



LENOX TERRACE UPDATED PLAN

BUILDING ON 60 YEARS OF HARLEM HISTORY

City Council Zoning Subcommittee – February 12, 2020

A PLAN MORE THAN 15 YEARS IN THE MAKING

- Revitalization planning began in 2003
- Olnick examined what zoning would allow at Lenox Terrace?
- Four 200'-tall buildings
- 500 market-rate apartments
- 6-7 year construction period
- No substantial improvements to the existing property
- Limited, if any, on-site retail



Rendering of as-of-right development permitted under existing zoning regulations (illustrative only)

LENOX TERRACE UPDATED PLAN

- **Will strengthen the core of existing Lenox Terrace**
 - over 6 acres of new, landscaped open space
 - improvements to existing apartments
 - renovations to existing building lobbies & corridors
 - new building amenities for all to use
 - all with no corresponding rent increase for existing residents



LENOX TERRACE UPDATED PLAN

- **Will enliven the streets around Lenox Terrace**
 - five new buildings at corners of the property
 - new street-level retail throughout



All project renderings for illustrative purposes only and subject to change

LENOX TERRACE UPDATED PLAN

- **New development and improvements to existing must and will happen together**
 - upgrades to existing buildings *cannot* happen without development of new buildings
 - development of new buildings *will not* happen without upgrades to existing buildings
- **Olnick stands ready to memorialized all these commitments through an enforceable Tenant Benefits Agreement with the existing residents**

PROPOSED NEW DEVELOPMENT

- Five new tower buildings at corners
- No building higher than Harlem Hospital
- Low-rise building along Lenox/Malcom X
- Always a minimum of 60' between existing and new buildings
- 1,600+ overall new housing units
- 400-500 units of affordable housing with the potential to house 160+ families earning the minimum wage

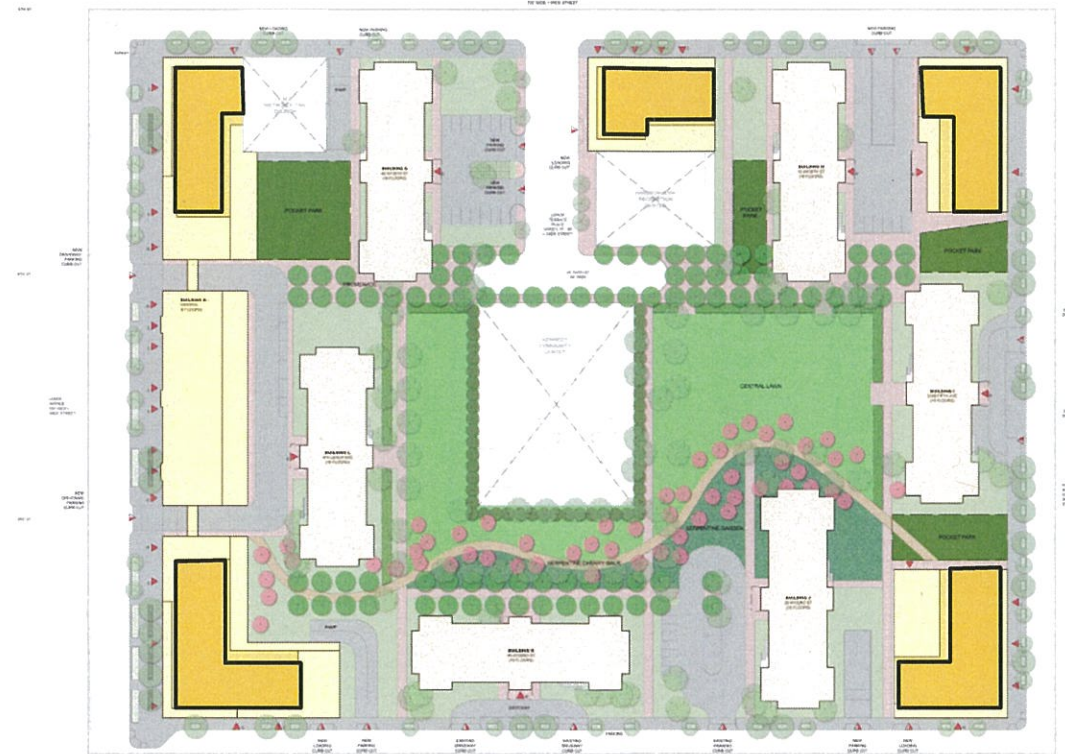

PROPOSED NEW DEVELOPMENT

- Five new tower buildings at corners
- No building higher than Harlem Hospital
- ~~Low-rise building along Lenox/Malcom X~~
- Always a minimum of 60' between existing and new buildings
- 1,600+ overall new housing units
- 400-500 units of affordable housing with the potential to house 160+ families earning the minimum wage



MAINTAINING THE HISTORIC 470 LENOX ENTRANCE



A SUBSTANTIAL IMPROVEMENT OVER THE “AS-OF-RIGHT”

With the proposed rezoning:

- Five new towers, max height of 284’
- 400-500 new affordable housing units
- Affordable units for households earning as little as \$30,000/year



Without the proposed rezoning:

- Four new towers, over 200’ in height
- All market rate, no affordable housing
- Infeasible to provide additional amenity package...



All project renderings for illustrative purposes only and subject to change

MODERN AMENITIES FOR EXISTING RESIDENTS

- Roof Decks
- Kids Playrooms
- Yoga Studios



- Community Rooms
- Gyms
- Game Room



IMPROVING THE RETAIL ENVIRONMENT



NEIGHBORHOOD RETAIL DEVELOPMENT



NEIGHBORHOOD RETAIL DEVELOPMENT

- 150,000 sf of new neighborhood retail space
- Small- to mid-sized local retailers
- Converted zoning request from C6 to R8 with C1 commercial overlay

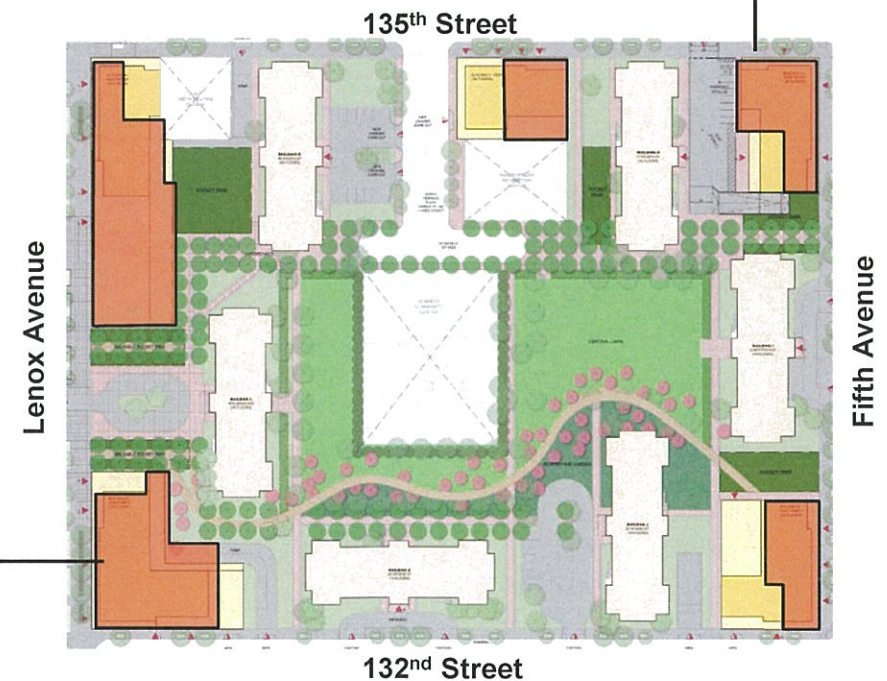

NEW OPEN SPACE PLAN



NEW OPEN SPACE PLAN

- Transform paved space without reducing parking

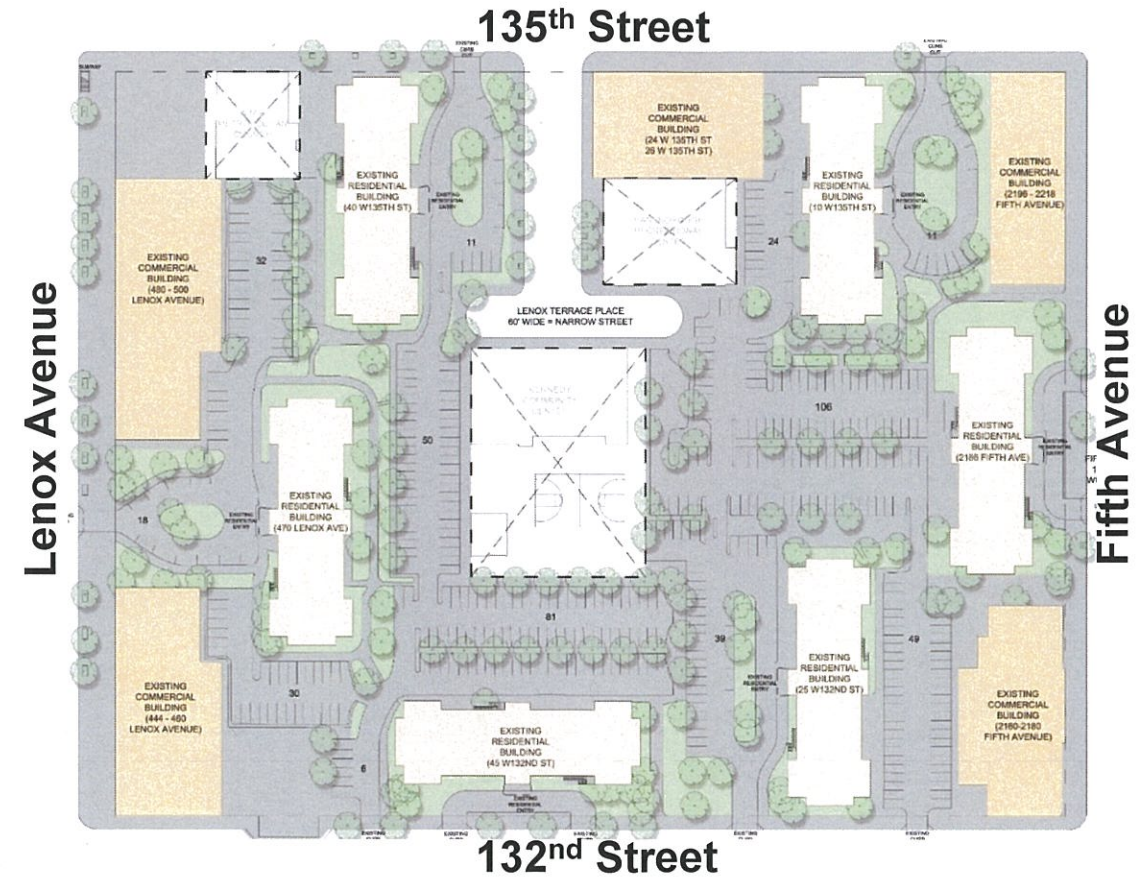

NEW OPEN SPACE PLAN

- Transform paved space without reducing parking
- Move parking underground and develop over six acres of open space



LARGE CENTRAL PARKING LOT



CENTRAL LAWN



DRIVEWAYS AND PARKING SPACES



PATHWAYS, POCKET PARKS AND BENCHES



LOBBY RENOVATIONS



LOBBY RENOVATIONS



UPGRADED KITCHENS, BATHROOMS AND HALLWAYS

- Upgrades to all kitchens older than 2000
- Upgrades to all bathrooms older than 2000
- Hallways will all be renovated: new lighting, paint, carpeting
- Current residents' rent will not increase to pay for renovations
- Renovation will happen at the same time as new construction



Renovation/upgrade images for illustrative purposes only and subject to change

ECONOMIC BENEFITS

- \$700+ million in construction spending
- 4,700+ total direct and generated construction jobs (2,700+ on-site)
- \$450+ million in direct and generated construction wages
- 300+ permanent jobs
- Millions in new wages



An aerial photograph of a dense urban neighborhood, likely Harlem, showing a mix of brick and modern high-rise buildings. A large blue rectangular overlay is centered on the image, containing white text. The text is arranged in three lines: the first two lines are the main title, and the third line is a subtitle. The background shows a grid of streets, numerous trees, and a variety of building heights and styles.

LENOX TERRACE UPDATED PLAN

BUILDING ON 60 YEARS OF HARLEM HISTORY

City Council Zoning Subcommittee – February 12, 2020

DISTRICT OFFICE
ADAM CLAYTON POWELL JR.
STATE OFFICE BUILDING,
163 WEST 125TH STREET, SUITE 729
NEW YORK, NY 10027
(212) 678-4505
FAX: (212) 864-4379

LEGISLATIVE OFFICE
250 BROADWAY, SUITE 1821
NEW YORK, NY 10007
(212) 788-7397
FAX: (212) 442-2732



THE COUNCIL OF
THE CITY OF NEW YORK
BILL PERKINS
COUNCIL MEMBER
9TH DISTRICT, MANHATTAN

COMMITTEES
CIVIL AND HUMAN RIGHTS
CONTRACTS
GOVERNMENT OPERATIONS
HOUSING AND BUILDING
JUVENILE JUSTICE
SMALL BUSINESS

My name is Councilman Bill Perkins and I represent the 9th District in the Village of Harlem.

The 9th District is a very diverse community. The residents represent the entire spectrum of New York City. From the "Harlem Born and Bread" to the "Harlem Dreamers" from river to river East, Central and West Harlem, I represent and have represented this community for over 30 years.

The Lenox Terrace ULURP proposal represents a unique opportunity a "test case" if you will. Others have an eye on Lenox Terrace. As goes Lenox Terrace.... Goes the Neighborhood.

Very rarely has a project of this magnitude received such attention as exhibited here today. And today I express my continued opposition to the Lenox Terrace ULURP Application.

For almost a decade, I have supported the residents of Lenox Terrace and the community's opposition to this application. I have held dozens of meetings over the course of my tenure in the New York State Senate and the New York City Council. Over the years, I have met with consultants, housing, labor and environmental advocates, my colleagues in government and the Olnick Organization and their development team; and I have not changed my position that this project is not good for our community.

The scale of this project tends to drastically change the landscape, quality of life of the residents and the numerous issues not addressed by the Olnick Organization. Since 2013, the community and Lenox Terrace residents have not only opposed the up-zoning, but have asked the ULURP applicant, Olnick Organization, to down scale the height and scope of even the as-of-right development plan.

“How can you say no to over 1600 units of new housing?” I was asked by a journalist. I can say no, because it affects my community. The new luxury housing and businesses will displace thousands of residents, small business owners and shoppers.

If allowed, this project will have a ripple effect throughout this community. The impact will be seen in many ways: Air-Quality, loss of open space, adverse shadow impact (lack of sun) for all buildings (470 Lenox Avenue, 40 West 135th Street and 45 West 132nd Street in particular); Overcrowded schools, transit systems, subway platforms, pedestrian and vehicular byways: parks; libraries and hospitals: The neighborhood will have to undertake the burden of this project which is ill conceived for a community that already lacks sufficient resources. In 2013 a survey was conducted amongst the residents of Lenox Terrace. The 2013 survey concluded that over 78% of the residents were opposed to the redevelopment and rezoning plan. Today, seven years later the consensus has not changed.

Further, the Olnick Organization has shown its self to be a bad player in this community for years, not just since this zoning change was conceived over a decade ago. Residents have endured lack of services, ranging from broken elevators, leaking ceilings, mice and bed bug infestations, Et al. Olnick's refusal over the years to make any upgrades to aging units has nurtured animosity and distrust from tenants. Current residents have seen of their rents in the development increase steadily with each year. Current residents, who have lived in The Terrace for over 30 years, have on average seen increases in their rents of 300-500%.

In addition, the five-year construction impact and all of the above mentioned and unmentioned issues raised by this project, I emphatically request that my colleagues join me, Borough President Gale Brewer, Community Board No. 10 and the residents of Lenox Terrace in voicing a definitive NO to this project.

Building As of Right is still Wrong.

Councilman Bill Perkins

January 12, 2020





OFFICE OF THE PRESIDENT
BOROUGH OF MANHATTAN
THE CITY OF NEW YORK

FOR THE RECORD

1 Centre Street, 19th floor, New York, NY 10007
(212) 669-8300 p (212) 669-4306 f
431 West 125th Street, New York, NY 10027
(212) 531-1608 p (212) 531-4615 f
www.manhattanbp.nyc.gov

Gale A. Brewer, Borough President

February 12, 2020

Testimony of Manhattan Borough President to the City Council Subcommittee on Zoning and Franchises on ULURP Application nos. C 200052 ZMM, C200050 ZSM, N 200051 ZRM, 200054 ZSM, N 200053 ZAM - Lenox Terrace

Good morning Chair Moya and Members of the Subcommittee:

There are few instances where a development the scale of the one proposed in this application can be viewed as responsible. The Proposed Development lacks the public and private investments necessary to make it a prudent exercise of planning for future growth. At its proposed scale, it promises to change the physical and socioeconomic character of Central Harlem.

The community's concerns are not unreasonable or unfounded. 1,200 of the proposed 1,700 dwelling units will be market-rate. This would result in a significant shift in the area's demographic composition; new residents will have much higher income levels. For a century, Harlem has been the epicenter of Black culture in America, but recent real estate trends have resulted in gentrification and led to a decrease in the area's Black population.

While no plan can insulate a community from market pressures leading to displacement, a project as large as the proposed project should include a plan that is equitable. An equitable plan would:

- 1) Create significantly more affordable housing;
- 2) Further preserve the current affordable housing stock;
- 3) Provide support to local entrepreneurs and small businesses;
- 4) Improve public transportation resources; and
- 5) Create and improve open space

The current proposal fails to meet these criteria. For the reasons stated below, I am recommending disapproval of these Land Use Applications.

The Proposed Development is expected to take place on a single development site and is expected to create 1,700 DUs, a population increase of approximately 4,000. That is nearly half the amount of the East Harlem Rezoning and the Inwood Rezoning. However, those rezonings covered over 60 square blocks. The Proposed Development will occupy just 3 square blocks. This will cause a disproportionate impact on local residents, infrastructure, economy, and educational resources.

For a plan like the one proposed in this application to provide equitable solutions it must also contain commitments proportional to the ones in the rezonings cited above. Both the East Harlem and Inwood rezonings led to commitments from the City in the amount of approximately \$300 to \$500 million for investments in infrastructure, housing preservation, open space, schools, and other elements essential to a neighborhood's high quality of life. One area in need of attention is public transit. Substantial improvements to the area's public transit resources must be made to ensure an equitable result. According to the Draft Environmental Impact Statement (DEIS), the 2 and 3 lines are currently

operating beyond capacity. 85% of the public transit usage generated by the Proposed Development forecasted to utilize the West 135th Street Station on the 2 and 3 lines. Serious overcrowding is foreseeable if the Proposed Development is built.

The DEIS study area has an overall open space ratio of 0.678 acres per 1,000 residents. This is significantly lower than the CEQR guideline of 2.5 acres of combined active and passive open space per 1,000 residents. While the open space expected to be created through the Proposed Development would offset an anticipated loss of existing open space, it will be only be accessible to residents of the Lenox Terrace complex. This proposal creates a disparity in access and in the amount of open space available to area residents.

One of the recurring concerns I have heard about the Proposed Development is the Applicant's ability to follow through on the commitments they have made in connection with this proposal. Many people have cited the long-term vacancy of the single-story commercial building at Fifth Avenue and West 132nd Street as an example. The planning process which led to the decision to keep over 17,000 square feet of commercial space vacant indicates indifference toward the local economy, and a lack of investment in the neighborhood's commercial vitality.

According to the Applicant and residents, there are upgrades and improvements that are needed at all six buildings in the Lenox Terrace complex. The Applicant insists that the proposed development is required to generate revenue necessary to perform these improvements. Many of the complaints by residents appear to involve conditions that the property owner is required by law to address, including brown water in their bathroom and kitchen faucets, lead contaminated water, inadequate electricity, rodents and other vermin, broken floor tiles, and similar conditions that have persisted for years.

According to the New York City Department of Housing Preservation and Development (HPD)¹, in the last 12 months the residents of the existing residential buildings have logged 149 complaints, which include the lack of heat and hot water throughout the buildings, bed bugs, roaches, and failed electrical outlets.

Based on past performance, the Proposed Development will not resolve the challenges faced at Lenox Terrace. We need a long-term commitment to housing affordability, and in concert with public agencies, greater investments in infrastructure, open space, and schools.

The Applicant must work with city and state agencies to create a preservation package for the existing units, and increase the number of affordable units that will better balance the mix of affordable and market-rate units in the new buildings.

The City Council should require the Deep Affordability Option pursuant to MIH
NYCT should work with the Applicant to develop a plan to alleviate the overcrowding at the West 135th Street Station on the 2 and 3 lines by increasing and improving alternative transportation options

The Applicant should provide funds for significant improvements to the Howard Bennett and Lincoln Playgrounds, the Hansborough Recreation Center, and the Lt. Joseph Kennedy Center.

¹ https://hpdonline.hpdnyc.org/Hpdonline/select_application.aspx

Prior to demolition, the single-story vacant commercial building on Fifth Avenue and West 132nd Street should be renovated and marketed to local businesses, arts and cultural organizations, church groups, and local community-based organizations at an affordable cost.

The improvements on the existing buildings committed to by the Applicant should be prioritized and tied to the Temporary Certificates of Occupancy obtained for the new buildings.

There is an opportunity to preserve and create truly affordable housing in this area, improve open space for the entire community, relieve transit constraints, as well as improve and create new community resources. The Applicant must work with all the tenants and the surrounding community in order to create a more equitable plan and process with transparency in order to ensure they are protected and their concerns are addressed

Thank you for your time and consideration of this application.



**The Greater Harlem
Chamber of Commerce**
200A West 136th Street
New York, NY 10030
Telephone: (212) 862-7200
Fax: (212) 862-8745
E-mail: info@greaterharlemchamber.com
www.GreaterHarlemChamber.com
Established in 1896

February 7, 2020

New York City Council
Committee on Land Use
The City of New York
250 Broadway
New York, New York 10007

Re: Public Hearing
February 12, 2020
Subject: Lenox Terrace
Letter of Support in Favor of Related Community Benefits

Dear Honorable Councilpersons:

The Greater Harlem Chamber of Commerce (GHCC), founded in 1896 and this year proudly celebrating its 124th year of continued activism and leadership in the Greater Harlem area, is pleased to inform you that we support the Applications before you for consideration regarding the Lenox Terrace renovation and new development. It is our belief, that the project, when properly developed, will bring short term and long term benefit to our service area as well as to our members and member businesses located throughout upper Manhattan.

With that in mind, we encourage you to support the Lenox Terrace Applications. Our Chamber not only greatly treasures Harlem's history, but also cares deeply about its future, and will be directly affected. That is why we have chosen to focus on the multiple community benefits that can and should be derived from the proposed development. We are pleased to have joined, in concert with **Community Board #10, Harlem Arts Alliance, Greater Harlem Housing Development Corporation, Harlem Congregations for Community Improvement, One Hundred Black Men of New York, Harlem Hospital Center, NY City Department of Parks and Recreation, The City College of New York, NY City Department of Education, MTA, HARLEM WEEK, NY State Senator Brian Benjamin, NY State Assemblymember Inez Dickens, etc.** in focusing on the community benefits and retail commercial development components of the Lenox Terrace initiative – **which is our specific area of focus.**

The proposed plan for Lenox Terrace has the potential to be an economic boom for our community creating hundreds of part time and full time jobs during the development and operational phases, as well as creating numerous business opportunities for local entrepreneurs. The Olnick Group has, in recent years, been an active member of the Chamber and has firmly committed to work closely with the Chamber and our community stakeholders partners, private and public, to create a significantly viable and short term and long term community benefits agreement.

The development phase will provide substantial opportunities for local service providers, contractors and small businesses. It is further our understanding from the Olnick Group that the project is committed to seeking to accomplish the minimum goal of 30% MWLBE participation. We also look forward to the substantial revitalization of the retail, commercial and professional services environment which will benefit the Chamber's target area of West 127th St. to West 142nd St. east from 5th Avenue to west, St. Nicholas Avenue.

Because we are concerned about the issues of gentrification we recognize that the development of new truly affordable housing in Harlem, is key to our community. Therefore, we are pleased that the development, when concluded, is guaranteed to provide 400 to 400 additional permanently affordable apartments earmarked in the main, for Harlem residents. We believe that the applicant has demonstrated flexibility in its proposals before you as submitted to ensure that much needed affordable housing will remain as a key aspect and consideration of this proposed development package.

We therefore, request that you, as well as our NY State Senator, our NY State Assemblymember and, of course, our Community Board, be supportive of our focus on Community Benefits in this project.

We invite you, if so desired, to communicate directly with The Greater Harlem Chamber of Commerce with any questions, thoughts or comments.

Sincerely,

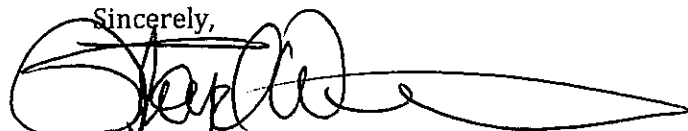
A handwritten signature in black ink, appearing to read 'Lloyd A. Williams', with a long horizontal flourish extending to the right.

Lloyd A. Williams
President



THE GATHERING HARLEM

Testimony Before the New York City Council Subcommittee on Zoning and Franchises

Jensy Acosta, Community Life Director, The Gathering Harlem

February 12, 2020

The Gathering Harlem submits this testimony in support of the tenants of Lenox Terrace, urging you to **oppose** the pending rezoning application by Olnick Organization, Inc. We believe any approval of the application will only exacerbate the continued harms of gentrification, which have already caused displacement of our members, neighbors, and countless others.

Deeply committed to the work of justice, The Gathering Harlem abides by a vision of a Harlem where everyone is dignified and unified, because justice, love, and mercy are present. Chief among our efforts is to identify concrete ways to address gentrification in Harlem. With 200 plus members—the majority of whom reside in your district—we’ve seen firsthand the deleterious disruptions that similar rezonings have caused our families, small businesses, and support networks in Harlem.

We believe that Olnick’s plan to add five 28-story buildings, reduce the number of truly affordable housing units, and repurpose the land for commercial use will place an unmitigated burden for residents to access basic resources. First, the construction will likely worsen the air quality in a neighborhood that already suffers from respiratory diseases at high rates.¹ The rate of avoidable asthma hospitalizations in Central Harlem, for example, is higher than the rates in other areas of the city.

¹ NYC Health Community Health Profiles: Manhattan Community District 10: CENTRAL HARLEM 5, 12, 13 (2015), <https://www1.nyc.gov/assets/doh/downloads/pdf/data/2015chp-mn10.pdf>. (“The rate of avoidable adult asthma hospitalizations in Central Harlem is higher than the Manhattan and citywide rates. . . . Central Harlem has the tenth-highest asthma hospitalization rate among children ages 5 to 14, almost twice the citywide rate. . . . In Central Harlem, levels of PM2.5, the most harmful air pollutant, are 9.6 micrograms per cubic meter, compared with 10.7 in Manhattan and 8.6 citywide.”)

Second, the plan would deviate from the goals the city purports to achieve through the Mandatory Inclusionary Housing (MIH) Program by making less affordable units available and at higher rent rates. Under the plan, only one-fourth of the units will be affordable. This is insufficient given the increasing demands for affordable housing. In 2017, the median household income in Central Harlem was \$49,995, while the median asking rent price for apartments was \$2,350, meaning a person with the median household income was asked to pay in 2017 nearly half their annual household income on rent.

Third, Olnick's plan would further drive the disproportionate displacement of black residents whose numbers are already dropping.² Lenox Terrace has long held a placeholder in the rich legacy of Harlem in large part due to its history of housing populations who have been historically discriminated against in New York City real estate market. Olnick's plan neither takes into account any racial impact analysis nor acknowledges the marginalization of the population its residents represent.

Put simply, we are concerned by the rapid pace at which Harlem buildings are being converted to appease the desires of developers over the interests of community members. And we don't want Lenox Terrace to be added to the list. We believe that what happens with Lenox Terrace stands to have a profound impact on the rest of Harlem. If we do not hold developers like Olnick and their plans accountable to the community residents of Harlem, displacement and disruption will result.

Make no mistake, many of us can appreciate the benefits of development, but we urge you to not permit development that lends itself wholly unaccountable to the community impacted. Please vote NO to Olnick's application to rezone Lenox Terrace.

² City University of New York Center for Urban Research, NYC Population Changes, 2000-2010 (2011), <http://www.urbanresearchmaps.org/plurality/>. ("Central Harlem and adjacent neighborhoods have experienced substantial change. Central Harlem (north and south) grew in population (an increase of 9%, from 109,095 people in 2000 to 118,665 in 2010). But Blacks in this predominantly Black community lost population share. The largest loss of Blacks in Manhattan occurred in Central Harlem North (-5,453) and Central Harlem South (-4,091). The Black population also declined in Hamilton Heights (-5,366).")



200A West 136th Street, New York, NY 10030
Telephone: (212) 862-8477
Fax: (212) 862-8745
HARLEMWEEK@gmail.com
www.harlemweek.com

February 7, 2020

New York City Council
Committee on Land Use
The City of New York
250 Broadway
New York, New York 10007

Re: Public Hearing
February 12, 2020
Subject: Lenox Terrace
Letter of Support in Favor of Related Community Benefits

Dear Honorable Councilpersons:

The board of directors of HARLEM WEEK, Inc. wishes to inform you that we believe the Applications before you for consideration regarding the Lenox Terrace renovation and new development can and will bring meaningful benefit to the greater Harlem area as well as to the goals and objectives of HARLEM WEEK. With that in mind, we encourage you to support the Lenox Terrace Applications. HARLEM WEEK cares deeply about the future of our community. That is why we are in favor of the various positive community benefits components that the Lenox Terrace initiative can bring to Harlem if properly planned.

HARLEM WEEK, is pleased to work, in concert with our community partners and the Olnick Group to strengthen the overall community impact of the proposed new Lenox Terrace development project. We believe this development, when properly aligned with its associated community benefits, will enhance and complement the continued growth of our local parks (such as Howard Bennett Playground, St. Nicholas Park); our health and fitness facilities (such as Hansborough Recreational Center, Kennedy Center, and the Harlem YMCA); our major health facility, Harlem Hospital Center; and, of course, our historic cultural and library facilities such as the Schomburg Center for Research in Black Culture, Countee Cullen Library, etc.

Over the past 10 years, HARLEM WEEK has worked directly with the Olnick Group on major community projects including:

“Summer in the City” (the 3rd Saturday of each August on W. 135th Street between Malcolm X Boulevard & St. Nicholas Avenue)

HARLEM DAY (the 3rd Sunday of each August on W. 135th Street between Fifth and St. Nicholas Avenues)

The Percy Sutton Harlem 5K Run & Health Walk (the 4th Saturday of each August on W. 135th Street and St. Nicholas Avenue)

The NY City Marathon (the 1st Sunday of each November on 135th Street between 5th Avenue and Malcolm X Boulevard)

We believe that the proposed development plan and the Applications before you can provide a unique opportunity to address many of the ever-growing needs of our service area. We therefore, request that you, as well as our other elected officials in the State Senate, State Assembly and, of course, our City Council and Community Board, be supportive of this historic project.

We invite you to communicate directly with HARLEM WEEK, Inc. with any questions, thoughts or comments.

Sincerely,



Winston Majette
Executive Director



February 7, 2020

New York City Council
Committee on Land Use
The City of New York
250 Broadway
New York, New York 10007

Re: Public Hearing
February 12, 2020
Subject: Lenox Terrace
Letter of Support in Favor of Related Community Benefits

Dear Honorable Councilpersons:

As longstanding members of the greater Harlem business and arts & culture community and as members of The Greater Harlem Chamber of Commerce, we are pleased to inform you that we believe the proposed plans and associated Applications for the Lenox Terrace renovation and new development can bring meaningful cultural and artistic benefits to our service area as well as to our member cultural institutions located in Central Harlem. With that in mind, we encourage you to support the Lenox Terrace initiative. Harlem Arts Alliance not only treasures Harlem's cultural history, but we also care deeply about its future. That is why we are in favor of the various positive community benefits components that the Lenox Terrace initiative can bring to Harlem.

Therefore, we are joining with **Community Board #10, Harlem Arts Alliance, Greater Harlem Housing Development Corporation, Harlem Congregations for Community Improvement, One Hundred Black Men of New York, Harlem Hospital Center, NY City Department of Parks and Recreation, The City College of New York, NY City Department of Education, MTA, HARLEM WEEK, NY State Senator Brian Benjamin, NY State Assemblymember Inez Dickens, New Heritage Theater Group, and Impact Repertory Theater, etc.**

In the planning of the short term and long term community benefits components of the Lenox Terrace initiative, we are also aware that, as part of its commitment to community benefits, Olnick will acknowledge and preserve the long term connection between Lenox Terrace and its surrounding neighborhoods to the rich historical tradition of Harlem in all aspects of arts and culture.

By concentrating on the arts and cultural impact that can best compliment the Lenox Terrace development and the residents of our service area, we will focus on key cultural sites located between W. 127th & W. 142nd Streets from 5th Avenue to Frederick Douglass Boulevard, including the:

- Schomburg Center for Research in Black Culture
- Harlem Hospital Mural Pavilion
- Harlem YMCA
- Countee Cullen Library
- National Jazz Museum in Harlem
- Dizzy Gillespie Mural Site, to name a few

Because we are concerned about the development of truly affordable housing units in Central Harlem, especially for residents from the arts and cultural community, we are pleased that the proposed development will 400 to 500 permanently affordable apartments.

We believe that the proposed development plan can provide a unique opportunity to address many of the ever-growing cultural and educational needs of our service area. We therefore, request that you, as well as our other elected officials in the State Senate, State Assembly and, of course, our City Council and Community Board, be supportive of this historic project.

We invite you, if so desired, to communicate directly with The Harlem Arts Alliance with any questions, thoughts or comments.

Sincerely,



Voza Rivers
Chairman

GREATER HARLEM HOUSING DEVELOPMENT CORPORATION

200A WEST 136TH STREET NEW YORK, NEW YORK 10030
PHONE: (212) 862-8299 FAX: (212) 862-8745
EMAIL: HARLEMCHAMBER@HOTMAIL.COM

February 7, 2020

New York City Council
Committee on Land Use
The City of New York
250 Broadway
New York, New York 10007

Re: Public Hearing
February 12, 2020
Subject: Lenox Terrace
Letter of Support in Favor of Related Community Benefits

Dear Honorable Councilpersons:

As longstanding members of the Central Harlem business community and as members of The Greater Harlem Chamber of Commerce, we are pleased to inform you that we believe the proposed plans for the Lenox Terrace renovation and new development will bring meaningful benefit to our service area as well as to our businesses. With that in mind, we encourage you to support the Lenox Terrace initiative. As Harlemites, we not only treasure Harlem's history, but also care deeply about its future and will be directly affected. That is why we are in favor of the various positive components that the Lenox Terrace initiative can and will bring to Harlem.

Greater Harlem Housing Development Corporation (GHHDC) has owned and operated a One-Hundred (100%) affordable housing portfolio consisting of 117 units of rental apartments ranging from studios to 3 bedrooms. We, therefore, understand the pressing and growing need for more affordable housing within the Central Harlem community and how the stated agreement of the creation of an additional 400-500 affordable units (as part of this proposed development) will address that need.

The proposed plan for Lenox Terrace also has the potential to be an economic boom for our community creating hundreds of temporary part time and full time jobs during the development and operational phase, as well as creating numerous business opportunities for local entrepreneurs.

The development phase will also provide substantial opportunities for local service providers, contractors and small businesses. It is further our understanding from the Olnick Group that the project development team is committed to achieving the goal of 30% MWLBE participation. We further understand from Olnick Group that the development project will create opportunities for a significant number of the workers to come from the Harlem community. We look forward to witnessing the

substantial revitalization of the retail, commercial and professional services environment which will benefit the Chamber's target area in Central Harlem (West 127th St. to West 142nd St. east from 5th Avenue to west, St. Nicholas Avenue), thereby benefitting a significant portion of the greater Harlem community and beyond.

We believe that the proposed development plan will provide a unique opportunity to address many of the ever-growing needs of our service area. We therefore, request that you, as well as our NY State Senator, our NY State Assemblymember and, of course, our Community Board, be supportive of our focus on Community Benefits in this project.

We invite you, if so desired, to communicate directly with Greater Harlem Housing Development Corporation with any questions, thoughts or comments.

Sincerely,

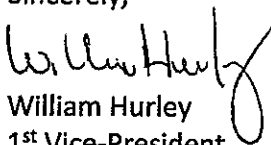
William Hurley
1st Vice-President

Carter Booth, *Chair*
Daniel Miller, *First Vice Chair*
Susan Kent, *Second Vice Chair*
Bob Gormley, *District Manager*



FOR THE RECORD

FOR THE

Antony Wong, *Treasurer*

Keen Berger, *Secretary*

Erik Coler, *Assistant Secretary*

COMMUNITY BOARD No. 2, MANHATTAN

3 WASHINGTON SQUARE VILLAGE

NEW YORK, NY 10012-1899

www.cb2manhattan.org

P: 212-979-2272 F: 212-254-5102 E: info@cb2manhattan.org

Greenwich Village * Little Italy * SoHo * NoHo * Hudson Square * Chinatown * Gansevoort Market

December 20, 2019

Marisa Lago, *Chair*
City Planning Commission
22 Reade Street
New York, NY 10007

Dear Ms. Lago:

At its Full Board meeting on December 19, 2019, CB#2, Manhattan (CB2, Man.), adopted the following resolution:

***46-74 Gansevoort** (between Washington and Greenwich Streets) #M 840260(F) LDM is a private application for an amendment to a restrictive declaration to allow Use Groups 3, 4, and 6B in addition to those presently permitted at the property located at 46-74 Gansevoort Street (Block 643, Lots 43, 49, and 54) in the Gansevoort Market Historic District, CD 2, Manhattan.

Whereas:

1. The three tax lots, which are within the Gansevoort Market Historic District, were previously treated as a single zoning lot, but have been treated as separate zoning lots since 2015.
2. The original restrictive declaration on this property dates to 1984, when the area bounded by Gansevoort, Washington, Jane, and West Sts. was rezoned to facilitate the development of new residential buildings and the conversion of non-residential buildings by Rockrose Development Corp. The project area in question retained its M1-5 zoning status.
3. To mitigate the possible impacts of the rezoning on industrial/meat production related uses, Use Groups 11, 16, 17 and 18 were allowed (various industrial and manufacturing uses).
4. In 1998, CPC approved a modification that expanded the uses permitted at 46-50 Gansevoort (Lot 54) to include Use Group 6, including but not limited to eating and drinking establishments and offices. This modification was intended to facilitate the operation of a restaurant on a portion of the ground floor and to allow a photography studio on the second floor.

This space is to be allocated as equally as possible between non-profit service and non-profit arts organizations and will be made available no later than 36 months from full and final approval of the amended restrictive declaration. In lieu of space, the service organization and/or Aurora may opt for an annuity or lump sum in an amount approximately commensurate with the value of the rent (exact amount to be negotiated by Aurora and the service organization(s)) and to be used only as a rent subsidy.

12. No more than 50% of the total square footage of all three of the community benefit spaces should be below grade.

Therefore, be it resolved that CB2 denies the application unless the stipulations in #8, #10, #11 and #12 are incorporated into the amended restrictive declarations (or other equally binding and enforceable instruments) and attach to the affected properties in perpetuity.

Be it further resolved that the timetable for the writing of the restrictive declarations (or other equally binding and enforceable instruments) allows for input by and the approval of CB2.

Vote: Passed unanimously with 38 Board members in favor.

Please advise us of any decision or action taken in response to this resolution.

Sincerely,

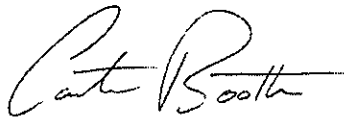

Carter Booth Chair
Community Board #2, Manhattan

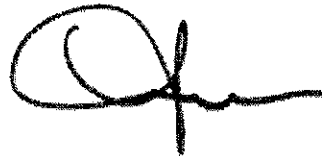

Anita Brandt, Co-Chair
Land Use & Business Development Committee
Community Board #2, Manhattan

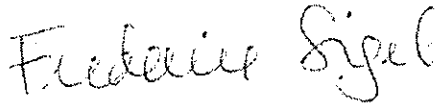

Frederica Sigel, Co-Chair
Land Use & Business Development Committee
Community Board #2, Manhattan

CB/jt

c: Hon. Jerrold Nadler, Congressman
Hon. Brad Holyman, State Senator
Hon. Deborah Glick, Assembly Member



Testimony
New York City Council
Subcommittee on Zoning and Franchises
Wednesday, February 12, 2020

Submitted by Beatriz Diaz Taveras
Executive Director
Catholic Charities Community Services

Good afternoon to Chairman Moya and the members of the New York City Council Subcommittee on Zoning and Franchises. I am Beatriz Diaz Taveras, Executive Director of Catholic Charities Community Services. Thank you for the opportunity to provide testimony today regarding Application No. C 200050 ZSM, N 200051 ZRM, C 200052 ZMM, N 200053 ZAM and C 200054 ZSM, submitted by Lenox Terrace Development Associates, and affiliate of the Olnick Organization. I am here to express disappointment at the lack of engagement of Catholic Charities in such an important project for the Harlem Community that we serve day in and day out. Located at 34 W 134th St, the Lt. Joseph P. Kennedy Jr. Memorial Center (Kennedy Center) lies in the center of Lenox Terrace and will be affected by the zoning changes requested in Olnick's applications. Any significant development here must continue and enhance the programs that the Kennedy Center community relies on. We also strongly believe that any development of this site must utilize any existing and potentially available FAR for much needed affordable housing.

Kennedy Center is one of New York City's most vibrant treasures, located in the heart of Harlem. This community cornerstone houses the DFTA-funded Central Harlem Senior Center Inc., which provides activities and meals for an average of 150 senior citizens five days a week. The center is a major hub for local non-Catholic and Catholic churches, temples and social organizations. Kennedy Center is the home base for over sixty different 501c3 non-profit organizations and/or private individuals that use the center on a regular basis and is considered their home base for their programs, workshops and activities. A large supermarket-style food pantry run by CCCS' Feeding our Neighbors program provides food for an average of 600 families a month.

For over 60 years, Catholic Charities Community Services, Archdiocese of New York (CCCS) has provided comprehensive, professional human services to vulnerable, low-income City residents in the poorest communities of Manhattan, the Bronx, and Staten Island. Its network of services enables a participant in any of our programs to access a continuum of services which include: case management services to help people resolve financial, emotional

and family issues; long-term disaster case management services to help the survivors of recent hurricanes rebuild their homes and lives; eviction and homelessness prevention; emergency food; immigration legal services; refugee resettlement; ESOL services; specialized assistance for the blind; after-school programs at summer camps and community centers; and supportive housing programs for adults with severe and persistent mental illness. Through its programs, CCCS serves more than 100,000 individuals each year without regard to race, ethnicity, gender or religion.

New Yorkers in need come to the Kennedy Center not only for case management, benefits and entitlement assistance, utility assistance, and eviction prevention assistance, but for a host of DYCD-funded youth programs and intergenerational programs.

Under the proposed zoning changes, the area including the Kennedy Center will go from R7-2 to R8, allowing for more potential residential development at the site. The Final Scope of Work for Preparation of a Draft Environmental Impact Statement (dated 8/23/19) projects that the lots occupied by the Kennedy Center and Metropolitan AME Church, if “fully utilizing the maximum FAR allowable under the proposed rezoning could be developed with approximately 69 new dwelling units and 6,968 gsf replacement community facility use.” The report further assumes “that up to 30 percent of the residential units (21 units) could be designated as affordable,” making the Kennedy Center a desirable location for residential and community facility development and a natural partner in the proposed development of Lenox Terrace.

We are deeply concerned with Olnick’s proposed plan which, although it acknowledges the potential of the Kennedy Center, clearly misrepresents the willingness of Catholic Charities to engage in the development process. In its Final Environmental Impact Statement, Olnick lists the Kennedy Center as a “Potential Development Site.” The report repeatedly states that

“[w]hile these lots would be rezoned under the proposed actions, the owner of the Kennedy Center—Catholic Charities of the Archdiocese of New York—has indicated that it has no intention of developing the Kennedy Center site, or altering its long established functions. Therefore, development of this site under the rezoning is unlikely in the foreseeable future.”

This statement is surprising and inaccurate, and Catholic Charities is disappointed at the lack of direct engagement by Olnick as it pursues a project that will have a profound effect on the Kennedy Center and on the surrounding Harlem community. Catholic Charities has been a proud partner in the City’s affordable housing initiatives, most recently working with the Archdiocese of New York to identify five parish sites to house 100 hundred safe haven beds as part of Mayor de Blasio’s “The Journey Home” initiative. Catholic Charities additionally looks forward to working with Speaker Johnson to effect policies outlined in the “Our Homelessness Crisis: The Case for Change” report. Catholic Homes New York, a Catholic

Charities partner, has worked in partnership with the Association of New York Catholic Homes, New York Institute for Human Development and in collaboration with the Archdiocese of New York to build or renovate 392 senior housing units, with an additional 89 units currently under construction, 1,973 family housing units, including 35 supportive housing units, with an 319 units currently under construction, at 17 locations across Manhattan, The Bronx, Staten Island, and Yonkers, all serving low income New Yorkers.

As a human services provider with a record of providing service to the community of Lenox Terrace and its surrounding streets, Catholic Charities looks forward to engaging with Olnick as well as residents, other non-profits and elected officials to develop strategies that provide sustainable growth and economic vitality while empowering New Yorkers who call the area home.

I thank you, Chairman Moya, once again, for providing an opportunity for CCCS to be heard. We look forward to continued engagement on this issue.

GRAND AVENUE AND PACIFIC STREET REZONING

BLOCK 1133, LOTS 7, 10, 11, 12, and, p/o 13
Block 1125, Lot 1

956-979 PACIFIC STREET AND
527 GRAND AVENUE, BROOKLYN



Subcommittee on Zoning and Franchises Public Hearing

February 12, 2020

Applicant Representative: Sheldon Lobel, P.C.



ZONING MAP

THE NEW YORK CITY PLANNING COMMISSION

Major Zoning Classifications:

The number(s) and/or letter(s) that follows on R, C or M District designation indicates use, bulk and other controls as described in the text of the Zoning Resolution.

R – RESIDENTIAL DISTRICT

C – COMMERCIAL DISTRICT

M – MANUFACTURING DISTRICT

 SPECIAL PURPOSE DISTRICT
The letter(s) within the shaded area designates the special purpose district as described in the text of the Zoning Resolution.

 AREA(S) REZONED

Effective Date(s) of Rezoning:

*05-08-2019 C 180042 ZMK
05-08-2019 C 160175 ZMK

Special Requirements:

For a list of lots subject to CEQR environmental requirements, see APPENDIX C.

For a list of lots subject to "D" restrictive declarations, see APPENDIX D.

For Inclusionary Housing designated areas and Mandatory Inclusionary Housing areas on this map, see APPENDIX F.

MAP KEY

12b	12d	13b
16a	16c	17a
16b	16d	17b

© Copyrighted by the City of New York

NOTE: Zoning information as shown on this map is subject to change. For the most up-to-date zoning information for this map, visit the Zoning section of the Department of City Planning website: www.nyc.gov/planning or contact the Zoning Information Desk at (212) 720-3291.

600 0 600 1200 1800 FEET

NOTE: STREETS FOR THE DOWNTOWN BROOKLYN STREET MAP CHANGES (C 030514MMK - C 030518MMK) ARE SHOWN ON THIS MAP PRIOR TO BECOMING EFFECTIVE IN ORDER TO LOCATE ZONING DISTRICT BOUNDARIES.

C1-1 C1-2 C1-3 C1-4 C1-5 C2-1 C2-2 C2-3 C2-4 C2-5

NOTE: Where no dimensions for zoning district boundaries appear on the zoning maps, such dimensions are determined in Article VII, Chapter 6 (Location of District Boundaries) of the Zoning Resolution.

ZONING MAP 16c

Proposed Project Area

Grand Pacific Rezoning, Brooklyn



NYC Digital Tax Map

Effective Date : 09-06-2018 14:34:37
 End Date : Current
 Brooklyn Block: 1125



Legend

- Streets
- Miscellaneous Text
- ↙ Possession Hooks
- Boundary Lines
- ↙ Lot Face Possession Hooks
- Regular
- Underwater
- Yellow Tax Lot Polygon
- Blue Tax Block Polygon
- Zoning Districts
- Special Districts
- Red dashed line Development Site

- Area Proposed to be Rezoned
- M1-1** Existing Zoning District
- Existing C2-4 Overlay
- Proposed C2-4 Overlay
- R7D** Proposed Zoning District

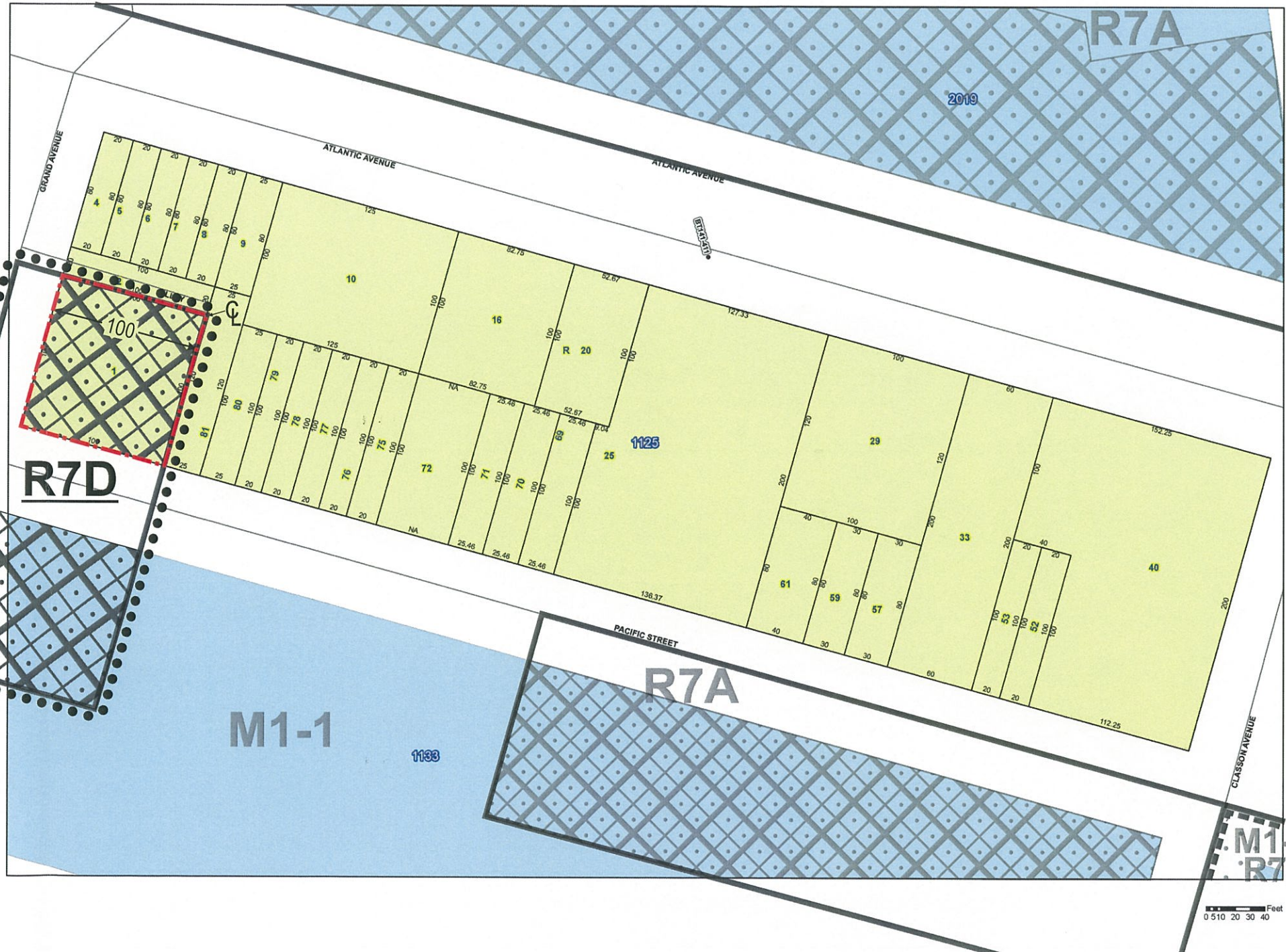

Grand Pacific Rezoning, Brooklyn



NYC Digital Tax Map

Effective Date : 03-07-2012 10:28:32
 End Date : Current
 Brooklyn Block: 1133



Legend

- Streets
- ↓ Miscellaneous Text
- ↓ Possession Hooks
- - - Boundary Lines
- ↓ Lot Face Possession Hooks
- Regular
- Underwater
- Yellow Tax Lot Polygon
- Blue Tax Block Polygon
- Thick Black Line Zoning Districts
- Red Dashed Line Development Site
- Black Dotted Line Area Proposed to be Rezoned
- M1-1 Existing Zoning District
- Grid with Diamond Existing C2-4 Overlay
- Grid with Square Proposed C2-4 Overlay
- R7D Proposed Zoning District

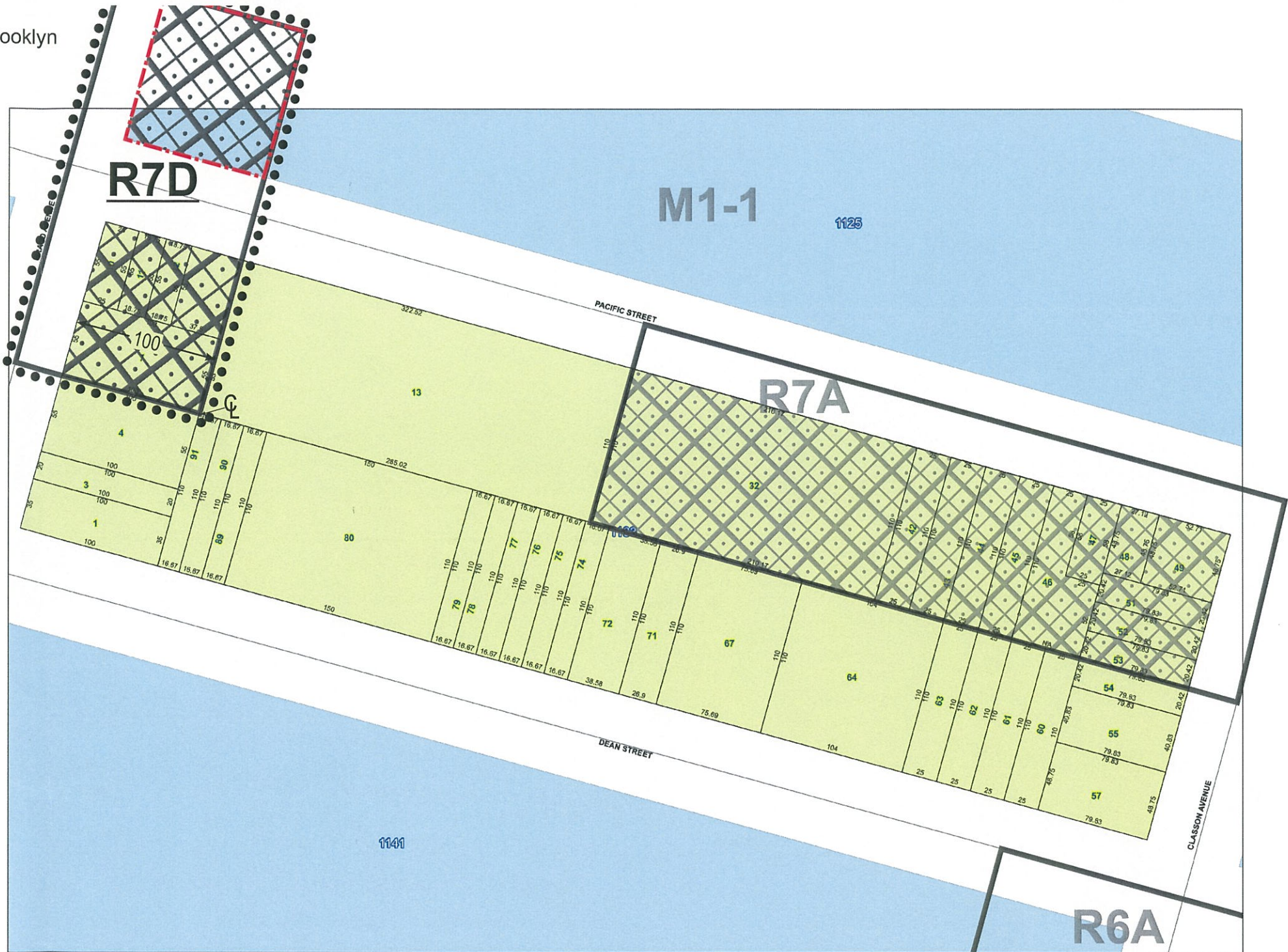

Area Map
Grand Pacific Rezoning, Brooklyn
Block 1125, Lot 1 and
Block 1133, Lots 7, 10, 11, 12 & 13 (p/o)

Project Information

- 600' Radius
- Development Site
- Area Proposed to be Rezoned
- Zoning Districts
- Special Districts

Existing Commercial Overlays

Subway Entries

5037 Block Numbers

Property Lines

5 Number of Floors

Land Uses

-
-
-
-
-
-
-
-
-
-
-
-

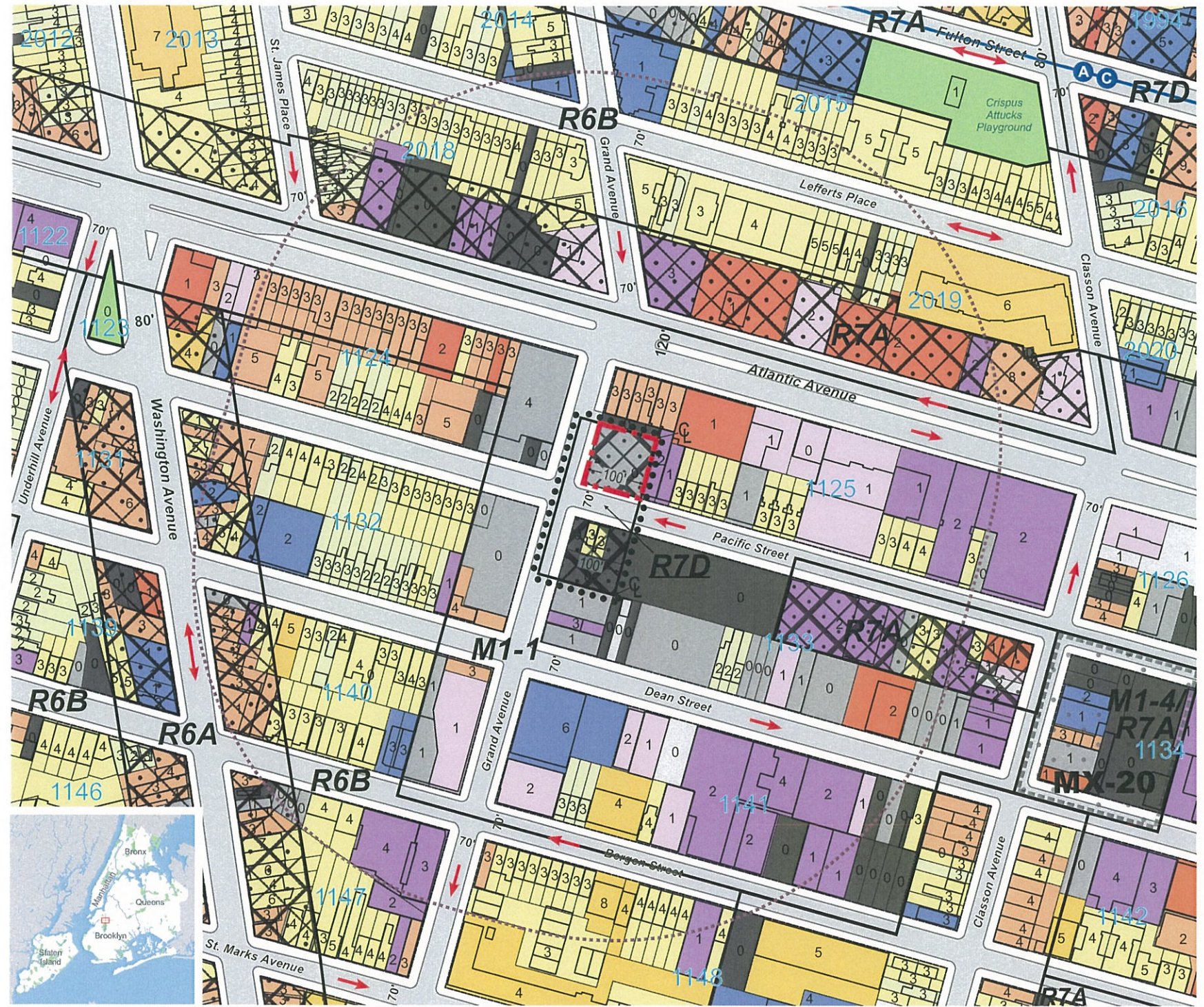

Zoning Change Map

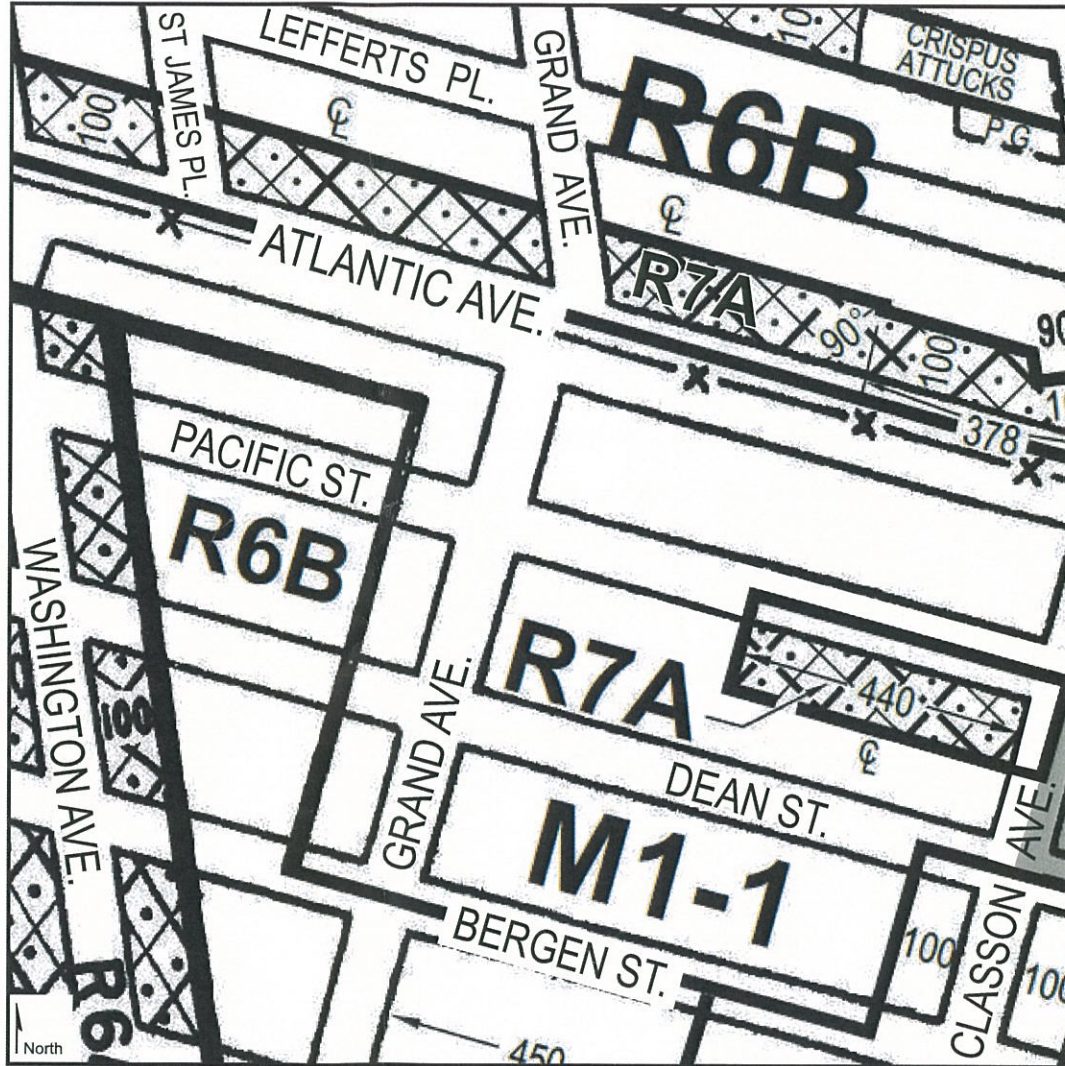

Current Zoning Map (16c)

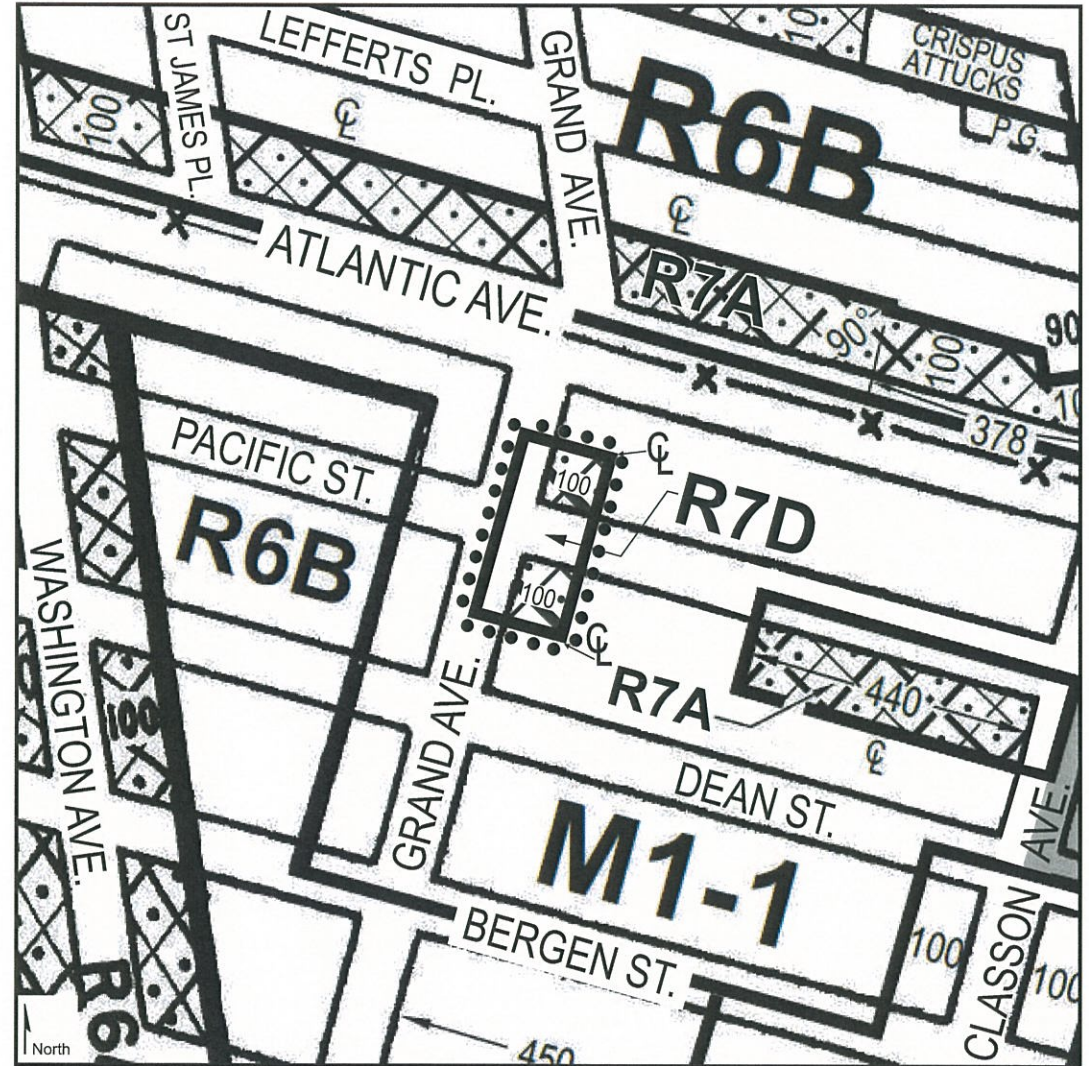

Proposed Zoning Map (16c) - Area being rezoned is outlined with dotted lines
Rezoning from M1-1 to R7D/C2-4

C1-1	C1-2	C1-3	C1-4	C1-5	C2-1	C2-2	C2-3	C2-4	C2-5

NOTE: Where no dimensions for zoning district boundaries appear on the zoning maps, such dimensions are determined in Article VII, Chapter 6 (Location of District Boundaries) of the Zoning Resolution.



1. View of the Development Site facing southeast from Grand Avenue.



2. View of Grand Avenue facing south (Development Site at left).



3. View of the Development Site facing east from Grand Avenue.





4. View of the Project Area facing southeast from the intersection of Grand Avenue and Pacific Street.



5. View of Pacific Street facing east from Grand Avenue (Development Site at left, Project Area at right).



6. View of the Development Site facing northeast from the intersection of Grand Avenue and Pacific Street.

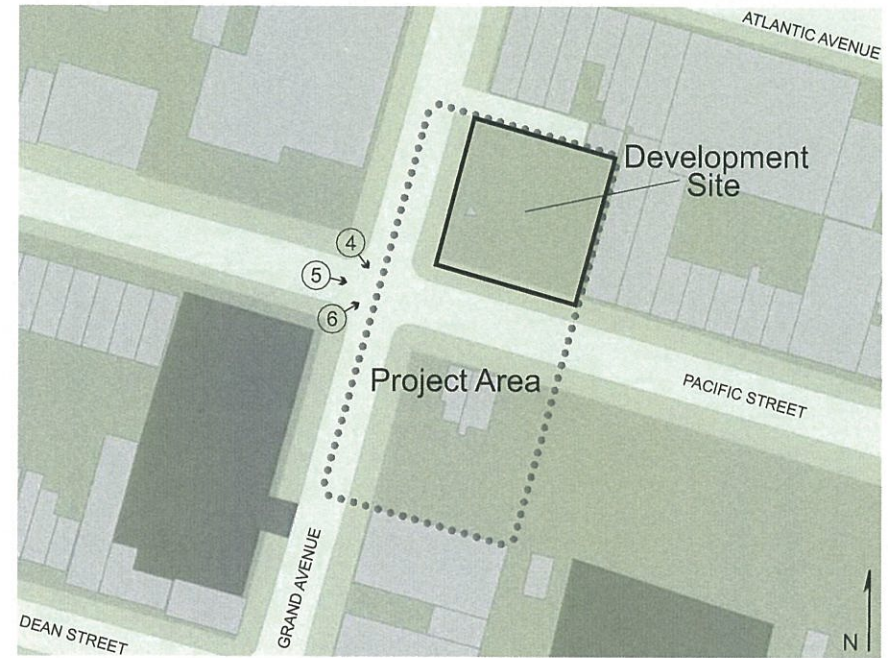

PROJECT: 192_08_PACIFIC
985 PACIFIC STREET
BROOKLYN, NY 11238

OWNER:
 ELE PARIENTE |
 EMP CAPITAL GROUP
 224 5TH AVENUE
 NEW YORK, NY 10001
 T. 212.527.0398
 E. EPARIENTE@EMPCAPITALGROUP.COM

LAND USE APPLICATION

985 PACIFIC STREET MIXED-USED RESIDENTIAL DEVELOPMENT

DRAWING LIST	
A-00	COVER
A-01	SITE PLAN
A-02	ZONING ANALYSIS
A-03	PLAN DIAGRAMS
A-04	ELEVATIONS
A-05	ELEVATION DIAGRAM & RENDER DETAIL



REVISIONS: ISSUE DATE: No.:

DCR JOB No.:

SEAL AND SIGNATURE:

ALBO LIBERIS

87 WEST STREET SUITE 224
 BROOKLYN, NY 11211 | WWW.ALBOLIBERIS.COM

ALBO LIBERIS ARCHITECTS AND DESIGNERS HAS PREPARED AND SUBMITTED THIS PLAN FOR THE CITY OF BROOKLYN. THE CITY OF BROOKLYN HAS REVIEWED THIS PLAN AND HAS ISSUED THIS PERMIT. THIS PERMIT IS VALID FOR THE PROJECT DESCRIBED HEREIN AND IS NOT TO BE USED FOR ANY OTHER PROJECT. THE CITY OF BROOKLYN IS NOT RESPONSIBLE FOR THE ACCURACY OF THE INFORMATION PROVIDED IN THIS PLAN. THE CITY OF BROOKLYN IS NOT RESPONSIBLE FOR THE CONSTRUCTION OF THE PROJECT DESCRIBED HEREIN. THE CITY OF BROOKLYN IS NOT RESPONSIBLE FOR THE MAINTENANCE OF THE PROJECT DESCRIBED HEREIN. THE CITY OF BROOKLYN IS NOT RESPONSIBLE FOR THE OPERATION OF THE PROJECT DESCRIBED HEREIN. THE CITY OF BROOKLYN IS NOT RESPONSIBLE FOR THE SAFETY OF THE PROJECT DESCRIBED HEREIN. THE CITY OF BROOKLYN IS NOT RESPONSIBLE FOR THE WELL-BEING OF THE PROJECT DESCRIBED HEREIN. THE CITY OF BROOKLYN IS NOT RESPONSIBLE FOR THE ENVIRONMENT OF THE PROJECT DESCRIBED HEREIN. THE CITY OF BROOKLYN IS NOT RESPONSIBLE FOR THE SOCIAL AND ECONOMIC IMPACT OF THE PROJECT DESCRIBED HEREIN. THE CITY OF BROOKLYN IS NOT RESPONSIBLE FOR THE CULTURAL AND HISTORICAL IMPACT OF THE PROJECT DESCRIBED HEREIN. THE CITY OF BROOKLYN IS NOT RESPONSIBLE FOR THE ARCHITECTURAL AND DESIGN QUALITY OF THE PROJECT DESCRIBED HEREIN. THE CITY OF BROOKLYN IS NOT RESPONSIBLE FOR THE ARTISTIC MERIT OF THE PROJECT DESCRIBED HEREIN. THE CITY OF BROOKLYN IS NOT RESPONSIBLE FOR THE COMMUNITY SUPPORT OF THE PROJECT DESCRIBED HEREIN. THE CITY OF BROOKLYN IS NOT RESPONSIBLE FOR THE PUBLIC OPINION OF THE PROJECT DESCRIBED HEREIN. THE CITY OF BROOKLYN IS NOT RESPONSIBLE FOR THE POLITICAL AND LEGISLATIVE PROCESS OF THE PROJECT DESCRIBED HEREIN. THE CITY OF BROOKLYN IS NOT RESPONSIBLE FOR THE FINANCIAL VIABILITY OF THE PROJECT DESCRIBED HEREIN. THE CITY OF BROOKLYN IS NOT RESPONSIBLE FOR THE ECONOMIC IMPACT OF THE PROJECT DESCRIBED HEREIN. THE CITY OF BROOKLYN IS NOT RESPONSIBLE FOR THE SOCIAL AND ECONOMIC IMPACT OF THE PROJECT DESCRIBED HEREIN. THE CITY OF BROOKLYN IS NOT RESPONSIBLE FOR THE CULTURAL AND HISTORICAL IMPACT OF THE PROJECT DESCRIBED HEREIN. THE CITY OF BROOKLYN IS NOT RESPONSIBLE FOR THE ARCHITECTURAL AND DESIGN QUALITY OF THE PROJECT DESCRIBED HEREIN. THE CITY OF BROOKLYN IS NOT RESPONSIBLE FOR THE ARTISTIC MERIT OF THE PROJECT DESCRIBED HEREIN. THE CITY OF BROOKLYN IS NOT RESPONSIBLE FOR THE COMMUNITY SUPPORT OF THE PROJECT DESCRIBED HEREIN. THE CITY OF BROOKLYN IS NOT RESPONSIBLE FOR THE PUBLIC OPINION OF THE PROJECT DESCRIBED HEREIN. THE CITY OF BROOKLYN IS NOT RESPONSIBLE FOR THE POLITICAL AND LEGISLATIVE PROCESS OF THE PROJECT DESCRIBED HEREIN. THE CITY OF BROOKLYN IS NOT RESPONSIBLE FOR THE FINANCIAL VIABILITY OF THE PROJECT DESCRIBED HEREIN. THE CITY OF BROOKLYN IS NOT RESPONSIBLE FOR THE ECONOMIC IMPACT OF THE PROJECT DESCRIBED HEREIN.

DRAWING TITLE:
 COVER

DCP

A-00

ZONING ANALYSIS

SITE DATA			LIST OF REQUIRED ACTIONS
BLOCK(S)	1125		REZONE TO R7D/C2-4
LOT(S)	1		
STREET ADDRESS	985 PACIFIC STREET		
EXISTING ZONING	M1-1		
COMMUNITY DISTRICT	308		
ZONING SECTION MAP	16c		
ZONING LOT AREA	10,000 SF		

ZR SECTION	PERMITTED/REQUIRED	PROPOSED	NOTES
22-12	RESIDENTIAL DISTRICT UG	USE GROUP 2	UG 2 MULTI-FAMILY
32-00, 32-15	COMMERCIAL DISTRICT UG	USE GROUP 6	UG 6 RETAIL
		M-CROWN USES	TBD
35-22, 35-31, 33-10, 23-154	MAX TOTAL FAR	5.6	5.6 FAR / 56,000 ZSF
23-154	MAX TOTAL RESIDENTIAL FAR	5.6	4.76 FAR / 47,600 ZSF
33-10	MAX TOTAL COMMERCIAL FAR	2	0.63 FAR / 6,300 ZSF
	M-CROWN FLOOR AREA	2	0.21 FAR / 2,100 ZSF (2,032 NET FA)
23-22	DU FACTOR	70 UNITS	84 UNITS
23-154	AFFORDABLE HOUSING	25% of RESIDENTIAL	47,600 / 680 = 70 UNITS
23-541	REAR YARDS	NONE REQUIRED	48 UNITS MARKET RATE AHU @ 60% AMI AVG.
23-684	BULK	BASE: 60'/95' MAX HT:115' MAX NO. OF STORIES: 11	NO REAR YARD WITHIN 100' OF INTERSECTION
23-32	MINIMUM LOT SIZE	Area:1,700 SF / WIDTH:18'	BASE: 60' MAX: 100' NO. OF STORIES: 9
28-21	QH REC SPACE	3.3% RESIDENTIAL	10,000 SF / 100'
25-21, 25-23	CAR PARKING	30% OF MARKET RATE	100' SQUARE CORNER LOT
36-62	LOADING BERTH	NONE REQUIRED	0.033 x 47,600 = 1,571 ZSF
36-711	BICYCLE PARKING	1 PER 2 DU	15 SPOT WAIVER > .3 x 48 = 14.4
			8,400 SF PROVIDED < 25,000 SF = 0 REQUIRED
			70/2 = 35

FLOOR AREA SUMMARY

DWELLING UNIT CHART

	GFA	DEDUCTION	ZFA	FAR	STUDIO	1 BEDROOM	2 BEDROOM	3 BEDROOM	TOTAL
CELLAR	10,000	10,000	0	0	0	0	0	0	0
GROUND FLOOR	9,810	334	9,476	0.95	0	0	0	0	0
2ND FLOOR	8,235	990	7,245	0.72	1	6	3	0	10
3RD FLOOR	8,235	990	7,245	0.72	1	6	3	0	10
4TH FLOOR	8,235	990	7,245	0.72	1	6	3	0	10
5TH FLOOR	8,235	990	7,245	0.72	1	6	3	0	10
6TH FLOOR	7,518	850	6,668	0.67	2	4	3	0	9
7TH FLOOR	6,520	728	5,792	0.58	5	4	0	0	9
8TH FLOOR	5,044	552	4,492	0.45	2	3	1	0	6
9TH FLOOR	1,176	584	592	0.06	0	0	0	0	0
TOTAL	73,008	17,008	56,000	5.6	13	35	16	0	64

PROJECT: 19238-0001
985 PACIFIC STREET
 BROOKLYN, NY 11238

OWNER:
 ELIE PARIENTE |
 EMP CAPITAL GROUP
 224 5TH AVENUE
 NEW YORK, NY 10001
 T: 212.227.2388
 E: EPARIENTE@EMPCAPITALGROUP.COM

REVISION: MAKE DATE: No.

DESIGNER:

SCALE AND SIGNATURE:

ALDO LIBERIS
 27 WEST STREET, SUITE 1113
 BROOKLYN, NY 11201 | WWW.ALDOLIBERIS.COM

THIS DRAWING IS THE PROPERTY OF ALDO LIBERIS ARCHITECTS AND ENGINEERS, INC. (ALDO LIBERIS). IT IS TO BE USED ONLY FOR THE PROJECT AND SITE SPECIFICALLY IDENTIFIED HEREON. ANY REUSE, REPRODUCTION, OR TRANSMISSION OF THIS DRAWING WITHOUT THE WRITTEN PERMISSION OF ALDO LIBERIS IS STRICTLY PROHIBITED. ALDO LIBERIS ASSUMES NO LIABILITY FOR ANY ERRORS OR OMISSIONS IN THIS DRAWING. THE USER OF THIS DRAWING SHALL BE RESPONSIBLE FOR OBTAINING ALL NECESSARY PERMITS AND APPROVALS FROM THE APPROPRIATE AGENCIES. THE USER OF THIS DRAWING SHALL BE RESPONSIBLE FOR OBTAINING ALL NECESSARY PERMITS AND APPROVALS FROM THE APPROPRIATE AGENCIES. THE USER OF THIS DRAWING SHALL BE RESPONSIBLE FOR OBTAINING ALL NECESSARY PERMITS AND APPROVALS FROM THE APPROPRIATE AGENCIES.

DRAWING TITLE:
 ZONING ANALYSIS

DCP

A-02

OWNER:
 ELIE PARIENTE |
 EMP CAPITAL GROUP
 224 5TH AVENUE
 NEW YORK, NY 10001
 T: (212) 237-3368
 E: EPARIENTE@EMPCAPITALGROUP.COM



02 WEST ELEVATION @ GRAND AVENUE
10/11/17

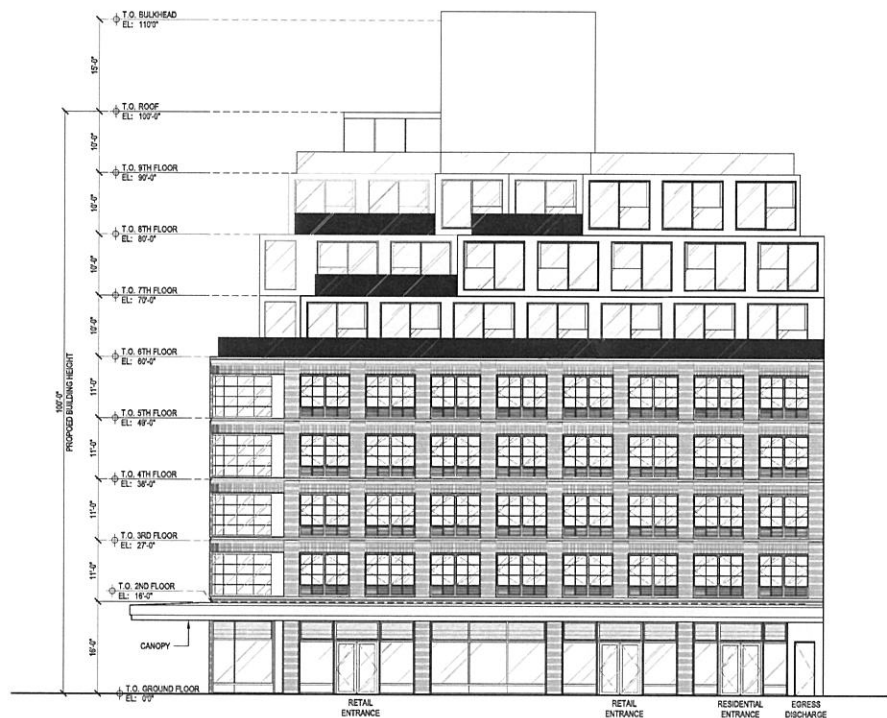

01 SOUTH ELEVATION @ PACIFIC STREET
10/11/17

REVISIONS: ISSUE DATE: No:
 JOB No:
 SEAL AND SIGNATURE:

ALDO LIBERIS

87 WEST STREET SUITE 214
 BROOKLYN, NY 11201 | WWW.ALDOLIBERIS.COM

THIS DOCUMENT IS THE PROPERTY OF ALDO LIBERIS ARCHITECTS. IT IS TO BE USED ONLY FOR THE PROJECT AND SITE SPECIFICALLY IDENTIFIED HEREIN. ANY REUSE OR MODIFICATION OF THIS DOCUMENT WITHOUT THE WRITTEN PERMISSION OF ALDO LIBERIS ARCHITECTS IS STRICTLY PROHIBITED. THE USER OF THIS DOCUMENT SHALL BE RESPONSIBLE FOR OBTAINING ALL NECESSARY PERMITS AND APPROVALS FROM THE APPROPRIATE AGENCIES. THE USER SHALL BE RESPONSIBLE FOR OBTAINING ALL NECESSARY PERMITS AND APPROVALS FROM THE APPROPRIATE AGENCIES. THE USER SHALL BE RESPONSIBLE FOR OBTAINING ALL NECESSARY PERMITS AND APPROVALS FROM THE APPROPRIATE AGENCIES.

DRAWING TITLE:
 SOUTH & WEST ELEVATIONS

DCP

A-04

8118 13th AVENUE REZONING

BLOCK 6291, LOTS 43, 45, AND, 47
8118-8124 13th AVENUE, BROOKLYN
COMMUNITY BOARD 10 BROOKLYN, NEW YORK



**Subcommittee on Zoning and Franchises
Public Hearing**

February 12, 2020

Proposed Project Area

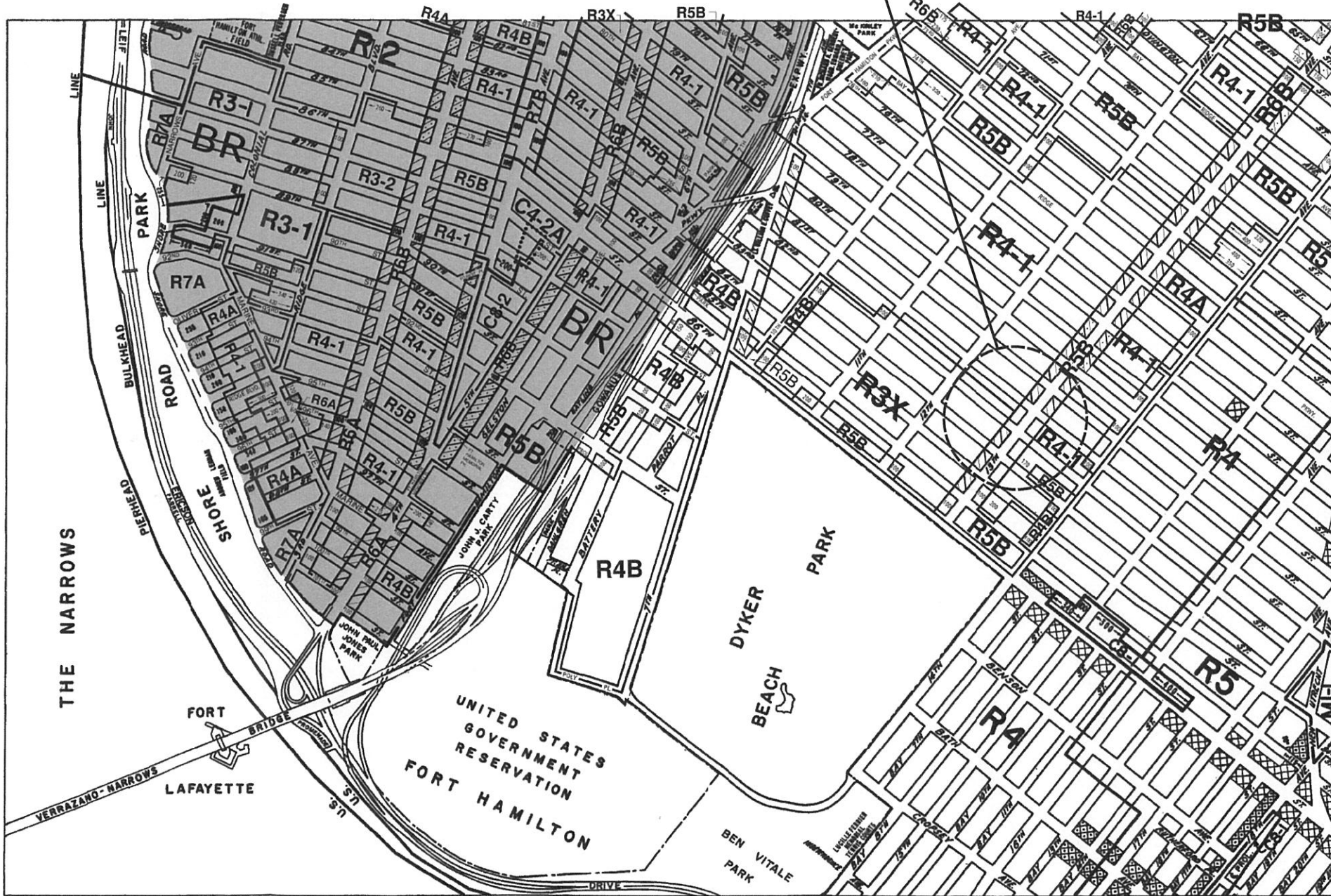

ZONING MAP
THE NEW YORK CITY PLANNING COMMISSION

Major Zoning Classifications:
The number(s) and/or letter(s) that follows an R, C or M District designation indicates use, bulk and other controls as described in the text of the Zoning Resolution.

- R – RESIDENTIAL DISTRICT
- C – COMMERCIAL DISTRICT
- M – MANUFACTURING DISTRICT

SPECIAL PURPOSE DISTRICT
The letter(s) within the shaded area designates the special purpose district as described in the text of the Zoning Resolution.

AREA(S) REZONED

Effective Date(s) of Rezoning:

11-15-2007 C 070203 ZMK

Special Requirements:

For a list of lots subject to CEQR environmental requirements, see APPENDIX C.

For a list of lots subject to "D" restrictive declarations, see APPENDIX D.

For Inclusionary Housing designated areas on this map, see APPENDIX F.

MAP KEY

21c	22a	22c
21d	22b	22d
27c	28a	28c

© Copyrighted by the City of New York

ZONING MAP 22b

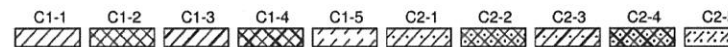
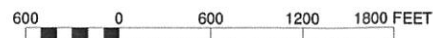

NOTE: Where no dimensions for zoning district boundaries appear on the zoning maps, such dimensions are determined in Article VII, Chapter 6 (Location of District Boundaries) of the Zoning Resolution.

NOTE: Zoning information as shown on this map is subject to change. For the most up-to-date zoning information for this map, visit the Zoning section of the Department of City Planning website: www.nyc.gov/planning or contact the Zoning Information Desk at (212) 720-3291.

13th Avenue Rezoning, Brooklyn



NYC Digital Tax Map

Effective Date : 12-07-2008 01:12:24
 End Date : Current
 Brooklyn Block: 6291



Legend

- Streets
- Miscellaneous Text
- Possession Hooks
- Boundary Lines
- Lot Face Possession Hooks
- Regular
- Underwater
- Tax Lot Polygon
- Condo Number
- Tax Block Polygon

- Zoning District Line
- Development Site
- Area Proposed to be Rezoned
- R3X** Existing Zoning District
- Existing C1-3 Overlay
- Proposed C1-3 Overlay

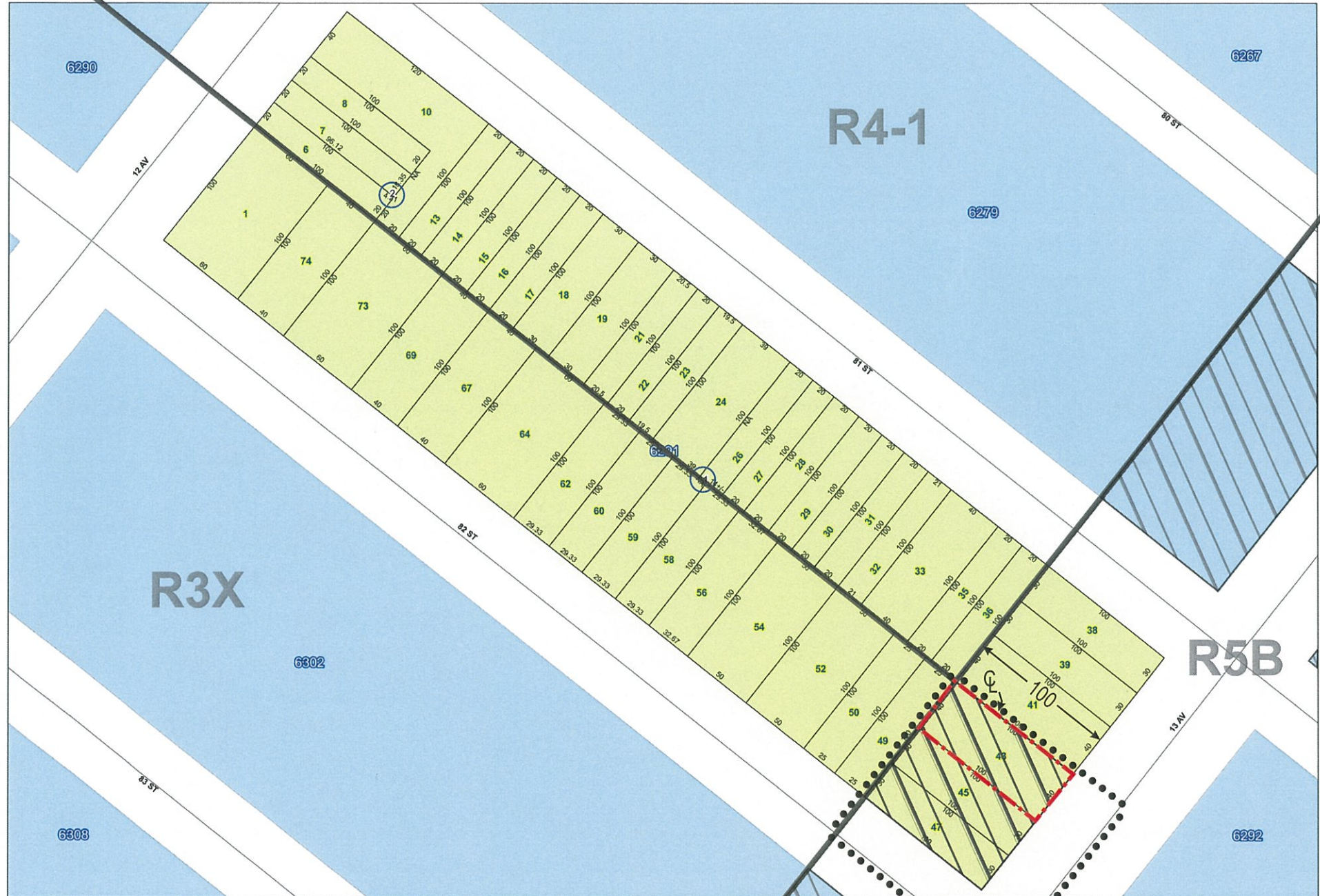

Area Map
13th Avenue Rezoning, Brooklyn
Block 6291, Lots 43, 45 & 47

Project Information

- 600' Radius
- Development Site
- Project Area
- Zoning Districts

Existing Commercial Overlays

C1-1	C2-1
C1-2	C2-2
C1-3	C2-3
C1-4	C2-4
C1-5	C2-5

● Subway Entries
 5037 Block Numbers
 Property Lines
 5 Number of Floors

Land Uses

- One & Two Family Residential Buildings
- Multi-Family Residential Buildings (Walk-up)
- Multi-Family Residential Buildings (Elevator)
- Mixed Residential & Commercial Buildings
- Commercial/Office Buildings
- Industrial/Manufacturing
- Transportation/Utility
- Public Facilities & Institutions
- Open Space
- Parking Facilities
- Vacant Land
- No Data/Other

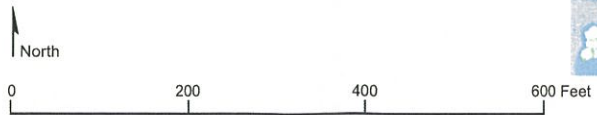
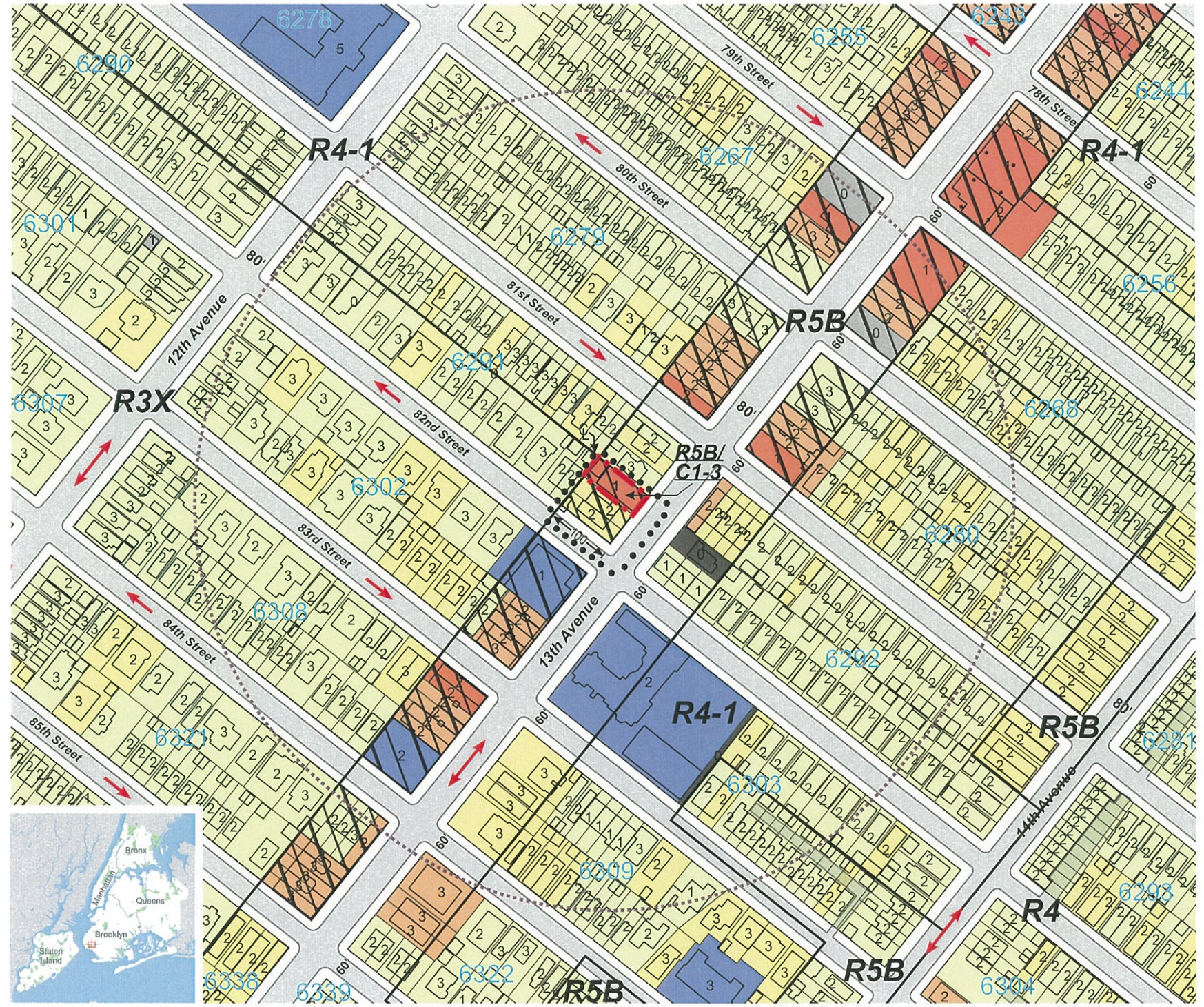

Zoning Change Map

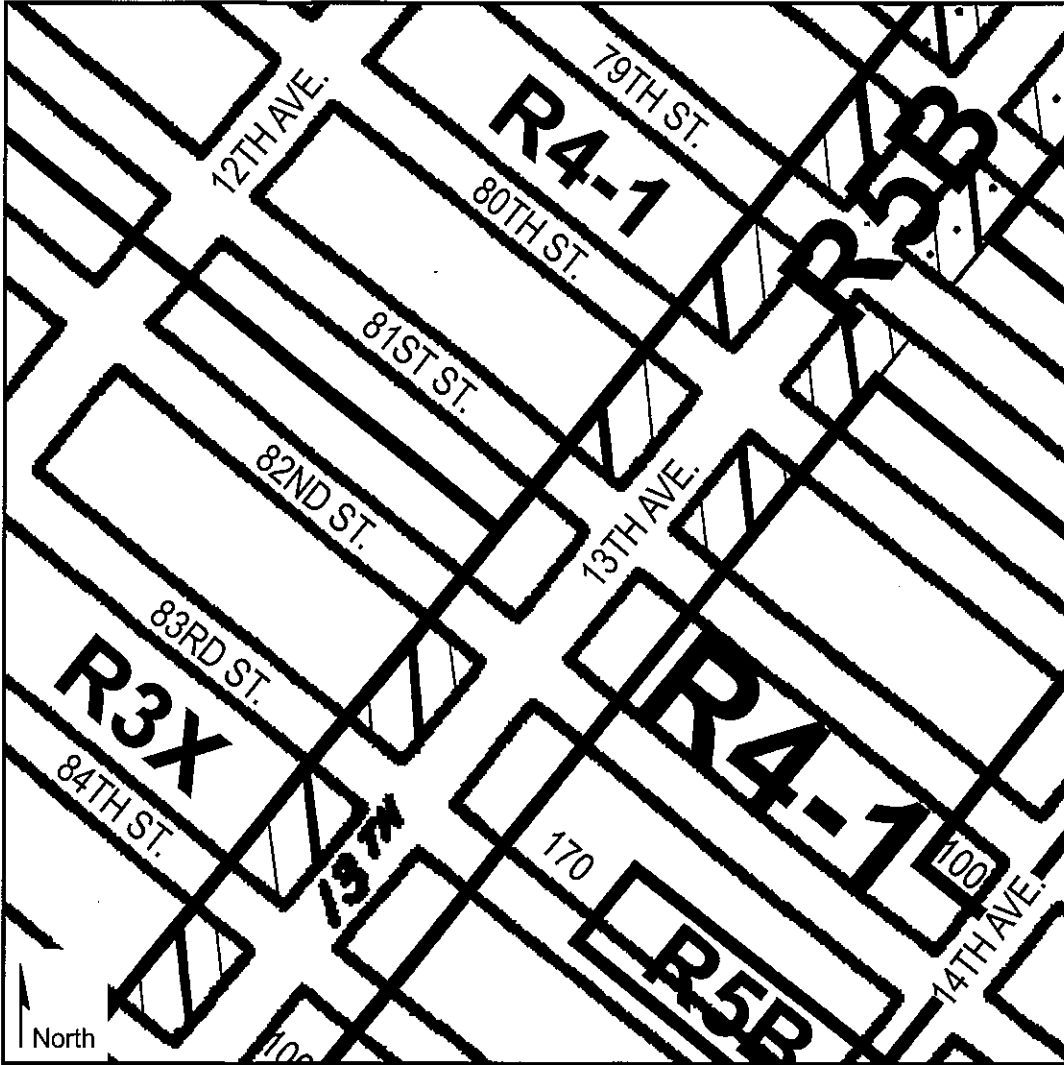

Current Zoning Map (22b)

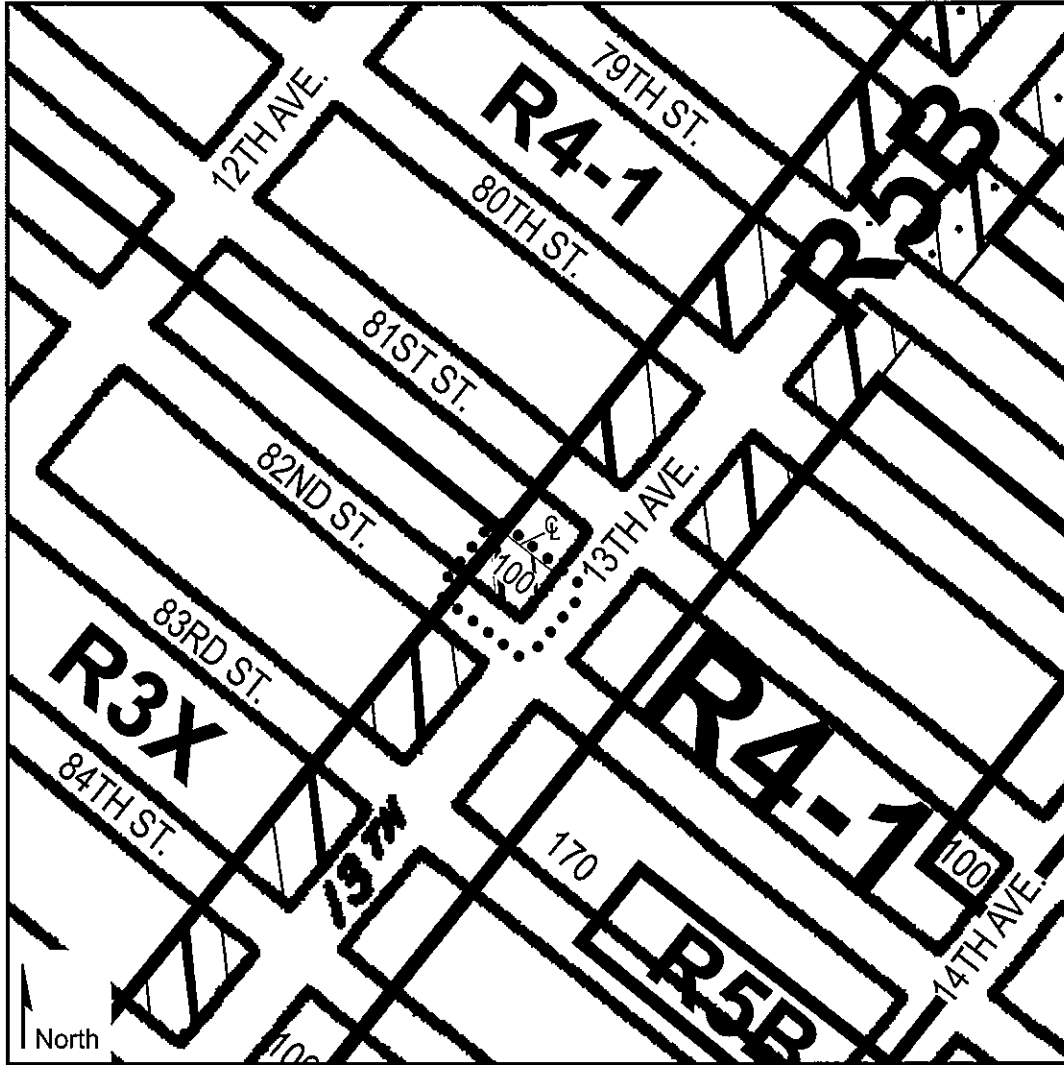

Proposed Zoning Map (22b) - Area being rezoned is outlined with dotted lines
Rezoning from R5B to R5B/C1-3

C1-1	C1-2	C1-3	C1-4	C1-5	C2-1	C2-2	C2-3	C2-4	C2-5



1. View of the Development Site facing northwest from 13th Avenue.



2. View of the Project Area facing northwest from 13th Avenue.



3. View of the Development Site facing west from 13th Avenue.

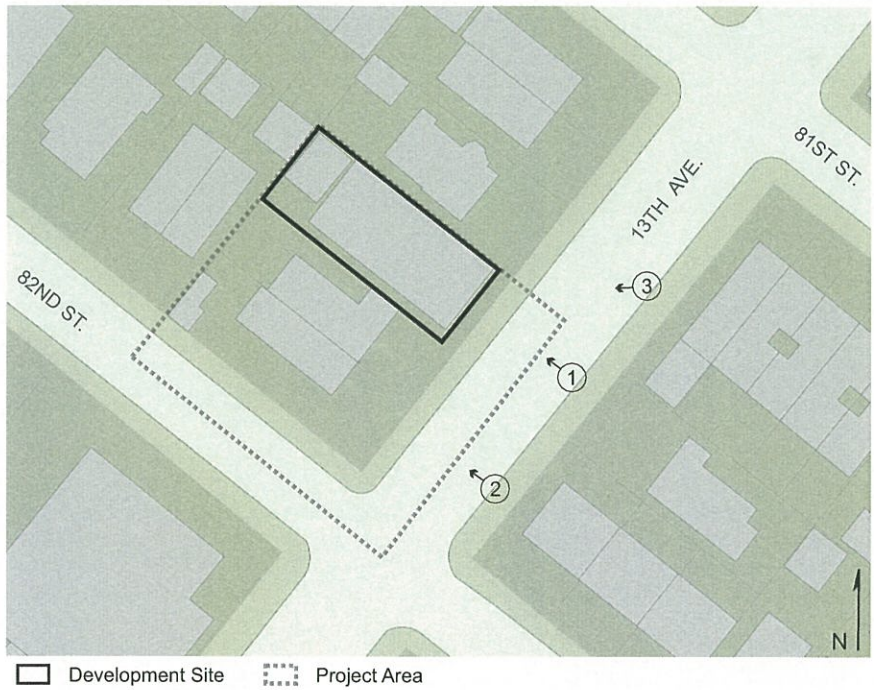

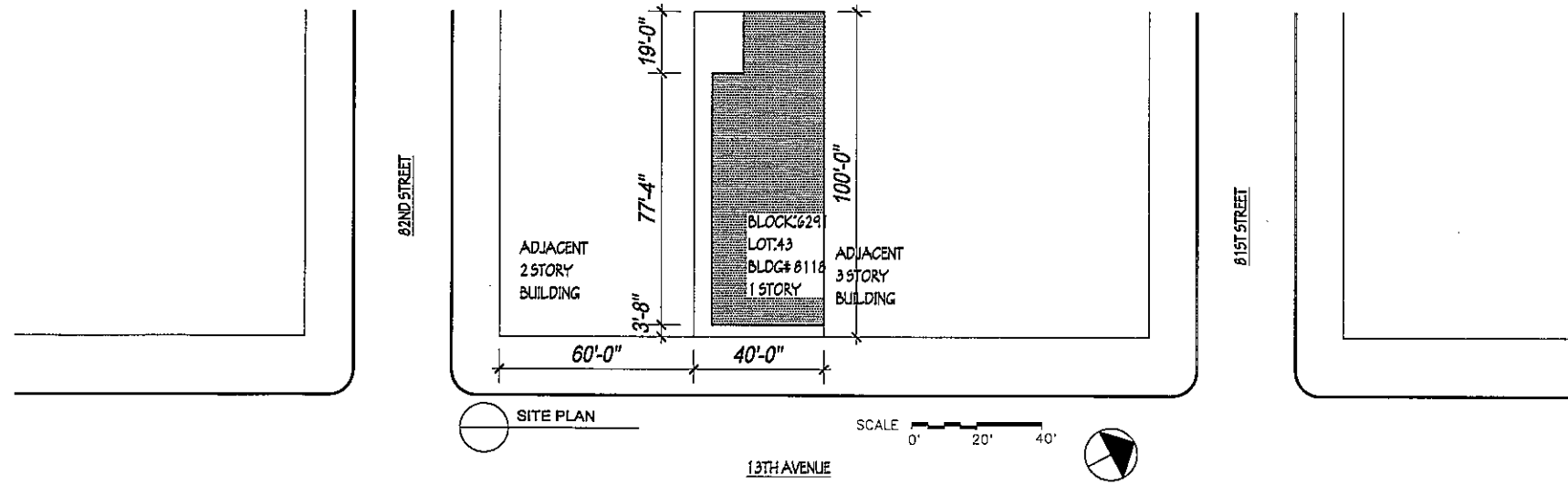

SITE NOTES:
1. THIS IS A NON ELEVATOR BUILDING

 <p>GRASSO-MENZIUSO ARCHITECTS A.I.A. 350 SEVENTH AVENUE, N.Y., N.Y. 10001 TEL: (212) 779-0257 FAX: (212) 779-9848</p>	PROJECT NO. 0000		NO.	DATE	REVISION
	DATE 9.19.17				
	SCALE AS NOTED				
	DWG BY: NC				
LOCATION		<p>T-001.00</p>			
8118 13TH AVENUE BROOKLYN, NEW YORK		<p>ALL RIGHTS RESERVED. ALL DRAWINGS, SPECIFICATIONS AND COPIES THEREOF PROVIDED BY THE ARCHITECT ARE AND SHALL REMAIN THEIR PROPERTY. THEY ARE NOT TO BE USED ON THIS OR ANY OTHER PROJECT UNLESS WRITTEN PERMISSION IS GIVEN BY G. M. ARCHITECTS.</p>			
		<p>SHEET: 0 OF 0</p>			

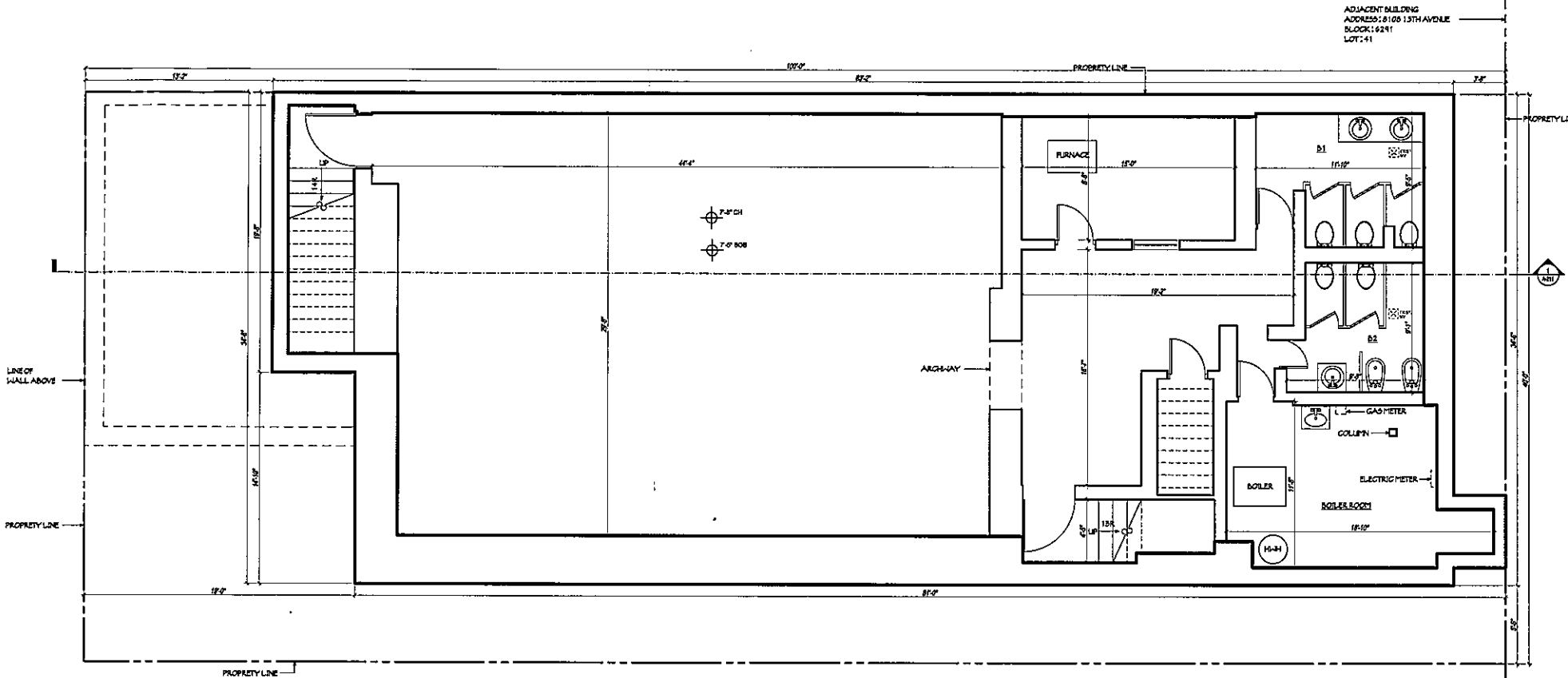

ADJACENT BUILDING
ADDRESS: 8100 13TH AVENUE
BLOCK: 6211
LOT: 41

ADJACENT BUILDING
ADDRESS: 8100 13TH AVENUE
BLOCK: 6211
LOT: 43

CELLAR - EXISTING CONDITIONS PLAN



**GRASSO-MENZUO ARCHITECTS
AIA**
350 SEVENTH AVENUE, N.Y., N.Y. 10001
TEL: (212) 778-0257 FAX: (212) 778-8848

TITLE
CELLAR FLOOR PLAN

LOCATION
8118 13TH AVENUE
BROOKLYN, NEW YORK

PROJECT NO. 0000 NO. DATE REVISION

DATE 9.19.17

SCALE AS NOTED

DWG BY: MC

A-101.00

SHEET 0 OF 0

ALL RIGHTS RESERVED.
ALL DRAWINGS, SPECIFICATIONS AND COPIES THEREOF PROVIDED BY THE ARCHITECT ARE AND SHALL REMAIN THEIR PROPERTY. THEY ARE NOT TO BE USED ON THIS OR ANY OTHER PROJECT UNLESS WRITTEN PERMISSION IS GIVEN BY G. M. ARCHITECTS.

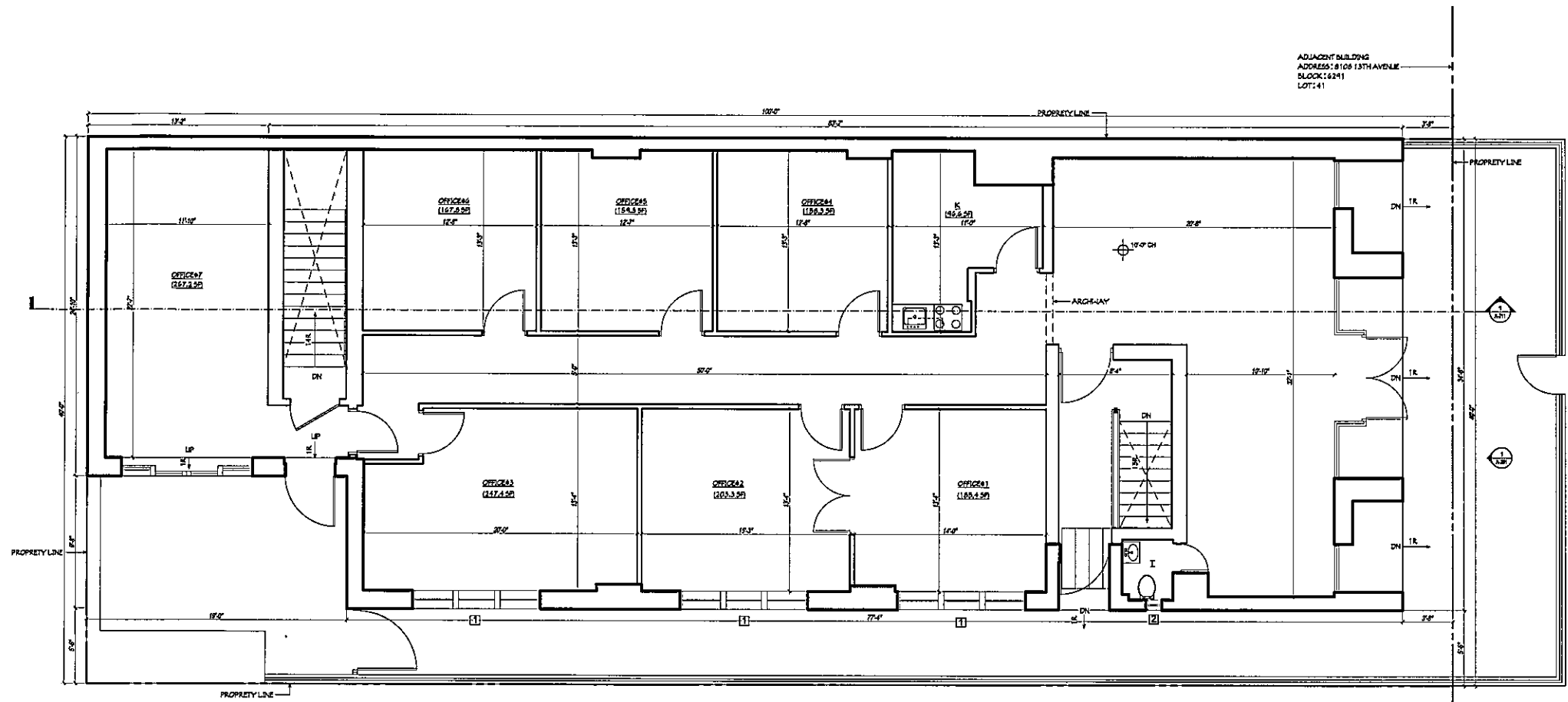

ADJACENT BUILDING
ADDRESS: 8108 13TH AVENUE
BLOCK: 6241
LOT: 41

ADJACENT BUILDING
ADDRESS: 8120 13TH AVENUE
BLOCK: 6241
LOT: 48

1ST FLOOR - EXISTING CONDITIONS PLAN

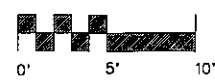

**GRASSO-MENZUGO ARCHITECTS
ALA**

350 SEVENTH AVENUE, N.Y., N.Y. 10001
TEL: (212) 779-0257 FAX: (212) 779-0448

TITLE
1ST FLOOR PLAN

LOCATION
8118 13TH AVENUE
BROOKLYN, NEW YORK

PROJECT NO.	0000	NO.	DATE	REVISION
DATE	9.19.17			
SCALE	AS NOTED			
DWG BY:	MC			
A-102.00				
SHEET:	0 OF 0			

ALL RIGHTS RESERVED.
ALL DRAWINGS, SPECIFICATIONS AND COPIES THEREOF PROVIDED BY THE ARCHITECT ARE AND SHALL REMAIN THEIR PROPERTY. THEY ARE NOT TO BE USED ON THIS OR ANY OTHER PROJECT UNLESS WRITTEN PERMISSION IS GIVEN BY G. M. ARCHITECTS.

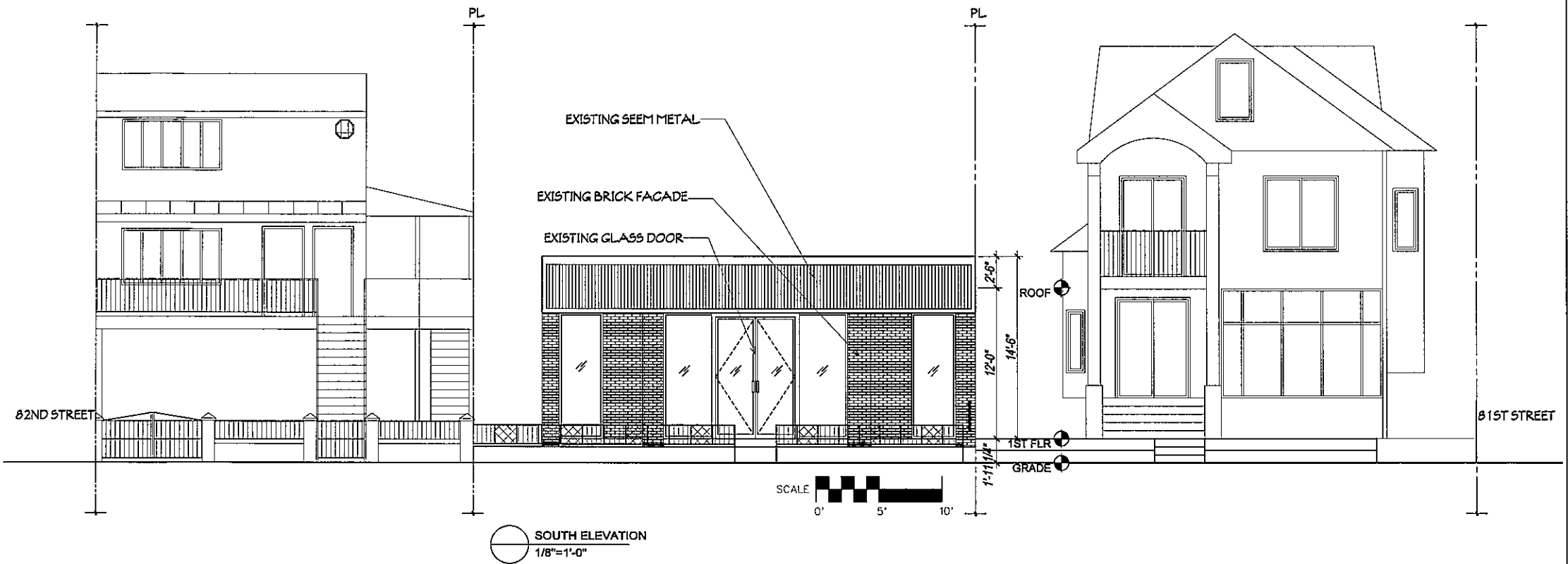

**GRASSO-MENZIUSO ARCHITECTS
A.I.A.**
350 SEVENTH AVENUE, N.Y., N.Y. 10001
TEL: (212) 779-0257 FAX: (212) 779-9848

TITLE
BUILDING ELEVATION
LOCATION
8118 13TH AVENUE
BROOKLYN, NEW YORK

PROJECT NO. 0000 NO.
DATE 9.19.17
SCALE AS NOTED
DWG BY: NC
A-201.00
SHEET: 0 OF 0

ALL RIGHTS RESERVED.
ALL DRAWINGS, SPECIFICATIONS AND COPIES THEREOF PROVIDED BY THE ARCHITECT ARE AND SHALL REMAIN THEIR PROPERTY. THEY ARE NOT TO BE USED ON THIS OR ANY OTHER PROJECT UNLESS WRITTEN PERMISSION IS GIVEN BY G. M. ARCHITECTS.

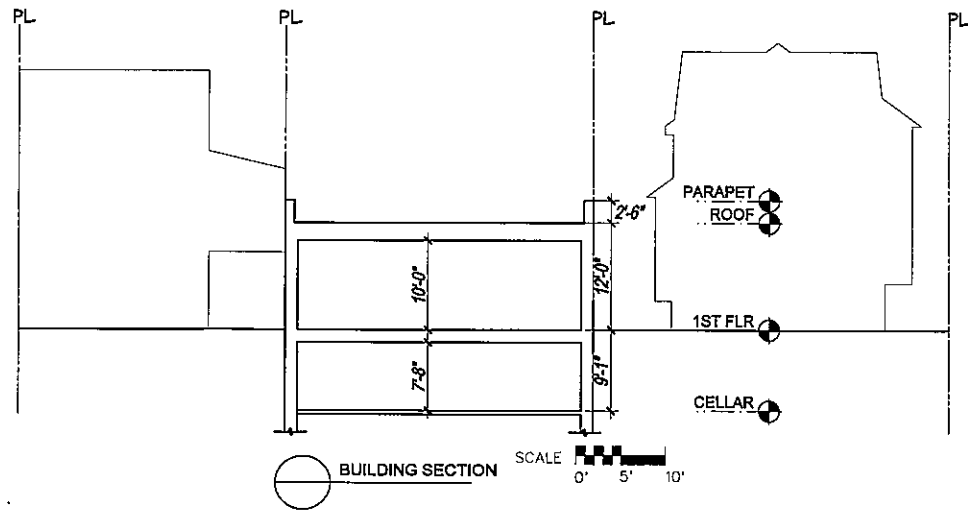
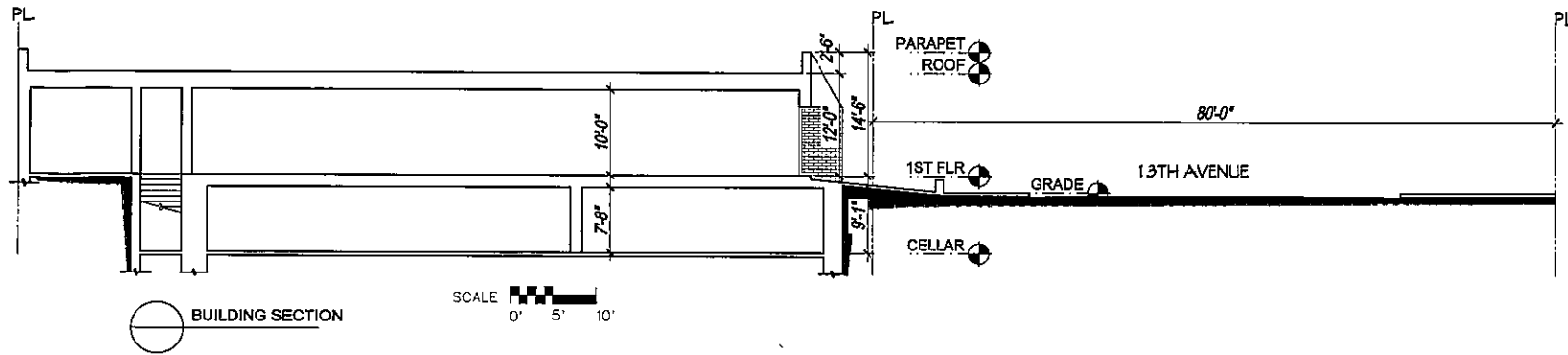

**GRASSO-MENZIUSSO ARCHITECTS
A.I.A.**
350 SEVENTH AVENUE, N.Y., N.Y. 10001
TEL: (212) 779-0257 FAX: (212) 779-9648

TITLE
BUILDING SECTION
LOCATION
8118 13TH AVENUE
BROOKLYN, NEW YORK

PROJECT NO:	0000	NO.	DATE	REVISION
DATE	9.19.17			
SCALE	AS NOTED			
DWG BY:	NC			
A-211.00				
SECT:	0 OF 0			

ALL RIGHTS RESERVED.
ALL DRAWINGS, SPECIFICATIONS AND COPIES THEREOF PROVIDED BY THE ARCHITECT ARE AND SHALL REMAIN THEIR PROPERTY. THEY ARE NOT TO BE USED ON THIS OR ANY OTHER PROJECT UNLESS WRITTEN PERMISSION IS GIVEN BY G. M. ARCHITECTS.

Queens Boulevard MIH Text Amendments

New York City Council

64-11 and 72-12 Queens Boulevard,
Maspeth and Woodside, NY
ULURP Application No. N 19305 ZRQ



akerman

Aerial Context



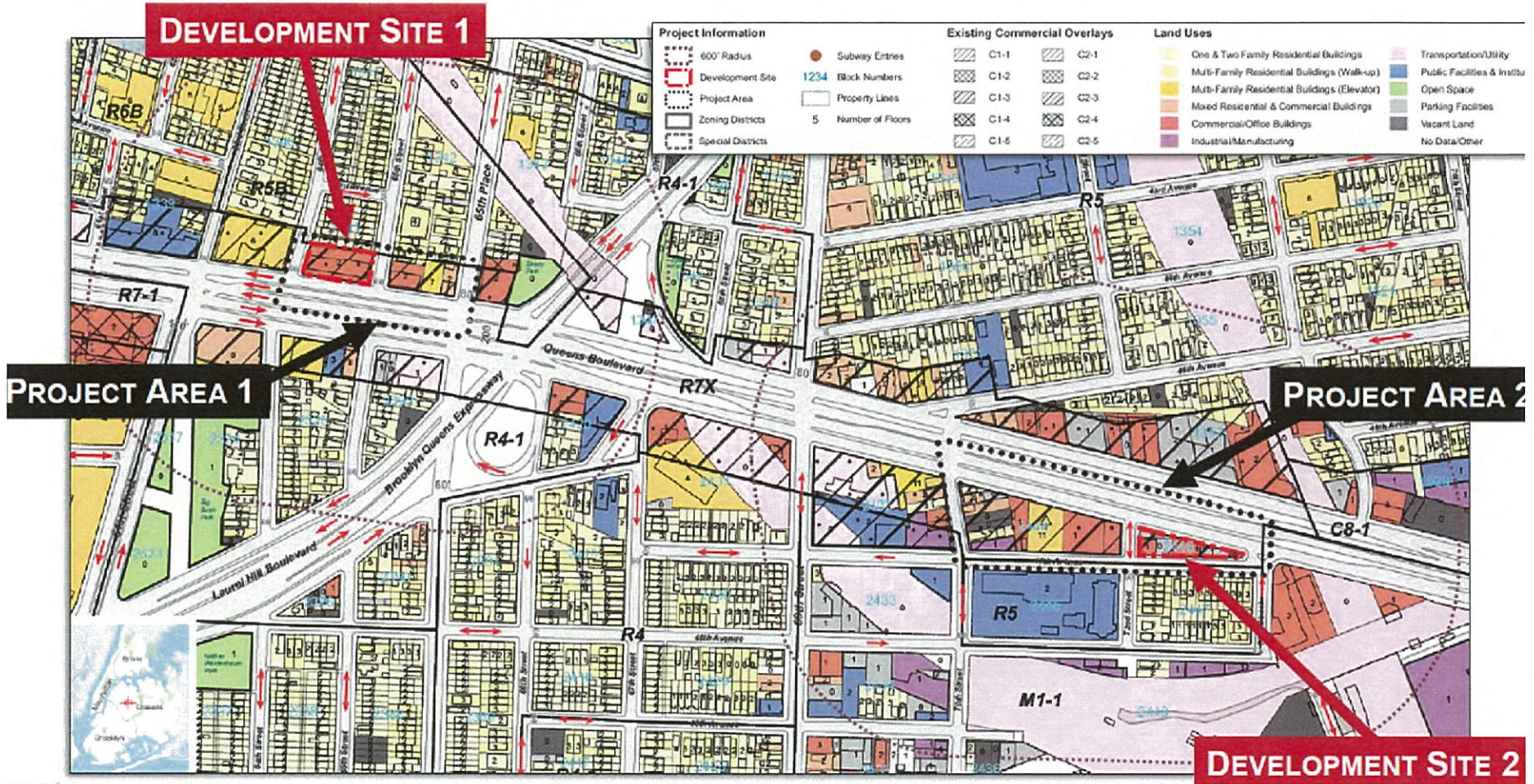

Surrounding Area Context

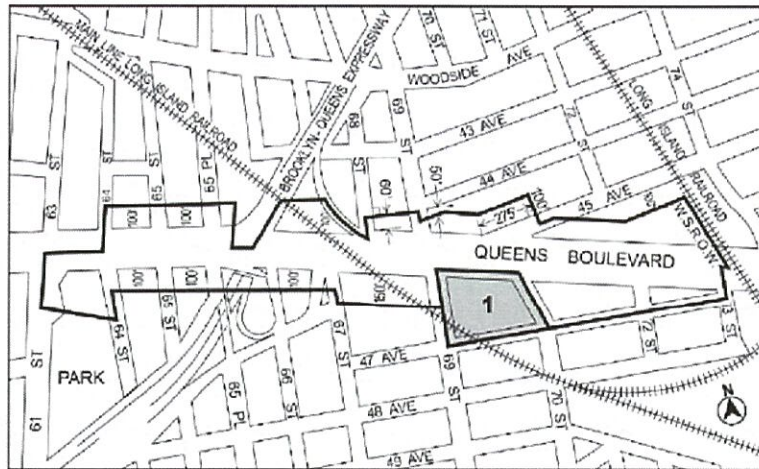

MIH Zoning Text Map

[EXISTING MAP]







-  Inclusionary Housing designated area
-  Mandatory Inclusionary Housing Program Area *see Section 23-154(d)(3)*
Area 1—10/31/18 MIH Program Option 2

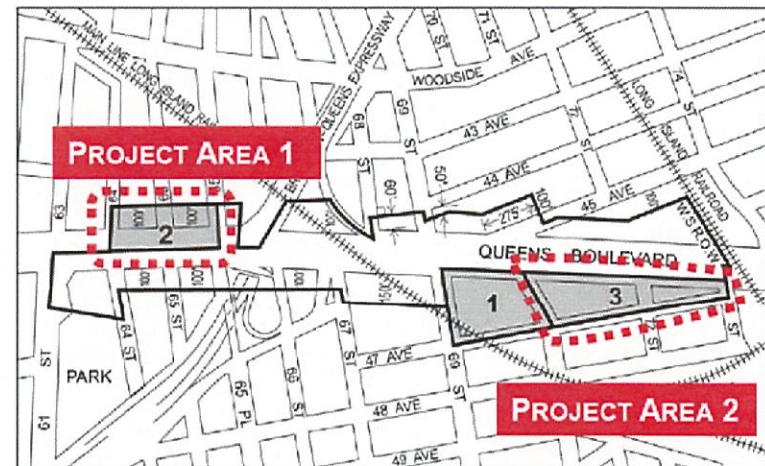

[PROPOSED MAP]



-  Inclusionary Housing designated area
-  Mandatory Inclusionary Housing Program Area *see Section 23-154(d)(3)*
Area 1—10/31/18 MIH Program Option 2
-  Mandatory Inclusionary Housing Area *see Section 23-154(d)(3)*
Area 2 — [date of adoption] — MIH Program Option 1 and Option 2
-  Mandatory Inclusionary Housing Area *see Section 23-154(d)(3)*
Area 3 — [date of adoption] — MIH Program Option 1 and Option 2

Project Area 1



Project Area 2

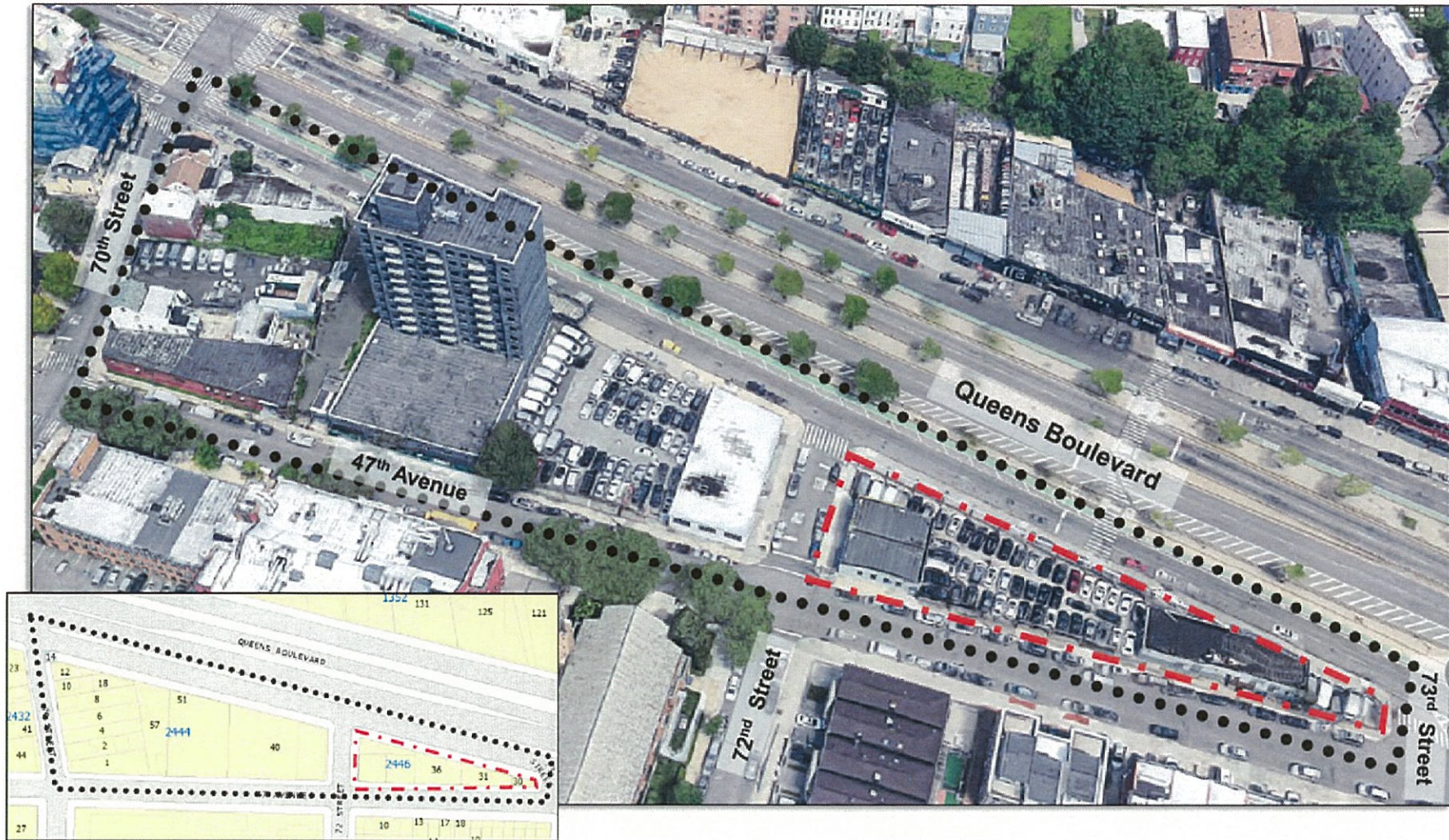

Proposed Development- 64-11 Queens Boulevard

- To facilitate the development of a new 13-story mixed-use building containing:
 - approx. 140 residential units
 - approx. 42 permanently affordable units**
 - 1,654 zsf of ground floor retail
 - approx. 75 parking spaces



*Unit breakdown: 60 studios, 3 1-br units, 64 2-br units, and 13 3-br unit

** Market rate unit sizes and types proportional to affordable dwelling unit.

***4 commercial spaces and 71 residential accessory parking spaces (53 required)

Ground Floor Plan- 64-11 Queens Boulevard

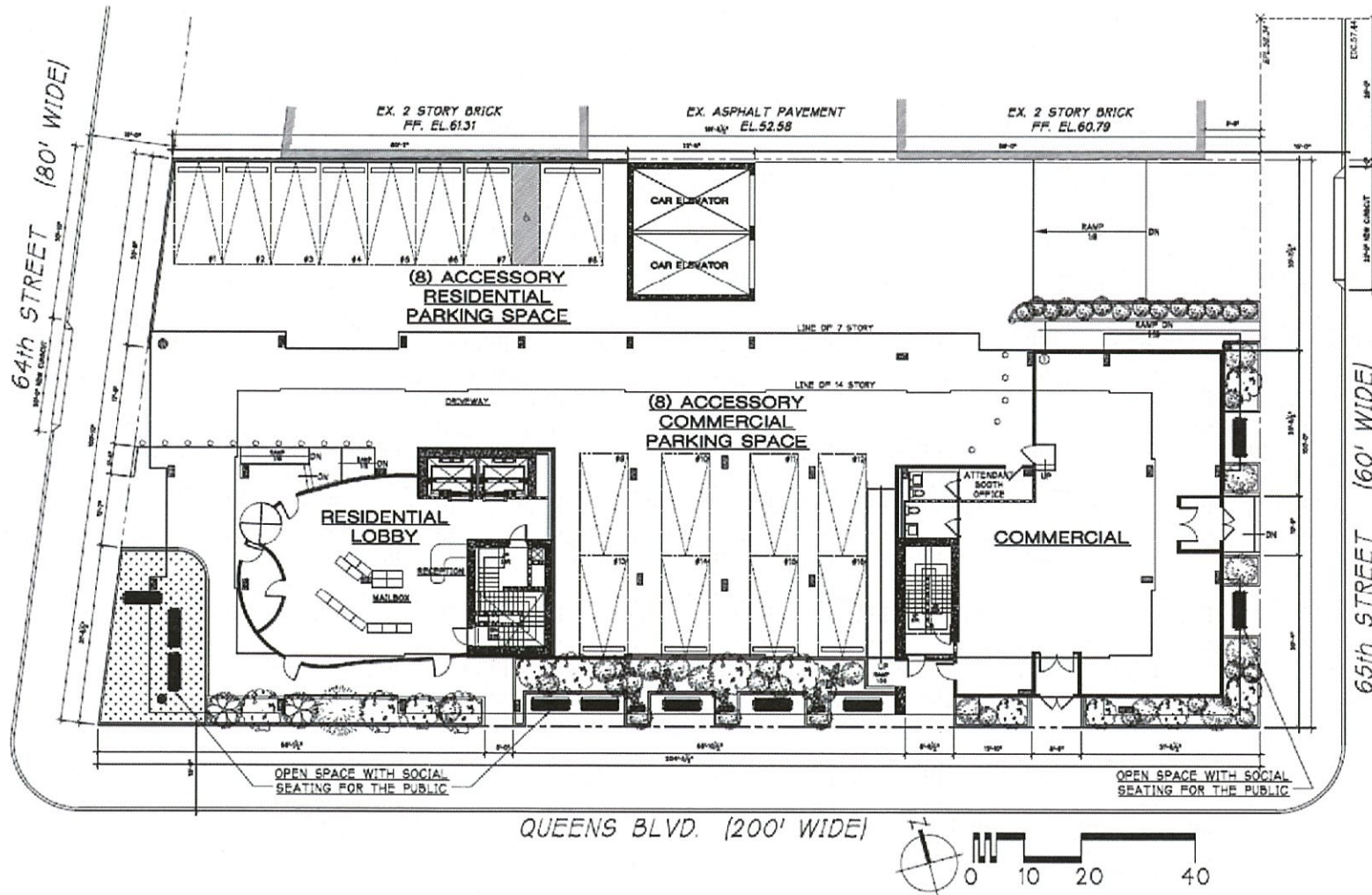

Proposed Development- 72-12 Queens Boulevard

- To facilitate the development of a new 12-story mixed-use building containing:
 - approx. 78 residential units
 - approx. 23 permanently affordable units**
 - 5,481 zsf of ground floor retail
 - approx. 32 parking spaces



*Unit breakdown: 10 studios, 19 1-br units, 38 2-br units, and 11 3-br units

** 30% @ average 80% AMI; Market rate unit sizes and types proportional to affordable dwelling unit.

***32 residential accessory parking spaces (29 required)

MIH Administering Agent & Management Company

HANAC, Inc.

- Founded in 1972
- Serves the needs of vulnerable populations throughout NYC over 35,000/year
- Responsible for ensuring that affordable housing units are rented in compliance with zoning provisions and guidelines applicable to affordable units. Owns and Manages over 600 units

Services:

- Marketing, processing applications, explaining eligibility and application requirements
- Assistance with applications and forms, referrals for counseling and many other types of community-based services

Administrative office located at 27-40 Hoyt Avenue S, Astoria

Fiscal office located at 1250 Broadway, Manhattan

Akerman LLP
650+ Lawyers
24 Offices

akerman.com

©2017 Akerman LLP. All rights reserved.



akerman



Fox Rothschild ^{LLP}
ATTORNEYS AT LAW

46-74 Gansevoort Street

Modification to ULURP No. C 840260 ZMM

Background

- Site is subject to a restrictive declaration (D-94) dating back to 1984, as amended, which limits permitted uses
 - The Declaration was initially placed on the property in conjunction with a 1984 Rezoning
 - The Final Environmental Impact Study (“FEIS”) for the 1984 Rezoning disclosed that the rezoning could potentially result in adverse impacts on industrial meat production-related businesses in the area
 - Use restrictions were imposed to mitigate such potential impacts
 - The Declaration has been amended multiple times, but the current Second Amended Declaration allows:
 - Permitted Uses, within Use Groups 11, 16, 17, and 18
 - Use Groups 6 and 9, except:
 - No Use Group 6B (i.e. offices)
 - No eating and drinking establishments with entertainment uses
 - No eating and drinking establishments in rear yards or on the roof
 - Modification seeking to allow:
 - Use Groups 3, 4, and 6B in addition to those currently permitted

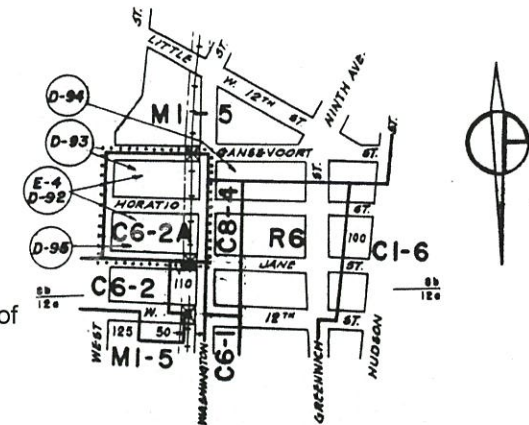

	M1-5 As-of-Right	1984 RD	1998 First Amended RD	2003 Second Amended RD	Modification Application
Permitted Uses	<ul style="list-style-type: none"> • UG 3-14, 16-17 	<ul style="list-style-type: none"> • UG 11, 16, 17, & 18 • Best efforts to maintain Site for meat-related use in UG 17A/B 	<ul style="list-style-type: none"> • UG 11, 16, 17, & 18 • UG 6 at 46-50 Gansevoort 	<ul style="list-style-type: none"> • UG 11, 16, 17, & 18 • UG 6 & 9 <ul style="list-style-type: none"> • No UG 6B • No Eating & Drinking Establishments w/ entertainment or in rear yards/on roofs 	<ul style="list-style-type: none"> • UG 11, 16, 17, & 18 • UG 6 & 9 <ul style="list-style-type: none"> • Including UG 6B • No Eating & Drinking Establishments w/ entertainment or in rear yards/on roofs • UG 3 & 4

M1-5 Zoning District – Uses Permitted As-of-Right

Uses within Use Groups 3-14, 16-17 are permitted in M1-5 Zoning Districts on an As-of-Right basis

Use Group	Examples of Uses
3A	Museums ancillary to existing motion picture production, radio, or television studios
4	Community Facilities, including houses of worship, limited health facilities, open uses such as agricultural uses or parks
5	Transient Hotels (permitted only by City Planning Commission Special Permit)
6	Food stores and variety stores*, bakeries, drug stores, beauty parlors, dry cleaning, hardware stores, liquor stores, post offices, shoe or hat repair, stationary stores, tailors/dressmaking shops; Retail or service establishments, including antique stores, commercial art galleries, artists' supply stores, banks, bicycle sales, book stores, candy or ice cream stores, carpet, rug, or other flooring stores*, clothing stores*, clothing rental stores*, dry goods or fabrics stores*, eating and drinking establishments, including those that provide outdoor table service, eating and drinking establishments with entertainment (but not dancing) with a capacity of 200 persons or fewer, eating and drinking establishments with musical entertainment (but not dancing) with a capacity of 200 persons or fewer, florist shops, furniture stores*, gift shops, interior decorating establishments, jewelry or art metal craft shops, leather goods or luggage stores, loan offices, meeting halls, toy stores, wallpaper stores, watch or clock stores or repair shops; Public Service Establishments, such as court houses, electric or gas utility substations, fire or police stations, public utility stations for oil or gas metering, solar energy systems, water or sewer pumping stations; Non-commercial clubs; (6B) Offices, business, professional including ambulatory diagnostic or treatment health care, or governmental, veterinary medicine for small animals
7	Transient Hotels (permitted only by City Planning Commission Special Permit); Retail or service establishments, including bicycle rental or repair shops, moving or storage offices; wholesale establishments (with no more than 1,500 SF accessory storage per establishment); auto service establishments, including automobile glass and mirror shops, electrical vehicle charging stations
8	Amusements, including billiard parlors, bowling alleys, theaters; Retail or Service Establishments, including automobile driving schools, television, radio, and appliance repair shops, upholstering shops; Automotive Service Establishment including automobile rental establishments
9	Retail or Service Establishments, including automobile, motorcycle, trailer or boat showrooms or sales, banquet halls, business schools or colleges, catering establishments, clothing or costume rental establishments, gymnasiums for basketball, handball, paddleball, racketball, squash, or tennis, medical or dental laboratories, musical instrument repair shops, plumbing, heating, or ventilating equipment showrooms, printing establishments***, public auction rooms, art, music, dance, or theatrical studios, trade or other schools for adults, wedding chapels; Wholesale Establishments, including hair products for headwear, photographic developing or printing***
10	Depositories for storage of office records, microfilm or computer tapes, or for data processing, office or business machine stores, sales, or rentals, production studios; Wholesale offices or showrooms
11	Manufacturing establishments, including art needlework, books, ceramic products, clothing, hair products, jewelry manufacturing from precious metals, medical, dental, drafting instruments, optical goods, or similar precision instruments, musical instruments, orthopedic or medical appliances, printing***, watchmaking; Wholesale or similar establishments (with accessory storage limited to 2,500 SF/establishment)
12	Amusements, including auditoriums, billiard or pool halls, bowling alleys, table tennis halls, eating and drinking establishments with entertainment and a capacity of more than 200 persons, or establishments of any capacity with dancing, historical exhibits, indoor golf, public auction rooms; Retail establishments, including antique stores, commercial art galleries, book stores, candy or ice cream stores, delicatessen stores, drug stores, gift shops, jewelry or art metal craft shops, music stores, news stands, photographic equipment stores, record stores, stationary stores, toy stores; Public Service Establishments, including police stations; Automotive service establishments
13	Amusements, open or enclosed, including miniature golf, golf driving ranges, theaters; Retail Establishments, including banquet halls, catering establishments, refreshment stands
14	Retail or Service Establishments, including bicycle rental, repair, or sales, candy and ice cream stores, fishing tackle or equipment, sale or rental of sporting goods; Non-commercial clubs
16	Retail or Service Establishments, including animal hospitals or kennels, animal pounds or crematoriums, automobile, motorcycle, trailer, or boat sales, blacksmith shops, building materials sales*, carpentry, custom woodworking, or custom furniture making shops, crematoriums, electrical, glazing, heating, painting, paper hanging, plumbing, roofing or ventilating contractors' establishments**, household office equipment or machinery repair shops, machinery rental or sales establishments, mirror silvering or glass cutting shops, poultry or rabbit killing establishments for retail sale on same zoning lot, sign painting shops with no floor area limit, silver plating shops, soldering or welding shops, tools, die, or pattern making establishments; Heavy Service, Wholesale, or Storage Establishments, including linen, towel, or diaper supply establishments, moving or storage offices, packing or crating establishments, warehouses, wholesale establishments Automotive Service Establishments, including automobile service stations for minor repairs and washing; Vehicle Storage Establishments
17	Service or wholesale establishments, including building materials or contractors' yards, wholesale produce or meat markets; Manufacturing establishments, including adhesives, advertising displays, aircraft, apparel or other textile products, automobiles, trucks, or trailers, non-alcoholic beverages, boats, bottling work for all beverages, brushes or brooms, cameras or other photographic equipment, canvas or canvas products, carpets, ceramic products, chemicals, cork products, cosmetics or toiletries, cotton, electrical appliances, electrical equipment, food products, fur goods, glass products from previously manufactured glass, hair, felt, or feather products, except washing, curing, or dyeing, hosiery, ink, laboratories, research, experimental or testing, leather products, luggage, business machines, miscellaneous machinery, including washing machines and refrigerators, machine tools, mattresses, metal finishing, plating, grinding, sharpening, polishing, cleaning, or other similar processes, motor cycles, musical instruments, novelty products, optical equipment, orthopedic or medical appliances, paper products, perfumes, pharmaceutical products, plastic products, printing or publishing establishments, rubber products, scenery construction, silverware, steel products, textiles, tobacco, tools or hardware, toys, umbrellas, bulk upholstering, children's vehicles, including bicycles and baby carriages, venetian blinds and window shades, wax products, wood products; Miscellaneous uses, including trucking terminals and motor freight stations
	*= limited to 10,000 SF/establishment **=limited to 5,000 SF/establishment ***=limited to 2,500 SF/establishment

1984 Declaration & Amendments

- **1984 Declaration (Approved Under ULURP No. M 840260 ZMM)**
 - Limited Site to “Permitted Uses” within Use Groups 11, 16, 17, & 18
 - Required best efforts to maintain Site for meat-related Use Group 17A and 17B uses
- **First Amended Declaration (Approved in 1998 Under ULURP No. M 840260 (B) ZMM)**
 - CPC approved a modification to expand the uses permitted at 46-50 Gansevoort to include Use Group 6 Uses in addition to the “Permitted Uses” within Use Groups 11, 16, 17, & 18
- **Second Amended Declaration (Approved in 2003 Under ULURP No. M 840260 (C) ZMM)**
 - In 2003, CPC approved a modification to expand the uses permitted to include Use Groups 6 & 9 in addition to the “Permitted Uses” (UG 11, 16, 17, & 18);
 - City Council modified the CPC approval to prohibit Use Group 6B uses, eating and drinking establishments of any type in rear yards or on roofs, and eating and drinking establishments with entertainment
- **Modification application seeks to additionally allow Use Groups 3, 4, and 6B**
 - Uses permitted would then include Use Groups 3, 4, 6 (including 6B), 9, 11, 16, 17, & 18
 - Use Groups 3 & 4 = Community Facility uses
 - Use Group 6B = Offices, business, professional including ambulatory diagnostic or treatment health care, or governmental, veterinary medicine for small animals
 - Eating and drinking establishments with entertainment and eating and drinking establishments in the rear yards or on the roof remain prohibited

Community Benefits

- Discussions with Community
 - Community Benefit Spaces and significant site restrictions
- New Restrictions to Benefit Quality of Life in the Community
 - Three liquor licenses and four beer and wine licenses
 - No liquor license may be sought/obtained for any spaces contiguous to and/or with direct access to any Outdoor Premises
 - No building height increase over 5' and only in event of casualty
 - No transfer of unused Floor Area for use at 803-807 Washington Street
 - Any unused Floor Area must adhere to the Restrictive Declaration if ever developed at the Site
 - Outdoor Premises:
 - Installation of visual and sound attenuation screening along the southern perimeters of the 2nd floor terraces ("Terraces")
 - No mechanical equipment may be located in the Site's rear yards
 - Roofs and Terraces to be used for passive recreation only
 - Terraces will close at 8 p.m. Sunday-Wednesday; 10 p.m. Thursday-Saturday
 - Fifth floor rooftop will close at 10 p.m. daily
 - Music and amplified sound will be prohibited on all roofs and Terraces

Community Benefit Spaces

- On-Site Community Benefit Space
 - 1,775 RSF on Lower Level of 68 Gansevoort Street
 - To be rented to non-profit arts organization for \$1/year
- Off-Site Community Benefit Space
 - 4,000 RSF of Community Benefit Space at site comprised of 7-11 Weehawken St., 300 W 10th St., and 171-177 Christopher St.
 - To be allocated as evenly as possible between non-profit service and arts organizations
 - \$25 per RSF with a 10% increase every 5 years
 - Community Benefit Space allocated to service organization (approximately 2,000 RSF) subject to right by service organization or Owner to opt for funding approximately commensurate with the value of the rent, in lieu of space
 - No more than 50% of the total square footage of all Community Benefit Spaces will be below grade

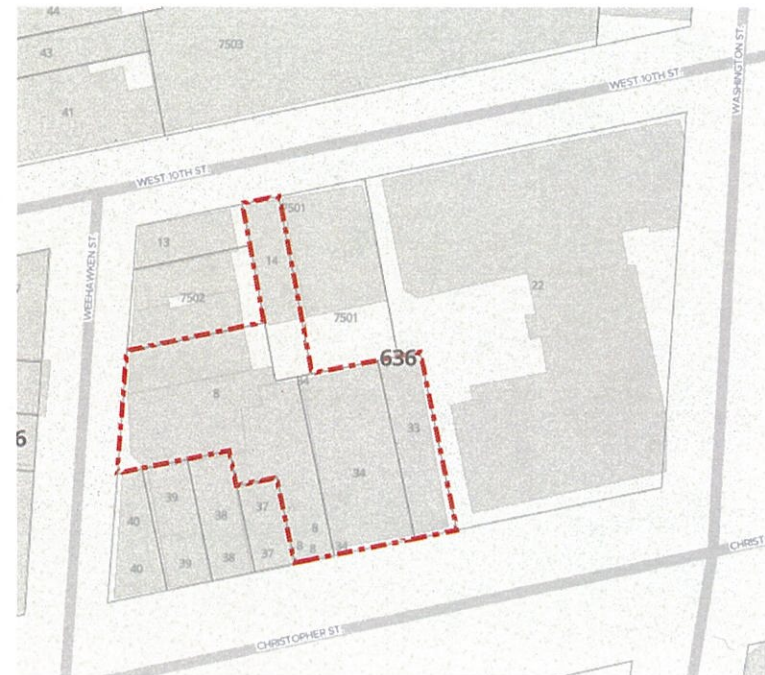

Proposed Modification

- From a land use perspective, the proposed uses fit within the context of the Surrounding Area while minimizing impacts on residents
- Modification would only allow uses permitted by the underlying zoning district, which are currently permitted on neighboring sites
- Office use is a predominant commercial use in area
- Given the changes in the meatpacking industry in New York City and the area since 1984, the use restrictions have become obsolete and the mitigation measures originally included in the FEIS are no longer necessary
- The proposed modification allows for enhanced consistency with uses in the neighborhood
- The Applicant has agreed to significant site restrictions and community benefits
 - On-Site Community Benefit Space
 - Off-Site Community Benefit Space
 - Restrictions on bulk and development rights transactions
 - Restrictions on operations

Elizabeth Bennett, Esq.
Fox Rothschild, LLP
ebennett@foxrothschild.com



Fox Rothschild LLP
ATTORNEYS AT LAW

WOODSIDE TENANTS ASSOCIATION

February 12, 2020

Council Member Jimmy Van Bramer
47-01 Queens Boulevard Suite 205
Sunnyside, NY 11104

Dear Council Member Jimmy Van Bramer,

I am the Tenant's Association President of the Woodside Houses in Queens. I write to express my support of the two new mixed use developments as part of the Queens Mandatory Inclusionary Housing Text Amendments located at 64-11 Queens Boulevard and 72-12 Queens Boulevard. The proposal will facilitate the development of 218 dwelling units of which 65 will be permanently affordable and also approximately 7,000 square feet of retail space that will bring quality retail jobs to the community.

The creation of new affordable housing opportunities are greatly needed in the neighborhood. I've had the privilege of meeting the developers and I feel confident that they will be a strong community partner. This new development will provide a great benefit to the neighborhood, especially residents of the Woodside Houses.

I therefore fully support the proposed development and request that it be approved.

Sincerely,



Ann Cotton Morris





Reverend Corwin S. Mason, Pastor

Reverend Corwin S. Mason, Pastor
Community Church of Astoria, 1240 1st Avenue, Astoria, OR 97103
Phone: 503.325.1234 Fax: 503.325.1235
3030 50th Street, Astoria, OR 97103

February 12, 2020

Council Member Jimmy Van Bramer
47-01 Queens Boulevard Suite 205
Sunnyside, NY 11104

Dear Council Member Jimmy Van Bramer,

I pray this letter finds you in the best of health spiritually, physically, and mentally. I am the Pastor of Community Church of Astoria. I write to express my support of the two new mixed use developments as part of the Queens Mandatory Inclusionary Housing Text Amendments located at 64-11 Queens Boulevard and 72-12 Queens Boulevard. Currently these sites along Queens Boulevard are occupied by vacant hotels and motels, auto-related uses and outdated residential walk-up buildings. The proposal will facilitate the development of 218 dwelling units of which 65 will be permanently affordable and also approximately 7,000 square feet of retail space that will bring quality retail jobs to the community.

The proposal will create new affordable housing opportunities that are greatly needed in the neighborhood. The developer has committed to working with 32BJ to ensure prevailing wage jobs for building service workers. In addition, the developer has agreed to work with Urban Upbound to ensure local hiring for this project. Overall, the permanently affordable housing units, good jobs, and partnership with Urban Upbound will provide a great benefit to the neighborhood, especially residents of Astoria and Woodside.

I therefore fully support the proposed development and request that it be approved.

In His Service,



Reverend Corwin S. Mason

CB1
Wednesday, February 12, 2020

Good evening, my name is Nijema Rivera, the Director of Property Management for HANAC, Inc.

For those who are not familiar with us, HANAC is a multi-faceted social services nonprofit organization founded in 1972 in Astoria, New York, and was developed to serve the needs of a vulnerable population throughout the City.

For the past 20 years, HANAC has played an ever-expanding role as an affordable housing developer in the City of New York. HANAC now owns and operates four (4) fully service senior residences and one (1) multifamily residence totaling over 600 units within Astoria, Corona and flushing Queens.

HANAC is fully committed with the development of affordable housing especially for seniors, and we support any efforts towards that goal.

Spiti Management (HANACs Property Management Company) will be working with Mega as the Administering Agent and Management Company for the MIH units. Spiti Management will be doing all the marketing by reaching out to the different community boards, advertising the project in local newspapers, and processing all the applications. HANAC's trained HPD Housing Ambassadors will assist with applications, referrals for counseling and other community based social services. As the Managing Agent the company will ensure compliance and that the regulatory agreement is followed.

One of the organizations main focus is the senior community and meeting their housing needs. The extraordinary relationship HANAC has with the senior community in providing senior centers, senior engagement and various activities is exceptional one. We will use the voice of HANAC to reach the senior community in regards to supporting and assisting them in the housing process.

Our overall objective is to provide effective management and assist with providing affordable housing for all.

EMP Agrees to CBA for Grand-Pacific Rezoning

The rezoning under consideration today is within an area of northwestern Crown Heights known as the M-CROWN district, for which Community Board 8 has expressed a vision that includes mixed-use development encouraging the creation of good-paying, accessible jobs and affordable apartments for local community members. A plan to move forward with this vision in conjunction with the Department of City Planning was affirmed by the Community Board on September 12, 2019. The Board's resolution called for a floor area ratio of four to five for lots along Grand Avenue.

On November 14, 2019, Brooklyn Community Board 8 voted to withhold support for the Grand/Pacific Rezoning as the density sought is greater than that expressed in the Board's September 12 resolution. However, the Board left open the door to supporting the rezoning should the applicant be willing to make a binding commitment that at least 0.25 FAR of the ground floor of the building to be constructed at 979-985 Pacific Street be dedicated to preferred M-CROWN job-creating uses, and that the applicant limit development at the site to no more than nine stories.

I am happy to report that Community Board 8 has negotiated an agreement which the applicant has executed that provides the commitment sought in the Board's November 14 resolution with respect to building height and restricted use at the ground floor.

Per its November 14 resolution, the Board's support for the Grand/Pacific Rezoning also requires that lots south of Pacific Street be rezoned to R7A/C2-4, consistent with the guidelines in its September 12 M-CROWN resolution. I therefore ask the City Council to amend the requested zoning accordingly.

Finally, Brooklyn Community Board 8 has consistently expressed a desire to see affordable apartments created in the M-CROWN district be affordable to families earning the median income for Brooklyn community district 8. Unfortunately, the application requests mapping to both MIH options 1 and 2. Option 2, which provides affordable apartments at an average of 80%, will not address the need for affordable housing among low-income residents of community district 8. I therefore ask that the City Council map the Grand/Pacific rezoning to MIH option 1 only, which will ensure a range of affordability levels between 40% and 80% AMI, accessible to the range of residents in our district who need affordable housing.

Ethel Tyus, Chair, Brooklyn Community Board 8
2/12/2020

Cieli Partners LP
900 7th Avenue
New York, NY 10106
License #1192416-DCA

2/5/20

Honorable Council Member Powers
211 East 83rd Street, #1205
New York, NY 10017

Dear Honorable Chairperson Salamanca, Council Member Powers and Members of the Council,

Please accept this letter as confirmation of our agreement with Councilmember Powers.
We agree to the following:

- All planters will be removed and never used again
- All tables will be flush against the wall

If anything else is required, please contact my representative, Michael Kelly, at (914) 632-6036.

Sincerely,

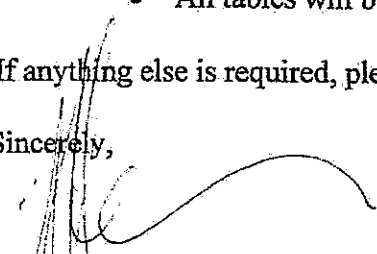

Sheldon Fireman
President



First Baptist Church

100-10 Astoria Blvd., E. Elmhurst, NY 11369
Phone: 718.448.0200/0481 Fax 718.585.6115
Reverend Patrick H. Young, Pastor
E-mail: firstbaptistchurch.fbc@gmail.com

February 12, 2020

Council Member Jimmy Van Bramer
47-01 Queens Boulevard Suite 205
Sunnyside, NY 11104

Dear Council Member Jimmy Van Bramer,

I am the Senior Pastor of First Baptist Church of East Elmhurst. I am writing to express my support of the two new mixed use developments as part of the Queens Mandatory Inclusionary Housing Text Amendments located at 64-11 Queens Boulevard and 72-12 Queens Boulevard. The project will be life changing to those living and working in this community. This new development will bring good jobs, 7,000 square feet of retail space and bring a total of 218 dwelling units of which 65 will be permanently affordable. Currently these sites along Queens Boulevard are occupied by vacant hotels and motels, auto-related uses and outdated residential walk-up buildings.

This building project will create new housing opportunities which our neighborhood greatly needs. I have members who live in the area and are looking forward to those mixed-income units being available to them. The developer has committed to working with 32BJ SEIU to ensure good paying jobs for building service workers.

Overall, the mixed-income housing units and good jobs will greatly benefit the neighborhood, especially residents of the Woodside.

I therefore fully support the proposed new development and request that it be approved.

In His Service,

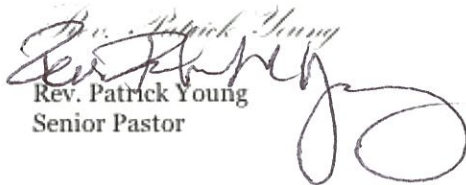
Rev. Patrick Young
Senior Pastor

Mount Horeb Baptist Church

109-20 Edward E. Jarvis Drive
Corona, NY 11368

February 12, 2020

Council Member Jimmy Van Bramer
47-01 Queens Boulevard Suite 205
Sunnyside, NY 11104

Dear Council Member Jimmy Van Bramer,

My name is Reverend Gilbert Pickett and I am the Pastor of the Mt. Horeb Baptist Church in Corona, and the Moderator of The Eastern Baptist Association representing 107 churches in Queens. We are in favor of the two new mixed use developments located at 64-11 Queens Boulevard and 72-12 Queens Boulevard.

This proposed new mixed-use campus will provide much needed housing, job opportunities and new landscape. The proposed new developments will bring a total of 218 dwelling units of which 65 will be permanently affordable and also approximately 7,000 square feet of retail space that will bring quality retail opportunities to the community.

I therefore fully support the proposed redevelopment and request that it be approved.

Respectfully,



Rev. Gilbert Pickett
Senior Pastor
Moderator EBA

Richard Lobel

Subject: FW: Avenue O Rezoning

From: Stephen Epstein <emanwater@aol.com>
Sent: Monday, February 10, 2020 11:04 AM
To: Frank Noriega <fnoriega@sheldonlobelpc.com>
Subject: Re: Avenue O Rezoning

EXTERNAL

Frank:

It is a pleasure dealing with you. You are very thorough and I appreciate that you have answered all my questions in a timely manner.

Please be advised that R3-1 is a go for Dr. Soni based on the 1500 square ft. restrictions and that this restriction applies to all subsequent owners of 2519-2523 Avenue O, Brooklyn.

Councilman Chaim Deutsch has been advised that the East 26 Street--Avenue O Block Association and neighbors on adjacent blocks seem to accept the R3-1 rezoning for the Avenue O block between Bedford Avenue and East 26 Street.

Cordially,
Stephen L. Epstein, President
East 26 Street--Avenue O Block Association

EAST 26 STREET - AVENUE O BLOCK ASSOCIATION

UPDATE ON PROPOSED ZONING CHANGE FOR AVENUE O

February 6, 2020

Jose
Ortiz 929
334-9852

Dear Neighbor,

This newsletter contains the latest information regarding the proposal to change the zoning for the Avenue O block between Bedford Avenue and East 26 Street. The proposed rezoning would **legalize** the medical offices at 2519 and 2523 Avenue O. Ambulatory diagnostic or treatment health care facilities are **not** permitted in our R2 zoned community.

The applicant, Dr. Soni, resides at 2517 Avenue O with his wife, who also is a physician. He originally applied for a zoning change from the existing R2 to R3-2 to legalize his Avenue O medical offices and to allow for future expansion. After three public hearings, he is now willing to have this block zoned **R3-1**, which would legalize his medical offices and, at the same time, restrict what he could do with the buildings at 2519 and 2523 Avenue O in terms of expansion, according to the city zoning laws.

The present medical facility occupies about 1424 square feet on the ground floor. The **R3-1** zoning classification **limits** ambulatory diagnostic and treatment health care facilities to 1500 square feet of floor area. In other words, the applicant could not expand his medical building more than 1500 square feet in a R3-1 zoned district. The applicant states that the second floor would be utilized for residential use.

I consider this a compromise worth considering. Our community has to make a decision as to whether to accept or reject the compromise. It is my opinion, based on decades of involvement in zoning disputes, that we should accept this compromise.

Here is some relevant **background** information:

Last November, Community Board 14 adopted a resolution to disapprove of changing the R2 zoning for the four buildings on the north side of the Avenue O block.

In December, the Brooklyn Borough President issued a recommendation disapproving the rezoning application "unless the proposed R3-2 district is modified to R3-1."

Last month the City Planning Commission voted to approve the applicant's request to change the R2 zoning to R3-2 for the Avenue O block between Bedford Avenue and East 26 Street.

At each of these public hearings for the three city agencies, I testified against the proposed zoning change.

The next step is for this zoning matter to be voted on by the City Council and I intend to attend the Council's public hearing on the proposed zoning change.

Several weeks ago, I received a phone call from the applicant's lawyer asking if I would meet with him to attempt to find a compromise. Because of a planned trip to Israel, we could not meet until Tuesday evening, February 4. This meeting was suggested by our City Council

member Chaim Deutsch. We met in the council member's Avenue U office. Fran and I represented our block during this 50-minute meeting. Mr. and Mrs. Soni (Dr. & Dr. Soni) were accompanied by their lawyer, a paralegal, and four of their friends. This was an informal and friendly get-together. The council member was not in attendance. At this meeting, Dr. Soni and his lawyer offered to change the zoning request from R3-2 to R3-1 as suggested by the Brooklyn Borough President's office.

What weakens the community opposition to changing the present R2 zoning on the Avenue O block is the location of a hospital across the street from the applicant's medical office. In its written report, the City Planning Commission stated the following: "The Commission believes that the continued use of the existing ambulatory diagnostic and treatment health care facility is appropriate at this location due to the surrounding context " [New York Community Hospital]. The Avenue O traffic congestion does not matter in this zoning controversy.

Our city council member could change the proposed zoning from R3-2 to R3-1 if authorized by the applicant. If the City Council approves the zoning change, Dr. Soni would be allowed to file at the Department of Buildings to legalize the space he is now utilizing, but he would be forbidden from enlarging it. He also would have to obtain from the Department of Buildings a Certificate of Occupancy for his medical facility, which he presently lacks.

If neighbors need additional information or would like to have a block meeting on this proposed rezoning, please let me know (718-338-6784.)

PUBLIC SAFETY AND SECURITY SITUATION

Getting away from zoning, I must now discuss what is presently going on in our city regarding public safety and security. Thanks to our p r o g r e s s i v e state and city public officials, crime in New York City has increased significantly since January 1, and arrests have decreased. The media has discussed the reasons--new laws that became effective January 1.

I make the following suggestion. Do not hesitate to call the 24-hour hotline of the **Flatbush Shomrim Safety Patrol (718-338-9797)** if you are a crime victim, see a crime in progress, or spot some suspicious activity. **Always call 911 first.**

The Flatbush Shomrim Safety Patrol consists of dedicated trained volunteers and often respond to a scene before the police. When I operated the Nottingham Association Civilian Car Patrol, I did not hesitate to call on the Flatbush Shomrim to back up our patrol.

Cordially,
Stephen L. Epstein, President
East 26 Street--Avenue O Block Assoc.
718-338-6784



COUNCIL OF PEOPLES ORGANIZATION

1081 Coney Island Ave. Brooklyn New York 11230.

Phone 718-434-3266 Fax 718-859-2266

www.copo.org

Ibrahim AB Olevic
President

Salamat Ali
Secretary

Ejaz Ahmed
Treasurer

Hussain Dharsi
Board Member

Mirsad Muminovic
Board Member

Advisory Members

Abdo Almasmary

Tahir Bhutta

Louis Cristello

Majid Dutt

Shakila Hamidi

Chaudhry Hashim

Mukhtar Hussain

Mushtaq Javed

Chris Johnson

Abdul Rub Khan

Hamid Khan

Nasrullah Khan

Katherine Khatari

Sakibeh Mustafa

Mian Quadry

Rab N. Qureshi

Hamim Shah

Mohammad Razvi
Chief Executive
Officer

RE: 2513-2523 Avenue O Rezoning (Block 7669 Lots 1, 2, 3, and 4)
2519-2523 Avenue O (Block 7679 Lots 1 and 2)
Brooklyn, New York (the "Development Site")

Date October 24, 2019

Dear Shawn Campbell,

On behalf of Council Of Peoples Organization Board, we support the application made by Pulmonary and Sleep Medical, PC, which seeks to rezone from an R2 zoning district to an R3-2 zoning district. This rezoning would facilitate the legalization of the existing community facility use, the Pulmonary and Sleep Medical Center, located at 2519-2523 Avenue O, Brooklyn, NY 11210. There are no enlargements planned for the site. The rezoning would allow for the conversion of the two semi-detached homes located at the site to be legally converted to a single mixed building with a ground floor and cellar medical facility with a single-family home on the second floor. I urge the community board to support the application and recommend that the city planning commission and city council approve the application.

Sincerely,

Mohammad Razvi

Mohammad Razvi
Chief Executive Officer

Letter in Support

To: Brooklyn Community Board 14

Re: 2513-2523 Avenue O Rezoning (Block 7679 Lots 1, 2, 3, & 4)
2519-2523 Avenue O (Block 7679 Lots 1 & 2)
Brooklyn, New York (the "Development Site")

I live/work at 2525 Kings Highway NY 11229 and submit this letter in support of the application made by Pulmonary and Sleep Medical, P.C., which seeks to rezone the Premises from an R2 zoning district to an R3-2 zoning district. This rezoning would facilitate the legalization of the existing community facility use, the Pulmonary and Sleep Medical Center, located at 2519-2523 Avenue O, Brooklyn, NY 11210. There are no enlargements planned for the Development Site. The rezoning would allow for the conversion of the two semi-detached homes located at the Development Site to be legally converted to a single mixed building with a ground floor and cellar medical facility with a single-family home on the second floor.

I understand what is being proposed and I believe that the proposal is consistent with the character of the surrounding neighborhood.

I urge the Community Board to support the application and recommend that the City Planning Commission and City Council approve the application.

MARCIA PEDRAN-VALENY
Signature

Name: MARCIA PEDRAN-VALENY

Letter in Support

To: Brooklyn Community Board 14

Re: 2513-2523 Avenue O Rezoning (Block 7679 Lots 1, 2, 3, & 4)
2519-2523 Avenue O (Block 7679 Lots 1 & 2)
Brooklyn, New York (the "Development Site")

I live/work at 2525 Kings Highway NY 11229 and submit this letter in support of the application made by Pulmonary and Sleep Medical, P.C., which seeks to rezone the Premises from an R2 zoning district to an R3-2 zoning district. This rezoning would facilitate the legalization of the existing community facility use, the Pulmonary and Sleep Medical Center, located at 2519-2523 Avenue O, Brooklyn, NY 11210. There are no enlargements planned for the Development Site. The rezoning would allow for the conversion of the two semi-detached homes located at the Development Site to be legally converted to a single mixed building with a ground floor and cellar medical facility with a single-family home on the second floor.

I understand what is being proposed and I believe that the proposal is consistent with the character of the surrounding neighborhood.

I urge the Community Board to support the application and recommend that the City Planning Commission and City Council approve the application.

Signature

Name: Aleksandra
Atayeva

Letter in Support

To: Brooklyn Community Board 14

**Re: 2513-2523 Avenue O Rezoning (Block 7679 Lots 1, 2, 3, & 4)
2519-2523 Avenue O (Block 7679 Lots 1 & 2)
Brooklyn, New York (the "Development Site")**

I live/work at 2525 Kings Highway NY 11229 and submit this letter in support of the application made by Pulmonary and Sleep Medical, P.C., which seeks to rezone the Premises from an R2 zoning district to an R3-2 zoning district. This rezoning would facilitate the legalization of the existing community facility use, the Pulmonary and Sleep Medical Center, located at 2519-2523 Avenue O, Brooklyn, NY 11210. There are no enlargements planned for the Development Site. The rezoning would allow for the conversion of the two semi-detached homes located at the Development Site to be legally converted to a single mixed building with a ground floor and cellar medical facility with a single-family home on the second floor.

I understand what is being proposed and I believe that the proposal is consistent with the character of the surrounding neighborhood.

I urge the Community Board to support the application and recommend that the City Planning Commission and City Council approve the application.

Signature

Name:

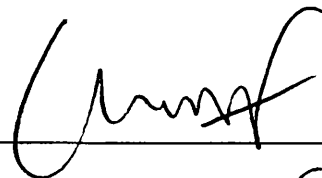

Letter in Support

To: Brooklyn Community Board 14

Re: 2513-2523 Avenue O Rezoning (Block 7679 Lots 1, 2, 3, & 4)
2519-2523 Avenue O (Block 7679 Lots 1 & 2)
Brooklyn, New York (the "Development Site")

I live/work at 2525 Kings Highway NY 11229 and submit this letter in support of the application made by Pulmonary and Sleep Medical, P.C., which seeks to rezone the Premises from an R2 zoning district to an R3-2 zoning district. This rezoning would facilitate the legalization of the existing community facility use, the Pulmonary and Sleep Medical Center, located at 2519-2523 Avenue O, Brooklyn, NY 11210. There are no enlargements planned for the Development Site. The rezoning would allow for the conversion of the two semi-detached homes located at the Development Site to be legally converted to a single mixed building with a ground floor and cellar medical facility with a single-family home on the second floor.

I understand what is being proposed and I believe that the proposal is consistent with the character of the surrounding neighborhood.

I urge the Community Board to support the application and recommend that the City Planning Commission and City Council approve the application.

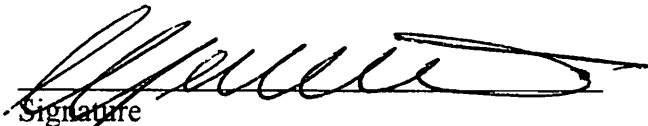
Signature

Name: CONSTANTINO GULUMTIRO M.D.

Letter in Support

To: Brooklyn Community Board 14

Re: 2513-2523 Avenue O Rezoning (Block 7679 Lots 1, 2, 3, & 4)
2519-2523 Avenue O (Block 7679 Lots 1 & 2)
Brooklyn, New York (the "Development Site")

I live/work at 2525 Kings Highway NY 11229 and submit this letter in support of the application made by Pulmonary and Sleep Medical, P.C., which seeks to rezone the Premises from an R2 zoning district to an R3-2 zoning district. This rezoning would facilitate the legalization of the existing community facility use, the Pulmonary and Sleep Medical Center, located at 2519-2523 Avenue O, Brooklyn, NY 11210. There are no enlargements planned for the Development Site. The rezoning would allow for the conversion of the two semi-detached homes located at the Development Site to be legally converted to a single mixed building with a ground floor and cellar medical facility with a single-family home on the second floor.

I understand what is being proposed and I believe that the proposal is consistent with the character of the surrounding neighborhood.

I urge the Community Board to support the application and recommend that the City Planning Commission and City Council approve the application.



Signature

Name:
Huzefa Sakernulla BPM

Letter in Support

To: Brooklyn Community Board 14

Re: 2513-2523 Avenue O Rezoning (Block 7679 Lots 1, 2, 3, & 4)
2519-2523 Avenue O (Block 7679 Lots 1 & 2)
Brooklyn, New York (the "Development Site")

I live/work at 2525 Kings Highway NY 11229 and submit this letter in support of the application made by Pulmonary and Sleep Medical, P.C., which seeks to rezone the Premises from an R2 zoning district to an R3-2 zoning district. This rezoning would facilitate the legalization of the existing community facility use, the Pulmonary and Sleep Medical Center, located at 2519-2523 Avenue O, Brooklyn, NY 11210. There are no enlargements planned for the Development Site. The rezoning would allow for the conversion of the two semi-detached homes located at the Development Site to be legally converted to a single mixed building with a ground floor and cellar medical facility with a single-family home on the second floor.

I understand what is being proposed and I believe that the proposal is consistent with the character of the surrounding neighborhood.

I urge the Community Board to support the application and recommend that the City Planning Commission and City Council approve the application.

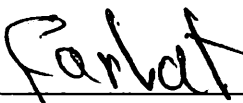

Signature
Name: Samira Farhat

Letter in Support

To: Brooklyn Community Board 14

Re: 2513-2523 Avenue O Rezoning (Block 7679 Lots 1, 2, 3, & 4)
2519-2523 Avenue O (Block 7679 Lots 1 & 2)
Brooklyn, New York (the "Development Site")

I live/work at 2525 Kings Highway NY 11228 and submit this letter in support of the application made by Pulmonary and Sleep Medical, P.C., which seeks to rezone the Premises from an R2 zoning district to an R3-2 zoning district. This rezoning would facilitate the legalization of the existing community facility use, the Pulmonary and Sleep Medical Center, located at 2519-2523 Avenue O, Brooklyn, NY 11210. There are no enlargements planned for the Development Site. The rezoning would allow for the conversion of the two semi-detached homes located at the Development Site to be legally converted to a single mixed building with a ground floor and cellar medical facility with a single-family home on the second floor.

I understand what is being proposed and I believe that the proposal is consistent with the character of the surrounding neighborhood.

I urge the Community Board to support the application and recommend that the City Planning Commission and City Council approve the application.

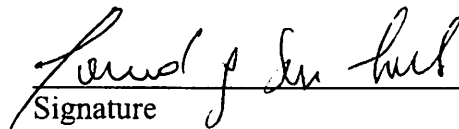
Signature

Name: F. G. Bou-Harb

Letter in Support

To: Brooklyn Community Board 14

Re: 2513-2523 Avenue O Rezoning (Block 7679 Lots 1, 2, 3, & 4)
2519-2523 Avenue O (Block 7679 Lots 1 & 2)
Brooklyn, New York (the "Development Site")

I live/work at 2525 Kings Highway NY 11224 and submit this letter in support of the application made by Pulmonary and Sleep Medical, P.C., which seeks to rezone the Premises from an R2 zoning district to an R3-2 zoning district. This rezoning would facilitate the legalization of the existing community facility use, the Pulmonary and Sleep Medical Center, located at 2519-2523 Avenue O, Brooklyn, NY 11210. There are no enlargements planned for the Development Site. The rezoning would allow for the conversion of the two semi-detached homes located at the Development Site to be legally converted to a single mixed building with a ground floor and cellar medical facility with a single-family home on the second floor.

I understand what is being proposed and I believe that the proposal is consistent with the character of the surrounding neighborhood.

I urge the Community Board to support the application and recommend that the City Planning Commission and City Council approve the application.



Signature
Name: PAULETTE SAM

Letter in Support

To: Brooklyn Community Board 14

Re: 2513-2523 Avenue O Rezoning (Block 7679 Lots 1, 2, 3, & 4)
2519-2523 Avenue O (Block 7679 Lots 1 & 2)
Brooklyn, New York (the "Development Site")

I live/work at 2525 Kings Highway NY 11228 and submit this letter in support of the application made by Pulmonary and Sleep Medical, P.C., which seeks to rezone the Premises from an R2 zoning district to an R3-2 zoning district. This rezoning would facilitate the legalization of the existing community facility use, the Pulmonary and Sleep Medical Center, located at 2519-2523 Avenue O, Brooklyn, NY 11210. There are no enlargements planned for the Development Site. The rezoning would allow for the conversion of the two semi-detached homes located at the Development Site to be legally converted to a single mixed building with a ground floor and cellar medical facility with a single-family home on the second floor.

I understand what is being proposed and I believe that the proposal is consistent with the character of the surrounding neighborhood.

I urge the Community Board to support the application and recommend that the City Planning Commission and City Council approve the application.

Ian Nangle
Signature

Name: IAN NANGLE

Letter in Support

To: Brooklyn Community Board 14

**Re: 2513-2523 Avenue O Rezoning (Block 7679 Lots 1, 2, 3, & 4)
2519-2523 Avenue O (Block 7679 Lots 1 & 2)
Brooklyn, New York (the "Development Site")**

I live/work at 2525 Kings Highway NY 11210 and submit this letter in support of the application made by Pulmonary and Sleep Medical, P.C., which seeks to rezone the Premises from an R2 zoning district to an R3-2 zoning district. This rezoning would facilitate the legalization of the existing community facility use, the Pulmonary and Sleep Medical Center, located at 2519-2523 Avenue O, Brooklyn, NY 11210. There are no enlargements planned for the Development Site. The rezoning would allow for the conversion of the two semi-detached homes located at the Development Site to be legally converted to a single mixed building with a ground floor and cellar medical facility with a single-family home on the second floor.

I understand what is being proposed and I believe that the proposal is consistent with the character of the surrounding neighborhood.

I urge the Community Board to support the application and recommend that the City Planning Commission and City Council approve the application.

S. Svetlana Karuyeva
Signature
Name: Svetlana Karuyeva

Letter in Support

To: Brooklyn Community Board 14

**Re: 2513-2523 Avenue O Rezoning (Block 7679 Lots 1, 2, 3, & 4)
2519-2523 Avenue O (Block 7679 Lots 1 & 2)
Brooklyn, New York (the "Development Site")**

I live/work at 2525 Kings Highway NY 11210 and submit this letter in support of the application made by Pulmonary and Sleep Medical, P.C., which seeks to rezone the Premises from an R2 zoning district to an R3-2 zoning district. This rezoning would facilitate the legalization of the existing community facility use, the Pulmonary and Sleep Medical Center, located at 2519-2523 Avenue O, Brooklyn, NY 11210. There are no enlargements planned for the Development Site. The rezoning would allow for the conversion of the two semi-detached homes located at the Development Site to be legally converted to a single mixed building with a ground floor and cellar medical facility with a single-family home on the second floor.

I understand what is being proposed and I believe that the proposal is consistent with the character of the surrounding neighborhood.

I urge the Community Board to support the application and recommend that the City Planning Commission and City Council approve the application.



Signature

Name: Raymond Casty

Letter in Support

To: Brooklyn Community Board 14

Re: 2513-2523 Avenue O Rezoning (Block 7679 Lots 1, 2, 3, & 4)
2519-2523 Avenue O (Block 7679 Lots 1 & 2)
Brooklyn, New York (the "Development Site")

I live/work at 2525 Kings Highway NY 11210 and submit this letter in support of the application made by Pulmonary and Sleep Medical, P.C., which seeks to rezone the Premises from an R2 zoning district to an R3-2 zoning district. This rezoning would facilitate the legalization of the existing community facility use, the Pulmonary and Sleep Medical Center, located at 2519-2523 Avenue O, Brooklyn, NY 11210. There are no enlargements planned for the Development Site. The rezoning would allow for the conversion of the two semi-detached homes located at the Development Site to be legally converted to a single mixed building with a ground floor and cellar medical facility with a single-family home on the second floor.

I understand what is being proposed and I believe that the proposal is consistent with the character of the surrounding neighborhood.

I urge the Community Board to support the application and recommend that the City Planning Commission and City Council approve the application.

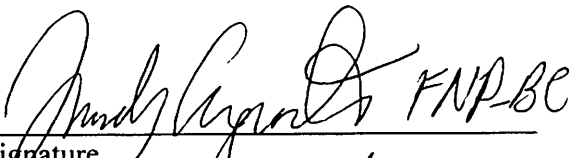
Signature _____ FNP-BC
Name: Judy Auguste

Letter in Support

To: Brooklyn Community Board 14

Re: 2513-2523 Avenue O Rezoning (Block 7679 Lots 1, 2, 3, & 4)
2519-2523 Avenue O (Block 7679 Lots 1 & 2)
Brooklyn, New York (the "Development Site")

I live/work at 2525 Kings Highway M 11210 and submit

this letter in support of the application made by Pulmonary and Sleep Medical, P.C., which seeks to rezone the Premises from an R2 zoning district to an R3-2 zoning district. This rezoning would facilitate the legalization of the existing community facility use, the Pulmonary and Sleep Medical Center, located at 2519-2523 Avenue O, Brooklyn, NY 11210. There are no enlargements planned for the Development Site. The rezoning would allow for the conversion of the two semi-detached homes located at the Development Site to be legally converted to a single mixed building with a ground floor and cellar medical facility with a single-family home on the second floor.

I understand what is being proposed and I believe that the proposal is consistent with the character of the surrounding neighborhood.

I urge the Community Board to support the application and recommend that the City Planning Commission and City Council approve the application.



Signature

Name:



Letter in Support

To: Brooklyn Community Board 14

**Re: 2513-2523 Avenue O Rezoning (Block 7679 Lots 1, 2, 3, & 4)
2519-2523 Avenue O (Block 7679 Lots 1 & 2)
Brooklyn, New York (the "Development Site")**

I live/work at 2525 Kingshyn NY 11210 and submit this letter in support of the application made by Pulmonary and Sleep Medical, P.C., which seeks to rezone the Premises from an R2 zoning district to an R3-2 zoning district. This rezoning would facilitate the legalization of the existing community facility use, the Pulmonary and Sleep Medical Center, located at 2519-2523 Avenue O, Brooklyn, NY 11210. There are no enlargements planned for the Development Site. The rezoning would allow for the conversion of the two semi-detached homes located at the Development Site to be legally converted to a single mixed building with a ground floor and cellar medical facility with a single-family home on the second floor.

I understand what is being proposed and I believe that the proposal is consistent with the character of the surrounding neighborhood.

I urge the Community Board to support the application and recommend that the City Planning Commission and City Council approve the application.

Signature

Name: K. GUSKALCZYKOS

Letter in Support

To: Brooklyn Community Board 14

Re: 2513-2523 Avenue O Rezoning (Block 7679 Lots 1, 2, 3, & 4)
2519-2523 Avenue O (Block 7679 Lots 1 & 2)
Brooklyn, New York (the "Development Site")

I live/work at 2825 Kings Highway NY 11210 and submit this letter in support of the application made by Pulmonary and Sleep Medical, P.C., which seeks to rezone the Premises from an R2 zoning district to an R3-2 zoning district. This rezoning would facilitate the legalization of the existing community facility use, the Pulmonary and Sleep Medical Center, located at 2519-2523 Avenue O, Brooklyn, NY 11210. There are no enlargements planned for the Development Site. The rezoning would allow for the conversion of the two semi-detached homes located at the Development Site to be legally converted to a single mixed building with a ground floor and cellar medical facility with a single-family home on the second floor.

I understand what is being proposed and I believe that the proposal is consistent with the character of the surrounding neighborhood.

I urge the Community Board to support the application and recommend that the City Planning Commission and City Council approve the application.

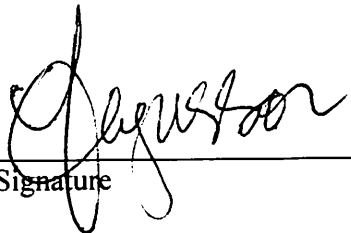

Signature

Name: L FER GUSSON

Letter in Support

To: Brooklyn Community Board 14

Re: 2513-2523 Avenue O Rezoning (Block 7679 Lots 1, 2, 3, & 4)
2519-2523 Avenue O (Block 7679 Lots 1 & 2)
Brooklyn, New York (the "Development Site")

I live/work at 2525 Kings Highway N¹¹²¹⁰ and submit this letter in support of the application made by Pulmonary and Sleep Medical, P.C., which seeks to rezone the Premises from an R2 zoning district to an R3-2 zoning district. This rezoning would facilitate the legalization of the existing community facility use, the Pulmonary and Sleep Medical Center, located at 2519-2523 Avenue O, Brooklyn, NY 11210. There are no enlargements planned for the Development Site. The rezoning would allow for the conversion of the two semi-detached homes located at the Development Site to be legally converted to a single mixed building with a ground floor and cellar medical facility with a single-family home on the second floor.

I understand what is being proposed and I believe that the proposal is consistent with the character of the surrounding neighborhood.

I urge the Community Board to support the application and recommend that the City Planning Commission and City Council approve the application.

Cl. Langusne
Signature

Name: Clara Langusne

Letter in Support

To: Brooklyn Community Board 14

Re: 2513-2523 Avenue O Rezoning (Block 7679 Lots 1, 2, 3, & 4)
2519-2523 Avenue O (Block 7679 Lots 1 & 2)
Brooklyn, New York (the "Development Site")

I live/work at 2528 Kings Highway NY 11210 and submit this letter in support of the application made by Pulmonary and Sleep Medical, P.C., which seeks to rezone the Premises from an R2 zoning district to an R3-2 zoning district. This rezoning would facilitate the legalization of the existing community facility use, the Pulmonary and Sleep Medical Center, located at 2519-2523 Avenue O, Brooklyn, NY 11210. There are no enlargements planned for the Development Site. The rezoning would allow for the conversion of the two semi-detached homes located at the Development Site to be legally converted to a single mixed building with a ground floor and cellar medical facility with a single-family home on the second floor.

I understand what is being proposed and I believe that the proposal is consistent with the character of the surrounding neighborhood.

I urge the Community Board to support the application and recommend that the City Planning Commission and City Council approve the application.

C. Blake
Signature

Name: Claudette Blake

Letter in Support

To: Brooklyn Community Board 14

**Re: 2513-2523 Avenue O Rezoning (Block 7679 Lots 1, 2, 3, & 4)
2519-2523 Avenue O (Block 7679 Lots 1 & 2)
Brooklyn, New York (the "Development Site")**

I live/work at 2525 Kensington NY 11210 and submit this letter in support of the application made by Pulmonary and Sleep Medical, P.C., which seeks to rezone the Premises from an R2 zoning district to an R3-2 zoning district. This rezoning would facilitate the legalization of the existing community facility use, the Pulmonary and Sleep Medical Center, located at 2519-2523 Avenue O, Brooklyn, NY 11210. There are no enlargements planned for the Development Site. The rezoning would allow for the conversion of the two semi-detached homes located at the Development Site to be legally converted to a single mixed building with a ground floor and cellar medical facility with a single-family home on the second floor.

I understand what is being proposed and I believe that the proposal is consistent with the character of the surrounding neighborhood.

I urge the Community Board to support the application and recommend that the City Planning Commission and City Council approve the application.

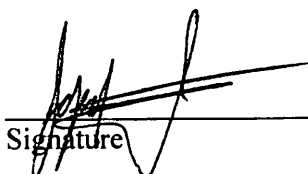
Signature

Name: Jazell Jones

Letter in Support

To: Brooklyn Community Board 14

Re: 2513-2523 Avenue O Rezoning (Block 7679 Lots 1, 2, 3, & 4)
2519-2523 Avenue O (Block 7679 Lots 1 & 2)
Brooklyn, New York (the "Development Site")

I live/work at 2525 Kensington NY 11210 and submit this letter in support of the application made by Pulmonary and Sleep Medical, P.C., which seeks to rezone the Premises from an R2 zoning district to an R3-2 zoning district. This rezoning would facilitate the legalization of the existing community facility use, the Pulmonary and Sleep Medical Center, located at 2519-2523 Avenue O, Brooklyn, NY 11210. There are no enlargements planned for the Development Site. The rezoning would allow for the conversion of the two semi-detached homes located at the Development Site to be legally converted to a single mixed building with a ground floor and cellar medical facility with a single-family home on the second floor.

I understand what is being proposed and I believe that the proposal is consistent with the character of the surrounding neighborhood.

I urge the Community Board to support the application and recommend that the City Planning Commission and City Council approve the application.

Signature

Name: ISHIA AVRAHAM, MD

Letter in Support

To: Brooklyn Community Board 14

Re: 2513-2523 Avenue O Rezoning (Block 7679 Lots 1, 2, 3, & 4)
2519-2523 Avenue O (Block 7679 Lots 1 & 2)
Brooklyn, New York (the "Development Site")

I live/work at 2525 Kings Highway NY 11210 and submit this letter in support of the application made by Pulmonary and Sleep Medical, P.C., which seeks to rezone the Premises from an R2 zoning district to an R3-2 zoning district. This rezoning would facilitate the legalization of the existing community facility use, the Pulmonary and Sleep Medical Center, located at 2519-2523 Avenue O, Brooklyn, NY 11210. There are no enlargements planned for the Development Site. The rezoning would allow for the conversion of the two semi-detached homes located at the Development Site to be legally converted to a single mixed building with a ground floor and cellar medical facility with a single-family home on the second floor.

I understand what is being proposed and I believe that the proposal is consistent with the character of the surrounding neighborhood.

I urge the Community Board to support the application and recommend that the City Planning Commission and City Council approve the application.

Signature

Name: AILEEN SAMICCANO

Letter in Support

To: Brooklyn Community Board 14

Re: 2513-2523 Avenue O Rezoning (Block 7679 Lots 1, 2, 3, & 4)
2519-2523 Avenue O (Block 7679 Lots 1 & 2)
Brooklyn, New York (the "Development Site")

I live/work at 2525 Kuyahyn NY 11210 and submit this letter in support of the application made by Pulmonary and Sleep Medical, P.C., which seeks to rezone the Premises from an R2 zoning district to an R3-2 zoning district. This rezoning would facilitate the legalization of the existing community facility use, the Pulmonary and Sleep Medical Center, located at 2519-2523 Avenue O, Brooklyn, NY 11210. There are no enlargements planned for the Development Site. The rezoning would allow for the conversion of the two semi-detached homes located at the Development Site to be legally converted to a single mixed building with a ground floor and cellar medical facility with a single-family home on the second floor.

I understand what is being proposed and I believe that the proposal is consistent with the character of the surrounding neighborhood.

I urge the Community Board to support the application and recommend that the City Planning Commission and City Council approve the application.

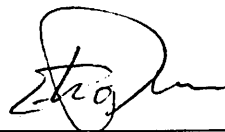

Signature

Name: Ngatham, Eric

Letter in Support

To: Brooklyn Community Board 14

Re: 2513-2523 Avenue O Rezoning (Block 7679 Lots 1, 2, 3, & 4)
2519-2523 Avenue O (Block 7679 Lots 1 & 2)
Brooklyn, New York (the "Development Site")

I live/work at 2525 Kuylenburg NY 11210 and submit this letter in support of the application made by Pulmonary and Sleep Medical, P.C., which seeks to rezone the Premises from an R2 zoning district to an R3-2 zoning district. This rezoning would facilitate the legalization of the existing community facility use, the Pulmonary and Sleep Medical Center, located at 2519-2523 Avenue O, Brooklyn, NY 11210. There are no enlargements planned for the Development Site. The rezoning would allow for the conversion of the two semi-detached homes located at the Development Site to be legally converted to a single mixed building with a ground floor and cellar medical facility with a single-family home on the second floor.

I understand what is being proposed and I believe that the proposal is consistent with the character of the surrounding neighborhood.

I urge the Community Board to support the application and recommend that the City Planning Commission and City Council approve the application.

Signature

Name: Wilfredo Mercado

Letter in Support

To: Brooklyn Community Board 14

Re: 2513-2523 Avenue O Rezoning (Block 7679 Lots 1, 2, 3, & 4)
2519-2523 Avenue O (Block 7679 Lots 1 & 2)
Brooklyn, New York (the "Development Site")

I live/work at NY COMMUNITY HOSPITAL and submit this letter in support of the application made by Pulmonary and Sleep Medical, P.C., which seeks to rezone the Premises from an R2 zoning district to an R3-2 zoning district. This rezoning would facilitate the legalization of the existing community facility use, the Pulmonary and Sleep Medical Center, located at 2519-2523 Avenue O, Brooklyn, NY 11210. There are no enlargements planned for the Development Site. The rezoning would allow for the conversion of the two semi-detached homes located at the Development Site to be legally converted to a single mixed building with a ground floor and cellar medical facility with a single-family home on the second floor.

I understand what is being proposed and I believe that the proposal is consistent with the character of the surrounding neighborhood.

I urge the Community Board to support the application and recommend that the City Planning Commission and City Council approve the application.

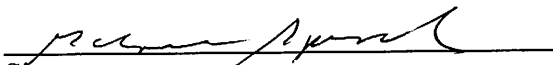
Signature

Name: GABRIEL SPENDEL, MD

Letter in Support

To: Brooklyn Community Board 14

Re: 2513-2523 Avenue O Rezoning (Block 7679 Lots 1, 2, 3, & 4)
2519-2523 Avenue O (Block 7679 Lots 1 & 2)
Brooklyn, New York (the "Development Site")

I live/work at 2525 Kings Highway NY 11210 and submit this letter in support of the application made by Pulmonary and Sleep Medical, P.C., which seeks to rezone the Premises from an R2 zoning district to an R3-2 zoning district. This rezoning would facilitate the legalization of the existing community facility use, the Pulmonary and Sleep Medical Center, located at 2519-2523 Avenue O, Brooklyn, NY 11210. There are no enlargements planned for the Development Site. The rezoning would allow for the conversion of the two semi-detached homes located at the Development Site to be legally converted to a single mixed building with a ground floor and cellar medical facility with a single-family home on the second floor.

I understand what is being proposed and I believe that the proposal is consistent with the character of the surrounding neighborhood.

I urge the Community Board to support the application and recommend that the City Planning Commission and City Council approve the application.

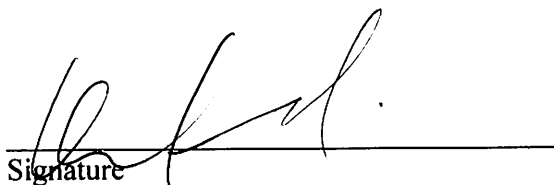
Signature

Name: Cuamdra Hyeckle

Letter in Support

To: Brooklyn Community Board 14

Re: 2513-2523 Avenue O Rezoning (Block 7679 Lots 1, 2, 3, & 4)
2519-2523 Avenue O (Block 7679 Lots 1 & 2)
Brooklyn, New York (the "Development Site")

I live/work at 2792 Ocean Ave, Unit 5 Bx. 24. and submit this letter in support of the application made by Pulmonary and Sleep Medical, P.C., which seeks to rezone the Premises from an R2 zoning district to an R3-2 zoning district. This rezoning would facilitate the legalization of the existing community facility use, the Pulmonary and Sleep Medical Center, located at 2519-2523 Avenue O, Brooklyn, NY 11210. There are no enlargements planned for the Development Site. The rezoning would allow for the conversion of the two semi-detached homes located at the Development Site to be legally converted to a single mixed building with a ground floor and cellar medical facility with a single-family home on the second floor.

I understand what is being proposed and I believe that the proposal is consistent with the character of the surrounding neighborhood.

I urge the Community Board to support the application and recommend that the City Planning Commission and City Council approve the application.

P. Telgatnikov
Signature

Name: Pavel. Telgatnikov

Letter in Support

To: Brooklyn Community Board 14

Re: 2513-2523 Avenue O Rezoning (Block 7679 Lots 1, 2, 3, & 4)
2519-2523 Avenue O (Block 7679 Lots 1 & 2)
Brooklyn, New York (the "Development Site")

I live/work at 3619 Bedford Ave 5c Brk, NY 11210 and submit this letter in support of the application made by Pulmonary and Sleep Medical, P.C., which seeks to rezone the Premises from an R2 zoning district to an R3-2 zoning district. This rezoning would facilitate the legalization of the existing community facility use, the Pulmonary and Sleep Medical Center, located at 2519-2523 Avenue O, Brooklyn, NY 11210. There are no enlargements planned for the Development Site. The rezoning would allow for the conversion of the two semi-detached homes located at the Development Site to be legally converted to a single mixed building with a ground floor and cellar medical facility with a single-family home on the second floor.

I understand what is being proposed and I believe that the proposal is consistent with the character of the surrounding neighborhood.

I urge the Community Board to support the application and recommend that the City Planning Commission and City Council approve the application.



Signature

Name:

Letter in Support

To: Brooklyn Community Board 14

Re: 2513-2523 Avenue O Rezoning (Block 7679 Lots 1, 2, 3, & 4)
2519-2523 Avenue O (Block 7679 Lots 1 & 2)
Brooklyn, New York (the "Development Site")

I live/work at 2114 Brown St Brooklyn NY 11229 and submit this letter in support of the application made by Pulmonary and Sleep Medical, P.C., which seeks to rezone the Premises from an R2 zoning district to an R3-2 zoning district. This rezoning would facilitate the legalization of the existing community facility use, the Pulmonary and Sleep Medical Center, located at 2519-2523 Avenue O, Brooklyn, NY 11210. There are no enlargements planned for the Development Site. The rezoning would allow for the conversion of the two semi-detached homes located at the Development Site to be legally converted to a single mixed building with a ground floor and cellar medical facility with a single-family home on the second floor.

I understand what is being proposed and I believe that the proposal is consistent with the character of the surrounding neighborhood.

I urge the Community Board to support the application and recommend that the City Planning Commission and City Council approve the application.

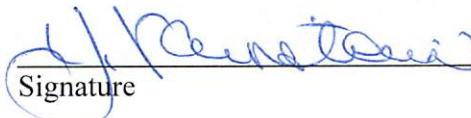
Signature

Name: Yana Vainstein

Letter in Support

To: Brooklyn Community Board 14

Re: 2513-2523 Avenue O Rezoning (Block 7679 Lots 1, 2, 3, & 4)
2519-2523 Avenue O (Block 7679 Lots 1 & 2)
Brooklyn, New York (the "Development Site")

I live/work at 2114 Brown str, Brooklyn 11238 and submit this letter in support of the application made by Pulmonary and Sleep Medical, P.C., which seeks to rezone the Premises from an R2 zoning district to an R3-2 zoning district. This rezoning would facilitate the legalization of the existing community facility use, the Pulmonary and Sleep Medical Center, located at 2519-2523 Avenue O, Brooklyn, NY 11210. There are no enlargements planned for the Development Site. The rezoning would allow for the conversion of the two semi-detached homes located at the Development Site to be legally converted to a single mixed building with a ground floor and cellar medical facility with a single-family home on the second floor.

I understand what is being proposed and I believe that the proposal is consistent with the character of the surrounding neighborhood.

I urge the Community Board to support the application and recommend that the City Planning Commission and City Council approve the application.



Signature

Name: Vinera Narova

Letter in Support

To: Brooklyn Community Board 14

Re: 2513-2523 Avenue O Rezoning (Block 7679 Lots 1, 2, 3, & 4)
2519-2523 Avenue O (Block 7679 Lots 1 & 2)
Brooklyn, New York (the "Development Site")

I live/work at 2013 8th Street Apt Brooklyn NY 11214 and submit

this letter in support of the application made by Pulmonary and Sleep Medical, P.C., which seeks to rezone the Premises from an R2 zoning district to an R3-2 zoning district. This rezoning would facilitate the legalization of the existing community facility use, the Pulmonary and Sleep Medical Center, located at 2519-2523 Avenue O, Brooklyn, NY 11210. There are no enlargements planned for the Development Site. The rezoning would allow for the conversion of the two semi-detached homes located at the Development Site to be legally converted to a single mixed building with a ground floor and cellar medical facility with a single-family home on the second floor.

I understand what is being proposed and I believe that the proposal is consistent with the character of the surrounding neighborhood.

I urge the Community Board to support the application and recommend that the City Planning Commission and City Council approve the application.



Signature

Name: Nadzeya Khiazine

Letter in Support

To: **Brooklyn Community Board 14**

Re: **2513-2523 Avenue O Rezoning (Block 7679 Lots 1, 2, 3, & 4)**
2519-2523 Avenue O (Block 7679 Lots 1 & 2)
Brooklyn, New York (the "Development Site")

I live/work at 2532 E 27st Brooklyn, NY 11235 and submit this letter in support of the application made by Pulmonary and Sleep Medical, P.C., which seeks to rezone the Premises from an R2 zoning district to an R3-2 zoning district. This rezoning would facilitate the legalization of the existing community facility use, the Pulmonary and Sleep Medical Center, located at 2519-2523 Avenue O, Brooklyn, NY 11210. There are no enlargements planned for the Development Site. The rezoning would allow for the conversion of the two semi-detached homes located at the Development Site to be legally converted to a single mixed building with a ground floor and cellar medical facility with a single-family home on the second floor.

I understand what is being proposed and I believe that the proposal is consistent with the character of the surrounding neighborhood.

I urge the Community Board to support the application and recommend that the City Planning Commission and City Council approve the application.

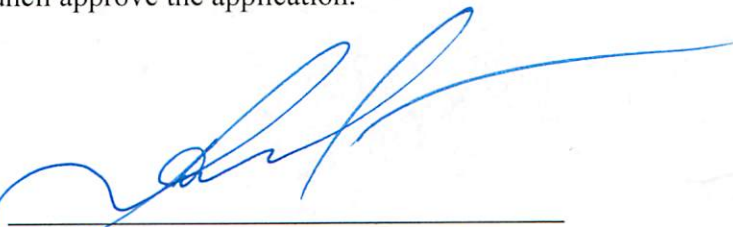

Signature

Name: Irina Dizik

Letter in Support

To: Brooklyn Community Board 14

Re: 2513-2523 Avenue O Rezoning (Block 7679 Lots 1, 2, 3, & 4)
2519-2523 Avenue O (Block 7679 Lots 1 & 2)
Brooklyn, New York (the "Development Site")

I live/work at 2901 Ave J Apt E1 Brooklyn NY 11210 and submit this letter in support of the application made by Pulmonary and Sleep Medical, P.C., which seeks to rezone the Premises from an R2 zoning district to an R3-2 zoning district. This rezoning would facilitate the legalization of the existing community facility use, the Pulmonary and Sleep Medical Center, located at 2519-2523 Avenue O, Brooklyn, NY 11210. There are no enlargements planned for the Development Site. The rezoning would allow for the conversion of the two semi-detached homes located at the Development Site to be legally converted to a single mixed building with a ground floor and cellar medical facility with a single-family home on the second floor.

I understand what is being proposed and I believe that the proposal is consistent with the character of the surrounding neighborhood.

I urge the Community Board to support the application and recommend that the City Planning Commission and City Council approve the application.



Signature

Name: Nelya Yarovaya

Letter in Support

To: Brooklyn Community Board 14

Re: 2513-2523 Avenue O Rezoning (Block 7679 Lots 1, 2, 3, & 4)
2519-2523 Avenue O (Block 7679 Lots 1 & 2)
Brooklyn, New York (the "Development Site")

I live/work at 3619 Bedford AVE B-C and submit this letter in support of the application made by Pulmonary and Sleep Medical, P.C., which seeks to rezone the Premises from an R2 zoning district to an R3-2 zoning district. This rezoning would facilitate the legalization of the existing community facility use, the Pulmonary and Sleep Medical Center, located at 2519-2523 Avenue O, Brooklyn, NY 11210. There are no enlargements planned for the Development Site. The rezoning would allow for the conversion of the two semi-detached homes located at the Development Site to be legally converted to a single mixed building with a ground floor and cellar medical facility with a single-family home on the second floor.

I understand what is being proposed and I believe that the proposal is consistent with the character of the surrounding neighborhood.

I urge the Community Board to support the application and recommend that the City Planning Commission and City Council approve the application.



Signature

Name: Leyla Bagirova

Letter in Support

To: Brooklyn Community Board 14

Re: 2513-2523 Avenue O Rezoning (Block 7679 Lots 1, 2, 3, & 4)
2519-2523 Avenue O (Block 7679 Lots 1 & 2)
Brooklyn, New York (the "Development Site")

I live/work at 2952 Brighton 3rd St and submit this letter in support of the application made by Pulmonary and Sleep Medical, P.C., which seeks to rezone the Premises from an R2 zoning district to an R3-2 zoning district. This rezoning would facilitate the legalization of the existing community facility use, the Pulmonary and Sleep Medical Center, located at 2519-2523 Avenue O, Brooklyn, NY 11210. There are no enlargements planned for the Development Site. The rezoning would allow for the conversion of the two semi-detached homes located at the Development Site to be legally converted to a single mixed building with a ground floor and cellar medical facility with a single-family home on the second floor.

I understand what is being proposed and I believe that the proposal is consistent with the character of the surrounding neighborhood.

I urge the Community Board to support the application and recommend that the City Planning Commission and City Council approve the application.

Paula Baum

Signature

Name:

Letter in Support

To: Brooklyn Community Board 14

Re: 2513-2523 Avenue O Rezoning (Block 7679 Lots 1, 2, 3, & 4)
2519-2523 Avenue O (Block 7679 Lots 1 & 2)
Brooklyn, New York (the "Development Site")

I live/work at 2952 Brighton 3rd St and submit this letter in support of the application made by Pulmonary and Sleep Medical, P.C., which seeks to rezone the Premises from an R2 zoning district to an R3-2 zoning district. This rezoning would facilitate the legalization of the existing community facility use, the Pulmonary and Sleep Medical Center, located at 2519-2523 Avenue O, Brooklyn, NY 11210. There are no enlargements planned for the Development Site. The rezoning would allow for the conversion of the two semi-detached homes located at the Development Site to be legally converted to a single mixed building with a ground floor and cellar medical facility with a single-family home on the second floor.

I understand what is being proposed and I believe that the proposal is consistent with the character of the surrounding neighborhood.

I urge the Community Board to support the application and recommend that the City Planning Commission and City Council approve the application.

Gaina Sviridovskaya
Signature

Name:

Letter in Support

To: Brooklyn Community Board 14

Re: 2513-2523 Avenue O Rezoning (Block 7679 Lots 1, 2, 3, & 4)
2519-2523 Avenue O (Block 7679 Lots 1 & 2)
Brooklyn, New York (the "Development Site")

I live/work at 3619 Bedford Ave Apt 6c Brooklyn and submit this letter in support of the application made by Pulmonary and Sleep Medical, P.C., which seeks to rezone the Premises from an R2 zoning district to an R3-2 zoning district. This rezoning would facilitate the legalization of the existing community facility use, the Pulmonary and Sleep Medical Center, located at 2519-2523 Avenue O, Brooklyn, NY 11210. There are no enlargements planned for the Development Site. The rezoning would allow for the conversion of the two semi-detached homes located at the Development Site to be legally converted to a single mixed building with a ground floor and cellar medical facility with a single-family home on the second floor.

I understand what is being proposed and I believe that the proposal is consistent with the character of the surrounding neighborhood.

I urge the Community Board to support the application and recommend that the City Planning Commission and City Council approve the application.



Signature

Name: *Tamila Gadaeva*

Letter in Support

To: Brooklyn Community Board 14

Re: 2513-2523 Avenue O Rezoning (Block 7679 Lots 1, 2, 3, & 4)
2519-2523 Avenue O (Block 7679 Lots 1 & 2)
Brooklyn, New York (the "Development Site")

I live/work at 2952 Brighton 3rd Street and submit this letter in support of the application made by Pulmonary and Sleep Medical, P.C., which seeks to rezone the Premises from an R2 zoning district to an R3-2 zoning district. This rezoning would facilitate the legalization of the existing community facility use, the Pulmonary and Sleep Medical Center, located at 2519-2523 Avenue O, Brooklyn, NY 11210. There are no enlargements planned for the Development Site. The rezoning would allow for the conversion of the two semi-detached homes located at the Development Site to be legally converted to a single mixed building with a ground floor and cellar medical facility with a single-family home on the second floor.

I understand what is being proposed and I believe that the proposal is consistent with the character of the surrounding neighborhood.

I urge the Community Board to support the application and recommend that the City Planning Commission and City Council approve the application.

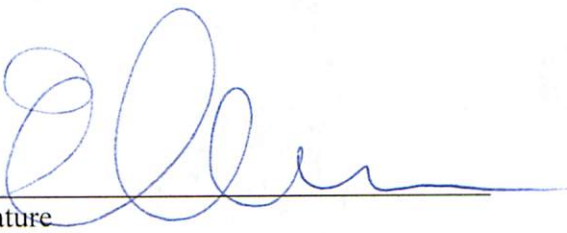
Signature

Name: Elina Avshalom

Letter in Support

To: Brooklyn Community Board 14

Re: 2513-2523 Avenue O Rezoning (Block 7679 Lots 1, 2, 3, & 4)
2519-2523 Avenue O (Block 7679 Lots 1 & 2)
Brooklyn, New York (the "Development Site")

I live/work at 2952 Brighton St Bk, NY 11235 and submit this letter in support of the application made by Pulmonary and Sleep Medical, P.C., which seeks to rezone the Premises from an R2 zoning district to an R3-2 zoning district. This rezoning would facilitate the legalization of the existing community facility use, the Pulmonary and Sleep Medical Center, located at 2519-2523 Avenue O, Brooklyn, NY 11210. There are no enlargements planned for the Development Site. The rezoning would allow for the conversion of the two semi-detached homes located at the Development Site to be legally converted to a single mixed building with a ground floor and cellar medical facility with a single-family home on the second floor.

I understand what is being proposed and I believe that the proposal is consistent with the character of the surrounding neighborhood.

I urge the Community Board to support the application and recommend that the City Planning Commission and City Council approve the application.

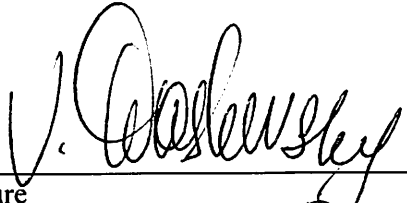

Signature

Name: Victoria Waskevsky

Letter in Support

To: Brooklyn Community Board 14

Re: 2513-2523 Avenue O Rezoning (Block 7679 Lots 1, 2, 3, & 4)
2519-2523 Avenue O (Block 7679 Lots 1 & 2)
Brooklyn, New York (the "Development Site")

I live/work at _____ and submit this letter in support of the application made by Pulmonary and Sleep Medical, P.C., which seeks to rezone the Premises from an R2 zoning district to an R3-2 zoning district. This rezoning would facilitate the legalization of the existing community facility use, the Pulmonary and Sleep Medical Center, located at 2519-2523 Avenue O, Brooklyn, NY 11210. There are no enlargements planned for the Development Site. The rezoning would allow for the conversion of the two semi-detached homes located at the Development Site to be legally converted to a single mixed building with a ground floor and cellar medical facility with a single-family home on the second floor.

I understand what is being proposed and I believe that the proposal is consistent with the character of the surrounding neighborhood.

I urge the Community Board to support the application and recommend that the City Planning Commission and City Council approve the application.

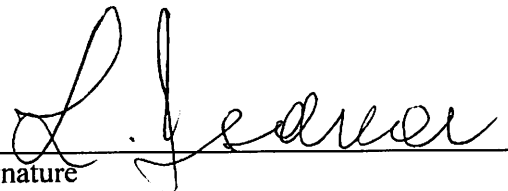
Signature

Name:
Leonid Isakov, MD
2792 Ocean Ave
Brooklyn NY 11229

Letter in Support

To: Brooklyn Community Board 14

Re: 2513-2523 Avenue O Rezoning (Block 7679 Lots 1, 2, 3, & 4)
2519-2523 Avenue O (Block 7679 Lots 1 & 2)
Brooklyn, New York (the "Development Site")

I live/work at 2792 Ocean Ave 3rd Fl and submit this letter in support of the application made by Pulmonary and Sleep Medical, P.C., which seeks to rezone the Premises from an R2 zoning district to an R3-2 zoning district. This rezoning would facilitate the legalization of the existing community facility use, the Pulmonary and Sleep Medical Center, located at 2519-2523 Avenue O, Brooklyn, NY 11210. There are no enlargements planned for the Development Site. The rezoning would allow for the conversion of the two semi-detached homes located at the Development Site to be legally converted to a single mixed building with a ground floor and cellar medical facility with a single-family home on the second floor.

I understand what is being proposed and I believe that the proposal is consistent with the character of the surrounding neighborhood.

I urge the Community Board to support the application and recommend that the City Planning Commission and City Council approve the application.

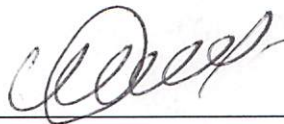

Signature

Name: Mokryk Olena

Letter in Support

To: Brooklyn Community Board 14

Re: 2513-2523 Avenue O Rezoning (Block 7679 Lots 1, 2, 3, & 4)
2519-2523 Avenue O (Block 7679 Lots 1 & 2)
Brooklyn, New York (the "Development Site")

I live/work at 2792 Ocean Ave and submit this letter in support of the application made by Pulmonary and Sleep Medical, P.C., which seeks to rezone the Premises from an R2 zoning district to an R3-2 zoning district. This rezoning would facilitate the legalization of the existing community facility use, the Pulmonary and Sleep Medical Center, located at 2519-2523 Avenue O, Brooklyn, NY 11210. There are no enlargements planned for the Development Site. The rezoning would allow for the conversion of the two semi-detached homes located at the Development Site to be legally converted to a single mixed building with a ground floor and cellar medical facility with a single-family home on the second floor.

I understand what is being proposed and I believe that the proposal is consistent with the character of the surrounding neighborhood.

I urge the Community Board to support the application and recommend that the City Planning Commission and City Council approve the application.

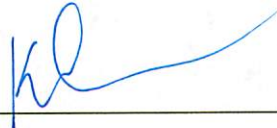

Signature

Name: Marina K.

Letter in Support

To: Brooklyn Community Board 14

Re: 2513-2523 Avenue O Rezoning (Block 7679 Lots 1, 2, 3, & 4)
2519-2523 Avenue O (Block 7679 Lots 1 & 2)
Brooklyn, New York (the "Development Site")

I live/work at 2792 Ocean Avenue and submit this letter in support of the application made by Pulmonary and Sleep Medical, P.C., which seeks to rezone the Premises from an R2 zoning district to an R3-2 zoning district. This rezoning would facilitate the legalization of the existing community facility use, the Pulmonary and Sleep Medical Center, located at 2519-2523 Avenue O, Brooklyn, NY 11210. There are no enlargements planned for the Development Site. The rezoning would allow for the conversion of the two semi-detached homes located at the Development Site to be legally converted to a single mixed building with a ground floor and cellar medical facility with a single-family home on the second floor.

I understand what is being proposed and I believe that the proposal is consistent with the character of the surrounding neighborhood.

I urge the Community Board to support the application and recommend that the City Planning Commission and City Council approve the application.

Signature

Name:

Nodira R

Letter in Support

To: Brooklyn Community Board 14

Re: 2513-2523 Avenue O Rezoning (Block 7679 Lots 1, 2, 3, & 4)
2519-2523 Avenue O (Block 7679 Lots 1 & 2)
Brooklyn, New York (the "Development Site")

I live/work at 2114 Brown St and submit this letter in support of the application made by Pulmonary and Sleep Medical, P.C., which seeks to rezone the Premises from an R2 zoning district to an R3-2 zoning district. This rezoning would facilitate the legalization of the existing community facility use, the Pulmonary and Sleep Medical Center, located at 2519-2523 Avenue O, Brooklyn, NY 11210. There are no enlargements planned for the Development Site. The rezoning would allow for the conversion of the two semi-detached homes located at the Development Site to be legally converted to a single mixed building with a ground floor and cellar medical facility with a single-family home on the second floor.

I understand what is being proposed and I believe that the proposal is consistent with the character of the surrounding neighborhood.

I urge the Community Board to support the application and recommend that the City Planning Commission and City Council approve the application.



Signature

Name: Farangiz M

Letter in Support

To: Brooklyn Community Board 14

Re: 2513-2523 Avenue O Rezoning (Block 7679 Lots 1, 2, 3, & 4)
2519-2523 Avenue O (Block 7679 Lots 1 & 2)
Brooklyn, New York (the "Development Site")

I live/work at 50 Noel Ave, Brooklyn NY and submit this letter in support of the application made by Pulmonary and Sleep Medical, P.C., which seeks to rezone the Premises from an R2 zoning district to an R3-2 zoning district. This rezoning would facilitate the legalization of the existing community facility use, the Pulmonary and Sleep Medical Center, located at 2519-2523 Avenue O, Brooklyn, NY 11210. There are no enlargements planned for the Development Site. The rezoning would allow for the conversion of the two semi-detached homes located at the Development Site to be legally converted to a single mixed building with a ground floor and cellar medical facility with a single-family home on the second floor.

I understand what is being proposed and I believe that the proposal is consistent with the character of the surrounding neighborhood.

I urge the Community Board to support the application and recommend that the City Planning Commission and City Council approve the application.



Signature

Name: Inga Guer

Letter in Support

To: Brooklyn Community Board 14

Re: 2513-2523 Avenue O Rezoning (Block 7679 Lots 1, 2, 3, & 4)
2519-2523 Avenue O (Block 7679 Lots 1 & 2)
Brooklyn, New York (the "Development Site")

I live/work at 3620 Bedford Ave, B2 and submit this letter in support of the application made by Pulmonary and Sleep Medical, P.C., which seeks to rezone the Premises from an R2 zoning district to an R3-2 zoning district. This rezoning would facilitate the legalization of the existing community facility use, the Pulmonary and Sleep Medical Center, located at 2519-2523 Avenue O, Brooklyn, NY 11210. There are no enlargements planned for the Development Site. The rezoning would allow for the conversion of the two semi-detached homes located at the Development Site to be legally converted to a single mixed building with a ground floor and cellar medical facility with a single-family home on the second floor.

I understand what is being proposed and I believe that the proposal is consistent with the character of the surrounding neighborhood.

I urge the Community Board to support the application and recommend that the City Planning Commission and City Council approve the application.



Signature

Name:

Tatyana Belkayg

Letter in Support

To: Brooklyn Community Board 14

Re: 2513-2523 Avenue O Rezoning (Block 7679 Lots 1, 2, 3, & 4)
2519-2523 Avenue O (Block 7679 Lots 1 & 2)
Brooklyn, New York (the "Development Site")

I live/work at 1487 E 37th St. BKlyn NY 11234 and submit this letter in support of the application made by Pulmonary and Sleep Medical, P.C., which seeks to rezone the Premises from an R2 zoning district to an R3-2 zoning district. This rezoning would facilitate the legalization of the existing community facility use, the Pulmonary and Sleep Medical Center, located at 2519-2523 Avenue O, Brooklyn, NY 11210. There are no enlargements planned for the Development Site. The rezoning would allow for the conversion of the two semi-detached homes located at the Development Site to be legally converted to a single mixed building with a ground floor and cellar medical facility with a single-family home on the second floor.

I understand what is being proposed and I believe that the proposal is consistent with the character of the surrounding neighborhood.

I urge the Community Board to support the application and recommend that the City Planning Commission and City Council approve the application.



Signature

Name: Liz Vazquez

Letter in Support

To: Brooklyn Community Board 14

Re: 2513-2523 Avenue O Rezoning (Block 7679 Lots 1, 2, 3, & 4)
2519-2523 Avenue O (Block 7679 Lots 1 & 2)
Brooklyn, New York (the "Development Site")

I live/work at 4317 Ave M, ^{Brooklyn} NY 11234 and submit this letter in support of the application made by Pulmonary and Sleep Medical, P.C., which seeks to rezone the Premises from an R2 zoning district to an R3-2 zoning district. This rezoning would facilitate the legalization of the existing community facility use, the Pulmonary and Sleep Medical Center, located at 2519-2523 Avenue O, Brooklyn, NY 11210. There are no enlargements planned for the Development Site. The rezoning would allow for the conversion of the two semi-detached homes located at the Development Site to be legally converted to a single mixed building with a ground floor and cellar medical facility with a single-family home on the second floor.

I understand what is being proposed and I believe that the proposal is consistent with the character of the surrounding neighborhood.

I urge the Community Board to support the application and recommend that the City Planning Commission and City Council approve the application.

Signature

Name: M. Johnson

Letter in Support

To: Brooklyn Community Board 14

Re: 2513-2523 Avenue O Rezoning (Block 7679 Lots 1, 2, 3, & 4)
2519-2523 Avenue O (Block 7679 Lots 1 & 2)
Brooklyn, New York (the "Development Site")

I live/work at 295 Ocean Pkwy Brooklyn NY 11224 and submit this letter in support of the application made by Pulmonary and Sleep Medical, P.C., which seeks to rezone the Premises from an R2 zoning district to an R3-2 zoning district. This rezoning would facilitate the legalization of the existing community facility use, the Pulmonary and Sleep Medical Center, located at 2519-2523 Avenue O, Brooklyn, NY 11210. There are no enlargements planned for the Development Site. The rezoning would allow for the conversion of the two semi-detached homes located at the Development Site to be legally converted to a single mixed building with a ground floor and cellar medical facility with a single-family home on the second floor.

I understand what is being proposed and I believe that the proposal is consistent with the character of the surrounding neighborhood.

I urge the Community Board to support the application and recommend that the City Planning Commission and City Council approve the application.

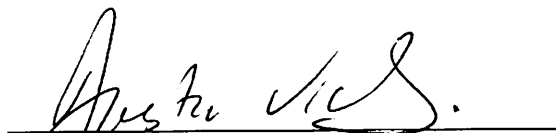
Signature
Name: Justin Udell

Letter in Support

To: Brooklyn Community Board 14

Re: 2513-2523 Avenue O Rezoning (Block 7679 Lots 1, 2, 3, & 4)
2519-2523 Avenue O (Block 7679 Lots 1 & 2)
Brooklyn, New York (the "Development Site")

I live/work at 900 15th Ave Bklyn NY 11218 and submit this letter in support of the application made by Pulmonary and Sleep Medical, P.C., which seeks to rezone the Premises from an R2 zoning district to an R3-2 zoning district. This rezoning would facilitate the legalization of the existing community facility use, the Pulmonary and Sleep Medical Center, located at 2519-2523 Avenue O, Brooklyn, NY 11210. There are no enlargements planned for the Development Site. The rezoning would allow for the conversion of the two semi-detached homes located at the Development Site to be legally converted to a single mixed building with a ground floor and cellar medical facility with a single-family home on the second floor.

I understand what is being proposed and I believe that the proposal is consistent with the character of the surrounding neighborhood.

I urge the Community Board to support the application and recommend that the City Planning Commission and City Council approve the application.

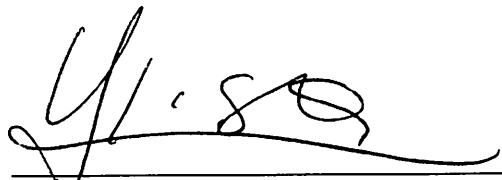

Signature

Name: Richard Shtern

Letter in Support

To: Brooklyn Community Board 14

Re: 2513-2523 Avenue O Rezoning (Block 7679 Lots 1, 2, 3, & 4)
2519-2523 Avenue O (Block 7679 Lots 1 & 2)
Brooklyn, New York (the "Development Site")

I live/work at 5100 15th Ave Bklyn NY 11218 and submit this letter in support of the application made by Pulmonary and Sleep Medical, P.C., which seeks to rezone the Premises from an R2 zoning district to an R3-2 zoning district. This rezoning would facilitate the legalization of the existing community facility use, the Pulmonary and Sleep Medical Center, located at 2519-2523 Avenue O, Brooklyn, NY 11210. There are no enlargements planned for the Development Site. The rezoning would allow for the conversion of the two semi-detached homes located at the Development Site to be legally converted to a single mixed building with a ground floor and cellar medical facility with a single-family home on the second floor.

I understand what is being proposed and I believe that the proposal is consistent with the character of the surrounding neighborhood.

I urge the Community Board to support the application and recommend that the City Planning Commission and City Council approve the application.

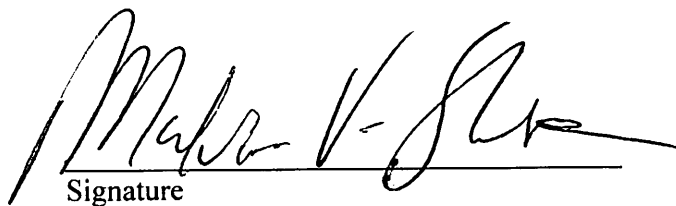
Signature

Name: Malvina V. Shteen

Letter in Support

To: Brooklyn Community Board 14

Re: 2513-2523 Avenue O Rezoning (Block 7679 Lots 1, 2, 3, & 4)
2519-2523 Avenue O (Block 7679 Lots 1 & 2)
Brooklyn, New York (the "Development Site")

BROOKLYN NY 11234
2037 EB + 5587

I live/work at _____ and submit

this letter in support of the application made by Pulmonary and Sleep Medical, P.C., which seeks to rezone the Premises from an R2 zoning district to an R3-2 zoning district. This rezoning would facilitate the legalization of the existing community facility use, the Pulmonary and Sleep Medical Center, located at 2519-2523 Avenue O, Brooklyn, NY 11210. There are no enlargements planned for the Development Site. The rezoning would allow for the conversion of the two semi-detached homes located at the Development Site to be legally converted to a single mixed building with a ground floor and cellar medical facility with a single-family home on the second floor.

I understand what is being proposed and I believe that the proposal is consistent with the character of the surrounding neighborhood.

I urge the Community Board to support the application and recommend that the City Planning Commission and City Council approve the application.



Signature

Name:

Letter in Support

To: Brooklyn Community Board 14

Re: 2513-2523 Avenue O Rezoning (Block 7679 Lots 1, 2, 3, & 4)
2519-2523 Avenue O (Block 7679 Lots 1 & 2)
Brooklyn, New York (the "Development Site")

I live/work at 248 Suydam St, Brooklyn, NY 11237 and submit this letter in support of the application made by Pulmonary and Sleep Medical, P.C., which seeks to rezone the Premises from an R2 zoning district to an R3-2 zoning district. This rezoning would facilitate the legalization of the existing community facility use, the Pulmonary and Sleep Medical Center, located at 2519-2523 Avenue O, Brooklyn, NY 11210. There are no enlargements planned for the Development Site. The rezoning would allow for the conversion of the two semi-detached homes located at the Development Site to be legally converted to a single mixed building with a ground floor and cellar medical facility with a single-family home on the second floor.

I understand what is being proposed and I believe that the proposal is consistent with the character of the surrounding neighborhood.

I urge the Community Board to support the application and recommend that the City Planning Commission and City Council approve the application.



Signature

Name: RENUKA CARPENTER

Letter in Support

To: Brooklyn Community Board 14

Re: 2513-2523 Avenue O Rezoning (Block 7679 Lots 1, 2, 3, & 4)
2519-2523 Avenue O (Block 7679 Lots 1 & 2)
Brooklyn, New York (the "Development Site")

I live/work at 2435 85th Street and submit this letter in support of the application made by Pulmonary and Sleep Medical, P.C., which seeks to rezone the Premises from an R2 zoning district to an R3-2 zoning district. This rezoning would facilitate the legalization of the existing community facility use, the Pulmonary and Sleep Medical Center, located at 2519-2523 Avenue O, Brooklyn, NY 11210. There are no enlargements planned for the Development Site. The rezoning would allow for the conversion of the two semi-detached homes located at the Development Site to be legally converted to a single mixed building with a ground floor and cellar medical facility with a single-family home on the second floor.

I understand what is being proposed and I believe that the proposal is consistent with the character of the surrounding neighborhood.

I urge the Community Board to support the application and recommend that the City Planning Commission and City Council approve the application.

Wendy Ellerbee
Signature

Name: Wendy Ellerbee

Letter in Support

To: Brooklyn Community Board 14

Re: 2513-2523 Avenue O Rezoning (Block 7679 Lots 1, 2, 3, & 4)
2519-2523 Avenue O (Block 7679 Lots 1 & 2)
Brooklyn, New York (the "Development Site")

I live/work at 2523 Ave O and submit this letter in support of the application made by Pulmonary and Sleep Medical, P.C., which seeks to rezone the Premises from an R2 zoning district to an R3-2 zoning district. This rezoning would facilitate the legalization of the existing community facility use, the Pulmonary and Sleep Medical Center, located at 2519-2523 Avenue O, Brooklyn, NY 11210. There are no enlargements planned for the Development Site. The rezoning would allow for the conversion of the two semi-detached homes located at the Development Site to be legally converted to a single mixed building with a ground floor and cellar medical facility with a single-family home on the second floor.

I understand what is being proposed and I believe that the proposal is consistent with the character of the surrounding neighborhood.

I urge the Community Board to support the application and recommend that the City Planning Commission and City Council approve the application.



Signature

Name: SUBHASH

Letter in Support

To: Brooklyn Community Board 14

**Re: 2513-2523 Avenue O Rezoning (Block 7679 Lots 1, 2, 3, & 4)
2519-2523 Avenue O (Block 7679 Lots 1 & 2)
Brooklyn, New York (the "Development Site")**

I live/work at 2517 Avenue O and submit this letter in support of the application made by Pulmonary and Sleep Medical, P.C., which seeks to rezone the Premises from an R2 zoning district to an R3-2 zoning district. This rezoning would facilitate the legalization of the existing community facility use, the Pulmonary and Sleep Medical Center, located at 2519-2523 Avenue O, Brooklyn, NY 11210. There are no enlargements planned for the Development Site. The rezoning would allow for the conversion of the two semi-detached homes located at the Development Site to be legally converted to a single mixed building with a ground floor and cellar medical facility with a single-family home on the second floor.

I understand what is being proposed and I believe that the proposal is consistent with the character of the surrounding neighborhood.

I urge the Community Board to support the application and recommend that the City Planning Commission and City Council approve the application.



Signature
Name: Amit Soni

Letter in Support

To: Brooklyn Community Board 14

Re: 2513-2523 Avenue O Rezoning (Block 7679 Lots 1, 2, 3, & 4)
2519-2523 Avenue O (Block 7679 Lots 1 & 2)
Brooklyn, New York (the "Development Site")

I live/work at 3619 Bedford Ave, # 6C BK, NY 11210 and submit this letter in support of the application made by Pulmonary and Sleep Medical, P.C., which seeks to rezone the Premises from an R2 zoning district to an R3-2 zoning district. This rezoning would facilitate the legalization of the existing community facility use, the Pulmonary and Sleep Medical Center, located at 2519-2523 Avenue O, Brooklyn, NY 11210. There are no enlargements planned for the Development Site. The rezoning would allow for the conversion of the two semi-detached homes located at the Development Site to be legally converted to a single mixed building with a ground floor and cellar medical facility with a single-family home on the second floor.

I understand what is being proposed and I believe that the proposal is consistent with the character of the surrounding neighborhood.

I urge the Community Board to support the application and recommend that the City Planning Commission and City Council approve the application.

Signature

Name:

Bagirov, Elgas

917 496 1524

Letter in Support

To: Brooklyn Community Board 14

Re: 2513-2523 Avenue O Rezoning (Block 7679 Lots 1, 2, 3, & 4)
2519-2523 Avenue O (Block 7679 Lots 1 & 2)
Brooklyn, New York (the "Development Site")

I live/work at 2517 Ave O, Bklyn, NY 11210 and submit this letter in support of the application made by Pulmonary and Sleep Medical, P.C., which seeks to rezone the Premises from an R2 zoning district to an R3-2 zoning district. This rezoning would facilitate the legalization of the existing community facility use, the Pulmonary and Sleep Medical Center, located at 2519-2523 Avenue O, Brooklyn, NY 11210. There are no enlargements planned for the Development Site. The rezoning would allow for the conversion of the two semi-detached homes located at the Development Site to be legally converted to a single mixed building with a ground floor and cellar medical facility with a single-family home on the second floor.

I understand what is being proposed and I believe that the proposal is consistent with the character of the surrounding neighborhood.

I urge the Community Board to support the application and recommend that the City Planning Commission and City Council approve the application.

Signature

Name: **MAPHI CARPENTER**
917 - 364-3605

Letter in Support

To: Brooklyn Community Board 14

Re: 2513-2523 Avenue O Rezoning (Block 7679 Lots 1, 2, 3, & 4)
2519-2523 Avenue O (Block 7679 Lots 1 & 2)
Brooklyn, New York (the "Development Site")

I live/work at 2519 Avenue O and submit this letter in support of the application made by Pulmonary and Sleep Medical, P.C., which seeks to rezone the Premises from an R2 zoning district to an R3-2 zoning district. This rezoning would facilitate the legalization of the existing community facility use, the Pulmonary and Sleep Medical Center, located at 2519-2523 Avenue O, Brooklyn, NY 11210. There are no enlargements planned for the Development Site. The rezoning would allow for the conversion of the two semi-detached homes located at the Development Site to be legally converted to a single mixed building with a ground floor and cellar medical facility with a single-family home on the second floor.

I understand what is being proposed and I believe that the proposal is consistent with the character of the surrounding neighborhood.

I urge the Community Board to support the application and recommend that the City Planning Commission and City Council approve the application.

Onokhina

Signature

Name: *IDA ONOKHINA*

Letter in Support

To: Brooklyn Community Board 14

Re: 2513-2523 Avenue O Rezoning (Block 7679 Lots 1, 2, 3, & 4)
2519-2523 Avenue O (Block 7679 Lots 1 & 2)
Brooklyn, New York (the "Development Site")

I live/work at work 2519 Ave O and submit this letter in support of the application made by Pulmonary and Sleep Medical, P.C., which seeks to rezone the Premises from an R2 zoning district to an R3-2 zoning district. This rezoning would facilitate the legalization of the existing community facility use, the Pulmonary and Sleep Medical Center, located at 2519-2523 Avenue O, Brooklyn, NY 11210. There are no enlargements planned for the Development Site. The rezoning would allow for the conversion of the two semi-detached homes located at the Development Site to be legally converted to a single mixed building with a ground floor and cellar medical facility with a single-family home on the second floor.

I understand what is being proposed and I believe that the proposal is consistent with the character of the surrounding neighborhood.

I urge the Community Board to support the application and recommend that the City Planning Commission and City Council approve the application.



Signature

Name: Mehina Ali

Letter in Support

To: Brooklyn Community Board 14

Re: 2513-2523 Avenue O Rezoning (Block 7679 Lots 1, 2, 3, & 4)
2519-2523 Avenue O (Block 7679 Lots 1 & 2)
Brooklyn, New York (the "Development Site")

I live/work at 2525 Kings Hwy and submit this letter in support of the application made by Pulmonary and Sleep Medical, P.C., which seeks to rezone the Premises from an R2 zoning district to an R3-2 zoning district. This rezoning would facilitate the legalization of the existing community facility use, the Pulmonary and Sleep Medical Center, located at 2519-2523 Avenue O, Brooklyn, NY 11210. There are no enlargements planned for the Development Site. The rezoning would allow for the conversion of the two semi-detached homes located at the Development Site to be legally converted to a single mixed building with a ground floor and cellar medical facility with a single-family home on the second floor.

I understand what is being proposed and I believe that the proposal is consistent with the character of the surrounding neighborhood.

I urge the Community Board to support the application and recommend that the City Planning Commission and City Council approve the application.

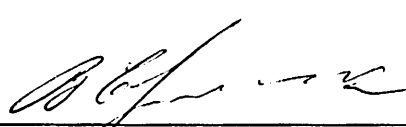

Signature

Name:

Volodymyr Svehick

Letter in Support

To: Brooklyn Community Board 14

Re: 2513-2523 Avenue O Rezoning (Block 7679 Lots 1, 2, 3, & 4)
2519-2523 Avenue O (Block 7679 Lots 1 & 2)
Brooklyn, New York (the "Development Site")

I live/work at 2525 Kings Hwy. and submit this letter in support of the application made by Pulmonary and Sleep Medical, P.C., which seeks to rezone the Premises from an R2 zoning district to an R3-2 zoning district. This rezoning would facilitate the legalization of the existing community facility use, the Pulmonary and Sleep Medical Center, located at 2519-2523 Avenue O, Brooklyn, NY 11210. There are no enlargements planned for the Development Site. The rezoning would allow for the conversion of the two semi-detached homes located at the Development Site to be legally converted to a single mixed building with a ground floor and cellar medical facility with a single-family home on the second floor.

I understand what is being proposed and I believe that the proposal is consistent with the character of the surrounding neighborhood.

I urge the Community Board to support the application and recommend that the City Planning Commission and City Council approve the application.

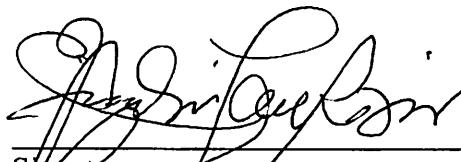

Signature

Name: VIRGILIO DEL ROSARIO

Letter in Support

To: Brooklyn Community Board 14

Re: 2513-2523 Avenue O Rezoning (Block 7679 Lots 1, 2, 3, & 4)
2519-2523 Avenue O (Block 7679 Lots 1 & 2)
Brooklyn, New York (the "Development Site")

I live/work at 2525 Kings Highway and submit this letter in support of the application made by Pulmonary and Sleep Medical, P.C., which seeks to rezone the Premises from an R2 zoning district to an R3-2 zoning district. This rezoning would facilitate the legalization of the existing community facility use, the Pulmonary and Sleep Medical Center, located at 2519-2523 Avenue O, Brooklyn, NY 11210. There are no enlargements planned for the Development Site. The rezoning would allow for the conversion of the two semi-detached homes located at the Development Site to be legally converted to a single mixed building with a ground floor and cellar medical facility with a single-family home on the second floor.

I understand what is being proposed and I believe that the proposal is consistent with the character of the surrounding neighborhood.

I urge the Community Board to support the application and recommend that the City Planning Commission and City Council approve the application.

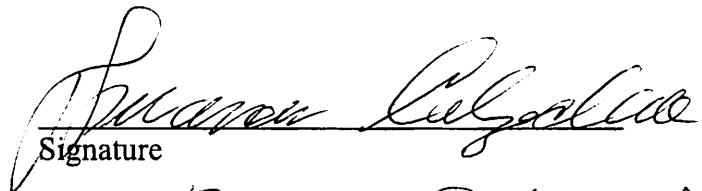
Signature

Name: FRANCIS CALZADILLA

Letter in Support

To: Brooklyn Community Board 14

Re: 2513-2523 Avenue O Rezoning (Block 7679 Lots 1, 2, 3, & 4)
2519-2523 Avenue O (Block 7679 Lots 1 & 2)
Brooklyn, New York (the "Development Site")

I live/work at 2525 Kings Highway and submit this letter in support of the application made by Pulmonary and Sleep Medical, P.C., which seeks to rezone the Premises from an R2 zoning district to an R3-2 zoning district. This rezoning would facilitate the legalization of the existing community facility use, the Pulmonary and Sleep Medical Center, located at 2519-2523 Avenue O, Brooklyn, NY 11210. There are no enlargements planned for the Development Site. The rezoning would allow for the conversion of the two semi-detached homes located at the Development Site to be legally converted to a single mixed building with a ground floor and cellar medical facility with a single-family home on the second floor.

I understand what is being proposed and I believe that the proposal is consistent with the character of the surrounding neighborhood.

I urge the Community Board to support the application and recommend that the City Planning Commission and City Council approve the application.

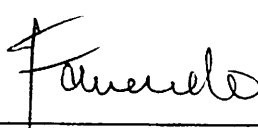
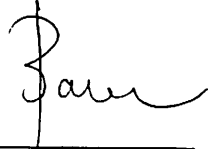
Signature

Name:

Fernando Baron

Letter in Support

To: Brooklyn Community Board 14

Re: 2513-2523 Avenue O Rezoning (Block 7679 Lots 1, 2, 3, & 4)
2519-2523 Avenue O (Block 7679 Lots 1 & 2)
Brooklyn, New York (the "Development Site")

I live/work at 2525 Kings Highway and submit this letter in support of the application made by Pulmonary and Sleep Medical, P.C., which seeks to rezone the Premises from an R2 zoning district to an R3-2 zoning district. This rezoning would facilitate the legalization of the existing community facility use, the Pulmonary and Sleep Medical Center, located at 2519-2523 Avenue O, Brooklyn, NY 11210. There are no enlargements planned for the Development Site. The rezoning would allow for the conversion of the two semi-detached homes located at the Development Site to be legally converted to a single mixed building with a ground floor and cellar medical facility with a single-family home on the second floor.

I understand what is being proposed and I believe that the proposal is consistent with the character of the surrounding neighborhood.

I urge the Community Board to support the application and recommend that the City Planning Commission and City Council approve the application.

Eva Eldabe

Signature

Name:

Eva Eldabe

Letter in Support

To: Brooklyn Community Board 14

Re: 2513-2523 Avenue O Rezoning (Block 7679 Lots 1, 2, 3, & 4)
2519-2523 Avenue O (Block 7679 Lots 1 & 2)
Brooklyn, New York (the "Development Site")

I live/work at 2525 Kingshwy N.Y. 11229 and submit this letter in support of the application made by Pulmonary and Sleep Medical, P.C., which seeks to rezone the Premises from an R2 zoning district to an R3-2 zoning district. This rezoning would facilitate the legalization of the existing community facility use, the Pulmonary and Sleep Medical Center, located at 2519-2523 Avenue O, Brooklyn, NY 11210. There are no enlargements planned for the Development Site. The rezoning would allow for the conversion of the two semi-detached homes located at the Development Site to be legally converted to a single mixed building with a ground floor and cellar medical facility with a single-family home on the second floor.

I understand what is being proposed and I believe that the proposal is consistent with the character of the surrounding neighborhood.

I urge the Community Board to support the application and recommend that the City Planning Commission and City Council approve the application.

Signature _____

Name:

Yelene Kupriyanova

Letter in Support

To: Brooklyn Community Board 14

Re: 2513-2523 Avenue O Rezoning (Block 7679 Lots 1, 2, 3, & 4)
2519-2523 Avenue O (Block 7679 Lots 1 & 2)
Brooklyn, New York (the "Development Site")

I live/work at 1405 E. 53 Street Brooklyn, NY and submit this letter in support of the application made by Pulmonary and Sleep Medical, P.C., which seeks to rezone the Premises from an R2 zoning district to an R3-2 zoning district. This rezoning would facilitate the legalization of the existing community facility use, the Pulmonary and Sleep Medical Center, located at 2519-2523 Avenue O, Brooklyn, NY 11210. There are no enlargements planned for the Development Site. The rezoning would allow for the conversion of the two semi-detached homes located at the Development Site to be legally converted to a single mixed building with a ground floor and cellar medical facility with a single-family home on the second floor.

I understand what is being proposed and I believe that the proposal is consistent with the character of the surrounding neighborhood.

I urge the Community Board to support the application and recommend that the City Planning Commission and City Council approve the application.

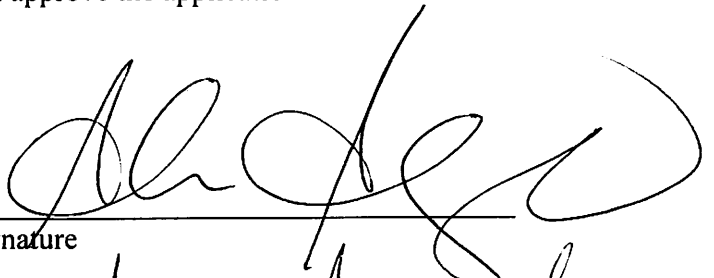

Signature

Name: Alicia Agard

Letter in Support

To: Brooklyn Community Board 14

Re: 2513-2523 Avenue O Rezoning (Block 7679 Lots 1, 2, 3, & 4)
2519-2523 Avenue O (Block 7679 Lots 1 & 2)
Brooklyn, New York (the "Development Site")

I live/work at Brooklyn, NY and submit this letter in support of the application made by Pulmonary and Sleep Medical, P.C., which seeks to rezone the Premises from an R2 zoning district to an R3-2 zoning district. This rezoning would facilitate the legalization of the existing community facility use, the Pulmonary and Sleep Medical Center, located at 2519-2523 Avenue O, Brooklyn, NY 11210. There are no enlargements planned for the Development Site. The rezoning would allow for the conversion of the two semi-detached homes located at the Development Site to be legally converted to a single mixed building with a ground floor and cellar medical facility with a single-family home on the second floor.

I understand what is being proposed and I believe that the proposal is consistent with the character of the surrounding neighborhood.

I urge the Community Board to support the application and recommend that the City Planning Commission and City Council approve the application.



Signature

Name: NAZIA JAHAN

NISHUJA@YAHOO.COM

Letter in Support

To: Brooklyn Community Board 14

Re: 2513-2523 Avenue O Rezoning (Block 7679 Lots 1, 2, 3, & 4)
2519-2523 Avenue O (Block 7679 Lots 1 & 2)
Brooklyn, New York (the "Development Site")

I live/work at 1090 Coney Island Brooklyn and submit this letter in support of the application made by Pulmonary and Sleep Medical, P.C., which seeks to rezone the Premises from an R2 zoning district to an R3-2 zoning district. This rezoning would facilitate the legalization of the existing community facility use, the Pulmonary and Sleep Medical Center, located at 2519-2523 Avenue O, Brooklyn, NY 11210. There are no enlargements planned for the Development Site. The rezoning would allow for the conversion of the two semi-detached homes located at the Development Site to be legally converted to a single mixed building with a ground floor and cellar medical facility with a single-family home on the second floor.

I understand what is being proposed and I believe that the proposal is consistent with the character of the surrounding neighborhood.

I urge the Community Board to support the application and recommend that the City Planning Commission and City Council approve the application.

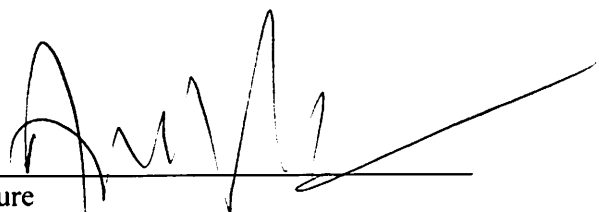
Signature

Name: **ARSHED AWARY**
Kawishmytv@gmail.com

Letter in Support

To: Brooklyn Community Board 14

Re: 2513-2523 Avenue O Rezoning (Block 7679 Lots 1, 2, 3, & 4)
2519-2523 Avenue O (Block 7679 Lots 1 & 2)
Brooklyn, New York (the "Development Site")

I live/work at 2519 Ave O and submit this letter in support of the application made by Pulmonary and Sleep Medical, P.C., which seeks to rezone the Premises from an R2 zoning district to an R3-2 zoning district. This rezoning would facilitate the legalization of the existing community facility use, the Pulmonary and Sleep Medical Center, located at 2519-2523 Avenue O, Brooklyn, NY 11210. There are no enlargements planned for the Development Site. The rezoning would allow for the conversion of the two semi-detached homes located at the Development Site to be legally converted to a single mixed building with a ground floor and cellar medical facility with a single-family home on the second floor.

I understand what is being proposed and I believe that the proposal is consistent with the character of the surrounding neighborhood.

I urge the Community Board to support the application and recommend that the City Planning Commission and City Council approve the application.

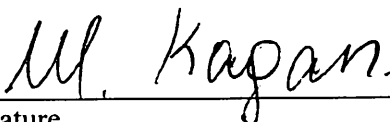

Signature

Name:

Letter in Support

To: Brooklyn Community Board 14

Re: 2513-2523 Avenue O Rezoning (Block 7679 Lots 1, 2, 3, & 4)
2519-2523 Avenue O (Block 7679 Lots 1 & 2)
Brooklyn, New York (the "Development Site")

I live/work at 2519 Ave O and submit this letter in support of the application made by Pulmonary and Sleep Medical, P.C., which seeks to rezone the Premises from an R2 zoning district to an R3-2 zoning district. This rezoning would facilitate the legalization of the existing community facility use, the Pulmonary and Sleep Medical Center, located at 2519-2523 Avenue O, Brooklyn, NY 11210. There are no enlargements planned for the Development Site. The rezoning would allow for the conversion of the two semi-detached homes located at the Development Site to be legally converted to a single mixed building with a ground floor and cellar medical facility with a single-family home on the second floor.

I understand what is being proposed and I believe that the proposal is consistent with the character of the surrounding neighborhood.

I urge the Community Board to support the application and recommend that the City Planning Commission and City Council approve the application.



Signature

Name: Rachelle Marriott

Letter in Support

To: Brooklyn Community Board 14

**Re: 2513-2523 Avenue O Rezoning (Block 7679 Lots 1, 2, 3, & 4)
2519-2523 Avenue O (Block 7679 Lots 1 & 2)
Brooklyn, New York (the "Development Site")**

I live/work at Arshad Ali ^{1374 E 69 St} Brooklyn NY and submit this letter in support of the application made by Pulmonary and Sleep Medical, P.C., which seeks to rezone the Premises from an R2 zoning district to an R3-2 zoning district. This rezoning would facilitate the legalization of the existing community facility use, the Pulmonary and Sleep Medical Center, located at 2519-2523 Avenue O, Brooklyn, NY 11210. There are no enlargements planned for the Development Site. The rezoning would allow for the conversion of the two semi-detached homes located at the Development Site to be legally converted to a single mixed building with a ground floor and cellar medical facility with a single-family home on the second floor.

I understand what is being proposed and I believe that the proposal is consistent with the character of the surrounding neighborhood.

I urge the Community Board to support the application and recommend that the City Planning Commission and City Council approve the application.

Arshad Ali
Signature

Name: Ali Arshad

Letter in Support

To: Brooklyn Community Board 14

**Re: 2513-2523 Avenue O Rezoning (Block 7679 Lots 1, 2, 3, & 4)
2519-2523 Avenue O (Block 7679 Lots 1 & 2)
Brooklyn, New York (the "Development Site")**

I live/work at Pulmonary & Sleep Medical, P.C. and submit this letter in support of the application made by Pulmonary and Sleep Medical, P.C., which seeks to rezone the Premises from an R2 zoning district to an R3-2 zoning district. This rezoning would facilitate the legalization of the existing community facility use, the Pulmonary and Sleep Medical Center, located at 2519-2523 Avenue O, Brooklyn, NY 11210. There are no enlargements planned for the Development Site. The rezoning would allow for the conversion of the two semi-detached homes located at the Development Site to be legally converted to a single mixed building with a ground floor and cellar medical facility with a single-family home on the second floor.

I understand what is being proposed and I believe that the proposal is consistent with the character of the surrounding neighborhood.

I urge the Community Board to support the application and recommend that the City Planning Commission and City Council approve the application.

Signature

Name:

Jesenia Rodriguez

Letter in Support

To: Brooklyn Community Board 14

Re: 2513-2523 Avenue O Rezoning (Block 7679 Lots 1, 2, 3, & 4)
2519-2523 Avenue O (Block 7679 Lots 1 & 2)
Brooklyn, New York (the "Development Site")

I live/work at 2517 Ave O Brooklyn NY 11210 and submit this letter in support of the application made by Pulmonary and Sleep Medical, P.C., which seeks to rezone the Premises from an R2 zoning district to an R3-2 zoning district. This rezoning would facilitate the legalization of the existing community facility use, the Pulmonary and Sleep Medical Center, located at 2519-2523 Avenue O, Brooklyn, NY 11210. There are no enlargements planned for the Development Site. The rezoning would allow for the conversion of the two semi-detached homes located at the Development Site to be legally converted to a single mixed building with a ground floor and cellar medical facility with a single-family home on the second floor.

I understand what is being proposed and I believe that the proposal is consistent with the character of the surrounding neighborhood.

I urge the Community Board to support the application and recommend that the City Planning Commission and City Council approve the application.

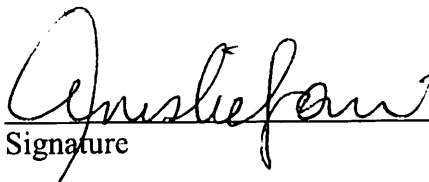
Signature

Name: Anisha Soni

Letter in Support

To: Brooklyn Community Board 14

Re: 2513-2523 Avenue O Rezoning (Block 7679 Lots 1, 2, 3, & 4)
2519-2523 Avenue O (Block 7679 Lots 1 & 2)
Brooklyn, New York (the "Development Site")

I live/work at 2519 AVE O and submit this letter in support of the application made by Pulmonary and Sleep Medical, P.C., which seeks to rezone the Premises from an R2 zoning district to an R3-2 zoning district. This rezoning would facilitate the legalization of the existing community facility use, the Pulmonary and Sleep Medical Center, located at 2519-2523 Avenue O, Brooklyn, NY 11210. There are no enlargements planned for the Development Site. The rezoning would allow for the conversion of the two semi-detached homes located at the Development Site to be legally converted to a single mixed building with a ground floor and cellar medical facility with a single-family home on the second floor.

I understand what is being proposed and I believe that the proposal is consistent with the character of the surrounding neighborhood.

I urge the Community Board to support the application and recommend that the City Planning Commission and City Council approve the application.

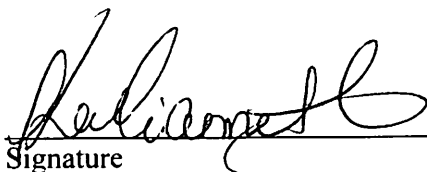
Signature

Name: Kaelianeth

Letter in Support

To: Brooklyn Community Board 14

Re: 2513-2523 Avenue O Rezoning (Block 7679 Lots 1, 2, 3, & 4)
2519-2523 Avenue O (Block 7679 Lots 1 & 2)
Brooklyn, New York (the "Development Site")

I live/work at 1775 East 18th St #5B and submit this letter in support of the application made by Pulmonary and Sleep Medical, P.C., which seeks to rezone the Premises from an R2 zoning district to an R3-2 zoning district. This rezoning would facilitate the legalization of the existing community facility use, the Pulmonary and Sleep Medical Center, located at 2519-2523 Avenue O, Brooklyn, NY 11210. There are no enlargements planned for the Development Site. The rezoning would allow for the conversion of the two semi-detached homes located at the Development Site to be legally converted to a single mixed building with a ground floor and cellar medical facility with a single-family home on the second floor.

I understand what is being proposed and I believe that the proposal is consistent with the character of the surrounding neighborhood.

I urge the Community Board to support the application and recommend that the City Planning Commission and City Council approve the application.

Signature
Name: Nicole JEANMITON

Letter in Support

To: Brooklyn Community Board 14

Re: 2513-2523 Avenue O Rezoning (Block 7679 Lots 1, 2, 3, & 4)
2519-2523 Avenue O (Block 7679 Lots 1 & 2)
Brooklyn, New York (the "Development Site")

I live/work at Benetta Vidal ^{2519 Ave O} Brooklyn NY and submit this letter in support of the application made by Pulmonary and Sleep Medical, P.C., which seeks to rezone the Premises from an R2 zoning district to an R3-2 zoning district. This rezoning would facilitate the legalization of the existing community facility use, the Pulmonary and Sleep Medical Center, located at 2519-2523 Avenue O, Brooklyn, NY 11210. There are no enlargements planned for the Development Site. The rezoning would allow for the conversion of the two semi-detached homes located at the Development Site to be legally converted to a single mixed building with a ground floor and cellar medical facility with a single-family home on the second floor.

I understand what is being proposed and I believe that the proposal is consistent with the character of the surrounding neighborhood.

I urge the Community Board to support the application and recommend that the City Planning Commission and City Council approve the application.

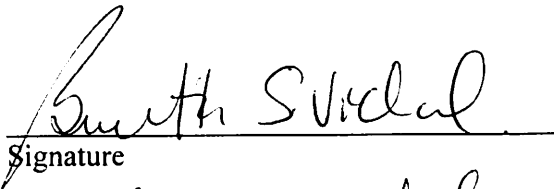
Signature
Name: Benetta Vidal.

Letter in Support

To: Brooklyn Community Board 14

Re: 2513-2523 Avenue O Rezoning (Block 7679 Lots 1, 2, 3, & 4)
2519-2523 Avenue O (Block 7679 Lots 1 & 2)
Brooklyn, New York (the "Development Site")

I live/work at Manana Kagan Ave²⁵¹⁹ and submit this letter in support of the application made by Pulmonary and Sleep Medical, P.C., which seeks to rezone the Premises from an R2 zoning district to an R3-2 zoning district. This rezoning would facilitate the legalization of the existing community facility use, the Pulmonary and Sleep Medical Center, located at 2519-2523 Avenue O, Brooklyn, NY 11210. There are no enlargements planned for the Development Site. The rezoning would allow for the conversion of the two semi-detached homes located at the Development Site to be legally converted to a single mixed building with a ground floor and cellar medical facility with a single-family home on the second floor.

I understand what is being proposed and I believe that the proposal is consistent with the character of the surrounding neighborhood.

I urge the Community Board to support the application and recommend that the City Planning Commission and City Council approve the application.

M. Kagan
Signature

Name:

Letter in Support

To: Brooklyn Community Board 14

Re: 2513-2523 Avenue O Rezoning (Block 7679 Lots 1, 2, 3, & 4)
2519-2523 Avenue O (Block 7679 Lots 1 & 2)
Brooklyn, New York (the "Development Site")

I live/work at 2519 ave O and submit this letter in support of the application made by Pulmonary and Sleep Medical, P.C., which seeks to rezone the Premises from an R2 zoning district to an R3-2 zoning district. This rezoning would facilitate the legalization of the existing community facility use, the Pulmonary and Sleep Medical Center, located at 2519-2523 Avenue O, Brooklyn, NY 11210. There are no enlargements planned for the Development Site. The rezoning would allow for the conversion of the two semi-detached homes located at the Development Site to be legally converted to a single mixed building with a ground floor and cellar medical facility with a single-family home on the second floor.

I understand what is being proposed and I believe that the proposal is consistent with the character of the surrounding neighborhood.

I urge the Community Board to support the application and recommend that the City Planning Commission and City Council approve the application.

Signature

Name:

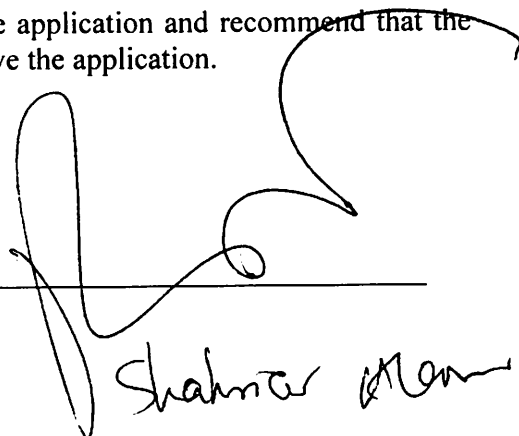

Shahmir Khan

Letter in Support

To: Brooklyn Community Board 14

**Re: 2513-2523 Avenue O Rezoning (Block 7679 Lots 1, 2, 3, & 4)
2519-2523 Avenue O (Block 7679 Lots 1 & 2)
Brooklyn, New York (the "Development Site")**

I live/work at 2525 Kings Highway NY and submit this letter in support of the application made by Pulmonary and Sleep Medical, P.C., which seeks to rezone the Premises from an R2 zoning district to an R3-2 zoning district. This rezoning would facilitate the legalization of the existing community facility use, the Pulmonary and Sleep Medical Center, located at 2519-2523 Avenue O, Brooklyn, NY 11210. There are no enlargements planned for the Development Site. The rezoning would allow for the conversion of the two semi-detached homes located at the Development Site to be legally converted to a single mixed building with a ground floor and cellar medical facility with a single-family home on the second floor.

I understand what is being proposed and I believe that the proposal is consistent with the character of the surrounding neighborhood.

I urge the Community Board to support the application and recommend that the City Planning Commission and City Council approve the application.

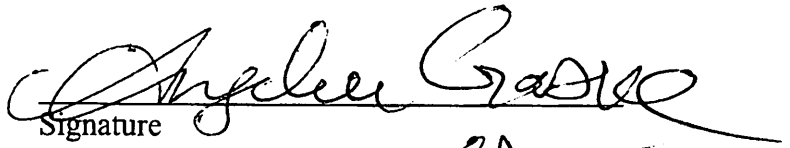
Signature
Name: Aydin GADIC

Letter in Support

To: Brooklyn Community Board 14

Re: 2513-2523 Avenue O Rezoning (Block 7679 Lots 1, 2, 3, & 4)
2519-2523 Avenue O (Block 7679 Lots 1 & 2)
Brooklyn, New York (the "Development Site")

I live/work at 2523 Ave O and submit this letter in support of the application made by Pulmonary and Sleep Medical, P.C., which seeks to rezone the Premises from an R2 zoning district to an R3-2 zoning district. This rezoning would facilitate the legalization of the existing community facility use, the Pulmonary and Sleep Medical Center, located at 2519-2523 Avenue O, Brooklyn, NY 11210. There are no enlargements planned for the Development Site. The rezoning would allow for the conversion of the two semi-detached homes located at the Development Site to be legally converted to a single mixed building with a ground floor and cellar medical facility with a single-family home on the second floor.

I understand what is being proposed and I believe that the proposal is consistent with the character of the surrounding neighborhood.

I urge the Community Board to support the application and recommend that the City Planning Commission and City Council approve the application.

SOFIA VAZQUEZ MEJIA
Signature

Name:

Letter in Support

To: Brooklyn Community Board 14

Re: 2513-2523 Avenue O Rezoning (Block 7679 Lots 1, 2, 3, & 4)
2519-2523 Avenue O (Block 7679 Lots 1 & 2)
Brooklyn, New York (the "Development Site")

I live/work at 2525 Kings highway, NY 11229 and submit this letter in support of the application made by Pulmonary and Sleep Medical, P.C., which seeks to rezone the Premises from an R2 zoning district to an R3-2 zoning district. This rezoning would facilitate the legalization of the existing community facility use, the Pulmonary and Sleep Medical Center, located at 2519-2523 Avenue O, Brooklyn, NY 11210. There are no enlargements planned for the Development Site. The rezoning would allow for the conversion of the two semi-detached homes located at the Development Site to be legally converted to a single mixed building with a ground floor and cellar medical facility with a single-family home on the second floor.

I understand what is being proposed and I believe that the proposal is consistent with the character of the surrounding neighborhood.

I urge the Community Board to support the application and recommend that the City Planning Commission and City Council approve the application.

Signature

Name: Patricia Burrell

Letter in Support

To: Brooklyn Community Board 14

**Re: 2513-2523 Avenue O Rezoning (Block 7679 Lots 1, 2, 3, & 4)
2519-2523 Avenue O (Block 7679 Lots 1 & 2)
Brooklyn, New York (the "Development Site")**

I live/work at 2478 E 28 St BKly 11210 and submit this letter in support of the application made by Pulmonary and Sleep Medical, P.C., which seeks to rezone the Premises from an R2 zoning district to an R3-2 zoning district. This rezoning would facilitate the legalization of the existing community facility use, the Pulmonary and Sleep Medical Center, located at 2519-2523 Avenue O, Brooklyn, NY 11210. There are no enlargements planned for the Development Site. The rezoning would allow for the conversion of the two semi-detached homes located at the Development Site to be legally converted to a single mixed building with a ground floor and cellar medical facility with a single-family home on the second floor.

I understand what is being proposed and I believe that the proposal is consistent with the character of the surrounding neighborhood.

I urge the Community Board to support the application and recommend that the City Planning Commission and City Council approve the application.

Fidel del Rosario
Signature
Name: Fidel del Rosario

Letter in Support

To: Brooklyn Community Board 14

Re: 2513-2523 Avenue O Rezoning (Block 7679 Lots 1, 2, 3, & 4)
2519-2523 Avenue O (Block 7679 Lots 1 & 2)
Brooklyn, New York (the "Development Site")

I live/work at 2525 Kings Hwy and submit this letter in support of the application made by Pulmonary and Sleep Medical, P.C., which seeks to rezone the Premises from an R2 zoning district to an R3-2 zoning district. This rezoning would facilitate the legalization of the existing community facility use, the Pulmonary and Sleep Medical Center, located at 2519-2523 Avenue O, Brooklyn, NY 11210. There are no enlargements planned for the Development Site. The rezoning would allow for the conversion of the two semi-detached homes located at the Development Site to be legally converted to a single mixed building with a ground floor and cellar medical facility with a single-family home on the second floor.

I understand what is being proposed and I believe that the proposal is consistent with the character of the surrounding neighborhood.

I urge the Community Board to support the application and recommend that the City Planning Commission and City Council approve the application.

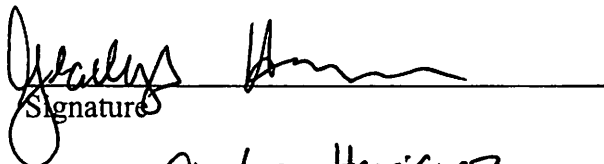
Signature

Name: Gladys Henriquez.

PAKISTANI/INDIAN-AMERICAN COMMUNITY LETTER OF SUPPORT

To: Hon. Chaim Deutsch
2401 Avenue U
Brooklyn, NY 11229

Re: 2513-2523 Avenue O Rezoning (Block 7679 Lots 1, 2, 3, & 4)
2519-2523 Avenue O (Block 7679 Lots 1 & 2)
Brooklyn, New York (the "Development Site")

I live at 8140 New Utrecht Ave Brooklyn, NY, 11244 and I am signing this notice to give my support for the application by Dr. Prabhat Soni, M.D. and his Pulmonary and Sleep Medical, P.C., so that his Premises can be rezoned (as described below).

As a member of the local Pakistani/Indian-American community, I am proud to support this application because it is by a doctor who is respected member of our community. Dr. Soni has been serving our community for over 30 years and knows very well our community's problems, especially among our elderly parents who need Dr. Soni's services more than anybody else. If Dr. Soni is forced to move away, that will jeopardize our elderly parent's care and they will suffer the most. It will be difficult to find a doctor of his caliber to provide equal or better care to our extremely sick and dependent population.

We want Dr. Soni to continue to be there to give medical care from the many medical disciplines (8) that he is Board-certified to provide. Therefore, I strongly urge you to support Dr. Soni's application and the approval which it has already received from the City Planning Commission. Recognizing that this is your final term on the New York City Council, I would thankfully hope to continue to support you in any of your future political plans.

**REZONING APPLICATION OF PULMONARY and SLEEP MEDICAL P.C.
BY DR. PRABHAT SONI, M.D.**

(DEVELOPMENT SITE LOCATED AT 2519 - 2523 AVENUE O, BROOKLYN, NY 11210)

- 1) This application is to re-zone the Premises from R-2 zoning district to R3-2. This rezoning would allow the existing community facility use by Pulmonary and Sleep Medical Center to be legalized.
- 2) There are no plans to enlarge the medical facility at the Development Site, only to legalize the conditions that currently exist.
- 3) The rezoning would enable the two semi-detached homes located at this site to be legally converted to a single mixed use building with a ground floor and cellar medical facility with a single family home on the second floor
- 4) Approval as R3-2 permits Dr. Soni to continue his multi-discipline practice in the facility.
- 5) The proposal is in keeping with the character of the surrounding neighborhood which includes the Emergency Room (ER) of New York Community Hospital across the street.
- 6) By signing herein, the person signing is declaring that he/she agrees with Dr. Soni's request for this rezoning for Pulmonary and Sleep Medical PC.

By my signature, I confirm that I understand and agree with Dr. Soni's application.

Signature

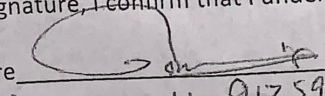

917 592 2518

Date: 02/02/20

Wife of Dawson Akter
Community ANS THE M
AMAM (Mosque)
"Lun Full"
S

PAKISTANI/INDIAN-AMERICAN COMMUNITY LETTER OF SUPPORT

To: Hon. Chaim Deutsch
2401 Avenue U
Brooklyn, NY 11229

Re: 2513-2523 Avenue O Rezoning (Block 7679 Lots 1, 2, 3, & 4)
2519-2523 Avenue O (Block 7679 Lots 1 & 2)
Brooklyn, New York (the "Development Site")

I live at 1089 CONYSSA AVE Brooklyn NY 11230 and I am signing this notice to give my support for the application by Dr. Prabhat Soni, M.D. and his Pulmonary and Sleep Medical, P.C., so that his Premises can be rezoned (as described below).

As a member of the local Pakistani/Indian-American community, I am proud to support this application because it is by a doctor who is respected member of our community. Dr. Soni has been serving our community for over 30 years and knows very well our community's problems, especially among our elderly parents who need Dr. Soni's services more than anybody else. If Dr. Soni is forced to move away, that will jeopardize our elderly parent's care and they will suffer the most. It will be difficult to find a doctor of his caliber to provide equal or better care to our extremely sick and dependent population.

We want Dr. Soni to continue to be there to give medical care from the many medical disciplines (8) that he is Board-certified to provide. Therefore, I strongly urge you to support Dr. Soni's application and the approval which it has already received from the City Planning Commission. Recognizing that this is your final term on the New York City Council, I would thankfully hope to continue to support you in any of your future political plans.

REZONING APPLICATION OF PULMONARY and SLEEP MEDICAL P.C.

BY DR. PRABHAT SONI, M.D.

(DEVELOPMENT SITE LOCATED AT 2519 - 2523 AVENUE O, BROOKLYN, NY 11210)

- 1) This application is to re-zone the Premises from R-2 zoning district to R3-2. This rezoning would allow the existing community facility use by Pulmonary and Sleep Medical Center to be legalized.
- 2) There are no plans to enlarge the medical facility at the Development Site, only to legalize the conditions that currently exist.
- 3) The rezoning would enable the two semi-detached homes located at this site to be legally converted to a single mixed use building with a ground floor and cellar medical facility with a single family home on the second floor
- 4) Approval as R3-2 permits Dr. Soni to continue his multi-discipline practice in the facility.
- 5) The proposal is in keeping with the character of the surrounding neighborhood which includes the Emergency Room (ER) of New York Community Hospital across the street.
- 6) By signing herein, the person signing is declaring that he/she agrees with Dr. Soni's request for this rezoning for Pulmonary and Sleep Medical PC.

By my signature, I confirm that I understand and agree with Dr. Soni's application.

Signature [Handwritten Signature]

Name: Iqbal Qureshi
1089 Muslim Community Ctr

Date: 2-3-20

*PLEASE ABOVE LETTER
SUPPORT OF DR. SONI
-T NBR MIM IN
MIM
- MOSQUE*

GO BROOME STREET DEVELOPMENT

Members of the City Planning Commission

February 12, 2020

I oppose a change in zoning from R-8 to R9-1 for the BROOME STREET DEVELOPMENT.

I would first like to emphasize that COMMUNITY BOARD 3, while approving this project, recommended certain conditions as part of its approval. Specifically, they wanted to hear about “scenarios to lower the overall building height and bulk” and at a minimum locate all mechanical and other services elsewhere on the site. Also added was a “commitment to enhance trees and open space” and “designate units for middle income.” Have any of these recommendations been taken?

On a fairly constrained footprint, it would also abut three narrow cross streets, heavy with Bridge traffic. Norfolk Street, like Clinton, is practically an unofficial ramp to the Williamsburg Bridge. There would be more of a traffic nightmare.

This site is also just across from the new Essex Crossing development, planned with much community input. The new Suffolk building would be bulkier and 25 feet taller than the highest Essex Crossing building, and could go even 30 feet higher with the planned roof mechanicals. This applicant also wants special permits for fewer setbacks, streetwall changes, minimum distances. There would be no outdoor space. The totality of all of these requests just emphasizes that it is too much for this site.

This applicant notes that these changes are necessary for the viability of the project, so it can accommodate affordable housing and community spaces. These are commendable but this is not the place to put them. Our neighborhood already has a large share of affordable housing in dedicated Essex Crossing Buildings. Community space of 40,000 square feet (how many apartments is that?) seems excessive.

This could set a precedent for the many other sites in this neighborhood that are ripe for development. Is every developer going to be allowed to build

higher and wider in exchange for some amenities. What is zoning for if not for something like this?

I was hoping that someone, somewhere, in some place of authority, maybe here, would be able to see the failings of this proposal and not approve something now that will be here for 100 years, and will always be a reminder that it didn't have to be.

There is NO reason to allow this as proposed. A high, dense, bulky building on a narrow corner not in sympathy with its surroundings would result. Please keep the R8 zoning.

Thank you,

Judith Prigal

212 East Broadway

Julius Tajiddin, et. al
Community Leaders in Harlem
P.O. Box 2499
New York, NY 10027

Tel. 917 442-2528

December 18, 2019

City Planning Commission
of New York City
*[22 Reade Street
New York, New York]*
120 Broadway
31st Floor
New York, NY 10271

Re: Lenox Terrace Rezoning

Dear City Planning Commissioners:

I ask that you VOTE NO and submit correspondence to the New York City Council REJECTING the Lenox Terrace Rezoning application in its entirety pursuant to the advice of Community Board 10/Manhattan and the Honorable Gale Brewer, Borough President of Manhattan.

First of all, the Community Board 10 Resolution is very sound. It covers all of the sentiments and concerns from all the relevant stakeholders, whether they were for the rezoning or against it.

However, CB 10 found that the majority of the stakeholders were against the rezoning and as a result CB 10 was persuaded to vote in disapproval for the reasons expressed in the resolution.

One of CB 10's strongest arguments was the law itself. Ten years ago maybe this project as promised would have been legal. Now as promised it violates the law. And not just any law, but a supreme law of the land.

The Fannie Lou Hamer, Rosa Parks and Coretta Scott King Voting Rights Act Reauthorization and Amendments Act of 2006. (The Voting Rights Act of 1965 as amended in 2006)

The ***FLHRPCSKVRARAA*** law was enacted by the 109th United States Congress and 43rd President of the United States. It is a supreme law of the land. The temporary provisions in the Voting Rights Act of 1965 (i.e., Section 5) were again extended in 2006, this time up to 2035. Moreover, greater protections in Section 5 were given to protected groups, i.e., the African American population. In particular Section 5, as amended, states that any standard, practice or procedure with respect to voting, denies or abridges the right to vote if its purpose or *its effect*

will be the diminishment of the ability of any U.S. citizens on account of race or color, or in contravention of certain guarantees, *to elect their preferred candidates of choice*. Emphasis added.

In fact, Section 5 was challenged in 2012 and upheld by the SCOTUS in the matter of *Shelby County vs. Eric Holder*. (2013)

What this amounts to is that this massive rezoning application and the other ones in the ULURP pipeline that offer 25% “*affordable*” housing and 75 % open market units (or thereabouts) are threatening the plurality of Central Harlem, which is African American.¹ We have demonstrated throughout time that our preferred candidate of choice is African American. And given the choice which under Section 5 we have, Congress has wisely figured out that there is a strong inclination that we will continue voting for an African American, likely Democrat, to represent us in City Council/District 9 and our state legislative districts, State Senate District 30 and State Assembly District 70.

The question is: Why is this so important? It’s important because not only can an individual voter be disenfranchised but a group belonging to a particular race can also be disenfranchised.

Harlem became plurality “Black” for a lot of reasons, but reverse gentrification wasn’t one of them. Well, initially yes. Slavery was the reason Black people initially came to Harlem. But after slavery circumstances brought [us] here.

And once we gained some sort of political power – *with that comes a certain amount of self-determination and other benefits* – and as a group vote a certain way, congress saw the need to protect that right and declared that diluting or diminishing [our] ability to elect [our] preferred candidates of choice would in essence be disenfranchising the [group].

So there is individual disenfranchisement and there is group disenfranchisement. Furthermore, any standard, practice or procedure (this is by government intrusion) that by its action its *effect* will be the diminishment or dilution of such ability, denies or abridges the right to a meaningful vote. In this case the right to elect [their] preferred candidate of choice.

Relevant Background Facts

Community Board 10 which is where the Lenox Terrace project will be constructed, makes up a large part of City Council District 9 and its plurality is African American, giving Council District 9 also a plurality African American.²

¹ The affordable units that are offered require an income of approximately 48K per year. Not only is this income out of the range of most Harlem residents, the units in that 25% are mostly studios, with some 1 bedrooms. Very few 2 bedrooms are offered. This type of development discourages the production or increase of Black families.

² Manhattan Community Board 10 2014 District Needs Statement - “African Americans make up approximately 63% of Community Board 10’s population, followed by Hispanic at 22%, White at 10% and Asian at 2%.” However, upon information and belief the Black population in District 9 has shrunk to 53% as of 2018.

Community Board 10's citizen voting age plurality is also African American.

The African American population in the United States is a protected group under the Voting Rights Act of 1965.

African Americans living in Community Board 10 (Central Harlem) and Council District 9 have enjoyed a plurality African American for over one hundred years and political power for the last four score years.

The community at large, expert opinions and other evidence have alleged or demonstrated that such rezoning, along with other mass re-zonings in Harlem, *past and present*, could affect the African American population's plurality status in District 9 in such a way that within 5 years Harlem will not be a plurality African American.

The city's zoning standards and developers' practices have created a dangerous precedent for the African American population in Harlem. Continuing to go unchecked it will accelerate the termination of the African American population's plurality status. This is why a line is now being drawn in the sand. And we stand on the *FLHRPCSK* law.

Such concern is realistic because historically **open market** apartments are occupied mostly by non-African Americans, as historically African Americans have a higher unemployment rate due to discriminatory systems that have long been in place and African Americans historically have faced and still do unequal employment practices.

Voting Rights Act (Section 5) Protection in Harlem Precedent

Back in 2007 Community Board 10 responded to the City's 125th Street Rezoning plan in its Resolution Disapproving of the 125th Street Rezoning which included the ground that its plurality and political power would be threatened by such rezoning, thereby making such zoning in part a violation of the Voting Rights Act of 1965, as amended in 2006.

City council heeded to Community Board 10's concern in that regard and within the 125th Street Special District's area for the highest residential density, such development is actually discouraged by certain mechanisms that have been put in place under local law.

In fact, City Council District 9 residents successfully fought to strengthen the African American's plurality status in District 9 (as well as Community Board 10) when the City brought forth its City Council Redistricting plan in 2012-2013, making such plurality (59% then) greater by 8%.

Purpose

The Act's purpose in part is to guarantee the right of protected groups (i.e., African American) to be able to cast meaningful votes [Section 2].

Congress has found that the reasons for such concerns by the African American group (supra) are justified and there is a continued need for protection.

Whereas Congress has declared in part through such Act that any practice or procedure that affects voting that has the purpose of or will have the *effect* of diminishing or diluting the ability of any citizens in a protected class (i.e., African American) to elect their preferred candidates of choice denies or abridges such group's right to vote [Section 5].

The African American population in CB 10 and Council District 9 is sufficiently large and geographically compact to constitute a majority in a single – member district; such group is politically cohesive; and the majority votes sufficiently as a bloc.³

Therefore, because of the above, African Americans living in CB 10, Council District 9, Senate District 30, Assembly District 70, enjoy African American representation in government, which is by their choice and they have demonstrated that they want to continue voting for people from their group.

Affordable Housing

The city's standard, law or rule for affordable housing can no longer apply in Central Harlem. Just like there are laws that let you vend in one part of the city but make it unlawful to vend in another part, the MIH/IH is no longer legal in Harlem under the Supreme Law of the land.

Maybe it could have been 20 years ago, maybe even 10. However, it is not legal for Central Harlem now. An example would be this: 50 years ago the use of asbestos was legal. Now it's not. A non-marital child under the inheritance laws of New York can prove paternity kinship largely with a post DNA test result in his/her favor. However, if a decedent died in 2009 a non-marital child would need to show clear and convincing evidence and that the decedent openly and notoriously acknowledged the child during his lifetime.

So laws are set up in different ways to do different things. The Fannie Lou Hamer, et al, law is designed to protect a protected group's right to a meaningful vote. That can only be determined by the Black population in Central Harlem. Thus [we] have declared it by our voting history.

MIH's flaw

It has been historically demonstrated that even when developing as of right, the likelihood that developers who build on a scale such as what the Olnick plan proposes even without a rezoning approval will apply for the federal Low-Income Housing Tax Credit (LIHTC) because the tax credits are more attractive than tax deductions, as the credits provide a dollar-for-dollar reduction

³ I would hope that I can forgo the arduous task of going through all the Supreme Court cases that support the implications being made in these two paragraphs.

in a taxpayer's federal income tax, whereas a tax deduction only provides a reduction in taxable income.

For any developer to qualify⁴ it agrees to one of the following:

- **At least 20% or more of the residential units in the development are both rent restricted and occupied by individuals whose income is 50% or less than the area median gross income.**
- At least 40% or more of the residential units in the development are both rent restricted and occupied by individuals whose income is 60% or less than the area median gross income.
- **At least 40% or more of the residential units in the development are both rent restricted and occupied by individuals whose income does not exceed the imputed income limitation designated by the taxpayer with respect to the respective unit. The average of the imputed income limitations shall not exceed 60% of the area median gross income.**

Typically, the project owner will agree to a higher percentage of low income usage than these minimums, up to 100%. There are no limits on the rents that can be charged to tenants who are not low income but live in the same project. However, the rule says, "60% or less" contemplating that the owner/developer will seek some sort of tax abatement or free "something" from the local government, thus the rule does not prevent the developer/owner from offering a lower percentage of the AMI.

The Olnick group has not presented an income targeted housing plan that is more attractive than 60% of the AMI, which is something that they will most likely do even without a rezoning approval. *Supra*.

However, this is a project for a rezoning. The Olnick group has requested a zoning that will give it greater bulk and density with other benefits. Also, Olnick will more than likely apply for the city's J51 Tax Credit program and for a set term not pay any city property taxes, without having to offer the low-income units to families earning less than 60% of the AMI. (*There were very few units that were offered at 50% of the AMI.*) Again, this will put a heavy tax burden on Harlem's smaller property home owners. (*If I am wrong on this, neither Olnick nor any other devil's advocate disputed this hypothesis.*)

When you add everything up, left unchecked, we are allowing housing, new and old, through a systematic standard, practice and procedure which its effect will diminish the ability of Harlem's plurality African American population to elect their preferred candidates of choice within several years. We cannot allow this standard, practice or procedure any longer.

Further Risk Factors

Furthermore, it has been historically demonstrated that major developments that consist of mainly open market units increase property taxes on smaller property owners in the catchment areas where such developments are situated. And the area of the Lenox Terrace cite is

⁴ The first step in the process is for a project owner to submit an application to a state authority, which will consider the application competitively. The application will include estimates of the expected cost of the project and a commitment to comply with one of the conditions (*supra*), known as "set-asides." HUD

surrounded by many properties owned by senior African Americans with limited income, thereby putting such properties at risk of higher property taxes, which ultimately will force these tenants out of Harlem.

Income Targeted Housing solution

Community Board 10 followed the Harlem Platform Committee's recommendation for an Income Targeted Housing model, in its decision disapproving the 125th Street Rezoning with Conditions back in 2007.

What Income Targeted Housing does is allow the creation of housing that addresses the relevant income bands in the district where the development is going to go up on a priority basis.

So if there are 100 people in your district in need of housing and 80% are low income earning between 15-29K a year, with or without a family of three, and the 20% are families earning 130-200K a year, with or without a family of three, we don't want/need 80% of housing that caters to someone or families earning 130-200K a year, and the 20% of housing only geared to families not even making 15-29K a year but instead earning 43-90K a year. That is truly gentrification at its top form, which is a condition created by unlawful government means. It pushes those low income tenants out and brings in wealthier tenants. This so happens to coincide with Black people being the ones pushed out and whites or non-Black people being the ones brought in.

Well this has been happening in Harlem for some time now and it is time to stop.

However, there are people in government who have heard our plea. Assembly member Inez Dickens has been pushing for Income Targeted Housing. Public Advocate Jumaane Williams is asking for Income Targeted Housing. Former HPD Commissioner Shaun Donovan tried to push for it before he went to HUD. Even the [Victoria Theater Project] which is a towering 27/28 story building on W, 125th Street – a project under the control of the Empire State Development Corp - has honored the spirit of the Voting Rights Act of 1965, as amended in 2006, and the 125th Street Special District, whereby it has a 100 foot set back and its housing model is targeted at 50/30/20, which housing income bands are Open, Moderate and Low, respectively. The Urban League development will also be utilizing an Income Targeted Housing model.

This is a fair attempt at respecting and adhering to the Fannie Lou Hamer, et al, law. The Olnick group will not be harmed by a decision of “NO” on its project. However, any harm that could occur doesn't rise above a supreme law of the land, especially since the project came well after such law was enacted. Furthermore, neither the ULURP procedure nor the traditional standard and practice (precedent) of how things are done when it comes to housing development supersedes a supreme law of the land.

Conclusion

It is with the utmost sincerity that we request the Commissioners of the City Planning Commission of New York City to follow the advice of CB 10, the Honorable Gale Brewer and all those others to vote against the applications before it, advise the Olnick group to adhere to the concerns outlined in the CB 10 resolution and follow a housing model that will not violate the Voting Rights Act of 1965, as amended in 2006, if it decides to come back with a rezoning application.

Very truly yours,

Julius Tajiddin, et. al

Harlem Advocates/Community Leaders

Cc: as appropriate

Julius Tajiddin
Preserve Harlem's Legacy
(Founder)
P.O. Box 2499
New York, NY 10027

Tel. 917 442-2528

February 12, 2020

Zoning and Franchises Subcommittee
Land Use Committee
New York City Council
New York, NY

Written Testimony of Julius Tajiddin

Re: Lenox Terrace Rezoning

Good Morning Council Members:

I ask that you Vote **NO** on the **Lenox Terrace Rezoning** application in its entirety for the reasons expressly articulated in the **Manhattan Community Board 10 Resolution** regarding same; **Recommendation of the Honorable Gale Brewer, Manhattan Borough President** and the written and oral testimony by me, **Julius Tajiddin**, submitted to the **City Planning Commission of New York City** on **December 17, 2019**.

I submit to you the same written document on file at the City Planning Commission. However, today I will not be redundant. Instead, I will emphasize on the *Commission's* misunderstanding or lack thereof of the Voting Rights Act of 1965, as amended in 2006, known as the ***Fannie Lou Hammer, Rosa Parks, and Coretta Scott King Voting Rights Act Reauthorization and Amendments Act of 2006***.

A few of the Commissioners had concerns whether this application would violate such act. Chairman Castro in answering one particular commissioner's address of the matter on the day of the vote who wasn't in attendance at the hearing simply said that the issue was addressed in a later report by counsel and that basically it did not apply to rezonings, rather redistricting. Nevertheless, two Commissioners did not vote in favor of this rezoning.

This seems to be a common thought throughout certain circles when it comes to issues pertaining to race, in particular African American communities. I wish today I could tell you that it's not a race issue. But it is a race issue.

The plan meaning of the phrase found in Section 5b of such Act “*any standard, practice or procedure...*” clearly implies that there are *other* things besides redistricting that can negatively impact or dilute a protected group’s voting rights.

And the right that we assert will be diluted or diminished is our right as a protected class to have the ability to elect a candidate in our single member districts, i.e., city council, of our preference.

Briefly I will use as an example ***Standard***. What is meant by standard within the meaning of the section? It simply is something established by authority, custom, or general consent as a model, example, or point of reference. Example: The housing model for inclusionary housing is 75% open market and 25% affordable, which as of 2020 does not work for us. In fact it has been a discriminatory housing model from its inception.

Also the misunderstanding and application of the **Low Income Housing Tax Credit** by the city is an incorrect practice that’s been hurting African American Communities.

So you see council members there are more things than redistricting that can violate the law. However, in truth rezoning is a vertical redistricting. It has the same effect as the former if done in a discriminatory way. Nevertheless, this process we are going through is known as ULURP. It is a procedure like redistricting is a procedure. And it falls within the category “*any procedure*” within the meaning of Section 5b of such Act, which by the way was upheld in ***Shelby County vs Eric Holder***.

Lastly, I will address why we the African American population in District 9 qualify for this protection and what will happen if it is violated. These massive rezonings and the inclusionary housing formula are like a sunami. It will wipe out the African American plurality in a matter of 10 years or less thus diluting the African American’s ability to elect such candidates of their preference, thereby denying our voting rights pursuant to Section 5b of the Fannie Lou Hammer Act, et al. This is not the same thing as property owners going through the sea of development organically. Id.

Qualification

Besides ***Shelby County***, there is guidance on this matter in ***Thornburg v Gingle***. Although the framework for assessing dilution of minority votes dealt with unconstitutional multi member election systems the assessment used in ***Gingle*** is still applicable here.

The three things we would have to show pursuant to ***Gingle*** are: *Are African Americans in Central Harlem sufficiently large and geographically compact to constitute a majority in a single member district?* **Yes**, but barely holding on.

Are African Americans in Central Harlem politically cohesive (meaning its members tend to vote similarly)? **Yes**. We vote Democrat and African American.

Finally, *does the African American majority vote sufficiently as a bloc to enable it ...usually...to defeat the minority's preferred candidate?* Yes. Historically we have proven that there will not be a Republican or non-Black candidate to represent us as long as we hold the majority.

Taking the totality of the circumstances would this rezoning diminish the ability of the African American group in Central Harlem to elect candidates of its preference (Id)? Yes.

And this is the law, regardless of what party passed it.

Thank you.

Julius Tajiddin

Julius Tajiddin
Preserve Harlem's Legacy
(Founder)
P.O. Box 2499
New York, NY 10027

Tel. 917 442-2528

February 14, 2020

Zoning and Franchises Subcommittee
Of the Land Use Committee
New York City Council
New York, NY

Addendum - Written Testimony of Julius Tajiddin

Re: Lenox Terrace Rezoning

Dear Zoning and Franchises Subcommittee Members:

This additional written testimony is necessary because Olnick, the applicant for the rezoning request before you, revealed additional changes to its application that only till yesterday did I learn of. Therefore, I am submitting this post hearing addendum.

Olnick cries the blues, claiming how it's strapped for cash and cannot do any of the things it needs and wants to do unless it gets its *development project* which is at the site of Lenox Terrace rezoned. It claims that this increased zoning will enable it to do great things for Lenox Terrace and the neighborhood.

But what isn't talked about is the fact that Olnick is enrolled in the J51 tax credit program, which means it is not paying any property taxes. Id. As stated in the CB 10 Resolution and other documents, Olnick is involved in a lawsuit because it is alleged that it unlawfully deregulated apartments while in the program thereby flagrantly violating **Roberts vs. Tishman Speyer Properties**. It has been alleged that Olnick has offered a settlement in the millions regarding same. Id.

I would also add that when asked at CB 10 and MBP Gale Brewer's hearings if it applied or will apply for HUD's Low Income Housing Tax Credit Olnick with or without city council approval Olnick never answered. This can be taken as a yes, because Olnick is alleging honesty. So silence means yes.

Nevertheless, this means that it will get matching dollars for development from HUD if it gets approved, which in all likelihood it will, whether this project goes through or not. In other words if this project cost 500M HUD will give Olnick 250M right away for development.

And all they have to do is offer a certain *number of units* at 60% or lower of the AMI. But what they have recently offered is insulting. It pales in comparison to everything that they will get. So in essence they are coming to the city offering nothing in hopes of getting away with a double dip. In fact, the City's Mandatory Inclusionary Housing rewards developers for doing something that they will do anyway in order to receive the HUD award.

Olnick will also likely continue to stay in the J51 program with or without this project, get half of their development costs paid for, with or without this project, and get as much city and state benefits as it can, with or without this project. Therefore Olnick's statement declaring that there will be no affordable units in its alternative plan should this application not get approved is highly unlikely.

However, affordable does not address Harlem's real housing needs anyway. We need "*Income Targeted Housing*," which would have a housing model closer to 50/30/20. The AMI in Central Harlem may be 39-49K a year but that number could jump to 500K a year if a billionaire lived there. We have way more people living at 25K than at 39-130K.

In closing, this is greed and another part of the scheme to rid Central Harlem of its African American plurality. An approval of this application would violate the **Fannie Lou Hammer, Rosa Parks, Coretta Scott King Voting Rights, Reauthorization and Amendments Act of 2006**. I urge you to support City Council Member Bill Perkins' outright "No" on this application. I trust that Olnick will go back to the drawing board and satisfy what the Lenox Terrace tenants and the community needs and wants going forward. Please allow that to work.

Respectfully I am,

Julius Tajiddin

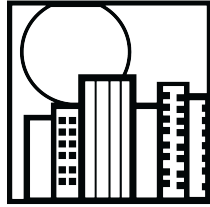

Lenox Terrace Association of Concerned Tenants
www.LTACT.org

12 January 2020

Good morning. My name is Savanna Washington and I am the Vice President of the Lenox Terrace Association of Concerned Tenants, the tenant's association at Lenox Terrace.

LT-ACT is against the current proposed R8 rezoning of the Lenox Terrace property. We ask that the City Council vote no on the proposed R8 project currently before you.

As Manhattan Borough President Gale Brewer said in her no recommendation, "There are few instances where a development the scale of the one proposed in this application can be viewed as responsible. The proposed project lacks the public and private investments necessary to make it a prudent exercise of planning for future growth...This project puts a disproportionate impact on local residents, infrastructure, economy, and educational resources."

MBP Brewer mentions the East Harlem Rezoning and the Inwood rezoning which covers 69 and 62 square blocks, respectively. This project is approximately 40% of the size of these rezonings in just 3 square blocks. MBP Brewer said, "Both the East Harlem and Inwood rezonings led to commitments from the City in the amount of approximately \$300 to \$500 million in investments in infrastructure, housing preservation, open space, schools and other elements essential to a neighborhood's high quality of life." The City has not committed any investment to the Central Harlem community around this proposal to ensure a high quality of life for our community.

CB10 mentioned in their opposition recommendations to this project, that it is completely out of scale for a residential community. George Janes, the respected Urban Planner said of this proposed project, that this level of infill for a residential community is "extraordinary". CB10 also mentions racial displacement in their NO recommendation comments. As you know, racial displacement caused by upzonings have led Public Advocate Jumaane Williams to introduce a bill that would mandate the City conduct a racial impact study as part of the EIS in the ULURP process.

Continued

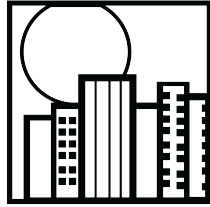

Lenox Terrace Association of Concerned Tenants
www.LTACT.org

S. Washington – LT-ACT
Public Comments
Page 2

If not rezoned, Olnick has threatened that it will build as-of right, without including affordable housing as part of their as-of right build. We maintain, that ANY development in the City, including as-of right, should include mandatory inclusionary housing. That developers don't get to threaten the City or communities to get what they want. Developers must understand their role as community partners and, if necessary have that role codified into law, to fulfill their role as good community citizens. That includes MIH as part of ANY build in this City.

It is understood that development is needed in the city, but we can create livable infill within Harlem and at Lenox Terrace that sustains a positive quality of life for the community. That zoning for Lenox Terrace should retain a contextual residential zoning with MIH.

Each community is told that development is important to bringing in jobs, taxes and money into a community. We can bring in jobs, additional taxes, and money into our communities without destroying our neighborhoods and the quality of life for our communities.

There is a feeling in the city sometimes that communities can absorb any amount of development. That is not true. Each community reaches a tipping point of what is livable and sustains a livable quality of life.

We urge the Council to accept the disapproval recommendations of CB10 and MBP Gale Brewer and vote no on the proposed R8 rezoning request before you. Thank you.

Savanna Washington
Vice-President – LT-ACT

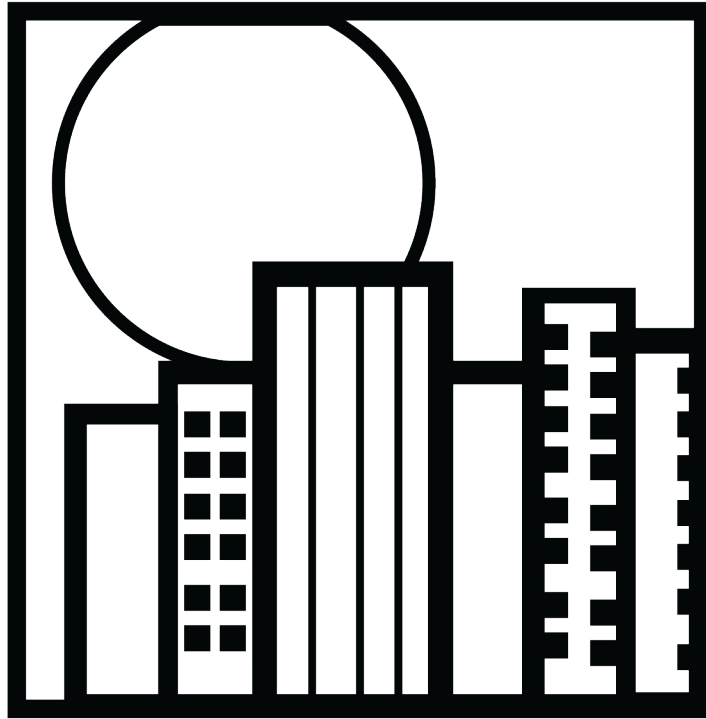

Lenox Terrace Association of Concerned Tenants
www.LTACT.org

**Opposition to proposed Olnick
Commercial Rezoning at Lenox Terrace**

**Lenox Terrace Association of Concerned Tenants
(LT-ACT)**

September 12, 2019

The Honorable Gale A. Brewer
Manhattan Borough President
One Center Street, 19th Floor South
New York, NY 10007

Dear Borough President:

On behalf of the Lenox Terrace Association of Concerned Tenants (LT-ACT), I would like to thank you for your leadership in support for tenants at Lenox Terrace.

As you know, LT-ACT has been opposed to the Olnick Organization's plan to rezone the Lenox Terrace property from a residential R7-2 to a commercial zoning C6-2 since the plan was introduced more than 10-years ago—it is a scary harbinger of developer-driven rezonings ahead of a community-driven plan for Central Harlem.

The proposed redevelopment that would take an estimated ten years is an infill of an additional five buildings, upwards of 28 stories, between the existing six lower rise buildings. The development would more than double the number of residents in this three-square-block area with an additional 1600 apartments. We are also concerned that these new luxury buildings would further degrade the quality of affordable housing in Lenox Terrace.

The requested C6-2 zoning is the same zoning as downtown Brooklyn and even larger than Bronx Terminal Market—imagine a Bronx Terminal market inside Lenox Terrace! The change in zoning would allow for neighborhood-altering mega-structures that would threaten to put an unsustainable burden on community resources, including the already dangerously overcrowded and narrow subway stop at 135th Street and Harlem Hospital.

The Olnick Organization intends to build as densely and as high as they can to maximize profit with no regard to the impact on the community. Together, we must prevent this egregious project from moving forward. We ask that you VOTE NO to this plan.

Sincerely,



Lenn Shebar
President
LT-ACT

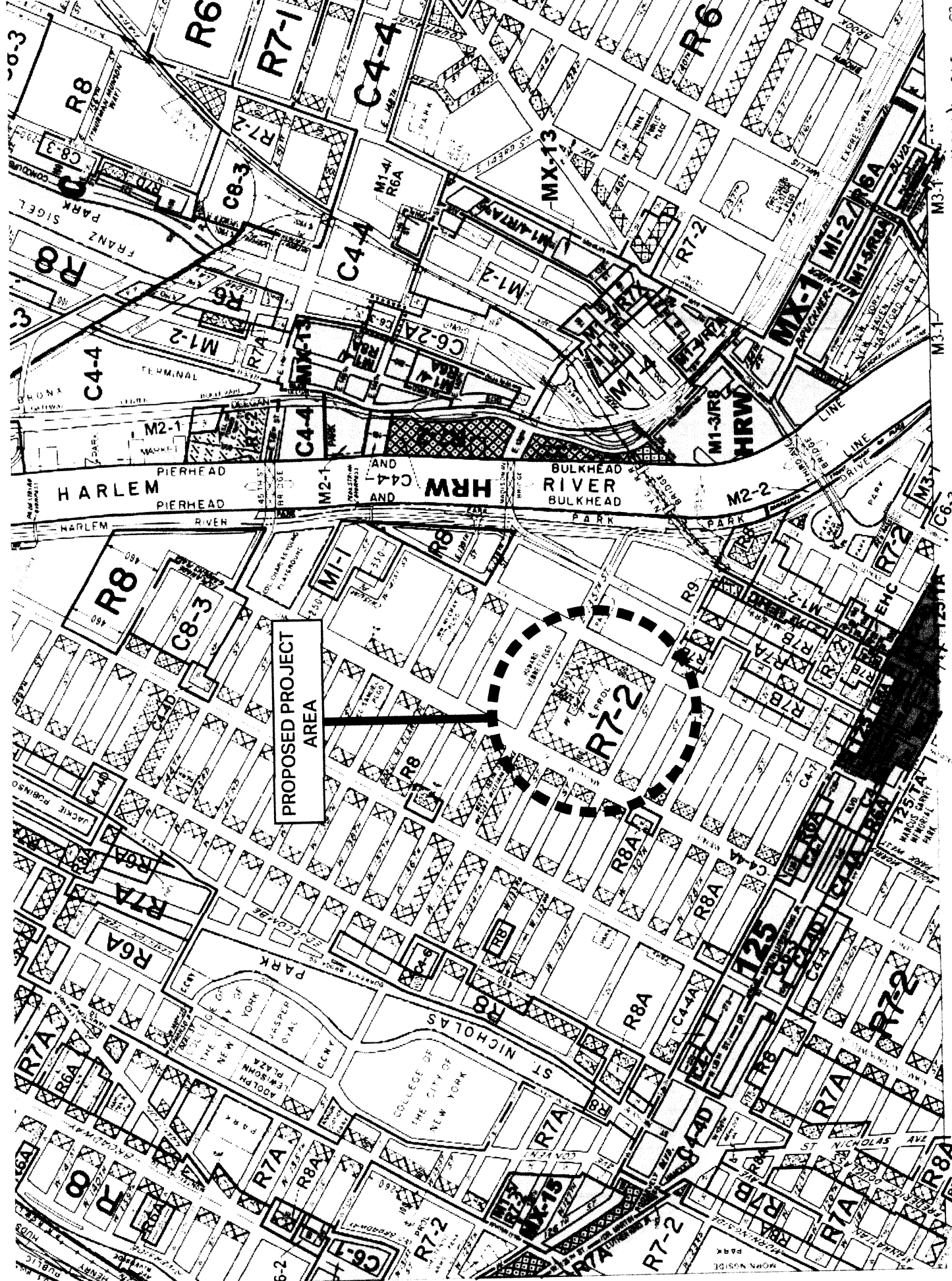

PROPOSED PROJECT AREA

C1-1 C1-2 C1-3 X-C1-4 C1-5 C2-1
 NOTE: Where no dimensions are shown for zoning districts or boundaries appear on the 2015 City of New York Zoning Resolution, Chapter 24, Article 24-01, Section 24-01.1.



MMU

CHAIR
Budget & Revenue

COMMITTEE MEMBER
Codes
Finance
Health
Rules
Transportation

OFFICE OF NEW YORK
STATE SENATOR



BRIAN A. BENJAMIN
Senator, 30th District

DISTRICT OFFICE
(212) 222-7315
163 West 125th Street
Suite 912
New York, NY 10027

ALBANY OFFICE
(518) 455-2441
Legislative Office Building
Suite 917
Albany, New York 12247

September 19, 2019

Dear Community Board 10,

I am writing this letter of support for the tenants of Lenox Terrace and the Lenox Terrace Association of Concerned Tenants (LT-ACT) in their demonstration against the proposed zoning changes in their district.

In their rightful concerns, the constituents of this jurisdiction reached out to my office regarding the proposed change and I, as their duly elected State Senator, support their stance. The reconstructing of this zone will be more problematic than beneficial. In changing the property from a residential R7-2 zone to a C6-2 commercial zone, the residents at Lenox Terrace and those surrounding, will be greatly impacted.

This zoning change will without a doubt, negatively affect the large senior population in this area, many of which already seek services from our office. The project will increase the strain that is already upon them through possible displacement, worsened air quality, traffic and congestion, noise quality, and potentially impede access to the most frequented hospital in Harlem, Harlem Hospital.

Given the insurmountable list of negatives of this proposed rezoning, I, along with the residents of the Lenox Terrace property, believe that, residential and commercial enhancements can be made to this area without a rezoning. It is evident that this can be achieved, as our office strives daily to make sure that the quality of life in this district is up to par.

Please feel free to reach out to me with any questions or concerns that you may have at (212) 222.7315.

Sincerely,

Brian A. Benjamin

Brian A. Benjamin

DAP STRATEGIES, LLC

October 17, 2019

Hon. Cecily Harris

Chair

Manhattan Community Board 10

215 W 125 Street, 4th fl.

NY, NY 10027

Hon. Lisa Downing

Chair, Land Use

Dear Chairs:

I proudly write this letter in support of the tenants of Lenox Terrace and their opposition to the Olnick Organization's commercial rezoning proposal for Lenox Terrace.

This precedent setting rezoning proposal must be halted. As a community leader, I urge you to not be complicit in this dangerous rezoning change that will escalate rents, erode both culture and sense of community.

The proposed towers and "destination" retail would threaten to put an unsustainable burden on community resources, including Harlem Hospital and the already dangerously overcrowded subway stop at 135th Street. Construction issues would include impeded hospital access because of additional trucks, traffic, noise, worsening air quality in a neighborhood with a large senior population and elevated rates of asthma, among a myriad of additional concerns.

I have proudly lived at Lenox Terrace since 1972, and my brother and mother live there as well and hope that future generations will have the opportunity to enjoy this special sense of community.

I urge the Land Use Committee and the entire Board to vote No.

Sincerely

Governor David A. Paterson

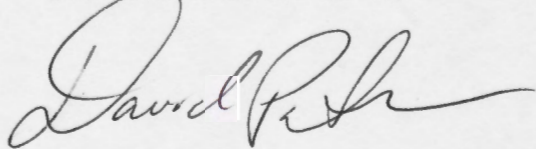



CITY OF NEW YORK
MANHATTAN COMMUNITY BOARD 10
215 West 125th Street, 4th Floor—New York, NY 10027
T: 212-749-3105 F: 212-662-4215

HENRIETTA LYLE
Chairperson

ANDREW LASSALLE
District Manager

June 26th, 2015,

Ms. Delsenia Glover
President
Lenox Terrace Association of Concerned Tenants
PO Box 822
Lincolnton Station
New York, NY 10027

Dear Ms. Glover:

This letter is provided to notify the Lenox Terrace Association of Concerned Tenants (LT-ACT), New York City Department of City Planning (DCP), the Olnick Organization and all other interested parties that Manhattan Community Board 10 understands the Olnick Organization plans to propose a commercial rezoning of their property, known as Lenox Terrace (Lenox Avenue between West 132nd Street and West 135th Street), to the New York City Department of City Planning.

This rezoning proposal will modify the current zoning from residential to commercial allowing for increased residential density, retail space and green space. It will include a proposal for 80% of the units to be market rate and 20% to be affordable housing.

A presentation was made by the Lenox Terrace Association of Concerned Tenants (LT-ACT) at the May 21st Land Use and Landmarks Committee Meeting expressing opposition to the rezoning. On June 19th, 2015, a presentation of the rezoning proposal was made by the Olnick Organization at the Land Use and Landmarks Committee Meeting.

After discussion and deliberation, Community Board 10 supports the Lenox Terrace Association of Concerned Tenants (LT-ACT) opposition to the Olnick Organization commercial rezoning as proposed.

While we are open to further discussion and a review of modified proposals from the Olnick Organization, we emphasize our belief that affordability extends beyond 80% market rate and 20% affordable units; that the Olnick Organization must address outstanding concerns expressed by its current residents including: rodent and pest control, noise during renovations, accessibility, rent collection policy and; that the proposal must include a commitment to the history, culture and community of Harlem.

Thank you for your time and consideration of this matter.

Sincerely,

Henrietta Lyle

Henrietta Lyle
Chairperson
Community Board 10

Brian Benjamin

Brian Benjamin
Chairperson
Land Use Committee

Lenox Terrace Tenants' Association Opposes Plan to Bring Overscale Development to Central Harlem

The Lenox Terrace Association of Concerned Tenants (LT-ACT), which represents the residents of the Lenox Terrace apartment complex in central Harlem, strongly opposes the proposed development plan as it currently stands, put forth by the Olnick Organization, landlords of Lenox Terrace. We are asking Community Board 10 to **vote "NO"** to their request to rezone the property to a **Commercial Zoning District C6-2 designation**.

Olnick's proposed development of building five new 28-story luxury tower rentals surrounding existing Lenox Terrace apartments between 132nd and 135th street from Malcolm X Boulevard to Fifth Avenue, requires approval to rezone the property from its **current Residential Zoning District R7-2 with a C-1 commercial overlay**, to a Commercial Zoning District C6-2 designation.

Areas with a commercial C6-2 designation are normally found in the central business district and regional commercial centers of cities, such as the 34th street corridor that travels through **Herald Square, Times Square**, and the **Bronx Shopping Terminal on 149th Street**. They are **not found in residential areas** such as the current Lenox Terrace property, nor does any other similar commercial zoning exist in the surrounding Community Board 10 Central Harlem area, except on 125th Street.

By allowing Lenox Terrace to become a Commercial Zoning District C6-2 property, which would open the door for the development of overscale retail stores, a cascade of negative impacts will affect the surrounding Central Harlem Community, especially with regards to Parks and Recreation.

The proposed rezoning would lead to a huge jump in population in the area—about 2,000 new apartments, which Olnick's own estimates would bring 3,500 new people. In other words, the population of Lenox Terrace would basically double. (From [DSOW](#).) This would put substantial pressure on the Hansborough Recreation Center as well as parks and playgrounds in the immediate area, which serves youth, young adult, adult and senior populations.

The rezoning would also drastically increase the potential development of the land on which the Hansborough Recreation Center, and the Kennedy Center— which primarily serves the senior population of the neighborhood— currently stands. This would lead to pressure on both City Parks and Recreation and Catholic Charities to either develop those properties or sell them to developers, which would further decrease space and programs for recreation in the area.

Rather than improving the districts parks and recreational facilities, Community Board 10 would, by voting yes to Olnick's request to be rezoned as a C6-2 property, inadvertently pave the way for a decrease in space, programs, and recreation in the Central Harlem area, as well as overburden the capacity of city workers to maintain the cleanliness, sanitation, and aesthetics of the districts' parks due to population overcrowding.

To be clear, LT-ACT understands and accepts that the Olnick Organization has the right to build on their property without the zoning change. **The current Residential Zoning District R7-2, with a very limited C-1 commercial overlay, allows for smaller-scale neighborhood retail development.** As an example, Park West Village, an apartment complex between 97th and 100 streets on Columbus Avenue, was able to develop a series of new hi-rise buildings next to the older, traditional, group of buildings, along with new commercial retail stores. This new development was built with the exact same R7-2 zoning as Lenox Terrace and, virtually, all of Harlem.

The current Residential Zoning District R7-2, with a very limited C-1 commercial overlay, would also allow--under the current "Housing New York: Zoning for Quality and Affordability" modifications of 2015--limited height and floor area bonuses for providing Affordable Senior Housing and Long Term Care.

While Olnick's renderings of their proposed development depicts restaurants, cafes, and grocery stores, a Commercial Zoning District C6-2 designation would set a precedent allowing for future overscale commercial development of the property and the area, such as Target and Home Depot retail stores. Olnick's past and current behavior with residents of Lenox Terrace gives little confidence that they will not, in the future, invite to the property and neighborhood large, overscale, commercial business.

Olnick is simultaneously the defendant in a class-action lawsuit by current Lenox Terrace residential tenants for illegally taking units out of rent stabilization while claiming a tax abatement for affordable housing. They made headlines again in July of 2019 for sending lease renewals to tenants with unlawfully high rent increases — in some cases, more than 30 times the legal maximum.

Additionally, the basements, laundry rooms, and many apartments in current Lenox Terrace buildings have **asbestos-vinyl tile flooring** that are now friable, due to cracks and breaks in the tile. This is a ticking time-bomb of a health crisis that Olnick has not adequately addressed.

LT-ACT has been against the commercial rezoning plan since its inception. Councilmember Perkins and Manhattan Borough President Brewer have publicly stated that they, too, are against this gargantuan plan. As Lenn Shebar, President of the LT-ACT has said, "The thought of 8 to 10+ years of continuous disruptive construction to the existing tenants is mind-boggling and frightful. We ask Community Board 10, all officials, and the mayor to vote against this dehumanizing force of commerce-minded urban planning and put community stability first."

TAKEROOT JUSTICE

Daniel Carpenter-Gold, Staff Attorney

After a quick initial review of Olnick's Draft EIS following is a summary:

Olnick is asking to be allowed to put a giant shopping mall in the middle of Lenox Terrace, and trying to paper it over with pretty renderings of coffee shops. I also attended the CPC's review session, where the Commissioners asked a number of critical questions, including why Olnick is requesting a C6 rezoning when a R8 would give it what it needs for the proposed project; the presenter did not have an answer for that.

1. The DEIS admits that there *will* be destination retail at Lenox Terrace if the rezoning goes through. But it then completely ignores this fact, and even gives false information, to avoid the obvious conclusion that this would be a huge change to the area.

- a. On p.2-13, the DEIS says, "The proposed commercial use is anticipated to include a mix of local and destination retail tenants." It also says that, "For the purposes of this EIS, it is currently anticipated that the retail mix could be split evenly between" local and destination retail—but this is very vague and does *not* guarantee that there won't be a larger share of destination retail.
- b. Because the DEIS assumes that at least half the space will include destination retail, the rest of the DEIS should reflect that, but it doesn't. The description of the project zoning space says that all new commercial space will be in Use Group 6, which includes only local-retail uses (table 1- 3). Similarly, the neighborhood-character chapter says that the rezoning "would not add uses not already present within the rezoning area and surrounding study area" (p.18-5), which is also wrong—there are no department stores in the area, and there are only two slivers of land that are zoned to allow department stores (and that only because they are zoned for manufacturing) on Park between 128th and 131st (Figure 2-2).
- c. Chillingly, the DEIS at one point justifies its decision to ignore the impact of new retail by saying that "Harlem is in the midst of a retail transformation from small-format retailers to large-format stores." (p.3-24). In other words, whatever new "large-format" department stores are put in at Lenox Terrace won't make a difference because all of Harlem will look like 125th St. soon.

2. Along the same lines, the DEIS downplays the impact of the rezoning on the residential side by using the residential density in the current site plans rather than the actual residential density that would be allowed by the rezoning. It provides two excuses for this: (1) Olnick may unilaterally declare that it won't build larger than the density in the site plan, and (2) building past that density would be difficult because of other zoning and building restrictions. Neither one of these holds water—Olnick has not actually committed itself to the Restrictive Declaration, and even if it were true that further density is impossible

without zoning waivers, it's a lot easier to get small zoning waivers for things like setbacks and minimum distance between buildings than it is to rezone an area.

- d. The DEIS assumes that the build will be to an FAR of 5.61, despite the fact that the maximum residential FAR in the requested rezoning is 7.2 (for example, at p.8-10). This impacts not just the amount of new buildings, but also the impact on population of the area, demographics of the area, traffic, etc.
- e. The DEIS says only that Olnick "is expected to enter into a Restrictive Declaration" limiting it to the build indicated in the Site Plan (p.1-11). This doesn't say that Olnick is committed to the declaration, or even that Olnick has plans to make the declaration—only that DCP *thinks* that they will. But then the rest of the analyses assume that the Declaration is in place and there will be no build past a 5.61 FAR.
- f. The DEIS also argues that building to the full density allowed would be difficult because of zoning, setback, and parking restrictions (p.1-11) but getting waivers of those zoning restrictions is a lot easier than getting the rezoning in the first place, so it is not a very strong protection.

III. Finally, the DEIS strengthens the case for preserving Lenox Terrace as a cultural/historical site. The Landmarks Preservation Committee found it to be eligible for inclusion on the National Register of Historic Places, and the DEIS notes that it was the residence of a number of important historical and cultural figures. The DEIS itself finds that tearing down the commercial properties on the site would damage historical resources. The DEIS inexplicably then finds that there are no significant impacts on historical resources from the project.

- g. The LPC says that Lenox Terrace "appears to be National Register eligible, for its cultural associations with prominent African Americans in the Harlem community." (Appx. B).
- h. Because of the LPC's designation, the DEIS finds that "the demolition of the one-story structures on the proposed development site would result in a significant adverse impact to historic resources" (p.7-7).
- i. The new buildings would also substantially change the current site layout, especially by building over the circular driveways in front of 470 Malcolm X and 40 W. 135th and putting enormous buildings right at the street (see Figure 1-5, for example). And of course plopping big box department stores in the middle of Lenox Terrace is not consistent with its history or site plan.
- j. Despite all this, the DEIS says that the rezoning "would not be anticipated to have any significant adverse impacts on historic and cultural resources in the study area" (7-9) which is untrue.

##

Lenox Terrace DEIS Transportation Chapter

Background Development

The CEQR Methodology includes a method for identifying the impacts of other projects that are already on the books for development within the 'study area'. There are 42 of them within the ½ mile radius that has been defined for this project. The impact of Lenox Terrace is incremental over these 'background' developments. It means that each successive developer that comes into the area will have to bear more and more of the cost of mitigation of transportation impacts as each development pushes the demands on the systems more and more over capacity – one reason why the Olmicks might like to get this approved sooner rather than later.

Detailed Analysis of Future Conditions

Future conditions were modeled for the 11 intersections that were indicated through the Levels 1 and 2 screening process. The approach was to evaluate the current level of service (LOS) with extensive counts, increase the volumes by the assumed increases caused by background development and then increase volumes again by the assumed increase in volumes caused by the Lenox Terrace Development. Those intersections pushed over into the unacceptable LOS category by the incremental difference between the background development and the Lenox Terrace development must be mitigated by Lenox Terrace.

It is not clear whether the impacts of background development were specifically allocated to individual streets and intersections by block, or whether the assumed percentage increase in volumes were simply applied across the board to all links and intersections. It might matter if background developments are clustered; creating bottlenecks in certain locations. It does not appear that a microsimulation of traffic in the neighborhood has been done.

Subway – An additional 1300-1600 unique daily subway trips are projected from the project. According to the DEIS the subway station at 135th /Lenox was screened out for additional analysis of a) stations circulation – (basically adequacy of access and platforms) and b) line haul. The more detailed analysis concluded that there was no potential for significant adverse impacts. Using Times Square as a "maximum point load" to analyze the impact of these trips disguises the extreme and unsupportable impact to the 135th /Lenox Ave. subway.

Recommendations:

A Build Out Analysis & Study of Cumulative Traffic Impacts

Because DEIS analyses are done on an incremental basis - one project at a time – CB10, the Manhattan Borough President's Office, and the City Councilmember's office are not getting any information about the cumulative effects multiple projects are having or will have on the community over time.

Given the rapid rate of growth in this neighborhood, the Manhattan Borough President, The City Councilmember's Office, and Community Board 10 may want to consider a more detailed build out analysis and study of cumulative traffic impacts on the neighborhood as well as a plan to address mobility and safety issues. It would be a better approach than the patchwork – first developer in the door – approach to build out and congestion given the intensified development within Central Harlem. West Harlem/CB9 took such an approach several years ago with their community wide zoning approach.

Dr. Misa Dayson
Transcript of comments at
Community Board 10 Land Use Subcommittee

September 19, 2019

Building Maintenance & Security Issues at Lenox Terrace

Some of the building issues that Olnick is proposing in their presentation in their [Tenant Benefit Agreement] section as upgrades are basic building issues. We at LT-ACT maintain that, what they are proposing as upgrades are basic building maintenance issues and should NOT be a part of any Tenant Benefit Agreement. We also maintain that they are cosmetic features that don't address outstanding issues that Olnick has willfully neglected for the last many years.

Unrenovated Apartments/Asbestos Tiles

In each building's basement and laundry room, the tiling in all of the apartments are made from asbestos vinyl tile flooring. This generally should be safe, until it breaks or cracks. When it breaks or cracks it becomes "friable" which means it becomes breathable, which means it's a serious health concern. Many apartments have these vinyl asbestos tiles where they have begun to crack. You can go into every building in Lenox Terrace in the laundry rooms, the tiles have also begun to crack and break. Olnick has not addressed this in a comprehensive way. So that's not part of what they're saying in terms of upgrades.

Plumbing issues

Tenants have complained for years about plumbing issues. This has resulted in the ceilings falling in in people's kitchens and bathrooms and not being repaired consistently.

This is related to an ad hoc approach to renovation. Our plumbing is over 60 years old and when they're installing dishwashers, it puts a strain on infrastructure. That's not being addressed.

Electric issues

Our electrical panels in the apartments are not uniform. Some apartments have circuit breakers, others have fuse boxes. Many tenants throughout the building have talked about their electricity going out when there's a renovation happening because [Olnick's] not maintaining uniform electrical panels in the building.

The sockets are also very old. Many tenants sockets depress into the walls which causes a health hazard. Also some of the wiring is faulty. You'll have a three-pronged socket where people plug in their air conditioners but they are sockets that are made of 15 amps and they should be 30 amps. But the 30 amp sockets only have two-pronged sockets. This isn't being addressed.

Green Space Proposal

We want to speak to the "Green Space Proposal" that Lenox Terrace has featured. We're asking questions about security. Because currently Lenox Terrace has taken out most of the benches that existed on the property due to security concerns. So if you're going to expand green space we're asking what are you're going to do about security? Currently security guards at Lenox Terrace are being used to distribute flyers for Olnick. They're also being used to cover for doormen. We have six buildings. Security is supposed to be monitoring the hallways and the stairwells, they're also supposed to be

monitoring the property, but:

- From 4-7 pm there are two (2) guards covering six buildings as well as covering our doormen breaks as well as distributing flyers.
- From 7-9 pm, there are three (3) guards
- From 9pm -2 am, four (4) guards
- From 2-5 am two (2) guards
- From 5-7 am, one (1) guard

Our concern is that if you're going to put in all of this greenspace and you have this kind of security on the property, we're not feeling safe.

One of the presenters said Lenox Terrace was asked how can we bring Lenox Terrace into the 21st century when they weren't taking care of the buildings.

Air Monitoring

Speaking to the air monitoring – WeACT maintains that air monitors can be installed now to set a baseline before construction that we actually understand what the health impacts could be once construction starts.

##

Lenox Terrace Association of Concerned Tenants (LT-ACT)

Sept. 2019
(Copy of Eblast to members)



UPDATES ON OLNICK'S PROPOSED REZONING

Plan enters Uniform Land Use Review Process (ULURP)

On August 26, 2019 Olnick went before the NY City Planning Commission (CPC) to present their Draft Environmental Impact Statement (DEIS). The DEIS was approved by the CPC to begin the ULURP process - the Uniform Land Use Review Process. The process takes approximately six months to see whether or not the proposed rezoning will go through.

LT-ACT strongly opposes the proposed rezoning by Olnick of Lenox Terrace from residential zoning to commercial zoning (zoning akin to a regional shopping center).

In addition to adding overscale retail, Olnick's proposed development includes building five new 28-story luxury towers. The proposed plan requires approval from Community Board 10, Gale Brewer, and Bill Perkin's office to succeed. Gale Brewer and Bill Perkin's office have publicly stated they are against the current proposed plan.

Olnick proposes to rezone the property from its current Residential Zoning District R7-2 with a C-1 commercial overlay, to a Commercial Zoning District C6-2 designation.

Areas with a commercial C6-2 designation are normally found in the **central business district and regional commercial centers like the Bronx**

Terminal Market and areas such as the 34th Street corridor that travels through **Herald Square**, and **Times Square. They are not found in residential areas** such as the current Lenox Terrace property, nor does any other similar commercial zoning exist in the surrounding Community Board 10 Central Harlem area, except on 125th Street.

The proposed rezoning would lead to a huge jump in population in the area—about 1700 new apartments, which Olnick's own estimates would bring in 3,500 new people. **In other words, the population of Lenox Terrace would basically double.** This would put substantial pressure on the mass transit system. Adding approximately 1,600 peak-time trips to the 135th Street, 2/3 train station.

To be clear, Lenox Terrace's **current Residential Zoning District R7-2**, with a very limited C1 commercial overlay, **allows for smaller-scale neighborhood retail development and reasonable residential infill.** As one urban planner stated, Olnick's current proposal request is "extraordinary" for a residential community.

Upcoming CB10 Meetings

Land Use Subcommittee

First Meeting:
Thurs. – Sept. 19th
6:30 pm
Touro College
231 W 124th St.

Second Meeting:
Thurs. – Oct. 17th
6:30 pm
Location: TBA
(Land Use Votes on Proposed Rezoning)

General Board Meeting

Wed. - Nov. 6
6:00 pm
163 W. 125th Street
2nd Floor Art Gallery
(CB10 Votes on Proposed Rezoning)

ALL TENANTS ARE ENCOURAGED TO ATTEND!

PRESIDENT'S LETTER



Hello Members of LT-ACT,

I have a number of updates to share with you, with more information to be included in an upcoming newsletter. The most urgent news items to bring to your attention is that Olnick's Environmental Impact Study (EIS) for their redevelopment plan was recently certified by the city planning commission, and the public review process (ULURP) has begun. We need you to join us in our fight to stop this plan of overdevelopment!

COME OUT TO SAY "NO" TO COMMERCIAL REZONING!!

There are several important meetings that all tenants should plan to attend. The first is:

Land Use Committee Meeting

September 19, 2019 @ 6:30PM
Touro College 231 W 124th Street 2nd fl

Olnick will be presenting their proposal to rezone Lenox Terrace in order to develop five new skyscrapers and overscale commercial stores. LT-ACT President Lenn Shebar, Vice President Savanna Washington, and LT-ACT Executive Committee members will also make presentations to counter Olnick's proposal.

CB10's Land Use Committee will hold a **second meeting and vote on Thursday, October 17th**. This is an extremely crucial vote and all tenants are advised to attend!

The entire Community Board will vote on the proposal on November 6th. Again, all tenants are encouraged to attend!

Recently, a few members of the Executive Committee and I met with Manhattan Borough President Gale Brewer to discuss the next steps in our fight against Olnick's effort to change the zoning of Lenox Terrace. Happily, the Borough President has always been ardently against the over-scale

development and stalwart in her support of our goals.

We also met with the Chair of Community Board 10's Land Use Committee, Lisa Downing and former Chair, Stanley Gleaton to discuss expectations for this week's Land Use Committee meeting.

On another note, I am also proud to share with you that LT-ACT's new Upgrades Committee and the Building, Grounds & Security Committee have initiated a series of urgent demands to management coupled with subsequent nudging, and it has successfully resulted in getting Olnick to proceed with a previous commitment to renovating all of the laundry rooms on the complex.

Since I became President of LT-ACT this past April, it has been a whirlwind challenge, working to incorporate Vice President Savanna Washington's and my management style into the organization and put new systems in place. We have also been moving at an accelerated pace to ensure that we are prepared to present our case against the Olnick Organization's proposed redevelopment project and respond to the recent onslaught of media attention.

This will be it for now. But, as I stated previously, I will have a lot more to share with you in the newsletter. It will be out sometime in October. If you would like to reach me, or would like to volunteer, or have matters of concern, please send an email to info@ltact.org.

Thanks & best,

Lenn Shebar
President, LT-ACT

FOR IMMEDIATE RELEASE September 17, 2019
Contact: Loretta Kane (917-410-7242 or
loretta@caminopr.com)

Lenox Terrace Tenants' Association Opposes Plan to Bring Overscale Development to Central Harlem

NEW YORK — The Lenox Terrace Association of Concerned Tenants (LT-ACT), which represents the residents of the Lenox Terrace apartment complex in central Harlem, strongly opposes rezoning that would allow luxury towers and overscale retail stores to be constructed on the historic site. The rezoning, which was certified on August 28 for the Uniform Land Use Review Procedure (ULURP), would allow developers to build “destination retail” stores, like Target or Walmart, for the first time in the neighborhood, while also building five new 28-story towers in Lenox Terrace, more than doubling the density within the complex.

“The tenants association has been against the commercial rezoning plan since its inception. Councilmember Perkins, Manhattan Borough President Brewer and community groups have publicly stated that they, too, are against this gargantuan plan,” said Lenn Shebar, President of LT-ACT. “The thought of eight to 10+ years of continuous disruptive construction to the existing tenants is mind-boggling and frightful. We ask all officials and the mayor to vote against this dehumanizing force of commerce-minded urban planning and put community stability first.”

The Lenox Terrace site has enormous cultural and historical significance as a center of African-American culture. Since its construction in the mid-20th century, as one of the first apartment complexes designed for middle-income Harlemites, Lenox Terrace has been home to a number of key artistic and political figures. Alex Haley, Charles Mingus, former Gov. David Patterson and Rep. Charles Rangel reside or have resided at the complex, among others. For these reasons, the Lenox Terrace complex is eligible for registration on the state and national historic registries. The rezoning applicant and owner of the complex, the Olnick Organization, admits that the proposed changes would adversely impact culturally relevant buildings.

The Olnick Organization has asked the City to rezone Lenox Terrace to a C6-2 designation, which is “normally found in the central business district and regional commercial centers,” according to the City’s Zoning Resolution. No other similar zoning exists in the area, except on 125th Street, where a 2008 rezoning paved the way for massive high-rise infill and luxury retail.

The current residential zoning (R7-2), already allows for additional housing to be built within the existing complex, and even more development would be possible if the new buildings were used for affordable senior housing or long-term care. The complex also has commercial overlay zoning (C1-4) on its perimeter, allowing for small-scale retail and restaurants on three sides of the complex.

“You don’t see places like Target in the pretty renderings that the developer gave the City,” said Daniel Carpenter-Gold, a staff attorney at TakeRoot Justice, which represents LT-ACT. “But make no mistake, that’s what they’re going for here. If all they

wanted was coffee shops and bookstores, they wouldn't need this ridiculous commercial upzoning.”

The new zoning designation would also allow a large increase in luxury housing within Lenox Terrace. Olnick claims that 1,600 new units will result from the rezoning — already doubling the Lenox Terrace population — and it would allow for far more to be built in the future. The new population will increase pressure on local services, including already overcrowded subway and bus lines, and is expected to push area rents higher.

Olnick is simultaneously the defendant in a class-action lawsuit by current Lenox Terrace residential tenants for illegally taking units out of rent stabilization while claiming a tax abatement for affordable housing. The owners made headlines again in July for sending lease renewals to tenants with unlawfully high rent increases — in some cases, more than 30 times the legal maximum.

Additionally, residents have reported that the basements, laundry rooms, and many apartments in current Lenox Terrace buildings have asbestos-vinyl tile flooring that are now friable, due to cracks and breaks in the tile. They are concerned that this is a ticking time-bomb of a health crisis that Olnick has not adequately addressed.

“The residents of Lenox Terrace want responsible development within the complex and within Central Harlem,” said Savanna Washington, vice president of LT-ACT. “We are a residential community, not 34th Street north. As State Sen. Brian Benjamin said at our Town Hall meeting last year, ‘A project of this scale is generally done on vacant land, not as infill where tenants already live.’”

The Land Use Subcommittee of Manhattan Community Board 10 will hold a public meeting to discuss the proposed rezoning this Thursday, September 19, at 6:30pm, at 215 West 125th St., 3rd Floor.

#

TakeRoot Justice (formerly the Community Development Project) provides legal, participatory research and policy support to strengthen the work of grassroots and community groups in New York City to support community-based partners to dismantle racial, economic and social oppression.

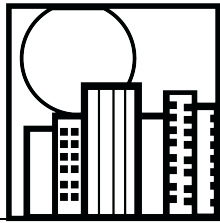

LENOX TERRACE ASSOCIATION OF CONCERNED TENANTS – LT-ACT

LT-ACT Town Hall Summary

“I stand with the tenants. I stood with the tenants when you came before me when I was Chair of the Land Use Committee of Community Board 10 and I stand with the tenants now as your State Senator. I want to be very clear about that...I don’t know what’s on this paper [The statement Olnick put out on Feb. 1, 2018] but I’m telling you with my own mouth, I stand with the tenants, period – point blank.”

**State Senator Brian Benjamin – Feb. 1, 2018
at the LT-ACT Town Hall Meeting**

“[Olnick’s rezoning proposal] is a very serious situation. As Lenox Terrace goes, so goes the rest of the community. This is a precedent setting move that’s taking place that has to be stopped, nipped in the bud. Otherwise it will flow like lava from a volcano and the victimization of it will be intolerable...It has to be one for all and all for one...I say NO!”

**Bill Perkins, Councilmember – Feb. 1, 2018
at the LT-ACT Town Hall Meeting**

On Thursday, February 1st, State Senator Brian Benjamin, Councilmember Bill Perkins, and Athena Moore, Manhattan Borough President Gale Brewer’s Director of the Northern Manhattan Office, spoke to the packed LT-ACT Town Hall meeting giving their complete support to the residents. Brian Benjamin gave a brief summary of the Uniform Land Use Review Procedure (ULURP) Process – which is the process through which Olnick will have to take to try to get the zoning changed at the property from residential to commercial and begin any building process. (We will post the ULURP process on the website in the next few days for residents.)

Each representative spoke about the importance of residents attending the Environmental Scoping hearing this Thursday, Feb. 8. This begins the process and it’s important for the Department of City Planning to hear from the residents about how this project will impact the community. (This is NOT a forum to share maintenance problems, only how proposed large-scale development would impact you and the community.)

As Bill Perkins said at the meeting, “Defeating this rezoning proposal is going to be a process that will take some time. We have to stay committed and to stay the course.” Brian Benjamin and Bill Perkins both offered to send buses to transport tenants to the meeting at Spector Hall.

Lenox Terrace Public Scoping Hearing Before the NYC Dept. of City Planning

Feb. 8 – Thursday @ 6:00 pm
Spector Hall, 22 Reade St.

Public comments on the proposed rezoning
by Olnick before the NYC Dept. of City Planning

Come and let your voice be heard!

Sign up for buses

to and from the hearing on
Reade St.

Look for sign up sheets in each
lobby to sign up for buses!

Buses will be leaving at
5pm sharp

Thursday, 2/8 in front of
Bethel AME Church
60 W. 132nd St.

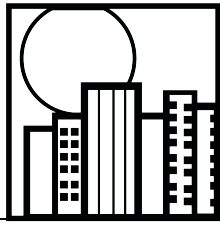

LENOX TERRACE ASSOCIATION OF CONCERNED TENANTS – LT-ACT

Olnick released a handout on the day of our Emergency Town Hall meeting that had several misstatements. Here is the correct information:

- **State Senator Brian Benjamin & Councilmember Bill Perkins stand with the tenants** against the previous landlord rezoning proposal several years ago and the current rezoning proposal. They were unambiguous about this at the Town Hall Meeting.
- **Vote by Tenants on Re-zoning:** Our last survey/vote (2013) by tenants was overwhelmingly against the re-zoning, 75% to 25%.
- **Tenants Benefits Agreement** – The landlord has said they will update the older kitchens and bathrooms as a "Tenant Benefit." This work in **NOT a "Tenant Benefit," it is their responsibility as landlords NOW - These are on-going maintenance items**, that a responsible landlord would be taking care of under the course of normal business, including updating the electrical work to today's code.
- **Commercial Rezoning in a Residential Area:** Olnick claims that commercial rezoning is a, "commonly used mechanism to both allow for and place limitations on the new development." **Commercial rezoning in a residential area is NOT so commonly used, and especially not in Central Harlem.** In this case, the rezoning to commercial would allow them to double the number apartments within the complex, which they cannot do under the current residential zoning. **Olnick can do responsible in-fill construction under the current residential zoning.**

**“A project of this scale is generally done on vacant land,
not as in-fill where tenants already live.”**

**State Senator Brian Benjamin
LT-ACT Town Hall Meeting
February 1, 2018**

As one long-time Lenox Terrace resident said at the meeting, “We will have to keep our windows closed for 9 years – I already have health issues, I won’t be able to live through this level of construction.”

LT-ACT FIGHTS FOR YOU!

Comparable As-Of Right Construction:

Park West Village

**Columbus between W. 97th-100th
East side of the street**

**Columbus Ave. between W. 97th-100th
Zoning: R7-2/C1-5**



From Daniel Carpenter-Gold, TakeRoot Justice:

The C1-5/R7-2 is very similar to the C1-4/R7-2 in Lenox Terrace. The main difference between a C1-4 and a C1-5 is parking: C1-5s generally don't have parking requirements, while C1-4s. But, the parking requirements are generally subject to waiver anyways—basically, a retail use in C1-4 that is <40,000 sq ft will generally not have a parking requirement in either a C1-4 or C1-5. And they can always put parking below ground (which is what happened for the residential parking at that development).

And it's very similar to Lenox Terrace also in that it's an old Urban Renewal site (brick buildings set back from Columbus) that was infilled with new residential and commercial development (glass buildings close to Columbus).

That's an excellent example of how as-of-right development could go at Lenox Terrace.





Statement for Zoning & Franchises Subcommittee re Lenox Terrace

To: The members of the Subcommittee for Zoning and Franchises

Re: Hearing 12 February 2019 regarding the application for rezoning of Lenox Terrace property by the Olnick Organization

From: Wendalyn Nichols, tenant, West 135th St.

Dear Committee Members,

I am a 17-year resident of Lenox Terrace. My late husband and I moved into one of the first apartments that was updated and – something that wasn't clear to us at the time – taken out of rent stabilization. For full disclosure, I am therefore one of the class of tenants eligible for compensation for rent overcharges following the settlement of the class action lawsuit against the Olnick organization.

My status as a member of the class provides context the reasons I do not believe the Olnick Organization acts in good faith. From the very beginning and throughout my tenancy, my experience of their actions towards their tenants and this community has been that they are disingenuous and cynical. They have waged a long war of attrition, using a combination of threats to current tenants about what they might just do "by right," attempts to get around New York laws, and slick promises to the transient population of newer tenants who come and go almost yearly and don't have a stake in this community as a community. I ask the city council to consider the track record these owners have in their behavior toward the community over time when determining how to hold them accountable for responsible behavior in the future.

They don't maintain the buildings they already have, and the "upgrades" are shoddy.

When we moved into our apartment in 2003, it was clear that Olnick was doing the minimum they could get away with in terms of updates - even new, the workmanship was shoddy. If I'd know then, I would have challenged the starting rent they charged, because the previous tenant's last rent was over \$1300 less than our rent, and there was simply no way the slapdash upgrade cost the landlord enough to qualify for that great of a difference, even with vacancy increases taken into account. The laminate counter in the kitchen didn't have enough support and pulled away from the walls almost immediately. The wood floors had the thinnest of sealant that quickly wore away, and the wood pieces were loose around the edges of rooms. The oven's temperature gauge quickly stopped working, but they won't replace an oven for that reason and the so-called repair person who came to look at the oven said all those models were like that. The refrigerator fan quit and was replaced with a part that the repair person said wasn't quite the exact one, but it would fit – and very soon afterwards it caught fire, and we were extremely lucky to have been up late that night to put the fire out. Door handle "chrome" has worn off. Tile in the shower keeps cracking and repairs are slapdash. Something is wrong with the electricity – light bulbs burn out quickly, cords get hot. I could say more: the point is that Olnick will cynically do the minimum to squeak by to call an apartment "upgraded" and they don't adequately maintain the apartments. So when they say that, as a sweetener in the redevelopment plan, they will upgrade all the apartments that have never been upgraded, a) they should have been doing this long since; b) the upgrades should be inspected by an independent third party to be sure they're to code; and c) before they're allowed to build more buildings, they should completely repair the ones they have, including the electrical systems and the water system that results in rusty water being a chronic issue.

They have allowed the blocks along the property to become derelict.

When we moved here, there were still stores along 5th Avenue, the Pan-Pan coffee shop was on the corner of 135th and Lenox, and all the store spaces along Lenox were occupied. Now almost all of the shops are gone from 5th; there's hardly anything apart from the Goodwill store to serve the community, and the derelict strip makes that side of the complex unsafe. When fires leveled Pan-Pan and now Mama's, these cafes have not been replaced. When the lease was up on the discount department store, it was shuttered. The Olnick organization is perfectly happy to allow the entire shopping infrastructure disappear, because they know it will help with leverage with the newer, transient tenants who want to have decent shopping in the neighborhood. The Olnicks could build that right now if they weren't trying to milk the maximum density they can get out of the space, and impact on the neighborhood be damned. They don't even make sure the sidewalk is shoveled along the stretches in front of the derelict spaces!

They use threatening tactics.

We have had flyers put under our doors with dire warnings from Olnick about what they could do by right, complete with pictures of what four buildings 200 feet each would look like, slapped onto the property. They say there will be no affordable units, no upgrades to existing units, no green space, no new amenities, little to no new retail, and no tenant benefits like community rooms. Well, that is believable. But here is the truth: This more than anything they have done shows their true colors. What they are saying is that we won't do any of these things that would be good for the tenants or the city unless you give us what we want with regard to rezoning. They actually *could* still do all those positive things without the rezoning; they simply *won't*, because it would cost them a bit more to do it. Cynical. Proof that they only pay lip service to the good of the community to the degree that they have to in order to meet the minimum letter of the law in terms of environmental impact.

They don't care about the quality of life for tenants.

If towers are built, even if they are no higher than the existing ones, all of us will be negatively impacted. Buildings that now enjoy light will be in partial to permanent shadow. I personally will never have sun coming in my living room again, or be able to see the sunrise, or even be able to open my blinds because I also won't have any more privacy. If an underground garage is built, we will lose all the wonderful mature trees that make our terraces usable in the hot summers and help absorb some of the pollution in the area. And car owners will be much less safe in retrieving their vehicles - and given global warming and the fact that we're in a flooding evacuation zone, how long before that structure floods? And infrastructure? The subway station, the buses, the schools are already overcrowded. What happens with the influx of thousands more people? Their recent charm offensive with nods to Black history in the lobbies and occasional lame events on the patch of dirty lawn along 132nd should be seen for what it is: a very recent attempt to mask their long history of neglecting and exploiting this population.

I feel completely helpless. The Olnick Organization is banking on our fear that they will make good on their threat to just build four new towers as of right. I'm sure they will do that, and I am sure that having done that, their make-nice campaign will go away and they will slide right back into neglecting the property. I'm also sure that they'll neglect it no matter what - even if they get their rezoning - because that is who they are. All that nice talk about the green space? They won't maintain it. New amenities for tenants? Those of us in the "old" buildings will be profiled if we try to enter the new ones. There will be apartheid between the rent stabilized tenants in the older buildings and the market rate tenants, just like there is now, only worse.

The only leverage we have, I feel, is that Olnick, for whatever reason, really really wants this R8 zoning. We need to use that to negotiate as hard as we can for a better solution for the tenants and community. When we first moved in, we were invited to the informational meetings about the planned redevelopment, the beginning of the charm offensive. At that time the plans looked different: there weren't these tall towers blocking out the sun, and it looked as though there was a mix of lower-rise units and retail around the property. I wouldn't object to that, if it meant that fewer people overall were affecting the density of the neighborhood, that light would not be lost, that decent shops and cafes we can afford would return, that lower-income units could be a large percentage of the project to keep this neighborhood from going the way of so many others in New York, for the rich only.

Respectfully,

Wendalyn Nichols

Rezoning Lenox Terrace area

Please vote no to the rezoning of the Lenox terrace area. The tenants have not been treated with respect from the owners of Lenox Terrace. Many of our request for the upkeep of the property and maintenance have been ignored. The area of 133rd to 132nd has been without stores for at least ten years. The block looks like a blighted community with loitering and safety issues. In the warmer months non tenants of the Lenox terrace have used the area for cookouts right on the sidewalk. The new businesses that are proposed with the redevelopment plan will be unaffordable for the longstanding community members. This neighborhood will be a plight between the haves and the have nots with the owners of the development only listening to the wealthier tenants.

Scott

nubia2186@aol.com

Opposed rezoning of Lenox Terrace

Chairmen Francisco Moya:

I am opposed to the rezoning of Lenox Terrace Housing Complex and fully supports the attached statement in opposition to the rezoning. The quality of life would be compromised.

No to rezoning.

Colette Belfor

<colette@cbelforsolutions.com>

From: marlittlejhn@aol.com
Sent: Tuesday, February 25, 2020 3:07 PM
Subject: No to rezoning Lenox Terrace

-

Rezoning

Dear Chairman: Francisco Moya
I am a Tenant at 2186 5th Ave
Lenox Terrace. I would like for you to vote "NO" to the Rezoning of Lenox Terrace on Wednesday
February 26,2020.
Thanks in Advance
Jean Covington

-

Rezoning of Lenox Terrace

Dear Chairman Francisco Moya,

I am a tenant at 2186 5th Avenue, Lenox Terrace. I would like for you to vote "No" to the Rezoning of
Lenox Terrace on Wednesday, February 26, 2020.
Thank you.

Sincerely,
Tina L. Lee

From: Ray Rogers <info@corporatecampaign.org>

Subject: Statement in Opposition to Lenox Terrace (Harlem) rezoning/upzoning

February 25, 2020

via email

To All Members of New York City Council

Statement in opposition to rezoning/upzoning of Lenox Terrace in Harlem

Submitted by:

Ray Rogers, Director

Corporate Campaign, Inc.

Campaign to Stop REBNY Bullies

PO Box 1002 Cooper Station

New York, NY 10276-1002

718-852-2808

My organization is totally opposed to The Olnick Organization's requests for permission to rezone Lenox Terrace in Harlem. It is no surprise that Olnick President Seth Schochet and The Olnick Organization are members of the Real Estate Board of New York (REBNY). Through its massive lobbying and payoffs to influential political leaders, REBNY has led the attacks on communities throughout NYC by using its clout to gain support for rezonings/upzonings that have fueled hyper-gentrification, torn stable neighborhoods apart and destroyed lives and livelihoods.

On January 12, 2020, Councilman Bill Perkins issued a statement in opposition to The Olnick Organization's rezoning efforts. He emphasized: "I have not changed my position that this project is not good for our community. The scale of this project tends to drastically change the landscape, quality of life of the residents and the numerous issues not addressed by The Olnick Organization...The new luxury housing and businesses will displace thousands of residents, small businesses...If allowed, this project will have a ripple effect throughout this community...in many ways...Air quality, loss of open space, adverse shadow impact (lack of sun) for all buildings...Overcrowded schools, transit systems, subway platforms, pedestrian and vehicular byways, parks, libraries and hospitals...2013 survey concluded that over 78% of the residents were opposed to the redevelopment and rezoning plan...seven years later the consensus has not changed.

"Further, The Olnick Organization has shown itself to be a bad player in this community for years...Residents have endured lack of services, ranging from broken elevators, leaking ceilings, mice and bed bug infestations...I emphatically request that my colleagues join me...in voicing a definite NO to this project."

On February 24, 2020, the the Asian American Legal Defense and Education Fund (AALDEF) issued a press release stating: "Today, a New York Supreme Court justice ruled that the developers' plans for four high-rise towers in Manhattan's Chinatown and the Lower East Side violate the New York City Zoning Resolution and nullified the approvals needed for the proposed projects...This legal victory will prevent developers from tripling the density of the neighborhood by adding almost 3,000 new luxury units, causing an affordability and displacement crisis for thousands of working-class residents." Similar victories to halt rezoning have happened in Inwood and Brooklyn.

The City Council, by refusing to cave in to The Olnick Organization's rezoning desires, will further send a message to REBNY that circumventing laws, ignoring community concerns and violating the public interest in order to satisfy developers' irresponsible rezoning wishes will no longer be tolerated.

Sincerely,

Ray Rogers
Director



(718) 852-2808
www.corporatecampaign.org

Lenox Hill ReZoning

Dear City Council Members

The community of Lenox Hill has spoken and they have NOT been heard. The rezonings that have gone through this far has been mostly in communities of color. They do not take into consideration the racial impact rezonings have on communities of color. The studies of Williamsburg and LIC make clear that rezonings result in mass displacement of black and brown folks.
YOU MUST VOTE NO ON THIS REZONING.

There is a growing mass consciousness in NYC. People are taking notice which politicians participate in the passing of these reZonings. Councilmembers May no longer hide behind the tradition of voting with the Councilmember whose calling for the rezoning. Think long and hard about your political image and career.

Sincerely,

Lena Melendez

Lenox Terrace / Central Harlem Rezoning

Please vote NO!!!,UNEQUIVOCALLY!! ON THE PROPOSED REZONING.

The Olnick plan will ABSOLUTELY INITIATE A "DIASPORA" FOR PEOPLE OF COLOR WHO LIVE IN LENOX TERRACE AND CENTRAL HARLEM. "THE" CULTURALLY HISTORIC COMMUNITY FOR AFRICAN AMERICANS IN NYC AND THE US.

Parenthetically, PLEASE, be very mindful of one significant question WHERE WILL THEY GO??? Please keep in mind the REAL TRUTH. HOW LONG WILL THE SENIOR CITIZENS AND LOW INCOME FAMILIES SURVIVE IN THE "MARKET RATE ECONOMY THAT AXIOMATICALLY IS GUARANTEED TO ARRIVE WITH THIS SO-CALLED "DEVELOPMENT"??

AGAIN, WHERE WILL THEY GO???????

IS THERE SIMPLY NO POLITICAL PROTECTION COMING FROM OUR ELECTED OFFICIALS TO STOP THE RAPACIOUS GREED OF THESE DEVELOPERS, WHO CLEARLY HAVE NO CONSCIENCE FOR THE DAMAGE THEY DO TO THE LIVES OF THOUSANDS??

YOU, MR. MOYA, ARE OUR LAST LINE OF DEFENSE!!

PLEASE VOTE "NO" ON WEDNESDAY!!!!

DONALD KENNEDY

**TEN WEST TENANTS ASSOCIATION
LENOX TERRACE**

Kaloma Cardwell
Chair, Ten West Tenants Association
Lenox Terrace
New York, NY 10037

February 18, 2020

NYC Council Speaker Johnson
City Hall
New York, NY 10007

Re: Olnick's Lenox Terrace Rezoning Proposal

Dear Speaker Johnson and members of City Council:

I write to you in support of the hundreds of Lenox Terrace tenants and Central Harlem residents who attended recent public hearings to request City Council's protection against Olnick, the owners of the Lenox Terrace apartment complex.¹ Olnick's record of (i) being sued by essentially hundreds of tenants for (allegedly) illegally deregulating rent stabilized apartments; (ii) contributing to economic disinvestment in Central Harlem, especially along 5th avenue; and (iii) responding poorly to health hazards such as mold and potential lead in its buildings' plumbing system is unacceptable.

It is clear, however, that this historic moment for Central Harlem ("Harlem") goes far beyond one landlord and raises questions about whether City Council will fight for tenants or if City Council will feign ignorance (or powerlessness) and reward landlords who have spent decades fighting and displacing tenants.

The people of Lenox Terrace/Harlem seek democratic and community control over their future, and called not only for City Council to vote "NO" (i.e., without conditions)² to Olnick's rezoning

¹ The applicant of the proposed rezoning, Lenox Terrace Development Associates—an affiliate of The Olnick Organization, Inc. ("Olnick")—is seeking several land use actions, including a zoning map amendment from R7-2 and C1-4 zoning districts to a C6-2 zoning district; two special permits to waive bulk and parking requirements; and a zoning text amendment.

² On June 20, 2019, speaking on behalf of Lenox Terrace tenants, I informed Community Board 10's Land Use Committee that the community "doesn't want negotiations around building size...They want Community Board 10 members to kill [Olnick's proposal]." A video of my remarks, as well as other Lenox Terrace tenants' testimonials can be viewed at <http://bit.ly/HarlemRezoning> or <https://medium.com/@SaveHarlem/harlem-residents-are-fighting-the-next-wave-of-gentrification-join-us-dc79d31652da>.

TEN WEST TENANTS ASSOCIATION LENOX TERRACE

proposal but for the end of landlords' control over the economic and political future of Harlem.

I agree with the demands of the residents of Lenox Terrace and Harlem who have been saying the same thing for years³: Tenants must no longer be treated as hostages. Lenox Terrace and Harlem must no longer be treated as a colony that is owned by outsiders.

During this moment of struggle for responsive and legitimate governance, I urge you to halt the current and crippling landlord-tenant relationship imposed on Lenox Terrace/Harlem residents. At a minimum, the uncertain process of certain private owners/landlords being able to build significantly smaller and fewer "as-of-right" buildings must not be exploited to strengthen owners/landlords power over the day-to-day lives of the people of Lenox Terrace/Harlem.

I remind you that according to the *Manhattan Community Board 10 2014 District Needs Statement*, "African Americans make up approximately 63% of Community Board 10's population, followed by Hispanic at 22%, White at 10% and Asian at 2%."⁴ I remind you that such population shifts do not occur because some natural and inevitable force is driving them, but rather from an overlapping mixture of government and corporate decisions that ignore the lessons of the past.

What past lesson is screaming to be heard? Well, at this very moment, Lenox Terrace has been credibly accused in an ongoing class action suit of essentially being a key driver of displacement and destabilization in Harlem.

In *Downing v. First Lenox Associates, LLC*, Index No. 100725/2010 (the "Lenox Terrace Class Action"), Lenox Terrace tenants filed a class action lawsuit against the owners of Lenox Terrace in 2010. In this case, which the owners of Lenox Terrace have been fighting for a decade, Lenox Terrace tenants are alleging that the owners of Lenox Terrace improperly treated apartments as being unregulated under applicable rent stabilized laws even though it was receiving "J-51" tax benefits.

According to publicly available documents that were filed July 31, 2019, the owners of Lenox Terrace recently agreed to pay \$2,989,000 in a *preliminary* (i.e., not final) settlement agreement

³ As many of you know, Lenox Terrace and Harlem residents are seemingly asked every couple of years to appear before city officials and bare their souls as to why approving Olnick's rezoning proposal would be harmful and unjust. *See Solis, Gustavo*. 2015. "Lenox Terrace Residents Fighting Against Proposed Commercial Rezoning." DNAInfo. June 4. <https://www.dnainfo.com/new-york/20150604/central-harlem/lenox-terrace-residents-fighting-against-proposed-commercial-rezoning/>

⁴ I don't need to remind you that the decline of the African American population continues to occur at an alarming rate and that such population shifts haven't led to Black, Latinx, or working-class communities gaining access to better opportunities and life outcomes.

TEN WEST TENANTS ASSOCIATION LENOX TERRACE

in the Lenox Terrace Class Action.⁵ According to the Lenox Terrace Association of Concerned Tenants (LT-ACT), approximately “175 residents who currently reside at Lenox Terrace and nearly 700 residents who have moved out will be affected” by the Lenox Terrace Class Action.

Make no mistake: This is Olnick’s “Lenox Terrace Legacy.”

It is unacceptable that certain members of City Council are considering justifying a government decision that effectively helps a landlord with Olnick’s *ongoing* litigation history build more and significantly bigger apartment towers.

To be clear, Olnick’s Lenox Terrace Legacy is not confined to the past. It seems to very much be alive and well, as I am personally aware of current Lenox Terrace tenants who are on the verge of filing lawsuits against Olnick because such tenants have determined that their apartment units are still illegally deregulated and that Olnick has overcharged and continues to overcharge them thousands of dollars.

Any anticipated and hypothetical benefits of a so-called “Tenants Benefits Agreement”—or Olnick’s commitment to “affordable housing” in exchange for a rezoned Lenox Terrace/Harlem—or Olnick’s “covenants” to restrict certain features of proposed buildings must be viewed in this light: Olnick arguably just spent a decade violating seemingly iron-clad lease agreements and rent stabilization commitments and then spent another decade fighting the enforceability of certain pro-tenant interpretations of those agreements and commitments. If that’s not enough for City Council, what does a landlord have to do to “earn” a “NO” (i.e., without conditions) vote?

Undoubtedly, some members of City Council are thinking that if Olnick can be limited to a “smaller” rezoning in the current ULURP process (e.g., R8), than City Council will have done Harlem a service by securing various and potential affordable housing outcomes. At best, this logic is built on wishful, short-term thinking; At worst, this logic is built on intentionally deceptive real estate talking points.

If City Council makes the tragic and unsupported mistake of thinking that Olnick will be a responsible affordable housing partner—without first demanding that Olnick spend (at least) the next couple of years demonstrating that it can and will be, among other things, a responsible affordable housing community partner to its existing tenants—then the next ten years of Lenox Terrace and Harlem will look like the last ten years of Lenox Terrace and Harlem: Surplus benefits are likely to end up in the hands of people who want to “celebrate” Harlem’s legacy even as they openly alter, threaten, and steal Harlem’s future.

⁵ “Stipulation of Settlement.” The Supreme Court Records On-line Library.
<http://iapps.courts.state.ny.us/iscroll/SQLData.jsp?IndexNo=100725-2010>

TEN WEST TENANTS ASSOCIATION

LENOX TERRACE

Ultimately, Olnick, the applicant of the proposed Lenox Terrace rezoning, cannot be credibly and responsibly redeemed or given the benefit of the doubt this ULURP cycle.

As such, the only way to protect Lenox Terrace and Harlem tenants and residents—the only way to prevent tenants from being treated like hostages—is to maintain the existing zoning for Lenox Terrace and to completely deny Olnick’s rezoning proposal.

I understand that many members of City Council have a genuine interest in addressing various structural and social challenges in Harlem. As such, as the people of Lenox Terrace and Harlem seek to compel transparency and accountability from decision makers, I believe City Council should heed this letter’s and the community’s calls.

I ask that before City Council gives Olnick (or any private applicant of a similarly impactful rezoning) something other than a “NO” vote, that City Council use all of its official and unofficial power and leverage to require Olnick (and other rezoning applicants) to provide the following to relevant parties **BEFORE** City Council’s 60-days’ review period is triggered by ULURP:^{6, 7}

- **Good Cause Eviction Protections**
 - Legally binding and enforceable commitments that all existing tenants (as of the date of the earliest submitted rezoning application and throughout its review) have received, and all post-ULURP/future tenants will receive (if approval is granted), guaranteed and strong “good cause” eviction protections in their leases.⁸
- **Lead Mitigation**
 - An independent analysis and proof that all the owner’s/landlord’s buildings are completely free of lead and/or have enacted and funded an effective and sustainable mitigation plan for any possible sources of lead.

(See Exhibit A for communications regarding potential lead at Lenox Terrace.)

⁶ For clarity, nothing in this letter should be construed to be a “condition” that should become a part of the current Olnick proposal/ULURP process. The community has made it clear that the community wants and needs City Council and other relevant officials to vote “NO” (i.e., without conditions).

⁷ This list is not exhaustive. The list is intended to serve as a guide for the types of information that should be provided and reviewed by relevant parties prior to any approvals by City Council and other relevant bodies.

⁸ Market tenants are hesitant to speak truthfully on the record during ULURP because of concerns about retaliation. I know of at least one case where Olnick suspiciously decided not to renew the lease of a tenant who had recently spoke against the proposed rezoning during a public hearing in the current ULURP cycle. If city council is relying on tenants to come forward at the public hearings during ULURP, city council must find ways to protect tenants from retaliation.

TEN WEST TENANTS ASSOCIATION

LENOX TERRACE

- **Litigation Due Diligence⁹**
 - Answers to the following questions:
 - How many claims are currently pending?
 - What is the estimate of damages?
 - What is the current status of each claim?
 - What is the likelihood of success on the merits?
 - Were there any large claims paid out in the past?
 - Are any of the pending claims class actions? Has the owner/landlord been involved in any class actions in the past?
 - What kinds of claims or litigation is the owner/landlord typically a party to?
 - What is the average amount of damages?
 - Are most claims settled or litigated? What is the typical size of a settlement?
 - Are there any settlement agreements or court decrees with ongoing obligations? If so, what are they and when do they terminate?
 - A list of all material claims (i.e., as defined by a dollar threshold or severity of injury) covering the previous 5 years.

- **Organizational Documents**
 - Answers to the following questions:
 - Who owns the equity in the business?
 - Is there an equity holder or group of equity holders that has control of the business?
 - Are there any subsidiaries? Are they wholly owned?
 - What actions require consent of equity holders or the board of directors (or other equivalent governing body)?

- **Finance Documents**
 - Audited Financial Statements

* * *

⁹ Since applicants will repeatedly ask City Council to consider and approve rezoning applications, City Council should create its own comprehensive due diligence request lists (and update it routinely). Pro bono legal counsel should be able to help City Council develop such a list (which ideally will be slightly adjusted for each applicant) and provide training on how City Council can systematically conduct due diligence across various committees and community partnerships.

TEN WEST TENANTS ASSOCIATION

LENOX TERRACE

In connection with the above and in advance of any rezoning for Lenox Terrace (or other future rezoning applications), City Council should require the following:

- **A Comprehensive Racial Impact Study**¹⁰
- **A City Council Community-Driven Rezoning Process that Meets or Exceeds the Process in the 2017 East Harlem Rezoning**¹¹
 - As the chart (created on June 26, 2019) on the next page makes clear, if City Council is going to take community-driven rezoning seriously, City Council can't merely have conversations with a few members of LT-ACT and think that qualifies as community-driven rezoning.
- **Conflicts Checks**
 - For community organizations and individuals who intend to have a “seat at the negotiating table” with respect to potential benefits agreements, materials related to such organizations’ policies on conflicts of interest and other internal measures to avoid financial capture by special and real estate interests. For example, LT-ACT has members on its Executive Committee who work in the real estate industry and it’s not clear to me that City Council has done any due diligence to ensure such folks have properly disclosed their employment status or any potential conflicts of interest.

¹⁰ Since February 2018, Harlem residents have been asking city officials to conduct a racial impact study on Olnick’s proposed rezoning. Such requests can be viewed at <http://bit.ly/HarlemRezoning> or <https://medium.com/@SaveHarlem/harlem-residents-are-fighting-the-next-wave-of-gentrification-join-us-dc79d31652da>.

¹¹ Since June 2019, I’ve been asking relevant government bodies to implement a comprehensive community-driven rezoning process and have been circulating the attached chart to community members.

TEN WEST TENANTS ASSOCIATION

LENOX TERRACE

WHERE IS CENTRAL HARLEM'S COMMUNITY-DRIVEN REZONING PROCESS?!

"AS BOROUGH PRESIDENT, I CAME INTO OFFICE DETERMINED TO CHALLENGE THE TOP-DOWN PLANNING FRAMEWORK THAT DROVE MANY NEIGHBORHOOD-REZONING EFFORTS. INSTEAD, I HAVE WORKED FOR DECISION- MAKING MODELS THAT APPROACH PLANNING FROM THE BOTTOM-UP." – GALE BREWER			
	2017 East Harlem Rezoning* (Approved in 2017)	2019 Central Harlem/Lenox Terrace Rezoning Proposal* (Under City Review; Not Final)	
Community Board	Community Board 11	Community Board 10	
Rezoning Applicant	NYC	Private Developer/Olnick	
Projected # of Residential Units	~ 3500 units (net increase)	~ 1642 units (~ 1,181 not "affordable")	
Commercial Space	~ 151,100 square feet	~ 135,500 square feet	
Community Facility Space	~ 98,900 square feet	~ 15,055 square feet	
Community-Driven Process?	Yes/Partially	No/Doesn't Exist	
Community Plan	The East Harlem Neighborhood Plan	N/A	
# of Large Public Meetings	8	N/A	
# of Policy Discussions	40	N/A	
On-the-ground Surveys?	Yes	N/A	
Final Report with Findings and Recommendations?	Yes	N/A	
Steering Committee Members	<ul style="list-style-type: none"> • City Council Speaker Melissa Mark-Viverito • Councilmember Inez Dickens • Manhattan Borough President Gale Brewer • Community Board 11 • El Barrio's Operation Fightback • Lott Community Development Corporation • Artimus Construction • Community Voices Heard • CIVITAS • Union Settlement • Business Development Center 	<ul style="list-style-type: none"> • Harlem RBI • Elmendorf Reformed Church • New York Academy of Medicine • El Museo del Barrio • Renaissance Charter High School for Innovation • WE ACT • Johnson Houses Tenant Association • New York Restoration Project • 32BJ SEIU • Local 79 	N/A
Researched Topics	<ul style="list-style-type: none"> • Open Space + Recreation • Culture + Arts • Afterschool / Daycare / Pre-K • Education / Schools • Affordable Housing Preservation • Environment / Transportation / Safety 	<ul style="list-style-type: none"> • NYCHA / Public Housing • Small Business / Economic Development / Workforce Development • Zoning / Land Use • Affordable Housing Development • Health / Seniors 	N/A
Planning Period	2 years	N/A	

*All numbers are projections and/or are as described in the East Harlem Rezoning Draft Scope of Work (11/10/16); Lenox Terrace Draft Scope of Work (12/28/17); and East Harlem Neighborhood Plan.

Questions/Comments/Corrections? Contact Kaloma Cardwell at SavelTandHarlem@gmail.com

6/26/19

**TEN WEST TENANTS ASSOCIATION
LENOX TERRACE**

For far too long, Olnick and other landlords have treated the residents of Lenox Terrace and Harlem as if they are disposable or completely under their control and domination. Harlem residents have suffered from decades of economic neglect, strategic disinvestment, landlord bullying and deception, and government officials' short-term compromises.

The people of Lenox Terrace and Harlem have spoken. Once again, they reject Olnick's proposal to rezone Harlem and call for democratic planning and governance, shared economic growth, and self-determination—aspirations fundamentally at odds with both Olnick's proposal and the current ULURP process.

I thank you in advance for your prompt attention to the issues outlined in this letter and consideration for what is a community-wide and tenant-led call for City Council to vote "NO" (i.e., without conditions) to Olnick's proposal to rezone Lenox Terrace and Harlem.

Sincerely,



Kaloma Cardwell, Esq.
Chair, Ten West Tenants Association
Executive Committee Member, LT-ACT
Lenox Terrace/Central Harlem Tenant

cc:

Wmartin@council.nyc.gov;
rdelfranco@council.nyc.gov;
hearings@council.nyc.gov

**TEN WEST TENANTS ASSOCIATION
LENOX TERRACE**

EXHIBIT A

Relevant Lead Notices at Lenox Terrace

Important Notice Regarding Possible Lead Contamination

Kaloma Cardwell
Chair, Ten West Tenants Association; Tenant
10 West 135th Street
New York, NY 10037

October 8, 2019

Dear Lenox Terrace Resident:

Yesterday, on October 7, 2019, a tenant in our building notified me of **potential lead contamination** involving their unit's running water. The tenant lives in a "D" unit and has sent additional water samples to the City for additional testing.

Unfortunately, I don't have much information beyond the official notice that the tenant received from the City. I have decided to share the attached letter, which is the official notice that the tenant received from the City. Please read both sides of the attached letter.

If you have questions or concerns, please contact management at 212-862-6380 or email Victoria Hair at vhair@lenoxpts.com.

Please also note that on October 7, 2019, I provided notice (via email) to Ms. Hair of the potential lead contamination in our building's plumbing system. In addition to sharing the attached letter with Ms. Hair, I also asked Ms. Hair the following questions:

1. How and when will management inform other tenants at 10 West that the building's plumbing is a potential lead source?
2. How and when will management conduct its own lead tests to assess and test the building's plumbing system?
3. How and when will management use independent agencies or companies to conduct lead tests to assess and test the building's plumbing system?
4. How and when will management follow the steps in questions 1-3 (i.e., inform tenants and run tests) with the other Lenox Terrace buildings?

If and when I hear back from Ms. Hair or management, I will share whatever new information I receive. Please reach out to me or your floor captain if you think we can be helpful, and we'll do our best to answer your questions with the limited information we have.

Sincerely,

Kaloma Cardwell (TWTAPresident@gmail.com)

PLEASE NOTE: The information in (and attached to) this letter is for informational purposes only and not for the purpose of providing legal advice. If you feel it is necessary, you should contact your attorney to obtain advice with respect to any particular issue or problem.



October 02, 2019

1

[REDACTED]
10 WEST 135 STREET, [REDACTED]
NEW YORK, NY 10037

Site ID: [REDACTED]
Kit ID: [REDACTED]

Vincent Sapienza, P.E.
Commissioner

Dear [REDACTED]

Thank you for taking part in NYC's Department of Environmental Protection (DEP) Free Residential Lead Testing Program. DEP's laboratory tested your samples to find out how much lead was in the water.

Paul V. Rush, P.E.
Deputy Commissioner
Bureau of Water Supply
prush@dep.nyc.gov

What Are My Results?

Lead Results in parts per billion (ppb)
(1st Bottle) First draw sample measured **22** ppb
(2nd Bottle) 1-2 minute flush sample measured **0** ppb

59-17 Junction Boulevard
Flushing, NY 11373

What Does This Mean?

The level of lead in your drinking water sample(s) indicates a lead source in your property's plumbing system.

Lead Unit
Tel: (718) 595-5364
Fax: (718) 595-5355
DEPLedUnit@dep.nyc.gov

What Is My Next Step?

DEP is sending you another test kit with three bottles because the level of lead was 15 ppb or above. Retest your water using the 3-bottle kit to verify your first results and to determine if running your water longer reduces the amount of lead.

What Should I Do?

DEP recommends you take the following steps when using tap water for drinking or cooking to reduce lead exposure:

- **Before use run your water for 30 seconds or more**, especially when water has been sitting in the pipes overnight or for several hours. Run the water until it becomes as cold as it will get, and then for another 15 seconds.
- **Always use cold water** for cooking, drinking, or preparing infant formula. Hot tap water is more likely to contain lead and other metals.
- **Every month remove and clean the faucet screen (also called an aerator)**, where small particles can get trapped.
- **Hire a licensed plumber to identify and replace plumbing fixtures and/or service line that contain lead.**
- **Consider using a home water filter device certified to remove lead.** Particularly if you are pregnant or there are children living in your home, and/or if your water's lead values do not decrease after running the water. Check out www.nsf.org/info/leadfiltrationguide for a list of certified treatment devices.

Sincerely,

Carla Glaser
Section Chief, Distribution Science and Planning
Bureau of Water Supply/Water Quality

More Information on Next Page

More Information

Where Does Lead Come From?

Lead can get into the water when it is in contact with lead service lines/pipes, lead solder, faucets, fittings, and valves. The most common cause for the presence of lead is corrosion, a reaction between the water and the lead pipes or solder. This is a greater concern when the water has not been used for several hours. To reduce corrosion, DEP applies treatment to the water. DEP is confident that the treatment reduces lead levels at the tap, but we cannot be sure that treatment alone will always lower the lead levels in all buildings throughout NYC if lead pipes or solder are present.

Who May Be At Risk?

Lead in drinking water can be harmful, especially to young children and pregnant women. NYC's water is healthy and safe to drink. It has no lead when it is delivered from our upstate reservoir system but the possible presence of lead in your interior plumbing may pose a risk. Not every home will have the same risk because each building's plumbing may be different in material and age.

Who Can I Contact?

For health-related questions:

- Call NYC Health Department – Healthy Homes at (646) 632-6023
- Visit www.nyc.gov/health - Healthy Homes, Lead Poisoning Prevention
- Contact your health care provider, if you need a blood test for you or your child

For questions about lead in drinking water:

- Call DEP Lead Unit at (718) 595-5364 or
- Email DEPLoadUnit@dep.nyc.gov
- Visit www.nyc.gov/dep/leadindinkingwater

From: Edgar Richmond <edgar.richmond@gmail.com>

Sent: Wednesday, February 26, 2020 8:29 AM

Subject: Re: Lenox Terrace Re-zoning Vote

Hello,

Please vote no today for the Lenox Terrace rezoning. As a tenant, I am in opposition of the rezoning. Please confirm receipt of this email.

Thanks,

Edgar

On Tue, Feb 25, 2020 at 3:00 PM Edgar Richmond <edgar.richmond@gmail.com> wrote:

Hello,

I hope that all is well. I oppose the Lenox Terrace rezoning proposal. I don't see the immediate benefits as a current tenant. The current property could be upgraded. For example, the carpet in the main hallways is really old. The laundry room is managed by a outside vendor. The cheap washer machines don't properly clean clothes. The construction would disturb the older retired tenants and potentially displace them.

From traveling around NYC, it appears that a project of this magnitude should be completed on a vacant lot. The proposal would double the current property size which would also put a strain on the current management and maintenance teams.

Thanks,

Edgar

**THE COUNCIL
THE CITY OF NEW YORK**

Appearance Card

I intend to appear and speak on Int. No. _____ Res. No. 625

in favor in opposition

Date: _____

(PLEASE PRINT)

Name: Peter Javorek

Address: _____

I represent: CAFC Training Cell Assoc

Address: 900 7th Ave

**THE COUNCIL
THE CITY OF NEW YORK**

Appearance Card

I intend to appear and speak on Int. No. 633-35 Res. No. _____

in favor in opposition

Date: _____

(PLEASE PRINT)

Name: Jessica Ortiz

Address: 25 W. 18th

I represent: 32B)

Address: _____

**THE COUNCIL
THE CITY OF NEW YORK**

Appearance Card

I intend to appear and speak on Int. No. 633 Res. No. 635

in favor in opposition

Date: 2/12/2020

(PLEASE PRINT)

Name: Winston Majette

Address: 2518 8th Ave. NYC, NY 10030

I represent: HARLEM WEEK Inc.

Address: 200A W. 136th St. NYC

Please complete this card and return to the Sergeant-at-Arms

**THE COUNCIL
THE CITY OF NEW YORK**

Appearance Card

I intend to appear and speak on Int. No. 0626 Res. No. _____

in favor in opposition

Date: 2/12/20

(PLEASE PRINT)

Name: ZACH WINGFIELD

Address: 92 HERRING ST

I represent: SAVE GANSEVOORT

Address: _____

**THE COUNCIL
THE CITY OF NEW YORK**

Appearance Card

I intend to appear and speak on Int. No. 0629 Res. No. _____

in favor in opposition

Date: _____

(PLEASE PRINT)

Name: Ethel Tyus

Address: 919 Sterling Pl / 1291 St Marks Av

I represent: CB 8

Address: 129 St Marks Av Plen

**THE COUNCIL
THE CITY OF NEW YORK**

Appearance Card

I intend to appear and speak on Int. No. _____ Res. No. _____

in favor in opposition

Date: 2/12/2020

(PLEASE PRINT)

Name: Frederica Sigel

Address: 101 W 12th St #125

I represent: CB2 - Manh.

Address: 3 WSV

Please complete this card and return to the Sergeant-at-Arms

**THE COUNCIL
THE CITY OF NEW YORK**

Appearance Card

632-635

I intend to appear and speak on Int. No. _____ Res. No. _____
 in favor in opposition

Date: _____

(PLEASE PRINT)

Name: Wollie Baulch

Address: #1 CONVENT AVE

I represent: _____

Address: _____

**THE COUNCIL
THE CITY OF NEW YORK**

Appearance Card

632-635

I intend to appear and speak on Int. No. _____ Res. No. _____
 in favor in opposition

Date: _____

(PLEASE PRINT)

Name: ANTHONY HARRIS

Address: 470 (AVOX) AVENUE

I represent: _____

Address: _____

**THE COUNCIL
THE CITY OF NEW YORK**

Appearance Card

632-35

I intend to appear and speak on Int. No. _____ Res. No. _____
 in favor in opposition

Date: _____

(PLEASE PRINT)

Name: TOUD HILLERY

Address: _____

I represent: _____

Address: _____

Please complete this card and return to the Sergeant-at-Arms

Applicant
Team

THE COUNCIL THE CITY OF NEW YORK

Appearance Card

631

I intend to appear and speak on Int. No. _____ Res. No. _____
 in favor in opposition

Date: _____

(PLEASE PRINT)

Name: Jacklyn Scaringi

Address: Akerman LLP 666 Fifth Ave

I represent: 64-11 QB corner (Applicant)

Address: _____

THE COUNCIL THE CITY OF NEW YORK

Appearance Card

632-635

I intend to appear and speak on Int. No. _____ Res. No. _____
 in favor in opposition

Date: 2/12/2020

(PLEASE PRINT)

Name: Jensy Acosta

Address: 3333 Broadway Apt E5C New York NY 10031

I represent: The Gathering Harlem

Address: 8 West 126th Street New York, NY 10027

THE COUNCIL THE CITY OF NEW YORK

Appearance Card

632

I intend to appear and speak on Int. No. _____ Res. No. 35
 in favor in opposition

Date: 2-12-20

(PLEASE PRINT)

Name: Veronica M. Glasgow

Address: 45 W. 132nd St Apt. 16K

I represent: TENANT

Address: Above

Please complete this card and return to the Sergeant-at-Arms

**THE COUNCIL
THE CITY OF NEW YORK**

Appearance Card

632-635

I intend to appear and speak on Int. No. _____ Res. No. _____

in favor in opposition

Date: _____

(PLEASE PRINT)

Name: Delsenia Glover

Address: 2186 5th Avenue

I represent: tenants

Address: Lenox Terrace

**THE COUNCIL
THE CITY OF NEW YORK**

Appearance Card

626

I intend to appear and speak on Int. No. _____ Res. No. _____

in favor in opposition

Date: _____

(PLEASE PRINT)

Name: Elizabeth Bennett

Address: _____

I represent: Applicant - 416-74 Gansevoort Owners

Address: _____

**THE COUNCIL
THE CITY OF NEW YORK**

Appearance Card

632-635

I intend to appear and speak on Int. No. _____ Res. No. _____

in favor in opposition

Date: _____

(PLEASE PRINT)

Name: Ethan Goodman (rep. Applicant)

Address: 101 Park

I represent: Applicant - Olmick Org

Address: _____

Please complete this card and return to the Sergeant-at-Arms

**THE COUNCIL
THE CITY OF NEW YORK**

Appearance Card

632-35

I intend to appear and speak on Int. No. _____ Res. No. _____

in favor in opposition

Date: 2/12/20

(PLEASE PRINT)

Name: Julius Tajiddin

Address: P.O. Box 2499, NYC 10027

I represent: Preserve Harlems Legacy

Address: Harlem

**THE COUNCIL
THE CITY OF NEW YORK**

Appearance Card

I intend to appear and speak on Int. No. 632-635 Res. No. _____

in favor in opposition

Date: _____

(PLEASE PRINT)

Name: Edward Applebone

Address: _____

I represent: Applicant - Olnick Organization

Address: _____

**THE COUNCIL
THE CITY OF NEW YORK**

Appearance Card

I intend to appear and speak on Int. No. 632-635 Res. No. _____

in favor in opposition

Date: _____

(PLEASE PRINT)

Name: Chris Grabe

Address: _____

I represent: Applicant - Olnick Organization

Address: _____

THE COUNCIL
THE CITY OF NEW YORK

Appearance Card

632-635

I intend to appear and speak on Int. No. _____ Res. No. _____

in favor in opposition

Date: 2/12/2020

(PLEASE PRINT)

Name: Beatriz Diaz Taveras

Address: _____

I represent: Catholic Charities New York

Address: 101 Ave NY NY 10022

THE COUNCIL
THE CITY OF NEW YORK

Appearance Card

632-35

I intend to appear and speak on Int. No. _____ Res. No. _____

in favor in opposition

Date: _____

(PLEASE PRINT)

Name: EMMETT CAUSEY

Address: 2186 5TH AVE.

I represent: GREATER HARLEM HOUSING DEVEL. CORP

Address: 200A WEST 136TH STREET

THE COUNCIL
THE CITY OF NEW YORK

Appearance Card

628,629

I intend to appear and speak on Int. No. _____ Res. No. _____

in favor in opposition

Date: _____

(PLEASE PRINT)

Name: RICHARD LOBEL

Address: SHELDON LOBEL PC

I represent: APPLICANT

Address: GRAND & PACIFIC

THE COUNCIL
THE CITY OF NEW YORK

Appearance Card

630

I intend to appear and speak on Int. No. _____ Res. No. _____

in favor in opposition

Date: _____

(PLEASE PRINT)

Name: RICHARD LOBEL

Address: SHELDON LOBEL, P.C.

I represent: APPLICANT

Address: 8118 13TH AVE

THE COUNCIL
THE CITY OF NEW YORK

Appearance Card

632-35

I intend to appear and speak on Int. No. _____ Res. No. _____

in favor in opposition

Date: _____

(PLEASE PRINT)

Name: DR JIM FAIRBANKS

Address: 1220 SHAKESPEARE AVE BRONX

I represent: _____

Address: _____

THE COUNCIL
THE CITY OF NEW YORK

Appearance Card

631

I intend to appear and speak on Int. No. _____ Res. No. _____

in favor in opposition

Date: _____

(PLEASE PRINT)

Name: REV. Gilbert Pickett

Address: _____

I represent: ~~Rev.~~ Moderator for EASTGEN

Address: Baptist Association

Please complete this card and return to the Sergeant-at-Arms

**THE COUNCIL
THE CITY OF NEW YORK**

Appearance Card

627

I intend to appear and speak on Int. No. _____ Res. No. _____

in favor in opposition

Date: _____

(PLEASE PRINT)

Name: ERIC PALATNIK

Address: 32 B'way

I represent: 271 Seabreeze

Address: _____

**THE COUNCIL
THE CITY OF NEW YORK**

Appearance Card

626

I intend to appear and speak on Int. No. _____ Res. No. _____

in favor in opposition
myself

Date: _____

(PLEASE PRINT)

Name: Donna Rafferty

Address: 32 Gansevoort St.

I represent: myself

Address: _____

**THE COUNCIL
THE CITY OF NEW YORK**

Appearance Card

632-35

I intend to appear and speak on Int. No. _____ Res. No. _____

in favor in opposition

Date: _____

(PLEASE PRINT)

Name: CLESTON LORD - GREATER HARLEM CHAMBER OF COM

Address: 200A W 136TH STREET

I represent: GREATER HARLEM CHAMBER OF COMMERCE

Address: _____

Applicant

THE COUNCIL THE CITY OF NEW YORK

Appearance Card

631

I intend to appear and speak on Int. No. _____ Res. No. _____

in favor in opposition

Date: _____

(PLEASE PRINT)

Name: Nijema Rivera

Address: HANAC

I represent: _____

Address: _____

THE COUNCIL THE CITY OF NEW YORK

Appearance Card

632-35

I intend to appear and speak on Int. No. _____ Res. No. _____

in favor in opposition

Date: 2/12/20

(PLEASE PRINT)

Name: Valerie Jo Bradley

Address: 144 W. 120th St. NY, NY 10027

I represent: Save Harlem Now!

Address: 144 W. 120th St. NY, NY 10027

THE COUNCIL THE CITY OF NEW YORK

Appearance Card

I intend to appear and speak on Int. No. 632-35 Res. No. _____

in favor in opposition

Date: _____

(PLEASE PRINT)

Name: Alex Bennell

Address: 60 Clarkson Ave

I represent: Churches United for Fairhousing

Address: Imanus Gavey Blvd

**THE COUNCIL
THE CITY OF NEW YORK**

Appearance Card

631

I intend to appear and speak on Int. No. _____ Res. No. _____

in favor in opposition

Date: 2/12/20

(PLEASE PRINT)

Name: Mark Espinoza

Address: _____

I represent: 32BS

Address: _____

**THE COUNCIL
THE CITY OF NEW YORK**

Appearance Card

32-65

I intend to appear and speak on Int. No. _____ Res. No. _____

in favor in opposition

Date: _____

(PLEASE PRINT)

Name: Michael Henry Adams

Address: 41 Conlon Avenue NY NY 10027

I represent: Harlem

Address: _____

**THE COUNCIL
THE CITY OF NEW YORK**

Appearance Card

632-635

I intend to appear and speak on Int. No. _____ Res. No. _____

in favor in opposition

Date: _____

(PLEASE PRINT)

Name: Jean Covington

Address: 2186 5th Ave # 4-N

I represent: Leopold Terrace

Address: _____

**THE COUNCIL
THE CITY OF NEW YORK**

Appearance Card

632-635

I intend to appear and speak on Int. No. _____ Res. No. _____

in favor in opposition

Date: 0/12/20

(PLEASE PRINT)

Name: CORA PERCIVAL

Address: 250

I represent: _____

Address: _____

**THE COUNCIL
THE CITY OF NEW YORK**

Appearance Card

632-635

I intend to appear and speak on Int. No. _____ Res. No. _____

in favor in opposition

Date: 2/12/20

(PLEASE PRINT)

Name: Cordell Cleare

Address: 102 W. 116th Street

I represent: District Leader 70th AD

Address: _____

**THE COUNCIL FOR QUESTIONS
THE CITY OF NEW YORK ONLY**

Appearance Card

629,629

I intend to appear and speak on Int. No. _____ Res. No. _____

in favor in opposition

Date: _____

(PLEASE PRINT)

Name: Elie Pariente (APPLICANT)

Address: Grand and Pacific

I represent: APPLICANT

Address: Grand and Pacific

Please complete this card and return to the Sergeant-at-Arms

**THE COUNCIL
THE CITY OF NEW YORK**

Appearance Card

632-635

I intend to appear and speak on Int. No. _____ Res. No. _____

in favor in opposition

Date: _____

(PLEASE PRINT)

Name: Ms. Samantha Thompson

Address: 410 Cathedral Park

I represent: Tenant and Neighbors Coalition

Address: to speak for Lenox Terrace

**THE COUNCIL
THE CITY OF NEW YORK**

Appearance Card

632-635

I intend to appear and speak on Int. No. _____ Res. No. _____

in favor in opposition

Date: 2/12/20

(PLEASE PRINT)

Name: Paula McKee

Address: 2186 5th Avenue

I represent: LT-ACT

Address: Lenox Terrace

**THE COUNCIL
THE CITY OF NEW YORK**

Appearance Card

628629

I intend to appear and speak on Int. No. _____ Res. No. _____

in favor in opposition

Date: _____

(PLEASE PRINT)

Name: Cassie Casillo

Address: 25 W 18th St

I represent: 32BT

Address: _____

**THE COUNCIL
THE CITY OF NEW YORK**

Appearance Card

I intend to appear and speak on Int. No. _____ Res. No. _____

in favor in opposition

Date: 12 FEB 2020

(PLEASE PRINT)

Name: Savanna Washington

Address: 45 W. 132ND #14N NY 10037

I represent: LT-Act - Vice President

Address: Lenox Terrace

**THE COUNCIL
THE CITY OF NEW YORK**

Appearance Card

I intend to appear and speak on Int. No. _____ Res. No. _____

in favor in opposition

Date: _____

(PLEASE PRINT)

Name: Lenn Shebar

Address: 470 Lenox Ave.

I represent: LT-Act President

Address: Lenox Terrace

**THE COUNCIL
THE CITY OF NEW YORK**

Appearance Card

I intend to appear and speak on Int. No. 240630 Res. No. _____

in favor in opposition

Date: _____

(PLEASE PRINT)

Name: Dedrick Blue

Address: 3743 Bronxwood Ave.

I represent: NY Interfaith Commission

Address: 101 W 123rd Harlem

Please complete this card and return to the Sergeant-at-Arms

**THE COUNCIL
THE CITY OF NEW YORK**

Appearance Card

I intend to appear and speak on Int. No. 622-135 Res. No. _____

in favor in opposition

Date: 2/12/20

(PLEASE PRINT)

Name: Kaloma Cardwell

Address: 10 West 135th St. NY, NY 10037

I represent: LT-ACT / Ten West Tenants Association

Address: same as above

Please complete this card and return to the Sergeant-at-Arms

**THE COUNCIL
THE CITY OF NEW YORK**

Appearance Card

I intend to appear and speak on Int. No. _____ Res. No. _____

in favor in opposition

Date: 2/12/20

(PLEASE PRINT)

Name: Gary Sales

Address: 470 Lenox Ave APT 11A

I represent: _____

Address: _____

Please complete this card and return to the Sergeant-at-Arms

**THE COUNCIL
THE CITY OF NEW YORK**

Appearance Card

[]

I intend to appear and speak on Int. No. _____ Res. No. _____
 in favor in opposition

Date: _____

(PLEASE PRINT)

Name: LENN SHEBAR
Address: 470 LENOX AVE
I represent: LENOX TERRACE
Address: _____

▶ Please complete this card and return to the Sergeant-at-Arms ◀

**THE COUNCIL
THE CITY OF NEW YORK**

Appearance Card

[]

I intend to appear and speak on Int. No. _____ Res. No. _____
 in favor in opposition

Date: _____

(PLEASE PRINT)

Name: JOANN SCOTT
Address: 2186 5th Ave. #8e NYC 10037
I represent: Paula Merae + myself
Address: 2186 5th Ave. #2D NYC 10037

▶ Please complete this card and return to the Sergeant-at-Arms ◀