

Int. No. 2261-A

By Council Members Cornegy, Levine, Gennaro and Louis (by request of the Mayor)

A Local Law to amend the administrative code of the city of New York, the New York city plumbing code, the New York city building code, the New York city mechanical code and the New York city fuel gas code in relation to bringing such codes and related provisions of law up to date with the 2015 editions of the international building, mechanical, fuel gas and plumbing codes, with differences that reflect the unique character of the city, clarifying and updating administration and enforcement of such codes and the 1968 code and repealing chapters 2 and 35, appendices K and M, section N102 of appendix N, appendices P and Q, and section R103.3 figures 1A and 1B of appendix R of the New York city building code, chapter 15 and appendix A of the New York city mechanical code and chapter 8 of the New York city fuel gas code in relation thereto

Be it enacted by the Council as follows:

1 Section 1. Legislative intent. This local law implements sections 28-601.1, 28-701.1, 28-
2 801.1 and 28-901.1 of the administrative code, which require regular updates of the New York city
3 plumbing code, the New York city building code, the New York city mechanical code and the New
4 York city fuel gas code to reflect changes in the International Plumbing, Building, Mechanical and
5 Fuel Gas Codes. These amendments will bring the New York city codes up to date with the 2015
6 editions of the International Plumbing, Building, Mechanical and Fuel Gas Codes published by the
7 International Code Council, with differences to accommodate the unique nature of construction in the
8 City. The local law is divided into parts A through E. Part A contains amendments to chapters 1
9 through 5 of title 28 of the administrative code in separately numbered sections within part A.
10 Chapters 1 through 5 contain general provisions governing administration and enforcement of all such
11 codes and the 1968 code. Parts B, C, D and E contain amendments to chapters 6 through 9 of title 28
12 of the administrative code and to the codes within such chapters-- chapter 6, containing the New York
13 city plumbing code (part B); chapter 7, containing the New York city building code, (part C); chapter
14 8, containing the New York city mechanical code, (part D); and chapter 9, containing the New York
15 city fuel gas code, (part E). Each part amends the relevant chapters and appendices of the relevant
16 code in separately numbered sections within the part.

1 Part A (Chapters 1 through 5 of Title 28)

2 § 1. Chapter 1 of title 28 of the administrative code of the city of New York, as added by
3 local law number 33 for the year 2007, sections 28-101.1, 28-101.2, 28-101.3.1, 28-101.4.5, 28-
4 101.5, 28-102.4.5, 28-102.5, 28-103.1, 28-103.16, 28-103.20 , article 104, article 105, sections 28-
5 107.1, 28-107.2, 28-107.3, 28-107.4, 28-107.5 , 28-113.1, 28- 113.3 , 28-113.4 , article 115, article
6 116, sections 28-117.1, 28-117.2, 28-117.5, 28-118.3.4.2, 28-118.16.2, 28-118.20, 28-118.21 as
7 amended by local law number 141 for the year 2013, sections 28-101.3, 28-102.7, 28-109.2, 28-109.3,
8 items 17, 20 and 21 of section 28-110.3, article 111, exception one of section 28-112.1, sections 28-
9 112.3, 28-112.7, 28-112.8 as amended by local law number 108 for the year 2008, exception 19 of
10 section 28-101.4.3 as added by local law number 13 for the year 2014, exception 20 as added by local
11 law number 15 for the year 2020, section 28-101.2.4 as added by local law number 17 for the year
12 2014, section 28 -103.1 item 5 and section 28-103.1.1 amended by local law number 195 for the year
13 2018, section 28-103.1.3 amended by local law number 80 for the year 2020, section 28-1103.7.1
14 added by local law number 39 for the year 2009, section 28-103.11 amended by local law number 10
15 for the year 2016, section 28-103.21.1 amended by local law number 78 for the year 2017, 28-103.24
16 amended by local law number 80 fir the year 2020, section 28-103.23 added by local law number 82
17 for the year 2013, section 28-103.26 added by local law 68 of 2017, section 28-103.27 added by local
18 law 158 of 2017, section 28-103.29 amended by local law number 219 for the year 2019, section
19 28-103.30.5 added by local law number 188 for the year 2017 and renumbered by local law number
20 233 for the year 2017, section 28-103.32 amended by local law number 80 for the year 2020, section
21 28-103.33 renumbered and amended by local law number 93 for the year 2019, section 28-103.35
22 added by local law number 59 for the year 2019, section 28- 103.36 added by local law number 15
23 for the year 2020, section 28-104.2 amended by chapter 217 of the laws of 2018, sections 28-104.2.1.
24 2, 28-104.2.1.3.2, 28-104.2.1.4 amended by local law number 108 for the year 2019, sections 28-

1 104.7.16, 28-104.8 amended by local law number 106 for the year 2019, section 28-105.1.2, added
2 by local law number 97 for the year 2017, sections 28-105.1.2 added by local law number 160 for the
3 year 2017, section 28-105.1.3 added by local law number 104 for the year 1019, sections 28-105.1.4
4 and 28-105.1. 5 added by local law number 114 for the year 2019, section 28-105.2,item 3 amended
5 by local law number 1 for the year 2011, item 10 amended by local law number 195 for the year 2018,
6 section 28-105.4 subdivisions 7 and 8 added and subdivision 9 amended by local law 195 for the
7 year 2018, section 28-105.5 amended by chapter 217 of the laws of 2018, section 28-105.10.1
8 amended by local law number 62 for the year 2019, section 28-105.11 amended by local law number
9 158 for the year 2017, section 105.12.7.1 amended by chapter 217 of the laws of 2018, section 28-
10 12.8 amended by local law number 81 for the year 2017, 28-105.12.9 added by local law number 196
11 for the year 2017, section 28-105.12.10 added by local law 106 of 219, section 28- 105.12.11 added
12 by local law number 111 for the year 2019, section 28-106.1 amended by local law 38 of 2015, section
13 28-106.2 added by local law 37 of 2009, sections 28-106.3 and 28-106.4 amended by local law 38 of
14 2015, section 28-109.1 amended by local law number 195 for the year 2018, table 112.2 amended by
15 local law number 56 for the year 2016, section 28-112.10 added by local law number 4 for the year
16 2016, section 28-112.10.2 amended by local law number 51 for the year 2013, section 28-112.11
17 added by local law number 33 for the year 2014, section 28-112.12 added by local law number 196
18 for the year 2017, section 28-113.5 added by local law number 2 for the year 2012, section 116.2.1
19 amended by local law number 115 for the year 2019, sections 28-116.2.4 and 28-116.2.4.3 amended
20 and added by local law number 151 for the year 2016, section 28-116.2.4.2 added by local law number
21 149 for the year 2017, section 28-116.7 added by local law number 97 for the year 2017, section 28-
22 117.4.4 amended by local law number 80 for the year 2020, section 28-118.22 added by local law
23 number 97 for the year 2017, section 28-119.4 added by local law number 154 for the year 2016,
24 article 120 amended by local laws 118 for the year 2019, 106 for the year 2019, and 116 for the year

1 2019, sections 28-101.5, 28-118.4.2, 28-118.15, 28-118.17, 28-118.19 and table 28-112.8 amended
2 by local law number 6 for the year 2021, is amended to read as follows:

3 **CHAPTER 1**

4 **ADMINISTRATION**

5 **ARTICLE 101**

6 **GENERAL**

7 **§28-101.1 Title.** The provisions of this chapter shall apply to the administration of the codes set forth
8 in this title and the 1968 building code. This title shall be known and may be cited as the “New York
9 city construction codes” and includes:

- 10 The New York city plumbing code.
- 11 The New York city building code.
- 12 The New York city mechanical code.
- 13 The New York city fuel gas code.
- 14 The New York city energy conservation code.

15 **§28-101.2 Intent.** The purpose of the New York city construction codes is to provide reasonable
16 minimum requirements and standards, based upon current scientific and engineering knowledge,
17 experience and techniques, and the utilization of modern machinery, equipment, materials, and forms
18 and methods of construction, for the regulation of building construction in the city of New York in
19 the interest of public safety, health, welfare and the environment, and with due regard for building
20 construction and maintenance costs.

21 **§28-101.3 Codes.** Any reference in this title to “this code” or “the code” shall be deemed to be a
22 reference to this title and all of the codes comprising the New York city construction codes unless
23 the context or subject matter requires otherwise. Whenever a section or subsection of this code is
24 cited or referred to, subordinate consecutively numbered sections and subsections of the cited
25 provision are deemed to be included in such reference unless the context or subject matter requires
26 otherwise.

27 **§28-101.3.1 Occupancy classifications in prior codes.** With regard to prior code buildings,
28 references to occupancy classifications in this code shall be deemed to refer to the equivalent
29 occupancy classification under the 1968 or prior building codes.

30 **§28-101.4 Effective date.** Except as otherwise provided in sections 28-101.4.1, 28-101.4.2, 28-
31 101.4.3, ~~and~~ 28-101.4.4, and 28-101.4.5, on and after July 1, 2008, all work shall be performed in
32 accordance with the provisions of this code.

33 **§28-101.4.1 Permit issued or work commenced prior to July 1, 2008.** If a permit for work was
34 issued prior to July 1, 2008 or, if no permit was necessary, work was commenced prior to July
35 1, 2008, all of the provisions of chapter 1 of title 27 of the administrative code as heretofore in
36 effect shall apply to such work.

1 **§28-101.4.2 Applications for construction document approval submitted prior to and within**
2 **twelve months after July 1, 2008.** Any work for which an application for construction document
3 approval was submitted to the department prior to July 1, 2008 and not thereafter abandoned, or
4 for which an application for construction document approval is submitted to the department
5 within a period of twelve months after such date may, at the option of the owner, be performed
6 in its entirety in accordance with the provisions of this code, or in accordance with the 1968
7 building code, provided that such work is commenced within twelve months after the date of
8 issuance of a permit [~~therefore~~] therefor and is diligently carried on to completion. The
9 commissioner may, for good cause, extend the time period for commencement of the work
10 beyond 12 months. Where the owner elects to perform the work in compliance with the 1968
11 building code, the following conditions shall apply:

- 12 1. Except as otherwise limited by the commissioner, administration and enforcement of the
13 1968 building code shall be in accordance with this code, including but not limited to
14 approval of construction documents, issuance of permits and certificates of occupancy,
15 tests and inspections, penalties and enforcement. Controlled inspections and semi-
16 controlled inspections as referenced in the 1968 building code shall be deemed to be
17 special inspections and shall comply with the provisions of this code relating to special
18 inspections. Materials regulated in their use by the 1968 building code shall be subject to
19 applicable provisions of this code.
- 20 2. Safety of public and property during construction operations including demolition shall
21 be governed by chapter 33 of the New York city building code.

22 **§28-101.4.3 Optional use of the 1968 building code for work on prior code buildings.** At the
23 option of the owner, and subject to applicable provisions of this code, work on prior code
24 buildings may be performed in accordance with the requirements and standards set forth in the
25 1968 building code, or where the 1968 code so authorizes, the code in effect prior to December
26 6, 1968.

27 **Exceptions:**

- 28 1. **Fuel gas, plumbing and mechanical work.** The installation of and work on all
29 appliances, equipment and systems regulated by the New York city fuel gas code, the
30 New York city plumbing code and the New York city mechanical code shall be
31 governed by applicable provisions of those codes relating to new and existing
32 installations.
- 33 2. **Fire protection systems.** Alterations of buildings and changes of use or occupancy
34 shall be governed by chapter 9 of the New York city building code, subject to special
35 provisions for prior code buildings as set forth therein.
- 36 3. **Elevators, conveyors and amusement rides.** The installation of and work on
37 elevators, conveyors, and amusement rides shall be governed by chapter 30 and
38 appendix K of the New York city building code and the rules of the department,
39 subject to special provisions for prior code buildings as set forth therein. [-]
- 40 4. **Safety during construction operations.** Safety of public and property during
41 construction operations including demolition shall be governed by chapter 33 of the
42 New York city building code.

- 1 5. **Accessibility.** Alterations, including minor alterations, of buildings and changes of
2 use or occupancy, shall be governed by chapter 11 of the New York city building
3 code, subject to special provisions for prior code buildings as set forth therein.
- 4 6. **Encroachments into the public right of way.** Encroachments onto the public right
5 of way shall be governed by chapter 32 of the New York city building code.
- 6 7. **Administration and enforcement.** Except as otherwise limited by the commissioner,
7 administration and enforcement of the 1968 building code shall be in accordance with
8 this code, including but not limited to approval of construction documents, issuance
9 of permits and certificates of occupancy, tests and inspections, penalties and
10 enforcement.
- 11 8. **Special inspections.** Controlled inspections and semi-controlled inspections as
12 referenced in the 1968 building code shall be deemed to be special inspections and
13 shall be governed by the provisions of this code relating to special inspections.
- 14 9. **Materials.** Materials regulated in their use by the 1968 building code shall be subject
15 to applicable provisions of this code.
- 16 10. **Security grilles.** The installation and replacement of security grilles shall comply
17 with section [~~1008.1.4.5~~] 1010.1.4.4 of the New York city building code.
- 18 [~~8.~~] 11. **Energy efficiency.** All work related to energy efficiency shall be regulated by
19 the New York city energy conservation code.
- 20 12. **Roof recovering and replacements.**
- 21 12.1. **Installation and materials.** Work involving the recovering or replacing of an
22 existing roof covering shall be governed by sections [~~1510.4~~] 1511.1 through
23 [~~1510.6~~] 1511.7 of the New York city building code;
- 24 12.2. **Cool roofs.** Work involving the recovering or replacing of an existing roof
25 covering shall comply with section 1504.9 of the New York city building code
26 unless the area to be recovered or replaced is less than fifty percent of the roof
27 area and less than 500 square feet (46 m²).
- 28 12.3. **Green roofs.** Notwithstanding the applicant's election to use the 1968 building
29 code or prior code, work involving green roof systems and container gardens
30 shall be permitted to be performed pursuant to Chapter 15 of the New York city
31 building code.
- 32 12.4. **Sustainable roofs.** Work involving the replacing of an entire existing roof deck
33 or roof assembly shall comply with section [~~1511.2~~] 1512.2 of the New York
34 city building code.
- 35 13. **Handrails.** Where the alteration of a building includes the addition or replacement of
36 an entire stair enclosure including the stairs, handrails shall comply with section
37 [~~1009.12~~] 1011.11 and section [~~1012~~] 1014 of the New York city building code.
38 Where the alteration of a building includes the addition or replacement of ramps,
39 handrails shall comply with section [~~1010.8~~] 1012.8 and section [~~1012~~] 1014 of such
40 code.

- 1 14. **Guards.** Where the alteration or repair of a building involves the addition or
2 replacement of guards, such guards shall comply with sections [~~1013~~] 1015 and
3 [~~1607.7~~] 1607.8 of the New York city building code.
- 4 15. [~~Areas of special flood~~] **Flood hazard areas.** Within [~~areas of special~~] flood hazard
5 areas in accordance with section 28-104.9.4, all work for any activity regulated by
6 Appendix G of the New York city building code shall be governed by such appendix.
- 7 16. **Structural.** The use of load resistance factor design (LRFD), calculation of live loads,
8 and applicability of seismic and wind loads shall be governed by special provisions
9 for prior code buildings as set forth in section 1601.2 of the New York city building
10 code.
- 11 17. **Emergency and standby power systems.** The installation of and work on emergency
12 and standby power systems shall comply with section 2702.1 of the New York city
13 building code.
- 14 18. **Parking garages and open parking lots.** Where an alteration of a parking garage or
15 an open parking lot includes an increase in the size of the electric service, such
16 alteration shall include provisions for the installation of electric vehicle charging
17 stations in accordance with section [~~406.2.11~~] 406.4.10 or [~~406.7.11~~] 406.9.8 of the
18 New York city building code, as applicable.
- 19 19. **Mold protection.** Alterations shall comply with sections 2506 and 2509 of the New
20 York city building code relating to areas subject to moisture or water damage.

21 **§28-101.4.4 Reductions of fire safety or structural safety of prior code buildings prohibited.**
22 Notwithstanding any other provision of this code, where the alteration of any prior code building
23 or structure in accordance with a provision of this code would result in a reduction of the fire
24 safety or structural safety of such building, relevant provisions of the 1968 building code shall
25 apply to such alteration unless there is full compliance with those provisions of this code that
26 would mitigate or offset such reduction of fire protection or structural safety. Where the owner,
27 having a choice to elect the 1968 building code or this code, chooses this code, the applicant
28 shall submit a comparative analysis acceptable to the commissioner of the relevant fire safety
29 and structural safety provisions under the 1968 building code and this code, demonstrating that
30 the alteration does not result in a reduction to the fire and life safety of the building.

31 **Exception:** The use of automatic-closing by smoke detection for doors serving vertical exit
32 enclosures in accordance with section [~~708.7~~] 713.7 of the New York city building code in a
33 prior code building shall not be deemed to result in a reduction of the fire safety or structural
34 safety of such a building.

35 **§28-101.4.5 Work that increases existing floor surface area of a prior code building by more**
36 **than 110 percent.** Notwithstanding sections 28-101.4.3 and 28-102.4.3 or any other provision of
37 this code that would authorize alterations of prior code buildings in accordance with the 1968
38 building code or prior codes, where the proposed work at the completion of construction will
39 increase the amount of floor surface area of a prior code building by more than 110 percent, over
40 the amount of existing floor surface area, such entire building shall be made to comply with the
41 provisions of this code as if it were a new building hereafter erected. See Section 28-105.2 for
42 permits for such work.

1 **Exceptions:** When determining the amount of existing floor surface area for the purposes
2 of section 28-101.4.5, the following shall be excluded from the measured square footage
3 of floor surface area:

- 4 1. The square footage of floors removed during the course of the work when such
5 floors are removed together with the supporting beams, joists, decking and slabs
6 on grade.
- 7 2. The square footage of any floor that was installed together with the supporting
8 beams, joists, decking and slabs on grade less than 12 months prior to submission
9 of the application for construction document approval for the proposed work. For
10 the purposes of this exception, floors installed pursuant to a work permit signed
11 off less than 12 months before such submission shall not be counted as existing
12 floor surface area.

13 **§28-101.4.5.1 Changes in scope of work.** In cases where changes in the scope of work during
14 the course of construction would result in increasing the floor surface area at the completion
15 of construction by more than 110 percent over the amount of existing floor surface area as
16 determined pursuant to section 28-101.4.5, such entire building shall be made to comply with
17 the provisions of this code as if hereafter erected and such work shall be refiled as a new
18 building application in accordance with the provisions of section 28-105.2.

19 **Exception:** Work to the extent necessary to relieve an emergency condition may be
20 performed prior to amending plans or obtaining a new permit pursuant to sections 28-
21 105.4.1 and 28-105.12.2.

22 **§28-101.4.5.2 Definitions.** As used in Section 28-101.4.5, the following term shall have the
23 following meaning unless the context or subject matter requires otherwise.

24 **FLOOR SURFACE AREA.** Floor surface area is the gross square foot area of all
25 horizontal floor and roof surfaces, including roofs of bulkheads and superstructures, of a
26 building or structure at any level, including cellar, attic and roof.

27 **§28-101.4.5.3 Effect on zoning resolution.** The provisions of section 28-101.4.5 shall not be
28 construed to affect the status of any nonconforming use or non-complying bulk otherwise
29 permitted to be retained pursuant to the New York city zoning resolution.

30 **§28-101.5 Definitions.** As used in this chapter and elsewhere in this title, the following terms shall
31 have the following meanings unless the context or subject matter requires otherwise:

32 **1968 BUILDING CODE.** Chapter 1 of title 27 of the administrative code as hereafter in effect.

33 **1968 OR PRIOR CODE BUILDINGS OR STRUCTURES (PRIOR CODE BUILDINGS).** (i) A
34 building or structure in existence prior to July 1, 2008 or one for which a lawful building permit was
35 issued for the erection of such building or structure prior to July 1, 2008. (ii) A building or structure
36 erected in accordance with the 1968 building code under a lawful building permit issued for the
37 erection of such building or structure on or after July 1, 2008 in accordance with section 28-101.4.2
38 of this code.

39 **ACCEPTANCE OR ACCEPTED.** In reference to construction documents, the endorsement by the
40 department of construction documents with less than full examination by the department based on

1 the professional certification of a registered design professional in accordance with a program
2 established by the commissioner.

3 **ADDITION.** An alteration of a building in existence that increases its exterior dimensions including,
4 but not limited to,² an extension or increase in floor area or height (including an increase in height or
5 area resulting from the construction of a rooftop structure or rooftop mechanical equipment) of the
6 building.

7 **ADMINISTRATIVE CODE.** The administrative code of the city of New York.

8 **ALTERATION.** Any construction, addition, change of use or occupancy, or renovation to a building
9 or structure in existence.

10 **APPROVAL OR APPROVED.** In reference to construction documents, the determination by the
11 department after full examination that submitted construction documents comply with this code and
12 other applicable laws and rules. In reference to materials, the determination by the commissioner
13 that material is acceptable for its intended use.

14 **APPROVED AGENCY.** An established and recognized agency [~~, or other qualified person,~~] that is
15 regularly engaged in conducting tests or furnishing inspection services, when approved pursuant to
16 department rules as qualified to perform or witness identified testing or inspection services.

17 **APPROVED FABRICATOR.** An established and qualified person, firm or corporation approved
18 by the commissioner to custom manufacture or build products or assemblies regulated by this code,
19 including the production of concrete.

20 **APPROVED INSPECTION AGENCY.** An approved agency that is approved by the department
21 as qualified to perform one or more of the inspections required by this code.

22 **APPROVED TESTING AGENCY.** An approved agency that is approved by the department as
23 qualified to test and evaluate the performance of one or more of the materials regulated in their use
24 by this code. Such term shall include, when approved pursuant to department rules, a third party
25 testing or certification agency, evaluation agency, testing laboratory, testing service, licensed
26 concrete testing laboratory, or other entity concerned with product evaluation.

27 **ARCHITECT.** A person licensed and registered to practice the profession of architecture under the
28 education law of the state of New York.

29 **BUILDING.** Any structure used or intended for supporting or sheltering any use or occupancy. The
30 term shall be construed as if followed by the phrase “structure, premises, lot or part thereof” unless
31 otherwise indicated by the text.

32 **CHARTER.** The New York city charter.

33 **CERTIFICATE OF COMPLIANCE.** A certificate stating that materials and products meet
34 specified standards [~~7~~] or that work was done in compliance with approved construction documents
35 and other applicable provisions of law, or,¹ with respect to specified service equipment, a certificate
36 issued by the department authorizing the operation of such equipment.

1 **CITY.** The city of New York.

2 **COMMISSIONER.** The commissioner of buildings of the city of New York, or his or her duly
3 authorized representative.

4 **CONSTRUCTION DOCUMENTS.** Plans and specifications and other written, graphic and
5 pictorial documents, prepared or assembled for describing the design, location, physical
6 characteristics, and other elements of the project necessary for obtaining a building permit.

7 **DAY.** A calendar day, computed in accordance with section 20 of the New York state general
8 construction law, unless otherwise specified as a business day.

9 **DEFERRED SUBMITTAL.** Those portions of the design that are not submitted at the time of the
10 application for construction document approval and that are to be submitted to the department within
11 a specified period of time after the issuance of a permit.

12 **DEMOLITION.** Full or partial demolition.

13 **DEMOLITION, FULL [§].** The dismantling, razing, or removal of all of a building or structure,
14 including all operations incidental thereto.

15 **DEMOLITION, PARTIAL [§].** The dismantling, razing, or removal of structural members, floors,
16 interior bearing walls, and/or exterior walls or portions thereof, including all operations incidental
17 thereto.

18 **DEPARTMENT.** The department of buildings of the city of New York.

19 **ENGINEER.** A person licensed and registered to practice the profession of engineering under the
20 education law of the state of New York.

21 **ENLARGEMENT.** An addition.

22 **ENVIRONMENTAL CONTROL BOARD or ECB.** The environmental control board established
23 pursuant to section 1049-a of the charter within the office of administrative trials and hearings.

24 **EXISTING BUILDING OR STRUCTURE.** A completed building or structure that is in existence
25 at the time of an applicable reference in this code.

26 **FABRICATED ITEM.** Products and assemblies regulated by this code [§] that are custom
27 manufactured [§] or built prior to their incorporation into the work at the construction site. Fabricated
28 items shall not include listed, labeled or approved products or assemblies. Materials produced in
29 accordance with standard specifications referenced by this code, such as rolled structural steel
30 shapes, steel-reinforcing bars, masonry units, and wood structural panels, or in accordance with a
31 referenced standard [§] listed in this code, which provides requirements for quality control done under
32 the supervision of a third-party quality control agency, shall not be considered fabricated items.

33 **FIRE PROTECTION PLAN.** A report containing a narrative description of the life and fire safety
34 systems and evacuation system for a structure.

1 **HEREAFTER.** On or after July 1, 2008.

2 **HERETOFORE.** Before July 1, 2008.

3 **INSPECTION CERTIFICATE.** Identification applied to a product by an approved agency
4 containing the name of the manufacturer, the function and performance characteristics, and the name
5 and identification of the approved agency that indicates that the product or material has been
6 inspected and evaluated by such approved agency. An inspection certificate shall also mean a
7 certificate issued by the department upon satisfactory completion of an inspection or test.

8 **INTERIM CERTIFICATE OF OCCUPANCY.** A type of temporary certificate of
9 occupancy authorizing occupancy of one or more floors of a building prior to the completion
10 of all work needed to obtain a certificate of occupancy for the building, and that remains in
11 effect until the issuance of a certificate of occupancy for the building.

12 **LABEL.** An identification applied [~~to material~~] on a product by the manufacturer that contains the
13 name of the manufacturer, the function and performance characteristics of the product or material,
14 and the name and identification of [~~the~~] an approved agency and that indicates that [~~the~~] a
15 representative sample of the product or material has been tested and evaluated by an approved agency
16 for compliance with nationally recognized standards or tests to determine suitable usage in a specific
17 manner.

18 **LABELED.** Material to which has been attached a label, symbol or other identifying mark of the
19 manufacturer that contains the name of the manufacturer, the function and performance
20 characteristics of the product or material, and the name and identification of an approved agency and
21 that indicates that a representative sample of the material has been tested and evaluated by an
22 approved agency for compliance with nationally recognized standards or tests to determine suitable
23 usage in a specified manner.

24 **LAND SURVEYOR.** A person licensed and registered to practice the profession of land surveying
25 under the education law of the state of New York.

26 **LANDSCAPE ARCHITECT.** A person licensed and registered to practice the profession of
27 landscape architecture under [~~the Education Law of the State of New York~~] the education law of the
28 state of New York.

29 **LETTER OF COMPLETION.** A document issued by the department indicating that permitted
30 work has been completed, including satisfactory final inspection in accordance with this code. A
31 letter of completion is issued only in circumstances where a certificate of occupancy is not required
32 upon completion of the permitted work.

33 **LIMITED ALTERATION APPLICATION.** Application for limited oil-burning appliance
34 alterations, limited plumbing alterations, limited sprinkler alterations and limited standpipe
35 alterations submitted pursuant to exception 1 of section 28-104.6. Such work shall not include any
36 associated work that would otherwise require an alteration permit including, but not limited to, any
37 construction of fire rated partitions and enclosures.

1 Category 1 work shall be limited to a new installation into an existing building or system. The
2 utilization of this category shall be limited by an annual monetary cap.

3 Category 2 work shall include any existing system or component that is replaced, repaired or
4 altered. This category shall not be limited by a monetary cap.

5 **LIMITED OIL-BURNING ~~[BOILER]~~ APPLIANCE ALTERATIONS.** An alteration,
6 installation, replacement or repair to an ~~[oil burner/boiler system]~~ oil-burning appliance that is
7 limited in scope, falling into one of the following categories [∓]. Any construction or alteration to
8 fire-rated partitions or enclosures, with the exception of through-penetrations that are firestopped,
9 shall require a separate application filed with the department.

10 **Category 1.** An ~~[alteration]~~ addition to an ~~[oil burner/boiler system]~~ existing oil-burning
11 appliance where the total cost of the proposed category 1 work in the building does not exceed
12 ~~[thirty five] [fifty thousand dollars]~~ \$50,000 in any 12-month period and where the proposed
13 work is limited to the ~~[replacement]~~ installation of:

- 14 1. oil equipment [∅] ,
- 15 2. oil-fired appliances, located within the same enclosure or room as the existing oil-burning
16 appliance,
- 17 3. unit heaters, or
- 18 4. oil piping including no more than two above-ground oil tanks each with a capacity of no
19 more than 330 gallons (1250 L) ~~[or less capacity provided the replacement]~~ provided such
20 oil tanks also comply with the capacity limits established in section 1305.11 of the New
21 York city mechanical code. The newly installed tanks shall have a UL listing, ~~[or~~
22 labeling] be labeled or meet the alternative tank design and construction standards
23 contained in section 1305.14 of the New York city mechanical code.

24 **Category 2.** An alteration ~~[to]~~ , repair or replacement of an ~~[oil burner/boiler system]~~ existing
25 oil-burning appliance that is not subject to cost or duration limitations and that is limited to the
26 following:

- 27 1. Replacement of oil burners, oil-burning ~~[boilers]~~ appliances or water ~~[heater with]~~ heaters
28 in which the heat input ~~[of 1]~~ per appliance does not exceed 3 million Btu/h ([293] 879
29 kW) ~~[or less].~~
- 30 ~~[2. Replacement of oil burners with heat input of 2.8 million Btu/h (821 kW) or less.]~~
- 31 ~~[3.]~~ 2. Relocation of an oil burner or oil-burning ~~[boiler]~~ appliance or water heater within
32 the same ~~[, unaltered fire-rated]~~ enclosure or room.
- 33 ~~[4.]~~ 3. Placement of a temporary department of buildings registered oil fired mobile boiler
34 and corresponding fuel oil storage tank with associated piping at a site for emergency
35 heating.
- 36 4. Placement of a temporary fuel oil storage tank with a capacity of 5,000 gallons (18 927
37 L) or less at a site for emergency use and connected to an existing oil-burning appliance.
- 38 5. Repair, replacement or relocation of oil equipment, appliances or oil piping including two
39 above-ground oil tanks with 330 gallons (1250 L) provided such oil tanks also comply

1 with the capacity limitations of section 1305.11 of the New York city mechanical code.
2 The replacement tanks shall have a UL listing or labeling or meet the alternative tank
3 design and construction standards contained in section 1305.14 of the New York city
4 mechanical code. Any such relocation shall be only within the same enclosure or room.

5 **LIMITED PLUMBING ALTERATIONS.** An installation, replacement, repair or alteration to a
6 plumbing or fuel gas piping system, including fixtures and appliances, that is limited in scope, falling
7 into one of the following categories:

8 **Category 1.** An ~~[alteration]~~ addition to [a] an existing plumbing or fuel gas piping system or
9 service where the total cost of the proposed Category 1 work in the building does not exceed
10 ~~[thirty-five] [thousand dollars]~~ \$50,000 in any 12-month period and where the proposed work is
11 limited to the following:

- 12 1. The addition of not more than ~~[5]~~ five plumbing fixtures or fixture connections in a
13 building within any 12-month period, including any associated plumbing necessary to
14 serve such additional fixtures or fixture connections;
- 15 2. The installation of new ~~[plumbing or]~~ fuel gas piping ~~[-, excluding work in Category 2]~~ in
16 conjunction with the addition of not more than five gas appliances or six unit heaters,
17 limited to residential gas barbecue, Category 1 vented hot water heater, gas infrared heater,
18 gas light, gas oil burner pilot, gas pool heater in conjunction with an R-3 occupancy group,
19 one commercial gas appliance and gas unit heater, including any associated fuel gas piping
20 necessary to serve such additional appliances;
- 21 3. The installation of up to five new sprinkler heads off of an existing domestic water system
22 within any 12-month period;
- 23 ~~[4. Rearrangement of not more than 20 sprinkler heads in areas classified in light hazard~~
24 ~~occupancy, as such term is defined in NFPA 13 as amended by appendix Q of the New~~
25 ~~York city building code, provided such areas are already sprinklered and such areas will~~
26 ~~remain in such occupancy, and provided further that all such sprinkler heads are off of a~~
27 ~~domestic water system;]~~
- 28 ~~[5. Rearrangement of not more than 20 sprinkler heads in restaurant service areas classified~~
29 ~~in Group 1 ordinary hazard occupancy, as such term is defined by NFPA 13 as amended~~
30 ~~by appendix Q of the New York city building code, provided such areas are already~~
31 ~~sprinklered and such areas will remain in such occupancy, and provided further that all~~
32 ~~such sprinkler heads are off of a domestic water system;]~~
- 33 ~~[6. Rearrangement of not more than 20 sprinkler heads in mercantile areas classified in Group~~
34 ~~2 ordinary hazard occupancy, as such term is defined by NFPA 13 as amended by~~
35 ~~appendix Q of the New York city building code, provided such areas are already~~
36 ~~sprinklered and such areas will remain in such occupancy, and provided further that all~~
37 ~~such sprinkler heads are off of a domestic water system;]~~
- 38 ~~[7. In kind replacement of piping and parts is required for the operation of a standpipe,~~
39 ~~provided that a sprinkler is not connected or is not now being connected to such system;~~
40 ~~and]~~
- 41 ~~[8. Replacement of parts required for the operation of a standpipe system that is not a~~
42 ~~combined standpipe system.]~~

- 1 4. Installation of a new single domestic gas dryer that is vented directly through an exterior
2 wall in buildings occupied exclusively as one- or two-family dwellings not more than three
3 stories in height, as provided for in rules of the department.

4 **Category 2.** ~~[A~~n~~]~~ The repair, replacement of or alteration to [a] an existing plumbing or fuel gas
5 pipng system that is not subject to cost or duration limitations and that is limited to the following:

- 6 1. The ~~[rerouting]~~ repair, replacement of or alteration of existing plumbing or fuel gas
7 ~~[branch]~~ piping to serve the same number of fixtures and appliances;
- 8 2. The in-kind replacement of plumbing fixtures and gas appliances that do not provide heat
9 or hot water when not constituting a minor alteration or ordinary repair under this code.
10 This shall not preclude plumbing work that is a minor alteration or ordinary repair from
11 being filed as a limited alteration application;
- 12 3. The relocation and ~~[mounting]~~ replacement of ~~[new]~~ plumbing fixtures ~~[on existing~~
13 ~~roughing]~~ , other than the mere replacement of existing fixtures constituting a minor
14 alteration or ordinary repair under this code. This shall not preclude the relocation and
15 replacement of plumbing fixtures that is a minor alteration or ordinary repair from being
16 filed as a limited alteration application;
- 17 4. The installation or replacement of primary backflow preventers;
- 18 5. ~~[Replacement]~~ In-kind replacement of gas-fired [boilers] appliances with a combined heat
19 input of [4] 3 million Btu/h ([293] 879kW) or less;
- 20 6. Replacement of gas burners with heat input of ~~[2-8]~~ 3 million Btu/h ([824] 879 kW) or
21 less;
- 22 7. Relocation of a gas burner/boiler within the same, unaltered fire-rated enclosure or room,
23 with the exception of through-penetrations that are firestopped;
- 24 8. In-kind replacement with the following direct-vent appliances with heat input of 350,000
25 Btu/h (103 kW) or less that are vented directly through exterior walls serving buildings
26 occupied exclusively as one- or two-family dwellings not more than four stories in height
27 ~~[, as provided for in rules by the department, regarding gas-fired boilers, hot water heaters~~
28 ~~and furnaces;];~~
- 29 8.1. gas-fired boilers,
- 30 8.2. hot water heaters and
- 31 8.3. furnaces;
- 32 9. ~~[Installation of a new single domestic gas dryer that is vented directly through an exterior~~
33 ~~wall in buildings occupied exclusively as one- or two-family dwellings not more than four~~
34 ~~stories in height, as provided for in rules by the department]~~ In-kind direct replacement of
35 gas-fired boilers, hot water heaters and furnaces with heat input of 350,000 Btu/h (103
36 kW) or less; that are vented directly through exterior walls;
- 37 10. Placement of a registered gas fired temporary boiler with associated gas piping at a site
38 for emergency heating and/or hot water; ~~[and]~~

1 11. Replacement of up to thirty existing sprinkler heads providing that orifice sizes, type and
2 deflector positions remain the same, and all such sprinkler heads are off of a domestic
3 water system [-];

4 12. Rearrangement of not more than 20 sprinkler heads in areas classified in light hazard
5 occupancy, as such term is defined in NFPA 13 as amended by appendix Q of the New
6 York city building code, provided such areas are already sprinklered and such areas will
7 remain in such occupancy, and provided further that all such sprinkler heads were legally
8 installed off of a domestic water system;

9 13. Rearrangement of not more than 20 sprinkler heads in restaurant service areas classified
10 in Group 1 ordinary hazard occupancy, as such term is defined by NFPA 13 as amended
11 by appendix Q of the New York city building code, provided such areas are already
12 sprinklered and such areas will remain in such occupancy, and provided further that all
13 such sprinkler heads were legally installed off of a domestic water system; and

14 14. Rearrangement of not more than 20 sprinkler heads in mercantile areas classified in Group
15 2 ordinary hazard occupancy, as such term is defined by NFPA 13 as amended by
16 appendix Q of the New York city building code, provided such areas are already
17 sprinklered and such areas will remain in such occupancy, and provided further that all
18 such sprinkler heads were legally installed off of a domestic water system.

19 **LIMITED SPRINKLER ALTERATIONS.** An alteration, installation, replacement or repair to a
20 sprinkler system that is limited in scope, falling into one of the following categories:

21 **Category 1.** An alteration to an existing sprinkler system where the total cost of the proposed
22 Category 1 work in the building does not exceed [~~thirty five~~] [~~fifty thousand dollars~~] \$50,000 in
23 any 12-month period, the fire rating of the area where the new sprinkler heads are being installed
24 is not being altered and [~~where~~] the proposed work is limited to [~~the following:~~] the installation
25 of up to five new sprinkler heads off of an existing sprinkler system.

26 [~~1. Replacement of parts required for the operation of a sprinkler system;]~~

27 [~~2. Changes that do not alter the type of sprinkler system;]~~

28 [~~3. Relocation of piping that does not affect the operation of the sprinkler system;]~~

29 [~~4. Rearrangement of not more than 20 sprinkler heads in areas classified in light hazard~~
30 ~~occupancy, as such term is defined in NFPA 13 as amended by appendix Q of the New~~
31 ~~York city building code, provided such areas area already sprinklered and such areas will~~
32 ~~remain in such occupancy;]~~

33 [~~5. Rearrangement of not more than 20 sprinkler heads in restaurant service areas classified in~~
34 ~~Group 1 ordinary hazard occupancy, as such term is defined in NFPA 13 as amended by~~
35 ~~appendix Q of the New York city building code, provided such areas are already~~
36 ~~sprinklered and such areas will remain in such occupancy;]~~

37 [~~6. Rearrangement of not more than 20 sprinkler heads in mercantile areas classified in Group~~
38 ~~2 ordinary hazard occupancy, as such term is defined in NFPA 13 as amended by appendix~~
39 ~~Q of the New York city building code, provided such areas are already sprinklered and~~
40 ~~such areas will remain in such occupancy; and]~~

41 [~~7. The installation of up to five new sprinkler heads off of an existing sprinkler system.]~~

1 **Category 2.** An alteration, repair or replacement of [to] an existing sprinkler system or combined
2 sprinkler standpipe system that is not subject to cost or duration limitations and that is limited to
3 ~~[the replacement of sprinkler heads, provided that orifice sizes, type and deflector positions~~
4 ~~remain the same.];~~

- 5 1. The replacement of sprinkler heads, provided that orifice sizes, type and deflector
6 positions remain the same;
- 7 2. Replacement of parts required for the operation of a sprinkler system or combined
8 sprinkler standpipe system, provided that orifice sizes, type and deflector positions remain
9 the same;
- 10 3. Changes that do not alter the type of sprinkler system;
- 11 4. Relocation of piping that does not affect the operation of the sprinkler system, provided
12 that orifice sizes, type and deflector positions remain the same;
- 13 5. Rearrangement of not more than 30 sprinkler heads in areas classified in light hazard
14 occupancy, as such term is defined in NFPA 13 as amended by appendix Q of the New
15 York city building code, provided such areas are already sprinklered and such areas will
16 remain in such occupancy;
- 17 6. Rearrangement of not more than 30 sprinkler heads in restaurant service areas classified
18 in Group 1 ordinary hazard occupancy, as such term is defined in NFPA 13 as amended
19 by appendix Q of the New York city building code, provided such areas are already
20 sprinklered and such areas will remain in such occupancy;
- 21 7. Rearrangement of not more than 30 sprinkler heads in mercantile areas classified in Group
22 2 ordinary hazard occupancy, as such term is defined by NFPA 13 as amended by
23 appendix Q of the New York city building code, provided such areas are already
24 sprinklered and such areas will remain in such occupancy;
- 25 8. Rearrangement of sprinkler heads in a storage area under 200 square feet classified Group
26 1 ordinary hazard, as such term is defined by NFPA 13 as amended by appendix Q of the
27 New York city building code, provided such areas are already sprinklered and such areas
28 will remain in such occupancy;
- 29 9. Unlimited cut and cap of an existing sprinkler system associated with a permitted
30 demolition or gut renovation; and
- 31 10. Relocation of a fire department connection as part of a combined system.

32 **LIMITED STANDPIPE ALTERATIONS. Category 2.** An alteration, replacement or repair to an
33 existing standalone or combined standpipe system that is limited ~~[in scope falling into the following~~
34 ~~category]~~ to the following:

35 ~~[Category 1. An alteration to an existing combined standpipe system where the total cost of the~~
36 ~~proposed work in the building does not exceed thirty five thousand dollars in any 12 month period~~
37 ~~and the proposed work is limited to one or more of the following:]~~

- 38 1. Replacement or relocation of parts required for the operation of a standalone or combined
39 standpipe system; [and]

- 1 2. Relocation of standalone or combined standpipe auxiliary hose sources and cabinets
2 within 10 feet (3048 mm) of their original location, provided that the existing covered area
3 is not affected and provided that such relocation complies with this code for a new
4 installation [-]; and
- 5 3. Unlimited cut and cap of an existing standalone or combined standpipe system for a
6 demolition or gut renovation.

7 **LISTED.** Material identified in a list published by an approved agency that maintains periodic
8 inspection of production of listed material or periodic evaluation services whose listing states either
9 that the material meets identified nationally recognized standards or has been tested and found
10 suitable for a specified purpose when installed in accordance with the manufacturer’s installation
11 instructions.

12 **MAIN USE OR DOMINANT OCCUPANCY (OF A BUILDING).** Refers to a single occupancy
13 classification assigned to a structure by the department according to such structure’s main use or
14 dominant occupancy.

15 **MANUFACTURER’S DESIGNATION.** Identification applied to material by the manufacturer
16 indicating that the material complies with a specified standard or set of rules (see “label” and
17 “mark”).

18 **MARK.** Identification applied to a product by the manufacturer indicating the name of the
19 manufacturer and the function of a product or material (see “Label” and “Manufacturer’s Label and
20 designation”).

21 **MATERIALS.** Materials, assemblies, appliances, equipment, devices, systems, products and
22 methods of construction regulated in their use by this code or regulated in their use by the 1968
23 building code.

24 **OCCUPANCY.** The purpose or activity for which a building or space is used or is designed,
25 arranged or intended to be used.

26 **OWNER.** Any person, agent, firm, partnership, corporation or other legal entity having a legal or
27 equitable interest in, or control of the premises.

28 **PARTY WALL.** A fire division on an interior lot line common to two adjoining buildings.

29 **PERMIT.** An official document or certificate issued by the commissioner that authorizes
30 performance of specified work or activity.

31 **PERSON.** An individual, partnership, corporation, or other legal entity.

32 **PREMISES.** Land, improvements thereon, or any part thereof.

33 **PRIOR CODE BUILDING.** See 1968 OR PRIOR CODE BUILDING OR STRUCTURE (PRIOR
34 CODE BUILDING).

35 **PROFESSIONAL CERTIFICATION.** A personal verification of a registered design professional
36 made under such professional’s signature and seal that accompanies construction documents and

1 other related documents filed with the department and that attests that such documents do not contain
2 false information and are in compliance with all applicable provisions of law.

3 **PROGRESS INSPECTION.** Inspection of permitted construction work in progress to verify
4 compliance with the code and with approved construction documents.

5 **PROJECT.** A design and construction undertaking comprised of work related to one or more
6 buildings or structures and the site improvements. A project is represented by one or more plan/work
7 applications, including construction documents compiled in accordance with article 104 of this
8 chapter, that relate either to the construction of new buildings or structures or to the demolition or
9 alteration of existing buildings or structures. Applications for a project may have different registered
10 design professionals and different application numbers, and may result in the issuance of one or more
11 permits.

12 **REGISTERED DESIGN PROFESSIONAL.** An architect or engineer.

13 **REGISTERED DESIGN PROFESSIONAL OF RECORD.** The registered design professional
14 who prepared or supervised the preparation of applicable construction documents filed with the
15 department.

16 **REQUIRED.** Shall mean required by the provisions of this code.

17 **RETAINING WALL.** A wall designed to prevent the lateral displacement of soil or other materials.

18 **SERVICE EQUIPMENT.** Equipment or systems, and all components thereof, that provide
19 sanitation, power, light, heat, ventilation, air conditioning, refuse disposal, fire-fighting,
20 transportation or other facilities for buildings.

21 **SIGN-OFF.** The issuance by the department of a letter of completion or certificate of occupancy for
22 permitted work indicating the satisfactory completion of all required inspections and receipt by the
23 department of all required submittal documents.

24 **SINGLE ROOM OCCUPANCY MULTIPLE DWELLING.** See section 28-107.2.

25 **SPECIAL INSPECTION.** Inspection and testing of selected materials, equipment, installation,
26 fabrication, erection or placement of components and connections, to ensure compliance with
27 approved construction documents and referenced standards as required by chapter 17 of the New
28 York city building code or elsewhere in this code or its referenced standards.

29 **SPECIAL INSPECTION AGENCY.** An agency employing one or more persons who are special
30 inspectors and that meets the requirements of department rules.

31 **SPECIAL INSPECTOR.** An individual employed by a special inspection agency having required
32 qualifications and authorized by department rules to perform or witness particular special inspections
33 required by this code or by the rules of the department, including but not limited to a qualified
34 registered design professional so authorized.

1 **STRUCTURE.** That which is built or constructed, including among others: buildings, stadia, tents,
2 reviewing stands, platforms, stagings, observation towers, radio towers, tanks, trestles, open sheds,
3 shelters, fences, and display signs.

4 **SUBMITTAL DOCUMENTS.** Completed application forms, construction documents, reports and
5 any other documents submitted in compliance with this code or other applicable laws and rules
6 including but not limited to special inspection reports, certifications or approvals from other
7 governmental agencies and other data required by this code or by the department.

8 **SUPERINTENDENT OF CONSTRUCTION (CONSTRUCTION SUPERINTENDENT).** An
9 individual, when authorized pursuant to department rules as qualified to superintend permitted
10 construction work on behalf of the owner.

11 **USE (USED).** The purpose for which a building, structure, or space is occupied or utilized, unless
12 otherwise indicated by the text. Use (used) shall be construed as if followed by the words “or is
13 intended, arranged, or designed to be used.”

14 **UTILITY COMPANY OR PUBLIC UTILITY COMPANY.** The term shall be construed to have
15 the same meaning as that contained in section two of the New York state public service law.

16 **UTILITY CORPORATION OR PUBLIC UTILITY CORPORATION.** The term shall be
17 construed to have the same meaning as that contained in section two of the New York state public
18 service law.

19 **WORK NOT CONSTITUTING MINOR ALTERATIONS OR ORDINARY REPAIRS.** See
20 section 28-105.4.2.1.

21 **WRITING (WRITTEN).** The term shall be construed to include handwriting, typewriting, printing,
22 photo-offset, or any other form of reproduction in legible symbols or characters, including, in the
23 discretion of the commissioner, electronic media.

24 **WRITTEN NOTICE.** A notification in writing delivered by hand to the person or parties intended,
25 or delivered at or sent by mail or in the discretion of the commissioner by electronic media to the
26 last address known to the party giving such notice.

27 **ZONING RESOLUTION.** The zoning resolution of the city of New York, adopted December
28 fifteenth, nineteen hundred sixty-one, including all amendments thereto.

29 **ARTICLE 102**
30 **APPLICABILITY**

31 **§28-102.1 General.** Where, in any specific case, different sections of this code specify different
32 materials, methods of construction or other requirements, the most restrictive shall govern. Where a
33 general requirement conflicts with a specific requirement, the specific requirement shall govern.
34 Where British and metric units of measurement conflict, the British units shall govern.

35 **§28-102.2 Other laws.** The provisions of this code do not presumptively provide for matters that are
36 contained in the charter, the New York state labor law, the New York state multiple dwelling law,
37 the zoning resolution, or the New York state general city law. Where there is conflict or

1 inconsistency between the requirements of this code and other applicable laws and rules, unless
2 otherwise required, such conflict shall be resolved in favor of the more restrictive requirement.

3 **§28-102.3 Separability.** If any clause, sentence, paragraph, section or part of this code shall be
4 adjudged to be invalid, such judgment shall not affect, impair or invalidate the remainder thereof,
5 but shall be confined in its operation to the clause, sentence, paragraph, or part thereof directly
6 involved in the controversy in which such judgment shall have been rendered.

7 **§28-102.4 Existing buildings.** The lawful use or occupancy of any existing building or structure,
8 including the use of any service equipment therein, may be continued unless a retroactive change is
9 specifically required by the provisions of this code or other applicable laws or rules.

10 **§28-102.4.1 Prior code buildings must comply with the applicable retroactive requirements**
11 **of the 1968 building code.** Prior code buildings must comply with the applicable retroactive
12 requirements of the 1968 building code including those requiring the installation of fire safety
13 and building safety systems and the filing of verifying reports with the department of such
14 installations by the dates specified in section 27-228.5 of the administrative code or in other
15 applicable provisions of such 1968 building code. A violation of such provisions shall be a
16 violation of this code.

17 **§28-102.4.2 Change in use or occupancy.** Except as otherwise provided in sections 28-101.4.1,
18 28-101.4.2, 28-101.4.3 or 28-101.4.4 changes in the use or occupancy of any building or
19 structure made after July 1, 2008 shall comply with the provisions of this code. Any changes
20 made in the use or occupancy of a building or structure not in compliance with this code shall be
21 prohibited and shall be a violation of this code. After a change in use or occupancy has been
22 made in a building, the re-establishment of a prior use or occupancy that would not be lawful in
23 a new building of the same construction class shall be prohibited unless and until all the
24 applicable provisions of this code and other applicable laws and rules for such reestablished use
25 or occupancy shall have been complied with. A change from a use prohibited by the provisions
26 of this code, but which was permitted prior to July 1, 2008, to another use prohibited by the
27 provisions of this code shall be deemed a violation of this code.

28 **§28-102.4.3 Alteration of prior code buildings.** Except as otherwise provided in sections 28-
29 101.4.1, 28-101.4.2, 28-101.4.3 and 28-101.4.4, prior code buildings altered after July 1, 2008
30 shall comply with the provisions of this code. In accordance with subdivision eleven of section
31 three of the New York state multiple dwelling law and article 4 of subchapter 1 of the 1968
32 building code, at the option of the owner, multiple dwellings erected prior to December 6, 1969
33 may be altered and buildings erected prior to December 6, 1969 may be converted to multiple
34 dwellings in accordance with applicable provisions of the New York state multiple dwelling law
35 and the building laws and regulations in effect prior to December 6, 1968, provided the general
36 safety and public welfare are not thereby endangered. At a minimum, the application of sections
37 28-101.4.3, 28-101.4.4 and 28-101.4.5 to any such alteration shall be deemed necessary to
38 protect the general safety and public welfare.

39 **§28-102.4.4 Continuation of unlawful use or occupancy.** The continuation of the unlawful use
40 or occupancy of a building or structure contrary to the provisions of this code, or contrary to the
41 provisions of prior codes or other applicable law or rule, shall be a violation of this code.

6. Fire fighting equipment, access to and within premises upon or in which construction and demolition work is being conducted, and the conduct of all construction or demolition work affecting fire prevention and fire fighting;
7. Any exhaust system designed or used for commercial cooking equipment, when such commercial cooking equipment is required to be protected by a fire extinguishing system; and
8. The installation and testing of natural gas distribution piping systems designed for or operated at a gas pressure of 15 psig (103 kPa gauge) or greater.

§28-103.1.1 Installation of equipment required by the New York city fire code. Where the installation of exit signs, emergency means of egress illumination, special mechanical ventilation, sprinkler systems, fire alarm systems and alternative automatic fire extinguishing systems is required by the New York city fire code, the fire commissioner shall require such installations to be in accordance with this code.

§28-103.1.2 Enforcement of New York city construction codes on property within the jurisdiction of the department of small business services. This code and the 1968 building code shall apply to property within the jurisdiction of the department of small business services pursuant to the New York city charter including, but not limited to, structures on waterfront property used in conjunction with and in furtherance of waterfront commerce and/or navigation. It shall be administered and enforced by the department of small business services in the same manner as property within the jurisdiction of the department.

§28-103.1.3 Innovation review board. There is hereby established within the department an innovation review board which shall include as members in addition to the commissioner, the commissioners of environmental protection, health and mental hygiene and design and construction and the chairperson of the city planning commission, or their respective designees. The commissioner shall also designate members from among the fire commissioner and the commissioners of transportation, parks and recreation, consumer affairs, emergency management, housing preservation and development and sanitation and the chairperson of the landmarks preservation commission, and non-governmental organizations and individuals, or their respective designees, with respect to specific matters being considered by the board where the commissioner determines it appropriate to do so.

§28-103.1.3.1 Meetings and recommendations. The commissioner shall convene the innovation review board at least quarterly, or more often as the commissioner may deem necessary to address issues in a timely manner to (i) review specific projects that propose to employ new technologies, design or construction techniques, materials or products, (ii) review proposals for approval of and to initiate reviews of such new technologies, design or construction techniques, materials or products in order to determine their environmental and sustainability benefits, (iii) make recommendations as to under what conditions and for what purposes each may be appropriately employed in New York city, and (iv) streamline approvals of specific innovative projects. If the board recommends that a technology, design or construction technique, material or product may appropriately be employed, the commissioner shall consider such recommendation and may by rule or other method as the commissioner deems appropriate, authorize the use of such technology, design or construction technique, material or product and under what conditions and for what purposes

1 each may be appropriately employed. The commissioner shall state in writing to the
2 interagency green team established pursuant to subdivision i of section twenty of the charter
3 what action the commissioner shall take with respect to each such recommendation and the
4 reasons for the action taken.

5 **§28-103.2 Interpretation.** This code shall be liberally interpreted to secure the beneficial purposes
6 thereof.

7 **§28-103.3 Variations.** The requirements and standards prescribed in this code shall be subject to
8 variation in specific cases by the commissioner, or by the board of standards and appeals, under and
9 pursuant to the provisions of paragraph two of subdivision (b) of section six hundred forty-five and
10 section six hundred sixty-six of the New York city charter, as amended.

11 **§28-103.4 Appeals.** An appeal from any decision or interpretation of the commissioner may be taken
12 to the board of standards and appeals pursuant to the procedures of the board, except as provided in
13 section 25-204 of the administrative code or as otherwise provided in this code.

14 **§28-103.5 Seal; judicial notice.** The commissioner may design and adopt a seal for the department
15 for use in the authentication of the orders and proceedings of the department, and for such other
16 purposes as the commissioner may prescribe. The courts shall take judicial notice of such seal, and
17 of the signature of the commissioner, the deputy commissioners, and the borough superintendents
18 of the department.

19 **§28-103.6 Proofs, affidavits and oaths.** Proofs, affidavits and examinations as to any matter arising
20 in connection with the performance of any of the duties of the department may be taken by or before
21 the commissioner, or a deputy commissioner, or such other person as the commissioner may desig-
22 nate; and such commissioner, deputy or other person may administer oaths in connection therewith.

23 **§28-103.7 Cooperation of other departments.** Upon request of the commissioner, it shall be the
24 duty of all departments to cooperate with the department of buildings at all times, and to furnish to
25 such department such information, reports and assistance as the commissioner may require.

26 **§28-103.7.1 Sharing results of buildings inspections.** The commissioner, the fire commissioner
27 and the commissioner of the department of environmental protection shall ~~establish a procedure,~~
28 ~~the implementation of which shall begin within six months of the effective date of this section,~~
29 ~~to~~ share information regarding violations issued as a result of inspections of buildings meeting
30 agreed-upon criteria that are relevant to the responsibilities of each department.

31 **§28-103.8 Matters not provided for.** Any matter or requirement essential for fire or structural safety
32 or essential for the safety or health of the occupants or users of a structure or the public, and which
33 is not covered by the provisions of this code or other applicable laws and rules, shall be subject to
34 determination and requirements by the commissioner in specific cases.

35 **§28-103.9 Additional tests.** Whenever there is insufficient evidence of compliance with the
36 provisions of this code, or evidence that a material or method of construction does not conform to
37 the requirements of this code, or in order to substantiate claims for alternative materials or methods,
38 the commissioner shall have the authority to require tests as evidence of compliance to be made at
39 no expense to the city. Test methods shall be as specified in this code, or by other recognized test
40 standards approved by the commissioner. In the absence of recognized and accepted test methods,

1 the commissioner shall approve the testing procedures. Tests shall be performed as directed by the
2 commissioner. Reports of such tests shall be retained by the department for the period required for
3 retention of public records.

4 **§28-103.10 Supporting documentation for materials.** Whenever this code or the rules of the
5 department permits the use of material regulated in its use by this code or the 1968 building code
6 without the prior approval of the commissioner, the commissioner may, in the interest of public
7 safety, require the submittal of supporting documentation that any material used or proposed to be
8 used complies with the applicable code standard for such use. Such supporting documentation may
9 consist of but shall not be limited to certification documents of an approved agency, test reports,
10 analysis, computations or other evidence of such compliance.

11 **§28-103.11 Applications and permits.** The department shall receive and review applications,
12 construction documents, and other related documents and shall issue permits, in accordance with the
13 provisions of this code. The department shall, on a weekly basis, send council members and
14 community boards, by electronic mail, a copy of all completed applications for a new building or an
15 alteration that will require a new certificate of occupancy for a building, received during the prior
16 week, disaggregated by community board. In addition, the department shall post such information
17 on its website on a weekly basis.

18 **§28-103.12 Identification.** Department personnel shall carry metal badges with suitable inscriptions
19 thereon or other prescribed identification when inspecting structures or premises or otherwise in the
20 performance of their duties under this code.

21 **§28-103.13 Right of entry.** The commissioner or his or her authorized representatives, in the
22 discharge of their duties, shall have the right to enter upon and inspect, at all reasonable times, any
23 buildings, enclosure, premises, or any part thereof, or any signs or service equipment contained
24 therein or attached thereto for the purpose of determining compliance with the provisions of this
25 code and other applicable building laws and rules. Officers and employees of the department shall
26 identify themselves by exhibiting the official badge or other identification prescribed by the
27 department; and other authorized representatives of the commissioner shall identify themselves by
28 producing and exhibiting their authority in writing signed by the commissioner. If access is not
29 obtained, the commissioner shall have recourse to remedies provided by law to secure entry.

30 **§28-103.14 Department records.** The department shall keep official records of applications
31 received, permits and certificates issued, fees collected, reports of inspections, and notices and orders
32 issued. Such records shall be retained in the official records for the period required for retention of
33 public records.

34 **§28-103.14.1 List of permits for cellular antenna.** The commissioner shall maintain a separate
35 list of alteration permits issued for the erection or placement of antennae used to provide cellular
36 telephone or similar service or any structure related to such service which shall, at a minimum,
37 set forth the name, business address and business telephone number of the applicant, the date of
38 the application, the date the permit was issued, the location for which the permit was issued,
39 including the premises address and the zoning district, whether residential, commercial, or
40 manufacturing, and the number of permits issued for such purpose at the same location. Such list
41 shall be made available to the public upon request between regular business hours and shall be
42 available to the public in electronic format on a 24-hour basis on the department's website.

1 **§28-103.15 Insurance.** The commissioner may require applicants for permits to obtain and furnish
2 proof of workers' compensation, disability and general liability insurance in such amounts and in
3 accordance with such specifications as shall be set forth in the rules of the department or as otherwise
4 required by law.

5 **§28-103.16 Inspections of existing buildings, structures, signs, service equipment and**
6 **construction machinery and equipment.** In addition to other required inspections, the
7 commissioner may make or require inspections of existing buildings, structures, signs, service
8 equipment installations and construction machinery and equipment to ascertain compliance with the
9 provisions of this code and other laws that are enforced by the department. Such inspections may be
10 made on behalf of the department by officers and employees of the department and other city
11 departments and governmental agencies; and by approved agencies, special inspectors or other
12 persons when the commissioner is satisfied as to their qualifications and reliability. The
13 commissioner may accept inspection and test reports from persons authorized by this code or by the
14 commissioner to perform such inspections. Such reports shall be filed with the department.

15 **§28-103.17 Certain outside work, employment and financial interests of department employees**
16 **prohibited.** It shall be unlawful for any officer or employee of the department to be engaged in
17 conducting or carrying on business as an architect, engineer, carpenter, plumber, iron worker, mason
18 or builder, or any other profession or business concerned with the construction, alteration, sale,
19 rental, development, or equipment of buildings. It shall also be unlawful for such employees to be
20 engaged in the manufacture or sale of automatic sprinklers, fire extinguishing apparatus, fire
21 protection devices, fire prevention devices, devices relating to the means or adequacy of exit from
22 buildings, or articles entering into the construction or alteration of buildings, or to act as agent for
23 any person engaged in the manufacture or sale of such articles, or own stock in any corporation
24 engaged in the manufacture or sale of such articles.

25 **§28-103.18 Investigation of complaints.** The commissioner shall cause all complaints to be
26 investigated. For purposes of investigating complaints of violations of law enforced by the
27 department, the commissioner may by rule establish a program to classify structures based on their
28 enforcement history and may create criteria for such classification and assign enforcement resources
29 accordingly.

30 **§28-103.18.1 Complaint records.** The department shall keep records of complaints made by any
31 person in reference to any building or other matter under the jurisdiction of the department.
32 Recorded complaints shall include the name and residence of the complainant, the name of the
33 person complained of, the date of the entry of the complaint and any suggested remedies. Except
34 for entries of names and residences of the complainants, such records shall be made available for
35 public examination.

36 **§28-103.19 Addition, modification, and deletion of referenced standards.** The standards
37 referenced in this code may be added to, deleted or modified pursuant to local law or by rule of the
38 department. Every such rule adding, deleting or modifying a referenced standard shall indicate the
39 promulgating agency of the standard, the standard identification, the effective date and title and the
40 section or sections of this code to which such standard applies. The commissioner shall act in
41 consultation with the fire commissioner on matters relating to fire safety.

1 ~~[Exception: Referenced standards in the New York city plumbing code, other than referenced~~
2 ~~national standards contained in chapter 13 of such code, shall not be added to, deleted, or~~
3 ~~modified by rule.]~~

4 **§28-103.20 Existing rules continued.** Rules promulgated by the department in accordance with the
5 law in effect [~~prior to July 1, 2008~~] when such rules were promulgated shall remain in effect for the
6 matters covered to the extent that such rules are not inconsistent with this code unless [~~and~~], until
7 and to the extent that such rules are amended or repealed by the department.

8 **§28-103.21 Incident lists.** The commissioner shall, [~~by January 2018 and~~] on a monthly basis
9 [~~thereafter~~] , post on the department’s website, in a machine-readable format, a list of every incident,
10 reported to the department in accordance with section 28-103.21.1, that occurred on every
11 construction site where construction work subject to permitting by the commissioner resulted in (i)
12 a fatality to any individual, including a member of the general public or a construction worker, or
13 (ii) an injury to any individual, including a member of the general public or a construction worker,
14 that requires transport by emergency medical services or requires immediate emergency care at a
15 hospital or offsite medical clinic, regardless of whether such incident involved a violation of this
16 code or any other law or rule. Such list shall identify, at a minimum, the following information for
17 each incident that the department is required to report on pursuant to this section:

- 18 1. The owner of the site where the incident occurred;
- 19 2. If the incident involved a construction worker, the name of the general contractor or the
20 subcontractor who employed such worker at the time of the incident;
- 21 3. A detailed description of the incident, including the nature of the work being performed at
22 the time of the incident;
- 23 4. Violations issued by the department as a result of the incident and to whom such violations
24 were issued;
- 25 5. The number of persons injured and/or killed in the incident, and whether such persons were
26 members of the public, construction workers or other persons;
- 27 6. If the incident involved an injury, a description of the type of injury;
- 28 7. Whether the incident involved a fatality;
- 29 8. The date and time of the incident;
- 30 9. The address where the incident occurred;
- 31 10. The total square footage of the site where the incident occurred;
- 32 11. The number of floors and height of the building involved where the incident occurred or, in
33 the case of a new building, the proposed number of floors and proposed height;
- 34 12. A list of active permits issued by the department associated with the construction site where
35 an incident occurred, disaggregated by type;
- 36 13. If the incident involved a construction worker, the length of time the injured or deceased
37 worker had been employed by their employer at the time of the incident;
- 38 14. If the incident involved a construction worker, the number of hours the injured or deceased
39 worker had been working when the incident occurred;

1 15. If the incident involved a construction worker, whether or not the injured or deceased worker
2 was a union member; and

3 16. Whether or not the construction site where the incident occurred was a union site.

4 **§28-103.21.1 Reporting.** Where construction work subject to permitting by the commissioner
5 that results in a fatality or injury to any individual, including a member of the general public or a
6 construction worker, occurs on a construction site within the city, the owner or person otherwise
7 in control of the site at which such incident occurred, or, if the incident involved a construction
8 worker, the general contractor or subcontractor that employed such worker, shall report to the
9 department, within three business days after the occurrence of such incident, the information
10 required by section 28-103.21, with such reporting made via an electronic portal established by
11 the department for the purpose of collecting the required information.

12 **§28-103.22 Outreach on security grille visibility requirements.** The commissioner shall, through
13 or in cooperation with the department of small business services, the department of consumer affairs,
14 and other city agencies deemed appropriate, develop an outreach program to manufacturers and
15 installers of security grilles, business improvement districts, local development corporations,
16 chambers of commerce and community boards to alert these groups and the businesses that utilize
17 security grilles of the permit requirements and the requirements of this section, the penalties
18 associated with violation thereof and the availability of any business loans, grants or tax subsidies
19 related to the installation or use of such security grilles.

20 **§28-103.23 Manual on flood construction and protection standards.** The commissioner shall
21 create and make publicly available, in print and on the department's website, a manual explaining in
22 detail the flood construction and protection requirements and standards applicable to the city. Such
23 manual shall be made available in plain English and Spanish and in other languages as determined
24 by the commissioner and shall be updated as necessary to reflect changes to applicable flood
25 construction requirements and standards. Such manual shall include, but need not be limited to, a
26 description and explanation of the following:

- 27 1. The materials requirements imposed by applicable flood construction requirements and
28 standards, including the elements of structures subject to such material requirements;
- 29 2. The manner in which specific utilities and attendant equipment must be protected from
30 flooding; and
- 31 3. The application of the flood construction and protection requirements and standards to
32 existing structures.

33 **§28-103.24 Electronic submissions.** The commissioner shall have the discretion to require that any
34 document or payment submitted to the department be submitted and/or signed electronically.

35 **§28-103.25 Hotel development plans.** Where the development receives applications for new
36 construction of or conversions to transient hotels, as defined in the zoning resolution, the department
37 shall provide written notice, or notice by electronic mail, of the proposed construction or conversion
38 to:

- 39 1. The borough president of the borough in which such proposed construction is located;
- 40 2. The council member in whose district such proposed construction is located;

- 1 3. The community board of the community district in which such proposed construction is
2 located; and
- 3 4. If such proposed construction involves land within two or more community districts in a
4 borough, the borough board.

5 **§28-103.26[-] Reporting to the federal occupational safety and health administration.** As soon
6 as practicable after the issuance of [(+) an immediately hazardous or major violation of chapter 33 of
7 the New York city building code [or (ii) a violation of section 3310.10.2 of the New York city building
8 code], the commissioner shall report such violation to the federal occupational safety and health
9 administration.

10 **§28-103.27 Disclosure of building occupancy status for buildings subject to permit.** For each
11 building for which a permit for work has been issued, the commissioner shall post on the
12 department's website a statement of whether the construction documents relating to such permit
13 indicate that one or more dwelling units within such building will be occupied during such work.

14 **§28-103.28 Site safety training (SST) task force.** The commissioner shall convene and provide
15 staff for an SST task force in accordance with the following:

- 16 1. Such task force shall be composed as follows:

17 1.1. The commissioner, or the designee of such commissioner, shall serve as the
18 chairperson of such task force.

19 1.2. The task force shall consist of 14 members, in addition to the chairperson. Seven of
20 the additional members of such task force shall be appointed by the mayor or the
21 mayor's designee, and seven of the additional members of such task force shall be
22 appointed by the speaker of the council. Such task force shall include members who
23 represent (i) parts of the construction industry that are represented by labor unions or
24 labor organizations, (ii) parts of such industry that are not represented by such unions
25 or organizations, (iii) minority-owned business enterprises or women-owned business
26 enterprises that are certified in accordance with section 1304 of the New York city
27 charter and primarily engaged in construction work and (iv) day laborers.

28 1.3 All members of the task force shall have significant experience (i) in a construction or
29 demolition related field or (ii) developing or providing construction site safety
30 training, except that one of the members appointed by the mayor pursuant to Item 1.2
31 may be a municipal officer with experience related to the program to be established
32 pursuant to section 22-509 of the code.

- 33 2. Such task force shall meet at least quarterly each year for the first two years of its existence
34 and at least annually for three years thereafter.

35 3. Such task force shall from time to time on its own initiative or upon request of the
36 commissioner provide the commissioner with recommendations relating to training required
37 by section 3321 of the New York city building code.

- 38 4. Such task force shall establish a mechanism for receiving and reviewing recommendations
39 from the public relating to training required by such section.

1 5. By no later than March 1, 2018, such task force shall provide the commissioner with
2 recommendations relating to the amount of additional SST credits required for satisfying
3 item 1.1 of the definition of limited SST card and the topics that such additional SST credits
4 must cover. Such task force shall consider, but need not include in its recommendations, the
5 following topics insofar as such topics relate to safeguarding the public from potential
6 dangers posed by building sites:

7 5.1. Fall protection.

8 5.2. Personal protection equipment.

9 5.3. Safely working with machines.

10 5.4. Working with hazardous chemicals or other materials.

11 5.5. OSHA and its role in construction industry safety and health.

12 5.6. Handling heavy materials and proper lifting techniques.

13 5.7. Exit routes, emergency action plans, fire prevention and fire protection.

14 5.8. Confined space awareness.

15 5.9. Walking and working surfaces.

16 5.10. Electrical safety.

17 5.11. Hazard communication.

18 5.12. Concrete operations.

19 5.13. Demolition work.

20 5.14. Excavation work.

21 5.15. Construction and demolition work at major building sites.

22 5.16. Material handling.

23 5.17. Material hoisting.

24 5.18. Site perimeter protection.

25 5.19. Sidewalk sheds and fences.

26 5.20. Steel erection.

27 5.21. Tenant and occupant protection.

28 5.22. Ladders and stairs.

29 5.23. Drug and alcohol awareness.

30 5.24. Asbestos awareness.

31 5.25. Lead awareness.

32 5.26. First aid, including cardiopulmonary resuscitation (CPR) and automated external
33 defibrillator (AED) use.

34 **§28-103.29 Reporting regarding implementation of section 3321 of the New York city building**
35 **code.** No later than three months after the end of each fiscal year, the commissioner shall report to

1 the mayor and the speaker of the council, and make publicly available online, a report on
2 implementation of section 3321 of the New York city building code. In addition to any information
3 the commissioner deems relevant, such report shall include:

- 4 1. The number of SST providers in existence at the end of such fiscal year. Such number shall
5 also be disaggregated by which condition of item 1 of the definition of “site safety training
6 (SST) provider” set forth in [~~section 3302.1~~] Chapter 2 of the New York city building code
7 is satisfied by each such provider.
- 8 2. The number of SST cards issued in such fiscal year.
- 9 3. The number of temporary SST cards issued in such fiscal year.
- 10 4. The number of violations of such section issued in such fiscal year, disaggregated by
11 violation type.
- 12 5. A list of building sites where violations of such section were issued and, for each such site,
13 the following information disaggregated by violation type:
 - 14 5.1. The number of follow-up inspections conducted pursuant to section 28-204.1.1.
 - 15 5.2. The average frequency of such follow-up inspections.
 - 16 5.3. The number of violations of section 3321 of the New York city building code issued
17 as a result of such inspections.
- 18 6. A description of the enforcement mechanisms used by the department to ensure the integrity
19 of training provided by SST providers in connection with section 3321 of the New York city
20 building code and that such training satisfies the requirements of such section and any rules
21 or department requirements relating to such training.

22 **§28-103.29.1 Audits of training provided in connection with section 3321 of the New York**
23 **city building code.** In addition to any other enforcement mechanisms, the department shall
24 periodically audit SST providers and training provided in connection with section 3321 of the
25 New York city building code by such providers in order to ensure the integrity of such training
26 and compliance with such section and any rules or department requirements relating to such
27 training.

28 **§28-103.30 Real Time Enforcement Unit.** There is hereby established within the department a real
29 time enforcement unit. Such unit and an agency that is delegated authority by the commissioner shall
30 be responsible for enforcing the construction codes with respect to:

- 31 1. occupied multiple dwellings with complaints related to work without a permit; and
- 32 2. occupied multiple dwellings with valid permits for (i) the alteration of 10 percent or more of
33 the existing floor surface area of the building or (ii) an addition to the building.

34 **§28-103.30.1 Tracking complaints related to work without a permit.** The real time
35 enforcement unit shall receive and track all complaints related to work without a permit in
36 occupied multiple dwellings. The unit shall retain records of such complaints.

37 **§28-103.30.2 Monitoring occupied multiple dwellings with permits for alteration or**
38 **addition.** The real time enforcement unit shall monitor all occupied multiple dwellings with valid
39 permits for (i) the alteration of 10 percent or more of the existing floor surface area of the building

1 or (ii) an addition to the building. Owners of such buildings shall notify the department in writing
2 at least 72 hours prior to the commencement of any work pursuant to such permits.

3 **§28-103.30.3 Inspections.** For immediately hazardous complaints related to work without a
4 permit in occupied multiple dwellings, the real time enforcement unit shall conduct inspections
5 of such occupied multiple dwellings within 12 hours of the receipt of such complaints, except that
6 complaints received after 8:00 p.m. shall be inspected by 10:00 a.m. on the following day. For all
7 other complaints related to work without a permit in occupied multiple dwellings, such unit shall
8 conduct inspections of such multiple dwelling within ten days of receipt of such complaints. The
9 real time enforcement unit shall also conduct initial inspections of no fewer than five percent of
10 occupied multiple dwellings with valid permits for alteration or addition as described in section
11 ~~[28-103.26.2]~~ 28-103.30.2, within 20 days of commencement of work for such alterations or
12 additions and shall conduct periodic unannounced inspections thereafter until such work is
13 complete. The unit shall be available to conduct inspections seven days a week, between the hours
14 of 8:30 a.m. and 10:00 p.m.

15 **§28-103.30.4 Violations.** The real time enforcement unit shall issue notices of violation or stop
16 work orders as necessary.

17 **§28-103.30.5 Report.** The department shall publish online an annual report with the following
18 information related to the effectiveness of the real time enforcement unit: (i) the number of
19 complaints received disaggregated by building; (ii) the average time taken to respond to
20 complaints; (iii) the number of monitored occupied multiple dwellings with valid permits for
21 alteration or addition as described in section ~~[28-103.26.2]~~ 28-103.30.2; (iv) the number of initial
22 and periodic inspections conducted disaggregated by building; and (v) the number and type of
23 violations issued disaggregated by building.

24 **§28-103.31 Report on site safety manager and coordinator certifications.** ~~[The]~~ In October of
25 each year, the commissioner shall ~~[, in October of 2018 and each year thereafter,]~~ electronically
26 submit to the city council and post on the department's website a report that includes the following
27 information regarding site safety managers and site safety coordinators:

- 28 1. The (i) number of active site safety manager certificates and (ii) number of active site safety
29 coordinator certificates;
- 30 2. The (i) number of active site safety manager certificates on the last day of the preceding
31 year and (ii) number of active site safety coordinator certificates on the last day of the
32 preceding year;
- 33 3. The (i) number of sites for which a site safety manager was required by this code during the
34 preceding year and (ii) number of such sites for which a site safety manager was required
35 by this code but for which a site safety coordinator may be designated in lieu of such
36 manager pursuant to the exception to section 3310.5 of the New York city building code;
- 37 4. The (i) number of site safety manager certificates issued in the preceding year and (ii)
38 number of site safety coordinator certificates issued in the preceding year;
- 39 5. The (i) number of applicants for site safety manager certificates who submitted applications
40 during the preceding year and (ii) number of applicants for site safety coordinator
41 certificates who submitted applications during the preceding year;

6. The (i) average length of time for an applicant who submitted an application for a site safety manager certificate during the preceding year to receive such certificate, measured from the date a completed application is submitted to the department and (ii) average length of time for an applicant who submitted an application for a site safety coordinator certificate during the preceding year to receive such certificate, measured from the date a completed application is submitted to the department; and
7. The (i) average length of time for an applicant who submitted an application for a site safety manager certificate during the preceding year to complete a background check, if any, for such certificate, measured from the date such applicant submitted all documentation necessary to complete such check, (ii) average length of time for an applicant who submitted an application for a site safety coordinator certificate during the preceding year to complete a background check, if any, for such certificate, measured from the date such applicant submitted all documentation necessary to complete such check (iii) the main three reasons for completions of background checks for applicants who submitted applications for site safety manager certificates during the preceding year exceeding the average length of time for completion of such background checks and (iv) the main three reasons for completions of background checks for applicants who submitted applications for site safety coordinator certificates during the preceding year exceeding the average length of time for completion of such background checks.

§28-103.32 Education and outreach regarding single-occupant toilet room requirements. The department, in conjunction with (i) the mayor’s office of immigrant affairs, (ii) the commission on human rights, (iii) the department of consumer affairs, (iv) the department of health and mental hygiene, (v) the department of small business services, (vi) the department of citywide administrative services and (vii) any other office or agency designated by the mayor, shall conduct education and outreach to increase awareness of sections 403.2.1 and 403.4 of the New York city plumbing code, regarding single-occupant toilet room requirements. Such education and outreach shall be tailored to business owners, and shall, at a minimum, include educational materials concerning such single-occupant toilet room requirements and the related posting and signage requirements, including samples of acceptable signage. Such materials and sample signage shall be available in the designated citywide languages as defined in section 23-1101. Information concerning such requirements shall also be made available on the department’s website.

§28-103.32.1 Reporting. [~~By no later than April 1, 2019, and annually thereafter~~] In April of each year until April 1, 2023, the commissioner of buildings shall submit to the mayor and the speaker of the council, and post on the department’s website, a report on:

1. The education and outreach conducted as required by section 28-103.32 including a description of how such outreach was conducted and the number of business owners reached through the outreach;
2. The number of complaints related to sections 403.2.1 and 403.4 of the New York city plumbing code reported to 311, disaggregated by online complaints and phone complaints;
3. The number of violations issued as a result of such complaints;
4. The total amount of penalties imposed as a result of such violations for the immediately preceding year; and

- 1 5. Whether subsequent inspections were conducted by the department to ensure future
2 compliance with such sections of the New York city plumbing code. The reports
3 required pursuant to this section shall remain permanently accessible on the
4 department’s website.

5 **§28-103.33 Office of alternative energy.** There is hereby established within the department an
6 office of alternative energy.

7 **§28-103.33.1 Definitions.** As used in this section, the following terms have the following
8 meaning:

9 **ALTERNATIVE ENERGY PROJECT.** Construction work on a building that will result in
10 such building having at least 50 kilowatts of alternative energy capacity installed onsite from:

- 11 1. A qualified energy resource, as such term is defined in section 45 of title 26 of the United
12 States code; or
13 2. A source that is determined to be renewable by the commissioner or the head of another
14 agency designated by the mayor.

15 **GREEN ROOF SYSTEM.** See [~~section 1502.4~~] chapter 2 of the New York city building code.

16 **§28-103.33.2 Duties of the office of alternative energy.** The duties of the office of alternative
17 energy include, but need not be limited to:

- 18 1. Establishing a program to (i) assist with the technical review and approval of
19 applications and other documents submitted to the department in connection with
20 alternative energy projects, (ii) provide guidance to applicants in connection with such
21 projects, (iii) support technical research for advancing energy legislation and policy
22 within the city and (iv) receive and respond to comments, questions and complaints with
23 respect to such program;
24 2. Coordinating with the office of long-term planning and sustainability, fire department,
25 department of small business services, department of housing preservation and
26 development, and other relevant agencies to ensure that policies are in place to
27 encourage the installation and maintenance of alternative energy projects, and seeking
28 cooperation and assistance from the city university of New York with respect to such
29 policies; and
30 3. Making recommendations to the commissioner and the heads of other agencies with
31 respect to streamlining the process for obtaining the necessary approvals to install and
32 maintain alternative energy projects.

33 **§28-103.33.3 Reporting.** The head of the office of the alternative energy shall submit an annual
34 report to the commissioner and to the head of any other relevant agency providing (i) a
35 description of the most commonly received comments, questions and complaints received with
36 respect to such office, (ii) a description of actions undertaken by such office to coordinate with
37 other agencies and the results of such coordination, (iii) recommendations made pursuant to
38 section [~~28-103.31.2~~] 28-103.33.2 and (iv) recommendations with respect to expanding the
39 definition of alternative energy project. By no later than three months after the end of each fiscal
40 year, such office shall submit a report to the mayor and the speaker of the city council that

1 includes a summary of the actions taken by any agency as a result of any comment, question,
2 complaint or recommendation from or forwarded by such office.

3 **§28-103.33.4 Posting of information.** The office of alternative energy shall maintain a website
4 and shall post on such website the contact information for such office and a statement indicating
5 that any person may contact such office if such person has a comment, question or complaint
6 with respect to such office.

7 **§28-103.33.4.1 Information regarding installation of green roof systems.** The office of
8 alternative energy shall further post and maintain links on its website to information
9 regarding the installation of green roof systems and other resources and materials regarding
10 green roof systems.

11 **§28-103.34 Electronic mail address.** All applicants, licensees, permit holders, and any other
12 person or entity that submits any report or certification or seeks or receives any approval or
13 authorization from the department shall provide to the department an active electronic mail address
14 for purposes of receiving communications from the department, except where another method of
15 communication is authorized by the commissioner. It shall be the responsibility of the applicant,
16 licensee, permit holder or other person or entity to monitor and maintain an electronic mail address
17 and notify the department of any changes.

18 **§28-103.34.1 Electronic notification.** The commissioner may send written notices, documents
19 or other correspondence to the electronic mail address provided pursuant to this section. Upon
20 consent of such applicant, licensee, permit holder or other person or entity, the commissioner
21 may serve an order to such electronic mail address.

22 **§28-103.35 [E-mail] Electronic mail notice of construction project updates.** The department
23 shall provide, free of charge, a service allowing users to register to receive an automated e-mail
24 notification each time a change in status is recorded with respect to one or more construction
25 projects, selected by such user. Such [~~email~~] electronic mail notifications shall include any update
26 to work permits issued by the department for each such selected construction project, including
27 issuance of any stop work order issued pursuant to section 28-207.2.

28 **§28-103.36 Bird friendly design and construction requirements.** The department shall issue, and
29 update as necessary, bird friendly building design and construction requirements. No later than
30 October 1, 2020, the department shall post on its website such requirements and information about
31 compliance with section 1403.8 of the New York city building code.

32 **ARTICLE 104**
33 **CONSTRUCTION DOCUMENTS**

34 **§28-104.1 General.** The department shall not issue a permit pursuant to this code, or a place of
35 assembly operation certificate pursuant to this code unless and until it approves all required
36 construction documents for such work. The department shall not issue an electrical work permit
37 pursuant to the New York city electrical code for fire and emergency alarm systems, solar panels
38 and wind turbines unless and until it approves all required construction documents for such work.
39 Such construction documents shall be prepared by or under the supervision of a registered design

1 professional as required by this code. An application for an associated work permit shall not be
2 submitted to the department until all required construction documents have been approved.

3 **§28-104.1.1 Construction documents subject to the New York city fire code.** Except as the
4 New York city fire code may otherwise provide, the construction documents for facilities and
5 systems for which the fire code provides design and installation requirements, including but not
6 limited to fire alarm systems, flammable and combustible liquids, compressed gases, explosives
7 and other hazardous materials; flammable spraying systems and facilities; automatic water
8 sprinkler systems for hazardous material and combustible material storage, and non-water fire
9 extinguishing systems, shall be subject to the review and approval of the fire commissioner in
10 accordance with the New York city fire code. Approval by the department of construction
11 documents for new or existing buildings containing such facilities and systems shall not be
12 construed as approval of such systems and facilities.

13 **§28-104.2 Application for approval of construction documents.** The department shall assign an
14 application number to and docket all applications for approval of construction documents and any
15 amendments thereto filed with it. The department shall examine the construction documents
16 promptly after their submission. The examination shall be made under the direction of the
17 commissioner for compliance with the provisions of this code and other applicable laws and rules.
18 The personnel employed for the examination of construction documents shall be qualified registered
19 design professionals[;] experienced in building construction and design or persons working under
20 the supervision of such registered design professionals. The department shall provide written
21 notification to owners of adjoining property at the time such application is submitted.

22 **§28-104.2.1 Less than full examination of applications for construction and related**
23 **document approval based on professional certification.** The commissioner may, in the
24 commissioner's discretion, establish a program whereby construction and related documents
25 may be accepted with less than full examination by the department based on the professional
26 certification of an applicant who is a registered design professional. On a monthly basis, the
27 commissioner shall audit no less than 25 percent of construction documents which are for
28 multiple dwellings where 25 percent or more of the dwelling units are occupied and such multiple
29 dwellings, in whole or in part, either (i) are subject to rent regulation, (ii) are being rehabilitated
30 or maintained as affordable housing through a department of housing preservation and
31 development program, (iii) are subject to a city regulatory agreement mandating the creation or
32 preservation of a certain number of affordable units, (iv) contain affordable housing units
33 created, sponsored or preserved through other city programs or initiatives, or (v) where the
34 department knows or has reason to know, are the subject of a rent overcharge application which
35 is in the process of being investigated by the New York State division of housing and community
36 renewal.

37 **Exceptions:**

- 38 1. Construction or related documents may not be subject to less than full examination if
39 the building is listed on the department of housing preservation and development's
40 website pursuant to paragraph 6 of subdivision m of section 27-2115.
- 41 2. Where a penalty is imposed pursuant to article 213 of chapter 2 of this title for work
42 that has been performed without a permit on a building (i) construction and related
43 documents for work at such building shall not be accepted with less than full

1 examination by the department for one year after such imposition or (ii) if such work
2 without a permit was performed on only part of such building and the owner of such
3 part is not the owner of such building, construction and related documents for work
4 on such part shall not be accepted with less than full examination by the department
5 for one year after such imposition or until the date such part of such building changes
6 owners, whichever is sooner.

7 **§28-104.2.1.1 Effect of acceptance.** Except as otherwise specified in this code or in the rules
8 of the department, for the purposes of this code, the acceptance of construction and related
9 documents in accordance with such program shall have the same force and effect as the
10 approval of construction and related documents after full examination by the department.
11 Except as otherwise specified in this code or in the rules of the department, references in this
12 code to approved construction and/or related documents or to the approval of construction
13 and/or related documents shall also be deemed to refer to accepted construction and related
14 documents or to the acceptance of construction and related documents, as applicable.

15 **§28-104.2.1.2 Program requirements.** The commissioner may establish qualifications and
16 requirements for registered design professionals to participate in such program and may
17 exclude, suspend or otherwise sanction participants for cause. The commissioner shall send
18 an annual notification to registered design professionals who are currently participating in
19 this program notifying them, in a manner to be determined by the commissioner, of the
20 grounds upon which they may be excluded, suspended or otherwise sanctioned.

21 **§28-104.2.1.3 Mandatory program requirements.** Registered design professionals
22 participating in such program shall be subject to sections 28-104.2.1.3.1 through 28-
23 104.2.1.3.2.

24 **§28-104.2.1.3.1 Probation.** A registered design professional shall not be eligible to
25 participate in the program during any period of probation imposed as a sanction by the
26 board of regents pursuant to section 6511 of the New York state education law.

27 **§28-104.2.1.3.2 Mandatory sanctions.** The commissioner shall, after the opportunity for
28 a hearing before the office of administrative trials and hearings in accordance with
29 department rules, exclude, suspend or otherwise condition the participation of a registered
30 design professional who (i) knowingly or negligently submits a professional certification
31 of an application and/or construction and other related document that contains false
32 information or is not in compliance with all applicable provisions of law, (ii) submits two
33 professionally certified applications for construction document approval within any 12-
34 month period containing errors that result in revocation of an associated permit or that
35 otherwise demonstrate incompetence or a lack of knowledge of applicable laws, or (iii)
36 knowingly orders or directs another registered design professional to submit a
37 professional certification of an application and/or construction and any other related
38 document that contains false information or is not in compliance with all applicable
39 provisions of law or that otherwise demonstrates incompetence or a lack of knowledge
40 of applicable laws, or with knowledge of such specific conduct, ratifies or assents to such
41 conduct or with knowledge of such specific conduct and while acting as a supervisor
42 otherwise fails to prevent it.[-] The commissioner may, after the opportunity for a hearing
43 before the office of administrative trials and hearings in accordance with department
44 rules, exclude, suspend, or otherwise condition the participation of a registered design
45 professional who submits two professionally certified applications for construction

1 document approval within any 12-month period containing errors that result in a stop
2 work order. The term “otherwise condition” shall mean limitations on such professional’s
3 participation in the program, such as, but not limited to, audits and monitoring of the
4 registered design professional’s applications and other submissions. For the purposes of
5 this section, a professionally certified application shall include the professional
6 certification of construction and other related documents and the satisfaction of
7 objections issued at plan examination.

8 **§28-104.2.1.3.2.1 Reinstatement.** A registered design professional who is excluded
9 from the program in accordance with section 28-104.2.1.3 may apply for
10 reinstatement one year or more after such exclusion. An applicant who the
11 commissioner finds is qualified to resume participation in the program shall be on
12 probation for a period of not less than [6] six months after reinstatement and during
13 that time shall as a condition of such reinstatement attend one or more training or
14 continuing education courses, approved by the department, related to compliance
15 with the New York city building code and related laws and rules and the zoning
16 resolution. The professional shall submit satisfactory proof of the successful
17 completion of such training or continuing education courses to the department.

18 **§28-104.2.1.3.2.2 Mandatory permanent revocation.** The commissioner (i) shall
19 permanently revoke, without the opportunity of restoration, the professional
20 certification privileges of [~~an engineer or architect~~] a registered design professional
21 who, while on probation, professionally certifies an application, plans, construction
22 or other related document that contains false information or is not in compliance with
23 all applicable provisions of law or who otherwise demonstrates incompetence or a
24 lack of knowledge of applicable laws and (ii) may permanently revoke the
25 professional certification privileges of [~~an engineer or architect~~] a registered design
26 professional who knowingly orders or directs another registered design professional
27 to, while on probation, professionally certify an application, plans, construction or
28 other related document that contains false information or is not in compliance with
29 all applicable provisions of law or that otherwise demonstrates incompetence or a
30 lack of knowledge of applicable laws, or with knowledge of such specific conduct,
31 ratifies or assents to, or with knowledge of such specific conduct and while acting as
32 a supervisor otherwise fails to prevent it.

33 **§28-104.2.1.3.2.3 Construction.** Nothing herein shall be construed to limit the
34 commissioner’s power, consistent with state and local law, to adopt rules that include
35 additional grounds to limit the filing privileges of or otherwise sanction registered
36 design professionals, after the opportunity for a hearing, who it determines,
37 knowingly or negligently submit applications or other documents to the department
38 that contain false information or are not in compliance with all applicable provisions
39 of law or that otherwise demonstrate incompetence or a lack of knowledge of
40 applicable law or standards.

41 **§28-104.2.1.4 Database.** The department shall create and maintain a database of all
42 registered design professionals who have been excluded, suspended or otherwise sanctioned
43 by the department, all current firms of employment or affiliation of such professionals, if
44 known or readily ascertainable, and the firm that employed such professionals, or with which
45 such professional was affiliated, at the time such professionals were sanctioned, and the

1 status of such sanction or sanctions. Within [7] seven business days of the date a sanction is
2 imposed, the department shall post on its website, in a non-proprietary machine-readable
3 format that permits automated processing, and shall make available upon request, the name
4 of the registered design professional, and the firm that employed such professionals, or with
5 which such professionals were affiliated, at the time such professionals were sanctioned, and
6 a description of the sanction, the initial date of the sanction, the reinstatement date, if
7 applicable, the address of the premises for which the application associated with the sanction
8 was submitted, and whether the sanction was imposed after a hearing or a settlement. The
9 department shall provide requested information concerning the exclusion, suspension or
10 other sanction of a specific registered design professional and the firm of employment of
11 such professionals, or the firm with which such professionals were affiliated, when such
12 professionals were sanctioned, within 30 days of such request.

13 **§28-104.2.1.5 Applicant requirement.** The program shall include a condition that the
14 applicant remain with the project until it is signed [-] off by the department and that if the
15 applicant withdraws from or is unable to continue a project before the issuance of a letter of
16 completion or certificate of occupancy, as applicable, all work shall stop and no permit, letter
17 of completion or certificate of occupancy shall be issued until a successor registered design
18 professional is designated as applicant of record and such person:

- 19 1. Completes a thorough review and evaluation of the previously filed and accepted
20 construction and other related documents to determine that they conform to the
21 applicable laws and rules in accordance with rules of the board or regents, 8 NYCRR
22 29.3(a)3;
- 23 2. Inspects any built work to confirm that the observable conditions are consistent with
24 the previously filed and accepted construction documents; [~~and~~]
- 25 3. Performs or reviews the results of any tests or inspections required by this code to
26 confirm that all required tests and inspections have been performed and that the
27 results of such tests and inspections are consistent with the accepted or approved
28 construction documents; and
- 29 4. Based on the result of the evaluation and inspections, secures department approval
30 after examination of construction and other related documents submitted by and
31 under signature and seal of the successor. All deficiencies shall be addressed by the
32 successor in such documents.

33 **§28-104.2.1.6 Notice to the state department of education.** The department shall provide
34 written notice to the New York state department of education of any registered design
35 professional who was the subject of any disciplinary proceeding where there has been an
36 adverse determination or sanction by the department including any settlement agreement that
37 is reached between the parties that resulted in a sanction of privileges being imposed by the
38 department. Such notice shall be sent within ten business days after a determination is made
39 in any such disciplinary proceeding or after a settlement of such proceeding has been reached,
40 and shall include the name, and business firm name and address of such registered design
41 professional, as well as any supporting documentation for the sanction imposed. The
42 department shall also provide such notice to the state department of education of any
43 registered design professional that has been the subject of any disciplinary proceeding where

1 there has been an adverse determination or sanction by the department within the five
2 calendar years immediately preceding the effective date of this section.

3 **§28-104.2.2 Approval or acceptance to be indicated on construction documents.** All
4 construction documents, when approved, shall be stamped or endorsed “approved” under the
5 official method of the department, followed by a notation of the date except that construction
6 documents accepted with less than full examination by the department shall be stamped or
7 endorsed “accepted” instead of “approved”. ~~[One set of “approved” or “accepted” construction~~
8 ~~documents shall be retained by the department and another set shall be maintained at the project~~
9 ~~site until the work authorized by the permit is completed and signed off by the department.]~~

10 **§28-104.2.3 Time limitation of application.** An application for approval of construction
11 documents shall be deemed to have been abandoned 12 months after the date of its submission,
12 unless such application has been diligently prosecuted after rejection in whole or in part, or unless
13 a permit shall have been issued pursuant to this code, except that the commissioner may upon
14 application, for reasonable cause, grant extensions of time for additional 12-month periods,
15 including for reasons such as the diligent prosecution of related applications at other agencies,
16 including but not limited to, the board of standards and appeals, the city planning commission,
17 the landmarks preservation commission and the department of environmental protection. Any
18 such extension shall not serve to avoid compliance with section 28-104.2.4 with respect to any
19 subsequent laws and rules in effect at the time of issuance of the associated work permit or place
20 of assembly certificate of operation.

21 **Exception:** Where, subsequent to the filing of an application, the department determines that
22 such application is incomplete and the department has notified the applicant that the
23 application is incomplete, the commissioner may deem such application abandoned after 90
24 days from the date of such notification.

25 **§28-104.2.4 Conditions of approval.** All construction documents approved by the commissioner
26 shall be conditioned upon and subject to compliance with the requirements of this code and other
27 applicable laws and rules in effect at the time of issuance of the associated work permit or place
28 of assembly certificate of operation, including, but not limited, to intervening amendments to
29 this code or the zoning resolution, and designations by the landmarks preservation commission.

30 **§28-104.2.5 Phased or partial approval.** In the case of construction documents for the
31 construction of new buildings or the alteration of buildings, the commissioner may grant partial
32 approval of construction documents before the construction documents for the entire building or
33 structure have been submitted. The approval of such partial applications will be subject to the
34 submittal and approval of construction documents, filed together, comprising:

- 35 1. The lot diagram showing the exact location of the lot and dimensions to the nearest
36 corner;
- 37 2. A complete zoning analysis showing compliance of the proposed work with the zoning
38 resolution;
- 39 3. The foundation plans, as provided for in section ~~[106.7.1]~~ 107.7.1 of the New York city
40 building code, as well as a loading diagram and column schedule for the entire building
41 or structure;

- 1 4. Earthwork plans, as provided for in section 107.8 of the New York city building code;
2 [~~and~~]
- 3 5. The floor and roof plans showing compliance with exit requirements, as provided for in
4 this code. Structural calculations that justify the foundation design shall be made
5 available to the department when requested by the department. Following the partial
6 approval of such construction documents, the issuance of a foundation and earthwork
7 permit shall be subject to submission of required submittal documents, including related
8 support of excavation documents in accordance with section 28-105.2.1. The owner and
9 the holder of such a foundation and earthwork permit shall proceed at their own risk with
10 the construction operation and without assurance that a permit for the entire structure will
11 be granted. In the event that the project does not proceed, any open excavation shall be
12 filled and graded in accordance with chapter 33 of the New York city building code[-];
13 and
- 14 6. Other documents the department determines are necessary.

15 The issuance of such foundation and earthwork permit is subject to submission of required
16 submittal documents. The owner and the holder of such foundation and earthwork permit shall
17 proceed at their own risk with the construction operation and without assurance that a permit for
18 the entire structure will be granted.

19 **§28-104.2.6 Deferred submittal.** With the prior approval of the department, the applicant may defer
20 submittal of portions of the design until a specified period of time after the issuance of a permit. The
21 applicant shall list the deferred submittal items on the initial application for construction document
22 approval. The deferred submittal items shall not be constructed or installed until the design and
23 submittal documents for the item have been approved by the department. The owner and permit
24 holder shall proceed at their own risk with the construction operation and without assurance that a
25 permit for the entire structure will be granted and the approval of all construction documents shall be
26 conditioned upon and subject to compliance with the requirements of this code and other applicable
27 laws and rules in effect at the time of issuance of the associated permit or place of assembly certificate
28 of operation.

29 **§28-104.2.7 Time period for review.** Completed construction documents complying with the
30 provisions of this code and other applicable laws and rules shall be approved by the
31 commissioner and written notice of approval shall be given the applicant promptly and no later
32 than 40 calendar days after the submission of a complete application.

33 **Exceptions:**

- 34 1. On or before the fortieth day, the commissioner may, for good cause shown and upon
35 notification to the applicant, extend such time for an additional 20 calendar days.
- 36 2. Such time period for review shall commence in accordance with article 107 for single
37 room occupancy multiple dwellings.

38 **§28-104.2.7.1 Notification of approval.** The department shall, on a weekly basis, send
39 council members and community boards, by electronic mail, and post on its website, a [~~copy~~]
40 report of all [~~notices of approval for~~] applications [~~sent to applicants~~] that were approved
41 during the prior week, disaggregated by community board, for:

- 1 1. A new building or an alteration that will require a new certificate of occupancy for a
2 building; and
- 3 2. Work at a building or part thereof for which construction and related documents shall
4 not be accepted with less than full examination by the department pursuant to the
5 exception to section 28-104.2.1.

6 **§28-104.2.8 Notification of rejection.** Applications failing to comply with the provisions of this
7 code and other applicable laws and rules shall be rejected and written notice of rejection, stating
8 the grounds of rejection, shall be given the applicant promptly and not later than the date required
9 in section 28-104.2.7. The department shall, on a weekly basis, send council members and
10 community boards, by electronic mail, a ~~[copy]~~ report of all ~~[notices of a first rejection for]~~
11 rejections of applications for a new building or an alteration that will require a new certificate of
12 occupancy for a building, ~~[sent to applicants]~~ during the prior week, disaggregated by community
13 board. In addition, the department shall post such information on its website on a weekly basis.

14 **§28-104.2.9 Resubmission.** Whenever an application has been rejected and is thereafter revised
15 and resubmitted to meet the stated grounds of rejection, the revised application and construction
16 documents shall be approved if they meet the stated grounds of rejection and otherwise comply
17 with the provisions of this code and other applicable laws and rules or shall be rejected if they
18 fail to meet the stated grounds of rejection or otherwise fail to so comply. Written notice of
19 approval or written notice of rejection, stating the grounds of rejection, shall be given the
20 applicant promptly and not later than 20 calendar days after the resubmission of such documents.

21 **§28-104.2.10 Revocation of approval.** The commissioner may, on notice to the applicant,
22 revoke the approval of construction documents for failure to comply with the provisions of this
23 code or other applicable laws or rules; or whenever there has been any false statement or any
24 misrepresentation as to a material fact in the submittal documents upon the basis of which such
25 approval was issued; or whenever an approval has been issued in error and conditions are such
26 that approval should not have been issued. Such notice shall inform the applicant of the reasons
27 for the proposed revocation and that the applicant has the right to present to the commissioner or
28 his or her representative within 10 business days of personal service or electronic delivery or 15
29 ~~[calendar]~~ business days of the posting of service by mail, information as to why the approval
30 should not be revoked.

31 **§28-104.2.10.1 Effect on work permit.** The effect of revocation of approval of construction
32 documents is the automatic revocation of all work permits that may have been issued based
33 on such construction documents.

34 **§28-104.3 Amended construction documents.** Subject to the time limitations set forth in this code,
35 amendments to approved construction documents shall be submitted, reviewed and approved before
36 the work or equipment is completed; and such amendments when approved shall be deemed part of
37 the original construction documents. The department may allow minor revisions of construction
38 documents to be made and submitted to the department after the completion of work but prior to
39 sign-off of the work ~~[in accordance with department rules]~~. All other revisions of construction
40 documents shall be submitted and approved prior to commencing the work effectuating such
41 revisions.

1 **§28-104.4 Place of filing.** Except as otherwise provided by rule, applications for construction
2 document approval shall be filed in the department office in the borough in which the work or
3 equipment is located or at the discretion of the commissioner shall be submitted electronically.

4 **§28-104.5 Fees.** Filing fees shall be paid as required by article 112.

5 **§28-104.6 Applicant.** The applicant for approval of construction documents shall be the registered
6 design professional who prepared or supervised the preparation of the construction documents on
7 behalf of the owner.

8 **Exception:** The applicant may be other than a registered design professional for:

- 9 1. Limited [~~oil burner/boiler~~] oil-burning appliance alterations, limited plumbing alterations,
10 limited sprinkler alterations, and limited standpipe alterations (limited alteration
11 application) alteration applications, where the applicant is licensed to perform such work
12 pursuant to this code;
- 13 2. Demolition applications other than those specified in section 3306.5 of the New York
14 city building code, where the applicant is the demolition contractor performing such
15 demolition. In such cases, the commissioner may require structural plans designed by a
16 registered design professional to address any critical structural, sequencing or site safety
17 items;
- 18 3. Elevator applications;
- 19 4. Applications for work falling within the practice of landscape architecture as defined by
20 the New York state education law, including but not limited to landscaping and
21 vegetation plans, tree protection plans, erosion and sedimentation plans, grading and
22 drainage plans, curb cuts, pavement plans, and site plans for urban plazas and parking
23 lots, where the applicant is a landscape architect. Landscape architects shall not file plans
24 for stormwater management and plumbing systems;
- 25 5. Other categories of work consistent with rules promulgated by the commissioner.

26 **§28-104.6.1 Verification of professional qualification required.** The department shall not
27 accept construction documents or other documents submitted in connection with applications for
28 construction document approval or work permits under this code by any person representing that
29 he or she is a registered design professional or landscape architect without verifying, by means
30 of lists compiled and made available by the New York state department of education pursuant to
31 paragraph e-1 of subdivision [~~four~~] 4 of section [~~sixty-five hundred seven~~] 6507 of the New York
32 state education law, that such person meets the qualifications established by law to practice as
33 an architect or engineer in New York state.

34 **§28-104.7 Submittal of construction documents.** All construction documents submitted to the
35 department shall contain such information and shall be in such form as shall be set forth in [~~this~~]
36 section 28-104.7 and the rules of the department. Construction documents shall also conform to
37 standards as may be prescribed in the applicable sections of the construction codes.

38 **§28-104.7.1 Scope.** Construction documents shall be complete and of sufficient clarity to
39 indicate the location and entire nature and extent of the work proposed, and shall show in detail
40 that they conform to the provisions of this code and other applicable laws and rules; if there exist

1 practical difficulties in the way of carrying out the strict letter of the code, laws or rules, the
 2 applicant shall set forth the nature of such difficulties.

3 **§28-104.7.2 Forms.** The applicant shall submit construction documents on or accompanied by
 4 forms provided by the department.

5 **§28-104.7.3 Media.** Construction documents shall be printed upon suitable material, or presented
 6 as electronic media documents as determined by the commissioner. Plans shall be drawn to
 7 suitable scale, resolution and file format as determined by the commissioner.

8 **§28-104.7.4 Quantities.** The applicant shall submit the number of copies of construction
 9 documents as the commissioner shall require.

10 **§28-104.7.5 Citations to code sections required.** In no case shall terms such as “code
 11 compliant”, “approved”, “legal” or similar terms be used in the construction documents as a
 12 substitute for specific reference to a particular code section, approval or standard in order to show
 13 compliance with code requirements or other applicable laws and rules.

14 **§28-104.7.6 City datum.** All elevations noted in the construction documents shall be referred to
 15 and clearly identified as the North American vertical datum of 1988 ([“NAVD”]) as established
 16 and maintained by National Geodetic Survey of the National Ocean Service, National Oceanic
 17 and Atmospheric Administration or successor agency, which is hereby established as the city
 18 datum. Neither the United States coast and geodetic survey mean sea level datum of 1929
 19 (national geodetic vertical datum, ([“NGVD”]) nor any of the five borough data as established
 20 by the former Board of Estimate and Apportionment shall be referred to in construction
 21 documents except as may be required for the purpose of demonstrating conversion to the NAVD.
 22 Conversions to NAVD shall be performed by registered design professionals or surveyors.
 23 Conversion to and from borough data, ~~and~~ NGVD and NAVD shall be performed using tables
 24 104.7.6.1 through 104.7.6.5.

TABLE 104.7.6.1^a

BRONX ELEVATIONS	TO OBTAIN EQUIVALENCY:	NGVD ELEVATIONS	TO OBTAIN EQUIVALENCY:	NAVD ELEVATIONS
<u>8.422 to 8.495</u>	<u>→add 2.608→</u>	<u>11.030 to 11.083</u>	<u>→subtract between 1.030 and 1.083→</u>	<u>10.000</u>
10.000	<u>→add 2.608→</u>	12.608	<u>→subtract between 1.030 and 1.083→</u>	<u>11.525 to 11.578</u>
7.392	<u>→add 2.608→</u>	10.000	<u>→subtract between 1.030 and 1.083→</u>	<u>8.917 to 8.970</u>

26 a. Conversions to and from NAVD as indicated in this table represent the likely range. The
 27 precise conversion depends on the latitude and longitude of the location in question, as
 28 determined by a surveyor.

TABLE 104.7.6.2^a

BROOKLYN ELEVATIONS	TO OBTAIN EQUIVALENCY:	NGVD ELEVATIONS	TO OBTAIN EQUIVALENCY:	NAVD ELEVATIONS
<u>8.546 to 8.572</u>	<u>→add 2.547→</u>	<u>11.093 to 11.119</u>	<u>→subtract between 1.093 and 1.119→</u>	<u>10.000</u>
10.000	→add 2.547→	12.547	→subtract between 1.093 and 1.119→	<u>11.428 to 11.454</u>
7.453	→add 2.547→	10.000	→subtract between 1.093 and 1.119→	<u>8.881 to 8.907</u>

1 a. Conversions to and from NAVD as indicated in this table represent the likely range. The
 2 precise conversion depends on the latitude and longitude of the location in question, as
 3 determined by a surveyor.

TABLE 104.7.6.3^a

MANHATTAN ELEVATIONS	TO OBTAIN EQUIVALENCY:	NGVD ELEVATIONS	TO OBTAIN EQUIVALENCY:	NAVD ELEVATIONS
<u>8.288 to 8.357</u>	<u>→add 2.752→</u>	<u>11.040 to 11.109</u>	<u>→subtract between 1.040 and 1.109→</u>	<u>10.000</u>
10.000	→add 2.752→	12.752	→subtract between 1.040 and 1.109→	<u>11.643 to 11.712</u>
7.248	→add 2.752→	10.000	→subtract between 1.040 and 1.109→	<u>8.891 to 8.960</u>

4 a. Conversions to and from NAVD as indicated in this table represent the likely range. The
 5 precise conversion depends on the latitude and longitude of the location in question, as
 6 determined by a surveyor.

TABLE 104.7.6.4^a

QUEENS ELEVATIONS	TO OBTAIN EQUIVALENCY:	NGVD ELEVATIONS	TO OBTAIN EQUIVALENCY:	NAVD ELEVATIONS
<u>8.361 to 8.381</u>	<u>→add 2.725→</u>	<u>11.086 to 11.106</u>	<u>→subtract between 1.086 and 1.106→</u>	<u>10.000</u>
10.000	→add 2.725→	12.725	→subtract between 1.086 and 1.106→	<u>11.619 to 11.639</u>
7.275	→add 2.725→	10.000	→subtract between 1.086 and 1.106→	<u>8.914 to 8.894</u>

1 a. Conversions to and from NAVD as indicated in this table represent the likely range. The
 2 precise conversion depends on the latitude and longitude of the location in question, as
 3 determined by a surveyor.

TABLE 104.7.6.5^a

STATEN ISLAND ELEVATIONS	TO OBTAIN EQUIVALENCY:	NGVD ELEVATIONS	TO OBTAIN EQUIVALENCY:	NAVD ELEVATIONS
<u>7.835 to 7.917</u>	<u>→add 3.192→</u>	<u>11.027 to 11.109</u>	<u>→subtract between 1.027 and 1.109→</u>	<u>10.000</u>
10.000	→add 3.192→	13.192	→subtract between 1.027 and 1.109→	<u>12.083 to 12.165</u>
6.808	→add 3.192→	10.000	→subtract between 1.027 and 1.109→	<u>8.891 to 8.973</u>

4 a. Conversions to and from NAVD as indicated in this table represent the likely range. The
 5 precise conversion depends on the latitude and longitude of the location in question, as
 6 determined by a surveyor.

7 **§28-104.7.7 Identification of special and progress inspections.** Whenever work or materials
 8 are subject to special inspection, as provided in this code, such work or materials shall be listed
 9 on the title sheet of the construction documents, or the sheet immediately following, as subject
 10 to special or progress inspection.

11 **§28-104.7.8 Identification of materials.** Construction documents shall identify all materials
 12 proposed to be used, including identification of the test standard to which they conform, and
 13 where applicable, supporting information or test data from the manufacturer attesting to such
 14 conformance.

15 **§28-104.7.9 Energy conservation code.** The application shall contain all information required
 16 to demonstrate compliance with the New York city energy conservation code. This information
 17 shall include signed and sealed construction drawings, including electrical drawings, to the extent
 18 that they demonstrate such energy code compliance, as required by such energy code and rules.

19 **§28-104.7.10 Preparer.** Each plan or drawing shall contain the license number, seal, signature
 20 (or equivalent as approved by the commissioner) and address of the registered design
 21 professional or landscape architect who prepared or supervised the preparation of the plans.

22 **§28-104.7.11 Additional information.** In addition to the data and information specified in this
 23 code and the rules of the department, the commissioner is authorized to require the submission
 24 of additional plans, surveys, computations, analyses, test reports, photographs, special inspection
 25 and such other data and information as may be necessary to determine compliance with this code
 26 and other applicable laws and rules.

27 **§28-104.7.12 Waiver of certain documents.** The commissioner is authorized to waive the
 28 submission of any of the required construction documents and other data if review of such

1 documents is not necessary to ascertain compliance with this code or not required for the phase
2 of work for which a permit is sought.

3 **§28-104.7.13 Identification of work involving raising or moving a building.** Where the lowest
4 above-grade floor or the lowest subgrade floor of a building is to be raised, lifted, elevated or
5 moved, such work shall be listed on the title sheet of the construction documents as subject to
6 special inspection.

7 **§28-104.7.14 Identification of certain I-1 and I-2 occupancies and of certain adult homes,
8 enriched housing, community residences and intermediate care facilities as exempt from
9 temporary external generator connection requirements.** The title sheet of construction
10 documents for the following buildings shall list whether the building is exempt from the
11 requirement to provide connections for temporary external generators pursuant to any exception
12 contained in [~~Sections~~] sections G304.5.1 or G304.5.2 of appendix G of the New York city
13 building code, as applicable:

- 14 1. A new or substantially improved building, as such term is defined in appendix G of the
15 New York city building code, that contains space classified in occupancy group I-1 or I-2
16 or space that is an adult home, enriched housing, community residence or intermediate
17 care facility classified as occupancy group R pursuant to an exception to section [~~308.2.1~~]
18 308.3.1 or [~~308.2.2~~] 308.3.2 of the New York city building code, and that is located in [~~an~~
19 ~~area of~~] a special flood hazard area, as such term is defined in appendix G of the New
20 York city building code; and
- 21 2. A new or substantially improved building that contains space classified as an occupancy
22 group I-2 hospital and that is located in a shaded X-Zone, as such terms are defined in
23 appendix G of the New York city building code.

24 **§28-104.7.15 Identification of certain hospitals as exempt from temporary external boiler or
25 chiller connection requirements.** The title sheet of construction documents for a new or
26 substantially improved building, as such term is defined in appendix G of the New York city
27 building code, that contains space classified as an occupancy group I-2 hospital and that is located
28 in [~~an area of special~~] a flood hazard [~~or shaded X-Zone~~] area, as such [~~terms are~~] term is defined
29 in appendix G of the New York city building code, shall list whether the requirement to provide
30 connections for temporary external boilers and chillers pursuant to [~~Item~~] item 2 of section
31 G304.5.2 is inapplicable as a result of such building having its boiler and chiller plants located at
32 or above the applicable design flood elevation.

33 **§28-104.7.16 Tenant protection plan.** The title sheet of construction documents shall contain a
34 statement requiring a tenant protection plan be submitted in accordance with the requirements of
35 article 120 prior to the issuance of a permit for alteration, construction or partial demolition work
36 in a building containing one or more occupied dwelling units.

37 **§28-104.7.17 Amended certificates of occupancy.** For amended certificates of occupancy
38 subject to section 28-118.16.2, the term construction documents, as used in section 28-116.2.4.1,
39 means an accurate and complete final lot survey made by a land surveyor, and floor and roof plans
40 showing, at a minimum, compliance with exit requirements in accordance with this code.

1 **§28-104.7.18 Multiple tax lots on a zoning lot.** For applications that will result in a new building
2 or an enlargement to an existing building, construction documents shall, on forms provided by the
3 department:

4 1. Identify whether the zoning lot consists of a single tax lot or multiple tax lots;

5 2. In the case of multiple tax lots on a zoning lot:

6 2.1. state whether each tax lot does or does not have a current certificate of occupancy;

7 2.2. for each tax lot that has a certificate of occupancy, state whether:

8 2.2.1. the address of the building or open lot use on each such certificate of occupancy
9 is consistent with the current lawful street address;

10 2.2.2. the block and/or tax lot numbers on each such certificate of occupancy is
11 consistent with the current tax maps as published by the Department of
12 Finance;

13 2.2.3. the certificate of occupancy indicates metes and bounds of a zoning lot and
14 whether such metes and bounds are inconsistent with the metes and bounds of
15 the zoning lot in the application; and

16 2.2.4. there is an existing building or an open lot use without a certificate of
17 occupancy.

18 2.3. Following a change in the metes and bounds of a zoning lot, construction documents
19 shall be filed by the owner of each tax lot with a certificate of occupancy that
20 indicates inconsistent metes and bounds to reflect the change in metes and bounds
21 of the zoning lot, in accordance with the requirements of section 28-118.3.2.1.

22 2.4. Following a change in the metes and bounds of a zoning lot, construction documents
23 shall be filed by the owner of each tax lot without a certificate of occupancy or where
24 the certificate of occupancy does not indicate inconsistent metes and bounds, in
25 accordance with the requirements of section 28-118.3.3.

26 **§28-104.7.18.1 Obligations of owners of other tax lot.** Within one year from the approval
27 of construction documents for a new building or enlargement on a zoning lot consisting of
28 multiple tax lots, the owners of all tax lots on the zoning lot shall comply with sections 28-
29 118.3.2.1, 28-118.3.3 and 28-118.3.5.1 as applicable.

30 **Exception.** For the purpose of this section, condominium tax lots and air parcel tax lots
31 shall not be deemed to be multiple tax lots.

32 **§28-104.8 Applications.** All applications shall comply with sections 28-104.8.1 through 28-104.8.3.

33 **§28-104.8.1 Applicant statements.** The application shall contain the following signed and sealed
34 statements by the applicant:

35 1. A statement certifying that the applicant is authorized by the owner to make the
36 application and certifying that, to the best of the applicant's knowledge and belief, the
37 construction documents comply with the provisions of this code or the 1968 building
38 code, if applicable, and other applicable laws and rules; if there exist practical difficulties

1 in the way of carrying out the strict letter of the code, laws or rules, the applicant shall
2 set forth the nature of such difficulties in such signed statement;

3 2. A professional certification; and

4 3. A statement certifying compliance with the New York city energy conservation code.

5 **§28-104.8.2 Owner statements.** The application shall contain a signed statement by the owner,
6 and, in the case of cooperative or condominium forms of ownership, the application shall also
7 contain a statement by the cooperative or condominium board, affirming that the applicant is
8 authorized to make the application and, if applicable, acknowledging that construction and
9 related documents will be accepted with less than full examination by the department based on
10 the professional certification of the applicant. Such statement shall list the owner's full name and
11 address, as well as the names of the principal officers, partners or other principals if a
12 corporation, partnership or other entity. Principal officers of a corporation shall be deemed to
13 include the president, vice presidents, secretary and treasurer. Where a current deed holder with
14 a valid property interest or a court appointed entity or equivalent in charge of the property, or in
15 the case of a cooperative or condominium unit, the cooperative or condominium board, notifies
16 the department in writing that the applicant does not have authority to make the application, the
17 department is authorized pursuant to section 28-104.2.10 to revoke approval of construction
18 documents. In addition, the application shall contain the following:

19 1. A signed statement certifying whether the building to be altered, constructed or
20 demolished contains one or more occupied dwelling units;

21 2. A signed statement indicating whether the building to be altered, constructed or
22 demolished contains housing accommodations subject to rent control or rent stabilization
23 under chapters 3 and 4 of title 26 of the administrative code or rent regulation under
24 ~~[Article]~~ article 7-C of the [Multiple Dwelling Law] New York state multiple dwelling
25 law; and

26 3. If the building to be altered, constructed or demolished contains occupied housing
27 accommodations subject to rent control under chapter 3 of title 26 of the administrative
28 code, the application shall contain a signed statement indicating that the owner has notified
29 the New York state division of homes and community renewal that the owner has
30 complied with all requirements imposed by the regulations of such agency as
31 preconditions for such filing; or that the owner has not notified such agency because the
32 nature and scope of the work proposed, pursuant to such regulations, does not require
33 notification; or, if the building is subject to ~~[Article]~~ article 7-C of the [Multiple Dwelling
34 Law] New York state multiple dwelling law, the application shall contain a signed
35 statement indicating that the owner will notify the ~~[New York City Loft Board]~~ loft board
36 of the filing of the construction documents and will comply with all requirements imposed
37 by ~~[Multiple Dwelling Law Article]~~ New York state multiple dwelling law article 7-C and
38 the [Loft Board's] loft board's rules.

39 **§28-104.8.3 Information of applicant, filing representative, and owner.** The application shall
40 set forth the full names, addresses, telephone numbers, and ~~[where available,]~~ [e-mail] electronic
41 mail addresses of the following persons and where any of such persons are corporations,
42 partnerships or other business entities, the names and addresses of the principal officers, partners
43 or other principals of such entity:

- 1 1. The applicant;
- 2 2. The filing representative;
- 3 3. The owner, and, in the case of cooperative or condominium forms of ownership,
4 cooperative owners' corporation, or condominium owners' association; and
- 5 4. Where a person other than the owner has engaged the applicant, such cooperative unit
6 shareholder, condominium unit owner, lessee, or mortgagee.

7 **§28-104.9 Coastal zones and water-sensitive inland zones.** Construction documents shall comply
8 with sections 28-104.9.1 through 28-104.9.6 relating to work in coastal zones and water-sensitive
9 inland zones.

10 **§28-104.9.1 Definitions.** As used in section 28-104.9 the following terms shall have the
11 following meanings:

12 **COASTAL [~~AREAS OF~~] SPECIAL FLOOD HAZARD AREAS.** Areas of land as identified
13 on the flood insurance rate maps referenced in New York city building code section G402 of
14 appendix G pursuant to article 36 of the New York state environmental conservation law.

15 **COASTAL EROSION HAZARD AREAS.** Areas of land as identified on the final map issued
16 by the New York state department of environmental conservation in accordance with section 34-
17 0104 of the New York state environmental conservation law.

18 **COASTAL ZONES AND WATER-SENSITIVE INLAND ZONES.** Areas of land comprising
19 tidal wetlands, freshwater wetlands, coastal erosion hazard areas, coastal [~~areas of~~] special flood
20 hazard areas or rivervine and other inland [~~areas of~~] special flood hazard areas.

21 **FRESHWATER WETLANDS.** Areas of land as identified on the final map issued by the New
22 York state department of environmental conservation in accordance with section 24-0301 of the
23 New York state environmental conservation law, as well as any adjacent areas as such term is
24 defined in section 662.1 of title [~~six~~] 6 of the New York code of rules and regulations.

25 **RIVERVINE AND OTHER INLAND [~~AREAS OF~~] SPECIAL FLOOD HAZARD AREAS.**
26 Areas of land, including floodways, as identified on the flood insurance rate maps referenced in
27 section G402 of the New York city building code pursuant to article 36 of the New York state
28 environmental conservation law.

29 **STRUCTURE.** Any object constructed, installed or placed in, on or under land or water,
30 including, but not limited to, a building, permanent shed, deck, in-ground or aboveground
31 swimming pool, garage, mobile home, paving, road, public utility service distribution,
32 transmission and collection system, storage tank, pier, dock, wharf, groin, jetty, seawall,
33 revetment, bulkhead or breakwater.

34 **TIDAL WETLANDS.** Areas of land as identified on the tidal wetland inventory issued by the
35 New York state department of environmental conservation in accordance with section 25-0201
36 of the New York state environmental conservation law, as well as any adjacent areas as such
37 term is defined in section 661.4 of title [~~six~~] 6 of the New York code of rules and regulations.

1 **§28-104.9.2 Statement and submission by applicant.** It shall be the duty of an applicant for
2 construction document approval to determine whether the proposed work is located within a
3 coastal zone or a water-sensitive inland zone subject to section 28-104.9.3 and/or section 28-
4 104.9. Applications for construction document approval shall include a statement by the
5 applicant indicating whether the proposed work is located within a coastal zone or water-
6 sensitive inland zone subject to such sections. The failure to disclose that proposed work is within
7 a coastal zone or water-sensitive inland zone subject to such sections shall be a violation of this
8 code.

9 **§28-104.9.3 Coordination with department of environmental conservation and other**
10 **agencies.** The commissioner shall not approve construction documents for construction of a new
11 structure, the horizontal enlargement of a structure or to excavate or fill any land, within a tidal
12 wetland, a tidal wetland adjacent area, freshwater wetland, freshwater wetland adjacent area, or
13 coastal erosion hazard area, without documentation satisfactory to the commissioner that the
14 New York state department of environmental conservation, and such other governmental
15 agencies as are applicable, have issued any applicable permits or other approvals for such
16 construction, excavation or fill.

17 **§28-104.9.4 Compliance with special flood hazard area requirements mandated within**
18 **special flood hazard areas.** Within coastal [~~areas of~~] special flood hazard areas and [~~areas of~~]
19 special flood hazard areas, the commissioner shall not approve construction documents for
20 construction or alteration of buildings or structures, including alterations pursuant to section 28-
21 101.4.3 of this code, or for any other activity regulated by section G201 of appendix F of the
22 New York city building code, unless the application complies with the requirements of
23 [~~Appendix~~] appendix G of the New York city building code.

24 **§28-104.9.5 False statement or omission.** No person shall submit an application for construction
25 document approval for any structure within a coastal zone or water-sensitive inland zone [~~which~~]
26 that falsely avers or by omission causes the department to determine that the subject property is
27 not located within such zone or that the New York state department of environmental
28 conservation and other appropriate agencies have issued the appropriate permits or approvals
29 when they did not.

30 **§28-104.9.6 Revocation of approval of construction documents.** Where the department
31 determines that work is located within a coastal zone or water-sensitive inland zone after
32 construction documents have been approved for such work and/or that the documentation
33 required by sections 28-104.9.2 through 28-104.9.4 has not been submitted, the department shall
34 revoke such approval and any associated work permits that may have been issued for such work
35 in accordance with section 28-104.2.10.

36 **§28-104.10 [~~Construction documents for sites near subways or tunnels.] Notification to the New~~**
37 **York city transit authority, the Metropolitan Transportation Authority and the Port Authority**
38 **of New York and New Jersey.** Construction documents shall not be approved unless all applicable
39 agency approvals [~~regarding nearby subways or tunnels~~] from the New York city transit authority,
40 the Metropolitan Transportation Authority or the Port Authority of New York and New Jersey, as
41 provided for in [~~sections 3304.3.3 and~~] section 3304.3.5 of the New York city building code have
42 been submitted to the department.

1 **§28-104.11 Construction documents for sites that are covered development projects as defined**
2 **in section 24-541 of the administrative code.** Construction documents for sites that are covered
3 development projects as defined in section 24-541 of the administrative code shall comply with
4 section 28-104.11.1 through 28-104.11.4.

5 **§28-104.11.1 Definitions.** As used in this code in connection with provisions relating to the
6 jurisdiction of the department of environmental protection, the terms covered development
7 project, development activity, post-construction stormwater management facility, stormwater
8 construction permit, stormwater maintenance permit, and stormwater pollution prevention plan
9 or SWPPP shall have the same definitions as such terms are defined in subchapter 1 of chapter 5-
10 A of title 24 of the administrative code.

11 **§28-104.11.2 Disclosure required.** It shall be the duty of an applicant for construction document
12 approval to determine whether the site of the proposed work is part of a covered development
13 project and to disclose such information on construction documents. Failure to disclose such
14 information on construction documents shall be a violation of this code.

15 **§28-104.11.3 Required documentation.** Applications for construction document approval shall
16 include copies of any required stormwater construction permit issued by the department of
17 environmental protection and the stormwater pollution prevention plan for the covered
18 development project.

19 **§28-104.11.4 Revocation of approval of construction documents.** Where the department finds
20 after the approval of construction documents that the applicant failed to disclose the information
21 required by this section, the department may revoke such approval and any associated work
22 permits in accordance with the provisions of sections 28-104.2.10 and 28-104.2.10.1.

23 **§28-104.12 Retention of construction and submittal documents.** An applicant shall retain one
24 set of approved construction documents, submittal documents and any other documents required
25 by department rule for a period of not less than six years from the date of completion of the
26 permitted work.

27 **§28-104.13 Construction documents for extension, alteration or relocation of an existing**
28 **chimney or vent.** Where an owner of a new or altered taller building is required by section 2113 of
29 the New York city building code, section 801 of the New York city mechanical code or section 501
30 of the New York city fuel gas code to extend, alter or relocate an existing chimney or vent on an
31 affected building, such work shall be filed under a separate application for the affected building.

32 **ARTICLE 105**
33 **PERMITS**

34 **§28-105.1 General.** It shall be unlawful to construct, enlarge, alter, repair, move, demolish, remove
35 or change the use or occupancy of any building or structure in the city, to change the use or
36 occupancy of an open lot or portion thereof, or to erect, install, alter, repair, or use or operate any
37 sign or service equipment in or in connection therewith, or to erect, install, alter, repair, remove,
38 convert or replace any gas, mechanical, plumbing, fire suppression or fire protection system in or in
39 connection therewith or to cause any such work to be done unless and until a written permit

1 ~~[therefore]~~ therefor shall have been issued by the commissioner in accordance with the requirements
2 of this code, subject to such exceptions and exemptions as may be provided in section 28-105.4.

3 **§28-105.1.1 Notification to fire department.** The commissioner, in consultation with the fire
4 commissioner, shall establish a procedure for notifying the fire department of the issuance of any
5 permit that will result in the issuance of a new or amended certificate of occupancy or other
6 change in the use or occupancy of the premises. In no instance shall the required notice be given
7 to the fire department more than one business day after the date of the issuance of the permit.

8 **§28-105.1.2 Projects for which a stormwater construction permit is required.** It shall be a
9 violation of this code to engage in any development activity with respect to a covered development
10 project without a stormwater construction permit issued by the department of environmental
11 protection. The issuance of a permit pursuant to this code shall not be construed to be permission
12 for any activity that requires a stormwater construction permit issued by the department of
13 environmental protection pursuant to chapter 5-A of title 24 of the administrative code. The
14 issuance of a stormwater construction permit by the department of environmental protection shall
15 not be construed as permission for work that requires a permit from the department of buildings
16 pursuant to this code.

17 ~~**§28-105.1.2 Denial of permits for certain arrears.** The commissioner shall not issue a permit
18 for a new building, demolition, place of assembly or major alteration that will change the use,
19 egress or occupancy for a property if \$25,000 or more in covered arrears is owed to the city with
20 respect to such property or if the owners of such property owe, in aggregate, \$25,000 or more in
21 covered arrears to the city, provided that, where a dwelling unit within a property is owned as a
22 condominium or held by a shareholder of a cooperative corporation under a proprietary lease,
23 covered arrears owed to the city for such unit shall not be considered covered arrears owed to the
24 city for such property. For the purposes of this section, the term "covered arrears" may include
25 any of the following, but shall not include any such items that are currently in the appeals process:]~~

26 ~~[1. Unpaid fines, civil penalties or judgments entered by a court of competent jurisdiction or
27 the environmental control board pursuant to chapter 2 of this title or chapter 2 of title 28
28 of the code; and]~~

29 ~~[2. Unpaid and past due fees or other charges lawfully assessed by the commissioner.]~~

30 **[Exceptions:]**

31 ~~[1. The commissioner may issue a permit for a property if the applicant submits a
32 certification from the department of finance that binding agreements are in force
33 requiring payment of all covered arrears owed by the owners of such property, and
34 such owners are in compliance with such agreement.]~~

35 ~~[2. The commissioner may issue a permit for a property where the issuance of such permit
36 is necessary to correct an outstanding violation of this code, the housing maintenance
37 code or any other applicable provisions of law or rule or where the commissioner
38 determines that issuance of such permit is necessary to perform work to protect public
39 health and safety.]~~

- 1 ~~[3. The commissioner may issue a permit for a portion of a property occupied by a tenant~~
2 ~~who is not an owner of such property or responsible for any covered arrears owed with~~
3 ~~respect to such property.]~~
- 4 ~~[4. The commissioner may issue a permit, for a dwelling unit within a property that is~~
5 ~~owned by a condominium or held by a shareholder of a cooperative corporation under~~
6 ~~a proprietary lease, if the owners of record for such unit do not owe, in aggregate,~~
7 ~~\$25,000 or more in covered arrears to the city.]~~
- 8 ~~[5. The commissioner may issue a permit where a property was the subject of an in rem~~
9 ~~foreclosure judgment in favor of the city and was transferred by the city to a third party~~
10 ~~pursuant to section 11-412.1 of the code.]~~
- 11 ~~[6. The commissioner may issue a permit where a property is the subject of a court order~~
12 ~~appointing an administrator pursuant to article 7-a of the real property actions and~~
13 ~~proceedings law in a case brought by the department of housing preservation and~~
14 ~~development.]~~
- 15 ~~[7. The commissioner may issue a permit where a property is the subject of a loan~~
16 ~~provided by or through the department of housing preservation and development or~~
17 ~~the New York city housing development corporation for the purpose of rehabilitation~~
18 ~~that has closed within the five years preceding the application for such permit.]~~
- 19 ~~[8. The commissioner may issue a permit for a property where the department of housing~~
20 ~~preservation and development or the New York city housing development corporation~~
21 ~~notifies the commissioner that the permit is required for participation in a program that~~
22 ~~involves rehabilitation of such property.]~~

23 **§28-105.1.3 Denial of permits for excessive violations.** The commissioner shall, no less than
24 once every six months, compile a list of multiple dwellings that includes: (i) all multiple dwellings
25 containing fewer than 35 units that have a ratio of open hazardous or immediately hazardous New
26 York city housing maintenance code violations or immediately hazardous or major construction
27 code violations that equal in the aggregate three or more such violations for every dwelling unit
28 in such multiple dwelling; and (ii) all multiple dwellings containing 35 units or more that have a
29 ratio of open hazardous or immediately hazardous New York city housing maintenance code
30 violations or immediately hazardous or major construction code violations that equal in the
31 aggregate two or more such violations for every dwelling unit in such multiple dwelling. The
32 commissioner shall not issue permits for multiple dwellings on such list. If the owner of a multiple
33 dwelling on such list corrects open hazardous or immediately hazardous New York city housing
34 maintenance code violations or immediately hazardous or major construction code violations in
35 such multiple dwelling so that the ratio of such violations to the number of dwelling units in such
36 multiple dwelling falls below those outlined in this section, the commissioner shall remove such
37 multiple dwelling from such list. Such denial shall not apply where a dwelling unit within such
38 multiple dwelling is owned as a condominium or held by a shareholder of a cooperative
39 corporation under a proprietary lease.

40 **Exceptions:**

- 41 1. Where the issuance of such permit is necessary to correct an outstanding violation of
42 this code, the New York city housing maintenance code or any other applicable
43 provisions of law or rule.

2. Where the issuance of such permit is necessary to perform work to protect public health and safety.
3. For a portion of a property occupied by a tenant who is not an owner of such property or responsible for any existing violations in such property.
4. Where a property was the subject of an in rem foreclosure judgment in favor of the city and was transferred by the city to a third party pursuant to section 11-412.1 of the administrative code.
5. Where a property is the subject of a court order appointing an administrator pursuant to article 7-a of the New York state real property actions and proceedings law in a case brought by the department of housing preservation and development.
6. Where a property is the subject of a loan provided by or through the department of housing preservation and development or the New York city housing development corporation for the purpose of rehabilitation that has closed within the five years preceding the application for such permit.
7. For a property where the department of housing preservation and development or the New York city housing development corporation notifies the commissioner that the permit is required in connection with the implementation of a program of such department or corporation.

§28-105.1.4 Denial of permits for false statements on applications for construction document approval. The commissioner shall not issue a permit for an occupied building for at least one year following the date of a determination by the commissioner that a false statement about the occupancy status of such building has been made in an application for construction document approval. Such denial shall not apply where a dwelling unit within such multiple dwelling is owned as a condominium or held by a shareholder of a cooperative corporation under a proprietary lease.

Exceptions:

1. Where the issuance of such permit is necessary to correct an outstanding violation of this code, the New York city housing maintenance code or any other applicable provisions of law or rule.
2. Where the issuance of such permit is necessary to perform work to protect public health and safety.
3. For a portion of a property occupied by a tenant who is not an owner of such property or responsible for any existing violations in such property.
4. Where a property was the subject of an in rem foreclosure judgment in favor of the city and was transferred by the city to a third party pursuant to section 11-412.1 of the administrative code.
5. Where a property is the subject of a court order appointing an administrator pursuant to article 7-a of the New York state real property actions and proceedings law in a case brought by the department of housing preservation and development.
6. Where a property is the subject of a loan provided by or through the department of housing preservation and development or the New York city housing development

1 corporation for the purpose of rehabilitation that has closed within the five years
2 preceding the application for such permit.

- 3 7. For a property where the department of housing preservation and development or the
4 New York city housing development corporation notifies the commissioner that the
5 permit is required in connection with the implementation of a program of such
6 department or corporation.

7 **§28-105.1.5 Denial of permits for work without permit on occupied building.** The
8 commissioner shall not issue a permit for a building for at least one year following the date of a
9 determination by the commissioner that work has been performed without a permit in such
10 building and such building was occupied at the time such work was being performed. Such denial
11 shall not apply where a dwelling unit within such multiple dwelling is owned as a condominium
12 or held by a shareholder of a cooperative corporation under a proprietary lease.

13 **Exceptions:**

- 14 1. Where the issuance of such permit is necessary to correct an outstanding violation of
15 this code, the New York city housing maintenance code or any other applicable
16 provisions of law or rule.
- 17 2. Where the issuance of such permit is necessary to perform work to protect public
18 health and safety.
- 19 3. For a portion of a property occupied by a tenant who is not an owner of such property
20 or responsible for any existing violations in such property.
- 21 4. Where a property was the subject of an in rem foreclosure judgment in favor of the
22 city and was transferred by the city to a third party pursuant to section 11-412.1 of the
23 administrative code.
- 24 5. Where a property is the subject of a court order appointing an administrator pursuant
25 to article 7-a of the New York state real property actions and proceedings law in a case
26 brought by the department of housing preservation and development.
- 27 6. Where a property is the subject of a loan provided by or through the department of
28 housing preservation and development or the New York city housing development
29 corporation for the purpose of rehabilitation that has closed within the five years
30 preceding the application for such permit.
- 31 7. For a property where the department of housing preservation and development or the
32 New York city housing development corporation notifies the commissioner that the
33 permit is required in connection with the implementation of a program of such
34 department or corporation.

35 **§28-105.1.6 Denial of permits for certain arrears.** The commissioner shall not issue a permit
36 for a new building, demolition, place of assembly or major alteration that will change the use,
37 egress or occupancy for a property if \$25,000 or more in covered arrears is owed to the city with
38 respect to such property or if the owners of such property owe, in aggregate, \$25,000 or more in
39 covered arrears to the city, provided that, where a dwelling unit within a property is owned as a
40 condominium or held by a shareholder of a cooperative corporation under a proprietary lease,
41 covered arrears owed to the city for such unit shall not be considered covered arrears owed to the

1 city for such property. For the purposes of this section, the term “covered arrears” may include
2 any of the following, but shall not include any such items that are currently in the appeals process:

- 3 1. Unpaid fines, civil penalties or judgments entered by a court of competent jurisdiction or
4 the environmental control board pursuant to chapter 2 of this title; and
- 5 2. Unpaid and past due fees or other charges lawfully assessed by the commissioner.

6 **Exceptions:**

- 7 1. The commissioner may issue a permit for a property if the applicant submits a
8 certification from the department of finance that binding agreements are in force
9 requiring payment of all covered arrears owed by the owners of such property, and
10 such owners are in compliance with such agreement.
- 11 2. The commissioner may issue a permit for a property where the issuance of such permit
12 is necessary to correct an outstanding violation of this code, the New York city housing
13 maintenance code or any other applicable provisions of law or rule or where the
14 commissioner determines that issuance of such permit is necessary to perform work to
15 protect public health and safety.
- 16 3. The commissioner may issue a permit for a portion of a property occupied by a tenant
17 who is not an owner of such property or responsible for any covered arrears owed with
18 respect to such property.
- 19 4. The commissioner may issue a permit, for a dwelling unit within a property that is
20 owned by a condominium or held by a shareholder of a cooperative corporation under
21 a proprietary lease, if the owners of record for such unit do not owe, in aggregate,
22 \$25,000 or more in covered arrears to the city.
- 23 5. The commissioner may issue a permit where a property was the subject of an in rem
24 foreclosure judgment in favor of the city and was transferred by the city to a third party
25 pursuant to section 11-412.1 of the administrative code.
- 26 6. The commissioner may issue a permit where a property is the subject of a court order
27 appointing an administrator pursuant to article 7-a of the New York state real property
28 actions and proceedings law in a case brought by the department of housing
29 preservation and development.
- 30 7. The commissioner may issue a permit where a property is the subject of a loan
31 provided by or through the department of housing preservation and development or
32 the New York city housing development corporation for the purpose of rehabilitation
33 that has closed within the five years preceding the application for such permit.
- 34 8. The commissioner may issue a permit for a property where the department of housing
35 preservation and development or the New York city housing development corporation
36 notifies the commissioner that the permit is required for participation in a program that
37 involves rehabilitation of such property.

38 **§28-105.2 Classification of work permits.** For the purposes of this code, work permits shall be
39 classified as follows:

- 1 1. **New building permits:** for the construction of new buildings, including as provided for in
2 section 28-101.4.5.
- 3 2. **Alteration permits:** for the alteration of buildings or structures, including new and existing
4 sign structures and partial demolition in conjunction with such buildings or structures.
- 5 3. **Foundation and earthwork permits:** for the construction or alteration of foundations,
6 including earthwork, excavation, fill, and foundation insulation.
- 7 4. **Earthwork permits:** for work solely involving earthwork, excavation, or fill operations.
- 8 5. **Full demolition permits:** for the full demolition and removal of buildings or structures.
- 9 6. **Plumbing permits:** for the installation or alteration of plumbing and plumbing systems,
10 including gas piping. Such permits shall include permits for limited plumbing alterations.
- 11 7. **Sign permits:** for the erection, installation, display or alteration of signs.
- 12 8. **Service equipment permits:** for the installation or alteration of service equipment,
13 including but not limited to air conditioning and ventilating systems, boilers, elevators,
14 escalators, moving walkways, dumbwaiters, mobile boilers and mobile oil tanks. Such
15 permits shall include permits for limited [~~oil burner/boiler~~] oil-burning appliance alterations.
- 16 9. **Temporary construction ~~[equipment]~~ installation permits:** for the erection, installation
17 and use of temporary [~~structures~~] construction installations to facilitate construction and/or
18 safety during construction, including but not limited to temporary fences, railings, catch
19 platforms, over-the-sidewalk chutes, footbridges, sidewalk sheds, and scaffolds.
- 20 10. **Fire protection and suppression system permits:** for the installation and alteration of fire
21 protection and suppression systems, including sprinkler systems and standpipe systems. Such
22 permits shall include permits for limited sprinkler alterations and limited standpipe
23 alterations.
- 24 11. **Crane and derrick permits:** for the use of power operated cranes and derricks during
25 construction.
- 26 **12. Temporary structure permits and temporary use authorizations:** for temporary
27 structures and uses, see article 111.

28 **§28-105.2.1 Submittal documents required for foundations and earthwork.** Prior to the
29 issuance of any permit for work that includes foundations and/or earthwork, submittal documents
30 clearly illustrating support of excavation design, including but not limited to stepping, sheeting,
31 sloping, shoring, and bracing, and any protective railings or equipment required by chapter 33 of
32 the New York city building code shall be required.

33 **§28-105.2.2 Submittal documents required for partial and full demolition.** Prior to the
34 issuance of any permit for work that includes full or partial demolition, submittal documents shall
35 be required in accordance with chapter 33 of the New York city building code.

36 **§28-105.3 Separate permits required.** Separate work permits shall be required, as provided above,
37 except that separate permits for foundations and earthwork, or for the installation or alteration of air
38 conditioning systems, ventilation systems, and heating systems shall not be required whenever such
39 work is included in and forms a part of the construction documents filed for the construction of a
40 new building or the alteration of a building or structure.

1 **§28-105.4 Work exempt from permit.** Exemptions from permit requirements of this code shall not
2 be deemed to grant authorization for any work to be done in any manner in violation of the provisions
3 of this code, the zoning resolution or any other law or rules enforced by the department. Such
4 exemptions shall not relieve any owner of the obligation to comply with the requirements of or file
5 with other city agencies. Unless otherwise indicated, permits shall not be required for the following:

- 6 1. Emergency work, as set forth in section 28-105.4.1.
- 7 2. Minor alterations and ordinary repairs, as described in section 28-105.4.2.
- 8 3. Certain work performed by a public utility company or public utility corporation, as set forth
9 in section 28-105.4.3.
- 10 4. Ordinary plumbing work, as set forth in section 28-105.4.4.
- 11 5. Permits for the installation of certain signs, as set forth in section 28-105.4.5.
- 12 6. Geotechnical investigations, as set forth in section 28-105.4.6.
- 13 7. The installation, alteration or removal of alternative automatic fire extinguishing systems,
14 including but not limited to fire extinguishing systems for commercial cooking equipment,
15 subject to the approval of the fire department in accordance with section 105 of the New
16 York city fire code.
- 17 8. The installation, alteration or removal of fire alarm systems, emergency alarm systems and
18 fire department in-building auxiliary radio communication systems, subject to the approval
19 of the fire department in accordance with the requirements of this code. Such work shall be
20 submitted in accordance with the rules and regulations of the fire department.
- 21 9. Other categories of work as described in department rules, consistent with public safety.

22 **§28-105.4.1 Emergency work.** Work that would otherwise require a permit may be performed
23 without a permit to the extent necessary to relieve an emergency condition. An application for a
24 permit shall be submitted within 2 business days after the commencement of the emergency work
25 and shall include written description of the emergency condition and the measures undertaken to
26 mitigate the hazard. Emergency work may include but shall not be limited to:

- 27 1. Erection of sidewalk sheds, fences, or other similar structures to protect the public from
28 an unsafe condition.
- 29 2. Stabilization of unsafe structural conditions.
- 30 3. Repair of gas leaks.
- 31 4. Repair or replacement of heating or hot water equipment servicing education or
32 residential occupancies during the heating season, which is between October 1 and May
33 31, as established by the New York city housing maintenance code or education
34 occupancies between [~~November 1st and May 1st~~].
- 35 5. Replacement of parts required for the operation of a combined standpipe or sprinkler
36 system.

37 **§28-105.4.2 Minor alterations and ordinary repairs.** A permit shall not be required for minor
38 alterations and ordinary repairs.

1 **§28-105.4.2.1 Definitions.** The following words and terms shall, for the purposes of [this] section
2 28-105.4.2 and as used elsewhere in this code, have the meanings shown herein.

3 **MINOR ALTERATIONS.** Minor changes or modifications in a building or any part thereof,
4 excluding additions thereto, that do not in any way affect health or the fire or structural safety of
5 the building or the safe use and operation of the service equipment therein. Minor alterations
6 shall not include any of the work described as “work not constituting minor alterations or
7 ordinary repairs.”

8 **ORDINARY REPAIRS.** Replacements or renewals of existing work in a building, or of parts
9 of the service equipment therein, with the same or equivalent materials or equipment parts, that
10 are made in the ordinary course of maintenance and that do not in any way affect health or the
11 fire or structural safety of the building or the safe use and operation of the service equipment
12 therein. Ordinary repairs shall include the repair or replacement of any plumbing fixture, piping
13 or faucets from any exposed stop valve to the inlet side of a trap. Ordinary repairs shall not
14 include any of the work described as “work not constituting minor alterations or ordinary
15 repairs.”

16 **WORK NOT CONSTITUTING MINOR ALTERATIONS OR ORDINARY REPAIRS.**
17 Minor alterations or ordinary repairs shall not include:

- 18 1. The removal or cutting away of any load bearing or required fire rated wall, fire door,
19 floor, or roof construction, or any portion thereof [-];
- 20 2. The removal, cutting, or modification of any beams or structural supports;
- 21 3. The removal, change, or closing of any required exit;
- 22 4. The addition, rearrangement, relocation, removal or replacement of any parts of the
23 building affecting loading or exit requirements, or light, heat, ventilation, or elevator
24 requirements or accessibility requirements, or any fire suppression or fire protection
25 system;
- 26 5. Additions to, alterations of, or rearrangement, relocation, replacement, repair or removal
27 of any portion of a standpipe or sprinkler system, water distribution system, house sewer,
28 private sewer, or drainage system, including leaders, or any soil, waste or vent pipe, or
29 any gas distribution system;
- 30 6. Any plumbing work other than the repair or replacement of plumbing fixtures, piping or
31 faucets from the exposed stop valve to the inlet side of a trap;
- 32 7. The alteration or repair of a sign for which a permit is required; or
- 33 8. Any other work affecting health or the fire or structural safety of the building or the safe
34 use and operation of the service equipment therein.

35 **§28-105.4.3 Public utility company or public utility corporation.** A permit shall not be
36 required for:

- 37 1. The installation or alteration of gas service piping or gas meter piping including meters,
38 valves, regulators, and related equipment, when such work is to be performed and

1 serviced and maintained by utility corporations subject to the jurisdiction of the New
2 York state public service commission [;].

- 3 2. The emergency repair of gas distribution piping when such work is performed by licensed
4 master plumbers or by utility corporations subject to the jurisdiction of the New York
5 state public service commission, in order to alleviate hazardous conditions, provided that
6 a written report describing the details of such repairs shall be filed with the commissioner
7 upon completion of the work.

8 **§28-105.4.4 Ordinary plumbing work.** The following ordinary plumbing work may be
9 performed without a permit, provided that the licensed plumber performing such work: (i)
10 provides a monthly report listing completed work and work in progress during the preceding
11 month, including the block, lot and address of each job, a description of the work performed or
12 in progress at each address, and the location in each building where the work was performed or
13 is in progress; (ii) pays the fees for such work in accordance with this code; and (iii) submits to
14 the department a certification that the work was performed in accordance with this code and all
15 applicable laws and rules. Ordinary plumbing work shall include:

- 16 1. The removal of a domestic plumbing system not connected to a fire suppression or fire
17 protection system, or the removal of a portion of such system.
- 18 2. The relocation of up to two plumbing fixtures within the same room to a maximum of 10
19 feet (3048 mm) distant from the original location, except in health care facilities.
- 20 3. The installation, replacement or repair of a food waste grinder (food waste disposal) or
21 secondary back flow preventer and the replacement or repair of a sump pump.
- 22 4. The replacement of closet bends.
- 23 5. In buildings in occupancy group R-2 occupied by fewer than six families or in buildings
24 in occupancy group R3, the replacement of a gas water heater or a gas fired boiler with a
25 capacity of 350,000 BTU (103 kW) or less where the existing appliance gas cock is not
26 moved, provided that the plumber has inspected the chimney and found it to be in good
27 operational condition.
- 28 6. The repair or replacement of any non-gas, non-fire suppression piping not longer than 10
29 feet (3048 mm) inside a building, or connected piping previously repaired or replaced
30 under this provision.
- 31 7. The repair or replacement of non-fire suppression branch piping after the riser shutoff
32 valve, including the replacement of fixtures, limited to two bathrooms and one kitchen
33 per building per monthly reporting period.
- 34 8. The replacement of flexible gas tubing no greater than 4 feet (1219 mm) in length located
35 downstream of the existing gas cock to an appliance, provided such gas tubing does not
36 penetrate a wall.

37 **§28-105.4.5 Sign permits.** A sign permit shall not be required where the sign is:

38 [~~1. Painted directly on the exterior wall surface of a building or on the surface of a fence;~~]

39 [~~2.~~] 1. A wall sign of not more than six square feet (0.56 m²) in area;

40 [~~3.~~] 2. Erected by employees of a city agency, including traffic and other similar signs;

1 [4.] 3. A ground sign offering the sale or rental of the premises on which it is erected,
2 provided the sign does not exceed 12 square feet (1.1 m²) in area, and is removed
3 immediately upon such sale or rental;

4 [5.] 4. Temporary and erected during construction work [~~and related thereto~~] as required by
5 chapter 33 of the New York city building code or other applicable law;

6 [6.] 5. Temporary for special decorative display use for holidays, public demonstrations, or
7 the promotion of civic, welfare or charitable purposes, except that signs that utilize
8 streets or cross streets shall be subject to the requirements of the department of
9 transportation; or

10 [7.] 6. Temporary signs offering the sale or rental of real property when erected on the
11 premises offered for sale or rent, and is removed immediately upon such sale or rental.

12 **§28-105.4.6 Geotechnical investigations.** A permit shall not be required for excavation
13 performed for a geotechnical investigation required by section [1802.4] 1803.4 of the New York
14 city building code provided such excavation does not exceed 10 feet (3048 mm) in length, width,
15 or diameter and is conducted under the supervision of a registered design professional. All
16 excavation activity, including backfilling of excavations, shall comply with all relevant code
17 provisions, including but not limited to sections 1803 and 3304 of the New York city building
18 code.

19 **§28-105.5 Application for permit.** All applications for permits shall be submitted on forms
20 furnished by the department. Applications shall include all information required by this code, other
21 applicable law or the rules of the department. The applicant shall list any portions of the design that
22 have been approved for deferred submittal in accordance with section 28-104.2.6. The application
23 shall set forth an inspection program for the project. An application for a permit shall be submitted
24 no later than 12 months after the approval of all required construction documents (other than those
25 documents approved for deferred submittal). The department shall provide written notification to
26 owners of adjoining property at the time such application is submitted.

27 **§28-105.5.1 Applicant for permit.** The applicant for a permit shall be the person who performs
28 the work or who retains a subcontractor to do the work.

29 **Exception:** For permits issued for plumbing work, fire protection and suppression work, and
30 [~~oil burner/boiler~~] oil-burning appliance work, the applicant for such permits shall be the
31 licensed master plumber, licensed master fire suppression piping contractor, or licensed oil-
32 burning equipment installer, respectively, who performs the work.

33 [~~§28-105.5.1~~] **§28-105.5.2 Application for permit where a building is occupied.** All
34 applications for permits for work on a building having more than three dwelling units shall state
35 (i) the total number of units in the building at the time the application is filed, [and] (ii) the number
36 of units occupied at the time the application is filed, and (iii) the number of units to be occupied
37 during the course of the work. The work permit application shall be amended prior to occupancy
38 of any units that were not initially counted as being occupied during the course of the work.

39 [~~§28-105.5.2~~] **§28-105.5.3 Owner statement.** All applications for permits shall include a
40 certification by the owner of the property for which the permit is sought stating the following:

- 1 1. A statement as to whether \$25,000 or more in covered arrears, that are not currently in
2 the appeals process, are owed to the city with respect to such property;
- 3 2. A statement as to whether the owners of the property owe, in aggregate, \$25,000 or
4 more in covered arrears to the city;
- 5 3. For each owner of the property:
 - 6 3.1. The person’s full name and business address;
 - 7 3.2. A list of properties in the city for which the person owes covered arrears to the
8 city and, for each such property, the amount of such covered arrears owed; and
 - 9 3.3. A list of properties in the city for which the person is an owner;
- 10 4. If an exception to section [~~28-105.1.2~~] 28-105.1.6 [~~of the code~~] applies to such owner,
11 a description of such exception.

12 ~~§28-105.5.2.1~~ **§28-105.5.3.1 Audit.** The commissioner shall each year, in consultation
13 with the department of finance and each other appropriate city agency, audit at least 25
14 percent of the statements submitted under section [~~28-105.5.2~~] 28-105.5.3 [~~of the code~~].

15 **§28-105.6 Fees.** Applications for permits shall be accompanied by the payment of appropriate fees
16 as provided for in article 112.

17 **§28-105.7 Time limitation of applications.** An application for a permit shall be deemed to have
18 been abandoned 12 months after the date of its submission, unless such application has been
19 diligently prosecuted after rejection in whole or in part, or a permit shall have been issued except
20 that the commissioner may, for reasonable cause, and upon payment of all reinstatement fees as
21 provided for in this code, grant extensions of time for additional 12-month periods.

22 **§28-105.8 Validity of permit.** The issuance or granting of a permit shall not be construed to be a
23 permit for, or an approval of, any violation of any of the provisions of this code or of any other law
24 or rule. Permits presuming to give authority to violate or cancel the provisions of this code or other
25 law or rule shall not be valid. The issuance of a permit based on construction documents and other
26 data shall not prevent the commissioner from requiring the correction of errors in the construction
27 documents and other data. The commissioner is authorized to prevent any occupancy, use or work
28 in violation of this code, the zoning resolution or other law or rule enforced by the department.

29 **§28-105.8.1 Duration of permit.** Permits may be issued for a period of up to two years unless
30 otherwise limited by law.

31 **§28-105.8.2 Signature of commissioner on permit.** Every permit issued by the commissioner
32 shall have his or her signature affixed thereto; but the commissioner may authorize any
33 subordinate to affix such signature, including by the use of electronic means.

34 **§28-105.9 Expiration.** All permits issued by the commissioner shall expire by limitation and become
35 invalid if the permitted work or use is not commenced within 12 months from the date of issuance
36 of the permit. Subsequent to the 12-month period following the issuance of the initial permit, all
37 permits shall expire if the permitted work is suspended or abandoned for a continuous period of 12
38 months unless such permits expire earlier pursuant to applicable provisions of this code. The permit
39 shall automatically expire upon the expiration of required insurance or, if the applicant holds a

1 license issued by the department, upon the expiration or revocation of such license during the term
2 of the permit or if the permit is not renewed.

3 **Exception:** All permits for work in [~~an area of special~~] a flood hazard area shall [~~comply with~~
4 expire in accordance with the timeframes established by section G104 of appendix G of the New
5 York city building code.

6 **§28-105.9.1 Reinstatement.** The commissioner may at any time reinstate a work permit solely
7 for the purpose of sign-off, including the correction of defects noted in a final inspection as
8 provided in section 28-116.2.4[~~of this code~~] or reinstate a work permit within a period of two
9 years from the date of issuance of the original permit. Except in the case of a permit reinstated
10 solely for the purpose of sign-off, the work shall comply with all the requirements of this code
11 and other applicable laws and rules in effect at the time application for reinstatement is made. The
12 applicant for reinstatement shall pay all reinstatement fees as required by article 112.

13 **§28-105.10 Suspension or revocation of permit.** The commissioner is authorized to suspend or
14 revoke a permit issued under the provisions of this code.

15 **§28-105.10.1 Notice of proposed revocation.** The commissioner may, on written notice to the
16 permit holder, revoke any permit for failure to comply with the provisions of this code or other
17 applicable laws or rules; or whenever there has been any false statement or any misrepresentation
18 as to a material fact in the application or submittal documents upon the basis of which such
19 approval was issued; or whenever a permit has been issued in error and conditions are such that
20 the permit should not have been issued. Such notice may be accompanied by a stop work order
21 pursuant to section 28-207.2[~~of this code~~] and shall inform the permit holder of the reasons for
22 the proposed revocation and that the applicant has the right to present to the commissioner or his
23 or her representative within 10 business days of delivery of the notice by hand or electronic
24 delivery or 15 [~~calendar~~] business days of the posting of notice by mail, information as to why
25 the permit should not be revoked.

26 **§28-105.10.2 Immediate suspension in cases of imminent peril.** The commissioner may
27 immediately suspend any permit without prior notice to the permit holder when the commissioner
28 has determined that an imminent peril to life or property exists. The commissioner shall forthwith
29 notify the permit holder that the permit has been suspended and the reasons [~~therefore~~] therefor,
30 that it is proposed to be revoked, and that the permit holder has the right to present to the
31 commissioner or his or her representative within 10 business days of delivery of the notice by
32 hand or electronic delivery or 15 [~~calendar~~] business days of the posting of notice by mail
33 information as to why the permit should not be revoked.

34 **§28-105.11 Posting of permit.** The building permit or a copy thereof shall be posted in a conspicuous
35 place at the work site, visible to the public for the duration of the work, or the use and operation of
36 the equipment, or until the expiration of the permit. No such permit shall be posted or displayed at
37 any location other than the location of the premises or equipment for which the permit was issued.
38 Where the permit is exposed to the weather, it shall be laminated or encased in a plastic covering to
39 protect it from the elements. The permit shall identify whether any dwelling unit within such building
40 will be occupied during the work. If dwelling units within such building will be occupied during the
41 work, the permit shall indicate the total number of dwelling units that will be occupied.

1 **Exception:** Where a project information panel is required by section 3301.9.1, of the New York
2 city building code, the permit shall be posted in accordance with such section, and no other
3 permits shall be posted in any location readily visible to the public, except as provided in section
4 3301.9.5 of the New York city building code.

5 **§28-105.12 Conditions of permit.** Permits shall be subject to the following conditions:

6 **§28-105.12.1 Compliance with code.** Permits shall be deemed to incorporate the provisions that
7 the applicant, the owner, their agents, employees, and contractors shall carry out the permitted
8 work in accordance with the provisions of this code and other applicable laws or rules, whether
9 specified or not, except as variations have been legally permitted or authorized.

10 **§28-105.12.2 Compliance with construction and submittal documents.** All work shall
11 conform to the approved construction and submittal documents, and any approved amendments
12 thereto. Changes and revisions during the course of construction shall conform to the amendment
13 requirements of this code.

14 **§28-105.12.2.1 Construction documents maintained on site.** One set of current “approved”
15 or “accepted” construction documents shall be retained by the department and another set
16 shall be maintained at the project site no later than the commencement of the work and until
17 the work authorized by the permit is completed and signed off by the department.

18 **Exception:** Construction documents filed in connection with the issuance of a temporary
19 construction installation permit shall be maintained at the site until such temporary
20 construction installation is removed.

21 **§28-105.12.3 Adherence to lot diagram.** All work shall be strictly located in accordance with
22 the lot diagram approved in accordance with this code and no lot or plot shall be changed,
23 increased or diminished in area from that shown on the approved lot diagram, unless and until a
24 revised diagram showing such changes, accompanied by the necessary statement of the owner
25 or applicant, shall have been submitted to and approved by the commissioner.

26 **§28-105.12.4 Compliance with safety requirements.** All work shall be conducted in accordance
27 with and subject to the safety requirements of this code and other applicable laws or rules,
28 including any order or requirement of the commissioner that the building or structure under
29 construction or alteration be vacated, in whole or in part, during the progress of the work and
30 until the issuance of a certificate of occupancy. Adjoining lots and properties shall be protected
31 in accordance with this code.

32 **§28-105.12.5 Compliance with noise control code required.** All work shall be performed in
33 compliance with the provisions of the New York city noise control code as set forth in chapter 2
34 of title 24 of the administrative code. Failure to comply with sections 24-222 and 24-223 of the
35 administrative code shall be a violation of this code.

36 **§28-105.12.6 Deferred submittals.** Where permits are issued subject to deferred submittal of
37 portions of the design as provided for in section 28-104.2.6, the deferred submittal items shall
38 not be installed until the construction and submittal documents for such portions have been
39 approved by the department and, where applicable, new or amended permits have been issued.

1 **§28-105.12.7 Insurance.** Where workers compensation, employee disability or liability
2 insurance is required by law or department rule, the applicant for the work permit shall obtain
3 and include proof of such insurance with the work permit application. The permit shall expire by
4 operation of law if the insurance upon which the permit was conditioned lapses, expires or is
5 cancelled, unless the permit holder files proof of alternate insurance before such event.

6 **§28-105.12.7.1 Insurance coverage for adjacent properties.** A person who obtains a permit
7 for construction or demolition operations shall, at such person's own expense, procure and
8 maintain for the duration of the operations, insurance of a kind and in an amount specified
9 by rule of the department, to insure any and all adjacent property owners and their lawful
10 occupants fully for all risks of loss, damage to property or injury to or death of persons,
11 arising out of or in connection with the performance of the proposed work. Such person shall
12 submit proof of insurance to the department when applying for a permit for construction or
13 demolition work. The department shall provide such proof of such insurance together with
14 the permit to the owners of adjoining property [~~thirty~~] 30 days prior to the commencement
15 of the construction or demolition work, except in the event that emergency work is authorized
16 as defined in section 28-105.4.1 of this code. If such emergency work is necessary, the permit
17 and proof of insurance shall be provided to owners of adjoining property within a reasonable
18 timeframe.

19 **§28-105.12.8 Site safety plan.** Where a site safety plan is required by this code or by the
20 department, all work shall adhere to the site safety plan. Site safety plans shall require approval
21 of the department where specified in this code or the New York city building code.

22 **§28-105.12.9 Safety training required.** No permit for construction or demolition work for
23 which training is required by section 3321 of the New York city building code shall be issued or
24 renewed until the applicant has certified that all workers who will be working under such permit
25 will have the requisite training throughout the duration of such permit.

26 **§28-105.12.10 Tenant protection plan required.** Where a tenant protection plan is required by
27 article 120, all work shall adhere to the tenant protection plan.

28 **§28-105.12.11 Inspections.** Upon issuance of a permit and at any time during such permit period,
29 the commissioner or his or her authorized representatives, in the discharge of their duties, shall
30 have the right to enter, in accordance with applicable law, upon any buildings, enclosures,
31 premises, or any part thereof, or attached thereto for the purposes of an inspection of work
32 pursuant to such permit to ensure that such work is not occurring in an unsafe or dangerous
33 manner, and that such work is being performed in compliance with applicable code provisions.
34 If the commissioner or his or her authorized representative is unable to gain access to such
35 property expeditiously for the purposes of an inspection of work pursuant to such permit and
36 there is a reason to believe that the work is being done in violation of the law, the commissioner
37 shall issue a stop work order. Such stop work order may be rescinded in accordance with section
38 28-207.2.3.

1 **ARTICLE 106**
2 **ASBESTOS**

3 **§28-106.1 Asbestos certification required.** The commissioner shall not issue a permit for the
4 demolition or alteration of a building constructed pursuant to plans submitted for approval on or
5 before April 1, 1987, unless the applicant submits such certification relating to asbestos as may be
6 required by the rules of the New York city department of environmental protection or the
7 commissioner of environmental protection has issued a variance.

8 **§28-106.1.1 Full demolition permit.** The commissioner shall not issue a full demolition permit
9 unless the owner of the building provides certification in a form and manner to be provided in
10 the rules of the department of environmental protection that (i) the building is free of asbestos
11 containing material, or (ii) the commissioner of environmental protection, has issued a variance
12 from this requirement in accordance with subdivision (m) of section 24-136 of the administrative
13 code and the rules of the department of environmental protection, subject to the requirement that
14 demolition work will be performed only in parts of the building that are certified free of asbestos
15 containing material. The full demolition permit shall be subject to such additional conditions as
16 the department of buildings may require of the permittee based on the size and complexity of the
17 demolition work.

18 **Exception:** This section [~~28-106.1.1~~] shall not apply to full demolition performed as
19 emergency work pursuant to article 215 of chapter 2 of this title where the emergency
20 warrants immediate commencement of the work or full demolition with asbestos in place
21 authorized pursuant to 12 NYCRR 56-11.5.

22 **§28-106.1.2 Alteration permit for the removal of one or more stories.** The commissioner shall
23 not issue an alteration permit for the removal of one or more stories of a building unless the
24 owner of the building provides certification in a form and manner to be provided in the rules of
25 the department of environmental protection that (i) the stories to be removed are free of asbestos
26 containing material and that no abatement activities will be performed anywhere in the building
27 concurrently with the removal work authorized by such permit or (ii) the commissioner of
28 environmental protection has issued a variance from these requirements in accordance with
29 subdivision (m) of section 24-136 of the administrative code and the rules of the department of
30 environmental protection, subject to the requirement that work authorized by the alteration
31 permit will be performed only in parts of the building that are certified free of asbestos containing
32 material. The alteration permit shall be subject to such additional conditions as the department
33 of buildings may require of the permittee based on the size and complexity of the work.

34 **Exception:** [~~This~~] [~~section~~] Section 28-106.1.2 shall not apply to removal of one or more
35 stories performed as emergency work pursuant to article 215 of chapter 2 of this title where
36 the emergency warrants immediate commencement of the work.

37 **§28-106.2 Construction and maintenance of asbestos containment structures and other**
38 **temporary structures or work required for asbestos abatement activities.** Notwithstanding any
39 other provision of this code, the construction and maintenance of asbestos containment structures,
40 decontamination system enclosures and other temporary structures or work performed in the course
41 of and only for the purpose of asbestos abatement activities shall comply with this section and the
42 rules of the New York city department of environmental protection relating to such temporary

1 structures and work and with article 30 of the New York state labor law and rules adopted pursuant
2 to such article.

3 **§28-106.2.1 Materials.** The rules of the New York city department of environmental protection
4 relating to materials used in the construction of temporary structures for asbestos abatement
5 activities shall contain a provision requiring such structures to be non-combustible or flame
6 resistant in compliance with reference standard NFPA 255-06 or NFPA 701-99, as such
7 standards may be modified by local law or by the department of buildings pursuant to applicable
8 rules.

9 **§28-106.3 Permit exemption.** Except as otherwise provided by rule, work performed in the course
10 of and only for the purpose of an asbestos project that is required to be permitted pursuant to section
11 24-138 of the administrative code shall be exempt from the permit requirements of this code.

12 **§28-106.4 Definitions.** For the purposes of this article, the terms "asbestos" and "asbestos project"
13 shall have the meanings as are ascribed in section 24-136 of the administrative code.

14 **ARTICLE 107**
15 **ALTERATION OR DEMOLITION OF SINGLE ROOM**
16 **OCCUPANCY MULTIPLE DWELLINGS**

17 **§28-107.1 General.** The commissioner shall not approve construction documents, nor issue an initial
18 or reinstated permit in connection therewith, for the alteration or demolition of a single room
19 occupancy multiple dwelling except as set forth in this article. Applications for post approval
20 amendments to construction documents are subject to this article where the application proposes a
21 change within a covered category of work as set forth in section 28-107.3.

22 **§28-107.2 Definitions.** The following words and terms shall, for the purposes of this article and
23 elsewhere in the code, have the meanings shown herein.

24 **CLASS A MULTIPLE DWELLING, CLASS B MULTIPLE DWELLING, FURNISHED**
25 **ROOM HOUSE, ROOMING UNIT AND SINGLE ROOM OCCUPANCY.** Shall have the
26 meanings set forth in section 27-2004 of the New York city housing maintenance code.

27 **SINGLE ROOM OCCUPANCY MULTIPLE DWELLING.** A single room occupancy multiple
28 dwelling means:

- 29 1. A "class A multiple dwelling" used in whole or part as a "rooming house" or "furnished room
30 house," or for "single room occupancy" pursuant to section 248 of the New York state
31 multiple dwelling law;
- 32 2. A "class A multiple dwelling" containing "rooming units"; or
- 33 3. A "class B multiple dwelling."

34 **Exception:** The term single room occupancy multiple dwelling shall not include:

- 35 1. College or school dormitories;
- 36 2. Clubhouses;

- 1 3. Luxury hotels, as such term is defined by the commissioner of housing preservation and
2 development; or
- 3 4. Residences whose occupancy is restricted to an institutional use such as housing intended
4 for use by the employees of a single company or institution;
- 5 5. City-owned multiple dwellings; or
- 6 6. Any multiple dwelling, other than a lodging house, containing fewer than nine sleeping
7 rooms, rooming units, single room occupancy units, or hotel units unless the total number
8 of such units is more than fifty percent of the total number of dwelling units in such
9 multiple dwelling; or
- 10 7. Any multiple dwelling that:
 - 11 7.1. Is the subject of a program approved by the commissioner of housing preservation
12 and development and related to the rehabilitation or preservation of a single room
13 occupancy multiple dwelling or the provision of housing for persons of low or
14 moderate income, other than a program consisting solely of real property tax
15 abatement or tax exemption; and
 - 16 7.2. Has been exempted from the provisions of this article by the commissioner of
17 housing preservation and development.
- 18 8. Any building erected after May 5, 1983.
- 19 9. Any building lawfully altered pursuant to the provisions of this article after May 5, 1983,
20 such that the building no longer meets the definition of single room occupancy multiple
21 dwelling.

22 **§28-107.3 Covered categories of work.** Applications for the approval of construction documents
23 for the following categories of work are covered by this article:

- 24 1. Demolition of a single room occupancy multiple dwelling;
- 25 2. Alteration of a single room occupancy multiple dwelling to a class A multiple dwelling to be
26 used in whole or in part for other than single room occupancy purposes;
- 27 3. Alteration of a single room occupancy multiple dwelling resulting in the removal or addition
28 of kitchen or bathroom facilities; and
- 29 4. Such other types of alteration work to a single room occupancy multiple dwelling as shall be
30 prescribed by rule of the commissioner of housing preservation and development, in
31 consultation with the commissioner.

32 **Exceptions:**

- 33 1. Work solely for the purpose of either (i) making the public areas of a multiple dwelling
34 accessible to persons with disabilities without altering the configuration of any dwelling
35 unit or rooming unit or (ii) making the interior or the entrance to a dwelling unit or a
36 rooming unit accessible to persons with disabilities shall not be covered by this article.
- 37 2. Repairs, demolition or any other work performed by a city agency or by a contractor
38 pursuant to a contract with a city agency shall not be covered by this article.

1 **§28-107.4 Required submittal documents.** The commissioner shall not approve any construction
2 documents, nor issue an initial or reinstated permit in connection therewith, for a single room
3 occupancy multiple dwelling for the covered categories of work unless the applicant provides:

- 4 1. A sworn affidavit by or on behalf of all the owners, as the term owner is defined in section
5 27-2004 of the New York city housing maintenance code, of such multiple dwelling that
6 there will be no harassment of the lawful occupants of such multiple dwelling by or on behalf
7 of such owners during the construction period;
- 8 2. A tenant protection plan as provided for in this code; and
- 9 3. One of the following documents from the commissioner of housing preservation and
10 development:
 - 11 3.1. A current certification that there has been no harassment of the lawful occupants of
12 such multiple dwelling within the 36 month period prior to submission of an application
13 for such certification to the department of housing preservation and development,
14 provided, however, that such certification shall except any portion of such 36 month
15 period during which title was vested in the city; or
 - 16 3.2. A waiver of such certification.

17 **§28-107.5 Filing process.** Applications for a certification of no harassment shall be made pursuant
18 to section 27-2093 of the New York city housing maintenance code.

19 **§28-107.6 Time period for acceptance or rejection.** The time period in which the commissioner is
20 required to approve or reject an application for construction document approval or resubmission
21 thereof pursuant to this code shall commence from the date that the commissioner receives either the
22 certification or waiver pursuant to this article.

23 **§28-107.7 Denial of certification.** Where the commissioner of housing preservation and
24 development denies the certification required by this article, the commissioner shall reject the
25 application for construction document approval.

26 **§28-107.8 Request for stop-work or rescission.** The commissioner shall be empowered to issue a
27 stop-work notice or order with respect to an alteration or demolition permit and/or to rescind
28 approval of construction documents at the request of the commissioner of housing preservation and
29 development pursuant to section 27-2093 of the New York city housing maintenance code.

30 **§28-107.9 Effect of denial or rescission.** Where the commissioner rejects or rescinds the approval
31 of construction documents pursuant to this article, no further application for the covered categories
32 of work shall be considered by the commissioner for a period of 36 months following the date of the
33 denial of the certification of no harassment by the commissioner of housing preservation and
34 development or the date of the rescission of such certification of no harassment by such
35 commissioner.

36 **ARTICLE 108**
37 **PAVEMENT PLAN**

38 **§28-108.1 General.** The commissioner shall not issue a permit for the erection of a new building,
39 use of an open lot or for alterations that will require the issuance of a new or amended certificate of

1 occupancy without a statement that no certificate of occupancy shall be issued unless the sidewalk,
2 curb and/or roadway in front of or abutting such building, including but not limited to the intersection
3 quadrants for corner properties, shall have been paved, ~~[or]~~ repaired or installed by the owner, at his
4 or her own cost, in the manner, of the materials, and in accordance with the ~~[standard specifications]~~
5 New York city building code, the New York city zoning resolution, and the standards prescribed by
6 the New York city department of transportation pursuant to sections 19-113 and 19-115 of the
7 administrative code.

8 **Exceptions:**

- 9 1. Application for the erection of an accessory building appurtenant to an existing one- or
10 two-family dwelling.
- 11 2. Where the commissioner determines, in consultation with the commissioner of
12 transportation, that a sidewalk is not required, provided that such determination shall not
13 affect the obligations of the owner under subdivision a of section 19-152 of the
14 administrative code, nor relieve the owner of any such obligations, nor impair or diminish
15 the rights of the city or its agencies to enforce such obligations.
- 16 3. Where ~~[the extent of the change in use or occupancy, or]~~ the cost of the alteration,
17 including enlargements, does not exceed a total cost of 30 percent of the building value
18 ~~[threshold established pursuant to rule of the commissioner]~~.

19 **§28-108.2 Pavement plan required.** Construction documents shall include a pavement plan
20 processed and approved under guidelines established by the department. The pavement plan shall
21 include documentation sufficient to show compliance with the New York city building code, the
22 New York city zoning resolution, and the standards ~~[and specifications of]~~ prescribed by the New
23 York city department of transportation pursuant to sections 19-113 and 19-115 of the administrative
24 code.

25 **Exception:** No pavement plan shall be required with respect to an alteration application for a
26 building where the applicant certifies that there is a sidewalk in existence in front of or abutting
27 such building, including but not limited to the intersection quadrants for corner properties,
28 complying with the specifications of the New York city department of transportation, and that
29 the nature of such alteration work will neither remove such existing sidewalk nor cause damage
30 to such existing sidewalk such that the damage could not be corrected as minor repairs prior to
31 issuance of the certificate of occupancy.

32 **§28-108.3 Improvement of streets.** The commissioner shall insure that streets are suitably improved
33 in accordance with the standards ~~[and specifications of]~~ prescribed by the department of
34 transportation as required by subdivision ~~[two]~~ 2 of section ~~[thirty-six]~~ 36 of the New York state
35 general city law and shall otherwise carry out the provisions of such subdivision.

36 **ARTICLE 109**
37 **FIRE PROTECTION PLAN**

38 **§28-109.1 Fire protection plan required for covered buildings.** New building and alteration
39 applications for covered buildings as set forth in section 28-109.2 shall include a fire protection plan
40 prepared by or under the supervision of a registered design professional who shall professionally
41 certify such plan. Such plan shall be submitted for review and approval by the fire department for

1 compliance with this code prior to issuance of a certificate of occupancy, a temporary certificate of
2 occupancy or a letter of completion, as applicable. The fire protection plan shall be submitted in
3 accordance with the rules and regulations of the fire department.

4 **Exception:** No fire protection plan shall be required for an alteration that meets all three of the
5 following requirements:

- 6 1. The alteration does not involve a change of use or occupancy;
- 7 2. The alteration does not exceed [~~one million dollars~~] \$1,000,000; and
- 8 3. The alteration does not create an inconsistency with a previously approved fire protection
9 plan.

10 **§28-109.2 Covered buildings.** Covered buildings include:

- 11 1. High-rise buildings as described in section 403 of the New York city building code.
- 12 2. Occupancy groups B, E, F, H, M_[7] or S occupying two or more stories with over 20,000
13 gross square feet (1858 m²) of floor area per floor, or occupying two or more stories in a
14 building with a total floor area exceeding 50,000 gross square feet (4645 m²).
- 15 3. Any building containing an assembly occupancy having an occupant load of 300 or more
16 persons.
- 17 4. Occupancy group I or R-1 occupying two or more stories and containing sleeping
18 accommodations for 30 or more persons.
- 19 5. Occupancy group R-2 occupancies containing 30 or more dwelling units in a building where
20 over 10,000 gross square feet (929 m²) of floor area is occupied by occupancy group A, E,
21 M_[7] or I.
- 22 6. Covered mall buildings and open mall buildings designed pursuant to section 402 of the New
23 York city building code.

24 **§28-109.3 Scope.** The plan shall include the following information, where applicable:

- 25 1. A description of the building including: address; block and lot numbers; number of stories;
26 height in feet; occupancy group; construction classification; occupancy load and department
27 of buildings application number;
- 28 2. All floors, exits, doors, corridors, and partitions serving as fire barriers, fire partitions, fire
29 walls; locations and ratings of required enclosures and fire areas; stairs with pressurization;
30 roof access; exit discharges; and locations of any required frontage space; and
- 31 3. In narrative form, a description of safety systems and features, including:
 - 32 3.1. Communications systems.
 - 33 3.2. Alarm systems.
 - 34 3.3. Smoke and carbon monoxide detection equipment.
 - 35 3.4. Location of fire command station.
 - 36 3.5. Elevator recall.

- 1 3.6. Emergency lighting and power.
- 2 3.7. Standpipes.
- 3 3.8. Sprinklers.
- 4 3.9. Emergency and standby power systems.
- 5 3.10. Mechanical ventilation and air conditioning.
- 6 3.11. Smoke control systems and equipment.
- 7 3.12. Furnishings types and materials.
- 8 3.13. Places of assembly.
- 9 3.14. Fire department access.
- 10 3.15. Photoluminescent pathway markings.
- 11 3.16. Other safety related systems, required and voluntary, to be installed.

ARTICLE 110
SITE SAFETY PLAN

14 ~~§28-110.1 Site safety plan. Where a site safety plan is required by chapter 33 of the New York city~~
15 ~~building code, such plan shall include the following:]~~

- 16 ~~[1.—Location of all construction fences around work site;]~~
- 17 ~~[2.—Location of all gates in construction fences;]~~
- 18 ~~[3.—Location of standard guardrails around excavations, when required;]~~
- 19 ~~[4.—Horizontal and vertical netting program, including details of the initial installation,~~
20 ~~schedule of horizontal jumps and vertical installations, and designated crane and derrick~~
21 ~~lifting areas where horizontal netting is omitted. The program shall include as an~~
22 ~~attachment any department approval obtained regarding required safety netting during~~
23 ~~construction or demolition operations; the revised site safety plan shall be approved;]~~
- 24 ~~[5.—Location of all sidewalk sheds, including appropriate department application numbers and~~
25 ~~department of transportation permit numbers and expiration dates;]~~
- 26 ~~[6.—Location of all temporary walkways, including appropriate department application~~
27 ~~numbers and department of transportation permit numbers and expiration dates;]~~
- 28 ~~[7.—Location of foot bridges and motor vehicle ramps, including appropriate department~~
29 ~~application numbers and department of transportation permit numbers and expiration~~
30 ~~dates;]~~
- 31 ~~[8.—Protection of side of excavation, when required, including appropriate department~~
32 ~~application numbers and department of transportation permit numbers and expiration~~
33 ~~dates;]~~
- 34 ~~[9.—Location of all street and sidewalk closing(s), including appropriate department application~~
35 ~~numbers and department of transportation permit numbers and expiration dates;]~~

- 1 ~~[10. Approximate location of material and personnel hoist(s) and loading areas, including~~
2 ~~appropriate department application numbers and department of transportation permit~~
3 ~~numbers and expiration dates;]~~
- 4 ~~[11. Approximate location of all crane and derrick loading areas;]~~
- 5 ~~[12. Location of all surrounding buildings, indicating occupancy, height and type of any~~
6 ~~required roof protection;]~~
- 7 ~~[13. Location of all standpipe system and siamese hose connections;]~~
- 8 ~~[14. Location of all temporary elevators for fire department use when building is above 75 feet~~
9 ~~(22 860 mm) in height;]~~
- 10 ~~[15. Location of all exterior contractors' sheds;]~~
- 11 ~~[16. All required safety netting and scaffolding;]~~
- 12 ~~[17. Widths of all sidewalks and roadways; all traffic information; all exits from the work site;]~~
- 13 ~~[18. A copy of the proposed site safety manager or site safety coordinator's certificate, as~~
14 ~~applicable, including the certificate for any alternate site safety manager or site safety~~
15 ~~coordinator;]~~
- 16 ~~[19. Such features requiring special sequencing in order to maintain safe conditions with a~~
17 ~~written description of those sequences;]~~
- 18 ~~[20. A statement that prior to performing any work on the project all workers have successfully~~
19 ~~completed the training required by section 3310.10.2 of the New York city building code;~~
20 ~~and]~~
- 21 ~~[21. A statement that all workers employed on the construction site will receive a site specific~~
22 ~~orientation program required by section 3310.10.1 of the New York city building code.]~~

23 **§28-110.1 Site safety plan.** Where a site safety plan is required by chapter 33 of the New York city
24 **building code, such plan shall include the following, as applicable:**

- 25 1. Site conditions and surrounding property, utilities and infrastructure;
- 26 2. Streets, sidewalks, pedestrian protection, fences, gates and pedestrian and traffic control;
- 27 3. Adjoining property protection, including but not limited to roof protection, yard protection
28 and window protection;
- 29 4. Unenclosed perimeter protection, including but not limited to netting systems, cocoon
30 systems and engineered enclosure systems;
- 31 5. Excavations, including but not limited to location of excavations, guardrails, protection of
32 sides of excavations or underpinning, and ladders, ramps and other means of egress from
33 the excavation;
- 34 6. Fire protection, including but not limited to location of hydrants, fire extinguishers,
35 standpipes and fire department hose connections;
- 36 7. Temporary construction installations and equipment, including but not limited to scaffolds,
37 runback structures, material hoists, personnel hoists, hoisting machines, cranes, derricks,

1 mast climbers, excavators, earth movers, drill rigs, concrete pumpers, chutes, contractor
2 sheds or offices and portable sanitation;

3 8. Means of egress from the jobsite, both permanent and temporary;

4 9. Location of security guard and watchperson stations;

5 10. Means of securing controlled access zones;

6 11. Debris and material storage areas/loading zones;

7 12. Material handling plan for crane operations if crane operations come into conflict with hoist
8 operations;

9 13. In occupied buildings, means and methods employed to protect all tenants from the adverse
10 effect of construction operations;

11 14. For work related to the alteration, maintenance, or repair of a façade, means and methods
12 of getting material and debris to and from the work area. Means to separate debris and
13 materials from occupants of the building must be indicated;

14 15. For work related to the alteration, maintenance, or repair of a façade, means and methods,
15 including ladders, used by workers to access scaffolds, sidewalk sheds and the work area;

16 16. Features requiring special sequencing in order to maintain safe conditions, with a written
17 description of those sequences;

18 17. A note indicating that prior to performing any work on the project all workers must
19 successfully complete the training required by section 3321 of the New York city building
20 code; and

21 18. A note indicating that all workers employed on the construction site must receive a site-
22 specific orientation program as required by section 3301.11 of the New York city building
23 code.

24 **§28-110.2 Phased site safety plans.** Multiple layouts of the site safety features enumerated in section
25 28-110.1 may be submitted at any time during construction operations to show phased site safety
26 designs consistent with the phase of anticipated work.

27 **ARTICLE 111**
28 **TEMPORARY STRUCTURES AND USES**

29 **§28-111.1 General.** The erection of certain temporary structures and temporary uses may be
30 authorized as set forth in sections 28-111.1.1 and 28-111.1.2.

31 **§28-111.1.1 Permits for the erection and use of temporary structures.** The commissioner is
32 authorized to issue a permit for the erection of temporary structures including but not limited to
33 tents, grandstands, platforms, reviewing stands, outdoor bandstands, stages and similar
34 miscellaneous structures and equipment, and for the temporary use of such structures. Such
35 permits shall be limited as to time of service or use, but in no event shall be permitted for more
36 than 90 days. The commissioner may grant extensions for demonstrated cause.

37 **Exception:** No permit shall be required for:

1 which inures to the benefit of any private shareholder or individual, and provided that the
2 property affected is to be used exclusively by such corporation or association for one or
3 more of such purposes.

- 4 2. A permit, inspection or other service or privilege as regulated in this code shall not be
5 subject to this provision if the work proposed is emergency work performed by a city
6 agency or by a contractor pursuant to a contract with a city agency.

7 **§28-112.2 Schedule of permit fees.** Permits for new buildings, structures, mechanical, and plumbing
8 systems or alterations requiring a permit shall be accompanied by a fee for each permit in accordance
9 with the fee schedule of Table 28-112.2. Fifty percent of the total fee for the work permit, but not
10 less than [~~one hundred dollars~~] \$100, or the total fee for the work permit where such fee is less than
11 [~~one hundred dollars~~] \$100, shall be paid and shall accompany the first application for the approval
12 of construction documents; and the whole or remainder of the total fee shall be paid before the work
13 permit may be issued. The commissioner may require reasonable substantiation of any statement or
14 other form that may be required by the department.

TABLE 28-112.2

PERMIT TYPE	FILING FEE	RENEWAL FEE	COMMENTS
New Buildings			
<p>New building work permit: One-, two- or three-family dwelling, where no existing building elements are to be retained in place as part of the new building.</p> <ul style="list-style-type: none"> Subsequent applications related to initial new building work permit application, filed prior to the first temporary certificate of occupancy (TCO), or the final certificate of occupancy if no TCO is issued. 	<p>\$0.06 for each square foot, or fraction thereof, of the total floor area of the new building, but not less than [\$100] <u>\$130</u> for each structure.</p> <p>The rates and fees set forth above shall be subject to increases as provided by department rules.</p> <p>[\$100] <u>\$130</u></p>	<p>[\$100] <u>\$130 per work type</u></p> <p>[\$100] <u>\$130 per work type</u></p>	<p>For the purposes of this fee schedule item, “building elements” means any portion of an existing building or structure, including but not limited to party walls, foundations, footings, piles and slabs on grade.</p>
<p>New building work permit: One-, two- or three-family dwelling, where any existing building elements are to be retained in place as part of the new building, pursuant to section 28-101.4.5.</p>	<p>Minimum Filing Fee – [\$100] <u>\$130</u></p> <p>Minimum filing fee for the first [five thousand dollars] <u>\$5,000</u> or fraction thereof, of the cost of alteration; plus \$2.60 for each [one thousand dollars] <u>\$1,000</u>, or fraction thereof, of cost of alterations in excess of [five thousand dollars] <u>\$5,000</u>.</p> <p>The rates and fees set forth above shall be subject to increases as provided by department rules.</p>	<p>[\$100] <u>\$130 per work type</u></p>	<p>For the purposes of this fee schedule item, “building elements” means any portion of an existing building or structure, including but not limited to party walls, foundations, footings, piles and slabs on grade.</p>
<p>New building work permit: Garage for not more than three cars when accessory to and filed with plans for one, two- or three-family dwelling to which it is accessory on the same lot.</p>	<p>[\$100] <u>\$130</u></p>	<p>[\$100] <u>\$130 per work type</u></p>	

TABLE 28-112.2

PERMIT TYPE	FILING FEE	RENEWAL FEE	COMMENTS
<p>New building work permit: All other new buildings fewer than 7 stories and less than 100,000 square feet, where no existing building elements are to be retained in place as part of the new building.</p> <ul style="list-style-type: none"> Subsequent applications related to initial new building work permit application, filed prior to the first temporary certificate of occupancy (TCO), or the final certificate of occupancy if no TCO is issued. 	<p>\$0.26 for each square foot, or fraction thereof, of the total floor area of the new building, but not less than \$280 for each structure.</p> <p>The rates and fees set forth above shall be subject to increases as provided by department rules.</p> <p>[\$100] <u>\$130</u></p>	<p>[\$100] <u>\$130 per work type</u></p> <p>[\$100] <u>\$130 per work type</u></p>	<p>For the purposes of this fee schedule item, “building elements” means any portion of an existing building or structure, including but not limited to party walls, foundations, footings, piles and slabs on grade.</p>
<p>New building work permit: All other new buildings fewer than 7 stories and less than 100,000 square feet, where any existing building elements are to be retained in place as part of the new building, pursuant to section 28-101.4.5.</p>	<p>Minimum Filing Fee - \$280</p> <p>Minimum filing fee for the first [three thousand dollars] <u>\$3,000</u>, or fraction thereof, of the cost of alteration; plus \$10.30 for each [one thousand dollars] <u>\$1,000</u>, or fraction thereof, of the alteration cost in excess of [three thousand dollars] <u>\$3,000</u>.</p> <p>The rates and fees set forth above shall be subject to increases as provided by department rules.</p>	<p>[\$100] <u>\$130 per work type</u></p>	<p>For the purposes of this fee schedule item, “building elements” means any portion of an existing building or structure, including but not limited to party walls, foundations, footings, piles and slabs on grade.</p>

TABLE 28-112.2

PERMIT TYPE	FILING FEE	RENEWAL FEE	COMMENTS
<p>New building work permit: All other new buildings 7 stories or more or 100,000 square feet or more, classified in occupancy group R-2, where at least 50 percent of the occupancy units are affordable to households whose income is less than 165 percent of the area median income for New York city, as determined by the United States department of housing and urban development or successor agency, which are financed entirely or in part by a grant or loan from the city of New York or the New York city housing and development corporation, and where no existing building elements are to be retained in place as part of the new building.</p> <ul style="list-style-type: none"> Subsequent applications related to initial new building work permit application, filed prior to the first temporary certificate of occupancy (TCO), or the final certificate of occupancy if no TCO is issued 	<p>\$0.26 for each square foot, or fraction thereof, of the total floor area of the new building, but not less than [\$100] <u>\$130</u> for each structure,</p> <p>The rates and fees set forth above shall be subject to increases as provided by department rules.</p> <p>[\$100] <u>\$130</u></p>	<p>[\$100] <u>\$130 per work type</u></p> <p>[\$100] <u>\$130 per work type</u></p>	<p>For the purposes of this fee schedule item, "building elements" means any portion of an existing building or structure, including but not limited to party walls, foundations, footings, piles and slabs on grade.</p>
<p>New building work permit: All other new buildings 7 stories or more 100,000 square feet or more, classified in occupancy group R-2, where at least 50 percent of the occupancy units are affordable to households whose income is less than 165 percent of the area</p>	<p>Minimum Filing Fee - \$280</p> <p>Minimum filing fee for the first \$3,000 or fraction thereof, of the cost of alteration; plus \$10.30 for each [one thousand dollars] <u>\$1,000</u>, or fraction thereof, of the alteration cost in excess of [three thousand dollars] <u>\$3,000</u>.</p>	<p>[\$100] <u>\$130 per work type</u></p>	<p>For the purposes of this fee schedule item, "building elements" means any portion of an existing building or structure, including but not limited to party</p>

TABLE 28-112.2

PERMIT TYPE	FILING FEE	RENEWAL FEE	COMMENTS
<p>median income for New York city, as determined by the United States department of housing and urban development or successor agency, which are financed entirely or in part by a grant or loan from the city of New York or the New York city housing and development corporation, and where any existing building elements are to be retained in place as part of the new building, pursuant to section 28-101.4.5.</p>	<p>The rates and fees set forth above shall be subject to increases as provided by department rules.</p>		<p>walls, foundations, footings, piles and slabs on grade.</p>
<p>New building work permit: All other new buildings 7 stories or more, or 100,000 square feet or more, where no existing building elements are to be retained in place as part of the new building.</p>	<p>\$0.45 for each square foot, or fraction thereof, of the total floor area of the new building, but not less than \$290 for each structure.</p> <p>The rates and fees set forth above shall be subject to increases as provided by department rules.</p>	<p>[\$100] \$130 per work type</p>	<p>For the purposes of this fee schedule item, "building elements" means any portion of an existing building or structure, including but not limited to party walls,</p>
<ul style="list-style-type: none"> Subsequent applications related to initial new building work permit application, filed prior to the first temporary certificate of occupancy (TCO), or the final certificate of occupancy if no TCO is issued 	<p>[\$100] \$130</p>	<p>[\$100] \$130 per work type</p>	<p>foundations, footings, piles and slabs on grade.</p>
<p>New building work permit: All other new buildings 7 stories or more, or 100,000 square feet or more, where any existing building elements are to be retained in place as part of the new building, pursuant to section 28-101.4.5.</p>	<p>Minimum Filing Fee - \$290</p> <p>Minimum filing fee for the first three thousand \$3,000, or fraction thereof, of the cost of alteration; plus \$17.75 for each one thousand dollars \$1,000, or fraction thereof, of the alteration cost in excess of</p>	<p>[\$100] \$130 per work type</p>	<p>For the purposes of this fee schedule item, "building elements" means any portion of an existing building or structure, including but not</p>

TABLE 28-112.2

PERMIT TYPE	FILING FEE	RENEWAL FEE	COMMENTS
	<p>[three thousand dollars] <u>\$3,000.</u></p> <p>The rates and fees set forth above shall be subject to increases as provided by department rules.</p>		<p>limited to party walls, foundations, footings, piles and slabs on grade.</p>
Alterations			
<p>Alteration work permit: One-, two- or three-family dwelling</p> <ul style="list-style-type: none"> • Alteration Type 1 • Alteration Type 2 • Alteration Type 3 • Limited Alteration Application 	<p>Minimum Filing Fee - \$170 Minimum Filing Fee - \$130 Minimum Filing Fee - \$130 Minimum Filing Fee - \$130</p> <p>Minimum filing fee for the first [five thousand dollars] <u>\$5,000</u>, or fraction thereof, of the cost of alteration; plus \$2.60 for each [one thousand dollars] <u>\$1,000</u>, or fraction thereof, of cost of alterations in excess of [five thousand dollars] <u>\$5,000</u>.</p> <p>The rates and fees set forth above shall be subject to increases as provided by department rules.</p>	<p>[\$100] <u>\$130 per work type</u></p>	
<p>Alteration work permit: Alterations in all other buildings and structures fewer than 7 stories and less than 100,000 square feet, including but not limited to aerial towers and masts, tank structures, fire escapes, etc., which are unoccupied and not easily valued by area.</p> <ul style="list-style-type: none"> • Alteration Type 1 • Alteration Type 2 	<p>Minimum Filing Fee - \$280 Minimum Filing Fee - \$225</p>	<p>[\$100] <u>\$130 per work type</u></p>	<p>Such alterations work shall include:</p> <ul style="list-style-type: none"> • Applications related to new building work permit application, filed after the first temporary certificate of

TABLE 28-112.2

PERMIT TYPE	FILING FEE	RENEWAL FEE	COMMENTS
<ul style="list-style-type: none"> • Alteration Type 3 • Limited Alteration Application 	<p>Minimum Filing Fee - \$195</p> <p>Minimum Filing Fee - \$195</p> <p>Minimum filing fee for the first [three thousand dollars] <u>\$3,000</u>, or fraction thereof, of the cost of alteration; plus \$10.30 for each [one thousand dollars] <u>\$1,000</u>, or fraction thereof, of the alteration cost in excess of [three thousand dollars] <u>\$3,000</u>.</p> <p>The rates and fees set forth above shall be subject to increases as provided by department rules.</p>		<p>occupancy (TCO), or the final certificate of occupancy if no TCO is issued.</p> <ul style="list-style-type: none"> • Installation or alteration of elevators, escalators, amusement devices and other devices regulated under this code, except those filed under a new building application.
<p>Alteration work permit: Alterations in all other buildings and structures 7 stories or more, or 100,000 square feet or more, classified in occupancy group R-2, which are unoccupied and not easily valued by area, where at least 50 percent of the occupancy units are affordable to households whose income is less than 165 percent of the area median income for New York city, as determined by the United States department of housing and urban development or successor agency, and which are financed entirely or in part by a grant or loan from the city of New York or the New</p>		<p>[\$100] <u>\$130 per work type</u></p>	<p>Such alterations work shall include:</p> <ul style="list-style-type: none"> • Applications related to new building work permit application, filed after the first temporary certificate of occupancy (TCO), or the final certificate of occupancy if no TCO is issued. • Installation or alteration

TABLE 28-112.2

PERMIT TYPE	FILING FEE	RENEWAL FEE	COMMENTS
<p>York city housing and development corporation.</p> <ul style="list-style-type: none"> • Alteration Type 1 • Alteration Type 2 • Alteration Type 3 • Limited Alteration Application 	<p>Minimum Filing Fee - \$280 Minimum Filing Fee - \$280 Minimum Filing Fee - \$195 Minimum Filing Fee - \$195</p> <p>Minimum filing fee for the first [three thousand dollars] <u>\$3,000</u>, or fraction thereof, of the cost of alteration; plus \$10.30 for each [one thousand dollars] <u>\$1,000</u>, or fraction thereof, of the alteration cost in excess of [three thousand dollars] <u>\$3,000</u>.</p> <p>The rates and fees set forth above shall be subject to increases as provided by department rules.</p>		<p>of elevators, escalators, amusement devices and other devices regulated under this code, except those filed under a new building application.</p>
<p>Alteration work permit: Alterations in all other buildings and structures 7 stories or more, or 100,000 square feet or more, including but not limited to aerial towers and masts, tank structures, fire escapes, etc., which are unoccupied and not easily valued by area.</p> <ul style="list-style-type: none"> • Alteration Type 1 • Subsequent or related filings 	<p>Minimum Filing Fee - \$290 Minimum Filing Fee - \$290</p> <p>Minimum filing fee for the first [three thousand dollars] <u>\$3,000</u>, or fraction thereof, of the cost of alteration; plus \$17.75 for each [one thousand dollars] <u>\$1,000</u>, or fraction thereof, of the alteration cost</p>	<p>[\$100] <u>\$130 per work type</u></p>	<p>Such alterations work shall include:</p> <ul style="list-style-type: none"> • Applications related to new building work permit application, filed after the first temporary certificate of occupancy (TCO), or the final certificate of occupancy if no TCO is issued. • Installation or alteration

TABLE 28-112.2

PERMIT TYPE	FILING FEE	RENEWAL FEE	COMMENTS
	<p>in excess of [three thousand dollars] <u>\$3,000</u>.</p> <p>The rates and fees set forth above shall be subject to increases as provided by department rules.</p>		<p>of elevators, escalators, amusement devices regulated under this code, except those filed under a new building application.</p>
<p>Alteration work permit: Alterations in all other buildings and structures 7 stories or more, or 100,000 square feet or more, including but not limited to aerial towers and masts, tank structures, fire escapes, etc., which are unoccupied and not easily valued by area.</p> <ul style="list-style-type: none"> • Alteration Type 2 • Alteration Type 3 • Limited Alteration Application 	<p>Minimum Filing Fee - \$225 Minimum Filing Fee - \$195 Minimum Filing Fee - \$195</p> <p>Minimum filing fee for the first [three thousand dollars] <u>\$3,000</u>, or fraction thereof, of the cost of alteration; plus \$10.30 for each [one thousand dollars] <u>\$1,000</u>, or fraction thereof, of the alteration cost in excess of [three thousand dollars] <u>\$3,000</u>.</p> <p>The rates and fees set forth above shall be subject to increases as provided by department rules.</p>	<p>[\$100] <u>\$130 per work type</u></p>	<p>Such alterations work shall include:</p> <ul style="list-style-type: none"> • Applications related to new building work permit application, filed after the first temporary certificate of occupancy (TCO), or the final certificate of occupancy if no TCO is issued. • Installation or alteration of elevators, escalators, amusement devices and other devices regulated under this code, except those filed under a new building application.

TABLE 28-112.2

PERMIT TYPE	FILING FEE	RENEWAL FEE	COMMENTS
Permit to install or alter service equipment except plumbing and fire suppression piping service equipment.	Filing fee calculated as for respective building alteration.	[\$100] <u>\$130</u>	
<p>Permit to install, alter or replace oil-burning equipment [;] , <u>gas or electric heating or any other energy source equipment.</u></p> <ul style="list-style-type: none"> • Where the storage tank exceeds two hundred seventy five gallon capacity; or where the storage tank is less than two hundred seventy five gallons and is to be buried, or is to be installed in a multiple dwelling or a place of assembly or in a building along the line of a subway, or is to deliver fuel oil to a burner installed above the lowest floor of a building with a primary Business Group B. occupaney. • In all other conditions.] 	<p><u>\$130 (Per Type, Device, or Equipment)</u></p> <p>[\$130]</p> <p>[\$65]</p>	<p><u>\$130 (Per Type, Device or Equipment)</u></p> <p>[\$100]</p> <p>[\$100]</p>	
Other			
Permit for foundation, earthwork or open space without roof, whether enclosed or unenclosed, on sites such as parking lots, gasoline or oil-selling stations, storage yards, sales or exhibition or show spaces used for generally similar purposes.	\$10 for each two thousand square feet of area or fraction thereof, but not less than \$130.	[\$100] <u>\$130</u>	

TABLE 28-112.2

PERMIT TYPE	FILING FEE	RENEWAL FEE	COMMENTS
Permit for golf driving range.	\$7.50 for each twenty thousand square feet of area or fraction thereof, but not less than \$130.	[\$100] <u>\$130</u>	
Accessory building to golf driving range, not to exceed [one hundred forty-four] <u>144</u> square feet.	\$130	[\$100] <u>\$130</u>	
Permit for demolition and removal.	Multiply building frontage in feet or fraction thereof × number of stories of the building × \$2.60, but not less than \$260. For corner lot, use the longer building frontage.	[\$100] <u>\$130</u>	
Curb cut, private dwelling	\$3 for each linear foot including splay; minimum \$130		
Curb cut, other	\$6 for each linear foot including splay; minimum \$130		
<u>Amendments</u>			
Filing of [post approval] amendments to [existing] <u>active applications and active permits.</u>	[The greater of \$100 or the fees for the additional scope or cost of work as calculated pursuant to this Table 28-112.2.] <u>As provided by rule.</u>		
<u>Signs</u>			
Permit to erect, install or alter sign: <u>Ground sign, wall sign, or any sign mounted to the wall or any other structure.</u>	Filing fee calculated as for respective building alteration, plus \$5 for each one hundred square feet of surface area or fraction thereof, but not less than \$35.	[\$100] <u>\$130</u>	Each face of any sign, when fronting on different streets, shall be treated as a separate sign.
Permit to erect, install or alter sign: Roof sign having a tight, closed or solid surface.	Filing fee calculated as for respective building alteration; plus \$15 for each [one hundred] <u>\$100</u> square feet of surface area, or fraction thereof, but not less than \$70.	[\$100] <u>\$130</u>	Each face of any sign, when fronting on different streets, shall be treated as a separate sign.

TABLE 28-112.2

PERMIT TYPE	FILING FEE	RENEWAL FEE	COMMENTS
Permit to erect, install or alter sign: Roof sign without a tight, closed or solid surface, extending to a height of not more than [thirty one] <u>31</u> feet above roof level.	Filing fee calculated as for respective building alteration; plus \$15 for each [one hundred] <u>100</u> square feet of surface area, or fraction thereof, but not less than [\$100] <u>\$130</u> .	[\$100] <u>\$130</u>	Each face of any sign, when fronting on different streets, shall be treated as a separate sign.
Permit to erect, install or alter sign: Roof sign without a tight, closed or solid surface, extending to a height over [thirty one] <u>31</u> feet above roof level.	Filing fee calculated as for respective building alteration; plus \$25 for each [one hundred] <u>100</u> square feet of area, or fraction thereof, but not less than \$135.	[\$100] <u>\$130</u>	Each face of any sign, when fronting on different streets, shall be treated as a separate sign.
Permit to erect, install or alter sign: <u>Illuminated sign on storefront or wall or any other structure projecting beyond street line</u> having [thirty] <u>30</u> square feet or less on one side.	Filing fee calculated as for respective building alteration.	\$100] <u>\$130</u>	Illuminated sign is subject to annual use fee: \$45.
Permit to erect, install or alter sign: <u>Illuminated sign on storefront or wall or any other structure projecting beyond street line</u> having more than thirty square feet but no more than [fifty] <u>50</u> square feet on one side.	Filing fee calculated as for respective building alteration.	\$100] <u>\$130</u>	Illuminated sign is subject to annual use fee: \$70.
Permit to erect, install or alter sign: <u>Illuminated sign on storefront or wall or any other structure projecting beyond street line</u> and having more than [fifty] <u>50</u> square feet on one side.	Filing fee calculated as for respective building alteration.	\$100] <u>\$130</u>	Illuminated sign is subject to annual use fee: \$.075 for each square foot or part thereof annually, but not less than [\$100] <u>\$130</u> .
Maintenance permit for outdoor signs.	As provided by department rules.		
<u>Temporary Structures and Construction Installations</u>			

TABLE 28-112.2

PERMIT TYPE	FILING FEE	RENEWAL FEE	COMMENTS
Sidewalk shed	\$160 for the first [twenty-five] <u>25</u> feet or fraction thereof in the length of the shed; plus \$10 for each additional [twenty-five] <u>25</u> feet or fraction thereof.	[\$100] <u>\$130</u>	
Scaffold	\$160	[\$100] <u>\$130</u>	
Construction Fence	\$160	[\$100] <u>\$130</u>	
Permit for temporary shed, railing, footbridge, catch platform, building sidewalk shanty, over-the-sidewalk chute.	\$160 for each permit.	[\$100] <u>\$130</u>	
Permit for temporary structure other than those [temporary structures] listed above, including but not limited to tents, grandstands, stages.	For the initial 30 days of permit duration: \$130 for the first [one thousand] <u>1,000</u> square feet or fraction thereof; plus \$0.10 for each square foot or fraction thereof in excess of one thousand square feet; [\$100] <u>\$130</u> for each additional 30 day period of permit duration.	[\$100] <u>\$130</u> for each <u>additional 30 days.</u>	
Reinstatement of Applications/Permits			
Application [/permit] reinstatement fees: [<ul style="list-style-type: none"> • Prior to first permit.] • Following first permit issuance but prior to commencing work. • Following first permit, with work partially complete. • <u>Reinstatement of an abandoned application.</u> 	<p>[Full fee at the rate in effect on the date of reinstatement.]</p> <p>Full fee at the rate in effect on the date of reinstatement.</p> <p><u>Full fee at the rate in effect on the date of reinstatement.</u></p> <p><u>Based upon the full fee at the rate in effect on the date of reinstatement, the percentage of the fee equal to the percentage of work remaining, as determined by the department inspector.</u></p>		

TABLE 28-112.2

PERMIT TYPE	FILING FEE	RENEWAL FEE	COMMENTS
<p><u>Permit reinstatement fees:</u></p> <ul style="list-style-type: none"> • <u>Following first permit issuance but prior to commencing work and more than 1 year since filing.</u> • <u>Following first permit, but more than 1 year with work partially complete.</u> • <u>Following first permit, more than 1 year after work suspended or abandoned.</u> • <u>Work permit within a period of 2 years from the date of issuance, solely for the purpose of sign-off, including correction of defects noted in a final inspection as provided in section 28-116.2.4.</u> • <u>More than 2 years with code/zone change during this period (e.g., job application was originally filed under 1968 Code and job must be filed in 2014 Code).</u> 	<p><u>Full fee at the rate in effect on the date of reinstatement.</u></p> <p><u>Based upon the full fee at the rate in effect on the date of reinstatement, the percentage of the fee equal to the percentage of work remaining as determined by the department inspector, plus the renewal fee.</u></p> <p><u>Based upon the full fee at the rate in effect on the date of reinstatement, the percentage of the fee equal to the percentage of work remaining as determined by the department inspector, plus the renewal fee.</u></p> <p><u>Based upon the full fee at the rate in effect on the date of reinstatement, the percentage of the fee equal to the percentage of work remaining as determined by the department inspector, plus the renewal fee.</u></p> <p><u>Re-file job application and pay full filing fee.</u></p>		

1
2 **§28-112.3 Building permit valuations.** An estimate of the cost of construction shall be provided at
3 the time of application for construction document approval or, where no construction documents are
4 required, at the time of application for a permit. Such costs shall include the total value of work

1 proposed, including but not limited to materials, equipment and labor, with reasonable allowances
2 for profit and overhead. If, in the opinion of the department, the cost is underestimated, the
3 application shall be denied, unless the applicant can show detailed estimates to meet the approval of
4 the department. A final [~~affidavit~~] statement with the total actual cost of construction, as built or
5 installed, shall be submitted prior to [~~sign-off~~] sign-off. The initial, amended and final building
6 permit valuation shall be set by the department.

7 **§28-112.4 Work commencing before permit issuance.** Any person who commences any work
8 before obtaining the necessary permits shall be subject to a penalty as specified in this code that shall
9 be in addition to the required permit fees.

10 **Exception: Emergency work performed pursuant to section 28-105.4.1.**

11 **§28-112.5 Related fees.** The payment of the fee for the construction, alteration, removal or
12 demolition for work done in connection or concurrently with the work authorized by a building
13 permit shall not relieve the applicant or holder of the permit from the payment of other fees that are
14 prescribed by law.

15 **§28-112.6 Refunds and rebates.** Upon application to the comptroller of the city of New York, and
16 upon verification of claim by the commissioner, refunds or rebates of partial or full fees shall be
17 provided as set forth in sections 28-112.6.1 through 28-112.6.3.

18 **§28-112.6.1 Withdrawal of work permit applications.** In the event that an owner withdraws an
19 application, the owner may obtain a refund of all or a portion of the fee paid as follows:

- 20 1. If an application for construction document approval is withdrawn prior to the
21 commencement of examination of the application all but [~~forty dollars~~] \$40 of the deposit
22 fee paid shall be refunded.
- 23 2. If an application for construction document approval is withdrawn during the progress of
24 examination of the application, the comptroller shall retain a percentage of the deposit
25 fee paid, which the department shall certify is the equivalent percentage of the
26 examination completed, but not less than [~~one hundred dollars~~] \$100. The remainder of
27 the deposit fee shall be refunded to the owner.
- 28 3. If an application for construction document approval is withdrawn after examination of
29 construction documents and/or construction document approval and before issuance of
30 permit, there shall be refunded by the comptroller 50 percent of the total computed fee
31 for the permit, except that not less than [~~one hundred dollars~~] \$100 shall be retained by
32 the comptroller.

33 **§28-112.6.2 Withdrawal of cranes and derricks applications.** If the applicant withdraws his or
34 her application for a certificate of approval for a power-operated crane, derrick or cableway, such
35 applicant may obtain a refund of a portion of the fees as follows:

- 36 1. If the application is withdrawn prior to the commencement of examination by the
37 department, the entire fee shall be refunded except [~~one hundred dollars~~] \$100.
- 38 2. If the application is withdrawn after the examination has commenced, the comptroller
39 shall retain a percentage of the fee paid, which the department shall certify is the

1 equivalent percentage of the examination performed, but not less than [~~one hundred~~
2 ~~dollars~~] \$100. The remainder of the fee shall be refunded to the applicant.

- 3 3. If the application is withdrawn after the department has performed its examination,
4 whether or not the application has been approved no part of the fee shall be returned to
5 the applicant.

6 **§28-112.6.3 Incentive rebates.** With respect to the rebates under [~~this~~] section 28-112.6, the
7 commissioner may, at his or her discretion, issue a rebate of application fees as follows and as
8 established by rule.

9 **§28-112.6.3.1 Renewable energy rebates.** Owners who demonstrate the production on a
10 zoning lot of five percent or more of the annual energy consumption on the zoning lot through
11 renewable energy sources may receive a fee rebate as established by rule.

12 **§28-112.6.3.2 Rebate for energy use reduction.** Owners who demonstrate a reduction in
13 energy use from that allowed at the time of permit by the New York state energy conservation
14 construction code as a result of the permitted work may receive a fee rebate as established
15 by rule.

16 **§28-112.6.3.3 Rebate for water conservation systems.** Owners who demonstrate
17 conservation of water taken from the city supply by providing evidence of achieving the
18 water-recycling discount authorized by the New York city water board may receive a fee
19 rebate as established by rule.

20 **§28-112.6.3.4 Rebate for redevelopment, remediation and reuse of contaminated**
21 **properties known as brownfields.** Owners who demonstrate that their site was contaminated
22 and has been certified as remediated by the United States environmental protection agency
23 or the New York state department of environmental conservation, or has received a notice of
24 satisfaction from the New York city department of environmental protection, may receive a
25 fee rebate as established by rule.

26 **§28-112.6.3.5 Rebate for recycling construction and demolition waste.** Owners who
27 demonstrate the recycling of construction and demolition waste may receive a fee rebate as
28 established by rule.

29 **§28-112.6.3.6 Rebate for bicycle storage facilities.** Except for R-3 occupancy, owners who
30 demonstrate that they have provided secured indoor bicycling facilities accessible to all
31 building occupants may be rebated their fees as set out in rule. Such facilities shall be
32 identified on approved plans and shall be noted on the certificate of occupancy with a
33 statement that the bicycling accommodations dedicated to such facilities were provided in
34 accordance with this section.

35 **§28-112.6.3.7 Rebate for LEED or other environmental design certification.** Owners who
36 demonstrate certification of their project, which was signed off following the effective date
37 of this code, by the United States Green Building Council based upon the Council's
38 Leadership in Energy and Environmental Design (LEED) rating system or as otherwise
39 provided by rule, may be rebated their fees as set out in rule.

40 **§28-112.6.3.8 Other rebates.** The commissioner is authorized to promulgate rules to rebate
41 fees following sign-off based upon the installation of energy-conserving systems.

1 **§28-112.7 Inspection and report filing fees.** Aside from the fees covered under permit fees above,
2 the following inspection and report filing fees shall be paid according to requirements of this code
3 and as promulgated in rules.

4 **§28-112.7.1 Fees for the testing, approval, inspection and use of power-operated cranes,**
5 **derricks and cableways.** The owner of any crane or derrick shall renew the certificate of
6 operation each year. See Table 28-112.7.1.

7

TABLE 28-112.7.1

EQUIPMENT TYPE	<u>FILING</u> FEE	RENEWAL FEE	COMMENTS
<p>Prototype approval of one configuration of a mobile crane. One configuration shall be comprised of the crane with a main boom, one fixed jib and one set of counterweights.</p> <p>Amendment to a configuration.</p>	<p>\$2500 when testing has been monitored and certified by a competent individual or group, other than the manufacturer, acceptable to the commissioner; \$4000 when, in lieu of monitoring and certification of tests, the commissioner shall require design calculations for such items as the commissioner deems necessary to supplement the tests.</p> <p>One-half the original configuration fee.</p>		<p>Additional configurations shall be subject to the same fee as the original configuration.</p>
<p>Prototype approval of a mobile crane with a hydraulic boom.</p>	<p>\$4000</p>		
<p>Certificate of approval for mobile crane with a boom less than [two hundred] <u>200</u> feet in length; fee also includes initial certificate of operation.</p>	<p>\$500</p>	<p>\$250 annually</p>	<p>The boom length as herein specified shall include the jibs and any other extensions to the boom.</p>
<p>Certificate of approval for mobile crane with a boom [two hundred] <u>200</u> feet or more in length, but less than [three hundred] <u>300</u> feet in length; fee also includes initial certificate of operation.</p>	<p>\$1000</p>	<p>\$250 annually</p>	<p>The boom length as herein specified shall include the jibs and any other extensions to the boom.</p>
<p>Certificate of approval for mobile crane with a boom [three hundred] <u>300</u> feet or more in length but less than [four hundred] <u>400</u> feet in length; fee also includes initial certificate of operation.</p>	<p>\$2000</p>	<p>\$400 annually</p>	<p>The boom length as herein specified shall include the jibs and any other extensions to the boom.</p>
<p>Certificate of approval for mobile crane with a boom [four hundred] <u>400</u> feet or more in</p>	<p>\$3000</p>	<p>\$400 annually</p>	<p>The boom length as herein specified shall</p>

TABLE 28-112.7.1

EQUIPMENT TYPE	<u>FILING FEE</u>	RENEWAL FEE	COMMENTS
length; fee also includes initial certificate of operation.			include the jibs and any other extensions to the boom.
Certificate of approval for master climber and tower cranes and derricks, regardless of length; fee also includes initial certificate of operation.	\$3000	\$400 annually	
Certificate of approval for all other cranes; fee also includes initial certificate of operation.	\$1000	\$250 annually	
Certificate of approval required for a mobile crane with a boom not exceeding [fifty] <u>50</u> feet in length with a maximum rated capacity not exceeding [three] <u>3</u> tons; fee also includes initial certificate of operation.	\$300	\$200 annually	The boom length as herein specified shall include the jibs and any other extensions to the boom.
Certificate of operation-sign hanger, [fifty-one] <u>51</u> feet to [one hundred thirty five] <u>135</u> feet with capacity of 3 tons or less.	\$250	\$200 annually	
New certificate of approval, when the boom or extension thereof is replaced or altered.	The fee shall be the full fee required for testing a new crane or derrick with a boom or extension of the same size and design as the replacement boom or extension thereof.		
Review only of engineering calculations for mobile crane with a boom exceeding 250 feet to be erected by a licensed master or special rigger, for which a certificate of on-site inspection is not required under this code or rules of the department.	[\$100] <u>\$130</u>		
On-site inspection of up to three models of mobile cranes with boom, including jibs and other	\$250 during business hours; \$750 outside business	[\$100] <u>\$130</u>	

TABLE 28-112.7.1

EQUIPMENT TYPE	<u>FILING FEE</u>	RENEWAL FEE	COMMENTS
extensions to the boom [two hundred fifty] <u>250</u> feet or more in length, or derrick.	hours; upon written request of the applicant.		
All other on-site inspections of cranes.	\$150	[\$100] <u>\$130</u>	
Amendment to an application for certificate of on-site inspection.	[\$100] <u>\$130</u>		
Application for waiver of on-site inspection of mobile crane or derrick.	[\$100] <u>\$130</u>		
Notification of Outrigger Beam Installation or dismantling	As provided by department rules		
Notification of use, installation or dismantle of all cranes	As provided by department rules		

1

2 **§28-112.7.2 Report filing fees.** See Table 28-112.7.2.

TABLE 28-112.7.2

REPORT TYPE	<u>FILING FEE</u>	RENEWAL FEE	COMMENTS
Filing fee for report of critical examination of exterior walls and appurtenances thereof.	As provided by department rules.		
Filing fee for inspection report of potentially compromised buildings or structures.	As provided by department rules.		
Filing fee for report of condition assessment of retaining walls.	As provided by department rules.		
Filing fee for periodic boiler inspection report.	[\$30 for each boiler.] <u>As provided by department rules.</u>		
Filing fee for report of periodic inspections and <u>category</u> tests of elevator and other devices [(Category 1)].	[\$30 for each device.] <u>As provided by department rules.</u>		

3

4 **§28-112.7.3 Other inspection fees.** See Table 28-112.7.3.

TABLE 28-112.7.3

INSPECTION TYPE	FILING FEE	RENEWAL FEE	COMMENTS
Each inspection of a temporary amusement device	[\$100] <u>\$130</u>		
Marquee inspection.	\$15 annually for each one hundred square feet or fraction thereof.		---
Place of assembly inspection, including following a violation.	[\$100] <u>\$130</u> each inspection, each place of assembly.		---
<p>Search inspection of a building with a frontage of [twenty-five] <u>25</u> feet or less and a depth of one hundred feet or less.</p> <ul style="list-style-type: none"> • Additional fee for building with frontage exceeding [twenty-five] <u>25</u> feet. • Additional fee for building with depth exceeding [one hundred] <u>100</u> feet. 	<p>\$20 for each floor for the first three floors; \$10 for each additional floor; [\$100] <u>\$130</u> minimum total.</p> <p>Increase above fee by 40% for each floor for each additional [twenty-five] <u>25</u> feet or fraction thereof. Increase above fee by 25% for each floor for each additional [twenty-five] <u>25</u> feet or fraction thereof.</p>		A basement or a cellar shall count as a floor. Where both a basement and a cellar exist, the cellar shall not count as a floor in computing fee.

1 **§28-112.7.4 Equipment inspection fees.** See Table 28-112.7.4.

TABLE 28-112.7.4

EQUIPMENT INSPECTION TYPE	FILING FEE	RENEWAL FEE	COMMENTS
<ul style="list-style-type: none"> • High-pressure boiler periodic inspection. • Reinspection fee following a violation. • Equipment inspection fee: Each elevator or other device regulated by this code. 	<p>\$65 for each inspection, for each boiler.</p> <p>As provided by department rules, [\$100] <u>\$130</u> for each inspection, for each device.</p>		

2
 3 **§28-112.8 Special fees.** Special fees are charged for services that are not covered in the fees for
 4 permits, equipment, reports and inspection. The department shall be entitled to charge the following
 5 special fees in accordance with Table 28-112.8:

6

TABLE 28-112.8

SERVICE TYPE	<u>FILING FEE</u>	<u>[RENEWALS]</u> <u>RENEWAL</u> <u>FEE</u>	COMMENTS
Accelerated plan review	As provided by department rules		
Accelerated inspection	As provided by department rules		
Certificate of occupancy request	As provided by department rules		
Accelerated certificate of occupancy request	As provided by department rules		
Application for temporary certificate of occupancy Application for interim certificate of occupancy	[\$100] <u>\$130</u> \$130	[\$100] <u>\$130</u>	
<u>Application to amend a temporary certificate of occupancy</u>	<u>\$130</u>		
Reinspection made necessary by a failure to correct a condition or respond to a request to correct that results in issuance of a violation or other order	As provided by department rules		
Temporary place of assembly certificate of operation	[\$100] <u>\$130</u>	[\$100] <u>\$130</u>	
Temporary use letter (does not include fees for any associated temporary structure)	For the initial 30 days of duration \$100. [\$100] <u>\$130</u> for each additional 30 day period of permit duration.	[\$100] <u>\$130</u> for each additional 30 days	
Temporary use letter for place of assembly	\$250		Application shall be submitted at least ten work days prior to the event; late fees shall be imposed at \$100 for each day following required submission date that the application is received by the department.

TABLE 28-112.8

SERVICE TYPE	<u>FILING FEE</u>	<u>[RENEWALS]</u> <u>RENEWAL</u> <u>FEE</u>	COMMENTS
Subpoena	As provided by applicable state or federal law		
Place of assembly certificate of operation	\$200		[\$100] \$130 amendment
Ordinary plumbing work	[\$100] \$130 for each report		
Limited plumbing alteration	Filing fee as calculated for respective building alteration		
Limited sprinkler and/or standpipe alteration	Filing fee as calculated for respective building alteration		
Limited [oil burner/boiler] <u>oil-burning appliance</u> alteration	Filing fee as calculated for respective building alteration		
Approval or acceptance of materials, assemblies and equipment			
Application for approval of materials	\$600		
Application for amendment of prior approval of materials	\$500		
Application for change of identification (change of ownership, corporate name or name of product) of prior approval	\$350		
Application for approval of materials evaluated by an approved testing agency	\$200		
Other fees			
Certificate of pending violation: Multiple and private dwellings	As provided by department rules		
Certificate of pending violation: All other buildings	As provided by department rules		
Certified copy of license	As provided by department rules		
Records Management of applications for new buildings and alterations and associated	As provided by department rules		

TABLE 28-112.8

SERVICE TYPE	<u>FILING FEE</u>	<u>[RENEWALS]</u> <u>RENEWAL</u> <u>FEE</u>	COMMENTS
documentation for certificates of occupancy, temporary certificates of occupancy, “compliance reports” and/or letters of completion, as required by rule of the commissioner			
Preparing only or preparing and certifying a copy of a record or document filed in the department	As provided by department rules		
Notification of, the installation or removal of an adjustable suspended scaffold	\$35		
Issuance of a core certificate of completion, which indicates completion of the building structure, the elevator systems, stairs, and all fire safety systems	[\$100] <u>\$130</u>		
Issuance of letter of no objection to or classification of a specified occupancy of a premises, as follows: <ul style="list-style-type: none"> • 1-, 2[;]- or 3- family homes • All other premises 	\$25 [\$100] <u>\$130</u>		
Fees for after-hours work variances. <ul style="list-style-type: none"> • The initial application fee for an after-hours variance • The renewal application fee for an after-hours variance For each day for which such variance is granted or renewed	[\$100] <u>\$130</u> [\$100] <u>\$130</u> \$80		
Application for approved agency approval	As provided by department rules		
Application for special inspector authorization	As provided by department rules		

TABLE 28-112.8

SERVICE TYPE	<u>FILING FEE</u>	<u>[RENEWALS]</u> <u>RENEWAL</u> <u>FEE</u>	COMMENTS
Failure to keep a scheduled plan examination appointment	As provided by department rules		
Failure to keep a scheduled inspection appointment	As provided by department rules		

1 **§28-112.9 Lien on premises for unpaid fee or other charge.** Any unpaid fee or charge for an
 2 inspection, reinspection, examination or service performed by the department or other unpaid
 3 amount owed to the department, and all permits issued by the department, pursuant to law shall
 4 constitute a lien upon the land and buildings upon or in respect to which such inspection,
 5 reinspection, examination or service was performed or permit issued, as hereinafter provided.

6 **§28-112.9.1 Filing of fees.** The department shall maintain a record of all unpaid fees and other
 7 charges. Such records shall be kept on a building by building basis and shall be accessible to the
 8 public during business hours. An entry of an unpaid amount on the records of the department
 9 shall constitute notice to all parties.

10 **§28-112.9.2 Lien.** All such unpaid amounts shall constitute a lien upon the land and building
 11 upon, or in respect to which, such inspection, reinspection, examination or service was performed
 12 or permit issued when the amount thereof shall have been definitely computed as a statement of
 13 account by the department and the department shall file such statement with the department of
 14 finance for entry in the records of such department against the premises. Such lien shall have a
 15 priority over all other liens and encumbrances except for the lien of taxes and assessments.
 16 However, no lien created pursuant to [this] section 28-112.9 shall be enforced against a
 17 subsequent purchaser in good faith or mortgagee in good faith unless the requirements of section
 18 28-112.9.1 are satisfied.

19 **§28-112.9.3 Notice.** A notice, stating the amount due and the nature of the charge, shall be mailed
 20 by the department of finance [;] to the last known address of the person whose name appears on
 21 the records in the office of the department of finance as being the owner or agent or as the person
 22 designated by the owner to receive tax bills or, where no name appears, to the premises [;]
 23 addressed to either the owner or the agent.

24 **§28-112.9.4 Interest.** If such charge is not paid within 30 days from the date of entry, it shall be
 25 the duty of the department of finance to receive interest thereon at the rate of 15 percent per
 26 annum, to be calculated to the date of payment from the date of entry.

27 **§28-112.9.5 Tax lien.** Such charge and the interest thereon shall continue to be, until paid, a lien
 28 on the premises. Such lien shall be deemed a tax lien within the meaning of sections 11-319 and
 29 11-401 of the administrative code and may be sold, enforced or foreclosed in the manner
 30 provided in chapter [three] 3 or [four] 4 of title [eleven] 11 of such code or may be satisfied in
 31 accordance with the provisions of section [thirteen hundred fifty four] 1354 of the New York
 32 state real property actions and proceedings law.

1 **§28-112.9.6 Reference.** The notice mailed by the department of finance pursuant to [this] section
2 28-112.9 shall have stamped or printed thereon a reference to [this] section 28-112.9.

3 **§28-112.9.7 Validity not subject to challenge in enforcement proceeding.** In any proceedings
4 to enforce or discharge a lien created pursuant to [this] section 28-112.9, the validity of the lien
5 shall not be subject to challenge based on:

- 6 1. The lawfulness of the inspection, reinspection, examination, service or permit; or
- 7 2. The propriety and accuracy of the fee for which a lien is claimed, except as provided in
8 [this] section 28-112.9.

9 **§28-112.9.8 Standing to challenge.** No such challenge may be made except by (i) the owner of
10 the property, or (ii) a mortgagee or lien or whose mortgage or lien would, but for the provisions
11 of [this] section 28-112.9, have priority over the department's lien.

12 **§28-112.10 Waiver of application, permit and inspection fees for certain work arising out of the**
13 **storm that occurred on October 29 and 30, 2012.** The commissioner shall waive the fees that
14 would otherwise be required to be paid by this code, the electrical code or the rules of the department
15 for applications, permits and inspections for certain work arising out of the storm that occurred on
16 October 29 and 30, 2012 as provided in [subsections] sections 28-112.10.1 and 28-112.10.2.

17 **§28-112.10.1 Eligible buildings.** For the purposes of this article, eligible buildings that,
18 following the storm and pursuant to an inspection program established by the department under
19 an emergency order of the Mayor, are designated by the department after inspection through a
20 notation on the department's records and/or by the posting of a red placard warning on the
21 building or premises as seriously damaged and unsafe to enter or occupy or completely
22 demolished and/or washed away. With respect to eligible buildings, fees associated with
23 applications, permits and inspections shall be waived for alteration work, demolition work,
24 construction of new buildings and associated work, including but not limited to associated
25 electrical and plumbing work. The commissioner may request the applicant to submit additional
26 information relating to the damage. Waiver of such fees pursuant to this section shall be
27 applicable for jobs where the initial application for construction document approval or, if no
28 construction documents are required, application for permit is submitted on or after October 30,
29 2012 and on or before October 31, 2014.

30 **§28-112.10.2 Storm related damage to electrical and plumbing systems.** In buildings other
31 than eligible buildings, fees shall be waived only for applications, permits and inspections for
32 work related to plumbing and electrical systems damaged by such storm. Applicants must submit
33 certification by a licensed master electrician or a licensed master plumber or fire suppression
34 piping contractor that the proposed work is related to such storm damage. The commissioner
35 may request the applicant to submit additional information relating to the damage. Waiver of
36 such fees pursuant to this section shall be applicable for jobs where the initial application for
37 construction document approval or, if no construction documents are required, application for
38 permit is submitted on or after October 30, 2012 and on or before December 31, 2013.

39 **§28-112.11 Waiver of application, permit and inspection fees for work funded under the “Build**
40 **It Back” program.** The city has implemented a disaster recovery program known as the Build It
41 Back program that uses federal Community Development Block Grant Disaster Recovery funds to

1 aid in the recovery of residential property damaged or destroyed in the severe storm known as Sandy
2 that occurred on October 29 and 30, 2012. To assist in such recovery, the commissioner shall waive
3 fees, which would otherwise be required to be paid to the department by this code, the electrical code
4 or the rules of the department, in connection with applications, permits and inspections for work that
5 is officially approved and funded under the Build It Back program. The waiver provided for in this
6 section shall apply only to work performed on property that is classified as residential and to fees
7 payable on or after July 1, 2014. With respect to work on a mixed use building, fees payable on or
8 after such date may only be waived for work on the residential units of such building and portions
9 of such building that serve the residential units.

10 **§28-112.12 Reduction in fees or penalties for sponsoring site safety training.** The commissioner
11 shall establish by rule a program for reducing the amount of any fee to be imposed upon a person or
12 any civil penalty to be imposed upon a person for a violation, other than an immediately hazardous
13 violation, where one or more of the following conditions is satisfied:

- 14 1. Such person demonstrates, in a form and manner established by the commissioner, that such
15 person has paid, either directly or indirectly, for the costs of one or more workers to obtain
16 the training needed to comply with section 3321 of the New York city building code or has
17 otherwise arranged for such workers to receive such training at no cost to such workers,
18 provided that this shall not include any worker trained pursuant to an agreement that such
19 person was required to enter into pursuant to section 28-204.1.1 or any worker trained under
20 a program developed pursuant to section 22-509 of the administrative code.
- 21 2. The fee or penalty to be imposed upon such person relates to a building site for which the
22 owner of such site, or a person acting on such owner’s behalf, demonstrates, in a form and
23 manner established by the commissioner, that such owner or such person acting on such
24 owner’s behalf has paid, either directly or indirectly, for the costs of one or more workers to
25 obtain the training needed to comply with section 3321 of the New York city building code
26 or has otherwise arranged for such workers to receive such training at no cost to such workers,
27 provided that this shall not include any worker trained pursuant to an agreement such person
28 was required to enter into pursuant to section 28-204.1.1 or any worker trained under a
29 program developed pursuant to section 22-509 of the administrative code.

30 **ARTICLE 113**
31 **MATERIALS**

32 **§28-113.1 General.** Materials shall be used, tested and approved for use in accordance with the
33 specific provisions of this code and department rules, except that the commissioner shall have the
34 power to limit or prohibit the use of any material to protect public safety. Materials shall be identified
35 or described on construction documents and other related documents.

36 **§28-113.2 Use of materials.** Except as set forth in sections 28-113.2.1 through [~~413.2.6~~] 28-113.2.6
37 materials specifically prescribed by this code or department rules may be used as prescribed without
38 the prior approval of the commissioner.

39 **§28-113.2.1 Approved material.** Whenever this code or the rules of the department requires the
40 use of an approved material, such material shall not be used without the prior approval of the
41 commissioner for such use and may be used only to the extent set forth in such approval.

1 **§28-113.2.2 Alternative materials.** Except as otherwise specifically limited by this code, the
2 provisions of this code are not intended to prevent the installation of any material or to prohibit
3 any alternative engineered design or method of construction not specifically prescribed by this
4 code, provided that the use of such alternative material has been previously approved by the
5 commissioner and may be used only to the extent set forth in such approval. The use of an
6 alternative material, design, method of construction or equipment shall be approved where the
7 commissioner finds that the proposed design is satisfactory and complies with the intent of the
8 provisions of this code, and that the material, method or work offered is, for the purpose intended,
9 at least the equivalent of that prescribed in this code in quality, strength, effectiveness, fire
10 resistance, durability and safety.

11 **§28-113.2.3 Listed or labeled.** Whenever this code or the rules of the department requires that
12 material used be listed or labeled to a standard, material that is so listed or labeled may be used
13 in accordance with such list or label without the prior approval of the commissioner. However,
14 the commissioner reserves the right to require that information be submitted with regard to the
15 testing and evaluation of any material so listed or labeled including but not limited to inspection
16 certificates, test or evaluation reports, analysis, computations or other information used to
17 determine that the material so listed or labeled complies with the applicable standard.

18 **§28-113.2.4 Material not listed or labeled.** Whenever this code or the rules of the department
19 requires that material be listed or labeled to a standard and material proposed to be used is not
20 so listed or labeled, the use of such material shall be subject to prior approval by the
21 commissioner and such material shall be used only to the extent set forth in such approval.

22 **§28-113.2.5 Reuse.** The use of used material that meets the requirements of this code for new
23 material is permitted unless otherwise provided in this code. Used equipment and devices shall
24 not be reused without the prior approval of the commissioner and may be used only to the extent
25 set forth in such approval.

26 **§28-113.2.6 Previously issued approvals.** Materials that were previously approved by the board
27 of standards and appeals or by the department before July 1, 2008 may continue to be used to the
28 extent that such approval is not inconsistent with the requirements or standards of this code,
29 unless specifically amended or repealed by the commissioner.

30 **§28-113.3 Approval procedure.** Approval of materials pursuant to section 28-113.2 shall be in
31 accordance with procedures set forth in this code and the rules of the department. The cost offsets,
32 reports and investigations required under these provisions shall be paid by the applicant.

33 **§28-113.3.1 Performance.** When required by the commissioner, specific information consisting
34 of test reports conducted by an approved testing agency in accordance with standards referenced
35 in the construction codes or other such information as necessary, shall be provided for the
36 commissioner to determine whether the material will perform for the use intended.

37 **§28-113.3.2 Research and investigation.** When required by the commissioner, sufficient
38 technical data shall be submitted to the commissioner to substantiate the proposed use of any
39 material. If it is determined that the evidence submitted is satisfactory proof of performance for
40 the use intended, the commissioner shall approve the use of the material subject to the
41 requirements of this code.

1 **§28-113.3.3 Retesting of materials.** All materials tested and accepted for use shall be subject to
2 periodic retesting as determined by the commissioner; and any material that upon retesting is
3 found not to comply with the code requirements or the requirements set forth in the approval of
4 such material shall cease to be acceptable for the use intended. During the period for such
5 retesting, the commissioner may require the use of such material to be restricted or discontinued
6 if necessary to secure safety.

7 **§28-113.3.4 New materials.** New materials not provided for in this code, and any material of
8 questioned suitability proposed for use in the construction of a building or structure, shall be
9 subjected to the tests prescribed in this code or in the rules of the department to determine
10 character, quality and limitations of use.

11 **§28-113.3.5 Research reports.** Supporting data, where necessary to assist in the approval of
12 materials not specifically provided for in this code, shall consist of valid research reports from
13 approved sources or other equivalent approved supporting documentation.

14 **§28-113.3.6 Conflicting test results.** Whenever there is evidence of conflicting results in the test
15 of any material, the commissioner shall determine the acceptability of the material and/or the
16 acceptable rating for such material.

17 **§28-113.3.7 Amendment and repeal.** The commissioner shall have the power to amend or repeal
18 the approval of any material, including materials previously approved by the board of standards
19 and appeals.

20 **§28-113.3.8 Maintenance of records of approved material.** For any material that has been
21 approved, a record of such approval, including the conditions and limitations of the approval,
22 shall be posted on the department's website or shall be made available for public inspection at
23 appropriate times.

24 **§28-113.4 Labeling.** Materials required to be labeled shall be labeled in accordance with the
25 procedures set forth in this code or the recognized referenced standards.

26 **§28-113.4.1 Testing.** An approved agency shall test a representative sample of the material being
27 labeled to the relevant standard or standards. The approved agency shall maintain a record of the
28 tests performed. The record shall provide sufficient detail to verify compliance with the test
29 standard.

30 **§28-113.4.2 Inspection and identification.** The approved agency shall at regular intervals
31 perform surveillance inspections, which shall be in-plant if necessary, of the material that is to
32 be labeled. The inspection shall verify that the labeled material is representative of the material
33 tested.

34 **§28-113.4.3 Label information.** The label shall contain the manufacturer's or distributor's
35 identification, model number, serial number or definitive information describing the material's
36 performance characteristics and the approved agency's identification.

37 **§28-113.4.4 Shipment and delivery certification of materials listed, labeled or approved.** In
38 the case of the shipment or delivery of material listed or labeled to a standard, such material shall

1 be appropriately labeled or accompanied by the inspection certificate of an approved agency that
2 the material is the same as that which was tested and evaluated by such agency. In the case of
3 the shipment or delivery of material previously approved by the commissioner, the material shall
4 be identified by a tag or certificate indicating that the material is the same that was approved for
5 its intended use by the commissioner or, if applicable, previously approved by the board of
6 standards and appeals, and containing the applicable approval number or calendar number under
7 which the material received such approval.

8 **§28-113.5 Volatile organic compounds emissions in carpet and carpet cushion.** On and after July
9 1, 2013 carpet and carpet cushion as defined in section 17-1401 of the administrative code shall
10 comply with the limits on volatile organic compound emissions set forth in chapter 14 of title 17 of
11 such code.

12 **ARTICLE 114**
13 **APPROVED AGENCIES**

14 **§28-114.1 General.** Approved agencies shall satisfy the provisions of this article and the rules of the
15 department as to qualifications and operations. The commissioner may revoke or suspend the
16 commissioner's approval of or otherwise sanction an approved agency for cause.

17 **§28-114.1.1 Independent.** An approved agency shall perform its authorized duties objectively
18 and competently. The agency shall disclose possible conflicts of interest so that objectivity can
19 be confirmed.

20 **§28-114.1.2 Testing equipment.** An approved agency shall have adequate testing equipment to
21 perform required tests. The equipment shall be periodically calibrated.

22 **§28-114.1.3 Personnel.** An approved agency shall employ experienced personnel qualified to
23 conduct, supervise and evaluate the tests or inspections that it undertakes. Special inspections
24 may be performed only by employees of such agency who are special inspectors qualified
25 pursuant to department rules to perform or witness the particular test or inspection. The
26 commissioner may require proof of the qualifications of employees.

27 **§28-114.1.4 Background.** The commissioner may require an approved agency to submit to an
28 investigation of its background and of the background of its principals as a condition of approval.

29 **§28-114.1.5 Insurance.** An approved agency shall maintain liability insurance as required by
30 department rules.

31 **§28-114.2 Written evaluation by approved agency.** An agency's evaluation of material or report
32 of an inspection shall be in writing after satisfactory completion of the required inspection or test.

33 **§28-114.3 Records.** The approved agency shall maintain records of inspection and test reports for
34 at least six years or for such period as the commissioner shall determine and shall make such records
35 available to the department upon request.

36 **§28-114.4 Re-authorization of approved agencies.** An approved agency shall have its approval re-
37 authorized in accordance with rules of the department.

1 §28-114.5 Disqualification. The commissioner may disqualify an approved agency or inspector
2 from performing inspections pursuant to this code for cause. The approved agency or inspector
3 shall be given prior notice of the proposed disqualification and the opportunity to contest such
4 action. A list of approved agencies and inspectors who have been disqualified from performing
5 inspections shall be maintained and made available to the public on the department’s website.

6 **ARTICLE 115**
7 **SPECIAL INSPECTION AGENCIES AND SPECIAL INSPECTORS**

8 **§28-115.1 General.** Special inspection agencies are approved agencies and shall be subject to the
9 provisions of article 114 of this chapter. Special inspection agencies and special inspectors shall
10 satisfy the provisions of this article and the rules of the department as to qualifications in order to
11 perform special inspections required by chapter 17 of the New York city building code or elsewhere
12 in this code or department rules.

13 **§28-115.2 Disqualification.** The commissioner may disqualify a special inspection agency or a
14 special inspector from performing special inspections pursuant to this code for cause. The special
15 inspection agency or special inspector shall be given prior notice of the proposed disqualification
16 and the opportunity to contest such action. A list of special inspection agencies and special inspectors
17 who have been disqualified from performing special inspection shall be maintained and made
18 available to the public upon request.

19 **§28-115.3 Records.** A special inspector shall maintain records of special inspections on a building
20 by building basis for at least [6] six years or for such period as the commissioner shall determine
21 and shall make such records available to the department upon request.

22 **ARTICLE 116**
23 **INSPECTIONS AND SIGN-OFF OF COMPLETED**
24 **WORK**

25 **§28-116.1 General.** Construction or work for which a permit is required shall be subject to inspection
26 in accordance with this code and such construction or work shall remain accessible and exposed for
27 inspection purposes until the required inspection is completed. A satisfactory inspection by the
28 department or the acceptance by the department of a satisfactory report of an inspection by an
29 approved agency shall not be construed to be an approval by the department of a violation of the
30 provisions of this code or of any other provision of law. It shall be the duty of the permit holder to
31 cause the work to remain accessible and exposed for inspection purposes. The permit holder shall
32 be liable for any expense entailed in the removal or replacement of any material required to allow
33 inspection. The inspector shall supply a report of the results of each inspection.

34 **§28-116.1.1 Defective work and discrepancies with approved construction documents.** An
35 approved agency conducting inspections shall report defective work and discrepancies with the
36 approved construction documents to the contractor and, when applicable, to the superintendent of
37 construction, for correction. The approved agency shall report uncorrected discrepancies and
38 defective work to the registered design professional of record and the owner in writing.

1 **§28-116.1.2 Hazardous conditions.** The approved agency shall report all conditions noted as
2 hazardous to life, safety or health that are not immediately corrected to the immediate attention
3 of the commissioner.

4 **§28-116.2 Types of inspections.** The inspections set forth in sections 28-116.2.1 through 28-116.2.4
5 are required or authorized by this code.

6 **§28-116.2.1 Preliminary inspection.** Before approving construction documents, the
7 commissioner is authorized to examine or cause to be examined structures or premises for which
8 an application has been filed. The department shall conduct preliminary inspections of no less
9 than 20 percent of buildings containing six or more units where (i) an application for construction
10 documents is submitted to the department and (ii) the applicant has indicated that the building
11 that is the subject of such application is unoccupied, in order to verify the occupancy status of
12 such sites.

13 **§28-116.2.1.1 Preliminary inspection reporting.** By January 1, 2021 and no later than January
14 1 annually thereafter, the department of buildings shall submit to the mayor and the speaker of
15 the council a report describing the findings of preliminary inspections performed pursuant to
16 section 28-116.2.1 in the preceding year. Such report shall include, but not be limited to: (i) the
17 total number of applications found to have falsely indicated that a building was unoccupied; and
18 (ii) for each application found to have falsely indicated that a building was unoccupied, the
19 location of the associated building and date of filing for such application.

20 **§28-116.2.2 Compliance inspections.** In addition to the inspections specified in this code, the
21 commissioner is authorized to make or require other inspections of any construction work to
22 ascertain compliance with the provisions of this code and other laws that are enforced by the
23 department.

24 **§28-116.2.3 Special inspections, progress inspections and other inspections required during**
25 **the progress of work.** After the issuance of a work permit, special inspections, progress
26 inspections and other inspections required by this code to be made during the progress of the
27 work shall be made at such times or at such stages of the work and in such manner as shall be
28 provided by this code or as otherwise required by the commissioner. The permit application shall
29 set forth an inspection program for the work. Such inspections may be made by approved
30 agencies or by the department as provided in this code or in the rules of the department. Special
31 inspections shall be performed only by individuals who are special inspectors. The commissioner
32 may accept inspection and test reports from approved agencies and the work may, unless
33 otherwise specifically provided by code provisions or directed by the commissioner, proceed
34 without any verifying inspection or test by the department. The names and business addresses of
35 special inspectors and approved agencies shall be set forth in the work permit application. All
36 inspection reports shall be in writing and signed by the person or entity performing the
37 inspection. A record of all inspections shall be kept by the person performing the inspection. The
38 commissioner may require inspection reports to be filed with the department. Records of
39 inspections made by approved agencies and special inspectors shall be maintained by such
40 persons for a period of six years after sign-off of the work or for such other period of time as the
41 commissioner may require and shall be made available to the department upon request.

1 **§28-116.2.3.1 Special and progress inspection of fabricated items.** Where fabrication of
2 regulated products is performed on the premises of a fabricator's shop, special ~~of~~ and
3 progress ~~[inspection]~~ inspections of the fabricated items ~~[is]~~ are required as provided in this
4 code. The approved agency shall verify that the fabricator maintains detailed fabrication and
5 quality control procedures that provide a basis for inspection control of the workmanship and
6 the fabricator's ability to conform to approved construction documents and referenced
7 standards. The approved agency shall review the procedures for completeness and adequacy
8 relative to the code requirements for the fabricator's scope of work.

9 **Exceptions:**

- 10 1. Work that is subject to progress inspections and performed on the fabricator's
11 premises shall not be subject to progress inspections where the fabricator is
12 approved by the commissioner in accordance with section 28-116.6 of this code.
- 13 2. Work that is subject to special inspections and performed on the fabricator's
14 premises shall be inspected by the special inspection agency in accordance with
15 Section 1704.2.2.3 of the New York city building code where the fabricator is
16 approved by the commissioner in accordance with section 28-116.6 of this code.

17 **§28-116.2.3.2 Special inspection of raising and moving of a building.** Where the lowest
18 above-grade floor or the lowest subgrade floor of a building is to be raised, lifted, elevated
19 or moved, special inspection of such work is required. The permit holder shall notify the
20 department in writing at least 48 hours before the commencement of such work.

21 **§28-116.2.4 Final inspection.** There shall be a final inspection of all permitted work. Final
22 inspections shall comply with sections 28-116.2.4.1 through 28-116.2.4.3.

23 **§28-116.2.4.1 Final inspection prior to certificate of occupancy.** In all cases where the
24 permitted work requires the issuance of a new or amended certificate of occupancy, the final
25 inspection shall be performed by the department in the presence of the permit holder, the
26 registered design professional of record or the superintendent of construction. Such
27 inspection shall be performed after all work authorized by the building permit is completed
28 and before the issuance of the certificate of occupancy. All failures to comply with the
29 provisions of this code or approved construction documents shall be noted and the owner
30 promptly notified thereof in writing. All defects noted in such inspection shall be corrected.
31 Reports of such final inspections shall be maintained by the department. The final inspection
32 report shall confirm that defects noted have been corrected, that the work is in substantial
33 compliance with the approved construction documents and with this code and with other
34 applicable laws and rules and that all required inspections were performed.

35 **Exception:** For amended certificates of occupancy subject to section 28-118.16.2, the
36 term construction documents, as used in section 28-116.2.4.1, shall consist of an accurate
37 and complete final lot survey made by a land surveyor, and floor and roof plans showing,
38 at a minimum, compliance with exit requirements in accordance with this code.

39 **§28-116.2.4.2 Final inspection prior to letter of completion.** In all cases where the
40 permitted work does not require the issuance of a certificate of occupancy, the final
41 inspection shall be performed by ~~[the department or at the option of the owner by]~~ an
42 approved agency on behalf of the owner or by the department as directed by the
43 commissioner. ~~[Whenever the department performs a final inspection, the department shall~~

1 ~~charge a fee for such inspection.~~] The applicant shall take all reasonable and necessary steps
2 to ensure that the final inspection is performed within one year after the expiration of the last
3 permit. The inspection shall be performed after all work authorized by the building permit is
4 completed. The approved agency performing the inspection shall report defective work and
5 discrepancies with the approved construction documents to the contractor and, when
6 applicable, to the superintendent of construction, for correction. The approved agency shall
7 report uncorrected discrepancies and defective work to the registered design professional of
8 record and the owner in writing. The approved agency shall report all conditions noted or
9 observed as hazardous to life, safety or health that are not immediately corrected to the
10 immediate attention of the commissioner. All defects noted in such inspection shall be
11 corrected. The final inspection report shall confirm that defects noted have been corrected,
12 that the work is in substantial compliance with the approved construction documents and
13 with this code and other applicable laws and rules and that all required inspections were
14 performed. Final inspection reports shall be filed with and maintained by the department.
15 Records of final inspections made by approved agencies shall be maintained by such persons
16 for a period of six years after sign-off or for such other period as the commissioner shall
17 require and shall be made available to the department upon request.

18 **Exception:** Final inspection shall be performed by the department for permitted work in
19 R-2 occupancies if the building is listed on the department of housing preservation and
20 development's website pursuant to paragraph 6 of subdivision m of section 27-2115 of the
21 administrative code. The department shall charge a fee for such inspection.

22 **§28-116.2.4.3 Final inspection of gas piping systems.** The final inspection of gas piping
23 systems shall be performed by the department in the presence of the permit holder, the
24 registered design professional of record or the superintendent of construction. Such inspection
25 shall be performed after all work authorized by the building permit is completed. All failures
26 to comply with the provisions of this code or approved construction documents shall be noted
27 and the owner promptly notified thereof in writing. All defects noted in such inspection shall
28 be corrected. Reports of such final inspections shall be maintained by the department. The
29 final inspection report shall confirm that defects noted have been corrected, that the work is
30 in substantial compliance with the approved construction documents and with this code and
31 with other applicable laws and rules and that all required inspections were performed.

32 **§28-116.3 Inspection requests.** It shall be the duty of the permit holder to notify the department or
33 the person or entity designated to perform the inspection when work requiring inspection is ready to
34 be inspected. It shall be the duty of the permit holder to provide access to and means for inspection
35 of such work for any inspections that are required by this code.

36 **§28-116.3.1 Additional notifications for special inspections.** The permit holder shall also notify
37 the relevant special inspection agency in writing at least 72 hours prior to the commencement of
38 any work requiring special inspection.

39 **§28-116.4 Sign-off of completed work.** Upon submission of a satisfactory report of final inspection
40 and all required submittal documents, the department shall document the sign-off of the project and
41 issue a letter of completion, or, if applicable, a certificate of occupancy for the work. The owner
42 shall take all necessary steps required by the department for the issuance of such letter of completion
43 or certificate of occupancy within [±] one year following the expiration of the last permit.

1 **§28-116.4.1 Issuance of certificate of compliance.** The following types of service equipment
2 shall not be operated until the department issues a certificate of compliance after submission of
3 a satisfactory report of inspection and testing of such equipment in accordance with this code
4 and all required submittal documents:

- 5 1. Air-conditioning, ventilation and exhaust systems.
- 6 2. Elevators, escalators, moving walkways and dumbwaiters.
- 7 3. Fuel burning and fuel-oil storage equipment.
- 8 4. Refrigeration systems.
- 9 5. Heating systems.
- 10 6. Boilers.

11 **Exception:** A certificate of compliance shall not be required in connection with work
12 specifically exempted from permit requirements in accordance with this code or department
13 rules.

14 **§28-116.5 Payment of outstanding penalties.** The department may refuse to issue a letter of
15 completion or certificate of occupancy pending payment of all outstanding fines or civil penalties
16 imposed for violations of this code, the 1968 building code or other laws enforced by the department
17 at the same building.

18 **§28-116.6 Fabricator approval.** Approval of fabricators by the department shall be based upon
19 review of the fabricator’s written procedural and quality control manuals and periodic auditing of
20 fabrication practices by an approved agency.

21 **§28-116.6.1 Certificate of intent to fabricate.** For all work where approval is sought based upon
22 section 28-116.6, the approved fabricator shall submit a certificate of intent to fabricate such work
23 to the department identifying the work to be performed as an approved fabricator, and that such
24 work shall be performed in accordance with the approved construction documents, referenced
25 standards and applicable provisions of law and for which site the work is being fabricated prior
26 to fabricating any items for such project.

27 **§28-116.6.2 Fabricator’s certificate of compliance.** For all fabricated items, the approved
28 fabricator shall submit a certificate of compliance to the department stating that the work was
29 performed in accordance with the approved construction documents, referenced standards and
30 applicable provisions of law.

31 **§28-116.7 Post-construction stormwater management facilities.** The department shall not issue
32 a certificate of occupancy or letter of completion with respect to a building or premises that is part
33 of a covered development project unless the applicant submits proof that the department of
34 environmental protection has issued a stormwater maintenance permit for any post-construction
35 stormwater management facilities serving such building or premises.

36 **ARTICLE 117**
37 **PLACES OF ASSEMBLY**

38 **§28-117.1 Place of assembly certificate of operation.** It shall be unlawful to use or occupy any
39 building or space, including an outdoor space, as a place of assembly without a certificate of

1 operation issued by the commissioner. An application for a certificate of operation shall be made to
2 the department in such form and containing such information as the commissioner shall provide. The
3 department shall inspect every place of assembly space prior to the issuance of a certificate of
4 operation. The commissioner shall not issue a certificate of operation unless the department
5 determines that the space conforms substantially to the approved construction documents and to this
6 code or the 1968 building code as applicable and that the certificate of occupancy authorizes such
7 use. A certificate of operation shall not be issued to a place of assembly providing seating or other
8 moveable furnishings unless the commissioner approves a plan conforming to this code or the 1968
9 building code as applicable and the rules of the department. Seating and other moveable furnishings
10 shall be maintained at all times during occupancy in accordance with the approved plan. Any
11 amendment of such plan shall be subject to the prior approval of the commissioner.

12 **§28-117.1.1 Contents of the place of assembly certificate of operation.** The certificate of
13 operation shall contain the place of assembly certificate number, the number of persons who may
14 legally occupy the space and any other information that the commissioner may determine. Such
15 certificate of operation shall be framed and mounted in a location that is conspicuously visible
16 to a person entering the space. For the purposes of this article, a department issued place of
17 assembly permit or place of assembly certificate of operation shall be valid until its expiration,
18 at which time a new place of assembly certificate of operation shall be required in accordance
19 with the provisions of this article and with the filing requirements of the department.

20 **§28-117.1.2 New certificate required.** The following changes to a place of assembly shall
21 require a new place of assembly certificate of operation instead of an amendment filed in
22 accordance with section 28-117.1.3:

- 23 1. For a department issued place of assembly permit or place of assembly certificate of
24 operation that does not have a nine-digit job number, any change of zoning use group,
25 assembly occupancy group A-1 through A-5, or any of the changes set forth in section
26 28-117.1.3.
- 27 2. For all other department issued place of assembly permits or place of assembly
28 certificates of operation, any change of zoning use group or assembly occupancy group
29 A-1 through A-5.

30 **§28-117.1.3 Amendments.** No change shall be made to a place of assembly that is inconsistent
31 with the most recently issued place of assembly certificate of operation or renewal unless an
32 amendment to such certificate is filed with and approved or accepted by the department. Changes
33 that require an amendment include any of the following:

- 34 1. Any physical change requiring an alteration permit to be issued by the department.
- 35 2. Any amendment to the plan for seating and other moveable furnishing, in accordance
36 with section 28-117.1.
- 37 3. Any change to the name of the establishment.

38 **§28-117.2 Temporary place of assembly certificate of operation.** At the commissioner's discretion,
39 a temporary certificate of operation may be issued for a place of assembly space upon request by the
40 applicant in accordance with this code provided that public safety is not jeopardized thereby. The

1 applicant shall notify the fire department when a temporary place of assembly certificate of operation
2 is issued.

3 **Exception.** Applications for temporary certificates of operation for place of assembly space in
4 prior code buildings shall be permitted to comply with the 1968 building code provided that
5 public safety is not jeopardized thereby.

6 **§28-117.3 Duration of certificate.** A place of assembly certificate of operation shall be issued by
7 the department and shall be effective for one year after its issuance. Thereafter, such certificate shall
8 be effective only for periods of time during which there is in effect an annual place of assembly
9 permit issued by the fire department pursuant to section 105.6 of the New York city fire code.

10 **§28-117.4 Security guards.** In the case of a certificate holder that offers for sale food and/or
11 beverages for on-premises consumption, but not including establishments operated by a not-for-
12 profit corporation, and employs or uses the services of a security guard, as that term is defined in
13 subdivision ~~[six]~~ 6 of section ~~[eighty nine]~~ 89 of the New York state general business law, such
14 certificate holder shall comply with the provisions of article 7-A of the general business law, shall
15 obtain proof that such security guard is registered pursuant to article 7-A of the New York state
16 general business law, shall maintain such proof in a readily available location, in accordance with
17 rules promulgated by the commissioner during all hours in which such place of assembly is open to
18 the public, shall maintain a roster of all security guards working at any given time when such place
19 of assembly is open to the public, and shall require each security guard to maintain on his or her
20 person proof of registration at all times when on the premises.

21 **§28-117.4.1 Presumption.** For purposes of this section, there shall be a rebuttable presumption
22 that a person employed or whose services are retained at a place of assembly is a security guard
23 if his or her job functions include:

- 24 1. The monitoring or guarding of the entrance or exit of such place of assembly to manage
25 ingress and egress to such place of assembly for security purposes during the hours of
26 operation of such establishment; and/or
27 2. Protection of such place of assembly from disorderly or other unlawful conduct by
28 patrons of such place of assembly.

29 **§28-117.4.1.1 Presumption not applicable to owner.** The rebuttable presumption in section
30 28-117.4.1 shall not apply to an individual who is an owner of the establishment as described
31 in section 28-117.4 that has received a place of assembly certificate of operation.

32 **§28-117.4.2 Responsibility for violations.** Notwithstanding any provision of this section, only
33 the holder of a certificate of operation shall be liable for violations of this article that relate to
34 such holder's obligations regarding security guards.

35 **§28-117.4.3 Enforcement.** In addition to employees of the department, employees of the police
36 department and the department of consumer affairs shall have the authority to enforce the
37 provisions of this article regarding security guards.

38 **§28-117.4.4 State liquor authority reporting.** The enforcement agency shall report any
39 violation of the provisions of this section relating to security guards to the state liquor authority

1 if the holder of the certificate of operation holds a license pursuant to the alcoholic beverage
2 control law.

3 **§28-117.5 Outdoor places of assembly.** The commissioner shall not issue a certificate of operation
4 to an outdoor temporary or permanent place of assembly, including, but not limited to, tents,
5 platforms, stages and outdoor assembly seating, unless the department determines that the space
6 complies with the provisions of the code.

7 **ARTICLE 118**
8 **CERTIFICATES OF OCCUPANCY**

9 **§28-118.1 General provisions.** No building or open lot shall be used or occupied without a
10 certificate of occupancy issued by the commissioner. Issuance of a certificate of occupancy shall not
11 be construed as an approval of a violation of the provisions of this code or of other applicable laws
12 and rules.

13 **§28-118.2 New buildings or open lots.** No building hereafter constructed or open lot shall be
14 occupied or used, in whole or in part, unless and until a certificate of occupancy shall have been
15 issued certifying that such building or open lot conforms substantially to the approved construction
16 documents and the provisions of this code and other applicable laws and rules.

17 **§28-118.3 Completed buildings or open lots.** The provisions of sections 28-118.3.1 through 28-
18 118.3.4 shall apply to completed buildings or open lots.

19 **Exception:** The provisions of sections 28-118.3.1 and 28-118.3.2 shall not be interpreted to
20 require an issuance of a new or amended certificate of occupancy for a change from a mercantile
21 establishment to a business establishment, or from a business establishment to a mercantile
22 establishment, provided all the following criteria are met:

- 23 1. Such alteration is limited to a change within the same zoning use group;
- 24 2. The maximum occupant load for the individual establishment, both as existing and
25 proposed, does not exceed 74 persons based on occupant load calculations in accordance
26 with Table 6-2 of the 1968 building code or Table 1004.1.3 of the New York city building
27 code, as applicable;
- 28 3. The establishment is located on the ground floor, accessed by the public directly from the
29 exterior of the building;
- 30 4. The establishment undergoing alteration complies or is made to comply with any other
31 requirements that would be applicable to the alteration, including but not limited to
32 accessibility, and fire protection requirements pursuant to sections 901.9.2 and 1101.3.1
33 of the New York city building code;
- 34 5. Such alteration does not require a change in the required exits. Relocation of exit doors
35 of the same size or larger shall not constitute a change in the required exits; and
- 36 6. Such alteration does not require a change in the live load from that stated on the existing
37 certificate of occupancy.

1 **§28-118.3.1 Change of occupancy or use.** No building, open lot or portion thereof hereafter
2 altered so as to change from one occupancy group to another, or from one zoning use group to
3 another, either in whole or in part, shall be occupied or used unless and until the commissioner
4 has issued a certificate of occupancy certifying that the alteration work for which the permit was
5 issued has been completed substantially in accordance with the approved construction documents
6 and the provisions of this code and other applicable laws and rules for the new occupancy or use.

7 **§28-118.3.2 Changes inconsistent with existing certificate of occupancy.** No change shall be
8 made to a building, open lot or portion thereof inconsistent with the last issued certificate of
9 occupancy or, where applicable, inconsistent with the last issued certificate of completion for
10 such building or open lot or which would bring it under some special provision of this code or
11 other applicable laws or rules, unless and until the commissioner has issued a new or amended
12 certificate of occupancy.

13 **§28-118.3.2.1 Changes in the address, block, lot, or zoning lot.** When changes are made in
14 the address of ~~[the structure]~~ a building or open use, the block and/or lot numbers, or the metes
15 and bounds of the zoning lot that are inconsistent with that indicated on a certificate of
16 occupancy, the owner shall obtain a new or amended certificate of occupancy within one year
17 of such change. For purposes of this section:

- 18 1. The date of change in the metes and bounds of the zoning lot shall be the date of the
19 approval of construction documents for any new building or enlargement on the zoning
20 lot, as per article 104 following the reporting required in section 28-104.7.18;
- 21 2. The date of the change of the address or the block and/or lot numbers shall be the
22 date such change is made effective by the borough president or the department of
23 finance.

24 **§28-118.3.3 Zoning lot change not inconsistent with existing certificate of occupancy.** Where
25 metes and bounds of the zoning lot have been changed after the effective date of the local law that
26 added this section and construction documents are approved for a new building or enlargement
27 within such metes and bounds, an owner of a tax lot within such metes and bounds with a
28 certificate of occupancy that does not indicate zoning lot metes and bounds shall file an
29 application with the department notifying it of the amended metes and bounds, including the city
30 registration file number (CRFN) numbers of the related zoning lot exhibits, and obtain approval
31 and sign off within one year from the date of such change in metes and bounds. For purposes of
32 this section, the date of change in the metes and bounds of the zoning lot shall be the date of the
33 approval of construction documents for any new building or enlargement on the zoning lot, in
34 accordance with article 104 following the reporting required in section 28-104.7.18.

35 ~~[§28-118.3.3]~~ **§28-118.3.4 Changes to exits.** No building hereafter altered so as to cause a major
36 alteration to existing exits shall be occupied or used unless and until the commissioner has issued
37 a certificate of occupancy certifying that the alteration work for which the permit was issued has
38 been completed substantially in accordance with the approved construction documents and the
39 provisions of this code and other applicable laws and rules.

40 ~~[§28-118.3.4]~~ **§28-118.3.5 Existing buildings or open lots without certificates of occupancy.**
41 A building or open lot in existence prior to January 1, 1938 and heretofore legally used or
42 occupied without a certificate of occupancy or, if applicable, a certificate of completion, and

1 subject to the provisions of section 28-102.4 (continuation of lawful existing use), may continue
2 to be used or occupied without a certificate of occupancy or, if applicable, a certificate of
3 completion, ~~[pursuant to the requirements of section six hundred forty five of the New York city~~
4 ~~charter, this code and other applicable laws and rules]~~ provided such use or occupancy is not
5 inconsistent with the records of the department relating to the lawful use of such building or open
6 lot, and complies with applicable laws and rules, and provided there is no change in the existing
7 use or occupancy classification of the building, open lot or portion thereof.

8 **§28-118.3.5.1 Zoning lot change.** Where metes and bounds of a zoning lot have been changed
9 after the effective date of this code for a building or open lot in existence prior to January 1,
10 1938 and heretofore legally used or occupied without a certificate of occupancy, the owner
11 shall file an application with the department notifying it of such change in metes and bounds,
12 including the CRFN numbers of the related zoning lot exhibits, and obtain approval and sign
13 off within one year from the date of the change in metes and bounds of the zoning lot. For
14 purposes of this section, the date of change in the metes and bounds of the zoning lot, shall be
15 the date of the approval of construction documents for any new building or enlargement on
16 the zoning lot, as per article 104 following the reporting required in section 28-104.7.18.

17 ~~[§28-118.3.4.1]~~ **§28-118.3.5.2 Application for certificate of occupancy.** Upon application
18 by the owner of such a building or open lot in existence prior to January 1, 1938, the com-
19 missioner shall issue a certificate of occupancy for such building, provided that at the time
20 of issuing such certificate, such existing building is in compliance with all retroactive
21 requirements of the 1968 building code applicable to such building and no notices of
22 violation or other notices or orders affecting the building as they relate to the provisions of
23 this code or the 1968 building code are pending before the department, and provided further
24 that it is established to the satisfaction of the commissioner, after inspection and
25 investigation, that the alleged use and occupancy of the building has heretofore legally
26 existed.

27 ~~[§28-118.3.4.2]~~ **§28-118.3.5.3 Partial certificates of occupancy.** Partial certificates of
28 occupancy may be issued pursuant to section ~~[28-118.16]~~ 28-118.20.

29 **§28-118.4 Applications for certificates of occupancy.** All applications for certificates of occupancy
30 shall be submitted on forms furnished by the department. Applications for new buildings or additions
31 to buildings shall be accompanied by an accurate and complete final lot survey made by a land
32 surveyor showing such information as prescribed by the commissioner. The commissioner may
33 waive the requirement of such survey in the case of small sheds, stands, temporary structures, signs,
34 and similar small structures.

35 **§28-118.4.1 Applicant.** The application for a certificate of occupancy shall be made by or on
36 behalf of the owner of the building or open lot; and if made by a person other than the owner,
37 the application shall be accompanied by a signed statement of the applicant stating that the
38 applicant is authorized by the owner to make the application. The full names and addresses of
39 the owner, and applicant, and of the principal officers thereof, if a corporation, shall be stated in
40 the application.

41 **§28-118.4.2 Statement of compliance.** When a certificate of occupancy for a new or altered
42 building is applied for, the application shall be accompanied by a signed statement of the
43 registered design professional of record or ~~[permit holder]~~ permittee, stating that such person has

1 examined the approved construction documents and specifications of the building for which the
2 certificate of occupancy is sought, and that, to the best of his or her knowledge and belief, the
3 building has been erected or altered in accordance with the approved construction documents
4 and specifications and, as erected or altered, complies with the provisions of this code and all
5 other applicable laws and rules, except insofar as variations or variances therefrom have been
6 legally permitted or authorized, specifying such variations or variances in such required
7 statement.

8 **28-118.4.3 Timeframe for application.** The application for the certificate of occupancy must be
9 submitted within six months of the final construction inspection. The department may refuse to
10 issue a certificate of occupancy where the final inspection was completed more than six months
11 prior to such application.

12 **§28-118.5 Review of applications for certificates of occupancy.** All applications for certificates of
13 occupancy and accompanying submittal documents shall be examined promptly after their
14 submission. If the building is entitled to the certificate of occupancy applied for, the application shall
15 be approved and the certificate of occupancy issued by the commissioner within 10 calendar days
16 after submission of a complete application. Otherwise, the application shall be rejected and written
17 notice of rejection, stating the grounds of rejection, shall be given to the applicant within 10 calendar
18 days of the submission of the application. Wherever an application has been rejected and proof is
19 thereafter submitted establishing that the grounds of rejection have been met and that the building is
20 entitled to the certificate of occupancy applied for, the application shall be approved and the
21 certificate of occupancy issued within 10 calendar days after submission of such proof.

22 **§28-118.6 Issuance of certificate of occupancy.** After the commissioner inspects the building or
23 open lot and determines that the building or open lot conforms substantially to the approved
24 construction documents and to the provisions of this code and other applicable laws and rules, the
25 commissioner shall issue a certificate of occupancy that shall contain information including, but not
26 limited to:

- 27 1. The building permit number.
- 28 2. The address of the structure.
- 29 3. Block and lot numbers pertaining to the zoning lot as of the date of issuance, as defined in
30 section 12-10 of the New York city zoning resolution.
- 31 4. The description of the structure for which the certificate is issued.
- 32 5. A statement that the described portion of the structure has been inspected for compliance
33 with the requirements of this code.
- 34 6. The name and signature of the commissioner.
- 35 7. The code under which the permit was issued.
- 36 8. The use and occupancy, in accordance with this code and the zoning resolution.
- 37 9. The type of construction as defined in this code.
- 38 10. The design occupant load of floors and spaces, including roofs.
- 39 11. Types of major fire suppression or alarm systems.

- 1 12. Any special stipulations and conditions of the building permit.
- 2 13. The maximum permissible live loads on the [~~several floors of the building~~] building floors
- 3 and roofs.
- 4 14. The number of parking spaces.

5 **§28-118.7 Pavement plan.** No certificate of occupancy shall be issued for any building or open lot
6 requiring a pavement plan pursuant to article 108 unless and until an inspection has been made to
7 show that all work necessary for compliance with the pavement plan has been completed.

8 **§28-118.7.1 Certification.** No certificate of occupancy shall be issued for any building or open
9 lot requiring a certification pursuant to article 108 unless and until the applicant, after completion
10 of construction work, inspects the sidewalk and certifies that the sidewalk is free from defects.

11 **Exception:** The commissioner may issue a certificate of occupancy if in lieu of such
12 certification the owner furnishes to the department prior to the issuance of the certificate of
13 occupancy security satisfactory to the department that the sidewalk will be installed and
14 paved or repaired within the time specified by the department.

15 **§28-118.8 Sanitary/storm water drainage.** No certificate of occupancy shall be issued until the
16 department confirms by inspection that all work relating to the installation of the part of the
17 sanitary/storm water drainage system which lies outside of such property, if and as required by
18 section 24-526 of the administrative code, has been satisfactorily completed.

19 **§28-118.9 Fire protection plan.** No certificate of occupancy shall be issued until a fire protection
20 plan, if required pursuant to article 109, has been filed and accepted.

21 **§28-118.10 Electrical work.** No certificate of occupancy shall be issued unless compliance with the
22 New York city electrical code is certified by the commissioner.

23 **§28-118.11 Certificates of compliance.** No certificate of occupancy shall be issued until certificates
24 of compliance are issued for the following types of service equipment:

- 25 1. Air conditioning and ventilation systems.
- 26 2. Elevators, escalators, moving walkways and dumbwaiters.
- 27 3. Fuel burning and fuel oil storage equipment.
- 28 4. Refrigeration systems.
- 29 5. Heating systems.
- 30 6. Boilers.

31 **§28-118.12 Place of assembly certificate of operation.** The issuance of a certificate of occupancy
32 shall not authorize the use of any space as a place of assembly unless and until the commissioner
33 thereafter issues a place of assembly certificate of operation.

34 **§28-118.13 Certificates of occupancy for air-inflated structures, air-supported structures, and**
35 **tents.** Certificates of occupancy for air-inflated structures, air-supported structures, and tents shall
36 be issued for a period not exceeding one year. Such certificates may be renewed for one-year periods

1 upon demonstration that the structure complies with all laws and rules in effect at the time of the
2 request for renewal.

3 **§28-118.14 Payment of outstanding fees and penalties.** The department may refuse to issue a
4 certificate of occupancy for a building pending payment of all outstanding fees, fines or civil
5 penalties imposed for violations of this code, the 1968 building code or other laws enforced by the
6 department at the same building.

7 **§28-118.15 Temporary certificates of occupancy.** Upon application, the commissioner is
8 authorized to issue a temporary certificate of occupancy before the completion of the entire work
9 covered by the permit, provided that the subject portion or portions of the building may be occupied
10 and maintained in a manner that will not endanger public safety, health, or welfare. The
11 commissioner may refuse to issue a temporary certificate of occupancy for a building pending
12 payment of all outstanding fees, fines or civil penalties imposed for violations of this code, the 1968
13 building code or other laws enforced by the department at the same building. The commissioner
14 shall set a time period during which the temporary certificate of occupancy is valid. The provisions
15 of section 28-118.15.1 apply only to interim certificates of occupancy. Nothing in section 28-
16 118.15.1 is intended to affect, alter or amend the commissioner's power to issue or to set time periods
17 for the expiration of temporary certificates of occupancy that are not interim certificates of occupancy.

18 **§ 28-118.15.1 Interim certificate of occupancy.** An interim certificate of occupancy may be
19 issued authorizing occupancy of a specific floor or floors of a building prior to the completion of
20 the entire work covered by a permit in accordance with this section and rules of the department,
21 subject to the following conditions:

- 22 1. The building is of noncombustible construction and protected with an automatic sprinkler
23 system;
- 24 2. Adequate means of egress are provided;
- 25 3. There are no outstanding objections relating to or affecting the occupancy of such portion
26 of the building; and
- 27 4. Upon inspection, the portion of the building is deemed safe for occupancy without reliance
28 upon temporary measures.

29
30 **Exceptions:** Section 28-118.15.1 shall not apply to:

- 31 1. Residential buildings with fewer than eight stories or fewer than four dwelling units; or
- 32 2. Non-residential buildings with fewer than five stories; or
- 33 3. Mixed-use buildings with fewer than four dwelling units; or
- 34 4. Parking structures.

35
36
37
38
39
40 **§ 28-118.15.1.1 Issuance, contents and posting of interim certificate of occupancy.** An
41 interim certificate of occupancy shall be issued after an inspection by the commissioner

1 determines that the floor or floors of the building conform substantially to the approved
2 construction documents and to the provisions of this code and other applicable laws and rules.
3 Such interim certificate of occupancy shall contain the same information as a certificate of
4 occupancy issued pursuant to section 28-118.6 and shall be posted while it is in effect in
5 accordance with section 28-118.19 and replaced when necessary in accordance with section
6 28-118.19.1.

7 **§ 28-118.15.1.2 Effective period.** An interim certificate of occupancy shall remain in effect
8 until the issuance of a certificate of occupancy for the building in accordance with section 28-
9 118.6.

10 **§ 28-118.15.2 Revocation and suspension.** The commissioner may revoke or suspend a
11 temporary certificate of occupancy, including an interim certificate of occupancy, that was issued
12 in error, or on the basis of incorrect information provided to the department, or based on
13 discontinuance of a nonconforming use pursuant to ~~[Article]~~ article V of the New York city zoning
14 resolution, in accordance with the procedures set forth in sections 28-105.10.1 and 28-105.10.2
15 for the suspension or revocation of a permit.

16 **§28-118.16 Amended certificate of occupancy.** The provisions of sections 28-118.16.1 through 28-
17 118.16.2 shall apply to amended certificates of occupancy.

18 **§28-118.16.1 Buildings exceeding three stories in height and change does not exceed 20**
19 **percent of total floor area.** Where a building exceeds three stories in height and the change does
20 not exceed 20 percent of the total floor area, an amendment to the existing certificate of occupancy
21 for such new use shall be issued by the commissioner certifying that the proposed new occupancy
22 and use conforms to the provisions of the laws governing building construction and that the
23 proposed use will not be in conflict with any provisions of the New York state labor law, New
24 York state multiple dwelling law or the zoning resolution.

25 **§28-118.16.2 Change in address of the structure, block and lot numbers or metes and bounds**
26 **of a zoning lot subsequent to the issuance of a certificate of occupancy.** Where no change is
27 made to a building, open lot or portion thereof inconsistent with the last issued certificate of
28 occupancy, an amended certificate of occupancy may be issued to reflect a change in the address
29 of the structure, block and lot numbers or the metes and bounds of the zoning lot. Notwithstanding
30 any other provisions of law, removal of violations and payments of outstanding penalties are not
31 required prior to issuance of an amended certificate of occupancy in accordance with ~~[this]~~ section
32 28-118.16.2.

33 **§28-118.17 Revocation of certificates of occupancy.** The commissioner is authorized to request, in
34 writing, pursuant to section ~~[six hundred forty five]~~ 645 of the New York city charter that the board
35 of standards and appeals or a court of competent jurisdiction revoke, vacate, or modify a certificate
36 of occupancy issued under the provisions of this code whenever the certificate is issued in error, or
37 on the basis of incorrect information provided to the department, or the nonconforming use reflected
38 on the certificate of occupancy is no longer permitted pursuant to ~~[Article]~~ article V of the New York
39 city zoning resolution. This section shall not be construed to apply to interim certificates of
40 occupancy and other temporary certificates of occupancy.

1 **§28-118.18 Record of certificates.** A record of all certificates of occupancy shall be kept by the
2 department; and copies thereof shall be furnished by the department upon request, and on the
3 payment of the fee prescribed in article 112 of this chapter. The certificate of occupancy or a copy
4 thereof shall be available for inspection at the building at all reasonable times.

5 **§28-118.19 Posting of certificates of occupancy.** The owner shall post a copy of the building's
6 certificate of occupancy, partial certificates of occupancy or temporary, including interim,
7 certificates of occupancy in accordance with this section [~~28-118.19~~], except buildings occupied
8 entirely by group R-3. [~~Buildings~~] Owners of buildings that are not required to have a certificate of
9 occupancy shall [~~be posted by the owner with~~] post a sign or placard in a form prescribed by the
10 commissioner. The certificate of occupancy or sign, as applicable, shall be permanently affixed to
11 the structure in a conspicuous location in a public hall, corridor, management office of the building
12 or as otherwise prescribed by the commissioner.

13 **§28-118.19.1 Replacement of posted certificates of occupancy and signs.** All posted
14 certificates of occupancy, partial certificates of occupancy, temporary, including interim,
15 certificates of occupancy or signs, as applicable, shall not be removed or defaced and, if lost,
16 removed or defaced, shall be immediately replaced. The commissioner may inspect or cause to
17 be inspected periodically all buildings for compliance with the provisions of this code in regard
18 to posting; and the inspection reports shall specify any violation thereof.

19 **§28-118.20 Partial certificate of occupancy.** A partial certificate of occupancy may be issued to a
20 specific floor or floors of an existing building erected prior to January 1, 1938 subject to the following
21 conditions:

- 22 1. The building does not have and is not otherwise required to have a certificate of occupancy or
23 certificate of completion, if applicable.
- 24 2. The floor or floors for which a certificate of occupancy is issued shall not constitute more than
25 50 percent of the gross floor area of the building.
- 26 3. The building is of noncombustible construction and protected with an automatic sprinkler
27 system.
- 28 4. Adequate means of egress are provided from all floors.
- 29 5. Upon inspection, the building is deemed safe for occupancy.

30 **§28-118.21 Live loads posted.** Where the live loads for which each floor or portion thereof of a
31 commercial or industrial building is or has been designed to exceed 50 psf (2.40 kN/m²), a certificate
32 of occupancy required by this article shall not be issued until such design loads shall be conspicuously
33 posted by the owner in that part of each story in which they apply, using durable signs. It shall be
34 unlawful to remove or deface such signs.

35 **Exception:** This section [~~28-118.21~~] shall not apply to prior code buildings.

36 **§28-118.22 Post-construction stormwater management facilities.** The department shall not issue
37 a certificate of occupancy with respect to a building or premises that is part of a covered development
38 project unless the applicant submits proof that the department of environmental protection has issued
39 a stormwater maintenance permit for any post-construction stormwater management facilities serving
40 such building or premises.

1 **§28-118.23 Extension, alteration or relocation of chimneys and vents.** No certificate of occupancy
2 shall be issued until all chimneys and vents required to be extended, altered or relocated by section
3 2113 of the New York city building code, section 801 of the New York city mechanical code or
4 section 501 of the New York city fuel gas code have been so modified.

5 **Exceptions:**

- 6 1. A certificate of occupancy may be issued to the new or altered taller building where
7 access is granted and conditions are observed that result in a determination that chimney
8 or vent alteration is not required and a revised chimney or vent plan is submitted pursuant
9 to section 107.18 of the New York city building code.
- 10 2. A certificate of occupancy may be issued to the new or altered taller building where one
11 or more of the chimneys or vents requiring alteration has not been altered or proven to
12 comply with the applicable requirements of the New York city fuel gas code or New York
13 city mechanical code as required when the following conditions have been met:
- 14 2.1. The owners of the affected buildings have provided their refusal of consent in
15 writing, or the owner of the affected buildings failed to grant consent after the owner
16 of the new or altered taller building has made all the required notifications to the
17 affected building owners; and
- 18 2.2. The owner of the new or taller building demonstrates to the department in the form
19 of a written statement from a registered design professional that there is no hazard
20 to the occupancy in whole or in part of the new or altered building from the
21 continued operation of the chimneys or vents in question.

22 **ARTICLE 119**
23 **SERVICE UTILITIES**

24 **§28-119.1 Connection of service utilities.** It shall be unlawful for any utility company or utility
25 corporation to supply gas to a building, place or premises in which new meters other than
26 replacement are required until a certificate of approval of gas installation from the department is
27 filed with such utility company or utility corporation. When new gas service piping has been
28 installed, it shall be locked-off by the utility company or utility corporation either by locking the gas
29 service line valve or by installing a locking device on the outside gas service line valve. The lock
30 shall not be removed until the gas meter piping (other than utility owned) and gas distribution piping
31 have been inspected and certified as required by the department of buildings as being ready for
32 service.

33 **§28-119.1.1 Gas shut-off for alterations to gas piping systems.** When alterations, extensions
34 or repairs to existing gas meter piping or gas distribution piping require the shut-off of gas flow
35 to a building, the utility company shall be notified by the owner or his or her authorized
36 representative.

37 **§28-119.2 Temporary connection.** The commissioner shall have the authority to authorize the
38 temporary connection of the building or system to the gas service utility.

39 **§28-119.3 Authority to disconnect utility service.** The commissioner may authorize disconnection
40 of gas service to the building, structure or system regulated by this code and the codes referenced in

1 case of emergency where necessary to eliminate an immediate hazard to life or property. The
2 department shall notify the local gas utility company, and wherever possible the owner and occupant
3 of the building, structure or service system of the decision to disconnect prior to taking such action.

4 **§28-119.4 Notification of gas shut-off or non-restoration after inspection.** Within 24 hours after
5 gas service to a building is shut off by a utility company or utility corporation because of a class A
6 or class B condition, as described in part 261 of title 16 of the New York codes, rules and regulations,
7 and within 24 hours after gas service is, after an inspection by such a company or corporation, not
8 restored because of such a condition, such company or corporation and the owner of such building
9 shall each provide notice to the department in a form and manner prescribed by the department.

10 **ARTICLE 120**
11 **TENANT PROTECTION PLAN**

12 **§28-120.1 Tenant protection plan.** A tenant protection plan shall be prepared and submitted for the
13 alteration, construction, or partial demolition of buildings in which any dwelling unit will be
14 occupied during construction, including newly constructed buildings that are partially occupied
15 where work is ongoing. The tenant protection plan shall be prepared by a registered design
16 professional and filed with the department. The registered design professional preparing the tenant
17 protection plan shall be retained by the general contractor performing the alteration, construction, or
18 partial demolition work. No permit shall be issued for work that requires a tenant protection plan
19 unless such plan is approved by the department. Such plan shall contain a statement signed by the
20 owner and signed by the applicant affirming that the building contains dwelling units that will be
21 occupied during construction and shall identify in sufficient detail the specific units that are or may
22 be occupied during construction, the means and methods to be employed to safeguard the safety and
23 health of the occupants throughout the construction, including, where applicable, details such as
24 temporary fire-rated assemblies, opening protectives, or dust containment procedures. Such means
25 and methods shall be described with particularity and in no case shall terms such as “code
26 compliant,” “approved,” “legal,” “protected in accordance with law” or similar terms be used as a
27 substitute for such description. The tenant protection plan must be site specific. The elements of the
28 tenant protection plan may vary depending on the nature and scope of the work but at a minimum,
29 must comply with all applicable laws and regulations, including the New York city construction
30 codes, the New York city housing maintenance code, the New York city noise control code and the
31 New York city health code, and shall make detailed and specific provisions for:

- 32 1. **Egress.** At all times in the course of construction, provision shall be made for adequate egress
33 as required by this code and the tenant protection plan shall identify the egress that will be
34 provided. Required egress shall not be obstructed at any time except where approved by the
35 commissioner.
- 36 2. **Fire safety.** All necessary laws and controls, including those with respect to occupied
37 dwellings, as well as additional safety measures necessitated by the construction shall be
38 strictly observed.
- 39 3. **Health requirements.** Specification of means and methods to be used for control of dust,
40 disposal of construction debris, pest control and maintenance of sanitary facilities shall be
41 included.

1 3.1. There shall be included a statement of compliance with applicable provisions of law
2 relating to lead and asbestos, and such statement shall describe with particularity what
3 means and methods are being undertaken to meet such compliance.

4 4. **Compliance with housing standards.** The requirements of the New York city housing
5 maintenance code, and, where applicable, the New York state multiple dwelling law shall be
6 strictly observed.

7 5. **Structural safety.** No structural work shall be done that may endanger the occupants.

8 6. **Noise restrictions.** Specification of means and methods to be used for the limitation of noise
9 to acceptable levels in accordance with the New York city noise control code shall be
10 included. Where hours of the day or the days of the week in which construction work may
11 be undertaken are limited pursuant to the New York city noise control code, such limitations
12 shall be stated.

13 7. **Maintaining essential services.** Where heat, hot water, cold water, gas, electricity, or other
14 utility services are provided in such building or in any dwelling unit located therein, the
15 tenant protection plan shall specify the means and methods to be used for maintaining such
16 services during such work in accordance with the requirements of the New York city
17 housing maintenance code. If a disruption of any such service is anticipated during the
18 work, then such plan shall specify the anticipated duration of such disruption and the means
19 and methods to be employed to minimize such disruption, including the provision of
20 sufficient alternatives for such service during such disruption. Notification of the disruption
21 must be given to all affected occupants of occupied dwelling units.

22 **Exception:** In the following instances, the tenant protection plan may be prepared and filed by
23 the registered design professional of record for the alteration, construction, or partial
24 demolition work as part of the underlying application:

- 25 1. Work in occupied one- and two-family homes.
- 26 2. Work limited to the interior of a single dwelling unit of an occupied multiple dwelling
27 with no disruption to the essential services of other units, where such dwelling is owner-
28 occupied. For a dwelling unit within a property that is owned by a condominium or held
29 by a shareholder of a cooperative corporation under a proprietary lease, the unit must
30 be occupied by the owners of record for such unit.

31 **§28-120.1.1 Public availability of tenant protection plan.** Upon issuance of a permit for
32 work containing a tenant protection plan, the department shall make the tenant protection plan
33 publicly available on its website.

34 **§28-120.1.2 Provision of copy of tenant protection plan to occupants upon request.** The
35 owner of a building undergoing work for which a tenant protection plan is required by section
36 28-120.1 shall, upon request from an occupant of a dwelling unit within such building, provide
37 such occupant with a paper copy of the tenant protection plan approved by the department.

38 **§28-120.1.3 Notice to occupants.** Upon issuance of a permit for work containing a tenant
39 protection plan, the owner shall (i) distribute a notice regarding such plan to each occupied
40 dwelling unit and (ii) post a notice regarding such plan in a conspicuous manner in the building
41 lobby, as well as on each floor within ten feet of the elevator, or in a building where there is

1 no elevator, within ten feet of or in the main stairwell on such floor. The notice shall be in a
2 form created or approved by the department and shall include:

- 3 1. A statement that occupants of the building may obtain a paper copy of such plan from
4 the owner and may access such plan on the department website;
- 5 2. The name and contact information for the site safety manager, site safety coordinator or
6 superintendent of construction required by section 3301.3 of the New York city building
7 code, as applicable, or, if there is no site safety manager, site safety coordinator or
8 superintendent of construction, the name and contact information of the owner of the
9 building or such owner's designee; and
- 10 3. A statement that occupants of the building may call 311 to make complaints about the
11 work.

12 **§28-120.2 Phased tenant protection plans.** Multiple layouts of the tenant protection features
13 enumerated in section 28-120.1 may be submitted at any time during construction operations to
14 show phased tenant protection plan designs consistent with the phase of anticipated work. Layouts
15 submitted subsequent to a previously approved tenant protection plan shall constitute an
16 amendment to such plan. Such amended plan shall be approved by the department prior to the
17 commencement of the work requiring such amended plan.

18 **§28-120.3 Contractor statement.** The permit holder for the underlying alteration, construction,
19 or partial demolition shall sign a statement certifying that the tenant protection plan submitted by
20 the registered design professional coordinates with the scope of work intended.

21 **Exception:** This statement shall not be required for:

- 22 1. Work in occupied one- and two-family homes.
- 23 2. Work limited to the interior of a single dwelling unit of an occupied multiple dwelling
24 with no disruption to the essential services of other units, where such dwelling is owner
25 -occupied. For a dwelling unit within a property that is owned by a condominium or
26 held by a shareholder of a cooperative corporation under a proprietary lease, the unit
27 must be occupied by the owners of record for such unit.

28 § 2. Chapter 2 of title 28 of the administrative code of the city of New York, as added
29 by local law number 33 for the year 2007, section 28-201.2.1 as amended by, and section 28-204.1.1
30 as added by, local law 196 for the year 2017, section 28-201.2.2 as amended by local law 33 for the
31 year 2018, section 28-201.2.3 as added by local law 47 for the year 2012, sections 28-201.3.1, 28-
32 204.3, 28-204.4, 28-204.6.3, 28-205.1.2.3, 28-207.4.2, 28-207.4.3, 28-207.5, 28-207.5.1, 28-211.1,
33 28-211.2, 28-212.10, 28-214.1, 28-215.1, 28-215.4, 28-215.6, 28-215.8, 28-216.2, 28-216.3, 28-
34 216.3.1, 28-216.4, 28-216.5, 28-216.6.1, 28-216.6.3, 28-216.6.4, 28-216.7.3, 28-216.8.3.1, 28-
35 216.8.3.3, 28-216.8.4, 28-216.9, 28-217.1, 28-217.1.1, 28-217.1.2, 28-217.1.3, 28-217.1.4, 28-
36 217.1.5, 28-217.1.6, 28-217.1.7, 28-218.1, 28-218.2, 28-218.3, 28-218.4, 28-218.5, 28-218.6, 28-
37 216.7 as amended by, and sections 28-207.2.5 and 28-207.4.4 as added by, local law 141 for the year
38 2013, section 28-202.1 as amended by, and sections 28-202.4 and 28-202.4.1 as added by, local law
39 70 for the year 2018, sections 28-202.3 and 28-202.3.1 as added by local law 205 for the year 2017,
40 section 28-203.1 as amended by local law 203 for the year 2017, sections 28-204.2 as amended by
41 local law 34 for the year 2008, section 28-204.6 as amended by local law 153 for the year 2017,

1 section 28-204.6.1 as added by local law 152 for the year 2017, section 28-207.2.6 as amended by
2 local law 157 for the year 2017, sections 28-207.2.4, 28-207.2.4.1, and 28-211.1.2 as added by local
3 law 8 for the year 2008, section 28-207.4 as amended by local law 150 for the year 2017, section 28-
4 210.1.1 as added by local law 94 for the year 2017, section 28-210.2 as added by local law 37 for the
5 year 2007, section 28-210.3 as added by local law 45 for the year 2012, section 28-210.3.1 as added
6 by local law 87 for the year 2017, sections 28-213.1.1 and 28-213.1.2 as amended by local law 156
7 for the year 2017, sections 28-213.5, 28-213.5.1, 28-213.5.2, and 28-213.5.3 as added by local law
8 155 for the year 2017, sections 28-213.6 and 28-213.7 as added by local law 158 for the year 2017,
9 sections 28-219.1, 28-219.2, 28-219.2.1, 28-219.2.2, and 28-219.3 as amended by local law 51 for
10 the year 2014, and section 28-219.4 as added by local law 101 for the year 2015, is amended to read
11 as follows:

12 **CHAPTER 2**

13 **ENFORCEMENT**

14 **ARTICLE 201**
15 **GENERAL**

16 **§28-201.1 Unlawful acts.** It shall be unlawful to erect, construct, alter, extend, repair, fail to
17 maintain, move, remove, demolish, occupy, use or operate any building, structure, premises, or
18 equipment, or to conduct any subject matter regulated by this code or by the zoning resolution, or to
19 cause same to be done, in conflict with or in violation of any of the provisions of this code, the
20 zoning resolution, or the rules of the department or, with regard to existing buildings, any applicable
21 provision of the 1968 building code or any other law or rule enforced by the department. It shall be
22 unlawful to fail to comply with an order of the commissioner or to violate any order of the com-
23 missioner issued pursuant to this code, the 1968 building code, the zoning resolution or any law or
24 rule enforced by the department.

25 **§28-201.2 Classification of violations.** The commissioner shall promulgate rules classifying all
26 violations of this code, the zoning resolution or, with regard to existing buildings, the 1968 building
27 code or other laws or rules enforced by the department as immediately hazardous violations, major
28 violations or lesser violations unless the classification of such violations is specifically directed by
29 this code. Such classification shall be based on the effect of the violation on life, health, safety or
30 the public interest or the necessity for economic disincentive.

31 **§28-201.2.1 Specified immediately hazardous violations.** The commissioner shall classify the
32 following violations as immediately hazardous:

33 1. With respect to violations of article 210 of this chapter:

34 1.1. A violation of section 28-210.1 in which a building legally approved for
35 occupancy as a one-family or two-family dwelling (as set forth in the certificate
36 of occupancy or if no certificate of occupancy is required, as evidenced by official
37 records) is illegally converted to or maintained as a dwelling for occupancy by
38 four or more families [§]; or

39 1.2. A violation of sections 28-210.1 and 28-210.2 in any building involving the illegal
40 conversion, maintenance or occupancy of three or more dwelling units than are

- 1 legally authorized by the certificate of occupancy or if no certificate of occupancy
2 is required as evidenced by official records.
- 3 2. Any violation of section 28-211.1 false statement;
 - 4 3. Any violation of a stop work order or of a cease use order;
 - 5 4. Any violation of a vacate order or order to seal, secure and close, or closure order;
 - 6 5. Unlawful demolition;
 - 7 6. Falsely impersonating an employee or authorized representative of the department;
 - 8 7. Occupancy without a required certificate of occupancy;
 - 9 8. Intentional disobedience or violation of any provision of a closure order;
 - 10 9. Submittal of a materially false or misleading professional certification.
 - 11 10. A violation of section 28-212.11.
 - 12 11. A violation of section 28-307.1.
 - 13 12. A violation by a licensed rigger or person performing the functions and duties of a
14 licensed rigger of the provisions of sections 28-404.1 or 28-401.9 of this code or such
15 person's failure to ensure that workers have certificates of fitness required pursuant to
16 this code or applicable rule or any person's violation of the provisions of ~~[section]~~
17 sections 3314.4.3.1 and 3314.4.3.4 of the New York city building code.
 - 18 13. A violation of any provision of chapter 4 of this title for engaging in any business or
19 occupation without a required license or other authorization or a violation of section
20 27-3017 for performing electrical work without a required license.
21 ~~[13.2—The minimum civil penalty that shall be imposed for a violation of section 27-~~
22 ~~3017 of this code and the minimum fine that shall be imposed for a violation of~~
23 ~~such section shall be \$4,800. The maximum fine that shall be imposed for a~~
24 ~~violation of such section shall be \$25,000. Such violation may also be punished,~~
25 ~~in addition to or instead of such fine, by imprisonment of not more than one year.]~~
 - 26 14. Any person who knowingly permits or causes a violation of ~~[paragraph] section~~
27 3314.4.5 or ~~[paragraph] section 3314.4.6 [of subdivision 3314.4 of section BC 3314]~~
28 of the New York city building code.
 - 29 15. A violation of sections 3303.4.5 and 3303.4.6 of the New York city building code.
 - 30 16. A violation of section 28-210.3 that involves more than one dwelling unit or a second
31 or subsequent violation of section 28-210.3 by the same person at the same dwelling
32 unit or multiple dwelling.
 - 33 17. A violation of sections 28-119.1 or 28-119.1.1.
 - 34 18. A violation of section ~~[105.2]~~ 106.2 of the New York city fuel gas code relating to work
35 on a gas piping system.
 - 36 19. A violation of sections 406.6.2, 406.6.2.1, 406.6.2.2, 406.6.2.3 or 406.6.3 of the New
37 York city fuel gas code.
 - 38 20. A second or subsequent violation of section 3321.1 of the New York city building code.

1 21. A violation of sections 28-401.19(1), 28-401.19(2), 28-401.19(3), 28-401.19(4), 28-
2 401.19(6), 28-401.19(7), 28-401.19(10), 28-401.19(11) or 28-401.19(15).

3 **§28-201.2.2 Specified major violations.** The commissioner shall classify the following
4 violations as major violations:

- 5 1. A violation of section 28-210.1 or 28-210.2 other than a violation that is directed to be
6 classified as immediately hazardous.
- 7 2. Failure to perform required façade, retaining wall, elevator and boiler inspections, or
8 tests, structural inspections of buildings and structures that are potentially compromised
9 as defined in section 28-217.1, and to file required reports within the applicable time
10 period.
- 11 3. Failure to provide the notice required by section [~~3314.1.1~~] 3314.4.1.5 of the New York
12 city building code.
- 13 4. A violation of the zoning resolution by any person for causing damage to or removing a
14 tree within a Special Natural Area District, as defined in the zoning resolution.
15 4.1. The fine or civil penalty for a violation described in item 4 shall be not less than
16 [~~seven hundred fifty dollars~~] \$750 for each tree damaged or removed.
- 17 5. Notwithstanding the provisions of section 28-204.2 of this code, a violation of item 3 or
18 item 4 of section [~~1008.1.3.5~~] 1010.1.4 of the New York city building code except that
19 no penalty for such violation shall be imposed if the respondent corrects the condition
20 constituting the violation and files a certificate with the department that the condition has
21 been corrected within [~~ninety~~] 90 days from the date set forth in the notice of violation.
22 It shall be an affirmative defense that the nonconforming security grille was installed
23 prior to July 1, 2011.
24 5.1. The fine or civil penalty for a violation described in item 5 shall be not less than
25 two hundred fifty dollars for the first offense and not less than [~~one thousand~~
26 ~~dollars~~] \$1,000 for each subsequent offense.
- 27 6. A violation of a condition, restriction or requirement established pursuant to the zoning
28 resolution, section 197-d of the charter or section 25-114, related to a privately owned
29 public space as such term is defined in section 25-114.

30 7. A violation of section 28-309.12.

31 **§28-201.2.3 Specified lesser violations.** The commissioner shall classify the following
32 violations as lesser violations:

- 33 1. A violation of item 5 of section [~~1110.1~~] 1111.1, of section [~~1110.2~~] 1111.2, or of item 7
34 of section [~~1110.3~~] 1111.3 of the New York city building code, or a violation of section
35 28-313.1, 28-313.2 or 28-313.3 of the administrative code of the city of New York.

36 **§28-201.3 Methods of enforcement.** The commissioner may use any of the methods set forth in
37 this code to enforce compliance with this code, the 1968 building code, the zoning resolution, other
38 laws or rules enforced by the department and orders of the commissioner issued pursuant thereto
39 including but not limited to:

- 1 1. Proceedings for the recovery of civil penalties for immediately hazardous, major and lesser
2 violations before the environmental control board or other administrative tribunal.
- 3 2. Civil judicial proceedings for the recovery of civil penalties or injunctive relief or both for
4 immediately hazardous, major and lesser violations.
- 5 3. Criminal judicial proceedings for the imposition of criminal fines or imprisonment or both
6 for immediately hazardous, major and lesser violations.
- 7 4. The issuance and enforcement of peremptory orders for immediately hazardous, major and
8 lesser violations.
- 9 5. The issuance of a commissioner's request for correction of an unlawful use or condition or
10 order to correct an unlawful use or condition.
- 11 6. Other special remedies as set forth in this code, the zoning resolution or other law or rule.

12 **§28-201.3.1 Issuance.** Officers and employees of the department and of other city agencies
13 designated by the commissioner shall have the power to issue summonses, appearance tickets,
14 orders and notices of violation based upon violations of this code, the 1968 building code, the
15 zoning resolution or other laws or rules enforced by the department, orders, and requests for
16 corrective action.

17 **§28-201.4 Aggravating and mitigating factors.** Civil penalties and criminal fines and
18 imprisonment shall be imposed within the ranges set forth in this code or as otherwise specified in
19 this code or other law, with due regard for mitigating and aggravating factors.

20 **ARTICLE 202**
21 **CIVIL PENALTIES**

22 **§28-202.1 Civil penalties.** Except as otherwise specified in this code or other law, violations of this
23 code, the 1968 building code, the zoning resolution or other laws or rules enforced by the department
24 shall be punishable by civil penalties within the ranges set forth below:

- 25 1. For immediately hazardous violations, a civil penalty of not less than [~~one thousand dollars~~]
26 \$2,500 nor more than \$25,000 may be imposed for each violation. In addition to such civil
27 penalty, a separate additional penalty may be imposed of not more than \$1,000 for each day
28 that the violation is not corrected. The commissioner may by rule establish such specified daily
29 penalties.
- 30 2. For major violations, a civil penalty of not less than \$1,000 nor more than \$10,000 may be
31 imposed for each violation. In addition to such civil penalty, a separate additional penalty may
32 be imposed of not more than \$250 for each month that the violation is not corrected. The
33 commissioner may by rule establish such specified monthly penalties.
- 34 3. For lesser violations, a civil penalty of not more than \$500 may be imposed for each
35 violation.

36 [~~Exceptions:~~] **Exceptions:**

- 1 1. The owner, lessee, occupant, manager or operator of a building affected by a natural or
2 man-made disaster, as determined by the commissioner, shall not be subject to a civil
3 penalty for a violation involving such building if (i) notice of such violation is issued
4 by the department during the 90-day period immediately after such disaster or, in the
5 case of a major natural or man-made disaster as determined by the commissioner,
6 during the six-month period immediately after such disaster, and (ii) such violation is
7 corrected on or before 40 days after such disaster period or such greater amount of time
8 as determined by the commissioner for such violation. The notice of such violation shall
9 state that such violation is subject to this exception and shall set forth the procedure and
10 time period for correcting such violation without incurring a civil penalty. This
11 exception shall not apply to immediately hazardous violations, violations charged as
12 aggravated violations or violations without connection to such disaster, as determined
13 by the department.
- 14 2. The owner, lessee, occupant, manager or operator of a building where a violation occurs
15 shall not be subject to a civil penalty for such violation if (i) such violation was
16 connected to a natural or man-made disaster, as determined by the commissioner, and
17 (ii) such building is undergoing, or scheduled or under evaluation for, work or
18 acquisition through a city-operated disaster recovery program responding to such
19 disaster.
- 20 3. The owner, lessee, occupant, manager or operator of a building shall not be subject to
21 a civil penalty for a violation resulting from work done by a city employee, or by a third
22 party under contract with the city, in response to a natural or man-made disaster,
23 provided that such violation is corrected on or before 60 days after the issuance of such
24 violation, or such greater amount of time as determined by the commissioner for such
25 violation. If such owner, lessee, occupant, manager or operator of a building can
26 demonstrate to the satisfaction of the department that a city employee or third party
27 under contract with the city has committed to correcting such violation then such
28 violation shall be rescinded, without penalty. The notice of such violation shall state
29 that such violation is subject to this exception and shall set forth the procedure and time
30 period for correcting such violation without incurring a civil penalty. This exception
31 shall not apply to immediately hazardous violations or violations charged as aggravated
32 violations.
- 33 4. The minimum civil penalty for a violation of section 28-408.1 or section 28-410.1 of
34 this code shall be \$2,500 for a first violation and \$5,000 for a second violation, in
35 addition to any separate daily penalty imposed pursuant to item 1 of this section.
- 36 ~~4. The minimum civil penalty for a violation of section 28-408.1 or section 28-410.1 of~~
37 ~~this code shall be \$2,500 for a first violation and \$5,000 for a second violation, in~~
38 ~~addition to any separate daily penalty imposed pursuant to item 1 of this section.]~~
- 39 5. The minimum civil penalty for a violation of section 28-103.21.1 of this code shall be
40 \$2,500, in addition to any separate daily or monthly penalty imposed pursuant to item
41 1 or 2 of this section.

- 1 6. The minimum civil penalty for a violation of section 3321.1 of the New York city building
2 code shall be \$5,000. The department may by rule provide that, for a first violation of such
3 section or a first set of such violations that occur substantially at the same time, the
4 minimum penalty may be reduced to \$2,500.
- 5 7. The minimum civil penalty for a violation of section 3321.2 of the New York city building
6 code shall be \$2,500.
- 7 8. A violation of a condition, restriction or requirement established pursuant to the zoning
8 resolution, section 197-d of the charter or section 25-114, related to a privately owned
9 public space as such term is defined in section 25-114, shall be subject to a civil penalty
10 of not less than \$4,000 for the first offense and not less than \$10,000 for each subsequent
11 offense, in addition to any separate monthly penalty imposed pursuant to item 2 of this
12 section.
- 13 9. For a violation of section 28-210.1:
- 14 9.1. Unless exception ~~[5-2]~~ 9.2 applies, the minimum civil penalty for a violation of
15 section 28-210.1 in any building involving the illegal conversion, maintenance or
16 occupancy of three or more dwelling units above the number of dwelling units that
17 is legally authorized by the certificate of occupancy or if no certificate of occupancy
18 is required as evidenced by official records shall be \$15,000. Each dwelling unit
19 above the number that is legally authorized by the certificate of occupancy or if no
20 certificate of occupancy is required as evidenced by official records shall constitute
21 a separate offense that shall be charged separately and shall be punishable by a
22 separate civil penalty. Provided, however, that the penalties for multiple violations
23 of this exception may be based on the same evidence; and
- 24 9.2. The owner of a building shall not be subject to a civil penalty for a violation of
25 section 28-210.1 in such building if such owner can show the following:
- 26 9.2.1. Such violation was the first such violation issued for such building or was
27 issued within 30 days after such first violation;
- 28 9.2.2. At the time such violation was issued or, if such violation was issued within
29 30 days after such first violation was issued, the time such first violation was
30 issued, a registration for such building has been properly filed with the
31 department of housing preservation and development in accordance with
32 article two of subchapter 4 of the New York city housing maintenance code;
33 and
- 34 9.2.3. At the time such violation was issued or, if such violation was issued within
35 30 days after such first violation was issued, the time such first violation was
36 issued, such owner reasonably did not know of, or could not reasonably have
37 known of such illegal conversion, the maintenance thereof or occupancy
38 thereof and takes lawful immediate and diligent steps to cure said violation.

1 10. For violations of article 110 of this chapter or chapter 33 of the New York city building
2 code:

3 10.1. The minimum civil penalty for an immediately hazardous violation of such article
4 or chapter shall be \$2,000, in addition to any separate daily penalty imposed pursuant
5 to item 1 of this section; and

6 10.2. The minimum civil penalty for a major violation of such article or chapter shall be
7 \$1,000, in addition to any separate monthly penalty imposed pursuant to item 2 of
8 this section.

9 11. For (i) a violation of section 28-211.1 or (ii) where a tenant protection plan is required
10 pursuant to section 28-120.1, but has not been submitted to the department, the minimum
11 civil penalty for a first offense shall be no less than \$10,000 and, for each subsequent
12 offense, no less than \$25,000.

13 12. The minimum civil penalty that shall be imposed for a violation of section 27-3017 of the
14 New York City electrical code and the minimum fine that shall be imposed for a violation
15 of such section shall be \$4,800. The maximum fine that shall be imposed for a violation
16 of such section shall be \$25,000. Such violation may also be punished, in addition to or
17 instead of such fine, by imprisonment of not more than one year.

18 **§28-202.2 Continuing violations.** Notwithstanding the assessment of daily penalties, each day that
19 a violation continues shall be a separate and distinct offense.

20 **§28-202.3 Increased civil penalties for construction sites with excessive violations.** Subject to
21 the limitations of section 28-202.1, for any violation of this code, the 1968 building code, the zoning
22 resolution or other laws or rules enforced by the department issued to a person who has an existing
23 immediately hazardous or major violation with respect to the construction site for which the violation
24 is being issued, that occurs at a construction site with a violation ratio, at the time of the issuance of
25 such violation, that exceeds the threshold violation ratio for such site, the civil penalty imposed shall
26 be at least twice the civil penalty that would be imposed if such site were not subject to this section[
27 ~~28-202.3~~]. This section [~~28-202.3~~] shall have no effect on additional monthly or daily penalties
28 imposed pursuant to section 28-202.1.

29 **Exceptions:**

30 1. Sites that are the subject of an in rem foreclosure judgment in favor of the city and were
31 transferred by the city to a third party pursuant to section 11-412.1 of the Administrative
32 code.

33 2. Sites that are the subject of a court order appointing an administrator pursuant to article
34 7-a of the New York state real property actions and proceedings law in a case brought by
35 the department of housing preservation and development.

36 3. Sites that are the subject of a loan provided by or through the department of housing
37 preservation and development or the New York city housing development corporation
38 for the purpose of rehabilitation.

1 **§28-202.3.1 Definitions.** The following words and terms shall, for the purposes of section 28-
2 202.3, have the meanings shown herein.

3 **THRESHOLD VIOLATION RATIO.** For a major building site, the ninetieth percentile of
4 violation ratios for major building sites in the city as of December 31 of the immediately
5 preceding calendar year. For a construction site that only involves work on a one-, two- or
6 three-family building, the ninetieth percentile of violation ratios for construction sites that
7 only involve work on a one-, two- or three-family building in the city as of December 31 of
8 the immediately preceding calendar year. For a construction site that is not a major building
9 site and that does not only involve work on a one-, two- or three-family building, the ninetieth
10 percentile of violation ratios for construction sites that are not major building sites and that
11 do not only involve work on a one-, two- or three-family building in the city as of December
12 31 of the immediately preceding calendar year.

13 **VIOLATION RATIO.** With respect to a construction site, (i) the number of immediately
14 hazardous violations and major violations issued against such site in the preceding 12
15 months, excluding any violations that have been dismissed or that are currently in the appeals
16 process, divided by the square footage of the footprint of such site or (ii) an alternative ratio
17 established by department rule and that the department determines is appropriate for
18 identifying construction sites with high rates of immediately hazardous violations, major
19 violations or unsafe conditions for the purposes of [this] section 28-202.3, provided that such
20 rule is promulgated on or after January 1, 2020.

21 **§28-202.4 Maximum civil penalty for immediately hazardous violation of chapter 33 of the**
22 **New York city building code that results in death or serious physical injury.** Notwithstanding
23 any inconsistent provision of this article, an immediately hazardous violation of a provision of
24 chapter 33 of the New York city building code that results in death or serious physical injury, as
25 such term is defined in article 10 of the New York state penal law, shall be punishable by a civil
26 penalty of not more than \$500,000, or not more than \$150,000 if such violation is issued to an
27 individual, which may be recovered in a civil action brought by the corporation counsel in the name
28 of the city in any court of competent jurisdiction where:

- 29 1. There was a substantial probability that the violating condition would cause death or serious
30 physical injury, as such term is defined in article 10 of the New York state penal law;
- 31 2. The defendant knew, or with reasonable diligence should have known, (i) of the existence of
32 such violation and (ii) was in a position to remedy such violation or lessen the danger posed
33 thereby; and
- 34 3. Such violation resulted in the death or serious physical injury, as such term is defined in
35 article 10 of the New York state penal law, of a person.

36 **§28-202.4.1 Determining the amount of the civil penalty to be imposed.** In determining the
37 amount of the civil penalty to be imposed the court shall consider:

- 38 1. The extent and severity of injury to persons and property;
- 39 2. The history of violations by the defendant of laws or rules enforced by the department;

- 1 3. The owner, lessee, manager or operator of a building shall not be subject to criminal fines
2 or imprisonment for a violation resulting from work done by a city employee or third party
3 under contract with the city, in response to a natural or man-made disaster. This exception
4 shall not apply to immediately hazardous violations or violations charged as aggravated
5 violations.
- 6 4. The minimum fine for an immediately hazardous violation of article 110 of this chapter or
7 chapter 33 of the New York city building code shall be \$2,000.
- 8 5. The minimum fine for a major violation of article 110 of this chapter or chapter 33 of the
9 New York city building code shall be \$1,000.
- 10 6. For (i) a violation of section 28-211.1 or (ii) where a tenant protection plan is required
11 pursuant to section 28-120.1, but has not been submitted to the department, the minimum
12 fine shall be no less than \$10,000 and, for each subsequent offense, no less than \$25,000.

13 **§28-203.2 Continuing violations.** In the case of continuing violations each day's continuance shall
14 be a separate and distinct offense.

15 **ARTICLE 204**
16 **ENVIRONMENTAL CONTROL BOARD**

17 **§28-204.1 General.** Any person who shall violate or fail to comply with any of the provisions of
18 this code, the 1968 building code, the zoning resolution or other laws or rules enforced by the
19 department or with any order issued pursuant thereto shall be liable for a civil penalty that may be
20 recovered in a proceeding before the environmental control board. Such proceeding shall be
21 commenced by the service of a notice of violation returnable before the board. Such notice of
22 violation may be issued by employees of the department or of other city agencies designated by the
23 commissioner and may be served by such employees or by a licensed process server.

24 **§28-204.1.1 Violations of section 3321 of the New York city building code.** In addition to any
25 other penalties or remedies provided by law or rule, the following items shall apply to violations
26 of section 3321 of the New York city building code:

- 27 1. Upon determining that a worker at a building site is not in compliance with section 3321.1
28 of the New York city building code:
 - 29 1.1. The commissioner shall issue a notice of violation to the owner of such site, each
30 permit holder responsible for ensuring that such worker complies with such section
31 at such site and the person who employed or otherwise engaged such worker at such
32 site if such person can reasonably be identified. Each such worker shall constitute a
33 separate violation that shall be noticed and charged separately and shall be
34 punishable by a separate civil penalty. It shall be an affirmative defense to such a
35 violation that such worker provided such owner, permit holder or the person who
36 employed or otherwise engaged such worker at such site with an SST card, SST
37 supervisor card, limited SST card, temporary SST card or documentation
38 establishing training in compliance with such section, as appropriate, that reasonably
39 appeared to be valid and applicable to such worker and such owner, permit holder or
40 such person reasonably relied thereon.

1 1.2. In addition to the requirements of any other law or rule, such violation shall not be
2 deemed corrected until the commissioner determines that, for each such worker, the
3 recipient of such violation shows, in a form and manner established by the
4 commissioner, that such owner, a person acting on behalf of such owner, a permit
5 holder responsible for ensuring that such worker complies with such section at such
6 site or the person who employed or otherwise engaged such worker at such site has
7 entered into a binding agreement that satisfies each of the following conditions:

8 1.2.1. Pursuant to such agreement, such owner, a person acting on behalf of such
9 owner or a permit holder responsible for ensuring that such worker complies
10 with such section at such site or the person who employed or otherwise
11 engaged such worker at such site shall pay, either directly or indirectly, for
12 the costs of such worker to obtain the training required to comply with such
13 section or will otherwise arrange for such worker to receive such training at
14 no cost to such worker.

15 1.2.2. Pursuant to such agreement, and provided that such worker is diligently
16 endeavoring to complete the training required by such section, such worker
17 shall continue to be employed or otherwise engaged under the same terms and
18 conditions that applied before such determination by the commissioner until
19 (i) such worker successfully completes the training required to comply with
20 such section, (ii) work for which such worker was employed or otherwise
21 engaged at such site concludes or (iii) 60 days elapses after such
22 determination, whichever occurs earlier, except that, during such period, such
23 worker shall be paid as if such worker were working at such site 40 hours each
24 week at the same hourly or effective hourly wage such worker was paid before
25 such determination by the commissioner.

26 2. Upon determining that a permit holder at a building site has not maintained a daily log in
27 compliance with section 3321.2 of the New York city building code, a notice of violation
28 shall be issued to the owner of such site and such permit holder. Failure to maintain such
29 a log establishes a rebuttable presumption that each worker for whom such permit holder
30 is responsible for ensuring compliance with section 3321 of the New York city building
31 code is not compliant with such section and shall result in the issuance of notices of
32 violation under Item 1.

33 3. Upon a finding by the office of administrative trials and hearings, acting pursuant to
34 section 1049-a of the ~~[New York city]~~ charter, or a court of competent jurisdiction that
35 a second or subsequent violation of section 3321 of the New York city building code has
36 occurred at a building site, the commissioner shall conduct at least one unannounced
37 inspection of such site at least once every three months to determine compliance with
38 such section. Such inspections shall continue until at least two consecutive inspections
39 do not result in the issuance of a notice of violation of such section.

40 4. Upon a finding by the office of administrative trials and hearings, acting pursuant to
41 section 1049-a of the ~~[New York city]~~ charter, or a court of competent jurisdiction that
42 the owner of a building site, a permit holder at such site or a person employing or
43 otherwise engaging workers at such site has violated section 3321 of the New York city
44 building code and such violation is a second or subsequent violation of such section by
45 such owner, permit holder or person, the commissioner shall conduct at least one

1 unannounced inspection of (i) each building site owned by such owner, if such violation
2 is a second or subsequent violation by such owner, (ii) each building site where such
3 permit holder works, if such violation is a second or subsequent violation by such permit
4 holder and (iii) each building site where such person works, if such violation is a second
5 or subsequent violation by such person.

6 **§28-204.1.2 Notice of violating conditions outside of occupied dwelling units.** An owner
7 must post a copy of a notice of violation that relates to a violating condition outside of an
8 occupied dwelling unit, including in a common area or affecting all residents, of such owner's
9 building in a conspicuous manner in the building's lobby until such violation has been closed.
10 In addition, such owner shall post a flyer or pamphlet, created by the department, with
11 information about the adjudication process. Such notice of violation and flyer or pamphlet shall
12 be posted as soon as practicable, but no later than five calendar days after it has been served.

13 **§28-204.1.3 Notice to occupants of violating conditions in occupied dwelling units.** An
14 owner must distribute a copy of a notice of violation to the resident of an occupied dwelling
15 unit where such violation relates to a violating condition that is present within such dwelling
16 unit, and to residents of occupied dwelling units adjacent to such dwelling unit. In addition,
17 such owner shall provide such residents with a flyer or pamphlet, created by the department,
18 with information about the adjudication process. Such notice of violation and flyer or pamphlet
19 shall be distributed to such occupied dwelling units as soon as practicable, but no later than
20 five calendar days after it has been served.

21 **§28-204.2 Order to certify correction.** Each such notice of violation shall contain an order of the
22 commissioner directing the respondent to correct the condition constituting the violation and to file
23 with the department electronically or in such other manner as the department may authorize by rule
24 a certification that the condition has been corrected. Unless otherwise provided by rule, such order
25 shall require that violations classified as major or lesser be corrected within 30 days from the date
26 of the order, that violations classified as immediately hazardous be corrected forthwith. Such order
27 shall also require that certification of the correction of the violation shall be filed with the department
28 in a manner and form and within such period of time as shall be established by the department. In
29 any proceeding before the environmental control board, no civil penalty shall be imposed for a lesser
30 violation if the respondent complies with the commissioner's order to correct and to certify
31 correction of the violation within the applicable time period. However, such violation may serve as
32 a predicate for purposes of assessing aggravating factors attributable to multiple offenses.

33 **§28-204.3 Failure of proof.** In any proceeding before the environmental control board, if [~~the board~~
34 ~~finds~~] it is found that the commissioner has failed to prove the violation charged, the order requiring
35 the respondent to correct the condition constituting the violation and to file a certification of
36 correction shall be deemed dismissed.

37 **§28-204.4 Failure to certify the correction of a violation.** Failure to comply with an order of the
38 commissioner issued pursuant to section 28-204.2 or pursuant to any provision of law or rule
39 enforced by the department in effect at the time the order was issued to correct and to certify
40 correction of a violation within the applicable time period shall be a violation of this code for which
41 penalties may be imposed in addition to the penalties that may be or have been imposed for the
42 violation referred to in such order. Upon application, for good cause, the commissioner may extend

1 the time for filing the certification of correction of a violation, but not for more than 30 days for each
2 extension.

3 **§28-204.5 False statements in certification of correction.** For the purposes of this section [~~28-~~
4 ~~204.5~~], if the environmental control board finds that a certification of correction filed pursuant to
5 section 28-204.2 contained material false statements relating to the correction of a violation, such
6 certification of correction shall be null and void and the penalties set forth in this code for the
7 violation may be imposed as if such false certification had not been filed with and accepted by the
8 department. It shall be an affirmative defense that the respondent neither knew nor should have
9 known that such statements were false.

10 **§28-204.6 Enforcement of environmental control board judgments as a [Tax] tax lien.**
11 ~~[Enforcement of]~~ Notwithstanding any provision of law to the contrary, environmental control
12 board judgments ~~[against owners]~~ shall be entered against the
13 owner and enforced as a tax lien against the property, as provided below. ~~[Notwithstanding any~~
14 ~~provision of law to the contrary, an]~~ An environmental control board judgment against an owner for
15 a building code violation with respect to (i) a private dwelling, a wooden-framed single room
16 occupancy multiple dwelling, or a dwelling with a legal occupancy of three or fewer dwelling units,
17 (ii) a violation of section 28-210.1 involving the illegal conversion, maintenance or occupancy of
18 three or more dwelling units than are legally authorized by the certificate of occupancy or if no
19 certificate of occupancy is required as evidenced by official records, (iii) a building that contains
20 twenty or more dwelling units, or that contains any space classified in an occupancy group other
21 than occupancy group R, where the total value of all such judgments against such building is \$60,000
22 or more, or (iv) a building that contains only space classified in occupancy group R and no fewer
23 than six and no more than nineteen dwelling units, where the total value of all such judgments against
24 such building is \$30,000 or more, shall ~~[constitute a tax lien on the]~~ result in a tax lien being entered
25 against the property named in the violation [with respect to] for which such judgment was rendered,
26 as hereinafter provided. ~~[Such liens shall be entered and enforced as provided in this section 28-~~
27 ~~204.6.]~~

28 **Exception.** Notwithstanding any provision of law to the contrary, an environmental control
29 board judgment shall not constitute a tax lien on the property named in the violation with
30 respect to which such judgment was rendered where:

- 31 1. Such property was the subject of an in rem foreclosures judgment in favor of the city
32 and was transferred by the city to a third party pursuant to section 11-412.1 of the
33 administrative code within five years of such judgment.
- 34 2. Such property is the subject of a court order appointing an administrator pursuant to
35 article 7-A of the New York state real property actions and proceedings law in a case
36 brought by the department of housing preservation and development.
- 37 3. Such property is the subject of a loan provided by or through the department of housing
38 preservation and development or the New York city housing development corporation
39 for the purpose of rehabilitation that had closed within five years before such judgment.

40 **§28-204.6.1 Record of unpaid judgments.** ~~[There shall be filed in the office of the]~~ The
41 department of finance shall keep a record of all such unpaid judgments. Such records shall be

1 kept by tax lot and block number and shall be accessible to the public during business hours. An
2 entry of a judgment on the records of the department shall constitute notice to all parties.

3 ~~§28-204.6.1 Tax lien reporting. On December 31, 2018, the department of finance shall~~
4 ~~submit a report to the mayor and the council on tax lien activities as a result of environmental~~
5 ~~control board judgment debt. Such report shall include: (i) the number of buildings subject to~~
6 ~~tax liens for environmental control board judgment debts, disaggregated by whether the tax~~
7 ~~lien was a result of an illegal conversion, more than \$60,000 in debt, or more than \$30,000 in~~
8 ~~debt; (ii) the location of such buildings disaggregated by council district; (iii) the number of~~
9 ~~dwelling units in each building which is subject to a tax lien; and (iv) recommendations for~~
10 ~~whether a 25 percent lien to value ratio is an appropriate threshold for a property to be~~
11 ~~considered distressed and if it is not, such report shall contain recommendations for what an~~
12 ~~appropriate threshold would be.]~~

13 **§28-204.6.2 Lien.** All such unpaid judgments shall constitute a lien upon the property named in
14 the violation with respect to which such judgment was rendered when the amount shall have
15 been definitely computed as a statement of account by the department, and the department shall
16 file such statement with the department of finance for entry against the property. Such lien shall
17 have a priority over all other liens and encumbrances except for the lien of taxes and assessments.
18 However, no lien created pursuant to [this] section 28-204.6 shall be enforced against a
19 subsequent purchaser in good faith or mortgagee in good faith unless the requirements of section
20 28-204.6.1 are satisfied.

21 **§28-204.6.3 Notice.** A notice, stating the amount due and the nature of the charge, shall be
22 mailed by the department of finance to the last known address of the person whose name appears
23 on the records of the department of finance as being the owner or agent of the property or as the
24 person designated by the owner to receive tax bills or, where no name appears, to the property,
25 addressed to either the “owner” or the “agent.”

26 **§28-204.6.4 Mailing.** Such notice mailed by the department of finance pursuant to this section
27 ~~[28-204.6.4]~~ shall have stamped or printed thereon a reference to section ~~[204.6]~~ 28-204.6.

28 **§28-204.6.5 Failure to pay charge.** If such charge is not paid within 30 days from the date of
29 entry, it shall be the duty of the department of finance to receive interest thereon at the same rate
30 as unpaid real property taxes, to be calculated to the date of payment from the date of entry.

31 **§28-204.6.6 Enforcement of lien.** Such charge and the interest thereon shall continue to be,
32 until paid, a lien on the property. Any remedy or procedure available for the enforcement of tax
33 liens against such property, including, but not limited to, any sale of a tax lien or any foreclosure
34 of a tax lien, shall be available with respect to such tax lien. In addition, such tax lien may be
35 satisfied in accordance with the provisions of section 1354 of the New York state real property
36 actions and proceedings law.

37 **§28-204.6.7 Validity of lien.** In any proceeding to enforce or discharge a lien created pursuant
38 to [this] section 28-204.6, the validity of the lien shall not be subject to challenge based on the
39 lawfulness of the judgment, except as provided in [this] section 28-204.6.

1 the object of the action is to recover a penalty for the violation of any of the provisions of this
2 code.

3 **§28-205.1.1.1 Naming the building as a defendant.** The corporation counsel shall name
4 as defendants the building, structure, or premises where the violation shall exist by describing
5 it by block, lot number, and street address and at least one of the owners of some part of or
6 interest in the building, structure, or premises.

7 **§28-205.1.1.2 In rem jurisdiction over the building.** In rem jurisdiction over the building,
8 structure, or premises where the violation shall exist shall be complete by affixing the
9 summons to the door of the building, structure, or premises and by mailing the summons by
10 certified or registered mail, return receipt requested, to one of the owners of some part of or
11 interest in the building, structure, or premises. Proof of service shall be filed within two days
12 thereafter with the clerk of the court designated in the summons. Service shall be complete
13 upon such filing.

14 **§28-205.1.1.3 Service on other defendants.** Defendants, other than the building, structure,
15 or premises where the violation shall exist, shall be served with the summons as provided in
16 the civil practice law and rules.

17 **§28-205.1.2 Presumptive evidence.** In any action or proceeding founded upon a claim by the
18 commissioner that any law or rule enforceable by the department has been violated, or that a
19 lawful order issued by such commissioner has not been complied with, the following
20 presumptions shall apply:

21 **§28-205.1.2.1 Presumption of commissioner certificate.** A certificate in writing by the
22 commissioner, or his or her authorized representative, shall be presumptive evidence of any
23 matter stated therein.

24 **§28-205.1.2.2 Presumption of ownership.** The person in whose name the real estate
25 affected by the action is recorded in the office of the city register or the county clerk, as
26 applicable, shall be presumed to be the owner thereof.

27 **§28-205.1.2.3 Presumption of employment or agency.** Whenever there is evidence that a
28 person was the manager, operator, or supervisor or, in any other way, in charge of the
29 premises, at the time the violation occurred, such evidence shall be presumptive that he or
30 she was an agent or employee of the owner and/or lessee of the building, structure, or
31 premises.

32 **§28-205.1.2.4 Presumption of electronic signature and electronic submission.** Anyone
33 who receives access to an account for electronic filing from the department shall be presumed
34 to have personally submitted or authorized the submission of all documents submitted to the
35 department from that account and to have personally electronically signed all documents
36 required to be electronically signed from such account.

37 **§28-205.1.3 Costs.** In no case shall the department, or any officer or employee thereof, be liable
38 for costs in any such action or proceeding; and officers and employees of the department, acting
39 in good faith and without malice, shall be free from liability for acts done in any such action or
40 proceeding.

1 vacate the premises pursuant to the provisions of section 28-207.4 and may also require such
2 work to be done as, in the opinion of the commissioner, may be necessary to remove any danger
3 therefrom. The police department or other law enforcement agency or officer shall, upon the
4 request of the commissioner, assist the department in the enforcement of ~~[this]~~ section 28-207.2.
5 The stop work order may be given verbally or in writing to the owner, lessee or occupant of the
6 property involved, or to the agent of any of them, or to the person or persons executing the work.
7 A verbal order shall be followed promptly by a written order and shall include the reason for the
8 issuance of the stop work order. All written orders issued pursuant to section 28-207.2 shall be
9 posted upon the premises and made available to the public.

10 **§28-207.2.2 Unlawful continuance.** No person shall with knowledge or notice of a stop work
11 order allow, authorize, promote, continue or cause to be continued any work covered by the stop
12 work order, except such work that may be required by order of the commissioner.

13 **§28-207.2.3 Rescission.** Upon application, the commissioner shall rescind the stop work order
14 when the condition that gave rise to its issuance has been corrected and either all civil penalties
15 or criminal fines assessed for any violation of such order have been paid or, where a violation is
16 pending, security for the payment of such penalties or fines has been posted in accordance with
17 department rules, or where the stop work order was issued in error or conditions are such that it
18 should not have been issued. The commissioner may by rule require the payment of a fee in the
19 amount of the expense of additional inspection and administrative expense related to such stop
20 work order.

21 **§28-207.2.4 Mandatory stop work orders.** The commissioner shall issue stop work orders in
22 the circumstances set forth below. Upon issuance of such stop work order, the work shall
23 immediately stop and shall not resume until the stop work order is rescinded by the department.
24 The stop work order shall not be rescinded less than two business days after the date of issuance
25 of such order. Nothing in the following sections shall be construed to limit the commissioner's
26 power to issue stop work orders in other circumstances.

27 **§28-207.2.4.1 Scaffold safety.** A stop work order shall be issued if a permit holder or person
28 directly in charge of any suspended scaffold supported by c-hooks or outrigger beams fails
29 to notify the department prior to the installation or use of such equipment as required by
30 section ~~[3314.1.1]~~ 3314.4.1.5 of the New York city ~~[Building]~~ building code and either:

- 31 1. The rigger does not hold a license required by this code, or
- 32 2. The workers lack certificates of fitness as required by this code or applicable rule, or
- 33 3. The rigger failed to file with the department satisfactory evidence of insurance
34 required by this code.

35 **§28-207.2.5 Tampering.** It shall be unlawful to tamper with, remove or deface a written posted
36 stop work order from the location where it was affixed unless and until such stop work order
37 has been rescinded by the commissioner. The owner or other person in control of the location
38 shall ensure that the stop work order remains posted until rescinded by the commissioner.

39 **§28-207.2.6 Penalties.** In addition to the penalties provided for in this chapter, any person who
40 fails to comply with a stop work order shall be liable for a civil penalty in the amount of \$6,000
41 for the initial violation and \$12,000 for every subsequent violation, to be paid to the department

1 prior to the rescission of the stop work order; provided, however, this shall not apply to any work
2 performed to remedy an unsafe or hazardous condition as authorized by order of the
3 commissioner.

4 **§28-207.3 Public nuisance.** Whenever any building, structure, place or premises is or may be
5 perilous to life or property by reason of the nature or condition of its contents, its use, the
6 overcrowding of persons therein, defects in its construction, or deficiencies in fire alarm, fire
7 extinguishing equipment or fire escape equipment, or by reason of any condition in violation of law
8 or order of the commissioner, the commissioner may declare that the same, to the extent that the
9 commissioner may specify, is a public nuisance and may order the same to be removed, sealed,
10 abated, repaired, altered or otherwise improved.

11 **§28-207.3.1 Rescission.** Upon application, the commissioner shall rescind such order when the
12 condition that gave rise to its issuance has been corrected or where the declaration was issued in
13 error or conditions are such that it should not have been issued. The commissioner may by rule
14 require the payment of a fee in the amount of the expense of additional inspection and
15 administrative expense related to such order.

16 **§28-207.4 Vacate order.** ~~[In case any order to remedy]~~ Where there is a condition that is or may
17 be imminently perilous, dangerous or detrimental to life, public safety or property, ~~[issued by the~~
18 ~~commissioner is not]~~ or where an order to remedy such condition has not been immediately complied
19 with, or the commissioner determines that an emergency exists requiring such action, the com-
20 missioner may order and immediately cause any building, structure, place or premises to be vacated.
21 The vacate order may be given verbally or in writing to the owner, lessee or occupant of the property
22 involved, or to the agent of any of them, or to the person or persons executing the work. [A] Any
23 verbal order to vacate shall be followed promptly by a written order and shall include the reason for
24 the issuance of the vacate order. The written vacate order shall include the date by which the owner
25 shall certify the correction of any and all violations giving rise to such vacate order.

26 **§28-207.4.1 Basis for vacate.** Conditions for which the commissioner may issue a vacate order
27 shall include but shall not be limited to the following conditions that create a hazard to life, public
28 safety, or property:

- 29 1. Danger of structural failure;
- 30 2. Danger of façade failure;
- 31 3. Inadequate fire protection, detection, or suppression;
- 32 4. Inadequate egress; [ø]
- 33 5. Improper storage of hazardous ~~[materials]~~ , combustible or toxic ~~[-]~~ materials; or
- 34 6. Defective or unlawful gas work.

35 **§28-207.4.2 Enforcement of vacate order.** All orders issued pursuant to ~~[this]~~ section 28-207.4
36 shall be posted upon the premises and made available to the public. Upon the posting of an order
37 upon the premises, officers and employees of the police department, the department, and other
38 authorized officers and employees of the city shall immediately act upon and enforce such order.
39 The police department shall provide all reasonable assistance to the department and other
40 authorized officers and employees necessary to carry out the provisions of ~~[this]~~ section 28-

1 207.4. A copy of the vacate order may be filed with the county clerk of the county in which the
2 premises is located and shall be filed with the department and accessible to the public. Such filing
3 shall be notice of the vacate order to any subsequent owner and such owner shall be subject to
4 such order.

5 **§28-207.4.3 Penalties.** In addition to the penalties provided for in this chapter, the owner of a
6 premises where the terms of a vacate order are violated shall be liable for a civil penalty in the
7 amount of \$6,000 for the initial violation and \$12,000 for every subsequent violation, to be paid
8 to the department prior to the rescission of the vacate order.

9 ~~§28-207.4.3~~ **§28-207.4.4 Rescission.** Upon application, the commissioner may rescind the
10 vacate order when the condition that gave rise to its issuance has been corrected [~~and either all~~
11 ~~civil penalties or criminal fines assessed for any violation of such order have been paid or, where~~
12 ~~a violation is pending, security for the payment of such penalties or fines has been posted in~~
13 ~~accordance with department rules], any civil penalty pursuant to section 28-207.4.3 has been
14 paid, or where the vacate order was issued in error or conditions are such that it should not have
15 been issued. The commissioner may by rule require the payment of a fee in the amount of the
16 expense of additional inspection and administrative expense related to such vacate order.~~

17 ~~§28-207.4.4~~ **§28-207.4.5 Tampering.** It shall be unlawful to remove or deface a written
18 posted vacate order from the location where it was affixed unless and until such vacate order
19 has been rescinded by the commissioner. The owner or other person in control of the location
20 shall ensure that the vacate order remains posted until rescinded by the commissioner.

21 **§28-207.4.6 Unlawful continuance.** No person shall with knowledge or notice of a vacate order
22 allow, authorize, promote, continue or cause to be continued any occupancy or use covered by
23 the vacate order.

24 **§28-207.5 Cease use orders for service equipment.** Whenever the commissioner determines that
25 the operation of any service equipment is or may be dangerous to life, health or safety, the
26 commissioner may issue a cease use order requiring such equipment to be shut down or sealed or
27 otherwise made inoperable. Upon the issuance of such order a tag or notice shall be affixed to the
28 device warning that the equipment is unsafe for operation. It shall be unlawful to operate such
29 equipment or to remove or deface such tag unless and until the cease use order is rescinded by the
30 commissioner. The owner or other person in control of the service equipment shall ensure that such
31 tag or notice remains affixed until rescinded by the commissioner.

32 **§28-207.5.1 Rescission of cease use order.** Upon application, the commissioner may rescind
33 the cease use order when the condition that gave rise to its issuance has been corrected and either
34 all civil penalties or criminal fines assessed for any violation of such order have been paid or,
35 where a violation is pending, security for the payment of such penalties or fines has been posted
36 in accordance with department rules or where the cease use order was issued in error or
37 conditions are such that it should not have been issued. The commissioner may by rule require
38 the payment of a fee in the amount of the expense of additional inspection and administrative
39 expense related to such cease use order.

1 **ARTICLE 208**
2 **COMMISSIONER'S REQUEST FOR CORRECTIVE ACTION**

3 **§28-208.1 Commissioner's request for corrective action.** As an alternative to the issuance of an
4 order or notice of violation, the commissioner may issue a request for corrective action to any person
5 responsible for any claimed unlawful use or condition in any premises. Each request for corrective
6 action shall have the commissioner's signature affixed thereto; but the commissioner may authorize
7 any subordinate to affix such signature, including an electronic signature.

8 **§28-208.1.1 Contents and delivery.** The request for corrective action shall contain a description
9 of the building, structure, premises, equipment or subject matter affected, shall be designated by
10 address, where applicable, shall be sent by regular mail or upon consent by electronic means to
11 the owner, lessee, person in charge, or occupant of the building, structure, premises, equipment
12 or to any person responsible for the unlawful use or condition at the last known address for such
13 person. Requests for corrective action may be sent to a managing agent or other person
14 specifically designated by the owner to attend to such requests on behalf of the owner. Each such
15 request shall describe the unlawful use or condition, call upon the person addressed to correct it
16 and to inform the department of the action taken. A time for correction or response shall be
17 specified. A request for corrective action may be given orally, followed within a reasonable time
18 by a writing as described in this section [~~28-208.1.1~~]. A request for corrective action shall provide
19 notice that failure to respond to such a request may result in the imposition of a fee for any
20 subsequent inspection that results in the issuance of a notice of violation for the condition.

21 **§28-208.1.2 Public record.** The department shall keep a record, available to the public, of
22 requests for corrective action issued pursuant to this article. The record of a request for corrective
23 action shall be reflected as withdrawn upon submission to the department of a statement in a
24 form prescribed by rule indicating that the use or condition has been corrected or did not exist or
25 following an inspection by the department that confirms correction. A request for corrective
26 action may be issued in response to a complaint or inspection.

27 **§28-208.1.3 Other remedies not precluded.** Nothing in this article shall be construed to limit
28 the power of the commissioner to take any other action authorized by this code with respect to
29 any unlawful use or condition including, but not limited to, the commencement of an action or
30 proceeding in a court or before the environmental control board or other administrative tribunal
31 or the issuance of a peremptory order or to require that the commissioner issue a request for
32 corrective action as a prerequisite to any other enforcement action.

33 **ARTICLE 209**
34 **COMMISSIONER'S ORDER TO CORRECT UNLAWFUL USE OR CONDITION**

35 **§28-209.1 General.** The commissioner may issue an order to the persons responsible for any
36 unlawful use or condition in any premises directing such person to correct the unlawful use or
37 condition. Each such order shall have the commissioner's signature affixed thereto; but the
38 commissioner may authorize any subordinate to affix such signature, including an electronic
39 signature.

40 **§28-209.2 Contents and service of order.** All orders issued by the commissioner shall contain a
41 description of the building, structure, premises, equipment or subject matter affected, and shall be

1 designated by address where applicable. All such orders shall be served by regular mail or, upon
2 consent, electronically. Such orders may be served by any officer or employee of the department, or
3 by any person authorized by the commissioner. An order may be given orally, followed within a
4 reasonable time by a written order as described in this section [~~28-209.2~~]. Failure to comply with a
5 commissioner's order within the stated time period shall be a violation of this code punishable by
6 civil penalties or criminal fines and imprisonment as set forth in this code. Proof of compliance with
7 a commissioner's order shall consist of certification as prescribed by the rules of the department.

8 **ARTICLE 210**
9 **ILLEGAL CONVERSIONS**

10 **§28-210.1 Illegal residential conversions.** It shall be unlawful, except in accordance with all
11 requirements of this code, to convert any dwelling for occupancy by more than the legally authorized
12 number of families or to assist, take part in, maintain or permit the maintenance of such conversion.
13 Upon the finding of such violation and the imposition of punishment for such violation as set forth
14 in this code the department or if applicable the environmental control board shall forward to the
15 internal revenue service, the New York state department of taxation and finance and the New York
16 city department of finance the name and address of the respondent or defendant, the address of the
17 building or structure with respect to which the violation occurred and the time period during which
18 the violation was found to have existed.

19 **§28-210.1.1 Inspection; failure to gain access to premises.** Upon receiving a complaint of a
20 condition relating to a building or part thereof that would, if observed by the commissioner, be
21 identified by the commissioner as a violation of section 28-210.1 involving the illegal
22 conversion, maintenance or occupancy of three or more dwelling units than are legally
23 authorized by the certificate of occupancy or if no certificate of occupancy is required as
24 evidenced by official records, the commissioner shall attempt to enter and inspect such building
25 or part thereof. After two unsuccessful attempts to gain access to such building or part thereof,
26 the commissioner shall request the corporation counsel to make an application in any court of
27 competent jurisdiction for an ex parte administrative warrant directing the entry and inspection
28 of such premises or location and to issue violations found upon access to such premises or
29 locations. In preparing such requests, priority may be given by the commissioner to requests
30 based on the degree of hazard to safety or property that the commissioner believes present.
31 Such counsel shall promptly consider such request, and where such counsel determines that
32 there is appropriate basis to obtain such an order, shall seek such an order. The commissioner
33 shall promptly execute any such order in accordance with its terms.

34 **§28-210.2 Illegal industrial or manufacturing conversions.** Except as otherwise provided by
35 section 42-03 of the New York city zoning resolution and the multiple dwelling law, it shall be
36 unlawful, except in accordance with all requirements of this code, to convert to residential use any
37 space legally authorized for occupancy for industrial or manufacturing use or to assist, take part in,
38 maintain or permit the maintenance of such conversion. Upon the finding of such violation and the
39 imposition of punishment for such violation as set forth in this code the department, or, if applicable,
40 the environmental control board shall forward to the internal revenue service, the New York state
41 department of taxation and finance and the [~~New York city~~]department of finance the name and
42 address of the respondent or defendant, the address of the building or structure with respect to which
43 the violation occurred and the time period during which the violation was found to have existed.

1 **§28-210.3 Illegal conversions of dwelling units from permanent residences.** Except as
2 otherwise provided in subdivision 16 of section 67 of the New York state multiple dwelling law and
3 section 120 of the New York state multiple dwelling law, dwelling units within (i) a class A multiple
4 dwelling as defined in section 27-2004 of the administrative code, (ii) occupancy group J-2 as
5 described in section 27-265 of the administrative code or (iii) occupancy group R-2 as described in
6 section [~~310.1.2~~] 310.4 of the New York city building code shall be used only for permanent
7 residence purposes as required pursuant to subparagraph a of paragraph [~~eight~~] 8 of subdivision a of
8 section 27-2004 of the administrative code. It shall be unlawful for any person or entity who owns
9 or occupies a multiple dwelling or dwelling unit classified for permanent residence purposes to use
10 or occupy, offer or permit the use or occupancy or to convert for use or occupancy such multiple
11 dwelling or dwelling unit for other than permanent residence purposes. For the purposes of this
12 section a conversion in use of a dwelling unit may occur irrespective of whether [~~any~~] physical
13 changes have been made to such dwelling unit. The provisions of this section shall not be construed
14 to prohibit lawful accessory uses permitted pursuant to the zoning resolution or the lawful conversion
15 of dwellings in accordance with applicable law.

16 **§28-210.3.1 Reporting on illegal conversions of dwelling units from permanent residences.**
17 By no later than September [~~1~~] first of each year, the department shall, with the cooperation of
18 the mayor's office of special enforcement and all other relevant city agencies, submit a report to
19 the council including, but not limited to, the following information for the previous year,
20 disaggregated by council district:

- 21 1. The number of complaints received by the department alleging the conversion of dwelling
22 units for other than permanent residence purposes;
- 23 2. The number of inspections conducted by the city in response to suspected conversions of
24 dwelling units for other than permanent residence purposes;
- 25 3. The number of notices of violation issued for conversions of dwelling units for other than
26 permanent residence purposes;
- 27 4. The amount of civil penalties imposed for such violations and the amount of such penalties
28 collected;
- 29 5. For each inspection resulting in the issuance of a notice of violation:
 - 30 5.1. The name of the owner and the address of the building to which such notice of
31 violation was issued; and
 - 32 5.2. The number and type of violations issued, disaggregated by whether such
33 violations are upheld, pending or dismissed;
- 34 6. For each inspection resulting in the issuance of a notice of violation pursuant to section
35 28-210.3:
 - 36 6.1. Whether each such notice of violation was classified as immediately hazardous
37 pursuant to item 16 of section 28-201.2.1;
 - 38 6.2. For each such immediately hazardous violation, whether the notice of violation
39 was for the illegal conversion of more than one dwelling unit or for a second or
40 subsequent offense; and

1 notice to the council, the department of investigation, New York state division of housing and
2 community renewal and the state tenant protection unit, and shall refer such finding to the district
3 attorney of the county in which the property is located and the state attorney general.

4 **§28-211.1.4 [-] Reporting.** By no later than January 30 of each year, the department shall submit
5 a report to the mayor and to the speaker of the council that indicates the actions it took in every
6 instance in which it made a determination that a person had violated section 28-211.1.

7 **§28-211.2 Falsely impersonating a department officer, inspector[-], or employee.** It shall be
8 unlawful for any person to falsely represent himself or herself as an officer, inspector or employee
9 of the department, or as acting under the authority of the department, or without authority to use,
10 wear or display a shield or other insignia or emblem such as is worn by such officer, inspector or
11 employee.

12 **§28-211.3 Identifying unlawful statements.** The department, in coordination with the department
13 of finance, shall collect information from the department of finance regarding occupied and rent
14 regulated buildings to identify violations of section 28-211.1. The department shall also request
15 information from the New York state division of housing and community renewal regarding
16 occupied and rent regulated buildings to identify violations of section 28-211.1.

17 **§28-211.3.1 Required audits.** If the department determines that a person has violated section
18 28-211.1, or that the person has performed work in violation 28-105.1 in a building that is
19 occupied as a dwelling, the department shall conduct an audit of filings for all buildings owned
20 by such person and located in the city to determine if other violations of 28-211.1 have occurred
21 with respect to other buildings owned by such person. If more than five amendments to approved
22 construction documents have been submitted to the department within a six month period for a
23 single building, and where such amendments indicate (i) a change in occupancy, (ii) a change in
24 whether the building contains occupied housing accommodations subject to rent control or rent
25 stabilization under chapters 3 and 4 of title 26 of the administrative code or (iii) a change that
26 would require the person to submit an application for a new permit to the department, the
27 department shall conduct an audit of all properties owned by such person and located in the city
28 to determine if any statements were made that are unlawful pursuant to section 28-211.1. At least
29 once per year, the department shall audit no less than 25 percent of buildings placed on the watch
30 list established by article 3 of subchapter 4 of chapter 2 of title 27 of the administrative code for
31 compliance with building permit requirements, including whether section 28-211.1 has been
32 violated.

33 **ARTICLE 212**
34 **ABATEMENT OF PUBLIC NUISANCE CAUSED BY CERTAIN ILLEGAL**
35 **OCCUPANCIES**

36 **§28-212.1 Abatement of public nuisances caused by illegal commercial or manufacturing**
37 **occupancy in residence districts and certain other zoning districts.** Any building or part thereof
38 or vacant land that is located in a residence zoning district and that is occupied for a use not permitted
39 in such district in violation of the zoning resolution, without a certificate of occupancy [~~authorizing~~
40 or other authorization of such use, is hereby declared to be a public nuisance. Any building or part
41 thereof or vacant land that is located in a C-1 or C-2 commercial zoning district and that is occupied
42 for a commercial or manufacturing use indicated under use group 16, 17, or 18 as described in

1 sections 32-25, 42-14, and 42-15 of the zoning resolution, in violation of the zoning resolution,
2 without a certificate of occupancy authorizing such use is hereby declared to be a public nuisance.

3 **§28-212.2 Order of closure.** If a building or part thereof or vacant land in which such a nuisance
4 occurs is not occupied primarily as a residence, the commissioner may, in addition to or as an
5 alternative to any other remedy under any other provision of law, after notice and the opportunity
6 for a hearing in accordance with this article, order the closing of such building or part thereof or such
7 vacant land to the extent necessary to abate the nuisance.

8 **§28-212.3 Notice of hearing.** A notice of hearing with respect to an order of closure shall be served
9 on the owner and mortgagee of record of such building or part thereof or such vacant land and on
10 any person alleged to be occupying such building or part thereof or such vacant land at which the
11 nuisance is located.

12 **§28-212.4 Service of notice of hearing.** Service may be made on the owner by delivering such
13 notice to the owner or to an agent of the owner or to a person of suitable age and discretion at the
14 residence or place of business of the owner or, if upon reasonable application such delivery cannot
15 be completed, by affixing such notice in a conspicuous place at the owner's place of business or
16 residence or by placing it under the entrance door at either of such locations or by delivering such
17 notice to a person employed by the owner to work at or to manage or maintain the premises at which
18 the nuisance is located and, in all instances except personal delivery upon such owner by mailing the
19 notice of hearing as follows:

20 **§28-212.4.1 Mailing to owner's registered address.** To the person registered with the
21 department of housing preservation and development as the owner or agent of the premises, at
22 the address filed with such department in compliance with article [~~two~~] 2 of subchapter [~~four~~] 4
23 of chapter [~~two~~] 2 of title [~~twenty-seven~~] 27 of the administrative code;

24 **§28-212.4.2 Mailing to billing address.** To the person designated as owner of the building or
25 designated to receive real property tax or water bills for the building at the address for such
26 person contained in one of the files compiled by the department of finance for the purpose of the
27 assessment or collection of real property taxes and water charges or in the file compiled by the
28 department of finance from real property transfer forms filed with the city register upon the sale
29 or transfer of real property; or

30 **§28-212.4.3 Mailing to recorded address.** To the person in whose name the real estate affected
31 by the order of the commissioner is recorded in the office of the city register or the county clerk
32 as the case may be at the address set forth on the recorded instrument.

33 **§28-212.4.4 Service on corporate owner.** Service may be made on an owner that is a
34 corporation pursuant to section 306 of the business corporation law; however, service upon a
35 corporation shall be deemed to have been completed 45 days following service upon the secretary
36 of state.

37 **§28-212.4.5 Service on mortgagees.** Service may be made upon mortgagees of record by
38 mailing such notice to the mortgagees at the address set forth on the recorded instrument.

1 **§28-212.4.6 Service on occupants.** Service may be made upon an occupant by delivering such
2 notice to the occupant or to a person employed by the occupant to work at or to manage or
3 maintain the premises at which the nuisance is located; or by affixing such notice to the premises
4 at which the nuisance is located in a conspicuous place or by placing a copy under the entrance
5 door of such premises and mailing a copy of such notice to the occupant at such premises; and
6 in all instances except personal delivery upon such occupant, by mailing the notice of hearing to
7 the occupant at the premises at which the nuisance is located.

8 **§28-212.4.7 Proof of service.** Proof of service pursuant to section 28-212.4.1 through 28-
9 212.4.6 shall be filed with the commissioner.

10 **§28-212.5 Conduct of hearing by office of administrative trials and hearings.** The hearing shall
11 be conducted by the office of administrative trials and hearings. The administrative law judge
12 assigned to hear the matter shall submit his or her proposed findings of fact and recommended
13 decision to the commissioner. If based on such recommended decision, proposed findings of fact,
14 and the record of the hearing the commissioner determines that the building or part thereof or vacant
15 land is a public nuisance, pursuant to this article, the commissioner may issue an order of closure.
16 Such order shall not bar legally required ingress or egress for residential occupancy of parts of the
17 building that are not subject to the order of closure.

18 **§28-212.6 Lack of knowledge not a defense.** At such hearing it shall not be a defense that the
19 owner, occupant, lessor, lessee, mortgagee, or other person having an interest in the property lacked
20 knowledge of or did not acquiesce or participate in the creation or continuation of the public
21 nuisance.

22 **§28-212.7 Closure not an act of possession.** A closure ordered by the commissioner pursuant to
23 this article shall not constitute an act of possession, ownership, or control by the city over the closed
24 premises.

25 **§28-212.8 Posting of order of closure.** An order of closure shall be posted at the building or part
26 thereof or vacant land that is the subject of such order, and shall be mailed to the record owner of
27 such premises, and any record mortgagee at the address for such person set forth in the recorded
28 instrument, and to the person designated as owner or agent of the building or designated to receive
29 real property tax or water bills for the building at the address for such person contained in one of the
30 files compiled by the department of finance for the purpose of the assessment or collection of real
31 property taxes and water charges or in the file compiled by the department of finance from real
32 property transfer forms filed with the city register upon the sale or transfer of real property. A copy
33 shall also be filed with county clerk or register of the county in which such premises are located.
34 Such filing shall be notice of the order to any subsequent owner and such owner shall be subject to
35 such order.

36 **§28-212.9 Enforcement of order of closure.** On the tenth business day after the posting of such
37 order and upon the written directive of the commissioner, police officers and authorized employees
38 of the department shall act upon and enforce such order by sealing, padlocking, or otherwise
39 preventing access to the premises in a manner that will not bar legally required ingress or egress for
40 residential occupancy of parts of the building that are not subject to the closure order.

1 **§28-212.10 Rescission of order of closure.** If at any time after the issuance of such order, the
2 owner, mortgagee, or other person having an interest in the property provides assurance, in a form
3 satisfactory to the commissioner, that the illegal commercial or manufacturing use of the premises
4 has been discontinued and will not reoccur, or such owner, mortgagee, or other person establishes
5 that the premises may be lawfully occupied for such use, the commissioner shall rescind the closure
6 order. If such order is rescinded, the commissioner shall, upon request of such owner, mortgagee, or
7 other person, provide a copy of such rescission, which may be filed with the county clerk or register
8 of the county in which such premises are located. No such re-occupancy shall be permitted without
9 a certificate of occupancy or other department records authorizing such use.

10 **§28-212.11 Violation of closure order.** It shall be unlawful for any person to use or occupy or to
11 permit any other person to use or occupy any building or part thereof or vacant land that has been
12 sealed, padlocked, or otherwise closed pursuant to an order of the commissioner. It shall be unlawful
13 to mutilate or remove a posted order of the commissioner. Intentional disobedience or violation of
14 any provision of a closure order shall be punishable as an immediately hazardous violation.

15 **ARTICLE 213**
16 **PENALTY FOR WORK WITHOUT A PERMIT**

17 **§28-213.1 Department penalty for work without a permit.** In addition to any penalties otherwise
18 authorized by law pursuant to article 202 and the rules of the department, whenever any work for
19 which a permit is required pursuant to this code has been performed without a permit, a penalty shall
20 be imposed by the department as provided in this article.

21 **Exception:** No such penalty shall be imposed for work performed without a permit to hang or
22 attach upon or on the outside of any building a sign that is accessory to a use on the same zoning
23 lot, as defined in section 12-10 of the New York city zoning resolution that does not exceed one
24 hundred fifty square feet in area, measured on one face only, or exceed one thousand two hundred
25 pounds in weight. All such outstanding penalties imposed on or after December 28, 2017 shall
26 be waived.

27 **§28-213.1.1 Penalty for work without permit on one- or two-family dwelling.** Where work
28 has been performed without a permit on a one-[family] or two-family dwelling the penalty shall
29 equal six times the amount of the fee payable for the permit. Where only part of the work has
30 been performed without a permit, the penalty shall be reduced proportionately according to the
31 amount of work still to be performed at the time a permit is issued. Notwithstanding the
32 foregoing, no such penalty shall be less than \$600, nor more than \$10,000.

33 **§28-213.1.2 Penalty for work without permit on other than one- or two-family dwelling.**
34 The penalty for work without a permit on buildings other than one- or two-family dwellings shall
35 be 21 times the amount of the fee payable for such permit. Where only part of the work has been
36 performed without a permit, the penalty shall be reduced proportionately according to the amount
37 of work still to be performed at the time a permit is issued. Notwithstanding the foregoing, no
38 such penalty shall be less than \$6,000, nor more than \$15,000.

39 **§28-213.2 Waiver.** Such penalty and the permit fee shall be payable by the owner of the building
40 on which the unpermitted work was performed. A waiver or reduction of such penalty shall be
41 available to a subsequent bona fide purchaser of the premises pursuant to department rules.

1 **§28-213.3 Payment of penalty required before issuance of permit.** No permit shall be issued for
2 work described in this article until the penalty assessed by the department pursuant to this article has
3 been paid.

4 **§28-213.4 Procedure.** The department shall adopt a rule setting forth a procedure for assessment of
5 penalties pursuant to this article.

6 **§28-213.5 Watch list of contractors performing work without required permit.** The department
7 shall compile and maintain a watch list of contractors who have been found to have performed work
8 without a required permit in the preceding two years.

9 **§28-213.5.1 Increased oversight.** At any site where a contractor that is included on the watch
10 list created pursuant to section 28-213.5 performs work in an occupied building, the department
11 shall perform one or more inspections in order to ensure compliance with applicable laws, rules,
12 regulations and permitting requirements. The department may promulgate rules providing for
13 additional oversight of such contractors where appropriate for the protection of the public.

14 **§28-213.5.2 Exemption.** Any work performed by a contractor that is wholly or partially exempt
15 from a civil penalty for work performed without a permit pursuant to a rule of the department
16 shall not be considered in determining whether the contractor is to be included on the watch list
17 created pursuant to section 28-213.5.

18 **§28-213.5.3 Removal from watch list.** The department shall remove from the watch list created
19 pursuant to section 28-213.5 any contractor who has not been found to have performed work
20 without a permit in the two years after the latter of the following dates: (i) the date on which such
21 contractor was originally placed on such watch list or (ii) the date on which such contractor most
22 recently performed work without a required permit.

23 **§28-213.6 Enhanced penalties for other violations.** Where a penalty is imposed pursuant to this
24 article for work that has been performed without a permit on a building (i) the civil penalty for each
25 violation of this code issued for such building within one year after such imposition shall be two
26 times the penalty that would otherwise apply for such violation or (ii) if such work without a permit
27 was performed on only part of such building and the owner of such part is not the owner of such
28 building, the civil penalty for each violation of this code issued for such part within one year after
29 such imposition shall be two times the penalty that would otherwise apply for such violation.

30 **§28-213.7 Inspection fees.** Where a penalty is imposed pursuant to this article for work that has
31 been performed without a permit on a building (i) the department may impose an inspection fee, in
32 an amount to be established by rule, for each complaint-based inspection it conducts at such
33 building within one year after imposition of such penalty where such inspection results in the
34 issuance of a violation or (ii) if such work without a permit was performed on only part of such
35 building and the owner of such part is not the owner of such building, the department may impose
36 an inspection fee, in an amount to be established by rule, for each complaint-based inspection it
37 conducts at only such part within one year after imposition of such penalty or until the date such
38 part of such building changes

1 **ARTICLE 214**
2 **ORDER TO SEAL, SECURE AND CLOSE**

3 **§28-214.1 Order to seal, secure and close.** If the commissioner determines such action is necessary
4 to the preservation of life and safety the commissioner may order a building subject to a vacate order
5 to be sealed, secured and closed.

6 **§28-214.1.1 Definition.** For the purpose of this article, “sealed” and “sealed, secured and
7 closed” shall mean the use of any means available to render the building, structure or part thereof
8 inaccessible, including but not limited to the use of a padlock or cinder blocks.

9 **§28-214.1.2 Hearing.** Such order to seal, secure and close shall contain notice of the opportunity
10 for a hearing with respect to such order to determine if the order was properly issued in
11 accordance with the provisions of this article. Such hearing shall be conducted by the
12 commissioner, or in the commissioner’s discretion, by the office of administrative trials and
13 hearings or the environmental control board. If the matter is referred to such office or board, the
14 hearing officer shall submit his or her findings of fact and a recommended decision to the
15 commissioner. The hearing shall be held within three business days after the receipt of the written
16 request of an owner, lessor, lessee, or mortgagee for such hearing. The commissioner shall render
17 a decision within three business days after such hearing is concluded or findings of fact and a
18 recommendation are submitted.

19 **§28-214.1.3 Service of seal, secure and close order.** Such order issued pursuant to this article
20 shall be served as follows: It shall be mailed to the record owner of such premises; any record
21 mortgagee of such premises at the address for such person as set forth in the recorded instrument;
22 and if reasonably ascertainable, the person designated as owner’s agent of the building or
23 designated to receive real property tax or water bills for the building at the address for such
24 person contained in one of the files compiled by the department of finance for the purpose of the
25 assessment or collection of real property taxes and water charges or in the file compiled by the
26 department of finance from real property transfer forms filed with the city register upon the sale
27 or transfer of real property. A copy shall also be filed with the county clerk of the county in
28 which such premises is located. Such filing shall be notice of the order to any subsequent owner
29 and such owner shall be subject to such order.

30 **§28-214.1.4 Rescission of seal, secure and close order.** An order issued pursuant to this article
31 shall not be rescinded unless the owner, lessor, lessee or mortgagee seeking such rescission
32 provides assurance, in a form satisfactory to the commissioner, that the conditions that caused
33 the issuance of such order have been corrected and will not reoccur. If such order is rescinded,
34 upon the request of the owner, lessor, lessee or mortgagee, the commissioner shall provide a
35 certified copy of such rescission, which may be filed with the county clerk of the county in which
36 such premises is located.

37 **§28-214.1.5 Expenses of enforcing seal, secure and close orders.** The expenses attending the
38 execution of any and all orders duly made by the department shall respectively be a several and
39 joint personal charge against each of the owners or part owners, and each of the lessees and
40 occupants of the building, structure, enclosure, place or premises to which such order relates,
41 and in respect to which such expenses were incurred; and also against every person or body who
42 was by law or contract bound to do that in regard to such building, structure, enclosure, place or

1 premises which such order requires. Such expenses shall also be a lien on all rent and
2 compensation due, or to become due, for the use of any building, structure, place or premises, or
3 any part thereof, to which such order relates, and in respect to which such expenses were
4 incurred.

5 **§28-214.1.6 Notice of seal, secure and close order to community.** The commissioner shall
6 give written notice of the closing of any building, structure, enclosure, place or premises pursuant
7 to this article, and any subsequent actions taken with respect thereto, as soon as practicable, to
8 the borough president of the borough within which the closing has occurred; the council member
9 representing the district within which the closing has occurred; and the local community board.
10 On January first of each year, the commissioner shall submit a report to the council, setting forth
11 the number of closings made in the previous year, the locations of such closings, and the nature
12 and use of the premises closed. The commissioner shall, in addition, as soon as practicable after
13 a building, structure, enclosure, place or premises has been closed, make and publish a report of
14 said closing in a manner calculated to quickly notify the local community in which such closing
15 occurred. The commissioner shall also make and publish a report of any premises reopened
16 pursuant to his or her permission under this article. Failure to comply with this section [~~28-~~
17 ~~214.1.6~~] shall not invalidate any action taken by the commissioner pursuant to this article.

18 **§28-214.2 Access to sealed premises.** The commissioner shall allow access to the premises sealed,
19 secured and closed pursuant to this article to an owner, or a lessor, lessee or mortgagee upon the
20 following conditions:

- 21 1. The submission of a written affirmation, satisfactory to the commissioner, that such person or
22 persons will commence or cause to be commenced without delay all work necessary to correct
23 the conditions stated in the vacate order or otherwise to make the premises meet all applicable
24 laws and rules and will complete such work within a period of time and in a manner to be
25 approved by the commissioner;
- 26 2. The submission of a written affirmation or other proof satisfactory to the commissioner
27 describing the steps that have been taken and will be taken in the future to ensure that the
28 premises will be used or operated in a lawful manner and specifying such lawful use;
- 29 3. If a license, permit, certificate of operation or certificate of occupancy is necessary for such
30 lawful use, the submission of a written affirmation or other proof, satisfactory to the
31 commissioner, describing the steps that have been taken and will be taken in the future to
32 ensure that such premises will be used or operated in compliance with any law requiring such
33 license, permit, certificate of operation or certificate of occupancy; and
- 34 4. If the premises are leased and the person making the affirmations described above in items 1,
35 2 and 3 is not such lessee, the commissioner may also require any authorized person seeking
36 access to submit a written affirmation or other proof that proceedings to enable such person to
37 take actions necessary to ensure compliance with the affirmations submitted by such
38 authorized person pursuant to items 1, 2 and 3 have been commenced.

39 **§28-214.3 Additional penalties for harm or injury from violation of order to seal, secure and**
40 **close.** Notwithstanding any other law, rule, or regulation, any person, corporation, partnership,
41 association or any other legal entity who permits a building, structure, enclosure, place or premises,
42 or any part thereof, to be unlawfully occupied or used in contravention of an order of the
43 commissioner pursuant to this article, or who negligently fails to prevent or prohibit such unlawful

1 occupancy or use, shall be liable for a civil penalty of not more than [~~one million dollars~~] \$1,000,000,
2 if any other person suffers serious physical injury, as defined in section ten of the penal law, or death
3 in the building, structure, place or premises or any part thereof subject to such order as a result of
4 such unlawful occupancy or use. If more than one person suffers serious physical injury or death,
5 such penalty shall be recoverable for each person suffering serious physical injury or death. Such
6 penalty shall be recovered in a civil action brought by the corporation counsel in the name of the city
7 in any court of competent jurisdiction. In determining the amount of the civil penalty to be imposed
8 the court shall consider:

- 9 1. The extent and severity of injury to persons and property caused by the violation;
- 10 2. The history of violations by the defendant at such premises, or any other premises, of laws or
11 rules enforced by the department;
- 12 3. The degree of willfulness, recklessness, or negligence displayed by the defendant in
13 committing the subject violation;
- 14 4. The defendant's financial resources; and
- 15 5. The defendant's good faith efforts to cure the subject violation, including efforts to obtain
16 entry to or possession of the premises in order to do so.

17 **§28-214.3.1 Payment by city.** In the event that the family of any person seriously injured or
18 who has died as the result of any unlawful occupancy or use described in [~~this~~] section 28-214.3
19 is unable to collect a judgment recovered in a civil action for personal injury or wrongful death
20 against a defendant who has violated [~~this~~] section 28-214.3 because of the insolvency of such
21 defendant, the city may, in its discretion, pay to such injured person or the family of such
22 deceased person an amount, as hereinafter provided, collected from such defendant in an action
23 relating to the same injury or death commenced by the corporation counsel against such
24 defendant pursuant to this section[~~-28-214.3.1~~].

25 **§28-214.3.2 Limitations.** Payments pursuant to section 28-214.3.1 shall be made as a matter of
26 grace and shall be in such amounts and in accordance with such standards and procedures as
27 shall be established by the mayor, provided, however, that any payment made pursuant to section
28 28-214.3.1 shall be in an amount not exceeding out-of-pocket expenses, including indebtedness
29 reasonably incurred for medical or other services necessary as a result of the injury upon which
30 such action is based; loss of earnings or support resulting from such injury; burial expenses not
31 exceeding [~~two thousand five hundred dollars~~] \$2,500 of a person who died as a result of such
32 unlawful occupancy or use described in [~~this~~] section 28-214.3; and the unreimbursed cost of
33 repair or replacement of articles of essential personal property lost, damaged or destroyed as a
34 direct result of such unlawful occupancy or use. In no event shall the payment made to any person
35 exceed the amount of such person's uncollected judgment for personal injury or wrongful death
36 and in no event shall the total amount paid to any number of persons with such uncollected
37 judgments against a single defendant exceed the actual amount collected by the city from such
38 defendant in an action under this subdivision.

1 **ARTICLE 215**
2 **EMERGENCY POWERS OF THE COMMISSIONER**

3 **§28-215.1 Emergency work.** Notwithstanding any other provisions of law, if the commissioner
4 determines that a structure or premises or any part thereof poses an imminent danger of serious
5 physical injury or death to the public or is in imminent danger of collapse and the exigency of the
6 situation is such that any delay may cause further danger to the public safety, then the commissioner
7 may direct the commissioner of housing preservation and development or the department of citywide
8 administrative services, or other authorized agency to perform or arrange the performance of the
9 emergency work on, or demolition of, such structure or premises or part thereof or such other work
10 as deemed by the commissioner to make it safe.

11 **§28-215.1.1 Lien for emergency work.** The expenses of the city in performing emergency work
12 on any structure or part of such structure pursuant to this article shall constitute a debt recoverable
13 from the owner and a lien upon the land and any part of such structure that was not demolished.
14 Every such lien shall have priority over all other liens and encumbrances on the premises except
15 for the lien of taxes and assessments. Except as otherwise provided by rule of the affected agency,
16 the agency incurring such expense shall be governed by the procedures set forth in article [~~eight~~]
17 8 of subchapter [~~five~~] 5 of the New York city housing maintenance code with respect to the
18 enforcement of such debt and lien against all types of structures, including those authorized to
19 be occupied or otherwise occupied for residential, commercial, and manufacturing purposes.

20 **§28-215.1.2 Interference prohibited.** It shall be unlawful for any person to interfere, obstruct
21 or hinder the commissioner or the commissioner of citywide administrative services, housing
22 preservation and development, or other authorized agency, or any person who, acting under the
23 authority conferred on such person by such commissioner, is performing the work authorized by
24 section 28-215.1.

25 **§28-215.1.3 Enforcement.** The police commissioner shall enforce such orders or requirements
26 when requested by the commissioner and shall likewise enforce same at the request of the
27 commissioner of citywide administrative services, housing preservation and development, or
28 other authorized agency, with respect to work performed by or under the direction of such
29 commissioner pursuant to the provisions of section 28-215.1.

30 **§28-215.2 Stopping work and securing structures.** See section 28-207.2.

31 **§28-215.3 Vacating structures.** See section 28-207.4.

32 **§28-215.4 Violations of protective measures during construction or demolition.** During the
33 construction or demolition of a structure, the commissioner shall notify the owner of the structure
34 affected of any failure to comply with any of the provisions of this code that concern the protection
35 of life, safety and property during construction or demolition. Unless the owner so notified proceeds
36 immediately to comply with the orders of the commissioner, the commissioner shall have full power
37 to correct the violation. All expenses incurred therefore shall become a lien on the property pursuant
38 to section 28-112.9.

39 **§28-215.5 Investigation of accidents or other emergency conditions.** When necessary to conduct
40 an investigation of any occurrence affecting building or construction safety, the commissioner may

1 seize or impound equipment, building material, and portions of the affected building or premises for
2 examination and testing. The police department or other authorized law enforcement agency shall
3 cooperate with the commissioner upon request and shall provide a suitable place for the deposit of
4 such items.

5 **§28-215.6 Closing streets temporarily.** The commissioner may, when necessary for the public
6 safety, temporarily close the sidewalks, streets, structures or places adjacent to a structure or part
7 thereof, and the police commissioner or commissioner of the department of transportation, any of
8 his or her subordinates shall enforce all orders or requirements made by the commissioner, when so
9 requested by the commissioner.

10 **§28-215.7 Recovery of bodies from wrecked structures.** Where any persons are known or
11 believed to be buried under the ruins of any fallen structure or part thereof in the city, the
12 commissioner shall cause an examination of the premises to be made for the recovery of the injured
13 and bodies of the dead. Whenever, in making such examination, it shall be necessary to remove any
14 debris from the premises, other city agencies shall cooperate with the commissioner in carrying out
15 the purposes of this section [28-215.7], and shall provide suitable and convenient places for the
16 deposit of such debris.

17 **§28-215.8 Non-compliance with orders; execution of work by department.** Upon the failure to
18 comply with any order of the commissioner within the time limited thereby, and subject to the
19 provisions of article 216, any work required to be executed by such order may be executed by the
20 commissioner through the officers, agents or contractors of the department or other authorized
21 agency; and the city shall be reimbursed promptly for all costs and expenses of such work. Such
22 costs and expenses shall become a lien upon the premises involved and named in the commissioner's
23 order, which may be enforced in accordance with the provisions of section 28-112.9[~~of this code~~].

24
25

ARTICLE 216 UNSAFE BUILDINGS

26 **§28-216.1 Conditions constituting an unsafe building or structure.** Any building, structure or
27 part thereof described in this article shall be deemed an unsafe building and shall be demolished or
28 removed or made safe and secure as provided herein.

29 **§28-216.1.1 Compromised structures.** Any structure or premises or part of a structure or
30 premises that from any cause may at any time become dangerous or unsafe, structurally or as a
31 fire hazard, or dangerous or detrimental to human life, health or safety, shall be demolished and
32 removed or made safe and secure.

33 **§28-216.1.2 Vacant buildings.** Any vacant building not continuously guarded or not sealed and
34 kept secure against unauthorized entry shall have all openings sealed in a manner approved by
35 the commissioner, and it shall be the duty of the owner thereof promptly to make any repairs that
36 may be necessary for the purpose of keeping such building sealed and secure.

37 **§28-216.2 Record and notice of unsafe building, structure or premises.** The department shall
38 cause a report to be filed on an unsafe building, structure or premises. The report shall describe the
39 nature of the occupancy of the structure and the nature of the unsafe condition and be made a record
40 of the department.

1 **§28-216.3 Notice of survey and summons and order.** The owner, executor, administrator,
2 mortgagee, lessee or any other person who may have a recorded vested or recorded contingent
3 interest in the unsafe building, structure or premises, shall be served with a notice of survey and
4 summons containing a description of the unsafe building, structure or premises and an order
5 requiring such building be sealed, secured, repaired, shored, or demolished and removed as may be
6 deemed necessary by the commissioner.

7 **§28-216.3.1 Content.** Such notice of survey and summons shall require the person thus served
8 immediately to certify to the commissioner his or her acceptance or rejection of the order. The
9 notice of survey and summons shall further notify said person(s) that upon ~~[his or her]~~ their
10 refusal or neglect to comply with any of the requirements of this provision, a survey of the
11 building or premises named in such notice will be made at a time and place therein named. The
12 notice of survey and summons shall also state that if, pursuant to the survey, it is found that the
13 building, structure, or premises referred to therein is unsafe or dangerous by the surveyors, their
14 report of survey will be placed before the supreme court for trial at a time and place named in
15 such notice.

16 **§28-216.4 Method of service.** The notice of survey and summons and order shall be served in
17 accordance with the New York state civil practice law and rules ~~[-of the state of New York].~~

18 **§28-216.5 Owner abatement of unsafe or dangerous conditions.** If the person served with a
19 notice and order pursuant to section 28-216.4 shall immediately certify his or her assent to the
20 securing or removal of such unsafe building, structure or premises condition, such person shall be
21 allowed a period of time as determined by the commissioner ~~[-or his or her designee,]~~ within which
22 to commence and complete the abatement of the unsafe or dangerous condition. Such person shall
23 employ sufficient labor and assistance to secure or remove such conditions as expeditiously as
24 possible.

25 **§28-216.6 Survey.** A survey of the building or premises shall be conducted as follows:

26 **§28-216.6.1 Identity of surveyors.** The survey shall be made by three competent persons, of
27 whom one shall be the commissioner ~~[or his or her designee]~~; another shall be a registered design
28 professional appointed by a recognized professional organization or by the commissioner; and
29 the third shall be a registered design professional appointed by the person served with a notice
30 pursuant to section 28-216.4. If the person served with such notice shall neglect or refuse to
31 appoint such surveyor, the other two surveyors shall make the survey. In case they disagree, they
32 shall appoint a third person to take part in such survey, who shall be a registered design
33 professional of at least 10 years' practice, whose decision shall be final.

34 **§28-216.6.2 Posting report of survey.** A copy of the report of the survey shall be posted on the
35 structure that is the subject thereof by the persons holding the survey, immediately on their
36 issuing such report.

37 **§28-216.6.3 Compensation of surveyors.** The registered design professional appointed by the
38 respective professional organization or by the commissioner, as hereinbefore provided, who may
39 act on any survey called in accordance with the provisions of ~~[this]~~ section 28-216.6, and the
40 third surveyor who may have been called in the case of disagreement provided for in ~~[this]~~

1 section 28-216.6, shall each be paid a sum to be determined by rule to be promulgated by the
2 department.

3 **§28-216.6.4 Cost of survey.** Any costs incurred by the city in connection with the survey shall
4 become money due and owing to the city as part of the return of precept and judgment provided
5 for in [~~section~~] sections 28-216.9, 28-216.10 and 28-216.11[~~of this code~~] or pursuant to lien
6 provided for in section 28-112.9[~~of this code~~].

7 **§28-216.7 Court proceeding.** Whenever the report of survey shall recite that the building, structure
8 or premises surveyed is unsafe or dangerous, the corporation counsel or his or her designee shall, at
9 the time specified in the notice, place such notice and report before a justice of the court named in
10 the notice. The report of survey shall be in writing and constitute the issues to be placed before the
11 court for trial. The purpose of the trial shall be to determine whether the unsafe building, structure,
12 or premises shall be vacated and sealed, secured, shored, or demolished and removed.

13 **§28-216.7.1 Precedence of proceeding.** The unsafe building proceeding shall have precedence
14 over every other business of such supreme court. The trial on the issues in the unsafe building
15 proceeding shall be held without delay, at the time specified in the notice, and shall be held by a
16 justice of the court or by a referee, whose decision or report in the matter shall be final.

17 **§28-216.7.2 Precept to abate.** If the justice or referee determines the building, structure or
18 premises that is the subject of the report of survey is unsafe or dangerous, such justice or referee
19 trying the case shall immediately issue a precept directed to the commissioner authorizing the
20 commissioner forthwith to vacate pursuant to section 28-207.4, if necessary, and to seal, secure,
21 shore, or demolish and remove the unsafe building, structure or premises named in such report.
22 The precept shall be effective for a period of three years from the date of issuance.

23 **§28-216.7.3 Notice of pendency.** A notice of pendency shall be filed in accordance with the
24 following procedure:

- 25 1. The notice of pendency shall be filed in accordance with the [~~Civil Practice Law and~~
26 ~~Rules of the State of New York~~] New York state civil practice law and rules and shall be
27 filed in the office of the clerk of the county where the property affected by such action,
28 suit or proceeding is located. Such notice of pendency may be filed at any time after the
29 service of the notice described in section 28-216.3 of this code.
- 30 2. Any notice of pendency filed pursuant to the provisions of this section [~~28-216.7.3~~] that
31 has not expired may be vacated and cancelled of record upon an order of a justice of the
32 court in which such suit or proceeding was instituted or is pending, or upon the consent
33 in writing of the corporation counsel. The clerk of the county where the notice is filed is
34 hereby directed and required to mark any such notice of pendency, and any record or
35 docket thereof, as vacated and cancelled of record upon the presentation and filing of a
36 certified copy of such order or consent.

37 **§28-216.8 Execution of precept.** A precept issued pursuant to section 28-216.7.2 shall be executed
38 in accordance with the procedure set forth in sections 28-216.8.1 through 28-216.8.3.

39 **§28-216.8.1 Work by the department.** Upon receiving a precept under the provisions of
40 section 28-216.7.2, the commissioner shall execute such precept, as therein directed, and may

1 employ such labor and assistance and furnish such materials as may be necessary for that
2 purpose. The commissioner [~~or his or her designee~~] shall direct the commissioner of citywide
3 administrative services or the department of housing preservation and development or other
4 authorized agency to perform work in accordance with the precept. Such work shall be performed
5 by or under the direction of citywide administrative services in accordance with the provisions
6 of section 4-204 of the administrative code, or the department of housing preservation and
7 development, or such other authorized agency.

8 **§28-216.8.2 Owner application to perform work.** The owner of such unsafe building,
9 structure, or premises, or any party interested therein, if such person applies to the commissioner
10 immediately upon the issuing of such precept, shall be allowed to perform the requirements of
11 such precept at his or her own cost and expense, if the performance shall be done immediately
12 and in accordance with the requirements of such precept and other applicable laws and rules and
13 such other requirements as the commissioner shall impose.

14 **§28-216.8.3 Modification of precept.** The commissioner [~~or his or her designee~~] shall have
15 authority to modify the requirements of any precept when such commissioner [~~or designee~~] shall
16 be satisfied that such change will secure the safety of such structure or premises equally well.

17 **§28-216.8.3.1 Upon application.** The commissioner shall also have authority to modify the
18 requirements of any precept upon application to such commissioner in writing by the owner
19 of the unsafe building, structure, or premises, or such owner's authorized representative. In
20 addition, upon application to modify the requirements of any precept to seal, shore or
21 demolish the structure by the commissioner of housing preservation and development,
22 citywide administrative services or such other authorized agency, the commissioner [~~or~~
23 ~~designee~~] shall have authority to modify such precept accordingly when the commissioner
24 shall be satisfied that such change will secure the safety of such structure or premises equally
25 well.

26 **§28-216.8.3.2 Notice.** After a determination to modify the precept is made by the
27 commissioner, written notice of such determination shall be sent by regular mail to the owner
28 and applicant for the modification if other than the owner, at his or her last known address.

29 **§28-216.8.3.3 Failure of owner to perform work.** If no action in accordance with the
30 modified precept is undertaken by the owner or applicant for modification within the time
31 period provided in the modification following the granting of such application, the
32 commissioner may direct the department of housing preservation and development or the
33 department of citywide administrative services or other authorized agency to execute the
34 original precept, provided however that prior to such execution, notice shall be provided by
35 regular mail to the owner of the unsafe building, structure or premises and applicant for the
36 modification if other than the owner, at his or her last known address. The owner shall
37 continue to have the right to request the commissioner to modify the requirements of the
38 precept prior to the execution thereof.

39 **§28-216.8.4 Interference prohibited.** It shall be unlawful for any person to interfere, obstruct
40 or hinder the commissioner or the commissioner of citywide administrative services, housing
41 preservation and development, or other authorized agency, or any person who, acting under the
42 authority conferred on such person by such commissioner, [~~is~~] is performing the work authorized
43 by a precept issued out of any court or modified in accordance with section 28-216.8.3, or the

1 work ordered by the commissioner in accordance with such precept under the provisions of
2 section 28-216.8.3.3.

3 **§28-216.8.5 Enforcement.** The police commissioner shall enforce such orders or requirements
4 when requested by the commissioner and shall likewise enforce same at the request of the
5 commissioner of citywide administrative services, the commissioner housing preservation and
6 development, or the commissioner of other authorized agency, with respect to work performed
7 by or under the direction of such commissioner pursuant to the provisions of section 28-
8 216.8.3.3.

9 **§28-216.9 Return of precept and reimbursement of city.** Upon compliance with any precept
10 issued to the commissioner in a proceeding under this article, the commissioner may make return
11 thereof, with an endorsement of the action there under and the costs and expenses thereby incurred,
12 to the justice of the court from which such precept issued. Such justice shall then tax and adjust the
13 amount endorsed upon such precept, and shall adjust and allow the disbursements of the proceeding,
14 including but not limited to the preliminary expenses of searches, service of the notice of survey and
15 summons on interested parties, surveys thereof, and costs of executing the precept, which shall be
16 inserted in the judgment in such proceeding. Such justice shall then render judgment for such amount
17 and for the sale of the premises named in such notice, together with all the right, title and interest
18 that the person named in such notice had in the lot, ground or land upon which such structure was
19 placed, at the time of the filing of a notice of pendency in such proceedings, or at the time of the
20 entry of judgment therein, to satisfy such judgment in foreclosure of mortgages. Nothing in this
21 article shall preclude the city from recovering such costs and expenses in any other lawful manner,
22 including pursuant to sections 28-112.9, 28-216.10 and 28-216.11~~[of this code]~~.

23 **§28-216.10 Judgment lien.** Any judgment rendered in an action or proceeding instituted under this
24 article shall be and become a lien upon the premises named in such action or proceeding, such lien
25 to date from the time of filing a notice of pendency in the office of the clerk of the county wherein
26 the property affected by such action or proceeding, is located. Every such lien shall have priority
27 before any mortgage or other lien as may exist prior to such filing except tax and assessment liens.

28 **§28-216.11 Tax lien.** Any costs and expenses incurred by any agency of the city pursuant to this
29 article, including but not limited to the preliminary expenses of searches, service of the notice of
30 survey and summons on interested parties, surveys thereof, and costs of executing the precept, shall
31 be a debt recoverable from the owner of the premises and a lien upon the land and buildings upon or
32 in respect to which such costs and expenses were incurred. Every such lien shall have priority over
33 all other liens and encumbrances on the premises except for the lien of taxes and assessments. Except
34 as otherwise provided by rule of the affected agency, the agency incurring such expense shall be
35 governed by the procedures set forth in article eight of subchapter ~~[five]~~ 5 of the New York city
36 housing maintenance code with respect to the enforcement of such debt and lien.

37 ARTICLE 217

38 BUILDINGS AND STRUCTURES THAT ARE POTENTIALLY COMPROMISED

39 **§28-217.1 Buildings and structures that are potentially structurally compromised.** For
40 purposes of this article, “potentially compromised” shall include a building or structure that: ~~[has~~
41 ~~had an open roof for sixty days or longer, that has been shored and braced or otherwise temporarily~~
42 ~~safeguarded pursuant to an emergency declaration issued by the commissioner, that has been subject~~

1 to a precept as a compromised structure under section 216.1.1 of this code or that may have suffered
2 structural damage by fire or any other cause as determined by the commissioner.]

- 3 1. Has had an open roof for 60 days or longer;
- 4 2. Has been shored and braced or otherwise temporarily safeguarded pursuant to an
5 emergency declaration issued by the commissioner, or due to concern for structural
6 integrity as determined by a registered design professional;
- 7 3. Has been subject to a precept as a compromised structure under section 28-216.1.1;
8 or
- 9 4. May have suffered structural damage by fire or any other cause as determined by the
10 commissioner.

11 **§28-217.1.1 Structural inspections of potentially compromised buildings or structures.**

12 When a building or structure has become potentially compromised, the owner [~~shall cause~~] is
13 required to have a structural inspection [of such building or structure to be] performed. Such
14 inspection shall be performed within 60 days of the opening of the roof, or within 60 days of the
15 [~~shoring and bracing or other temporary safeguards pursuant to an emergency declaration, or~~
16 ~~within 60 days of damage by fire or a determination by the commissioner that the building has~~
17 ~~suffered structural damage by other cause] onset of any of the conditions listed in section 28-
18 217.1. A report of such inspection shall be filed with the department within 30 days thereafter in
19 such form and detail and with provision for periodic monitoring of the building or structure as
20 the commissioner may require.~~

21 **§28-217.1.2** Structural inspections shall only be performed by a registered design professional
22 in good standing with the New York state department of education.

23 **§28-217.1.3** If a violation of any applicable statute, law, rule or regulation or any unsafe
24 condition that poses a threat to the structural integrity of the building or to the public is found
25 during the course of such inspection, the registered design professional performing the inspection
26 shall immediately notify the department and the owner of such violation or unsafe condition by
27 calling 311 and in writing.

28 **§28-217.1.4** An inspection of the buildings and structures subject to the inspection and filing
29 requirements of section [~~28-216.12~~] 28-217.1 shall be performed every year [~~or, for a specified~~
30 ~~building or structure, within such other period as determined by the commissioner but not longer~~
31 ~~than two years, and shall continue] until such time as the registered design professional
32 documents and certifies that the building or structure is no longer potentially compromised and
33 such certification is accepted by the commissioner.~~

34 **§28-217.1.5** The owner shall hire a registered design professional to perform a structural
35 inspection of buildings and structures subject to section 28-217.1 prior to the issuance of a permit
36 to alter, repair, demolish or enlarge such building or structure, except that the commissioner may
37 waive such inspection if a structural inspection of the entire building or structure has been
38 performed within the prior year.

39 [~~§28-217.16~~] **§28-217.1.6** Any owner of a building or structure shall notify the department in
40 writing that such building or structure has become potentially compromised immediately after

1 such owner knows or should have known of the condition. Such notice shall contain the name
2 and business address of the owner of record of such building or structure and shall identify the
3 building or structure by street address and tax block and lot. The notices required by this
4 subdivision shall be in such form and manner as established by the commissioner by rule.

5 **§28-217.1.7** If an owner subject to the inspection and filing requirements of this section fails to
6 file such report, the owner shall be liable for a civil penalty in an amount not less than [~~two~~
7 ~~thousand dollars~~] \$2,500. In such a case, the department may cause a structural inspection to be
8 conducted and a report filed.

9 **ARTICLE 218**
10 **SAFETY COMPLIANCE OFFICER**

11 **§28-218.1 Definition.** For purposes of this article, the terms "Safety Compliance Officer" and
12 "SCO" shall mean a person whose presence is required by the commissioner pursuant to section 28-
13 218.2 and who satisfies the qualifications of section 28-218.4.

14 **§28-218.2 Safety [~~Compliance Officer~~] compliance officer.** In addition to any other remedies or
15 penalties authorized by law, the commissioner in his or her discretion may require the presence of a
16 SCO at any permitted site that has received immediately hazardous violations that the commissioner
17 determines adversely affect public safety and require the presence of a SCO to protect public safety.
18 In any circumstance where a SCO is required, the commissioner [~~or designee~~] shall state in writing
19 the circumstances necessitating the SCO, and the duration of the compliance monitoring and/or
20 conditions that must be satisfied prior to the termination of the compliance monitoring.

21 **§28-218.3 Appointment of a safety compliance officer.** The owner or contractor shall employ,
22 at the owner's or contractor's expense, an SCO approved by the department.

23 **§28-218.4 Qualifications.** Safety compliance officers shall have experience in supervising the type
24 of construction operations being monitored. They shall be an architect or engineer who has
25 experience supervising construction projects in New York city, a licensed site safety manager or
26 coordinator or other licensee of the department, or a special inspector as provided for in article 115
27 of this title. Safety compliance officers shall carry insurance as required by the department.

28 [~~§28-218.3~~] **§28-218.5 Compliance monitoring.** The SCO shall monitor the operations related to
29 the circumstances and conditions that the commissioner [~~or designee~~] has identified pursuant to
30 section 28-218.2 until the areas of concern set forth by the commissioner [~~or designee~~] have been
31 addressed as determined by the commissioner [~~or designee~~], but in no case shall any monitoring
32 period exceed [~~ninety~~] 90 days. For such purpose, the SCO and his or her employees shall be
33 designated as authorized representatives of the commissioner with authority pursuant to section 28-
34 103.13 of this code to enter upon and examine and inspect at all reasonable times any site, building
35 or structure. In the event that the conditions [~~set out~~] set out in the commissioner's [~~or designee's~~]
36 determination, pursuant to section [~~28-217.2~~] 28-218.2, to require a SCO have not been satisfied
37 within the prescribed monitoring period, the commissioner [~~or designee~~] may order the general
38 contractor to appoint another SCO subject to the approval of the department, who shall be a different
39 SCO than the initial SCO, to monitor operations for an additional period not to exceed [~~ninety~~] 90
40 days.

1 **§28-218.5.1 Hazardous conditions.** In addition to any other requirements specified by the
2 commissioner, the SCO shall immediately report to the commissioner all conditions that are
3 hazardous to life, safety or health.

4 [~~§28-218.4 Qualifications. Safety Compliance Officers shall have experience in supervising the~~
5 ~~construction operations being monitored. They shall be an architect or engineer who has experience~~
6 ~~supervising construction projects in New York City, a licensed site safety manager or coordinator or~~
7 ~~other licensee of the department, or a special inspector as provided for in article 115 of this title.~~
8 ~~Safety Compliance Officers shall carry insurance as required by the department.]~~

9 [~~§28-218.5~~] **§28-218.6 Cost of a [Safety Compliance Officer] safety compliance officer.** The
10 owner of the site where the services of the SCO have been required shall reimburse the department
11 for all direct costs and any related administrative expenses incurred by the department in the
12 operation of the SCO program provided for in this article. Reimbursement shall be made at such
13 times as the department shall require, but in any event, before a temporary or permanent certificate
14 of occupancy is issued for the building or structure that is being monitored. No permit shall be issued
15 for the job site at which a SCO has been assigned if reimbursements for the cost of the monitor are
16 outstanding for more than [~~thirty~~] 30 days. The department shall adopt rules establishing a process
17 for the resolution of disputes concerning the costs of the SCO.

18 [~~§28-218.6~~] **§28-218.7 The SCO shall document with photographs or other means any**
19 **violation of the code.** The SCO shall submit [~~an interim report, to be submitted at the midpoint of~~
20 ~~the appointment period, and a final report~~] reports to the department in the frequency, manner and
21 form prescribed by the commissioner [~~or designee~~]. The department will share the results of these
22 reports with the general contractor and provide the general contractor an opportunity to comment.

23 [~~§28-218.7~~] **§28-218.8 Records.** The SCO shall keep and maintain records relating to the services
24 performed on behalf of the department in such manner and for such period of time as shall be
25 established by the commissioner [~~by rule or by direction of the commissioner~~].

ARTICLE 219

FAILURE TO CERTIFY CORRECTION OF CERTAIN IMMEDIATELY HAZARDOUS VIOLATIONS

29 **§28-219.1 Department penalty for failure to certify correction.** In addition to any penalties
30 otherwise authorized by law pursuant to article 202 and the rules of the department, whenever any
31 person fails to submit a certification of correction of an immediately hazardous violation that poses
32 a threat of imminent danger to public safety or property, as required by an order issued pursuant to
33 section 28-204.2, a penalty shall be paid to the department by the owner of the property in the
34 amount of not less than [~~one thousand five hundred dollars~~] \$1,500 or more than [~~five thousand~~
35 dollars] \$5,000. No permit or certificate of occupancy shall be issued and no stop work order may
36 be rescinded at the property named in the order until such penalty is paid to the department. Failure
37 to pay such penalty shall not prevent the issuance of a permit for work to be performed pursuant to
38 articles 215 or 216[~~of this chapter~~]. In addition, even if the immediately hazardous violation is
39 subsequently corrected, no certificate of correction shall be accepted for the violation giving rise to
40 this civil penalty until such penalty has been paid to the department.

1 **§28-219.2 [Reinspection] Re-inspection.** Where an immediately hazardous condition has been
2 identified as posing a threat of imminent danger to public safety or property and a violation has been
3 issued, the commissioner shall re-inspect the condition that gave rise to the violation within 60 days
4 of the date of the notice of a violation, unless:

- 5 1. [A] An acceptable certification of the correction of the condition has been filed in the manner
6 and form prescribed by the department;
- 7 2. The person to whom the violation has been directed has obtained an extension of time for
8 filing the certificate of correction of the violation from the commissioner in accordance with
9 section 28-204.4 and with any applicable rules of the department, and said extension of time
10 to file has not yet expired; or
- 11 3. The condition has been corrected in the presence of the commissioner.

12 **§28-219.2.1 Continued noncompliance.** If, upon re-inspection, the commissioner determines
13 the condition continues to pose a threat of imminent danger to public safety or property, and the
14 person against whom the initial violation was directed is not in compliance with section 28-
15 204.4, the commissioner shall issue an appropriate violation and shall issue a stop-work order,
16 pursuant to section 28-207.2, where appropriate, or the commissioner shall, if the commissioner
17 is unable to obtain access to the premises, request the corporation counsel to institute legal
18 proceedings to compel correction of the violation and abate the condition or take such other
19 action as is appropriate.

20 **§28-219.2.2 Inspections by the commissioner.** The commissioner shall continue to re-inspect
21 any condition that has given rise to an immediately hazardous violation that poses a threat of
22 imminent danger to public safety or property every 60 days, and shall follow the procedures
23 described in items 1, 2 and 3 of section [~~219.2~~] 28-219.2 until the condition has been found by
24 inspection or certification to be corrected or abated.

25 **§28-219.3 False certifications of correction.** It shall be unlawful to prepare, file or offer for filing
26 a certification of correction of an immediately hazardous condition, knowing that such certification
27 contains a false statement or false information. Any person who prepares such a certificate shall be
28 subject to prosecution under section 175.05 or 175.10 of the New York state penal law. Any person
29 who files such a certificate or offers such a certificate for filing shall be subject to prosecution under
30 section 175.30 or 175.35 of the New York state penal law. Nothing in this section shall be construed
31 to limit, alter or affect the authority conferred by any other provision of this chapter or other law to
32 bring criminal, civil or administrative actions or proceedings or other remedies for the preparation,
33 filing or offering for filing of a certification of correction of an immediately hazardous condition
34 containing a false statement or false information.

35 **§28-219.4 Notice to the department of housing preservation and development for certain**
36 **elevator-related violations.** If, upon [~~reinspection~~] re-inspection of an immediately hazardous
37 violation relating to an elevator that services one or more dwelling units in a multiple dwelling, the
38 department determines that such owner has failed to correct the condition constituting such violation,
39 then the commissioner shall refer such violation, within one week of such [~~reinspection~~] re-
40 inspection, to the commissioner of housing preservation and development for a determination as to
41 whether such violation is dangerous to human life and safety or detrimental to health pursuant to
42 section 27-2125 of the New York city housing maintenance code. If the department knows or has

1 reason to believe that any such unit is not served by another operable elevator, the department shall
2 include such information and any other relevant information in such referral. The department may
3 continue enforcement action against the owner of the multiple dwelling after referral of such violation
4 to the commissioner of housing preservation and development. Where the owner begins to take
5 corrective action, the department shall notify the commissioner of housing preservation and
6 development of such efforts. The department shall notify an owner of the referral of any such violation
7 to the commissioner of housing preservation and development for action under this section.

8 **Exceptions:**

- 9 1. Elevators located in owner-occupied multiple dwellings that service only the owner-
10 occupied dwelling unit [?] provided that such unit is not occupied by boarders, roomers,
11 or lodgers.
- 12 2. Elevators located within convents and rectories that are not open to non-occupants on a
13 regular basis.

14 § 3. Chapter 3 of title 28 of the administrative code of the city of New York, as added
15 by local law number 33 for the year 2007, the opening paragraph of section 28-302.2 as amended by
16 local law number 38 for the year 2007, item 1 of section 28-302.5, Articles 303, 304 and 305 and
17 section 28-306.1 as amended by, and sections 28-303.6, 28-303.8, 28-306.2, Article 314, sections 28-
18 315.1, 28-315.2, 28-315.3, 28-315.4, 28-315.5, 28-315.6 and 28-315.7 as added by, local law number
19 141 for the year 2013, section 28-304.6.1 as amended by chapter 750 of the laws of 2019, Article 308
20 as added by local law number 87 for the year 2009, Article 309 as added by local law number 84 for
21 the year 2009, sections 28-309.2, 28-309.8, 28-309.9 as amended by, and section 28-309.11 as added
22 by, local law number 133 for the year 2016, section 28-309.12 as added by local law number 33 for
23 the year 2018, section 28-309.13 as added by local law number 93 for the year 2020, sections 28-
24 310.1, 28-311.1 and 28-311.4 as added by local law number 88 for the year 2009, sections 28-310.2,
25 28-310.3 and 28-315.3.1 as amended by local law number 134 for the year 2016, sections 28-311.2,
26 28-311.3, 28-311.5 and 28-315.3.2 as amended by local law number 132 for the year 2016, sections
27 28-312.1, 28-312.2, 28-312.3, 28-312.4 and 28-312.5 as amended by, and sections 28-312.6, 28-312.7
28 and 28-315.2.4 as added by, local law number 157 for the year 2016, section 28-312.8 as added by
29 local law number 113 for the year 2018, sections 28-313.1 and 28-313.2 as added by local law number
30 47 for the year 2012, sections 28-313.3 and 28-315.6.3 as added by local law number 122 for the year
31 2019, section 28-315.2.3 as added by local law number 78 for the year 2015, sections 28-315.8 and
32 28-315.8.1 as added by local law number 110 for the year 2013, sections 28-315.8.2 and 28-315.8.3
33 as added by local law number 108 for the year 2013, section 28-315.9 as added by local law number
34 79 for the year 2016, section 28-315.10 as added by local law number 111 for the year 2018, section
35 28-315.11 as added by local law number 191 for the year 2018, section 28-316.1 as added by local
36 law number 12 for the year 2014, Article 317 as added by local law number 77 for the year 2015,
37 section 28-317.5 as amended by local law number 76 for the year 2019, Article 318 as added by local
38 law number 152 for the year 2016, Article 319 as added by local law number 105 for the year 2018,
39 sections 28-320.1 and 28-321.1 as amended by, and section 28-320.3.10.1 as added by, local law
40 number 116 for the year 2020, sections 28-320.2, 28-320.3.1.1, 28-320.3.2, 28-320.3.6, 28-320.3.6.1,
41 28-320.3.6.2, 28-320.3.6.3, 28-320.3.9, 28-320.6.1, 28-320.6.1, items 1 and 2 of section 28-320.7,
42 28-320.8 and 28-320.9 as amended by, and Article 322 as renumbered by, local law number 147 for
43 the year 2019, sections 28-320.3, 28-320.4, 28-320.5, 28-320.6, 28-320.7, 28-320.10, 28-320.11 and
44 Article 321 as added by local law number 97 for the year 2019, item 6 of section 28-320.3.1.1 and

1 section 28-320.3.2.1 as amended by local law number 95 for the year 2020, and section 28-320.3.7
2 as amended by and section 28-320.3.7.2 as added by local law number 117 for the year 2020, is
3 amended to read as follows:

4 **CHAPTER 3**

5 **MAINTENANCE OF BUILDINGS**

6 **ARTICLE 301**
7 **GENERAL**

8 **§28-301.1 Owner’s responsibilities.** All buildings and all parts thereof and all other structures shall
9 be maintained in a safe condition. All service equipment, means of egress, materials, devices, and
10 safeguards that are required in a building by the provisions of this code, the 1968 building code or
11 other applicable laws or rules, or that were required by law when the building was erected, altered,
12 or repaired, shall be maintained in good working condition. Whenever persons engaged in building
13 operations have reason to believe in the course of such operations that any building or other structure
14 is dangerous or unsafe, such person shall forthwith report such belief in writing to the department.
15 The owner shall be responsible at all times to maintain the building and its facilities and all other
16 structures regulated by this code in a safe and code-compliant manner and shall comply with the
17 inspection and maintenance requirements of this chapter.

18 **§28-301.1.1 Parapets.** A building’s parapet shall be maintained in a safe condition. A building
19 owner must have an annual parapet observation performed as described in the rules of the
20 department. This observation must be performed on all buildings, regardless of height.

21 **Exception:** The requirements of this section shall not apply to detached one- or two-family
22 homes.

23 **§28-301.2 Filing of reports in writing or electronically.** Reports required to be filed under this
24 chapter shall be filed in writing or electronically as the commissioner may require.

25 **ARTICLE 302**
26 **MAINTENANCE OF EXTERIOR WALLS**

27 **§28-302.1 General.** A building’s exterior walls and appurtenances thereof shall be maintained in a
28 safe condition. All buildings greater than six stories shall comply with the maintenance requirement
29 of this article.

30 **Exception:** The requirements imposed by this article shall not apply to any part of an exterior
31 wall that is less than 12 inches (305 mm) from the exterior wall of an adjacent building.

32 **§28-302.2 Inspection requirements.** A critical examination of a building’s exterior walls and
33 appurtenances thereof shall be conducted at periodic intervals as set forth by rule of the
34 commissioner, but such examination shall be conducted at least once ~~[every five years. No later than~~
35 ~~January 1, 2009 the commissioner shall by rule establish staggered inspection cycles for buildings~~
36 ~~required to comply with this section]~~ during each five-year report filing cycle, as defined by rule of
37 the department. The initial examination for a new building shall be conducted in the fifth year

1 following the erection or installation of any exterior wall and/or appurtenances as evidenced by the
2 issuance date of a temporary or final certificate of occupancy or as otherwise prescribed by rule.

- 3 1. Such examination shall be conducted on behalf of the building owner by or under the direct
4 supervision of a registered design professional with appropriate qualifications as prescribed
5 by the department.
- 6 2. Such examination shall include a complete review of the most recently prepared report and
7 an inspection.
- 8 3. Such examination shall be conducted in accordance with rules promulgated by the
9 commissioner.

10 **§28-302.3 Immediate notice of unsafe condition.** Whenever a registered design professional learns
11 of an unsafe condition through a critical examination of a building's exterior walls and appurtenances
12 thereof, such person shall notify the owner and the department immediately in writing of such
13 condition.

14 **§28-302.4 Report of critical examination.** The registered design professional shall submit a written
15 report to the commissioner within 60 days of completing the critical examination, [~~but not more than~~
16 ~~five years following submission of the preceding report of critical examination~~] at least once during
17 each five-year report filing cycle, as defined by rule of the department certifying the results of such
18 critical examination as either safe, unsafe or safe with a repair and maintenance program. The report
19 shall clearly document the condition of the exterior walls and appurtenances thereof and shall include
20 a record of all significant deterioration, unsafe conditions and movement observed as well as a
21 statement concerning the watertightness of the exterior surfaces. Such report must be [~~professionally~~
22 ~~certified~~] signed and sealed by such registered design professional.

23 **§28-302.5 Repair of exterior walls, unsafe condition.** Upon the notification to the department of
24 an unsafe condition, the owner, the owner's agent or the person in charge shall immediately
25 commence such repairs, reinforcements or other measures as may be required to secure public safety
26 and to make the building's exterior walls or appurtenances thereof conform to the provisions of this
27 code.

- 28 1. All unsafe conditions shall be corrected within 90 days of filing the critical examination
29 report.
- 30 2. The owner shall engage a registered design professional [~~shall~~] to reinspect the premises and
31 file an amended report within two weeks after the repairs have been completed certifying that
32 the unsafe conditions of the building have been corrected.
- 33 3. The commissioner may grant an extension of time of up to 90 days to complete the repairs
34 required to correct an unsafe condition upon receipt and review of an initial extension
35 application submitted by the registered design professional together with such additional
36 documentation as may be prescribed by rule.
- 37 4. The commissioner may grant further extensions of time to complete the repairs required to
38 remove an unsafe condition upon receipt and review of an application for a further extension
39 submitted by the registered design professional together with such further documentation as
40 may be prescribed by rule.

1 **§28-302.6 Safe condition with a repair and maintenance program.** The registered design
2 professional shall not file a report of a safe condition with a repair and maintenance program for the
3 same building for two consecutive filing periods unless the second such report is accompanied by
4 his or her professional certification attesting to the correction of all conditions identified in the prior
5 report as requiring repair.

6 **ARTICLE 303**
7 **PERIODIC BOILER INSPECTIONS**

8 **§28-303.1 General.** Periodic boiler inspections shall be performed in accordance with this article
9 and the provisions of section 1011.3 of the New York city mechanical code.

10 **§28-303.2 Annual inspections.** Except as otherwise provided in this article, each owner of a boiler,
11 as defined in section 204 of the New York state labor law, excepting those boilers listed in
12 subdivision five of such section of such labor law, shall have such boiler inspected at least once a
13 year in accordance with this article. All individuals who perform periodic inspections pursuant to
14 this article shall be qualified under section 204 of the New York state labor law and the rules
15 promulgated by the commissioner of labor or the commissioner of buildings.

16 **§28-303.2.1 Internal inspection required.** All high pressure boilers shall have an annual internal
17 inspection performed in accordance with section 204 of New York state labor law and the rules
18 of the department. Where construction of a low pressure boiler allows, an internal inspection
19 shall be performed on a periodic schedule in accordance with section 204 of the New York state
20 labor law and the rules of the department.

21 **§28-303.2.2 External inspection required.** All high and low pressure boilers shall have an
22 annual external inspection performed in accordance with section 204 of New York state labor law
23 and the rules of the department. Such inspection shall include chimney connectors.

24 **§28-303.2.3 Electric high pressure boilers.** Electric boilers operating at pressures or
25 temperatures classified as high pressure boilers, as defined in the New York city mechanical code,
26 shall be annually inspected as high pressure boilers in accordance with this article.

27 **§28-303.3 Qualifications of boiler inspectors.** All individuals who perform periodic inspections
28 pursuant to this article shall have the qualifications set forth in the rules of the department and in
29 section 28-303.3.1 or section 28-303.3.2 of this code, as applicable.

30 **§28-303.3.1 High-pressure boilers.** Inspections required by section 28-303.2 of this code for a
31 high-pressure boiler must be performed, in accordance with the rules of the department, on behalf
32 of the owner, by boiler inspectors in the employ of a duly authorized insurance company who
33 are qualified in accordance with section 204 of the New York state labor law.

34 **§28-303.3.2 Low-pressure boilers.** Inspections required by [~~Section~~] section 28-303.2 of a low-
35 pressure boiler must be performed, in accordance with the rules of the department, on behalf of
36 the owner, by boiler inspectors who are qualified in accordance with section 204 of the New York
37 state labor law.

1 **§28-303.4 Staggered inspection cycles.** The commissioner may by rule establish staggered
2 inspection cycles for buildings required to comply with this article.

3 **§28-303.5 Repair of defects.** The owner of each boiler that is subject to periodic inspection shall
4 correct any defects identified in the annual boiler inspection.

5 **§28-303.6 Reporting an unsafe or hazardous condition.** If an inspection reveals that any boiler is
6 unsafe or hazardous to life and safety, the device is to be immediately taken out of service by the
7 approved boiler inspection agency performing the inspection and the building owner shall be notified.
8 Such agency shall notify the department of the unsafe or hazardous condition of the boiler within 24
9 hours after the condition is discovered. Notification to the department may be made by telephone,
10 electronically or in writing.

11 **§28-303.7 Owner's annual boiler inspection report.** The owner of each boiler that is subject to
12 inspection pursuant to section 28-303.2 shall file a signed annual report with the commissioner in
13 accordance with the rules of the department within ~~[45]~~ 14 days after the required annual inspection
14 of the boiler has been performed. Extensions of time to file such report may be granted in accordance
15 with the rules of the department. The report shall include, but shall not be limited to:

- 16 1. The location of the boiler.
- 17 2. The name and address of the inspector, the qualification of the inspector to perform the
18 inspection, the date of inspection and if the inspector is a qualified boiler inspector in the
19 employ of a duly authorized insurance company, the policy number covering the boiler.
- 20 3. A list of all defects found in the inspection for each device inspected.

21 **§28-303.7.1 Affirmation of correction.** ~~[The owner must file an affirmation that all]~~ All defects
22 identified in the annual boiler inspection report ~~[have been corrected. Such affirmation must be~~
23 ~~filed with the department]~~ shall be corrected within ~~[120]~~ 90 days after the date of ~~[filing of the~~
24 ~~report.]~~ initial inspection. The department may grant an extension of 45 days upon submission of
25 an application by the owner demonstrating a practical difficulty in complying within the 90 day
26 timeframe. In no case shall a single extension request be granted for more than 45 days, and no
27 more than two such extensions be granted for a specific defect. An affirmation of correction shall
28 be filed within 14 days of the date of correction.

29 **§28-303.8 Scope of inspection.** During required inspection and testing, in addition to any other
30 requirements prescribed by this code or the rules of the department, all parts of the equipment shall
31 be inspected to determine that they are in safe operating condition and that parts subject to wear have
32 not worn to such an extent as to affect the safe and reliable operation of the boiler.

33 **§28-303.9 Removal or discontinuance notice.** The owner of a boiler that is removed or discontinued
34 from use shall file a written notice of such removal or discontinuance with the commissioner within
35 30 days of the date of removal or discontinuance.

36 **§28-303.10 Additional inspections.** In addition to the inspections required by this article, the
37 commissioner may make such additional inspections as required to enforce the provisions of this
38 code.

1 **§28-303.11 Fees.** The owner of each boiler subject to periodic inspection pursuant to this article shall
2 pay to the department an annual fee for each boiler in the amount prescribed by this code to cover
3 the city’s administrative and supervisory costs. The fee shall be payable at the time of the filing of
4 the owner’s annual boiler inspection report. No fee shall be charged for additional inspections made
5 by the department pursuant to section 28-303.10.

6 **ARTICLE 304**
7 **ELEVATORS AND CONVEYING SYSTEMS**

8 **§28-304.1 General.** Elevators and conveying systems shall be maintained in a safe condition and in
9 accordance with ASME A17.1, as modified by appendix K of the New York [City] city building
10 code. Every new and existing elevator or conveying system shall be inspected and tested in
11 accordance with this article.

12 **§28-304.2 Elevators, escalators, moving walkways, material lifts, man lifts and dumbwaiters.**
13 Elevators, escalators, moving walkways, material lifts, man lifts and dumbwaiters shall be inspected
14 and tested in accordance with section 28-304.6, chapter 30 of the New York city building code, and
15 the schedule set forth in Table N1 of ASME [17.1] A17.1 as [referenced in chapter 35 and as may
16 be] modified [in chapter 30 and] by chapter K1 of appendix K of the New York [City] city building
17 code [~~(“Table N1”)~~].

18 [~~**Exception:** Elevators located in one family, two family or multiple family dwellings that~~
19 ~~service only a single owner-occupied dwelling unit which is not occupied by boarders, roomers~~
20 ~~or lodgers, and elevators located within convents and rectories that are not open to non-occupants~~
21 ~~on a regular basis are not subject to periodic inspection requirement of such reference standard.~~
22 ~~Inspections and tests shall be performed in accordance with Table N1.~~]

23 **§28-304.3 [Chair] Platform lifts, stairway chair lifts and vertical reciprocating conveyors**
24 **(VRCs).** [~~Chair~~] Platform lifts, stairway chair [~~lifts~~] lifts and VRCs shall be inspected and tested at
25 intervals not exceeding one year. Inspections and tests shall be performed in accordance with Table
26 N1.

27 **§28-304.4 Amusement devices.** Amusement devices shall be inspected and tested in accordance
28 with department rules.

29 **§28-304.5 Frequency of inspection and testing.** Elevators and other conveying systems may be
30 subject to more frequent inspection and testing as the commissioner finds necessary to protect public
31 safety.

32 **§28-304.6 Inspection and testing process.** All devices shall be inspected and tested in accordance
33 with Table N1 of ASME A17.1 as modified by chapter K1 of appendix K of the New York city
34 building code and, where applicable, department rules and with sections 28-304.6.1 through 28-
35 304.6.6 of this code.

36 **§28-304.6.1 Inspection and testing entities.** [~~The required periodic inspections in Table N1 shall~~
37 ~~be made by the department.~~] The [~~other~~] required category tests and periodic inspections in Table
38 N1 of ASME A17.1 as modified by chapter K1 of appendix K of the New York City building
39 code shall be performed on behalf of the owner by an approved elevator agency in accordance

1 with this code and department rules. Where indicated in Table N1, tests [~~and inspections~~] shall
2 be witnessed by an approved elevator agency not affiliated with the agency performing the test,
3 and not affiliated with the agency performing the elevator work. Where indicated in Table N1,
4 inspections shall be performed by an approved elevator agency not affiliated with the agency
5 performing the maintenance. Not affiliated, as used in this section, shall mean the approved
6 elevator agency owners, directors and inspectors shall be independent of all relative approved
7 elevator agencies, maintenance firms or other entities providing any associated services to the
8 device owner. Such other tests and inspections shall comply with the timeframes established as
9 follows:

- 10 1. Category 1 [~~inspections and~~] tests shall be performed between January 1st and December
11 31st of each year at a minimal time interval of six months from the date of the previous
12 Category 1 testing. Category 1 tests are required on new installations the calendar year
13 following final acceptance test.
- 14 2. Category 3 [~~inspections and~~] tests for water hydraulics shall be performed every three
15 years on or before the anniversary month of the last Category 3 testing.
- 16 3. Category 5 [~~inspections and~~] tests shall be performed every five years on or before the
17 month of the final acceptance test for new elevators or the anniversary month of the last
18 Category 5 testing.
- 19 4. Periodic inspections shall be performed between January 1 and December 31 of each year
20 at a minimum of three months from the date of any Category 1 testing or previous periodic
21 inspection. Initial periodic inspections on new installations shall be performed in the
22 calendar year following the final acceptance test. For private residence elevators, the
23 periodic inspection and category testing may be performed on the same date.

24 **§28-304.6.1.1 Department notification.** The department shall be notified by the [~~performing~~
25 ~~agency~~] agency performing the test at least [~~seven~~] five days prior to the Category 1 testing
26 of escalators, Category 3 testing of water hydraulic elevators and Category 5 testing of
27 elevators, pursuant to the rules of the department.

28 **§28-304.6.2 Scope.** During periodic inspection and category testing, in addition to any other
29 requirements prescribed by this code, all parts of the equipment shall be inspected to determine
30 that they are in safe operating condition and that parts subject to wear have not worn to such an
31 extent as to affect the safe and reliable operation of the installation.

32 **§28-304.6.3 Reporting an unsafe or hazardous condition.** If [~~an~~] a periodic inspection or
33 category test reveals that any elevator or other conveying system is unsafe or hazardous to life
34 and safety, the device is to be taken out of service immediately by the agency performing the
35 inspection or test and the building owner notified immediately. The performing agency shall
36 notify the department by telephone, electronically or in writing within 24 hours.

37 **§28-304.6.4 [Field] Periodic inspection and category testing reports and notations on the**
38 **inspection certificate.** [Field] Periodic inspection and category testing reports and notations on
39 the inspection certificate shall comply with the requirements of sections 28-304.6.4.1 and 28-
40 304.6.4.2.

1 **§28-304.6.4.1 [When no witnessing agency is required] Periodic inspections.** [~~When no~~
2 ~~witnessing agency is required to witness~~] For the periodic inspections [and tests under] listed
3 in Table N1 of ASME A17.1, as modified by chapter K1 of appendix K of the New York city
4 building code, the performing inspector shall, on the day of each inspection [and test]: (i)
5 complete the [field] periodic inspection [and test] report, documenting all violating conditions,
6 if any, and affix his or her signature; (ii) provide a copy of such report to the owner or owner's
7 representative; and (iii) affix the [inspection] date and his or her signature over a stamp
8 identifying his or her approved elevator agency and his or her approval number on the
9 inspection certificate issued by the department attesting to completion of items (i) and (ii). No
10 witnessing agency is required to witness the periodic inspections.

11 **§28-304.6.4.2 [When] Category testing when a witnessing agency is required.** When a
12 witnessing agency is required to witness [~~inspections and~~] category tests [under] listed in
13 Table N1 of ASME A17.1, as modified by chapter K1 of appendix K of the New York city
14 building code, the performing inspector shall, on the day of each [inspection and] test
15 complete the [field inspection and] category test report, documenting all violating conditions,
16 if any, and affix his or her signature; and provide a copy of such report to the owner or owner's
17 representative with the witnessing agency inspector signature. The witnessing agency
18 inspector shall, on the day of each [inspection and] test: (i) review and confirm the [field
19 inspection] category test report and also affix his or her signature to it; (ii) [provide] confirm
20 that a copy of such report was provided to the owner or owner's representative; and (iii) affix
21 the [inspection] date and his or her signature over a stamp identifying his or her approved
22 elevator agency and his or her approval number on the inspection certificate issued by the
23 department attesting to the completion of items (i) and (ii).

24 **§28-304.6.4.3 Category testing when no witnessing agency is required.** When no
25 witnessing agency is required to witness the category tests listed in Table N1 of ASME A17.1,
26 as modified by chapter K1 of appendix K of the New York city building code, the performing
27 inspector shall, on the day of each test: (i) complete the category test report, documenting all
28 violating conditions, if any, and affix his or her signature; (ii) provide a copy of such report
29 to the owner or owner's representative; and (iii) affix the date and his or her signature over a
30 stamp identifying his or her approved elevator agency and his or her approval number on the
31 inspection certificate issued by the department attesting to completion of items (i) and (ii).

32 **§28-304.6.5 [Inspection and] Periodic inspection or category test reports submission.**
33 [~~Inspection and~~] Periodic inspection or category test reports shall be submitted to the department
34 on such forms and in such manner as required by the commissioner. Such reports shall comply
35 with the following and department rules[=].

36 **§28-304.6.5.1 Periodic inspection reports.** Reports of periodic inspections shall comply
37 with the following:

- 38 1. The reports shall contain the signatures of (i) the performing agency director, and (ii)
39 the building owner.
- 40 2. The reports, with all applicable signatures, shall be filed with the department within
41 14 days after the date of the inspection.

42 **§28-304.6.5.2 Category test reports.** Reports of category tests shall comply with the
43 following:

- 1 1. The ~~[inspection and test]~~ reports shall contain signatures of (i) the performing agency
2 inspector and director, (ii) the witnessing agency ~~[inspector and]~~ director, if required
3 under Table N1 of ASME A17.1 as modified by chapter K1 of appendix K of the New
4 York city building code, and (iii) the building owner.
- 5 2. The completed ~~[inspection and test]~~ reports, with all applicable signatures, shall be
6 ~~[delivered to the owner by the approved performing and/or witnessing agency within~~
7 ~~30 days of the test listing all violating conditions for each device tested, and]~~ filed with
8 the department within ~~[60]~~ 21 days after the date of the test ~~[by the owner or its~~
9 ~~authorized designee].~~

10 **Exception:** ~~[Inspection and test reports]~~ Reports are not required to be submitted to the
11 department for private residence wheelchair lifts and private residence dumbwaiters
12 devices. However, the owner shall maintain an inspection and test log to be available to
13 the department upon request.

14 **§28-304.6.6 [Repair.] Periodic inspection and category testing repair.** All defects as found in
15 periodic inspection and category testing reports shall be corrected in accordance with the
16 requirements of sections 28-304.6.6.1 and 28-304.6.6.2 of this code, except that all hazardous
17 conditions and defects related to firefighters' Phase I emergency recall operations or Phase II
18 emergency in-car operation as required by section 3003.2 of the New York city building code
19 shall be corrected immediately.

20 **§28-304.6.6.1 Category test repair.** All defects as found in such category test report shall
21 be corrected within 90 days after the date of inspection. The department may grant an
22 extension of 45 days upon submission of an application by the owner demonstrating a
23 practical difficulty in complying within the 90 day timeframe. In no case shall more than two
24 such extensions be granted for a specific defect. An affirmation of correction shall be filed
25 within 14 days after the date of correction.

26 **§28-304.6.6.2 Periodic inspection repair.** All defects as found in such ~~[inspection and test~~
27 ~~reports]~~ periodic inspection report shall be corrected within ~~[120]~~ 90 days after the date of
28 ~~[inspection and]~~ test ~~[, except all hazardous conditions shall be corrected immediately].~~ An
29 affirmation of correction shall be filed within ~~[60]~~ 14 days of the date of correction.

30 **§28-304.7 Required contract.** The owner of all new and existing passenger elevators, freight
31 elevators, and escalators shall have a contract with an approved elevator agency to perform elevator
32 and escalator maintenance, repair and replacement work as defined by ASME A17.1 as modified by
33 chapter K1 of appendix K of the New York ~~[City]~~ city building code. The name, address and
34 telephone number of such agency shall be maintained at each premises, on the mainline disconnect
35 switch and in a location readily accessible to employees of the department and to maintenance and
36 custodial staff at the premises.

37 **§28-304.8 Fees.** Every owner of elevators and other devices shall pay to the department ~~[an~~
38 ~~inspection fee and]~~ a report filing fee for each elevator or device in the amount prescribed by ~~[this~~
39 ~~code]~~ the department's rules.

40 **§28-304.9 Additional inspections.** The commissioner may make such additional inspections as
41 required to enforce the provisions of this code. No fee shall be charged for such additional
42 inspections.

1 **§28-304.10 Occupant notification for elevator work.** In occupancy groups R-1 and R-2, when an
2 elevator is to be out of service, a notice identifying the type of work to be performed and the expected
3 start and end dates for such outage shall be provided in English, Spanish, and such other languages
4 as the department may provide by rule, in accordance with sections 28-304.10.1 and 28-304.10.2.

5 **§28-304.10.1 Occupant notification for alteration work.** When an elevator is to be out of
6 service for alteration work, notice shall be given to the residential occupants no fewer than 10
7 business days before the start of the work, except in case of emergency repairs. This notification
8 requirement does not apply to minor alterations and ordinary repairs.

9 **§28-304.10.2 Occupant notification for other elevator service outages.** When all elevators
10 servicing a building or any section of a building are expected to be out of service for two or more
11 hours, notice shall be posted at least twenty-four hours before the start of the work. When all
12 elevators servicing a building or any section of a building are expected to be out of service for
13 less than two hours, or are out of service as the result of emergency work, notice is not required
14 to be posted, except that where such outage lasts for two or more hours, notice shall be posted as
15 soon as practicable after the commencement of such service outage.

16 **ARTICLE 305**
17 **RETAINING WALLS, PARTITION FENCES AND OTHER SITE STRUCTURES**

18 **§28-305.1 Retaining walls, partition fences and other site structures.** In addition to the
19 requirements set forth in chapter 33 of the New York [~~City~~] city building code, the responsibility for
20 maintaining and repairing retaining walls, partition fences and other site structures shall be in
21 accordance with sections 28-305.1.1, [~~305.1.2~~] 28-305.1.2, and [~~305.4~~] 28-305.4 of this code.

22 **§28-305.1.1 Structures located on the lot line of adjacent properties and partially on both**
23 **properties.** The owners of adjacent properties shall be responsible jointly for the proper
24 maintenance and repair of retaining walls, partition fences and other site structures, or portions
25 thereof, that are located along the common lot line and on both their properties; and each such
26 owner shall be responsible for one-half of the costs of maintaining and repairing such fences,
27 retaining walls and other site structures, or such portions thereof. Where an owner elects to
28 remove temporarily a retaining wall or partition fence that is required to support a grade
29 differential between the two properties, or for any other reason is required by this code, such
30 owner shall protect the adjacent property, shall not impair its safe use, and shall replace the
31 retaining wall or partition fence at his or her own cost. Refer to chapter 33 of the New York
32 [~~City~~] city building code for additional requirements during construction and demolition
33 operations.

34 **§28-305.1.2 Structures located entirely on one property.** Where such retaining walls, partition
35 fences or other site structures, or portions thereof, are located entirely on one property, the owner
36 of such property shall be wholly responsible for the proper maintenance and repair of the
37 retaining wall, partition fence or other site structure. If, however, the proper maintenance and/or
38 repair of such retaining wall, partition fence or other site structures requires access to the
39 adjoining property, the owner of such adjoining property shall allow such access. Refer to chapter
40 33 of the New York [~~City~~] city building code for additional requirements during construction
41 and demolition operations.

1 **§28-305.2 Retaining walls required.** Hereafter, when an owner elects to set his or her grade either
2 higher or lower than the grade of an adjoining property at the property line, such owner shall erect,
3 maintain and repair a retaining wall of sufficient height, structure and foundation to support such
4 grade differential, and with proper drainage, in accordance with this code, such that the adjacent
5 property is not impacted, and shall do so at the sole expense of such owner and entirely on the
6 property of such owner without access to the adjoining property.

7 **§28-305.3 Special agreement.** Nothing in this article shall be construed to prevent the owners of
8 adjacent properties from making or enforcing by private action special agreements with respect to
9 maintenance or repair of retaining walls, partition fences and other site structures or access to
10 adjoining property for such purpose.

11 **§28-305.4 Maintenance, inspection and repair of retaining walls.** Maintenance, inspection and
12 repair of retaining walls shall comply with sections 28-305.4.1 through 28-305.4.8.

13 **§28-305.4.1 Definition.** As used in this article, the following term shall have the following
14 meaning:

15 **RETAINING WALL.** A wall that resists lateral pressures and limits lateral displacement caused
16 by soil, rock, water or other materials, except that basement and vault walls that are part of a
17 building, underground structures, including but not limited to utility vault structures, tunnels,
18 transit stations and swimming pools, shall not be considered retaining walls.

19 **§28-305.4.2 Owner’s responsibility.** Owners of retaining walls with a height of ten feet or more
20 and fronting a public right-of-way shall comply with the requirements of this section. For the
21 purposes of this section, the height of a retaining wall shall be the distance from the top of the
22 ground in front of the wall to the top of the wall stem, or wall step for stepped walls, including
23 any parapets or fencing capable of retaining material.

24 **§28-305.4.3 Condition assessment requirements.** A condition assessment of a retaining wall
25 shall be conducted at periodic intervals as set forth by rule of the commissioner, but such
26 assessment shall be conducted at least once every [5] five years. The commissioner may establish
27 staggered assessment cycles for retaining walls required to comply with this section.

28 **§28-305.4.3.1 Registered design professional.** The condition assessment shall be conducted
29 on behalf of the owner by or under the direct supervision of a registered design professional
30 with appropriate qualifications as prescribed by the department.

31 **§28-305.4.3.2 Department rules.** The condition assessment shall be conducted in
32 accordance with rules promulgated by the commissioner.

33 **§28-305.4.4 Report of condition assessment.** A report of condition assessment shall be
34 submitted to the department in accordance with sections 28-305.4.4.1 and 28-305.4.4.2.

35 **§28-305.4.4.1 Submission deadlines.** Except as otherwise provided in section 28-305.4.6,
36 the registered design professional shall submit a written report to the commissioner within
37 60 days of completing the assessment, but not more than [5] five years following submission
38 of the preceding report of assessment, certifying the results of the assessment.

1 **§28-305.4.4.2 Contents.** The report shall certify the results of the assessment as either safe,
2 safe with minor repair or safe with repair and/or engineering monitoring, as prescribed by
3 rules of the department. The report shall clearly document the condition of the retaining wall
4 and shall include a record of all significant deterioration, potentially unsafe conditions of the
5 wall or affecting the wall, and movement observed. The report must be certified by the
6 registered design professional.

7 **§28-305.4.5 Fees.** Every owner of a retaining wall shall pay to the department a report filing fee
8 for each report of condition assessment in the amount prescribed by this code.

9 **§28-305.4.6 Immediate notice of unsafe condition.** Whenever the registered design professional
10 under whose supervision the inspection is performed learns of an unsafe condition through a
11 condition assessment of a retaining wall, such person shall notify the owner and the department
12 of such condition immediately by calling 311 and by written notification to the department.

13 **§28-305.4.7 Repair of unsafe condition.** Upon the notification to the department of an unsafe
14 condition, the owner or the owner’s agent shall immediately commence such repairs,
15 reinforcements or other measures as may be required to secure public safety.

16 **§28-305.4.7.1 Permit.** The owner or the owner’s agent shall obtain a permit within the time
17 set forth in the rules of the department in order to correct the unsafe condition, after securing
18 public safety as provided above.

19 **§28-305.4.7.2 Monitoring.** The owner or the owner’s agent shall monitor the protection of
20 public safety until the unsafe condition is remedied.

21 **§28-305.4.7.3 Reinspection.** The owner or the owner’s agent shall reinspect the retaining
22 wall and file an amended report within two weeks after the repairs have been completed
23 certifying that the unsafe conditions of the retaining wall have been corrected.

24 **§28-305.4.7.4 Extension.** The commissioner may grant an extension of time of up to 90 days
25 from the date of the application for an extension to complete the repairs required to correct
26 an unsafe condition upon receipt and review of an initial extension application submitted by
27 the registered design professional together with such additional documentation as may be
28 prescribed by rule.

29 **§28-305.4.7.5 Further extension.** The commissioner may grant further extensions of time to
30 complete the repairs required to remove an unsafe condition upon receipt and review of an
31 application for a further extension submitted by the registered design professional together
32 with such further documentation as may be prescribed by rule.

33 **§28-305.4.8 Safe with repair and/or engineering monitoring.** A retaining wall or any part
34 thereof that may pose a potential danger to persons or property, but does not require immediate
35 action shall be rated safe with repair and/or engineering monitoring. This condition requires
36 further investigation and timely remedial action to prevent its deterioration into an unsafe
37 condition. A registered design professional shall be responsible for appropriately monitoring the
38 wall until the repair is completed.

39 **§28-305.4.8.1 Safe with repair and/or engineering monitoring for two cycles.** The
40 registered design professional shall not file a report of safe with repair and/or engineering
41 monitoring for the same retaining wall for [2] two consecutive filing periods unless the

1 second such report is accompanied by his or her professional certification attesting to the
2 correction of all conditions identified in the prior report as requiring repair.

3 **§28-305.5 Removal of retaining structures.** Any retaining structure, standing partly on the land of
4 each owner, may be removed by either owner when the original reason for the erection of such
5 retaining structure ceases to exist. Notification shall be provided to the adjoining property owner.

6 **ARTICLE 306**
7 **PARTY WALLS**

8 **§28-306.1 Responsibility for party walls.** Repair and maintenance of the construction, design and
9 fire-resistance rating of party walls shall be the joint responsibility of the owners of the adjoining
10 properties, and any change by either owner must maintain the weather protection, structural, vertical
11 fire division and other requirements of this code for party walls.

12 **§28-306.2 Safeguards during construction or demolition.** Refer to section [B~~C~~] 3309 of the New
13 York [~~City~~] city building code for additional requirements for the maintenance of party walls during
14 construction or demolition operations.

15 **ARTICLE 307**
16 **WORKPLACE EXITS**

17 **§28-307.1 Obstruction of workplace exits prohibited.** Except for the exemptions specified in
18 subdivision j of section 27-371 of the New York city administrative code or chapter 10 of the New
19 York [~~City~~] city building code, as applicable, it shall be unlawful for an employer or the agent of an
20 employer to lock the doors of a workplace or otherwise obstruct or prohibit exit from a workplace
21 when such act may endanger the health or safety of any employee, independent contractor or other
22 individual in such workplace in the event of a fire or other hazardous condition or event. The
23 commissioner shall classify a violation of this section as an immediately hazardous violation.
24 Notwithstanding any other provision of this code, upon criminal conviction or civil adjudication of
25 liability for a violation of this section an additional fine or civil penalty of not less than [~~five thousand~~
26 ~~dollars~~] \$5,000 nor more than [~~twenty thousand dollars~~] \$20,000 shall be imposed for each
27 employee, independent contractor or other individual endangered by a violation of this section.

28 **§28-307.1.1 Notice.** A sign shall be posted conspicuously at the workplace of a person convicted
29 of or found liable for a violation of section 28-307.1. Such sign shall, in English, Spanish,
30 Korean, Chinese or any other language directed by the fire commissioner, provide notice to
31 employees of the acts prohibited by section 28-307.1 and of the remedies for employer retaliation
32 as set forth in section 28-307.3. The sign shall be in a form and posted in a manner directed by
33 the fire commissioner and may contain any other information deemed necessary by the fire
34 commissioner or as recommended by the police commissioner or the commissioner. The fire
35 commissioner may, in the interest of public safety, adopt a rule requiring the posting of such
36 signs at other workplaces.

37 **§28-307.2 Unannounced inspections of workplaces by fire department.** In addition to any other
38 inspections required by law or rule, the fire department shall conduct a minimum of [~~fifty~~] 50
39 unannounced workplace inspections annually to ensure the identification and abatement of any

1 hazardous conditions in violation of section 28-307.1. Such inspections shall include, but not be
2 limited to, sites where there are known or suspected conditions affecting employee safety and health.

3 **§28-307.3 Retaliation.** It shall be unlawful for an employer or the agent of such employer to take a
4 retaliatory action, as defined by section 740 of the New York state labor law, against an employee
5 because of the lawful acts of such employee in furtherance of a civil or criminal enforcement
6 proceeding arising out of the failure of such employer or agent to comply with section 28-307.1 of
7 this code. An employee who is the victim of such retaliatory action may commence an action in any
8 court of competent jurisdiction for the relief provided for in this section and shall be entitled to all
9 relief necessary to make such employee whole. Lawful acts of an employee shall include, but not be
10 limited to, assisting in the investigation and initiation of an enforcement proceeding alleging a
11 violation of section 28-307.1 of this code, providing testimony in any such proceeding or providing
12 other assistance in connection therewith. The relief to which such employee shall be entitled shall
13 include, but not be limited to, (i) an injunction to restrain any adverse or retaliatory action, (ii)
14 reinstatement to the position such officer or employee would have had but for such action, or to an
15 equivalent position, (iii) reinstatement of full benefits and seniority rights including payment of any
16 missed back pay, plus interest and (iv) compensation for any special damages sustained as a result
17 of such action, including litigation costs and reasonable attorneys' fees.

18 **ARTICLE 308**
19 **ENERGY AUDITS AND RETRO-COMMISSIONING OF BASE BUILDING SYSTEMS**

20 **§28-308.1 Definitions.** As used in this article, the following terms shall have the following meanings:

21 **BASE BUILDING SYSTEMS.** The systems or subsystems of a building that use energy and/or
22 impact energy consumption including:

- 23 1. The building envelope.
- 24 2. The [~~HVAC~~] [~~(h)eating ventilating and air conditioning()~~] (HVAC) systems.
- 25 3. Conveying systems.
- 26 4. Domestic hot water systems.
- 27 5. Electrical and lighting systems.

28 **Exception:** The term "base building systems" shall not include:

- 29 1. Systems or subsystems owned by tenants (other than a net lessee for a term of 49 years
30 or more, inclusive of renewal options), condominium unit owners or cooperative unit
31 shareholders, or a system or subsystems for which a tenant bears full maintenance
32 responsibility and that is within the tenant's leased space and/or exclusively serves such
33 leased space.
- 34 2. Industrial processes that occur within a covered building.

35 **BUILDING MANAGEMENT SYSTEM.** A computer-based system that monitors and controls a
36 building's mechanical and electrical equipment, such as HVAC, lighting, power, fire, and security
37 systems, including, at a minimum, control of the heating equipment using interior temperature
38 sensors.

1 **CITY BUILDING.** A covered building that is owned by the city and for which the city regularly
2 pays all or part of the annual energy bills.

3 **Exception:** The term "city building" shall not include:

- 4 1. Any building that participates in the tenant interim lease apartment purchase program.
- 5 2. Any building that participates in a program administered by the department of housing
6 preservation and development.
- 7 3. Any building managed by the New York [~~City~~] city health and hospitals corporation.
- 8 4. Any senior college in the City University of New York system.
- 9 5. Any cultural institution that is in the Cultural Institutions Group as determined by the
10 department of cultural affairs.

11 **COOPERATIVE CORPORATION.** A corporation governed by the requirements of the state
12 cooperative corporation law or general business law that, among other things, grants persons the right
13 to reside in a cooperative apartment, that right existing by such person's ownership of certificates of
14 stock, proprietary lease, or other evidence of ownership of an interest in such entity.

15 **COVERED BUILDING.** As it appears in the records of the department of finance: (i) a building
16 that exceeds 50,000 gross square feet (4645 m²), (ii) two or more buildings on the same tax lot that
17 together exceed 100,000 gross square feet (9290 m²), or (iii) two or more buildings held in the
18 condominium form of ownership that are governed by the same board of managers and that together
19 exceed 100,000 gross square feet (9290 m²).

20 **Exception:** The term "covered building" shall not include real property classified as class one
21 pursuant to subdivision one of section eighteen hundred two of the real property tax law of the
22 state of New York.

23 **CURRENT FACILITY REQUIREMENTS.** The owner's current operational needs and
24 requirements for a building, including temperature and humidity set points, operating hours,
25 filtration, and any integrated requirements such as controls, warranty review, and service contract
26 review.

27 **ENERGY AUDIT OR AUDIT.** A systematic process of identifying and developing modifications
28 and improvements of the base building systems, including but not limited to alterations of such
29 systems and the installation of new equipment, insulation or other generally recognized energy
30 efficiency technologies to optimize energy performance of the building and achieve energy savings,
31 provided that such process shall not be less stringent than the Level II Energy Survey and
32 Engineering Analysis of the 2004 edition of Procedures for Commercial Building Energy Audits
33 published by the American Society of Heating, Refrigerating and Air-conditioning Engineers Inc.
34 (ASHRAE).

35 **ENERGY AUDITOR.** An approved agency authorized by the department to perform energy audits
36 and to certify audit reports required by this article. Until such time as there is a national standard
37 establishing qualifications for persons performing energy audits and such standard has been adopted
38 by the department, an energy auditor shall be a registered design professional with such other
39 certification or qualification as the department deems to be appropriate. After the establishment of

1 such a national standard, the department may adopt the qualifications of the national standard with
2 such modifications as the department deems to be appropriate.

3 **ENERGY MANAGEMENT SYSTEM.** A system incorporating interior temperature sensors and a
4 central processing unit and controls, which are used to monitor and control gas, steam and oil usage,
5 as is applicable, based on the need for heating.

6 **ENERGY EFFICIENCY REPORT.** The report required to be filed pursuant to section 28-308.4.

7 **FINANCIAL HARDSHIP (OF A BUILDING).** A building shall be considered to be subject to
8 financial hardship if the building:

- 9 1. Had arrears of property taxes or water or wastewater charges that resulted in the property's
10 inclusion, within two years prior to the due date of an energy efficiency report, on the
11 department of finance's annual New York City tax lien sale list;
- 12 2. Is exempt from real property taxes pursuant to sections 420-a, 420-b, 446 or 462 of the New
13 York state real property tax law and applicable local law and the owner had negative revenue
14 less expenses during the two tax years prior to the due date of an energy efficiency report as
15 certified to the department by a certified public accountant;
- 16 3. Had outstanding balances under the department of housing preservation and development's
17 emergency repair program that resulted in the property's inclusion, within two years prior to
18 the due date of an energy efficiency report, on the department of finance's annual New York
19 City tax lien sale list; or
- 20 4. Has an active or effective commitment letter from a governmental agency that provides for
21 the financing of the rehabilitation, within a period of [~~5~~] five years or less, of such building
22 by such government agency for the purposes of affordable housing for low or moderate
23 income families.

24 **OWNER.** The owner of record of a covered building, except that in the case of a net lease of an
25 entire building for a term of 49 years or more, inclusive of renewal options, the term owner shall
26 refer to the net lessee and in the case of a covered building held in cooperative or condominium form
27 of ownership, the term owner shall refer to the board of managers in the case of a condominium and
28 the board of directors in the case of a cooperative apartment corporation.

29 **RETRO-COMMISSIONING.** A systematic process for optimizing the energy efficiency of
30 existing base building systems through the identification and correction of deficiencies in such
31 systems, including but not limited to repairs of defects, cleaning, adjustments of valves, sensors,
32 controls or programmed settings, and/or changes in operational practices.

33 **RETRO-COMMISSIONING AGENT.** An individual, who shall not be a certified refrigerating
34 system operating engineer or a licensed high pressure boiler operating engineer on the staff of the
35 building being retro-commissioned, authorized by the department to certify retro-commissioning
36 reports required by this article. Until such time as there is a national standard establishing
37 qualifications for persons who perform retro-commissioning and such standard has been adopted by
38 the department, a retro-commissioning agent shall be a registered design professional, a certified
39 refrigerating system operating engineer, or a licensed high pressure boiler operating engineer, with
40 such other qualification or certification as determined by the department. After the establishment of

1 such a national standard, the department may adopt the qualifications of the national standard with
2 such modifications as the department deems to be appropriate.

3 **SIMPLE BUILDING.** A covered building with neither a central chilled water system nor a central
4 cooling system that covers more than 10 percent of the building’s gross area.

5 **SIMPLE PAYBACK.** The number of years for the projected annual energy savings to equal the
6 amount invested in the energy conservation measure, as determined by dividing the investment by
7 the annual energy savings.

8 **SPACE.** An area within a building enclosed by floor to ceiling walls, partitions, windows and doors.

9 **SYSTEM OR SUBSYSTEM.** Shall have the same definition as set forth in section two hundred
10 two of the New York [City] city energy conservation code.

11 **§28-308.2 Energy audits required.** The owner shall ensure that an energy audit is performed on the
12 base building systems of a covered building prior to filing an energy efficiency report as required by
13 this article. Except as otherwise provided in section 28-308.7, an energy audit shall be performed by
14 or under the supervision of an energy auditor and shall be performed in accordance with rules
15 promulgated by the department. The audit process shall cover the base building systems and shall
16 identify at a minimum:

- 17 1. All reasonable measures, including capital improvements, that would, if implemented, reduce
18 energy use and/or the cost of operating the building;
- 19 2. For each measure, the associated annual energy savings, the cost to implement, and the
20 simple payback, calculated by a method determined by the department;
- 21 3. The building’s benchmarking output consistent with the United States Environmental
22 Protection Agency Portfolio Manager tool or as otherwise established by the department;
- 23 4. A break-down of energy usage by system and predicted energy savings by system after
24 implementation of the proposed measures; and
- 25 5. A general assessment of how the major energy consuming equipment and systems used
26 within tenant spaces impact the energy consumption of the base building systems based on a
27 representative sample of spaces.

28 **Exceptions:**

- 29 1. No energy audit is required if the building complies with one of the following as certified
30 by a registered design professional:
 - 31 1.1. The covered building has received an EPA Energy Star label for at least two of the
32 three years preceding the filing of the building’s energy efficiency report.
 - 33 1.2. There is no EPA Energy Star rating for the building type and a registered design
34 professional submits documentation, as specified in the rules of the department, that
35 the building’s energy performance is 25 or more points better than the performance
36 of an average building of its type over a two-year period within the three-year period
37 prior to the filing of an energy efficiency report consistent with the methodology of
38 the LEED 2009 rating system for Existing Buildings published by the United States

1 Green Building Council or other rating system or methodology for existing
2 buildings, as determined by the department.

3 1.3. The covered building has received certification under the LEED 2009 rating system
4 for Existing Buildings published by the United States Green Building Council or
5 other rating system for existing buildings, as determined by the department, within
6 four years prior to the filing of the building's energy efficiency report.

7 2. An energy audit shall not be required for the first energy efficiency report of a simple
8 building that is in compliance with six out of seven of the following items as certified by
9 a registered design professional:

10 2.1. Individual heating controls. (i) Each dwelling unit in the building has one or
11 more thermostatic controls controlling all the heating units within the dwelling
12 unit and any heated space not within a dwelling unit has one or more
13 thermostatic controls controlling all the heating units within the space, or (ii)
14 the building has a central heating system controlled by an energy management
15 system or a building management system that incorporates temperature sensors
16 located in at least 10 percent of the dwelling units and 10 percent of the heated
17 spaces, except that the total number of sensors required within the building shall
18 not be less than 10 nor more than 30.

19 2.2. Common area and exterior lighting. Common area (lighting outside of tenant
20 spaces) and exterior lighting, at a minimum, are in compliance with the
21 provisions of the New York [City] city energy conservation code as in effect for
22 new systems installed on or after July 1, 2010.

23 2.3. Low flow faucets and shower heads. All faucets and showerheads within the
24 building, at a minimum, meet the standards of Table 604.4 of the New York
25 [City] city plumbing code as in effect for new systems installed on or after July
26 1, 2010.

27 2.4. Pipe insulation. All exposed pipes that are used to convey heat or hot water are
28 insulated, at a minimum, in accordance with the standards of the New York
29 [City] city energy conservation code as in effect for new systems installed on or
30 after July 1, 2010.

31 2.5. Domestic hot water. All domestic hot water tanks that do not have built-in
32 insulation are insulated with a minimum insulation value of R-8.

33 2.6. Washing machines. All common area clothes washing machines are front
34 loading.

35 2.7. Cool roof. The roof complies with section 1504.8 of the New York [City] city
36 building code as in effect for new buildings constructed on or after July 1, 2010.

37 **§28-308.2.1 Contents of audit report.** The energy auditor shall prepare and certify a report of
38 the energy audit. Except as otherwise provided in section 28-308.7, the audit report shall include
39 such information relating to the audit as shall be specified in the rules of the department,
40 including but not limited to (i) the date that the audit was completed, and (ii) the information
41 specified in section 28-308.2.

1 **§28-308.2.1.1 Compliance with landmarks laws.** The cost estimates for covered buildings
2 that are regulated by any city, state or federal law regulating landmarks and historic buildings
3 shall include all additional costs necessary for the proposed work to comply with such law.

4 **§28-308.2.2 Timing of energy audit.** Except as otherwise provided in section 28-308.7, the
5 energy audit shall be completed no earlier than four years prior to the date on which a covered
6 building’s energy efficiency report is filed with the department pursuant to this article.

7 **§28-308.3 Retro-commissioning required.** The owner shall ensure that retro- commissioning is
8 performed on the base building systems of a covered building prior to filing an energy efficiency
9 report as required by this article. Except as otherwise provided in section 28-308.7, retro-
10 commissioning shall be performed by or under the supervision of a retro-commissioning agent in
11 accordance with rules promulgated by the department. Such rules, at a minimum, shall ensure that
12 sufficient analysis, corrections and testing have been done so that the base building systems meet
13 the following criteria demonstrating efficient operation:

14 1. Operating protocols, calibration, and sequencing:

15 1.1. HVAC temperature and humidity set points and setbacks are appropriate and operating
16 schedules reflect major space occupancy patterns and the current facility requirements.

17 1.2. HVAC sensors are properly calibrated.

18 1.3. HVAC controls are functioning and control sequences are appropriate for the current
19 facility requirements.

20 1.4. Loads are distributed equally across equipment when appropriate (i.e. fans, boilers,
21 pumps, etc. that run in parallel).

22 1.5. Ventilation rates are appropriate for the current facility requirements.

23 1.6. System automatic reset functions are functioning appropriately, if applicable.

24 1.7. Adjustments have been made to compensate for oversized or undersized equipment so
25 that it is functioning as efficiently as possible.

26 1.8. Simultaneous heating and cooling does not occur unless intended.

27 1.9. HVAC system economizer controls are properly functioning, if applicable.

28 1.10. The HVAC distribution systems, both air and water side, are balanced.

29 1.11. Light levels are appropriate to the task.

30 1.12. Lighting sensors and controls are functioning properly according to occupancy,
31 schedule, and/or available daylight, where applicable.

32 1.13. Domestic hot water systems have been checked to ensure proper temperature settings.

33 1.14. Water pumps are functioning as designed.

34 1.15. System water leaks have been identified and repaired.

35 2. Cleaning and repair:

36 2.1. HVAC equipment (vents, ducts, coils, valves, soot bin, etc.) is clean.

37 2.2. Filters are clean and protocols are in place to replace, as appropriate.

- 1 2.3. Light fixtures are clean.
- 2 2.4. Motors, fans, and pumps, including components such as belts, pulleys, and bearings,
- 3 are in good operating condition.
- 4 2.5. Steam traps have been replaced as required to maintain efficient operation, if
- 5 applicable.
- 6 2.6. Manual overrides on existing equipment have been remediated.
- 7 2.7. Boilers have been tuned for optimal efficiency, if applicable.
- 8 2.8. Exposed hot and chilled water and steam pipes 3 inches (76 mm) or greater in diameter
- 9 with associated control valves are insulated in accordance with the standards of the
- 10 New York [City] city energy conservation code as in effect for new systems installed
- 11 on or after July 1, 2010.
- 12 2.9. In all easily accessible locations, sealants and weather stripping are installed where
- 13 appropriate and are in good condition.

14 3. Training and documentation:

- 15 3.1. Permits for all HVAC, electrical and plumbing equipment are in order.
- 16 3.2. Critical operations and maintenance staff have received appropriate training, which
- 17 may include labor/management training, on all major equipment and systems and
- 18 general energy conservation techniques.
- 19 3.3. Operational and maintenance record keeping procedures (log books, computer
- 20 maintenance records, etc.) have been implemented.
- 21 3.4. The following documentation is on site and accessible to the operators: the operations
- 22 and maintenance manuals, if such manuals are still available from the manufacturer,
- 23 the maintenance contracts, and the most recent retro-commissioning report.

24 **Exception:** No retro-commissioning is required if the covered building has received certification
25 under the LEED 2009 rating system for Existing Buildings published by the United States Green
26 Building Counsel or other rating system for existing buildings, as determined by the department,
27 within two years prior to the filing of the building’s energy efficiency report and earned the
28 LEED point for Existing Building Commissioning investigation and analysis and the LEED point
29 for Existing Building Commissioning implementation.

30 **§28-308.3.1 Contents of retro-commissioning report.** The retro-commissioning agent shall
31 prepare and certify a retro-commissioning report. The retro-commissioning report shall include
32 such information relating to the retro-commissioning as shall be set forth in the rules of the
33 department including, at a minimum:

- 34 1. Project and team information:
 - 35 1.1. Building address.
 - 36 1.2. Experience and certification of person performing retro-commissioning and any
 - 37 staff involved in the project.

1 1.3. Name, affiliation, and contact information for persons performing retro-
2 commissioning and members of the retro-commissioning team, owner of building,
3 and facility manager of building.

4 2. Building information:

5 2.1. List of all HVAC, domestic hot water, electrical equipment, lighting, and
6 conveyance equipment types in the base building systems.

7 2.2. Benchmarking output.

8 3. Testing protocol:

9 3.1. List of all equipment types tested.

10 3.2. For each equipment type tested, a list of the sample rates (percent of each type of
11 equipment tested), the testing methodology, including any diagnostic equipment
12 used, and the test results.

13 3.3. List of integrated system testing performed.

14 4. Master list of findings, including for each, the name of the retro-commissioning measure
15 and its assigned number, a brief description of the measure, recommended corrections,
16 the benefits attained, estimated annual savings (energy and cost), the estimated
17 implementation cost, and the simple payback.

18 5. Deficiencies corrected:

19 5.1. List of repairs completed during investigation.

20 5.2. List of deficiencies corrected, including, for each deficiency, the date corrected, by
21 whom the correction was made, the actual cost, and projected savings.

22 **§28-308.3.2 Timing of retro-commissioning.** Except as otherwise provided in section 28-308.7,
23 the retro-commissioning shall be completed no earlier than four years prior to the date on which
24 a covered building's energy efficiency report is filed with the department pursuant to this article.

25 **§28-308.3.3 Documentation of retro-commissioning.** A copy of the latest up-to-date equipment
26 manuals and the most recent retro-commissioning report shall be maintained at every covered
27 building and shall be made available upon request for inspection by the department.

28 **§28-308.4 Energy efficiency report required.** Except as otherwise provided in section 28-308.7,
29 the owner of a covered building shall file an energy efficiency report for such building between
30 January first and December thirty-first of the calendar year in which such report is due pursuant to
31 this section and between January first and December thirty-first of every tenth calendar year
32 thereafter.

33 **Exceptions:**

34 1. An owner may apply for an extension of time to file an energy efficiency report if despite
35 such owner's good faith efforts, to be documented in such application, the owner is unable
36 to complete the required energy audit and retro-commissioning prior to the scheduled due
37 date for such report. The commissioner may grant no more than two such extensions of

1 no more than one year each. Extensions granted pursuant to this provision shall not extend
2 the scheduled due dates for subsequent energy efficiency reports.

- 3 2. An owner may receive annual extensions of time to file an energy efficiency report based
4 on financial hardship of the building.

5 **§28-308.4.1 Due dates.** The first energy efficiency reports for covered buildings [~~in existence on~~
6 ~~the effective date of this article]~~ and for new buildings shall be due [~~, beginning with calendar~~
7 ~~year 2013,~~] in the calendar year with a final digit that is the same as the last digit of the building's
8 tax block number, as illustrated in the following chart:

9
10

Last digit of tax block number	0	1	2	3	4	5	6	7	8	9
Year first EER is due	2020	2021	2022	[2013] <u>2023</u>	[2014] <u>2024</u>	[2015] <u>2025</u>	[2016] <u>2026</u>	[2017] <u>2027</u>	[2018] <u>2028</u>	[2019] <u>2029</u>

1
2 Owners of covered buildings (i) that are less than 10 years old at the commencement of their first
3 assigned calendar year or (ii) that have undergone substantial rehabilitation, as certified by a
4 registered design professional, within the 10 year period prior to any calendar year in which an
5 energy efficiency report is due, such that at the commencement of such calendar year all of the
6 base building systems of such building are in compliance with the New York [City] city energy
7 conservation code as in effect for new buildings constructed on and after July 1, 2010, or as in
8 effect on the date of such substantial rehabilitation, whichever is later, may defer submitting an
9 energy efficiency report for such building until the tenth calendar year after such assigned
10 calendar year.

11 **Exceptions:**

- 12 1. ~~[The first due dates for city buildings shall be in accordance with a staggered~~
13 ~~schedule, commencing with calendar year 2013 and ending with calendar year 2022~~
14 ~~for buildings in existence on the effective date of this article, to be submitted by the~~
15 ~~department of citywide administrative services to the department on or prior to~~
16 ~~December 31, 2011.]~~ A city building constructed after ~~[the effective date of this~~
17 ~~article]~~ December 28, 2009 shall be added to such schedule within 10 years after the
18 issuance of the first certificate of occupancy for such building. Copies of energy
19 efficiency reports submitted to the department with respect to city buildings that are
20 not submitted by the department of citywide administrative services shall also be
21 submitted to the department of citywide administrative services.
- 22 2. A cooperative corporation that owns multiple covered buildings located on different
23 tax block numbers, that is required to file an energy efficiency report for more than
24 one covered building in different calendar years, may consolidate all such energy
25 efficiency reports into one report, disaggregated by covered building, due no later than
26 the year in which the last energy efficiency report would be due, which shall be
27 accepted by the department in satisfaction of the requirements of this section for each
28 covered building included in such consolidated report.

29 **§28-308.4.2 Combined audit and retro-commissioning.** Nothing in this article shall prevent an
30 owner from performing the audit and the retro-commissioning in a combined process, provided
31 that all the requirements of sections 28-308.2 and 28-308.3 are met.

32 **§28-308.5 Content of energy efficiency report.** Except as otherwise provided in section 28-308.7,
33 the energy efficiency report shall include, in a format prescribed by the department, (i) the energy
34 audit report or documentation substantiating that an exception as set forth in section 28-308.2 applies
35 to such building, and (ii) the retro-commissioning report or documentation substantiating that an
36 exception as set forth in section 28-308.3 applies to such building.

1 **§28-308.6 Notification by the department of finance.** The department of finance shall notify the
2 owner of the requirements of this article three years prior to the calendar year in which the covered
3 building's energy efficiency report is due and in the calendar year prior to the calendar year in which
4 such report is due.

5 ~~**§28-308.7 Early compliance.** Notwithstanding any other provision of this article, an owner may
6 submit an energy efficiency report, including both an energy audit report pursuant to section 28-
7 308.7.1 and a retro commissioning report pursuant to section 28-308.7.2, in the calendar year
8 commencing January 1, 2013 and ending December 31, 2013 in order to achieve early compliance
9 with this section. An energy efficiency report submitted for early compliance shall be deemed to
10 satisfy the first required energy efficiency report for the building as assigned pursuant to section 28-
11 308.4.1. The next required energy efficiency report for such building shall be due in the tenth
12 calendar year after the first assigned due date for such report.]~~

13 ~~**§28-308.7.1 Early compliance energy audit report.** An energy audit report for a covered
14 building shall be acceptable for early compliance if it is completed after January 1, 2006 and it
15 includes:]~~

16 [1. The address of the building, completion date of the audit, signature and credentials of the
17 person performing or supervising the performance of the audit and of the audit team; and]

18 [2. The information required in items 1 through 5 of section 28-308.2.]

19 ~~**§28-308.7.1.1 Early compliance audit completed after January 1, 2006 and prior to the
20 effective date of this article.** An early compliance audit completed after January 1, 2006 and
21 prior to the effective date of this article shall have met the following additional criteria:]~~

22 [1. The audit shall have met the requirements of the Level II Energy Survey and Analysis
23 of the 2004 edition of Procedures for Commercial Building Energy Audits published
24 by ASHRAE; or]

25 [2. The audit shall have been performed under a New York Power Authority or New
26 York State Energy Research and Development Authority (NYSERDA) contract or by
27 a NYSEERDA Flex Tech contractor; and]

28 [3. The audit report shall be submitted along with certification by a registered design
29 professional that the audit satisfies the criteria of this section.]

30 [4. A partial audit completed after January 1, 2006 and prior to the effective date of this
31 article shall qualify for early compliance only if the base building systems that were
32 not subject to such audit are audited, after the effective date of this article, in the
33 manner set forth in section 28-308.7.1.2.]

34 ~~**§28-308.7.1.2 Early compliance audit completed after the effective date of this article.**
35 An early compliance audit completed after the effective date of this article shall meet the
36 following additional criteria:]~~

37 [1. The audit shall be performed by or under the supervision of a registered design
38 professional and shall meet the requirements of the Level II Energy Survey and
39 Analysis of the 2004 edition of Procedures for Commercial Building Energy Audits
40 published by ASHRAE;]

1 [2. The auditing team shall include an individual who is one of the following:]

2 [2.1. A NYSERDA approved Flex Tech contractor;]

3 [2.2. A Certified Energy Manager (CEM) or Certified Energy Auditor (CEA),
4 certified by the Association of Energy Engineers (AEE);]

5 [2.3. A High Performance Building Design Professional (HPBD) certified by
6 ASHRAE; or]

7 [2.4. For audits of multifamily residential buildings only, a Multi-family Building
8 Analyst (MFBA), certified by the Building Performance Institute (BPI), or have
9 such other qualification or certification as determined by the department;]

10 [3. An individual with at least three years of professional experience performing energy
11 audits on buildings larger than 50,000 gross square feet (4645 m²) shall be a member
12 of the auditing team;]

13 [4. The building's operations and maintenance staff shall be consulted at the start of and
14 during the audit process; and]

15 [5. The registered design professional performing or supervising the audit shall certify
16 that the audit satisfies the criteria of this section.]

17 **[§28-308.7.2 Early compliance retro-commissioning.** A retro-commissioning shall be
18 acceptable for early compliance if it is completed after the effective date of this article and meets
19 the following criteria:]

20 [1. The retro-commissioning shall be performed under a NYSERDA contract for base
21 building retro-commissioning or certified by an individual who is not on the staff of the
22 building and is (i) a registered design professional, (ii) a certified refrigerating system
23 operating engineer, or (iii) a licensed high pressure boiler operating engineer;]

24 [2. The retro-commissioning team shall include an individual who is a Certified
25 Commissioning Professional (CCP) certified by the Building Commissioning
26 Association (BCA), a Certified Building Commissioning Professional (CBCP) certified
27 by the AEE, a Commissioning Process Management Professional (CPMP) certified by
28 ASHRAE, or an Accredited Commissioning Process Authority Professional (ACPAP)
29 approved by the University of Wisconsin, or has such other certification as determined
30 by the department;]

31 [3. The retro-commissioning team shall include an individual with at least one year of
32 professional experience performing retro-commissioning on the mechanical systems of
33 buildings larger than 50,000 gross square feet (4645 m²);]

34 [4. The building's operations and maintenance staff shall be consulted at the start of and
35 during the retro-commissioning process; and]

36 [5. The retro-commissioning report shall contain a certification that sufficient analysis and
37 testing has been done and corrections have been performed so that the base building
38 systems meet the criteria of section 28-308.3 and shall include the information specified
39 in section 28-308.3.1.]

1 [6. Nothing in this section shall be construed to determine which individuals may perform
2 the work to correct deficiencies identified during the retro commissioning process,
3 except as otherwise provided by applicable law.]

4 [~~§28-308.8 Optional compliance for energy efficiency reports due in the calendar year~~
5 ~~commencing January 1, 2013.~~ Notwithstanding any other provision of this article, audits and retro-
6 commissioning for energy efficiency reports scheduled to be due in the calendar year commencing
7 January 1, 2013 shall be performed, at the option of the owner, in accordance with the provisions for
8 early compliance as set forth in section 28-308.7 or in accordance with procedures set forth in the
9 rules of the department, if such procedures are promulgated within one year prior to the due date of
10 such report. If such procedures are not promulgated within one year prior to the due date of such
11 report, audit and retro commissioning for energy efficiency reports due in the calendar year
12 commencing January 1, 2013 shall comply with the audit and retro commissioning procedures for
13 early compliance.]

14 [~~§28-308.9~~ §28-308.7 Rules. The department shall promulgate such rules as are necessary to carry
15 out the provisions of this article in a timely manner, which may include separate fees for filing and
16 review of applications and reports filed pursuant to this article.

17 **ARTICLE 309**
18 **BENCHMARKING ENERGY AND WATER USE**
19 **AND DISCLOSURE OF ENERGY EFFICIENCY SCORES AND GRADES**

20 **§28-309.1 General.** The energy and water use of city buildings and covered buildings shall be
21 benchmarked in accordance with this article.

22 **§28-309.2 Definitions.** As used in this article, the following terms shall have the following meanings:

23 **BENCHMARK.** To input and submit to the benchmarking tool the total use of energy and water for
24 a building for the previous calendar year and other descriptive information for such building as
25 required by the benchmarking tool.

26 **BENCHMARKING TOOL.** The internet-based database system developed by the United States
27 environmental protection agency, and any complementary interface designated by the office of long-
28 term planning and sustainability, to track and assess the energy and water use of certain buildings
29 relative to similar buildings.

30 **CITY BUILDING.** A building that is more than 10,000 gross square feet (929 m²), as it appears in
31 the records of the department of finance, that is owned by the city or for which the city regularly
32 directly pays all of the annual energy bills, provided that two or more buildings on the same tax lot
33 shall be deemed to be one building.

34 **Exception:** The term "city building" shall not include:

- 35 1. Any building owned by the city that participates in the tenant interim lease apartment
36 purchase program; or

1 2. Any building owned by the city that (i) is 25,000 gross square feet (2323 m²) or less, as
2 it appears in the records of the department of finance, and (ii) participates in a program
3 administered by the department of housing preservation and development.

4 **COVERED BUILDING.** As it appears in the records of the department of finance: (i) a building
5 that exceeds 25,000 gross square feet (2323 m²), (ii) two or more buildings on the same tax lot that
6 together exceed 100,000 gross square feet (9290 m²), (iii) two or more buildings held in the
7 condominium form of ownership that are governed by the same board of managers and that together
8 exceed 100,000 gross square feet (9290 m²), or (iv) a city building.

9 **Exceptions:** The term "covered building" shall not include:

- 10 1. Any building owned by the city that participates in the tenant interim lease apartment
11 purchase program.
- 12 2. Real property classified as class one pursuant to subdivision [~~one~~] 1 of section 1802 of
13 the real property tax law.
- 14 3. Real property, not more than three stories, consisting of a series of attached, detached or
15 semi-detached dwellings, for which ownership and the responsibility for maintenance of
16 the HVAC systems and hot water heating systems is held by each individual dwelling
17 unit owner, and with no HVAC system or hot water heating system in the series serving
18 more than two dwelling units, as certified by a registered design professional to the
19 department.

20 **DATA CENTER.** A room or rooms used primarily to house [~~high-density~~] high-density computing
21 equipment, such as server racks, used for data storage and processing.

22 **DWELLING UNIT.** A single unit consisting of one or more habitable rooms, occupied or arranged
23 to be occupied as a unit separate from all other units within a building, and used primarily for
24 residential purposes and not primarily for professional or commercial purposes.

25 **ENERGY.** Electricity, natural gas, fuel oil and steam.

26 **OWNER.** The owner of record, provided that "owner" shall be deemed to include: (i) the net lessee
27 in the case of a building subject to a net lease with a term of at least [~~forty-nine~~] 49 years, inclusive
28 of all renewal options, (ii) the board of managers in the case of a condominium, and (iii) the board
29 of directors in the case of a cooperative apartment corporation.

30 **TENANT.** Any tenant, tenant-stockholder of a cooperative apartment corporation, condominium
31 unit owner or other occupant.

32 **§28-309.3 Benchmarking required for city buildings.** [~~No later than May 1, 2010, and no~~] No later
33 than every May first [~~thereafter~~] , any city building shall be benchmarked by the agency or entity
34 primarily responsible for the management of such building, in coordination with the department of
35 citywide administrative services with respect to energy use, and with the New York [~~City~~] city
36 department of environmental protection with respect to water use. Benchmarking of water use shall
37 not be required unless the building was equipped with automatic meter reading equipment by the
38 New York [~~City~~] city department of environmental protection for the entirety of the previous

1 calendar year. The city shall maintain such documents as the department determines are necessary
2 for the purpose of carrying out the provisions of this article.

3 **§28-309.4 Benchmarking required for covered buildings other than city buildings.** The owner
4 of a covered building, other than a city building, shall annually benchmark such covered building
5 [~~no later than May 1, 2011, and~~] no later than every May [~~thereafter~~] first. Benchmarking of water
6 use shall not be required unless the building was equipped with automatic meter reading equipment
7 by the New York [~~City~~] city department of environmental protection for the entirety of the previous
8 calendar year. The owner or the owner's representative performing the benchmarking shall consult
9 with the operating staff of the building, as appropriate. Information submitted to the benchmarking
10 tool must be accurate and complete.

11 **Exception:** The first mandatory benchmarking for a covered building, other than a city building,
12 that (i) does not exceed 50,000 gross square feet (4645 m²), (ii) is not one of two or more
13 buildings on the same tax lot that together exceed 100,000 gross square feet (9290 m²) and (iii)
14 is not one of two or more buildings held in the condominium form of ownership that are governed
15 by the same board of managers and that together exceed 100,000 gross square feet (9290 m²),
16 shall be completed on or before May [~~+~~] first of the first year that commences after the
17 department determines and sets forth in a rule that the utility company providing energy to such
18 buildings will, upon request of an owner, directly upload information necessary to benchmark
19 such building.

20 **§28-309.4.1 Obligation to report energy use for all utility accounts and addresses connected**
21 **to the building.** The owner shall submit information to the benchmarking tool for all utility
22 accounts and addresses connected to the building, including those for separately metered tenant
23 spaces. The owner shall obtain information for separately metered tenant spaces from the utility.
24 If the utility does not have a program to provide such information, the owner shall make
25 reasonable efforts to obtain such information from the tenant. Tenants shall have the obligation
26 to provide such information.

27 **§28-309.4.2 Preservation of documents, inspection, and audit.** An owner of a covered building
28 shall maintain such records as the department determines are necessary for carrying out the
29 purposes of this article, including but not limited to energy and water bills and reports or forms
30 received from utilities and tenants. Where energy use within separately metered tenant spaces is
31 omitted, records shall be maintained documenting owner's efforts to obtain such information.
32 All records shall be preserved for a period of three years, provided that the commissioner may
33 consent to their destruction within that period or may require that such records be preserved
34 longer than such period. At the request of the department, such records shall be made available
35 for inspection and audit by the department at the place of business of the owner or at the offices
36 of the department during normal business hours.

37 **§28-309.4.3 Violations.** It shall be unlawful for the owner of a covered building to fail to
38 benchmark pursuant to section 28-309.4. The commissioner shall classify such violation as a
39 lesser violation. If, upon audit of a benchmarking report, the department finds that information
40 submitted to the benchmarking tool was substantially inaccurate or incomplete, the department
41 may reject the purported benchmarking and the owner shall be liable for a violation of section
42 28-309.4 as if no benchmarking had been performed.

1 **Exception:** Notwithstanding section 28-204.2, no civil penalty shall be imposed on the
2 owner of a covered building for a violation of this section for such covered building if:

- 3 1. Such covered building (i) does not exceed 50,000 gross square feet (4645 m²), (ii) is
4 not two or more buildings on the same tax lot that together exceed 100,000 gross
5 square feet (9290 m²), (iii) is not two or more buildings held in the condominium
6 form of ownership that are governed by the same board of managers and that together
7 exceed 100,000 gross square feet (9290 m²), and (iv) is not a city building;
- 8 2. Such owner requested, from the department or another agency designated pursuant to
9 section 28-309.11, benchmarking assistance in connection with such building, and
10 such request was made at least 60 days before the due date of the benchmarking report
11 for which such violation was issued; and
- 12 3. Such owner corrects such violation within 60 days after the date of the notice of such
13 violation.

14 **§28-309.5 Direct upload.** Information shall be directly uploaded to the benchmarking tool in
15 accordance with the following:

16 **§28-309.5.1 Direct upload by a utility company or other source.** The office of long-term
17 planning and sustainability shall encourage and facilitate any utility company or any other source
18 authorized by the office of long-term planning and sustainability to upload directly to the
19 benchmarking tool as soon as practicable, information necessary to benchmark a building.

20 **§28-309.5.2 Direct upload by the ~~[New York City]~~ department of environmental protection.**
21 The ~~[New York city]~~ department of environmental protection shall upload directly to the
22 benchmarking tool information on water use at all buildings that were equipped with automatic
23 meter reading equipment by the ~~[New York city]~~ department of environmental protection for the
24 entirety of the previous calendar year and that are subject to the benchmarking requirements of
25 this article.

26 **§28-309.6 Suspension.** The director of the office of long-term planning and sustainability may
27 suspend all or part of the requirement to benchmark pursuant to this article upon a written finding
28 that a technological deficiency in the benchmarking tool precludes compliance with this article. The
29 director of the office of long-term planning and sustainability may lift all or part of any such
30 suspension upon a written finding that such deficiency has been corrected. The office of long-term
31 planning and sustainability shall notify the speaker of the city council, the department, the
32 department of citywide administrative services, the ~~[New York City]~~ department of environmental
33 protection and the department of finance promptly upon issuing a suspension or lifting a suspension
34 pursuant to this section.

35 **§28-309.7 Notification and transmission of information.** The department of finance shall:

- 36 1. Annually notify owners of covered buildings of their obligation to benchmark pursuant to
37 section 28-309.4, provided that the failure of the department of finance to notify any such
38 owner shall not affect the obligation of such owner to benchmark pursuant to such section.
- 39 2. Notify owners of covered buildings of any suspension or lifting of a suspension pursuant to
40 section 28-309.6.

1 3. Make available to the department information regarding owners of covered buildings for
2 which no benchmarking information was generated by the benchmarking tool.

3 **§28-309.8 Disclosure.** The department of finance shall make information generated by the
4 benchmarking tool available to the public on the internet no later than September [~~+~~] first of the year
5 in which the covered buildings are benchmarked. Such information shall include, but need not be
6 limited to: (i) the energy use intensity, (ii) the water use per gross square foot, (iii) where available,
7 a rating or score that compares the energy and water use of the building to that of similar buildings,
8 and (iv) a comparison of data across calendar years for any years such building was benchmarked.
9 [~~Information generated by the benchmarking tool for the 2009 calendar year for city buildings, for~~
10 ~~the 2010 calendar year for covered buildings, and for the 2011 calendar year for covered buildings~~
11 ~~whose primary use is residential, as determined by the department of finance, shall not be disclosed.]~~

12 **Exception:** Ratings or scores generated by the benchmarking tool for a covered building that
13 contains a data center, television studio, and/or trading floor that together exceed ten percent of
14 the gross square footage of any such building shall not be disclosed until the office of long-term
15 planning and sustainability determines that the benchmarking tool can make adequate
16 adjustments for such facilities. When the office of long-term planning and sustainability
17 determines that the benchmarking tool can make such adjustments, it shall report such
18 determination to the mayor and the speaker of the city council. Until such determination is made,
19 the office of long-term planning and sustainability shall report biennially to the mayor and the
20 speaker of the city council that the benchmarking tool is unable to make such adjustments.

21 **§28-309.9 Report.** No later than December 31 of each year, the office of long-term planning and
22 sustainability shall prepare, submit to the mayor and the speaker of the city council, and post on the
23 internet a report reviewing and evaluating the administration and enforcement of this article and
24 analyzing data obtained from the benchmarking tool. Such report shall contain information
25 regarding: (i) the energy and water efficiency of buildings in the city, (ii) the accuracy of
26 benchmarked data and whether there is a need to train and/or certify individuals who benchmark,
27 (iii) compliance with the requirements of this article, (iv) any administrative and legislative
28 recommendations for strengthening the administration and enforcement of this article, (v) the
29 effectiveness of the benchmarking tool in accounting for New York City conditions, including, but
30 not limited to, high density occupancies, use of steam, large building size, and specific high-energy
31 uses such as data centers, television studios, and trading floors, and (vi) such other information and
32 analyses as the office of long-term planning and sustainability deems appropriate.

33 **§28-309.10 Rules.** The department, the department of finance and the office of long-term planning
34 and sustainability may promulgate such rules as deemed necessary to carry out the provisions of this
35 article.

36 **§28-309.11 Benchmarking assistance.** The department or another agency designated by the mayor
37 shall establish a system to receive and respond to requests from owners for assistance with respect to
38 fulfilling the benchmarking requirements of this section. Such assistance may include, but need not
39 be limited to, trainings, the provision of reference guides, and a publicized telephone number and
40 [~~email~~] electronic mail address to receive direct questions. The annual notice required by section 28-
41 309.7 shall notify covered building owners that such assistance is available and shall describe how
42 such assistance can be obtained.

1 **§28-309.12 Energy efficiency scores and energy efficiency grades.** Energy efficiency scores and
2 grades for buildings shall be obtained, assigned and disclosed in accordance with this section.

3 **§28-309.12.1 Definitions.** As used in section 28-309.12, the following terms shall have the
4 following meanings:

5 **ENERGY EFFICIENCY GRADE.** The term “energy efficiency grade” means, for a covered
6 building, a grade based on an energy efficiency score assigned through the benchmarking tool in
7 accordance with this section as follows:

- 8 1. If such score is equal to or greater than 85, the energy efficiency grade shall be A;
- 9 2. If such score is equal to or greater than 70 but less than 85, the energy efficiency grade
10 shall be B;
- 11 3. If such score is equal to or greater than 55 but less than 70, the energy efficiency grade
12 shall be C;
- 13 4. If such score is less than 55, the energy efficiency grade shall be D;
- 14 5. If the owner of such building has not complied with section 28-309.12.2, and such owner
15 has had an opportunity to be heard with respect to such non-compliance, the energy
16 efficiency grade shall be F; and
- 17 6. If, in accordance with the rules of the department, it is not feasible to obtain an energy
18 efficiency score for such building or if such building is subject to the exception in section
19 28-309.8, the energy efficiency grade shall be N.

20 **ENERGY EFFICIENCY SCORE.** The term "energy efficiency score" means, for a building,
21 the Energy Star rating for such building or a score that assesses the energy use of such building
22 relative to similar buildings that is assigned through the benchmarking tool.

23 **ENERGY STAR RATING.** The rating that a building earns using the United States
24 Environmental Protection Agency ENERGY STAR portfolio manager to compare building
25 energy performance to similar buildings in similar climates.

26 **§28-309.12.2 Energy efficiency score and energy efficiency grade required.** In 2020 and in
27 each calendar year thereafter, an owner of a covered building shall use the benchmarking tool to
28 provide an energy efficiency score for such building to the department in accordance with the
29 rules of the department unless, in accordance with such rules, the building is a type of building
30 for which it is not feasible to obtain an energy efficiency score. In each such year, the department
31 shall issue an energy efficiency grade to the owner in accordance with such rules.

32 **§28-309.12.3 Display of energy efficiency score and energy efficiency grade.** Within 30 days
33 after the owner of a covered building obtains an energy efficiency grade, such owner shall post
34 such grade and the energy efficiency score upon which such grade was based in a conspicuous
35 location near each public entrance to such building, in a form and manner established by the
36 department.

37 **Exception:** This section [28-309.12.3] shall not apply to posting of the energy efficiency score
38 of a building with an energy efficiency grade of N.

1 **§28-309.12.4 Publication of energy efficiency grades and energy efficiency scores.** For each
2 building for which an energy efficiency grade or energy efficiency score is generated pursuant to
3 this section, the department shall make information generated in connection with such grade and
4 score publicly available online by no later than May 1 of the year following such generation.

5 **Exception:** This section [~~28-309.12.4~~] shall not apply to information generated with respect
6 to a building with an energy efficiency grade of N.

7 **§28-309.12.5 Audits.** The department shall, from time to time, audit information submitted for
8 buildings in connection with energy efficiency grades and energy efficiency scores. Such audits
9 shall occur at least annually and shall involve appropriate sample size of buildings, as determined
10 by the department.

11 **§28-309.13 Outreach to building owners regarding making energy efficiency improvements.**
12 Each year, the department shall provide information regarding energy efficiency improvements to
13 owners of buildings of all sizes, including buildings connected to gas lines. Such information shall
14 also be posted on the department's website. The information shall include but not be limited to making
15 energy efficiency improvements including the use of fossil fuel alternatives, the benefits of energy
16 efficiency improvements, compliance with the New York city energy conservation code, and
17 compliance with other laws aimed at reducing building energy use and carbon emissions.

18 **ARTICLE 310**
19 **REQUIRED UPGRADE OF LIGHTING SYSTEMS**

20 **§28-310.1 General.** Lighting systems in covered buildings shall be upgraded as provided for in this
21 article.

22 **§28-310.2 Definitions.** As used in this article, the following terms shall have the following meanings:

23 **COVERED BUILDING.** As it appears in the records of the department of finance: (i) a building
24 that exceeds 25,000 gross square feet (2323 m²), (ii) two or more buildings on the same tax lot that
25 together exceed 100,000 gross square feet (9290 m²) or (iii) two or more buildings held in the
26 condominium form of ownership that are governed by the same board of managers and that together
27 exceed 100,000 gross square feet (9290 m²).

28 **Exceptions:** The term "covered building" shall not include:

- 29 1. Real property classified as class one pursuant to subdivision [~~one~~] 1 of section [~~eighteen~~
30 ~~hundred two~~] 1802 of the New York state real property tax law; or
- 31 2. Real property, not more than three stories, consisting of a series of attached, detached or
32 semi-detached dwellings, for which ownership and the responsibility for maintenance of
33 the HVAC systems and hot water heating systems is held by each individual dwelling unit
34 owner, and with no HVAC system or hot water heating system in the series serving more
35 than two dwelling units, as certified by a registered design professional to the department.

36 **§28-310.3 Upgrade of lighting systems of covered buildings required.** No later than January 1,
37 2025, the lighting systems of covered buildings shall be in compliance with the standards for new
38 systems set forth in the New York [~~City~~] city energy conservation code and/or applicable standards
39 referenced in such energy code. The owner of a covered building shall ensure that the upgrade of the

1 lighting system of the entire covered building is completed on or prior to such date and shall file a
2 report with the department, in accordance with the rules of the department, prepared by a registered
3 design professional or a licensed master or special electrician certifying that such upgrade has been
4 completed and that the work is in compliance with the technical standards of the New York [City]
5 city electrical code. The department may impose a fee for filing and review of such reports.

6 **Exceptions:**

- 7 1. An element of a lighting system that is in compliance with the standards of the New
8 York city energy conservation code and/or applicable standards referenced in such code
9 as in effect for new systems installed on or after July 1, 2010.
- 10 2. Lighting power densities in any space bounded by permanent floor-to-ceiling partitions
11 and/or closable doors that are in compliance with the standards of the New York city
12 energy conservation code and/or applicable standards referenced in such code as in
13 effect for new systems installed on or after July 1, 2010.
- 14 [2] 3. The lighting system within dwelling units classified in occupancy group R-2 or R-3.
- 15 [3] 4. The lighting system within a space classified in occupancy group A-3 that is within a
16 house of worship.

17 **ARTICLE 311**
18 **INSTALLATION OF ELECTRICAL SUB-METERS IN TENANT SPACES**

19 **§28-311.1 General.** Sub-meters shall be installed in covered buildings as provided in this article.

20 **§28-311.2 Definitions.** As used in this article, the following terms shall have the following meanings:

21 **COVERED BUILDING.** As it appears in the records of the department of finance: (i) a building
22 that exceeds 25,000 gross square feet (2323 m²), (ii) two or more buildings on the same tax lot that
23 together exceed 100,000 gross square feet (9290 m²), or (iii) two or more buildings held in the
24 condominium form of ownership that are governed by the same board of managers and that together
25 exceed 100,000 gross square feet (9290 m²).

26 **Exceptions:** The term "covered building" shall not include:

- 27 1. Real property classified as class one pursuant to subdivision one of section eighteen
28 hundred two of the real property tax law; or
- 29 2. Real property, not more than three stories, consisting of a series of attached, detached or
30 semi-detached dwellings, for which ownership and the responsibility for maintenance of
31 the HVAC systems and hot water heating systems is held by each individual dwelling
32 unit owner, and with no HVAC system or hot water heating system in the series serving
33 more than two dwelling units, as certified by a registered design professional to the
34 department.

35 **COVERED TENANT SPACE.** (i) A tenant space larger than 5,000 gross square feet (465 m²) on
36 one or more floors of a covered building let or sublet to the same person, or (ii) a floor, of a covered
37 building, larger than 5,000 gross square feet (465 m²) consisting of tenant spaces let or sublet to two
38 or more different persons.

1 **Exception:** The term "covered tenant space" shall not include dwelling units classified in
2 occupancy group R-2 or R-3.

3 **METER.** A device installed by an electrical utility company or corporation that measures the flow
4 of electricity supplied to a building or to a defined space within a building and used by the utility to
5 bill consumers for electrical service.

6 **SUB-METER.** A device meeting the standards of the department or, where applicable, the public
7 service commission, installed within a building's electrical distribution system that measures the
8 flow of electricity within a defined space within the building and that may, but need not, be used for
9 apportioning the cost of electricity among the building's tenants or subtenants.

10 **TENANT SPACE.** Space within a covered building that is let or sublet to another person by the
11 owner or a lessee of such space.

12 **§28-311.3 Sub-meters required for covered tenant spaces.** On and after January 1, 2025, the
13 electrical consumption of each covered tenant space shall be measured by one or more sub-meters.
14 Sub-meters shall be installed in existing covered tenant spaces by the owner or the lessor of such
15 space on or before January 1, 2025 and thereafter as new covered tenant spaces are created within
16 the building. If the covered tenant space is a floor with multiple tenancies, each tenancy that is 5,000
17 gross square feet (465 m²) or less shall (i) have a separate sub-meter, (ii) share a sub-meter with
18 other tenant spaces on the floor, or (iii) share a sub-meter covering the entire floor.

19 **Exception:** Covered tenant space for which the electrical consumption within such space is
20 measured by a meter dedicated exclusively to that space.

21 **§28-311.4 Monthly statements.** Each tenant or subtenant within a covered tenant space that has a
22 sub-meter or sub-meters to measure electrical consumption shall be provided with a monthly
23 statement showing the amount of electricity measured by the sub-meter for such tenant or subtenant
24 during the month, and any amount charged to the tenant or subtenant for electricity. If the covered
25 tenant space is a floor with multiple tenancies and the tenant's sub-meter covers other tenant spaces,
26 the statement for such tenant shall show the electrical consumption for the area covered by the sub-
27 meter and the percentage of that area that is leased by the tenant.

28 **§28-311.5 Reports.** The owner of each covered building shall file a report in accordance with the
29 rules of the department prepared by a registered design professional or a licensed master or special
30 electrician certifying that sub-meters have been installed in all covered tenant spaces in such building
31 as required by this article or that covered tenant spaces are subject to the exception set forth in section
32 28-311.3. The department may impose a fee for filing and processing such reports.

33 **ARTICLE 312**
34 **CARBON MONOXIDE AND SMOKE ALARMS**

35 **§28-312.1 General.** Required carbon monoxide and smoke alarms shall comply with the provisions
36 of this article.

37 **§28-312.2 Periodic replacement of carbon monoxide alarms.** Carbon monoxide alarms required
38 pursuant to section [908.7] 915.1 of the New York [City] city building code or sections 27-981.1,

1 27-981.2 and 27-981.3 of the 1968 building code shall be replaced when the time elapsed since the
2 installation of such alarm exceeds the manufacturer’s suggested useful life of the alarm.

3 **Exception:** A carbon monoxide alarm installed [~~prior to the effective date of this article~~] before
4 April 25, 2012 shall be replaced when the time elapsed since the installation of such alarm
5 exceeds the manufacturer’s suggested useful life of the alarm [~~or within 6 months after the~~
6 ~~effective date of this article, whichever is later~~].

7 **§28-312.3 Audible notification of expiration of useful life of carbon monoxide alarms.** All carbon
8 monoxide alarms installed after [~~the effective date of this article~~] April 25, 2012 shall comply with
9 UL 2034 and be of a type that emits an audible notification at the expiration of the useful life of such
10 alarm.

11 **§28-312.4 Periodic replacement of smoke alarms.** Smoke alarms required pursuant to section
12 907.2 of the New York [~~City~~] city building code or sections 27-978, 27-979, 27-980 and 27-981 of
13 the 1968 building code shall be replaced when the time elapsed since the installation of such alarm
14 exceeds the manufacturer’s suggested useful life of the alarm.

15 **Exception:** A smoke alarm installed [~~prior to the effective date of this section~~] before April 1,
16 2014 and whose end of useful life is not known shall be replaced with an alarm that complies
17 with section 28-312.5 [~~within 7 years after the effective date of this section~~] by no later than
18 April 1, 2021.

19 **§28-312.5 Audible notification of expiration of useful life of smoke alarms.** All smoke alarms
20 installed after [~~the effective date of this section~~] April 1, 2014 shall comply with UL 217, shall
21 employ a non-removable, non-replaceable battery that powers the alarm for a minimum of 10 years,
22 and shall be of the type that emits an audible notification at the expiration of the useful life of the
23 alarm.

24 **§28-312.8 Location of smoke alarms and smoke detectors.** On or after January 1, 2021, smoke
25 alarms and smoke detectors installed or replaced in group R occupancies shall be installed in
26 accordance with section [~~907.2.11.5~~] 907.2.11.6 of the New York city building code.

27 **ARTICLE 313**
28 **ACCESSIBILITY**

29 **§28-313.1 Retroactive requirement for directional signage at building entrances.** The provisions
30 of section [~~1110.2~~] 1111.2 of the New York [~~City~~] city building code requiring directional signage
31 to be posted at inaccessible building entrances indicating the route to the nearest accessible entrance
32 shall apply retroactively to all buildings that have such accessible entrances. [~~Buildings in existence~~
33 ~~on the effective date of this section shall post such directional signage on or before August 1, 2013.~~]
34 Such directional signage shall be maintained in good condition.

35 **Exception:** Directional signage posted at building entrances in compliance with the americans
36 with disabilities act of 1990 shall be deemed to be in compliance with section [~~1110.2~~] 1111.2
37 of the New York [~~City~~] city building code.

1 **§28-313.2 Retroactive requirement for accessible building entrances.** The provisions of item [5]
2 4 of section [~~4440.4~~] 1111.1 of the New York [City] city building code requiring signage to be posted
3 at accessible entrances where an inaccessible building entrance exists shall apply retroactively to all
4 buildings that have such accessible entrances. [~~Buildings in existence on the effective date of this~~
5 ~~section shall post such signage on or before August 1, 2013. Such signage shall be maintained in good~~
6 ~~condition.~~]

7 **Exception:** Accessible entrance signs that are posted at building entrances in compliance with
8 the americans with disabilities act of 1990 shall be deemed to be in compliance with section
9 [~~4440.4~~] 1111.1 of the New York [City] city building code subject to the inclusion on or adjacent
10 to such signage of a contact telephone number or instructions to gain access if an otherwise
11 accessible building entrance is subject to locking.

12 **§28-313.3 Retroactive requirement for signage and safety requirements for portable ramps at**
13 **inaccessible building entrances where such ramps are permissible.** The provisions of item 7 of
14 section [~~4440.3~~] 1111.3 of the New York city building code requiring that signage stating a portable
15 ramp is available, if provided by the building, and the phone number to request such ramp, be posted
16 at inaccessible building entrances shall apply retroactively to all prior code buildings that have such
17 portable ramps where use of such a ramp is permissible. The use of a portable ramp by any building
18 must comply with all applicable laws, and must comply with Section 405 (Ramps) of ICC A117.1
19 except to the extent the commissioner has waived a requirement pursuant to section 28-313.3.1. All
20 signage posted pursuant to this section shall comply with Section [~~4440~~] 1111 of the New York city
21 building code and be maintained in good condition. Nothing in this section shall be construed to
22 authorize the provision of a portable ramp where such provision would not otherwise be lawful.

23 **§28-313.3.1 Waiver of requirements related to portable ramps at inaccessible building**
24 **entrances where such ramps are permissible.** The commissioner may waive the requirement of
25 section 28-313.3 that all portable ramps used by prior code buildings must comply with Section
26 405 (Ramps) of ICC A117.1, provided, however, that such waiver would not significantly
27 adversely affect safety and that equally safe and proper alternatives are prescribed and, further,
28 that such waiver is based upon a specific finding by the commissioner that strict compliance with
29 the requirement:

- 30 1. Would create an undue economic burden;
- 31 2. Would not achieve its intended objective;
- 32 3. Would be physically or legally impossible;
- 33 4. Would be unnecessary in light of alternatives which ensure the achievement of the
34 intended objective or which, without a loss in the level of safety, achieve the intended
35 objective more efficiently, effectively or economically; or
- 36 5. Would entail a change so slight as to produce a negligible additional benefit.

37 **§28-313.3.2 Waiver application process.** Each application for a waiver under section 28-313.3.1
38 shall be made to the commissioner in writing, setting forth each requirement of Section 405
39 (Ramps) of ICC A117.1 sought to be waived and the specific reason or reasons therefore. The
40 commissioner shall determine, under all of the circumstances presented by such application,
41 which of such requirements may appropriately be waived. The commissioner shall render such

1 determination in a writing, which shall set forth in detail the commissioner’s findings and
2 conclusions with respect to each requirement sought to be waived. A copy of such written
3 determination shall be forwarded to the applicant. Such written determination shall be filed with
4 the department and shall be available for public inspection.

5 **§28-313.3.3 Waiver recommendation.** The mayor’s office for people with disabilities, or its
6 successor agency shall be consulted by and shall advise the commissioner concerning each
7 application for a waiver under section 28-313.3.1.

8 **ARTICLE 314**
9 **~~[PERIODIC WASTEWATER RECYCLING SYSTEM INSPECTION~~**
10 **~~AND TESTING]~~**
11 **RESERVED**

12 ~~[§28-314.1 General. Wastewater recycling systems installed in accordance with section C102 of~~
13 ~~appendix C of the New York City plumbing code shall be periodically inspected and tested in~~
14 ~~accordance with this article. This article shall not apply to rainwater recycling systems installed in~~
15 ~~accordance with section C103 of appendix C of the New York City plumbing code.]~~

16 ~~[§28-314.2 Frequency of inspection and testing. The owner shall test and inspect wastewater~~
17 ~~recycling systems on a monthly basis. The commissioner may require additional testing and~~
18 ~~inspections of wastewater recycling systems as necessary to protect public safety.]~~

19 ~~[§28-314.3 Inspection and testing process. Wastewater recycling systems shall be inspected and~~
20 ~~tested in accordance with sections 28-314.3.1 through 28-314.3.6.]~~

21 ~~[§28-314.3.1 Inspection and testing entities. Required tests performed on behalf of the owner~~
22 ~~shall be performed by an approved agency with qualifications as set forth in department rules.]~~

23 ~~[§28-314.3.2 Scope. At each test and inspection, in addition to the requirements prescribed by~~
24 ~~this article, all wastewater treatment equipment provided for operation of wastewater recycling~~
25 ~~systems shall be inspected to determine that they are in safe operating condition and parts have~~
26 ~~not worn to such an extent as to affect the safe and reliable operation of the installation. At each~~
27 ~~test and inspection, treated effluent from the wastewater recycling system shall be sampled and~~
28 ~~tested, the results of which shall comply with section C102.1 of the New York City plumbing~~
29 ~~code.]~~

30 ~~[§28-314.3.3 Notation of inspection or test. After each test and inspection, the inspector shall~~
31 ~~affix the inspection date and his or her signature over a stamp identifying his or her approved~~
32 ~~agency and his or her approval number on the inspection certificate issued by the department.]~~

33 ~~[§28-314.3.4 Inspection and test reports submission. Inspection and test reports shall be~~
34 ~~submitted on forms in such manner as required by the commissioner. Each inspection and test~~
35 ~~report shall include a listing of all violations for each device inspected and tested associated with~~
36 ~~the wastewater recycling system. A copy of the report, signed by the inspector performing the~~
37 ~~inspection and tests shall be delivered to the owner within 30 days of the site visit. All reports~~
38 ~~shall be kept on file by the approved agency and the owner for a period of at least 6 years.]~~

1 ~~§28-314.3.5 Reporting an unsafe or hazardous condition.~~ The operation of the system shall
2 immediately cease if any test sample does not meet the minimum water quality standards of Table
3 C102.1 of the New York City plumbing code. The wastewater recycling system shall be placed
4 into start-up mode and testing shall commence for at least five consecutive days demonstrating
5 full compliance. If further inspection and testing reveals that the wastewater recycling system test
6 samples do not meet the minimum water quality standards in table C102.1 of the New York City
7 plumbing code, the system shall be taken out of service immediately by the agency performing
8 the inspection. The building owner shall be notified immediately by the agency performing the
9 inspection. The department shall be notified by the agency that the system has been taken out of
10 service within 24 hours by telephone, electronically, in writing or as otherwise directed by the
11 commissioner.]

12 ~~§28-314.3.6 Repair.~~ All defects and violations identified during the inspection and testing
13 process shall be corrected immediately prior to continuing the operation of the wastewater
14 recycling system.]

15 **ARTICLE 315**
16 **RETROACTIVE REQUIREMENTS**

17 **§28-315.1 General.** Buildings must be in compliance with the retroactive requirements of the
18 provisions of this code. Such requirements are listed in this article along with the dates by which
19 compliance must be achieved. The retroactive requirements of the 1968 building code continue in
20 effect under this code in accordance with section 28-102.4.1 of this code. The dates for compliance
21 with the retroactive requirements of the 1968 building code are as set forth in the applicable provisions
22 of such 1968 building code. Failure to comply with a retroactive requirement of this code or of the
23 1968 building code by the date specified for such compliance is a violation of this code.

24 **§28-315.2 Fire protection systems.** The work specified in this section to enhance the fire protection
25 systems of buildings shall be completed by the dates specified herein.

26 **§28-315.2.1 Painting of certain exposed portions of sprinkler systems.** The painting of
27 exposed risers, cross connections and handles of valves of sprinkler systems in accordance with
28 the retroactive requirements of section 903.6.3 of the New York [City] city building code shall
29 be completed by June 2, 2010 and certification of such painting shall be maintained in accordance
30 with section 903.6.5 of such code.

31 **§28-315.2.2 Painting of certain exposed portions of standpipe systems.** The painting of
32 exposed portions of standpipe systems and handles of valves serving such systems in accordance
33 with the retroactive requirements of section 905.11.3 of the New York [City] city building code
34 shall be completed by June 2, 2010 and certification of such painting shall be maintained in
35 accordance with section 905.11.6 of such code.

36 **§28-315.2.3 Animal service facilities.** By December 31, 2016, animal service facilities shall
37 comply with the retroactive requirements of section 903.2.2.2 of the New York city building code
38 and owners of such facilities shall file with the department a report certifying either that sprinklers
39 have been installed or that the facility is in compliance with one of the exceptions set forth in such
40 section.

1 **§28-315.3 Sustainability.** The work specified in this section to enhance the sustainability of buildings
2 must be completed by the dates specified herein.

3 **§28-315.3.1 Lighting systems.** By January 1, 2025, the lighting systems of certain buildings shall
4 be in compliance with article 310 of this chapter and the owners of such buildings shall file a
5 report in accordance with the rules of the department, prepared by a registered design professional
6 or a licensed master or special electrician, certifying compliance with such section and compliance
7 with the technical standards of the New York city electrical code. The department may impose a
8 fee for filing and reviewing such reports.

9 **§28-315.3.2 Electrical sub-meters.** By January 1, 2025, the installation of electrical sub-meters
10 in tenant spaces in certain buildings in accordance with article 311 of this chapter shall be
11 completed and the owners of such buildings shall file a report in accordance with the rules of the
12 department, prepared by a registered design professional or a licensed master or special
13 electrician, certifying compliance with such section. The department may impose a fee for filing
14 and reviewing such reports.

15 **§28-315.4 Elevator safety.** The work specified in this section to improve the safety of existing
16 elevators shall be completed by the dates specified herein.

17 **§28-315.4.1 Compliance with ASME A17.3 of [2002] 2015.** Existing elevators and escalators
18 shall, at a minimum, comply with ASME A17.3 of [2002] 2015, as modified by chapter K3 of
19 appendix K of the New York [City] city building code. [~~All work to achieve compliance with~~
20 ~~such requirements shall be completed by December 14, 2009.~~]

21 **Exceptions:**

- 22 **1. Spaces below hoistways.** Spaces below hoistways shall be protected in accordance
23 with section 2.5 of chapter K3 of such appendix by December 14, 2010.
- 24 **2. Car doors and gates.** Car doors and gates shall be in compliance with section 3.4.2
25 of chapter K3 of such appendix by December 14, 2012.
- 26 **3. Car illumination.** Car illumination shall be in compliance with section 3.4.5 of
27 chapter K3 of such appendix by December 14, 2010.
- 28 **4. Traction elevators.** Traction elevators with single plunger brakes shall be in
29 compliance with section 3.8.4.1 of chapter K3 of such appendix by January 1, 2027.
- 30 **5. Electrical protective devices.** Electrical protective devices shall be in compliance
31 with section 3.10.4 of chapter K3 of such appendix by December 14, 2010.
- 32 **6. Automatic passenger and freight elevators.** Automatic passenger and freight
33 elevators shall be in compliance with section 3.10.12 of chapter K3 of such appendix
34 by January 1, 2020.
- 35 **7. Hydraulic elevators.** Hydraulic elevators shall be in compliance with section 4.3.3 of
36 chapter K3 of such appendix by December 14, 2014.
- 37 **8. Escalator skirt obstruction devices.** Escalator skirt obstruction devices shall be in
38 compliance with Section 5.3.7 of Chapter K3 of such appendix by January 1, 2014.

1 **§28-315.5 Fuel gas systems.** The work specified in this section to enhance the safety of fuel gas
2 systems shall be completed by the dates specified herein.

3 **§28-315.5.1 Outside gas shut-off.** Existing gas services shall be provided with an outside
4 emergency shutoff device acceptable to the commissioner and the fire commissioner in
5 accordance with the retroactive requirements of item 1 of section [E6] E.6 of appendix E of the
6 New York [City] city fuel gas code. Installation of such a device shall be completed no later than
7 January 1, 2010.

8 **Exception:** For R-3 occupancies, the installation of such a device shall be completed no later
9 than January 1, 2020.

10 **§28-315.6 Accessibility.** The work specified in this section to enhance the accessibility of buildings
11 shall be completed by the dates specified herein.

12 **§28-315.6.1 Directional signage at inaccessible building entrances.** The posting of directional
13 signage at inaccessible building entrances in accordance with the retroactive requirements of
14 section 28-313.1 of this code shall be completed on or before August 1, 2013.

15 **§28-315.6.2 Signage at accessible building entrances.** The posting of signage at accessible
16 building entrances in accordance with the retroactive requirements of section 28-313.2 of this
17 code shall be completed on or before August 1, 2013.

18 **§28-315.6.3 Signage for portable ramps at inaccessible building entrances where such ramps
19 are permissible.** The posting of signage for portable ramps at inaccessible building entrances
20 where such a ramp is permissible in accordance with the requirements of item 7 of [1110.3] 1111.3
21 of the New York city building code shall be completed on or before March 1, 2020.

22 **§28-315.7 Building security.** The work specified in this section to enhance building security shall be
23 completed by the dates specified herein.

24 **§28-315.7.1 Security grilles on buildings in occupancy groups B or M.** Security grilles abutting
25 sidewalks on buildings in occupancy groups B or M shall comply with the retroactive
26 requirements of item 4 of section [1008.1.4.5] 1010.1.4.4 of the New York [City] city building
27 code. On and after July 1, 2026, such grilles when closed shall permit visibility from the sidewalk
28 of at least 70 percent of the area covered by such grille.

29 **§28-315.8 Resiliency.** The work specified in this section to enhance building resiliency shall be
30 completed by the dates specified herein.

31 **§28-315.8.1 Emergency source of water for residential occupancies.** [~~Within 8 years after the~~
32 ~~effective date of this section,~~] As of December 31, 2022, existing buildings greater than five
33 stories in occupancy groups I-1, R-1, R-2, and R-3 that supply potable water from the public water
34 main to occupants with the assistance of pumps, other than pumps connected to an emergency or
35 a standby power system that complies with the requirements of chapter 27 of the New York [City]
36 city building code, shall be equipped with additional fixtures capable of supplying potable water
37 to occupants utilizing only the available pressure from the public water main in compliance with
38 section 614 of the New York [City] city plumbing code.

1 **§28-315.8.2 Connections for temporary external generators.** For the following buildings, the
2 provision of connections for temporary external generators in accordance with the retroactive
3 requirements of section [~~G311.2~~] G312.2 of appendix G of the New York [~~City~~] city building
4 code shall be completed by January 1, 2033, and a report detailing compliance with such
5 requirements shall be filed with the department in accordance with section [~~G311.2.2~~] G312.2.2
6 of such appendix by such date:

- 7 1. Buildings whose main use or dominant occupancy is group I-1 and that are located in [~~an~~
8 ~~area of~~] a special flood hazard area, as such term is defined in appendix G of the New
9 York [~~City~~] city building code;
- 10 2. Buildings whose main use or dominant occupancy is an adult home, enriched housing,
11 community residence or intermediate care facility classified as occupancy group R
12 pursuant to an exception to section [~~308.2.1~~] 308.3.1 or [~~308.2.2~~] 308.3.2 of the New York
13 [~~City~~] city building code and that are located in [~~an area of~~] a special flood hazard area,
14 as such term is defined in appendix G of the New York [~~City~~] city building code;
- 15 3. Buildings whose main use or dominant occupancy is group I-2 hospital and that are located
16 in [~~an area of~~] a special flood hazard area or shaded X-Zone, as such terms are defined in
17 appendix G of the New York [~~City~~] city building code;
- 18 4. Buildings whose main use or dominant occupancy is group I-2 nursing home and that are
19 located in [~~an area of~~] a special flood hazard area, as such term is defined in appendix G
20 of the New York [~~City~~] city building code; and
- 21 5. Buildings whose main use or dominant occupancy is group I-2, other than hospitals and
22 nursing homes, and that are located in [~~an area of~~] a special flood hazard area, as such
23 term is defined in appendix G of the New York [~~City~~] city building code.

24 **§28-315.8.2.1 Modification to the [~~area of special~~] flood hazard [~~or shaded X-Zone~~] area.**
25 Where the [~~area of~~] special flood hazard area or shaded X-Zone, as established in appendix G
26 of the New York [~~City~~] city building code, is modified on or after the effective date of this
27 section, any building identified in section 28-315.8.2 of this code and newly identified as
28 being within such modified [~~area of~~] special flood hazard area or shaded X-Zone shall, no
29 later than 20 years following the adoption of such modification, comply with the retroactive
30 requirements of section [~~G311.2~~] G312.2 of appendix G of the New York [~~City~~] city building
31 code. The owner of such building shall, no later than 20 years following the adoption of such
32 modification, file with the department a report detailing compliance with such requirements
33 in accordance with section [~~G311.2.2~~] G312.2.2 of such appendix.

34 **§28-315.8.3 Connections for temporary external boilers and chillers.** For buildings whose main
35 use or dominant occupancy is group I-2 hospital and that are located in [~~an area of special~~] a flood
36 hazard [~~or shaded X-Zone~~] area, as such [~~terms are~~] term is defined in appendix G of the New York
37 [~~City~~] city building code, the provision of connections for temporary external boilers and chillers in
38 accordance with the retroactive requirements of section [~~G311.3~~] G312.3 of appendix G of the New
39 York [~~City~~] city building code shall be completed by January 1, 2033, and a report detailing
40 compliance with such requirements shall be filed with the department in accordance with section
41 [~~G311.3.2~~] G312.3.2 of such appendix by such date.

42 **§28-315.8.3.1 Modification to the [~~area of special~~] flood hazard [~~or shaded X-Zone~~] area.**
43 Where the [~~area of~~] special flood hazard area or shaded X-Zone, as established in appendix G

1 of the New York [~~City~~] city building code, is modified on or after the effective date of this
2 section, any building whose main use or dominant occupancy is group I-2 hospital and that is
3 newly identified as being within such modified [~~area of~~] special flood hazard area or shaded
4 X-Zone shall, no later than 20 years following the adoption of such modification, comply with
5 the retroactive requirements of section [~~G311.3~~] G312.3 of appendix G of the New York
6 [~~City~~] city building code. The owner of such building shall, no later than 20 years following
7 the adoption of such modification, file with the department a report detailing compliance with
8 such requirements in accordance with section [~~G311.3.2~~] G312.3.2 of such appendix.

9 **§28-315.9 Single-occupant toilet rooms.** Notwithstanding any other provision of law or rule
10 requiring separate facilities for each sex, on and after January 1, 2017, all single-occupant toilet rooms
11 shall be made available for use by persons of any sex in accordance with section [~~403.2.1~~] 403.2.2 of
12 the New York city plumbing code. Nothing in this section shall be construed to require physical
13 alteration of a single-occupant toilet room except for the posting and maintenance of appropriate
14 signage in accordance with section 403.4 such code. [~~of the New York city plumbing code.~~]

15 **§28-315.10 Self-closing doors.** All doors providing access to interior corridors or stairs in occupancy
16 groups R-1 and R-2 shall be self-closing or equipped with a device that will ensure closing after
17 having been opened by July 31, 2021.

18 **§28-315.11 Buildings that are equipped with a fire alarm system and that contain Group A-1,**
19 **A-2, A-3, Group B or Group M occupancies.** By [~~January~~] July 1, 2021, existing buildings equipped
20 with a fire alarm system and that contain group A-1, A-2 or A-3, Group B or Group M occupancies
21 shall comply with the retroactive requirements of section [~~908.7.3.1~~] 915.1.2.1 of the New York city
22 building code.

23 ARTICLE 316

24 INSULATION OF CONCEALED PIPES EXPOSED DURING ALTERATION OR REPAIR

25 **§28-316.1 Required insulation of certain concealed piping exposed during alteration or repair.**
26 Where concealed existing piping is exposed in the course of the alteration or repair of a building, the
27 owner of the building shall provide for the insulation of the exposed piping. The exposed piping shall
28 be insulated to the extent required by the New York [~~City~~] city energy conservation code for newly
29 installed pipe of the same specifications and serving the same function as the exposed pipe. The entire
30 exposed length of the piping shall be insulated as well as any further length of concealed pipe that
31 can be directly accessed through openings made in the course of such alteration or repair.

32 **Exceptions:**

- 33 1. Exposed pipe with [~~one-~~] 1 inch (25-mm) thick continuous coverage of existing insulation
34 in good condition.
- 35 2. Where the length of concealed pipe which may be directly accessed through openings
36 made in the course of such alteration or repair is less than three feet (914 mm).
- 37 3. Where there is not sufficient space to insulate pipes to the extent required by the New
38 York [~~City~~] city energy conservation code due to conflicts with existing construction,
39 pipes shall be insulated to the extent that space allows.

1 Consecutive annual certifications shall be submitted at least 90 days apart. The department of health
2 and mental hygiene shall send an electronic reminder to each owner or operator of a cooling tower at
3 least 30 days before such certification submission deadline. Such electronic reminder shall include a
4 link to the website where such certification may be submitted.

5 **§28-317.6 Fees.** The department may charge filing fees for registration, discontinuing of use and
6 annual certification as set forth in the rules of the department.

7 **§28-317.7 Enforcement.** Failure to register a cooling tower or submit a certification or statement
8 required by this article shall be classified as a major violation.

9 **ARTICLE 318**
10 **PERIODIC INSPECTION OF GAS PIPING SYSTEMS**

11 **§28-318.1 General.** [~~Commencing January 1, 2019, building~~] Building gas piping systems, other than
12 gas piping systems of buildings classified in occupancy group R-3, shall be periodically inspected in
13 accordance with this article.

14 **Exception:** A building that contains no gas piping and for which the owner of such building has
15 submitted to the commissioner, in a form and manner determined by the commissioner, a
16 certificate of a registered design professional, or a person satisfying other qualifications that the
17 commissioner may establish, that such building contains no gas piping.

18 **§28-318.2 Frequency of inspection.** An inspection of a building's gas piping system shall be
19 conducted at periodic intervals as set forth by rule of the commissioner, but such inspection shall be
20 conducted at least once every five years.

21 **Exceptions:**

- 22 1. If the New York state public service commission adopts a rule or other requirement for
23 periodic inspections of service lines, as defined in section 255.3 of title 16 of the New
24 York codes, rules and regulations, with a frequency other than five years, the
25 commissioner may, by rule, require that the periodic inspections required by this article
26 be conducted with such frequency.
- 27 2. The initial inspection for a new building shall be conducted in the tenth year after the
28 earlier of (i) the issuance by the department of a letter of completion or, if applicable, a
29 temporary or final certificate of occupancy for such building or (ii) the date such building
30 was completed as determined by department rule.

31 **§28-318.3 Inspection process.** Gas piping systems shall be inspected and tested in accordance with
32 sections 28-318.3.1 through 28-318.3.4.

33 **§28-318.3.1 Inspection entity.** Inspections of gas piping systems shall be conducted on behalf of
34 the building owner by a licensed master plumber or by an individual under the direct and
35 continuing supervision of a licensed master plumber, with appropriate qualifications as prescribed
36 by department rule.

37 **§28-318.3.2 Scope.** At each inspection, in addition to the requirements prescribed by this article
38 or by the commissioner, all exposed gas lines from point of entry of gas piping into a building,

1 including building service meters, up to individual tenant spaces shall be inspected for evidence
2 of excessive atmospheric corrosion or piping deterioration that has resulted in a dangerous
3 condition, illegal connections, and non-code compliant installations. The inspection entity shall
4 also test public spaces, hallways, corridors, and mechanical and boiler rooms with a portable
5 combustible gas detector to determine if there is any gas leak, provided that such testing need only
6 include public spaces, hallways and corridors on floors that contain gas piping or gas utilization
7 equipment.

8 **§28-318.3.3 Report and certificate of inspection.** The inspection entity conducting an inspection
9 of a building pursuant to this article and the owner of such building shall comply with the
10 following requirements:

- 11 1. No later than 30 days after such inspection, such inspection entity shall submit to such
12 owner (i) a report of such inspection, on a form and in a manner determined by the
13 department, and (ii) a certification of the licensed master plumber who performed or
14 exercised direct and continuing supervision over such inspection that an inspection
15 pursuant to this article has been completed for such building. Such report shall be certified
16 by such licensed master plumber and, where applicable, by any individual who performed
17 such inspections under the direct and continuing supervision of such licensed master
18 plumber, and shall include, for each gas piping system inspected, a list of conditions
19 including instances where a part or parts of such system is worn to such an extent that the
20 safe and reliable operation of such system may be affected, gas leaks, any observed non-
21 code compliant installations or illegal connections, any conditions described in section 28-
22 318.3.4 and any additional information required by the department.
- 23 2. No later than the due date for such inspection, in accordance with department rules, and
24 no earlier than 60 days before such due date, such owner shall submit a certification from
25 a licensed master plumber that an inspection pursuant to this article has been completed
26 by such licensed master plumber for such building, provided that the department may by
27 rule establish an alternative timeframe for such submissions.
- 28 3. No later than 90 days after the due date for such inspection, in accordance with department
29 rules, such owner shall electronically submit, or cause to be submitted by such inspection
30 entity, such report to the utility company providing gas service to such building. Such
31 submission shall only be required if, before the date that such submission would be
32 required, the department has determined and set forth in a rule that such utility company
33 will accept such electronic submission at no cost to such owner.
- 34 4. No later than 120 days after the due date for such inspection, in accordance with
35 department rules, such owner shall submit to the department, in a form and manner
36 determined by the department, (i) a certification from a licensed master plumber that all
37 conditions that were identified in the inspection report for which a certification was
38 submitted pursuant to item 2 of this section have been corrected, except that such
39 certification may note that correction of one or more conditions identified in such report,
40 other than conditions referred to in section 28-318.3.4, will reasonably take additional time
41 to complete and (ii) a certification from such owner that such owner is in compliance with
42 item 3 of this section. If such certification notes that one or more conditions will take
43 additional time to complete, such owner shall, no later than 180 days after the due date for
44 such inspection, submit to the department, in a form and manner determined by the

1 department, a certification from a licensed master plumber that all conditions identified in
2 such report have been corrected.

- 3 5. All reports and certifications required by this section shall be kept on file by the inspection
4 entity and the building owner for at least eight years after the date of inspection and made
5 available to the department at the department’s request.

6 **§28-318.3.4 Reporting and correction of unsafe or hazardous condition.** If an inspection reveals
7 any of the following conditions, the inspection entity shall notify the building owner, the utility and
8 the department immediately and the building owner shall immediately take action to correct such
9 condition in compliance with the New York city construction codes:

- 10 1. A gas leak;
11 2. Evidence of illegal connections or non-code compliant installations; or
12 3. Any other condition which (i) if verified by a utility company or utility corporation, would
13 constitute a class A condition as described in part 261 of title 16 of the New York codes,
14 rules and regulations or (ii) constitutes an imminently dangerous condition.

15 **§28-318.4 Fees.** The department may charge filing fees for the certifications required by section 28-
16 318.3.3, as set forth in the rules of the department.

17 **§28-318.5 Enforcement.** Failure to submit a certification required by this article shall be classified
18 as a major violation.

19 **ARTICLE 319**
20 **MAINTENANCE AND REMOVAL OF SMALL WIND TURBINES**

21 **§28-319.1 Maintenance.** The owner of a small wind turbine or small wind turbine tower, as such
22 terms are defined in [~~section 3113.2~~] chapter 2 of the New York city building code, shall maintain
23 such turbine and tower in accordance with department rules.

24 **§28-319.2 Removal.** The owner of a small wind turbine, as such term is defined in [~~section 3113.2~~]
25 chapter 2 of the New York city building code, shall remove such turbine when (i) the time elapsed
26 since installation exceeds the manufacturer’s suggested useful life of such turbine or (ii) such turbine
27 has been continuously inoperable for 12 months or more, whichever occurs sooner, provided that the
28 commissioner shall by rule establish a timeframe for removing small wind turbines that do not have
29 manufacturer’s suggested useful lives.

30 **ARTICLE 320**
31 **BUILDING ENERGY AND EMISSIONS LIMITS**
32

33 **§28-320.1 Definitions.** As used in this article, the following terms shall have the following meanings:

34 **BUILDING EMISSIONS.** The term “building emissions” means greenhouse gas emissions as
35 expressed in metric tons of carbon dioxide equivalent emitted as a result of operating a covered
36 building and calculated in accordance with rules promulgated by the department in consultation with
37 the mayor’s office of long term planning and sustainability. The term “building emissions” shall not
38 include greenhouse gas emissions emitted during a local state of emergency declared by the mayor

1 pursuant to section 24 of the executive law or a state of emergency declared by the governor pursuant
2 to sections 28 of the executive law, where such local or state emergency has an impact on building
3 emissions.

4 **BUILDING EMISSIONS INTENSITY.** The term “building emissions intensity” means, for a
5 covered building, the number obtained by dividing the building emissions by the gross floor area for
6 such building, expressed in metric tons of carbon dioxide equivalent per square foot per year.

7 [~~Carbon dioxide equivalent~~] **CARBON DIOXIDE EQUIVALENT.** The term “carbon dioxide
8 equivalent” means the metric used to compare the emissions of various greenhouse gases based upon
9 their global warming potential as defined in the Intergovernmental Panel on Climate Change Fifth
10 Assessment Report (2014).

11 **CAPACITY RESOURCE.** The term “capacity resource” means a facility that has the capability to
12 generate and transmit electrical power and sell capacity (i) by bilateral contracts, (ii) in the wholesale
13 capacity market, or (iii) by indirect sales of capacity in the wholesale market in accordance with the
14 schedules of rates and charges of a utility in effect pursuant to section 66 of the New York state public
15 service law.

16 **CITY BUILDING.** The term “city building” means a building that is owned by the city or for which
17 the city regularly pays all of the annual energy bills, or a cultural institution that is in the Cultural
18 Institutions Group as determined by the department of cultural affairs for which the city regularly
19 pays all or part of the annual energy bills.

20 **Exception:** The term “city building” shall not include any senior college in the city university of
21 New York system.

22 **CLEAN DISTRIBUTED ENERGY RESOURCE.** The term “clean distributed energy resource”
23 means a distributed energy resource that (i) uses any of the following sources to generate electricity:
24 hydropower, solar photovoltaics, geothermal wells or loops, tidal action, waves or water currents, or
25 wind; or (ii) is designed and operated to store energy, including but not limited to batteries, thermal
26 systems, mechanical systems, compressed air, and superconducting equipment.

27 **COVERED BUILDING.** The term “covered building” means, as it appears in the records of the
28 department of finance, (i) a building that exceeds 25,000 gross square feet (2322.5 m²) or (ii) two or
29 more buildings on the same tax lot that together exceed 50,000 gross square feet (4645 m²), or (iii)
30 two or more buildings held in the condominium form of ownership that are governed by the same
31 board of managers and that together exceed 50,000 gross square feet (4645 m²).

32 **Exceptions:**

- 33 1. An industrial facility primarily used for the generation of electric power or steam.
- 34 2. Real property, not more than three stories, consisting of a series of attached, detached or
35 semi-detached dwellings, for which ownership and the responsibility for maintenance of
36 the HVAC systems and hot water heating systems is held by each individual dwelling unit
37 owner, and with no HVAC system or hot water heating system in the series serving more

- 1 than 25,000 gross square feet (2322.5 m²), as certified by a registered design professional
2 to the department.
- 3 3. A city building.
- 4 4. A housing development or building on land owned by the New York city housing authority
- 5 5. A rent regulated accommodation.
- 6 6. A building whose main use or dominant occupancy is classified as occupancy group A-3
7 religious house of worship.
- 8 7. Real property owned by a housing development fund company organized pursuant to the
9 business corporation law and article eleven of the private housing finance law.
- 10 8. A building that participates in a project-based federal housing program.

11 **DISTRIBUTED ENERGY RESOURCE.** The term “distributed energy resource” means a resource
12 comprised of one or multiple units capable of generating or storing electricity, all at a single location
13 that is directly or indirectly connected to an electric utility transmission and distribution system. The
14 resource may serve all or part of the electric load of one or more customers at the same location, and
15 it may simultaneously or alternatively transmit all or part of the electricity it generates or stores onto
16 the electric transmission and distribution system for sale to or use by other customers at other
17 locations.

18 [~~Greenhouse gas~~] **GREENHOUSE GAS.** The term “greenhouse gas” means a unit of greenhouse
19 gas, including carbon dioxide (CO₂), methane (CH₄), nitrous oxide (N₂O), hydrofluorocarbons
20 (HFCs), perfluorocarbons (PFCs), sulfur hexafluoride (SF₆), and nitrogen trifluoride (NF₃).

21 **GREENHOUSE GAS OFFSET.** The term “greenhouse gas offset” means a credit representing one
22 metric ton of carbon dioxide equivalent emissions reduced, avoided, or sequestered by a project from
23 a measured baseline of emissions and which has been verified by an independent, qualified third party
24 in accordance with offset standards referenced by rules of the department.

25 **FINANCIAL HARDSHIP (OF A BUILDING).** The term “financial hardship (of a building)”
26 means a building that for the combined two years prior to the application for an adjustment to annual
27 building emissions limit pursuant to section 28-320.7:

- 28 1. Had arrears of property taxes or water or wastewater charges that resulted in the property’s
29 inclusion on the department of finance’s annual New York city tax lien sale list;
- 30 2. Had been exempt from real property taxes pursuant to sections 420-a, 420-b, 446 or 462 of
31 the real property tax law and applicable local law and the owner had negative revenue less
32 expenses as certified to the department by a certified public accountant, or by affidavit under
33 penalties of perjury; or
- 34 3. Had outstanding balances under the department of housing preservation and development’s
35 emergency repair program that resulted in the property’s inclusion on the department of
36 finance’s annual New York city tax lien sale list.

1 **METRIC TONS OF CARBON DIOXIDE EQUIVALENT.** The term “metric tons of carbon
2 dioxide equivalent” means the global standard unit in carbon accounting to quantify greenhouse gas
3 emissions, also expressed as tCO₂e.

4 **RENEWABLE ENERGY CREDIT.** The term “renewable energy credit” means a certificate
5 representing the environmental, social and other non-power attributes of one megawatt-hour of
6 electricity generated from a renewable energy resource, which certificate is recognized and tradable
7 or transferable within national renewable energy markets or the New York generation attribute
8 tracking system. This term also means the environmental, social, and other non-power attributes of
9 one megawatt-hour of electricity generated from a hydropower resource that does not trade or transfer
10 renewable energy certificates for those hydropower resources in any renewable energy market or via
11 the New York generation attribute tracking system, provided that the hydropower resource owner
12 certifies the amount of energy produced in each reporting year and that it has not sold the non-power
13 attributes equal to its energy production more than once.

14 **RENT REGULATED ACCOMMODATION.** The term “rent regulated accommodation” means a
15 building in which more than 35[%] percent of dwelling units are required by law or by an agreement
16 with a governmental entity to be regulated in accordance with the New York state emergency tenant
17 protection act of 1974, the New York city rent stabilization law of 1969, or the local emergency
18 housing rent control act of 1962.

19 **§28-320.2 Advisory board.** There shall be an advisory board convened by the office of building
20 energy and emissions performance upon the effective date of this article, in January of 2029 and in
21 January of 2039, to provide advice and recommendations to the commissioner and to the mayor’s
22 office of long term planning and sustainability relating to effectively reducing greenhouse gas
23 emissions from buildings. Such recommendations shall include, but not be limited to:

- 24 1. A report and recommendations to be delivered to the mayor and the speaker of the city council
25 no later than January 1, 2023 for additional or improved approaches to assessing building
26 energy performance. Such report shall include, but not be limited to:
 - 27 1.1. An approach for buildings to submit energy use or greenhouse gas emissions and other
28 information for the purpose of assessing energy performance of covered buildings;
 - 29 1.2. A methodology that includes the metric of measure, adjustments to the metric, the
30 approach to comparing the output to a benchmark, alternative compliance paths, credit
31 for beneficial electrification and distributed energy resources, and an approach for a
32 trading mechanism as described in section 28-320.11;
 - 33 1.3. Recommendations for addressing tenant-controlled energy usage;
 - 34 1.4. Recommendations for amendments to the audit required under section 28-308.2[~~of the~~
35 ~~administrative code~~], including consideration of whether such audit should be replaced
36 by a capital plan;
 - 37 1.5. Recommendations for reducing building emissions from rent regulated
38 accommodations;

- 1 1.6. Recommendations for allowing additional time to comply with the emissions limits for
2 buildings converting to a new occupancy group or use with lower emissions limits or
3 some other change in status that would affect applicability of the provisions of this
4 article;

- 5 1.7. An evaluation of the extent to which the mayor’s 80x50 energy infrastructure pathways
6 study is incorporated and addressed within the recommendations made pursuant to items
7 1.1 through 1.6 of this section; and

- 8 1.8. A reference guide to delineate the responsibilities of the building designer and owners
9 to comply with emissions limits.

- 10 2. A report to be delivered to the mayor and the speaker of the city council no later than January
11 1, 2023, providing an analysis of, and any recommendations for improving, energy and
12 emissions performance requirements for covered buildings. Such recommendations shall be
13 targeted to achieve at least a 40 percent reduction in aggregate greenhouse gas emissions from
14 covered buildings by calendar year 2030 relative to such emissions for the calendar year 2005.
15 Such report shall include, but not be limited to assessments of:
 - 16 2.1. Incentives for reduction of peak energy demand;
 - 17 2.2. Methods to allow for staggered reporting cycles for compliance with energy and
18 emissions performance improvements;
 - 19 2.3. Methods for calculating penalties for non-compliance;
 - 20 2.4. Estimated emissions reductions associated with any recommended energy performance
21 requirements;
 - 22 2.5. The economic impact, including benefits, of achieving the energy and emissions
23 performance requirements;
 - 24 2.6. Methods for achieving earlier or larger reductions from city buildings;
 - 25 2.7. Separate improvement targets for base building energy systems and tenant-controlled
26 energy systems;
 - 27 2.8. Methods for achieving emissions reductions from manufacturing and industrial
28 processes; and
 - 29 2.9. Methods for achieving emissions reductions from hospitals while maintaining critical
30 care for human health and safety.

31 **§28-320.2.1 Advisory board composition.** Such advisory board shall be staffed with registered
32 design professionals and be composed of 19 members as follows: the chairperson, the speaker of
33 the council or the speaker’s designee, the mayor or the mayor’s designee, eight members
34 appointed by the mayor, and eight members appointed by the speaker of the council. The mayor
35 shall appoint one architect, one engineer, one building owner or manager, one public utility
36 industry representative, one environmental justice representative, one business sector

1 representative, one residential tenant representative, and one environmental advocacy
2 organization representative. The speaker shall appoint one architect, one stationary engineer, one
3 construction trades representative, one green energy industry representative, one residential tenant
4 representative, one environmental justice organization representative, one environmental
5 advocacy representative and one not for profit organization representative. The director of such
6 office, or the designee of such director, shall serve as chairperson of the advisory board. The
7 advisory board may convene in working groups. Such working groups may include individuals
8 not on such advisory board to address the recommendations required by this article. The mayor
9 shall invite the appropriate federal, state and local agencies and authorities to participate,
10 including but not limited to the New York state energy research and development authority. Such
11 advisory board shall convene a working group on hospitals that shall be composed of engineers,
12 architects, and hospital industry representatives.

13 **§28-320.3 Building emissions limits.** Except as otherwise provided in this article, or otherwise
14 provided by rule, on and after January 1, 2024, a covered building shall not have annual building
15 emissions higher than the annual building emissions limit for such building as determined in
16 accordance with this section based on the occupancy group of the building.

17 **§28-320.3.1 Annual building emissions limits 2024-2029.** For calendar years 2024 through
18 2029, the annual building emissions limits for covered buildings shall be calculated pursuant to
19 items 1 through 10 of this section. For the purposes of such calculation the department shall
20 provide a method for converting categories of uses under the United States environmental
21 protection agency Portfolio Manager tool to the equivalent uses and occupancy groups set forth
22 in this section. For a covered building with spaces classified in more than one occupancy group,
23 the annual building emissions limit shall be the sum of the calculated values from items 1 through
24 10 of this paragraph, as applicable for each space.

- 25 1. For spaces classified as occupancy group A: multiply the building emissions intensity limit
26 of 0.01074 tCO_{2e}/sf by the corresponding gross floor area (sf);
- 27 2. For spaces classified as occupancy group B other than as described in item 6: multiply the
28 building emissions intensity limit of 0.00846 tCO_{2e}/sf by the corresponding gross floor
29 area (sf);
- 30 3. For spaces classified as occupancy groups E and I-4: multiply the building emissions
31 intensity limit of 0.00758 tCO_{2e}/sf by the corresponding gross floor area (sf);
- 32 4. For spaces classified as occupancy group I-1: multiply the building emissions intensity
33 limit of 0.01138 tCO_{2e} /sf by the corresponding gross floor area (sf);
- 34 5. For spaces classified as occupancy group F: multiply the building emissions intensity limit
35 of 0.00574 tCO_{2e}/sf by the corresponding gross floor area (sf);
- 36 6. For spaces classified as occupancy groups B civic administrative facility for emergency
37 response services, B non-production laboratory, Group B ambulatory health care facility,
38 H, I-2 and I-3: multiply the building emissions intensity limit of 0.02381 tCO_{2e}/sf by the
39 corresponding gross floor area (sf);

- 1 7. For spaces classified as occupancy group M: multiply the building emissions intensity
2 limit of 0.01181 tCO_{2e}/sf by the corresponding gross floor area (sf);
- 3 8. For spaces classified as occupancy group R-1: multiply the building emissions intensity
4 limit of 0.00987 tCO_{2e}/sf by the corresponding gross floor area (sf);
- 5 9. For spaces classified as occupancy group R-2: multiply the building emissions intensity
6 limit of 0.00675 tCO_{2e}/sf by the corresponding gross floor area (sf);
- 7 10. For spaces classified as occupancy groups S and U: multiply the building emissions
8 intensity limit of 0.00426 tCO_{2e}/sf by the corresponding gross floor area (sf).

9 **§28-320.3.1.1 Greenhouse gas coefficient of energy consumption for calendar years 2024**
10 **through 2029.** The annual building emissions of a covered building in accordance with this
11 section, greenhouse gas emissions shall be calculated as follows for calendar years 2024 through
12 2029:

- 13 1. Utility electricity consumed on the premises of a covered building that is delivered to the
14 building via the electric grid shall be calculated as generating 0.000288962 tCO_{2e} per
15 kilowatt hour or, at the owner's option, shall be calculated based on time of use in
16 accordance with referenced emissions factors promulgated by rules of the department. The
17 department, in consultation with the office of long term planning and sustainability, shall
18 promulgate rules governing the calculation of greenhouse gas emissions for campus-style
19 electric systems that share on-site generation but make use of the utility distribution
20 system and for buildings that are not connected to the utility distribution system.
- 21 2. Natural gas combusted on the premises of a covered building shall be calculated as
22 generating 0.00005311 tCO_{2e} per kbtu.
- 23 3. #2 fuel oil combusted on the premises of a covered building shall be calculated as
24 generating 0.00007421 tCO_{2e} per kbtu.
- 25 4. #4 fuel oil combusted on the premises of a covered building shall be calculated as
26 generating 0.00007529 tCO_{2e} per kbtu.
- 27 5. District steam consumed on the premises of a covered building shall be calculated as
28 generating 0.00004493 tCO_{2e} per kbtu.
- 29 6. The amount of greenhouse gas emissions attributable to natural gas powered fuel cells
30 shall be credited compared to the electricity grid marginal emissions factor that will be
31 determined by the commissioner and promulgated into rules of the department.

32 **Exception:** Natural gas powered fuel cells that commence operation prior to the later of
33 January 1, 2023 or the promulgation of such rules, shall be credited compared to the
34 electricity grid marginal emissions factor published in the most recent New York state
35 energy research and development authority renewable energy standard program impact
36 evaluation and clean energy standard triennial review, or a successor to such report issued
37 by the New York state energy research and development authority.

- 1 7. The amount of greenhouse gas emissions attributable to other energy sources, including
2 but not limited to distributed energy resources, shall be determined by the commissioner
3 and promulgated into rules of the department.

4 **§28-320.3.2 Building emissions limits for calendar years 2030 through 2034.** For calendar
5 years 2030 through 2034, the annual building emissions limits for covered buildings shall be
6 calculated pursuant to items 1 through 10 of this section. For the purposes of such calculation, the
7 department shall provide a method for converting categories of uses under the United States
8 environmental protection agency Portfolio Manager tool to the equivalent uses and occupancy
9 groups set forth in this section. For a covered building with spaces classified in more than one
10 occupancy group, the annual building emissions limit shall be the sum of the calculated values
11 from items 1 through 10 of this paragraph, as applicable for each space. The department may
12 establish different limits, including a different metric or method of calculation, set forth in the
13 rules of the department, where the department determines that different limits are feasible and in
14 the public interest. Where such limits are set by rule, the average emission limits for all covered
15 buildings shall not be less restrictive than the average emissions impact of the building emissions
16 limits outlined in items 1 through 10 of this section. The advisory board and the office of long
17 term planning and sustainability shall provide advice and recommendation regarding such limits.

- 18 1. For spaces classified as occupancy group A: multiply the building emissions intensity limit
19 of 0.00420 tCO_{2e}/sf by the corresponding gross floor area (sf);
- 20 2. For spaces classified as occupancy group B other than as described in item 6: multiply the
21 building emissions intensity limit of 0.00453 tCO_{2e}/sf by the corresponding gross floor
22 area (sf);
- 23 3. For spaces classified as occupancy groups E and I-4: multiply the building emissions
24 intensity limit of 0.00344 tCO_{2e}/sf by the corresponding gross floor area (sf);
- 25 4. For spaces classified as occupancy group I-1: multiply the building emissions intensity
26 limit of 0.00598 tCO_{2e}/sf by the corresponding gross floor area (sf);
- 27 5. For spaces classified as occupancy group F: multiply the building emissions intensity limit
28 of 0.00167 tCO_{2e}/sf by the corresponding gross floor area (sf);
- 29 6. For spaces classified as occupancy groups B civic administrative facility for emergency
30 response services, B non-production laboratory, Group B ambulatory health care facility,
31 H, I-2 or I-3: multiply the building emissions intensity limit of 0.01330 tCO_{2e}/sf by the
32 corresponding gross floor area (sf);
- 33 7. For spaces classified as occupancy group M: multiply the building emissions intensity
34 limit of 0.00403 tCO_{2e}/sf by the corresponding gross floor area (sf);
- 35 8. For spaces classified as occupancy group R-1: multiply the building emissions intensity
36 limit of 0.00526 tCO_{2e}/sf by the corresponding gross floor area (sf);
- 37 9. For spaces classified as occupancy groups R-2: multiply the building emissions intensity
38 limit of 0.00407 tCO_{2e}/sf by the corresponding gross floor area (sf);

1 10. For spaces classified as occupancy groups S and U: multiply the building emissions
2 intensity limit of 0.00110 tCO_{2e}/sf by the corresponding gross floor area (sf).

3 **§28-320.3.2.1 Greenhouse gas coefficients of energy consumption for calendar years**
4 **2030 through 2034.** For the purposes of calculating the annual building emissions of a
5 covered building in accordance with this section, the amount of greenhouse gas emissions
6 attributed to particular energy sources shall be determined by the commissioner and
7 promulgated into rules of the department by no later than January 1, 2023. The commissioner
8 shall consult with the advisory board required by this article to develop such greenhouse gas
9 coefficients for utility electricity consumption. When developing such coefficients, the
10 commissioner shall consider factors, including but not limited to the best available New York
11 state energy research and development authority and State Energy Plan marginal forecasts for
12 Zone J for the end of the compliance period and beneficial electrification.

13 **§28-320.3.4 Building emissions limits for calendar years 2035 through 2050.** No later than
14 January 1, 2023, the commissioner shall establish by rule annual building emissions limits and
15 building emissions intensity limits applicable for calendar years 2035 through 2039 and building
16 emissions limits and building emissions intensity limits applicable for calendar years 2040
17 through 2049. Such limits shall be set to achieve an average building emissions intensity for all
18 covered buildings of no more than 0.0014 tCO_{2e} /sf/yr by 2050.

19 **§28-320.3.5 Building emissions limits on and after calendar year 2050.** No later than January
20 1, 2023, the commissioner shall establish by rule annual building emissions limits and building
21 emissions intensity limits applicable for calendar years commencing on and after January 1, 2050.
22 Such limits shall achieve an average building emissions intensity for all covered buildings of no
23 more than 0.0014 tCO_{2e} /sf/yr.

24 **§28-320.3.6 Deductions from reported annual building emissions.** The department may authorize
25 a deduction from the annual building emissions required to be reported by an owner pursuant to
26 section 28-320.3 where the owner demonstrates the purchase of greenhouse gas offsets or renewable
27 energy credits, or the use of clean distributed energy resources, in accordance with this section. For
28 such sections that limit the dates of applicability of such deductions, the department shall promulgate
29 rules to extend such deductions for each future compliance date.

30 **§28-320.3.6.1 Deductions from reported annual building emissions for renewable energy**
31 **credits.** A deduction from the reported annual building emissions shall be authorized equal to
32 the number of renewable energy credits purchased by or on behalf of a building owner,
33 provided (i) the renewable energy resource that is the source of the renewable energy credits
34 is considered by the New York independent system operator to be a capacity resource located
35 in, or whose output directly sinks into, the zone J load zone for the reporting calendar year;
36 (ii) the renewable energy credits are solely owned and retired by, or on behalf of, the building
37 owner; (iii) the renewable energy credits are from the same year as the reporting year; and (iv)
38 the building that hosts the system producing the energy does not receive a deduction under
39 section 28-320.3.6.3. Covered buildings claiming deductions for renewable energy credits
40 under this section must provide the department with the geographic location of the renewable
41 energy resource that created the renewable energy credits. The department, in consultation
42 with the mayor's office of long term planning and sustainability, shall promulgate rules to
43 implement this deduction.

1 **§28-320.3.6.2 Deductions from reported annual building emissions for purchased**
2 **greenhouse gas offsets.** For calendar years 2024 through 2029, a deduction shall be
3 authorized for up to 10 percent of the annual building emissions limit. Such a deduction shall
4 be authorized only where within the reporting calendar year, greenhouse gas offsets equivalent
5 to the size of the deduction as measured in metric tons of carbon dioxide equivalent and
6 generated within the reporting calendar year have been (i) purchased by or on behalf of the
7 owner in accordance with an offset standard referenced by rules of the department, (ii)
8 publicly registered in accordance with such offset standard, and (iii) retired or designated to
9 the department for retirement. Such greenhouse gas offsets must exhibit environmental
10 integrity principles, including additionality, in accordance with rules promulgated by the
11 department in consultation with the office of long term planning and sustainability. For the
12 purposes of this section, additionality means a requirement that an offset project is not already
13 required by local, national or international regulations. Prior to the department promulgation
14 of rules pursuant to this section, the department shall consult the advisory board on
15 environmental justice as established by section 3-1006 of the administrative code.

16 **§28-320.3.6.3 Deductions from reported annual building emissions for clean distributed**
17 **energy resources.** A deduction from the reported annual building emissions shall be
18 authorized based upon the calculated output of a clean distributed energy resource located at
19 the building subject to the report. The department shall promulgate rules to set forth how such
20 deduction shall be calculated, in accordance with the following:

- 21 1. For a clean distributed energy resource that generates electricity, the department shall
22 establish separate calculations for each type of commercially available clean
23 distributed energy resource, which shall not be revised more frequently than once
24 every three years.
- 25 2. For a clean distributed energy resource that stores electricity, the deduction shall be
26 based on the size of the resource and its ability to reduce greenhouse gas emissions
27 during designated peak periods.

28 **§28-320.3.7 Reports required to be filed by owner.** By May 1, 2025, and by May [4] first of
29 every year thereafter, the owner of a covered building shall file with the department a report,
30 certified by a registered design professional, prepared in a form and manner and containing such
31 information as specified in rules of the department, that for the previous calendar year such
32 building is either:

- 33 1. In compliance with the applicable building emissions limit established pursuant to section
34 28-320.3; or
- 35 2. Not in compliance with such applicable building emissions limit, along with the amount
36 by which such building exceeds such limit.

37 For a report filed on or after May 1, 2026, where a report required to be submitted by May 1
38 in the prior year indicated that the covered building was not in compliance with the applicable
39 building emissions limit established pursuant to section 28-320.3 in the calendar year covered
40 by such report, but such building is in compliance for the calendar year covered by the report

1 required to be submitted by May 1 in the current year, such report shall describe the methods
2 used to achieve compliance.

3 **§28-320.3.7.1 Extension of time to file report.** An owner may apply for an extension of time
4 to file an annual report required by section 28-320.3.7 in accordance with this section and the
5 rules of the department. An extension may be granted where the owner is unable to file the
6 certified report by the scheduled due date despite such owner's good faith efforts, as
7 documented in such application. An extension granted pursuant to this section shall not
8 modify the owner's obligation to comply with the applicable emission limits for such calendar
9 year.

10 **§28-320.3.7.2 Reporting on compliance by the department.** By January 1, 2026, and
11 January 1 of every year thereafter, the office of building energy and emissions performance
12 shall submit to the mayor and speaker of the council a report relating to compliance with this
13 section. Such report shall include, but not be limited to:

- 14 1. Beginning with the report due January 1, 2027, the methods used by covered buildings
15 to comply with the building emissions limits established pursuant to section 28-320.3
16 where such buildings were not in compliance for the report submitted in the previous
17 year, including, as applicable, any retrofitting improvements and purchasing of clean
18 energy, disaggregated by method and by number of buildings; and
- 19 2. The total number of buildings in each occupancy group, and the number of buildings
20 in compliance with emissions limits, disaggregated by occupancy group.

21 **§28-320.3.8 Continuing requirements.** In 2055, the office of building energy and emissions
22 performance shall prepare and submit to the mayor and the speaker of the council
23 recommendations whether to repeal or amend any of the requirements of this article.

24 **§28-320.3.9 Extension for certain income-restricted housing.** This section is applicable to
25 covered buildings:

- 26 1. That are owned by a limited-profit housing company organized under article 2 of the New
27 York state private housing finance law, and
- 28 2. That contain one or more dwelling units for which occupancy or initial occupancy is
29 restricted based upon the income of the occupant or prospective occupant thereof as a
30 condition of a loan, grant, tax exemption, tax abatement, or conveyance of property from
31 any state or local governmental agency or instrumentality pursuant to the private housing
32 finance law, the general municipal law, or section 420-c of the New York state real
33 property tax law.

34 Such covered buildings are exempted from the annual building emissions limits set forth in
35 section 28-320.3.1 and 28-320.3.2 of this code and from any applicable reporting requirements.
36 Commencing January 1, 2035, such covered buildings shall be subject to the annual building
37 emissions limits established pursuant to sections 28-320.3.4 and 28-320.3.5 of this code and any
38 applicable reporting requirements.

1 **§28-320.3.10 Changes in building status.** The department may establish by rule procedures for
2 a building to apply for additional time to comply with the emissions limits when such building
3 converts to a new occupancy group or use with lower emissions limits, or undergoes a change
4 affecting the applicability of this article to such building.

5 **§28-320.3.10.1 Additional time for certain covered buildings.** A covered building where at
6 least one dwelling unit is required by law or by an agreement with a governmental entity to
7 be regulated in accordance with the emergency tenant protection act of 1974, the rent
8 stabilization law of 1969, or the local emergency housing rent control act of 1962, but that is
9 not a rent regulated accommodation pursuant to this article, may delay compliance with annual
10 building emissions limits until January 1, 2026, and submission of the first report required by
11 section 28-320.3.7 until May 1, 2027.

12 **§28-320.4 Assistance.** The office of building energy and emissions performance shall establish and
13 maintain a program for assisting owners of covered buildings in complying with this article, as well
14 as expand existing programs established to assist owners in making energy efficiency and renewable
15 energy improvements. These programs shall be made available to assist building owners without
16 adequate financial resources or technical expertise.

17 **§28-320.5 Outreach and education.** The office of building energy and emissions performance shall
18 establish and engage in outreach and education efforts to inform building owners about building
19 emissions limits, building emissions intensity limits and compliance with this article. The materials
20 developed for such outreach and education shall be made available on the office’s website. Such
21 outreach shall include a list of city, state, federal, private and utility incentive programs related to
22 energy reduction or renewable energy for which buildings reasonably could be eligible. The office of
23 building energy and emissions performance shall also provide outreach, education, and training
24 opportunities for buildings’ maintenance and operations staff.

25 **§28-320.5.1. Reporting on outreach and education.** By June 1, 2021, and by June 1 in every
26 year thereafter, the office of building energy and emissions performance shall submit a report to
27 the mayor and the speaker of the council, detailing the outreach and education efforts made
28 pursuant to section 28-320.5, including, but not limited to information provided about incentive
29 programs and other sources of funding. Such report shall also include the number of staff members
30 working at the office of building energy and emissions performance.

31 **§28-320.6 Penalties.** An owner of a covered building who has submitted a report pursuant to section
32 28-320.3.7 [~~which~~ that] indicates that such building has exceeded its annual building emissions limit
33 shall be liable for a civil penalty of not more than an amount equal to the difference between the
34 building emissions limit for such year and the reported building emissions for such year, multiplied
35 by \$268.

36 **§28-320.6.1 Determination of penalty.** In considering the amount of the civil penalty to be
37 imposed pursuant to this article, a court or administrative tribunal shall give due regard to
38 aggravating or mitigating factors including:

- 39 1. The respondent’s good faith efforts to comply with the requirements of this article,
40 including investments in energy efficiency and greenhouse gas emissions reductions
41 before the effective date of this article;

2. The respondent's history of compliance with this article;
3. The respondent's compliance with the conditions of any adjustment to the applicable building emissions limit, issued by the department pursuant to section 28-320.7;
4. Whether the non-compliance was directly related to unexpected and unforeseeable events or conditions during the calendar year outside the control of the respondent;
5. The respondent's access to financial resources, where the court or administrative tribunal may consider the financial hardship of a building owned by such respondent as evidence of such respondent's access to such financial resources; and
6. Whether payment of such penalty would impact the operations of facilities critical to human life or safety.

§28-320.6.2 Civil penalty for failure to file report. It shall be unlawful for the owner of a covered building to fail to submit an annual report as required by section 28-320.3.7 on or before the applicable due date. An owner of a covered building subject to a violation for failure to file a report shall be liable for a penalty of not more than an amount equal to the gross floor area of such covered building, multiplied by \$0.50, for each month that the violation is not corrected within the 12 months following the reporting deadline; provided, however, that an owner shall not be liable for a penalty for a report demonstrating compliance with the requirements of this article if such report is filed within 60 days of the date such report is due.

§28-320.6.3 False statement. It shall be unlawful to knowingly make a material false statement in a report or other submission filed with the department, pursuant to this article. A violation of this section shall be a misdemeanor and subject to a fine of not more than \$500,000 or imprisonment of not more than 30 days or both such fine and imprisonment. A person who violates this section shall also be liable for a civil penalty of not more than \$500,000.

§28-320.6.4 Penalty recovery. Civil penalties provided for by this article may be recovered in a proceeding before an administrative tribunal within the jurisdiction of the office of administrative trials and hearings. Administrative summonses returnable to such tribunal for violations of this article may be issued by the department or by an agency designated by the department. Civil penalties provided for by this article may also be recovered in an action by the corporation counsel in any court of competent jurisdiction.

§28-320.7. Adjustment to applicable annual building emissions limit. The department, in consultation with the mayor's office of long term planning and sustainability or any other agency designated by the mayor, may grant an adjustment of the annual building emissions limit applicable to a covered building in existence on the effective date of this article or for which a permit for the construction of such building was issued prior to such effective date, provided that the owner is complying with the requirements of this article to the maximum extent practicable.

1. Such an adjustment may be granted upon a specific determination that all of the following conditions in items 1.1 through 1.3 are met:
 - 1.1. Capital improvements are necessary for strict compliance with the limit set forth in section 28-320.3 and it is not reasonably possible to make such improvements due to (i) a constraint imposed by another provision of law, including but not limited to designation as a landmark, landmark site, interior landmark, or within a historic district

1 pursuant to chapter 3 of title 25 of the administrative code, or (ii) a physical condition
2 of the building or building site including but not limited to lack of access to energy
3 infrastructure, space constraints, or lack of access to a space within a building covered
4 by a lease in existence on the effective date of this section;

5 1.2. The owner has made a good faith effort to purchase greenhouse gas offsets to comply
6 with section 28-320.3 but a sufficient quantity is not available at a reasonable cost; and

7 1.3. The owner has availed itself of all available city, state, federal, private and utility
8 incentive programs related to energy reduction or renewable energy for which it
9 reasonably could participate.

10 2. Such an adjustment may be granted upon a specific determination that all of the following
11 conditions in items 2.1 through 2.4 are met:

12 2.1. The cost of financing capital improvements necessary for strict compliance with the
13 limit set forth in section 28-320.3 would prevent the owner of a building from earning a
14 reasonable financial return on the use of such building or the building is subject to
15 financial hardship as defined in this article. In evaluating the ability of an owner to earn
16 a reasonable financial return, the department may consider future savings expected from
17 such capital improvements;

18 2.2. The owner is not eligible for any program funded by the city or enabled by a local law
19 that provides financing for the purpose of energy reduction or sustainability measures.
20 Proof of ineligibility for financing must be demonstrated by rejection from any such
21 program funded by the city or enabled by a local law or an affidavit explanation why
22 such owner could not reasonably participate in such programs;

23 2.3. The owner has made a good faith effort to purchase greenhouse gas offsets or renewable
24 energy credits to comply with section 28-320.3 but a sufficient quantity is not available
25 at a reasonable cost; and

26 2.4. The owner has availed itself of all available city, state, federal, private and utility
27 incentive programs related to energy reduction or renewable energy for which it
28 reasonably could participate.

29 **§28-320.7.1 Effective period.** An adjustment granted pursuant to item 1 of section 28-320.7 may
30 be effective for a period of not more than three calendar years. An adjustment granted pursuant
31 to item 2 of such section may be effective for a period of not more than one calendar year.

32 **§28-320.7.2 Application.** An application for such an adjustment shall be made in the form and
33 manner determined by the department and certified by a registered design professional.

34 **§28-320.8 Adjustment to applicable annual building emissions limit for calendar years 2024-**
35 **2029.** The department may grant an adjustment of the annual building emissions limit for calendar
36 years 2024 through 2029 applicable to a covered building in existence on the effective date of this
37 article where such covered building emissions in calendar year 2018 exceeds the building emissions
38 limit as prescribed by section 28-320.3.1 by more than 40 percent, as reported to the department by a
39 registered design professional. The adjustment shall result in a required building emissions limit that
40 is 70 percent of the calendar year 2018 building emissions for the covered building. Such adjustment
41 may be granted where all of the following conditions in items 1 through 3 are met:

- 1 1. The owner of the covered building demonstrates that the building emissions in excess of the
2 building emissions limit is attributable to special circumstances related to the use of the
3 building, including but not limited to 24 hour operations, operations critical to human health
4 and safety, high density occupancy, energy intensive communications technologies or
5 operations, and energy-intensive industrial processes;
- 6 2. The owner of the covered building demonstrates that the energy performance of the covered
7 building is equivalent to a building in compliance with the New York city energy conservation
8 code in effect on January 1, 2015; and
- 9 3. The owner of the covered building has submitted a plan to the department setting forth a
10 schedule of alterations to the covered building or changes to the operations and management
11 of the covered building sufficient to ensure that the covered building will be in compliance
12 with the annual building emissions limits for calendar years 2030 through 2034, as required
13 by section 28-320.3.2.

14 **§28-320.8.1 Effective period.** An adjustment granted pursuant to section 28-320.8 may be
15 effective for the reporting years 2025 through 2030, as prescribed by section 28-320.3.7, provided
16 that the certificate of occupancy has not been amended after December 31, 2018.

17 **§28-320.8.1.1 Extension of effective period.** The commissioner may also grant an extension
18 of the effective period of the adjustment to applicable annual building emissions limit for
19 calendar years 2030-2035, as prescribed by section 28-320.3.8. Such extension may be
20 granted upon submission of a schedule of alterations to the covered building or changes to the
21 operations and management of the covered building in accordance with section 28-320.8
22 sufficient to ensure that by 2035 the covered building will comply with a required building
23 emissions limit that is 50 percent of the reported 2018 building emissions for the covered
24 building.

25 **§28-320.8.2 Application.** An application for an adjustment shall be submitted to the department
26 before July 1, 2021 in the form and manner determined by the department and certified by a
27 registered design professional.

28 **§28-320.9 Adjustment to applicable annual building emissions limit for not-for-profit hospitals
29 and healthcare facilities.** The department shall grant an adjustment of the annual building emissions
30 limits for calendar years 2024-2029 and 2030-34 where all of the following conditions in items 1 and
31 2 are met:

- 32 1. The building is classified as a not-for-profit hospital, not-for-profit health center, or not-for-
33 profit HIP center, in existence on the effective date of this article; and
- 34 2. By no later than July 21, 2021, the owner of the covered building submits an application to
35 the department for such adjustment in a form and manner prescribed by the department.

36 For calendar years 2024 through 2029, the adjustment shall result in the covered building being
37 subject to an emissions limit that is 85 percent of the calendar 2018 building emissions for such
38 covered building. For calendar years 2030 through 2034, the adjustment shall result in the covered
39 building being subject to an emissions limit that is 70 percent of the calendar 2018 building emissions
40 for such covered building.

1 **§28-320.10 Fee schedule.** The department may establish by rule a schedule of fees that shall be paid
2 upon the filing of a report or an application for an adjustment to the applicable building emissions
3 limit pursuant to this article. Such schedule may include a fee for the late filing of a report.

4 **§28-320.11 Carbon trading study.** The office of long term planning and sustainability shall conduct
5 a study on the feasibility of a citywide trading scheme for greenhouse gas emissions from buildings
6 and submit a report and implementation plan with the findings of such study to the mayor and the
7 speaker of the council no later than January 1, 2021. Such study shall include methods to ensure
8 equitable investment in environmental justice communities that preserve a minimum level of benefits
9 for all covered buildings and do not result in any localized increases in pollution. Such study shall
10 also include an approach to a marketplace for credit trading, pricing mechanisms, credit verification,
11 and mechanisms for regular improvement of the scheme. Such study should also consider the reports
12 and recommendations of the advisory board.

13 **ARTICLE 321**

14 **ENERGY CONSERVATION MEASURE REQUIREMENTS FOR CERTAIN BUILDINGS**

15 **§28-321.1 Definitions.** As used in this article, the following terms shall have the following meanings:

16 **COVERED BUILDING.** The term “covered building” means a building that is (i) a rent regulated
17 accommodation, (ii) a building whose main use or dominant occupancy is classified as occupancy
18 group A-3 religious house of worship, (iii) owned by a housing development fund company organized
19 pursuant to the business corporation law and article 11 of the New York state private housing finance
20 law, or (iv) a building that participates in a project-based federal housing program and, as it appears
21 in the records of the department of finance, such building exceeds 25,000 (2322.5 m²) gross square
22 feet, or (ii) is one of two or more buildings on the same tax lot that together exceed 50,000 gross
23 square feet (4645 m²), or (iii) is one of two or more buildings held in the condominium form of
24 ownership that are governed by the same board of managers and that together exceed 50,000 gross
25 square feet (4645 m²).

26 **Exceptions:**

- 27 1. Real property, not more than three stories, consisting of a series of attached, detached or
28 semi-detached dwellings, for which ownership and the responsibility for maintenance of
29 the HVAC systems and hot water heating systems is held by each individual dwelling unit
30 owner, and with no HVAC system or hot water heating system in the series serving more
31 than 25,000 (2322.5 m²) gross square feet, as certified by a registered design professional
32 to the department.
- 33 2. An industrial facility primarily used for the generation of electric power or steam.

34 **RENT REGULATED ACCOMODATION.** The term “rent regulated accommodation” means a
35 building in which more than 35% of dwelling units are required by law or by an agreement with a
36 governmental entity to be regulated in accordance with the emergency tenant protection act of 1974,
37 the rent stabilization law of 1969, or the local emergency housing rent control act of 1962.

38 **§28-321.2 Required energy conservation measures for certain buildings.** A covered building must
39 comply with either section 28-321.2.1 or section 28-321.2.2.

1 **§28-321.2.1 Energy compliant buildings.** The owner of a covered building shall demonstrate
2 that, for calendar year 2024, the annual building emissions of such covered building did not
3 exceed what the applicable annual building emissions limit would be pursuant to section 28-
4 320.3.2 if such building were a covered building as defined in article 320 of this chapter.

5 **§28-321.2.2 Prescriptive energy conservation measures.** By December 31, 2024, the owner of
6 a covered building shall ensure that the following energy conservation measures have been
7 implemented where applicable:

- 8 1. Adjusting temperature set points for heat and hot water to reflect appropriate space
9 occupancy and facility requirements;
- 10 2. Repairing all heating system leaks;
- 11 3. Maintaining the heating system, including but not limited to ensuring that system
12 component parts are clean and in good operating condition;
- 13 4. Installing individual temperature controls or insulated radiator enclosures with
14 temperature controls on all radiators;
- 15 5. Insulating all pipes for heating and/or hot water;
- 16 6. Insulating the steam system condensate tank or water tank;
- 17 7. Installing indoor and outdoor heating system sensors and boiler controls to allow for
18 proper set-points;
- 19 8. Replacing or repairing all steam traps such that all are in working order;
- 20 9. Installing or upgrading steam system master venting at the ends of mains, large horizontal
21 pipes, and tops of risers, vertical pipes branching off a main;
- 22 10. Upgrading lighting to comply with the standards for new systems set forth in section 805
23 of the New York city energy conservation code and/or applicable standards referenced in
24 such energy code on or prior to December 31, 2024. This provision is subject to exception
25 1 in section 28-310.3, provided that July 1, 2010 is replaced by January 1, 2020 for the
26 purposes of this section;
- 27 11. Weatherizing and air sealing where appropriate, including windows and ductwork, with
28 focus on whole-building insulation;
- 29 12. Installing timers on exhaust fans; and
- 30 13. Installing radiant barriers behind all radiators.

31 **§28-321.3 Reports.** By May 1, 2025, an owner of a covered building shall submit a report to the
32 department to demonstrate compliance with this section in accordance with section 28-321.3.1 or
33 section 28-321.3.2.

34 **§28-321.3.1 Energy compliant buildings reports.** The owner of a covered building shall file
35 with the department a report, certified by a registered design professional, prepared in a form and
36 manner and containing such information as specified in rules of the department, that for calendar
37 year 2024 such building was in compliance with the applicable building emissions limit
38 established pursuant to section 28-320.3.2.

1 **§28-321.3.2 Prescriptive energy conservation measures reports.** A retro-commissioning agent,
2 as defined in article 308, shall prepare and certify a report in a form and manner determined by
3 the department. The report shall include such information relating to the completion of the
4 prescriptive energy conservation measures as shall be set forth in the rules of the department
5 including, at a minimum:

6 1. Project and team information:

7 1.1. Building address.

8 1.2. Experience and certification of persons performing the prescriptive energy
9 conservation measures and any staff involved in the project.

10 1.3. Name, affiliation, and contact information for persons performing the prescriptive
11 energy conservation measures, owner of building, and facility manager of building.

12 2. Building information:

13 2.1. List of all HVAC, domestic hot water, electrical equipment, lighting, and
14 conveyance equipment types serving the covered building.

15 **ARTICLE 322**

16 **MAINTENANCE AND REMOVAL OF LARGE WIND TURBINES**

17 **§28-322.1 Maintenance.** The owner of a large wind turbine or large wind turbine tower, as such
18 terms are defined in section 3114.2 of the New York city building code, shall maintain such turbine
19 and tower in accordance with department rules.

20 **§28-322.2 Removal.** The owner of a large wind turbine, as such term is defined in section 3114.2 of
21 the New York city building code, shall remove such turbine when (i) the time elapsed since the
22 installation of such turbine exceeds the manufacturer’s suggested useful life of such turbine or (ii)
23 such turbine has been continuously inoperable for 12 months or more, whichever occurs sooner,
24 provided that the commissioner shall by rule establish a timeframe for removing large wind turbines
25 that do not have manufacturer’s suggested useful lives.

26 **§28-322.3 Locking before hurricane or strong wind conditions.** If a hurricane or strong wind
27 conditions are expected, the commissioner may order that large turbines equipped with passive locks
28 be stopped and locked.

29 **§28-322.4 Lighting.** A large wind turbine shall not be artificially lighted.

30 **Exception:** Lighting that is required by this code or other applicable laws or rules, provided that
31 such lighting is shielded in accordance with rules promulgated by the commissioner.

32 **ARTICLE 323**

33 **PERIODIC INSPECTION OF PARKING STRUCTURES**

34 **§28-323.1 General.** Parking structures shall be maintained in a safe condition. The owner shall be
35 responsible for the proper inspection, repair, and maintenance of the parking structure in accordance
36 with the requirements set forth in this article.

37 **Exceptions:** The requirements imposed by this article shall not apply to:

- 1 1. Unenclosed, unattached outdoor parking lots.
- 2 2. Private garages serving one- and two-family homes as defined in chapter 2 of the New
- 3 York city building code.

4 **§28-323.2 Definitions.** As used in this article, the following terms shall have the following meanings:

5 **ANNUAL OBSERVATION CHECKLIST.** A document developed by the approved agency during

6 initial condition assessment containing baseline items to be inspected between condition assessments,

7 annually or at more frequent intervals as prescribed by the approved agency, by or on behalf of the

8 parking structure owner .

9 **CONDITION ASSESSMENT.** An on-site inspection and evaluation of a parking structure by an

10 approved agency for evidence of deterioration of any structural element or building component of

11 such parking structure, evidence of the existence of any unsafe structural condition in such parking

12 structure, or evidence indicating that such parking structure is so damaged, decayed, dilapidated, or

13 structurally unsafe, or is of such faulty construction or unstable foundation, that partial or complete

14 collapse is possible.

15 **INITIAL CONDITION ASSESSMENT.** The first condition assessment conducted by an approved

16 agency of a parking structure as outlined in the rules of the department.

17 **PARKING STRUCTURE.** A building or space used for the parking or storage of motor vehicles,

18 other than an automotive service station, automotive repair shop, or private garage as defined in

19 chapter 2 of the New York city building code.

20 **§28-323.3 Condition assessment.** A condition assessment of a parking structure shall be conducted

21 at periodic intervals as set forth by rule of the commissioner, provided that such condition assessment

22 shall be conducted at least once every six years and after each notification of an unsafe condition. All

23 condition assessments shall be conducted on behalf of the building owner by an approved agency.

24 **§28-323.3.1 Initial condition assessment.** The initial condition assessment for a new parking

25 structure shall be conducted in the second year following the completion of a parking structure or

26 as otherwise prescribed by rule as evidenced by the issuance date of a temporary or final certificate

27 of occupancy. Existing parking structures shall have an initial condition assessment performed by

28 an approved agency as required herein and by rule. During the initial condition assessment, the

29 approved agency shall develop and provide to the parking structure owner or owner’s authorized

30 agent an annual observation checklist containing minimum requirements and elements to be

31 inspected as part of the required annual observation.

32 **§28-323.3.2 Subsequent condition assessments.** Condition assessments shall be conducted at

33 intervals specified in the rules of the department. Condition assessments shall include a complete

34 review of the most recently prepared condition assessment report, owner’s annual inspection

35 checklists since the last condition assessment, inspection of structural elements, and a structural

36 assessment conducted in accordance with rules promulgated by the commissioner.

37 **§28-323.4 Annual parking structure observation.** An annual observation shall be performed by the

38 parking structure owner or owner’s authorized agent at intervals specified in the annual observation

39 checklist, but not less than once a year after the owner receives the most recent condition assessment

1 report. The observation shall include, at a minimum, observation of the items included on the annual
2 observation checklist provided or verified by the approved agency during the most recent condition
3 assessment. Copies of all annual observation checklists completed since the last condition assessment
4 shall be maintained at the parking structure.

5 **§28-323.5 Report of condition assessment.** A report shall be issued by the approved agency
6 following each condition assessment in accordance with sections 28-323.5.1 and 28-323.5.2.

7 **§28-323.5.1 Contents.** The report shall indicate the results of the condition assessment as safe,
8 safe with repair and/or engineering monitoring, or unsafe, as prescribed by the rules of the
9 department. It shall include a record of all potentially unsafe conditions of the structure and the
10 condition of structural framing members, any visible reinforcement, connections, and conditions
11 of slabs and slab joints. The report must also contain the annual observation checklist to be used
12 for subsequent annual parking structure observations. Such report must be signed and sealed by a
13 professional engineer, who must file the report.

14 **§28-323.5.2 Submission deadlines.** Except as otherwise provided in section 28-323.7, the
15 approved agency shall submit a written report to the commissioner within 60 days of completing
16 the condition assessment, but not more than six years from the submission of the preceding report
17 of condition assessment, certifying the results of the assessment as described in section 28-
18 323.5.1.

19 **§28-323.6 Fees.** Every owner of a parking structure subject to condition assessments shall pay to the
20 department a report filing fee for each report of condition assessment in the amount set forth in the
21 rules of the department.

22 **§28-323.7 Immediate notice of unsafe condition.** The department must be notified of an unsafe
23 condition immediately. A compliance report shall be filed after each unsafe notification.

24 1. Whenever a representative of an approved agency learns of an unsafe condition through a
25 condition assessment of a parking structure, such representative shall notify the owner and the
26 department immediately.

27 2. Whenever an owner or an owner's authorized agent observes an unsafe condition during
28 annual observations, or at any other time in between assessments, the owner shall notify the
29 department immediately and undertake repairs in accordance with section 28-323.8.

30 **§28-323.8 Repair of parking structure, unsafe condition.** Upon the notification to the department
31 of an unsafe condition, the owner or the owner's authorized agent shall immediately secure public
32 safety by removing the unsafe condition or safeguarding the area. The owner shall then engage an
33 approved agency to conduct a condition assessment and file a compliance report.

34 1. The owner shall commence repairs, reinforcements or other measures to make the structural
35 elements of the parking structure conform to the provisions of this code.

36 2. All unsafe conditions shall be corrected within 90 days of filing of the condition assessment
37 report.

1 3. The approved agency shall reinspect the premises and file an amended report within two
2 weeks after the repairs have been completed certifying that the unsafe conditions of the
3 building have been corrected.

4 4. The commissioner may grant an extension of time of up to 90 days to complete the repairs
5 required to correct an unsafe condition upon receipt and review of an initial extension
6 application submitted by the approved agency together with such additional documentation as
7 may be prescribed by rule.

8 5. The commissioner may grant further extensions of time to complete the repairs required to
9 remove an unsafe condition upon receipt and review of an application for a further extension
10 submitted by the approved agency together with such further documentation as may be
11 prescribed by rule.

12 **§28-323.9 Safe with repair and/or engineering monitoring.** A parking structure or any part thereof
13 that may pose a potential danger to persons or property, but does not require immediate action shall
14 be rated safe with repair and/or engineering monitoring. This condition requires further investigation
15 and timely remedial action to prevent its deterioration into an unsafe condition. A registered design
16 professional shall be responsible for appropriately monitoring the structure until the repair is
17 completed.

18 **§28-323.9.1 Safe with repair and/or engineering monitoring assessment requirements.** When
19 the results of an initial assessment indicate a parking structure is safe with repair and/or
20 engineering monitoring, the parking structure shall be subsequently assessed no more than three
21 years from the date of the initial assessment and an amended report filed with the department.

22 **§28-323.9.2 Safe with repair and/or engineering monitoring for two cycles.** The approved
23 agency shall not file a report of a safe condition with repair and/or engineering monitoring
24 program for the same parking structure for two consecutive filing periods unless the second such
25 report is accompanied by his or her professional certification attesting to the correction of all
26 conditions identified in the prior report as requiring repair.

27 **ARTICLE 324**
28 **PERIODIC INSPECTIONS OF DRY FLOODPROOFING**

29 **28-324.1 General.** This article shall apply to covered buildings and structures as described in 28-
30 324.1.1 of this code permitted on or after the effective date of the local law that added this article that
31 are required to comply with the dry floodproofing requirements of appendix G of the New York city
32 building code and that require human intervention to activate or implement the dry floodproofing
33 systems prior to a flood event.

34 **§28-324.1.1 Covered buildings and structures.** Such buildings or structures include:

35 1. new construction;

36 2. substantial improvements;

37 3. such portions of buildings or structures that are horizontal enlargements.

1 §28-324.1.2 Covered dry floodproofing systems. Covered dry floodproofing systems include
2 any dry floodproofing system where human intervention is required to implement any measure,
3 including the installation of shields, equipment, temporary stairs and platforms, hardware,
4 signage, fixed flood-resistant glazing systems or similar components necessary to activate and
5 implement the dry floodproofing system.

6 §28-324.2 Annual inspection of covered dry floodproofing system. An annual inspection of
7 the covered dry floodproofing system shall be conducted by a person designated by the building
8 owner.

9 §28-324.2.1 Scope of annual inspection. The annual inspection shall include, at a minimum,
10 visual confirmation that all covered systems are in their stored locations and ready for
11 deployment, and that any gaskets do not appear damaged or brittle.

12 §28-324.2.2 Records. Such inspection shall be documented and such documentation shall be
13 maintained on the premises and provided to the department upon request.

14 §28-324.3 Triennial full-scale deployment inspection. A full-scale deployment inspection
15 initiated by the owner shall be conducted every three years in the presence of a special inspection
16 agency that is qualified to perform flood zone compliance special inspections.

17 §28-324.3.1 Scope of inspection. The special inspector shall observe, inspect and document
18 the components in their deployed state. Any defects shall be noted. The special inspector shall
19 also review all annual inspection documentation for the preceding three years to confirm its
20 completeness.

21 §28-324.3.2 Notification. Prior to the triennial full-scale deployment inspection, the owner
22 shall notify the department and the fire department in accordance with procedures established
23 by the department. Such notification shall not relieve the applicant, owner, engineer, architect
24 or contractor of the obligation to comply with any notification or permitting requirement of the
25 New York city department of transportation or the New York state department of transportation.

26 §28-324.3.3 Reports. The owner shall submit a written report prepared and certified by the
27 special inspection agency that witnessed the deployment required by section 28-324.3 to the
28 commissioner within 60 days of completing such deployment. The report shall clearly document
29 the condition of the dry floodproofing system and related egress components and appurtenances
30 thereof and shall include a record of all defects, including any significant deterioration, unsafe
31 conditions and missing or defective components and outline any corrective action necessary to
32 address such defects. Such report shall be submitted to the department on such forms and in
33 such manner as required by the commissioner.

34 §28-324.3.4 Repair. All defects as found in such inspection shall be documented, noted in
35 inspection reports, and corrected. Where missing or incomplete annual inspection records are the
36 defect in question the owner shall provide a narrative of steps taken to ensure future records will
37 be compliant. An affirmation of correction shall be filed by the owner within 60 days of the date
38 of correction.

1 §28-324.3.5 Fees. A report filing fee shall be paid to the department in the amount prescribed
2 by rule.

3 **ARTICLE 325**
4 **ANNUAL INSPECTIONS TO PREVENT CONTAMINATION OF MECHANICAL**
5 **SYSTEMS**

6 §28-325.1 General. This article shall apply to buildings with exhaust ducts under positive pressure,
7 chimneys, and vents that extend into or pass through ducts or plenums.

8 §28-325.1.1 Covered buildings and structures. Such buildings or structures include:

- 9 1. Buildings constructed after the effective date of this article;
10 2. Alterations to existing buildings performed after the effective date of this article resulting
11 in a plenum penetration by a chimney or vent serving an appliance with a heat input not
12 greater than 350,000 Btu/hr.

13 §28-325.2 Annual inspection of covered buildings. An annual inspection of the covered
14 building mechanical systems shall be conducted to ensure no contamination exists. Such
15 inspection shall be conducted by a person designated by the building owner who meets the
16 qualifications established by the commissioner.

17 §28-325.2.1 Scope of annual inspection. The annual inspection shall include, at a minimum,
18 visual confirmation that joints, seams and connections of covered mechanical systems are
19 securely fastened and sealed with welds, gaskets, mastics (adhesives), mastic-plus-embedded-
20 fabric systems, liquid sealants or tapes.

21 §28-325.2.2 Records. Such inspection shall be documented and such documentation shall be
22 maintained on the premises for at least six years and provided to the department upon request.

23 § 4. Chapter 4 of title 28 of the administrative code of the city of New York, as added
24 by local law number 33 for the year 2007, articles 404, 405, 412, 413, 414, 415 and 416 as amended
25 by and articles 421 and 422 as added by local law number 141 for the year 2013 and amended by
26 chapter 750 for the year 2019; the definitions of “direct and continuing supervision” and “seal” in
27 section 28-401.3 as amended by local law number 141 for the year 2013, the definition of “elevator
28 agency” as added by chapter 750 for the year 2019, the definitions of “elevator agency helper” and
29 “elevator work” as added by chapter 750 for the year 2019 and amended by subpart O of chapter 55
30 for the year 2020, the definition of “general contractor” in such section as added by local law number
31 8 for the year 2008 and the definition of “safety registration recipient” in such section as added by
32 local law number 8 for the year 2009; section 28-401.4, 28-401.6, 28-401.7, 28-401.8 28-401.9, 28-
33 401.13, 28-401.15, 28-401.17, 28-401.19, 28-402.2, 28-403.2, 28-406.3, 28-407.3, 28-408.3, 28-
34 408.4, 28-408.6, 28-410.4, 28-410.5, 28-410.6, 28-410.8, 28-417.1, 28-418.2, as amended by and 28-
35 401.22 as added by local law number 141 for the year 2013; section 28-418.4, 28-418.5 and articles
36 419 and 420 as added by local law number 8 for the year 2008, article 423 as added by local law
37 number 150 for the year 2016, article 424 as added by local law number 14 for the year 2018, and
38 article 425 as added by chapter 750 for the year 2019 and amended by subpart O of chapter 55 for the
39 year 2020 , article 426 as added by chapter 750 for the year 2019, and article 427 as added by chapter

1 750 for the year 2019 and amended by subpart O of chapter 55 for the year 2020, is amended to read
2 as follows:

3 **CHAPTER 4**

4 **LICENSING AND REGISTRATION OF BUSINESSES, TRADES AND**
5 **OCCUPATIONS ENGAGED IN BUILDING WORK**

6 **ARTICLE 401**
7 **GENERAL**

8 **§28-401.1 Application.** This chapter shall apply to the licensing and registration of businesses,
9 trades and occupations engaged in building work regulated by this code.

10 **§28-401.2 General requirements for all licenses.** The provisions of this article shall apply to all
11 licenses issued by the department pursuant to this chapter. All applicants and licensees shall comply
12 with the provisions of this article as well as the specific requirements applicable to the particular
13 license as set forth in other articles of this chapter and department rules.

14 **§28-401.3 Definitions.** As used in this chapter, the following terms shall have the following
15 meanings unless the context or subject matter requires otherwise.

16 **BOILER, HIGH-PRESSURE.** An appliance for supplying steam or hot water that, for a steam
17 boiler, operates at a pressure of more than 15 psig (103 kPa gauge), and for a hot water boiler,
18 operates at a pressure exceeding 160 psig (1103 kPa gauge) or at a temperature exceeding 250°F
19 (121°C).

20 **CERTIFICATE OF COMPETENCE.** A certificate issued by the department to an individual
21 representing that such individual has completed all requirements for the master plumber or master
22 fire suppression piping contractor license but has not obtained a seal [~~or plate~~] and that such
23 certificate of competence has been renewed as required and is currently in effect. The certificate of
24 competence shall bear the name of the holder and the certificate number. The holder of a certificate
25 of competence is not a licensed master plumber or licensed master fire suppression piping contractor
26 and may practice the trade for which the certificate is issued only under the direct and continuing
27 supervision of a licensed master plumber or licensed master fire suppression piping contractor or,
28 with respect to a city employee under the direct and continuing supervision of a supervising licensed
29 master plumber or licensed master fire suppression piping contractor.

30 **CITY AGENCY.** A city, county, borough, or other office, position, administration, department,
31 division, bureau, board or commission, or a corporation, institution or agency of government, the
32 expenses of which are paid, in whole or in part, from the city treasury.

33 **COMBINED STANDPIPE SYSTEM.** A standpipe to which a sprinkler system is connected or is
34 being connected.

35 **DIRECT AND CONTINUING SUPERVISION.** Responsible control exercised by a licensed
36 individual, either personally or through one or more, but no more than three, levels of competent
37 supervision over individuals performing the actual work of the [~~licensees~~] licensee's trade who are

1 (i) in the direct employ of an individual who is a licensee, or (ii) in the direct employ of the city
2 agency employing the licensee or (iii) in the direct employ of a business employing the licensee, as
3 allowed by the department, or (iv) where the licensee uses his or her license on behalf of a business,
4 in the direct employ of such business provided that such business is disclosed to the department
5 pursuant to this chapter. Such control shall be evidenced by such licensee’s signature, and seal where
6 applicable, upon any required statements, applications and/or permits and by demonstrating
7 involvement of the licensee in the operations of the business, including hiring of employees,
8 responsibility for financial matters, and oversight of work performance. Direct and continuing
9 supervision includes field inspection, supervision of job sites, and the maintenance of records of
10 such supervision and such other requirements as the commissioner may prescribe by rule for a
11 particular license type.

12 **DIRECT EMPLOY.** An individual is in the direct employ of a licensee or business or a city agency
13 when such individual is on the payroll of such licensee or business or city agency and under the
14 usual common law rules applicable in determining the employer-employee relationship has the status
15 of an employee. The work performed by such employee shall not exceed the class of license held by
16 the licensee. Direct employment shall be evidenced by payroll records, such as social security
17 payments, income tax withholding or the disbursement of other funds as required by law for the
18 benefit of such employee, timekeeping records, such as time cards and sign-in sheets, work orders,
19 and assignment or route logs.

20 **DIRECT SUPERVISION.** Responsible control exercised by a licensed individual over individuals
21 performing the actual work of the licensee’s trade. Such control shall be evidenced by such licensee’s
22 signature, and seal where applicable, upon any required statements, applications and/or permits.
23 Direct supervision includes field inspection, supervision of job sites, and the maintenance of records
24 of such supervision and such other requirements as the commissioner may prescribe by rule for a
25 particular license type. All work shall be performed under the guidance and direction of the licensed
26 individual, or, for gas work, a person who holds a gas work qualification pursuant to article 423, who
27 shall be present at all times such trade work is conducted.

28 **ELEVATOR AGENCY.** An approved agency authorized by the commissioner to perform
29 elevator work and to inspect and test elevators, escalators and other conveying equipment
30 regulated by this code.

31 **ELEVATOR AGENCY HELPER.** An individual having required qualifications to perform
32 elevator work, as defined in this chapter, under the direct and continuing supervision of an
33 elevator agency director.

34 **ELEVATOR WORK.** Alteration, assembly, installation, maintenance, repair, replacement and
35 modernization work, as defined by ASME A17.1 as modified by appendix K of the New York
36 city building code, performed on conveyances regulated by this code or other applicable laws or
37 rules. Elevator work does not include material hoists, platform lifts, stair chair lifts, or personnel
38 hoists. Outfitting, removal, refinishing, or replacement of interior finishes, including wall panels,
39 drop ceilings, handrails and flooring, removal or replacement of interior lighting, recladding of
40 doors, transoms and front return panels, finishing or ornamental work on elevator car operating
41 panels shall not be considered elevator work. Operation of an elevator by any person employed
42 as an operator of such elevator, including operation of an elevator operating under a temporary

1 certificate of occupancy as issued by the department of buildings or such other issuing agency
2 shall not be considered elevator work.

3 **FIRE SUPPRESSION PIPING SYSTEM.** Any system including any and all equipment and
4 materials in connection therewith, [~~with the exception of any electrical components that must be~~
5 ~~installed by a licensed electrician pursuant to the New York city electrical code,~~] the purpose of
6 which is to control, contain, suppress or extinguish fire and shall include:

- 7 1. The systems, materials and equipment described or referred to in this code [~~(with the~~
8 ~~exception of any electrical components that must be installed by a licensed electrician~~
9 ~~pursuant to the New York city electrical code)~~] which [systems, materials or equipment] shall
10 include any standpipe system to which a sprinkler system is or is now being connected;
11 [provided, however, that such systems, materials or equipment shall not include any systems,
12 materials or equipment constituting plumbing work, with the exception of up to thirty
13 sprinkler heads off the domestic water in any one building;] or
- 14 2. Up to 30 sprinkler heads off the domestic water in any one building; or
- 15 3. Any dry, liquid or gaseous chemical fire containment, suppression, control or extinguishing
16 system or any other device or means of control, suppression, containment or extinguishing
17 of fire [~~(with the exception of any electrical components that must be installed by a licensed~~
18 ~~electrician pursuant to the New York city electrical code) but not including portable fire~~
19 ~~extinguishers].~~

20 Fire suppression piping systems shall not include:

- 21 1. Any electrical components that must be installed by a licensed electrician pursuant to
22 the New York city electrical code; or
- 23 2. Portable fire extinguishers; or
- 24 3. Connection to domestic water being used for sprinklers.

25 **FIRE SUPPRESSION PIPING WORK.** The installation, maintenance, repair, modification,
26 extension, or alteration or testing of a fire suppression piping system in any building in the city of
27 New York. Fire suppression piping work shall not include plumbing work.

28 **GENERAL CONTRACTOR.** An individual, corporation, partnership or other business entity that
29 applies for a permit pursuant to this code to construct a new residential structure containing no more
30 than three dwelling units. The term “general contractor” shall not be construed to include an
31 individual, corporation, partnership or other business entity that holds a license pursuant to this code
32 or subchapter twenty-two of chapter two of title twenty of the administrative code, and enters into a
33 contract to perform work exclusively within the scope of such license, nor shall it include an
34 individual who constructs a residential structure containing no more than three dwelling units for his
35 or her own occupancy, or any subcontractors working for the general contractor.

36 **GOVERNMENT AGENCY.** Any office, position, administration, department, division, bureau,
37 board, commission, corporation, institution or agency under the control of any city, county, state or
38 the federal government of the United States of America.

1 ~~**HIGH-PRESSURE BOILER.** A boiler that carries a pressure of more than fifteen pounds of steam~~
2 ~~per square inch and is rated in excess of ten horsepower, or that produces over a pressure of one~~
3 ~~hundred sixty pounds per square inch or at a temperature over 250°F (121°C).]~~

4 **LICENSE.** A license, registration, certification or other evidence, issued by the department
5 pursuant to this chapter, representing that an individual, a sole proprietorship, partnership,
6 corporation, business association or other person meets the qualifications and requirements as set
7 out in this chapter and in the rules of the department and is authorized to engage in the particular
8 trade, occupation or business as indicated on the license and representing that such license, with
9 associated [~~plate and/or~~] seal, where applicable, has been renewed as required and is currently in
10 effect. The license shall bear the holder's full name, the type of license, the license class, where
11 applicable, the license number and any restrictions relating to the use of such license. Such term
12 shall not include a certificate of competence.

13 ~~**LICENSE BOARD OR BOARD.** A panel of trade practitioners and others appointed by the~~
14 ~~commissioner as provided herein and in rules promulgated by the commissioner with the purpose of~~
15 ~~advising the commissioner regarding the character and fitness of applicants for a license or certificate~~
16 ~~of competence, allegations of illegal practices by persons licensed, or other matters as the~~
17 ~~commissioner may see fit.]~~

18 **LICENSED MASTER FIRE SUPPRESSION PIPING CONTRACTOR, MASTER FIRE**
19 **SUPPRESSION PIPING CONTRACTOR.** An individual who has satisfied the requirements of
20 this chapter for the master fire suppression piping contractor license, who has been issued a license
21 [~~plate~~] and [~~or~~] seal, and who is authorized under the provisions of this chapter to perform fire
22 suppression piping work in the city of New York, according to the classification of license held. A
23 master fire suppression piping contractor licensee shall practice his or her trade in association with
24 a master fire suppression piping contractor business or as an employee of a city agency.

25 **LICENSED MASTER PLUMBER, MASTER PLUMBER.** An individual who has
26 satisfied the requirements of this chapter for the master plumber license, who has been issued a
27 license [~~plate~~] and [~~or~~] seal, and who is authorized under the provisions of this chapter to perform
28 plumbing work in the city of New York. A master plumber licensee shall practice his or her trade in
29 association with a master plumber business or as an employee of a city agency.

30 ~~**PLATE.** A plaque issued by the department to a master plumber or a master fire suppression piping~~
31 ~~contractor setting forth the licensee's name and number, the class of license and the master plumber~~
32 ~~business or master fire suppression piping contractor business operating pursuant to the plate, and~~
33 ~~displayed prominently and conspicuously on view to the public at the place of business registered~~
34 ~~with the department. The plate is the property of the department and is not transferable by the~~
35 ~~licensee.]~~

36 **PLUMBING WORK.** The installation, maintenance, repair, modification, extension or alteration
37 of plumbing, standpipe where a sprinkler is not connected or is not now being connected, domestic
38 water, connections to the domestic water, combination domestic water and reserve standpipe supply
39 tank up to and including the roof tank check valve, gas piping or any piping system referred to in the
40 New York city plumbing code, and/or up to thirty sprinkler heads off the domestic water in any
41 building in the city of New York.

1 ~~[PRIVATE ELEVATOR INSPECTION AGENCY. An approved agency authorized by the~~
2 ~~commissioner to operate as an independent contractor for the purpose of inspecting and testing~~
3 ~~elevators, escalators and other conveying equipment regulated by this code and shall include but~~
4 ~~shall not be limited to an insurance company, elevator maintenance company, elevator manufacturer~~
5 ~~or elevator inspection company.]~~

6 **SAFETY REGISTRATION RECIPIENT.** An individual, corporation, partnership or other
7 business entity that applies for a permit to perform or performs, or supervises any work that requires
8 the filing under this code of an application for (i) a new building permit; (ii) an alteration permit for
9 work that involves a vertical or horizontal enlargement in excess of twenty-five percent of the floor
10 area of an existing building; (iii) an alteration permit for work that involves the addition of three or
11 more stories to an existing building; (iv) an alteration permit for work that involves alteration or
12 demolition of more than fifty percent of the floor area of an existing building; (v) an alteration permit
13 where the work will result in the removal of one or more floors of an existing structure; (vi) a
14 demolition permit; or (vii) an individual, corporation, partnership or other business entity that places
15 concrete in a building or building site in connection with excavations, foundations or superstructures,
16 including but not limited to the placement of concrete in steel structures, where the concrete portion
17 of the project involves the pouring of a minimum of two thousand cubic yards of concrete or such
18 other amount as determined by rule.

19 **SEAL.** Emblem issued by the department to a licensee that allows the licensee to stamp documents
20 required by this code to be signed and sealed. The seal shall bear the full name of the licensee, the
21 license type, the license class, where applicable, and the license number. The seal is the property of
22 the department and is not transferable by the licensee. For applications and other documents
23 submitted electronically, the digital signature and imprint of the seal may be submitted in a manner
24 authorized by the commissioner.

25 **SIGN.** A sign as defined in section 12-10 of the New York city zoning resolution.

26 ~~[TOTAL BOOM. A boom including jibs and other extensions.]~~

27 **§28-401.4 Requirement of license.** It shall be unlawful for any person to engage in or carry on in
28 the city any business, trade or occupation regulated by this chapter or to hold himself or herself out
29 as authorized to engage in or carry on such activity, without having first obtained a license from the
30 commissioner and, if applicable, the proper endorsement for such license in accordance with and
31 subject to the provisions of this chapter and the rules of the department. ~~[A license issued by the~~
32 ~~department for any such business, trade or occupation prior to July 1, 2008 shall remain in full force~~
33 ~~and effect until the expiration or termination thereof in accordance with the terms thereof, unless~~
34 ~~sooner revoked or suspended for cause as hereinafter provided. Any renewal of such license shall be~~
35 ~~in accordance with the provisions of this code.]~~

36 **§28-401.5 Application and conditions.** Every application for a license or certificate of competence
37 shall be made in such form and shall be accompanied by such information as the commissioner may
38 prescribe, and by the required fee. Failure to provide all requested documents in a timely manner
39 will constitute an incomplete application and will result in denial of the license. It is a condition of
40 the license or certificate of competence that information in the application be kept correct and
41 current. Any change in required information shall be reported to the department within ~~[fourteen]~~ 14

1 days after any change prior to issuance of the license or certificate of competence or within [~~thirty~~
2 30 days after any change following issuance.

3 **§28-401.6 Qualifications of applicant.** All applicants for a license or certificate of competence shall
4 be at least 18 years of age, shall be able to read and write the English language, shall be of good
5 moral character, shall be fit to perform work authorized by the particular license or certificate of
6 competence, and shall meet additional qualifications that may be prescribed for the particular license
7 or certificate of competence. The department may refuse to qualify an applicant if it has found that
8 the applicant violated any law, rule, or regulation of the department resulting in the suspension [~~or~~
9 revocation or non-renewal of a department-issued license.

10 **§28-401.7 Examination of applicant.** Except as otherwise specified for the particular license type,
11 applicants for a license shall be required to take an examination in accordance with the rules of the
12 department. [~~Every applicant shall commence the license application process with the department~~
13 ~~within one year of passing the examination for licensure and shall furnish to the department a~~
14 ~~completed license application within one year of submission of the first filing. Failure to provide all~~
15 ~~requested documents in a timely manner will constitute an incomplete application and will result in~~
16 ~~denial of the license.]~~

17 **§28-401.8 Investigation of applicant.** Every applicant for a license or certificate of competence
18 issued pursuant to this chapter shall submit to investigation as directed by a governmental entity in
19 order to determine the applicant's character and fitness and in accordance with the rules of the
20 department. The applicant shall furnish the department with payment for the actual cost of
21 conducting the background investigation. Failure to provide all requested and completed documents
22 or any other information necessary for completion of the investigation in a timely fashion will
23 constitute an incomplete application and will result in a denial of the license or certificate of
24 competence.

25 **§28-401.8.1 Fingerprinting.** Applicants for licenses issued pursuant to this chapter shall be
26 fingerprinted for the purpose of securing criminal history records from the state division of
27 criminal justice services.

28 1. The applicant shall pay a processing fee as required and in a form and manner as
29 prescribed by the state division of criminal justice services. Fingerprints shall be taken of
30 the individual seeking licensure in the form and manner as prescribed by the division of
31 criminal justice services; the owner, if the applicant is a sole proprietorship; the general
32 partners, if the applicant is a partnership; and the officers, principals, directors, and
33 stockholders owning more than 10 percent of the outstanding stock of the corporation, if
34 the applicant is a corporation.

35 2. Any person required to be fingerprinted hereunder shall furnish to the department three
36 current passport-sized photographs of such person.

37 3. Notwithstanding paragraph (1) above, an applicant may submit, in lieu of such
38 fingerprints, copies of submissions to any federal, state or local regulatory entity
39 containing information comparable to that required by the department, provided that the
40 department may require fingerprinting and disclosure pursuant to such paragraph where it
41 finds that it has not received sufficient information or information that is comparable to
42 department requirements.

- 1 4. Any person authorized by the department to request a check of criminal history
2 information shall comply with the provisions of article 23a of the New York state
3 correction law and all other applicable laws. If an applicant has been convicted of a crime,
4 any decision regarding such applicant's fitness for a license or certificate of competence
5 issued pursuant to this chapter must be made upon consideration of sections 701-703-b
6 (article 23) and sections 751-753 (article 23-a) of the New York state correction law.
- 7 5. The department shall authorize the director of the licensing backgrounds unit and a
8 licensing unit attorney to review the criminal history record information disseminated by
9 the division.

10 **§28-401.9 Insurance.** Except as noted otherwise for a particular license, or exempted by the
11 commissioner pursuant to rule, prior to the issuance of a license, or during the renewal thereof, the
12 applicant shall file with the department satisfactory evidence of a commercial general liability
13 insurance policy in the amount of [~~one million dollars~~] \$1,000,000 or such other amount as the
14 commissioner may require, together with satisfactory evidence of compliance with the workers'
15 compensation law and the disability benefits law. Required insurance shall be maintained for the
16 duration of the license and any changes in coverage, insurance renewals, or policy status shall be
17 provided to the department in accordance with department rules.

18 **§28-401.10 Issuance of license [~~,-plate~~] and [~~/or~~] seal, where applicable, or certificate of**
19 **competence.** The commissioner shall issue a license or certificate of competence to each applicant
20 who shall have submitted satisfactory evidence of his or her qualifications, and shall have
21 satisfactorily passed all required examinations and investigations, provided that no license or
22 certificate of competence shall be issued unless and until the applicant shall have paid the required
23 fee and complied with such other and further requirements for the particular license or certificate of
24 competence as may be set forth in this chapter and in rules promulgated by the department. All
25 licenses or certificates of competence issued by the commissioner shall have his or her signature
26 affixed thereto; but the commissioner may authorize any subordinate to affix such signature. For
27 licenses that require [~~a plate and/or~~] the application of a seal, the [~~plate and/or~~] seal shall be issued
28 with the license except as provided otherwise in this chapter. The license [~~,-plate~~] and seal are the
29 property of the department and are not transferable by the licensee. No licensee shall make or cause
30 to be made duplicates of a department-issued license [~~,-plate~~] or seal. The loss or theft of a license [~~,-~~
31 ~~plate~~] or seal must be reported to the department within five calendar days.

32 **§28-401.11 Term of license.** [~~All~~] Except as otherwise provided in this code or by rule, all licenses
33 issued by the commissioner [~~for which an examination is required~~] shall expire three (3) years from
34 the date of issuance thereof, and may be renewed every three (3) years thereafter without
35 examination. The commissioner shall have authority to stagger the issuance of licenses for three-
36 year terms. [~~All licenses not requiring examination shall expire one year from the date of issuance~~
37 ~~thereof, and may be renewed each year thereafter except as otherwise noted for a specific license.]~~
38 The term of an elevator agency technician license issued in accordance with the provisions of article
39 425 of this chapter shall be two (2) years.

40 **§28-401.12 Renewal of license or certificate of competence.** Applications for renewal of a license
41 or certificate of competence shall be accompanied by the renewal fee and such additional information
42 as the commissioner may require, and shall be made at least 30 [~~calendar~~] days but not more than 60
43 [~~calendar~~] days prior to the expiration date of same. Applications for renewal of a license or
44 certificate of competence submitted within 30 days prior to the license expiration date shall be

1 considered late and subject to applicable late renewal fees. Applicants shall provide evidence
2 satisfactory to the department that he or she is fit to perform the work authorized by the particular
3 license as provided by department rule. Applications for renewal are subject to investigation by the
4 department. The failure of an individual to renew his or her license or certificate of competence shall
5 have the effect of cancellation of the license or certificate of competence upon expiration, and the
6 holder of a [~~plate and/or~~] seal issued by the department shall immediately surrender such [~~plate~~
7 ~~and/or~~] seal to the department. A person who fails to renew a license or certificate of competence
8 within the time period set forth in this section [~~28-401.12~~] may apply for late renewal [~~or~~
9 ~~reinstatement~~] of such license pursuant to section 28-401.13. The department may, following notice
10 and an opportunity to be heard, refuse to renew a license or certificate of competence on any grounds
11 on the basis of which it could deny, suspend or revoke such license.

12 **§28-401.13 Late renewal [~~and reinstatement~~].** If a license or certificate of competence expires, the
13 individual may apply for late renewal of the license or certificate of competence [~~;~~] within one (1)
14 year of the date of its expiration without examination but subject to applicable late renewal fee.
15 [~~Thereafter, and up to five years after the date of expiration, the commissioner may reinstate the~~
16 ~~license or certificate of competence without examination upon the applicant's demonstration to the~~
17 ~~commissioner's satisfaction of continued competence in the respective trade and satisfaction of any~~
18 ~~applicable continuing education requirements but subject to applicable late renewal and~~
19 ~~reinstatement fees. Applicants for late renewal and reinstatement shall provide evidence satisfactory~~
20 ~~to the department that he or she is fit to perform the work authorized by the particular license as~~
21 ~~provided by department rule. A license or certificate of competence shall not be reinstated after five~~
22 ~~years from date of expiration. The department may refuse to reinstate a license or certificate of~~
23 ~~competence on any grounds on the basis of which it could deny, suspend or revoke such license.]~~

24 **§28-401.14 Continuing education.** The commissioner may promulgate rules to require applicants
25 for the renewal of licenses or certificate of competence to complete a prescribed number of hours of
26 continuing education courses approved by the department within the term preceding the application
27 for renewal and to provide proof of same in a form acceptable to the department. Such proof, when
28 required, shall be submitted with the application for renewal.

29 **§28-401.15 Schedule of fees.**

LICENSE TYPE	INITIAL FEE	RENEWAL FEE	ADDITIONAL FEES
Master rigger license.	\$200	\$150 triennially	Late-renewal fee: \$50 Reissuance fee: \$50
Special rigger license.	\$100	\$75 triennially	Late-renewal fee: \$50 Reissuance fee: \$50
Basic hoisting machine operator license (Class A).	\$150	\$150 triennially	Late-renewal fee: \$50 Reissuance fee: \$50
Basic hoisting machine operator license with endorsement to operate hoisting machinery without limitation or restriction	\$200	\$150 triennially	Late-renewal fee: \$50 Reissuance fee: \$50
Special hoisting machine operator license (Class C).	\$100	\$75 triennially	Late-renewal fee: \$50 Reissuance fee: \$50
Lift director registration	As provided by dept rules.	As provided by dept rules.	As provided by dept rules.
Concrete testing laboratory license.	\$100	\$75 annually	Late-renewal fee: \$50 Reissuance fee: \$50
Welder license.	\$50	\$45 triennially	Late-renewal fee: \$50 Reissuance fee: \$50
Master plumber license (certificate of competence).	\$200	\$150 triennially	Late-renewal fees: Up to 30 days late, \$50; From 31 days to five years late, \$100 for each year or part thereof. Reissuance fee: \$50
[Master plumber license plate.]	[\$75]	[\$100 triennially]	[Replacement fee upon loss of plate, w/affidavit: \$100]
Master plumber license seal.	\$50	\$75 triennially	Replacement fee upon loss of seal, w/affidavit: \$75
Journeyman plumber registration.	\$50		No renewal [no reissuance]. Reissuance fee: \$50
Master fire suppression piping contractor (class A, B or C) license (certificate of competence).	\$200	\$150 triennially	Late-renewal fees: Up to 30 days late, \$50; From 31 days to five years late, \$100 for each year or part thereof. Reissuance fee: \$50

[Master fire suppression piping contractor (class A, B or C) license plate.]	[\$75]	[\$100 triennially]	[Replacement fee upon loss of plate, w/affidavit: \$100]
Master fire suppression piping contractor (class A, B or C) license seal.	\$50	\$75 triennially	Replacement fee upon loss of seal, w/affidavit: \$75
Journeyman fire suppression piping installer registration.	\$50		No renewal [no reissuance]. Reissuance fee: \$50
Oil-burning equipment installer. License [(class A or B)].	\$100	\$75 triennially	Late-renewal fee: \$50 Reissuance fee: \$50
<u>Oil-burning equipment installer seal.</u>	<u>\$100</u>	<u>\$75 triennially</u>	<u>Replacement fee upon loss of seal, w/affidavit: \$75</u>
High-pressure boiler operating engineer license.	\$50	\$45 triennially	Late-renewal fee: \$50 Reissuance fee: \$50
Portable high-pressure boiler operating engineer license.	\$50	\$45 triennially	Renewal fee includes renewal fee for a hoisting machine operator license. Late-renewal fee: \$50
Master sign hanger license.	\$100	\$75 triennially	Late-renewal fee: \$50 Reissuance fee: \$50
Special sign hanger license.	\$100	\$75 triennially	Late-renewal fee \$50 Reissuance fee: \$50
Outdoor advertising company registration.	As provided by dept rules.	As provided by dept rules.	As provided by dept rules.
Filing representative registration.	As provided by dept rules.	As provided by dept rules.	As provided by dept rules.
[Reinstatement of expired license, certificate of competence or certification without examination, if approved by commissioner, in addition to	[Same as initial license.]		[\$100 for each year or part thereof from date of expiration]
Site safety coordinator certificate.	\$100	\$50	Late-renewal fee \$50 Reissuance fee: \$50
Site safety manager certificate.	\$300	\$150	Late-renewal fee \$50 Reissuance fee: \$50
General contractor registration.	\$300	\$240 triennially	Late-renewal fee \$50 Reissuance fee: \$50

Tower crane rigger license.	\$150	\$50 triennially	Late-renewal fee \$50 Reissuance fee: \$50
Safety registration [number (concrete contractor, demolition contractor, general contractor)] endorsement	\$80 each	\$80 triennially	Late-renewal fee: \$50 Reissuance fee: \$50
Lift director registration	As provided by dept rules.	As provided by dept rules.	As provided by dept rules.

1
2 **§28-401.15.1 Additional fees.** Additional fees for licensing shall be set forth in the rules of the
3 department. Additional fees include, but are not limited to, reissuance, deactivation, reactivation
4 and late renewal.

5 **§28-401.16 Restrictions on use [of license].** No holder of a license issued under this chapter shall
6 authorize, consent to or permit the use of his or her license by or on behalf of any other person, and
7 no person who has not qualified and obtained or renewed a license or qualification under this chapter
8 shall hold himself or herself out to the public as qualified, licensed, certified, registered or as the
9 holder of a license issued under this chapter, either directly or indirectly, by means of signs, sign
10 cards, [~~plates,~~] stationery, or in any other manner whatsoever.

11 **§28-401.17 Use on behalf of a business.** Except for such additional requirements as may be set forth
12 for a particular license, nothing in this chapter shall be construed to prohibit the use of a license by
13 the holder thereof for or on behalf of a partnership, corporation or other business association,
14 provided that such business entity is disclosed to the department in a manner required by the
15 department and where:

- 16 1. At least one member of the partnership or at least one officer of the corporation is licensed
17 for the same business, trade or occupation, and that all work performed by such partnership
18 or corporation is performed by or under the direct and continuing supervision of such license
19 holder or holders; or
- 20 2. Such partnership, corporation or other business association is itself authorized to engage in
21 such business as prescribed herein.

22 **§28-401.17.1 Use on behalf of a city agency.** Nothing in this chapter shall be construed to
23 prohibit the holder of a license who is an employee of a city agency from using such license to
24 practice the trade for which such license is issued for or on behalf of such city agency in the
25 course of such employment except as otherwise limited pursuant to articles 408 and 410 of this
26 chapter for licensed master plumber and licensed master fire suppression piping contractor
27 licensees.

28 **§28-401.17.2 Change of business.** A license holder who is required to register his or her business
29 or apply for permits with the department may change his or her registered business provided that
30 such change is disclosed to the department in a manner required by the department and where:

- 31 1. All business documentation required by the department, including new insurance
32 certificates, for the new business is submitted;

1 2. All open applications filed by the license holder under the previous business are closed or
2 transferred; and

3 3. All fines, penalties or fees owed to the city or department related to the work performed
4 by the previous registered business during the period the license holder was registered at
5 that business are paid.

6 **§28-401.18 New York city location required.** Except as otherwise noted for a particular license, the
7 holder of a license, other than an employee of a city agency, shall have or be employed by a business
8 entity that has an established place [øf] dedicated to the licensee’s business with an address within
9 the city of New York at which such person can be contacted by the public and the department by
10 mail, telephone, electronic mail or other modes of communication during usual business hours. A
11 post office box or virtual office is not [an] acceptable [address].

12 **§28-401.18.1 Notification required.** Licensees shall promptly notify the department in writing
13 of any address, telephone number and/or electronic mail change within 30 days of the change.
14 Licensees shall notify the department in writing of any criminal conviction within 10 days of the
15 occurrence.

16 **§28-401.18.2 Posting.** Licensees with established places of business shall post a photocopy of
17 such license in a conspicuous place near the entrance of the licensee’s place of business.

18 **§28-401.19 Suspension or revocation of license or certificate of competence.** The commissioner
19 shall have the power to suspend or revoke a license or certificate of competence and/or to impose a
20 fine not to exceed [~~twenty five thousand dollars~~] \$25,000 for each finding of violation, and/or to
21 order any holder thereof to repair damage resulting from any act or omission as set forth in this
22 chapter or in rules, for any of the following:

- 23 1. Fraud or deceit in obtaining or renewing a license [~~,plate~~] or seal, certificate of competence,
24 certification, registration, or permit;
- 25 2. The making of a material false or misleading statement on any form or report filed with the
26 department or other governmental entity;
- 27 3. The failure to file a statement, report or form required by law to be filed;
- 28 4. Willfully impeding or obstructing the filing of a statement, report or form of another required
29 by law to be filed;
- 30 5. Fraudulent dealings;
- 31 6. Negligence, incompetence, lack of knowledge or fitness, or disregard of this code and related
32 laws and rules;
- 33 7. Failure to comply with this code or any order, rule, or requirement lawfully made by the
34 commissioner including failure to cooperate with investigations related to the trade for which
35 the individual is licensed conducted by the commissioner or other government entity;

- 1 8. Failure to comply with any order, rule, regulation or requirement lawfully made by the
2 commissioner of environmental protection or commissioner of transportation pertaining to
3 water services, house connections, street openings, street/lane closures or sidewalk closures
4 that relate to requirements of this code;
- 5 9. A practice or pattern of failing timely to perform or complete contracts relating to home
6 improvements as defined by section 20-386 of the administrative code or a practice of
7 abandoning contracts on residential buildings containing four dwelling units or less;
- 8 10. Failure to provide documents, including payroll records, workers compensation or other
9 insurance documents, employee timekeeping records and corporate tax returns, required by
10 the commissioner;
- 11 11. Engaging or assisting in any act that endangers the public safety and welfare;
- 12 12. Conviction of a criminal offense where the underlying act arises out of the individual's
13 professional dealings with the city or any other governmental entity;
- 14 13. Poor moral character that adversely reflects on his or her fitness to conduct work regulated
15 by this code; [ø]
- 16 14. Failure to pay outstanding fines, penalties, or fees related to the individual's professional
17 dealings with the city or any other governmental entity [-];
- 18 15. The unauthorized removal of documents from the department;
- 19 16. Repeated failure to be prepared for or attend scheduled meetings with the department as
20 provided by rule; or
- 21 17. Failure to notify the department in accordance with section 28-401.18.1.
- 22 [~~15.~~] 18. With respect to general contractor registration, upon a finding that the applicant or
23 registrant or a business entity in which one of the applicant's or registrant's principals,
24 officers or directors is a principal, officer or director has engaged in any of the acts set forth
25 in items 1 through [~~14~~] 17 or any of the following:
- 26 [~~15.1.~~] 18.1. Fraud, misrepresentation or bribery in securing a sign-off of work or a
27 temporary or permanent certificate of occupancy.
- 28 [~~15.2.~~] 18.2. A practice on the part of the registrant of failure to timely perform or complete
29 its contracts for the construction of new residential structures containing no more than
30 three dwelling units, or the manipulation of assets or accounts, or fraud or bad faith.
- 31 [~~15.3.~~] 18.3. Approval or knowledge on the part of the registrant of an act of omission,
32 fraud, or misrepresentation committed by one or more agents or employees of the
33 registrant, and failure to report such act to the department.
- 34 [~~15.4.~~] 18.4. The applicant or registrant, or any of its principals, officers or directors, or
35 any of its stockholders owning more than ten percent of the outstanding stock of the

1 corporation has been convicted of a crime which, in accordance with article twenty-
2 three-a of the correction law, is determined to have a direct relationship to such person's
3 fitness or ability to perform any of the activities for which a registration is required
4 under this article.

5 ~~[15.5.]~~ 18.5. The applicant or registrant, or any of its principals, officers or directors has
6 been or is a principal, officer or director of a registered general contractor whose
7 registration has been revoked.

8 **§28-401.19.1 Notice and hearing.** The commissioner shall not revoke or suspend a license or
9 certificate of competence for any cause or impose any other sanction on a licensee unless and
10 until the holder has been given at least five calendar days prior written notice and an opportunity
11 to be heard at the office of administrative trials and hearings (OATH) or its successor agency.
12 However, when the public safety may be imminently jeopardized, the commissioner shall have
13 the power, pending a hearing and determination of charges, to forthwith suspend any license for
14 a period not exceeding 15 days.

15 **§28-401.19.2 Resolution of proceedings.** Resolution of proceedings shall comply with the
16 following:

- 17 1. **Surrender of ~~[plate or]~~ seal.** Upon surrender, suspension or revocation of a license for
18 which the department has also issued a ~~[plate or]~~ seal, the license and ~~[such plate and/or]~~
19 seal shall be immediately surrendered to the department.
- 20 2. **Posting of resolution of proceedings.** The names of all licensees whose licenses were
21 suspended or revoked or upon whom penalties have been imposed after a hearing and a
22 department determination ~~[following an office of administrative trials and hearings~~
23 ~~(OATH), or its successor agency, as applicable, report and recommendation]~~ shall be
24 posted on the department's website. The department shall post the names of the licensees
25 who have entered into stipulations with the department, unless the stipulation agreed to
26 by the parties provides otherwise.

27 ~~[§28-401.19.3 Reinstatement fees. The fees required for the reinstatement of a certificate of~~
28 ~~competence or license, plate or seal after suspension shall be the same as those required to obtain~~
29 ~~an original document. If reinstatement of the certificate of competence, license, plate or seal is~~
30 ~~not requested within 30 days of the lifting of the suspension, then late fees shall be imposed in~~
31 ~~accordance with article 119 of chapter 1 of this title.]~~

32 ~~[§28-401.19.4]~~ **§28-401.19.3 Mandatory suspension or revocation.** The commissioner shall
33 immediately suspend or revoke a license issued pursuant to this code as set forth below. Nothing
34 in the following sections shall be construed to limit the commissioner's power to revoke or
35 suspend licenses in other circumstances.

36 ~~[§28-401.19.4.1]~~ **§28-401.19.3.1 Rigger license.** Any licensed rigger who has been found
37 guilty after proceedings before the environmental control board or other adjudicative
38 proceedings of violating section 28-404.1 or 28-401.9 of the administrative code or sections
39 3314.1.1 and 3314.4.3.1 of the New York city building code, or of failing to insure that
40 workers have certificates of fitness required pursuant to this code or applicable rule three

1 times within any six-month period, shall be subject to immediate suspension of his or her
2 license pending a hearing and determination in accordance with the provisions of this code.

3 ~~§28-401.19.4.2~~ **§28-401.19.3.2 General contractor registration.** Any registered general
4 contractor who has defaulted at or been found liable after proceedings before the
5 environmental control board or in an adjudication in criminal court of violations of any
6 provisions of this code relating to a stop work order, public health or safety, structural
7 integrity, building in compliance with approved construction documents or fire safety three
8 times within any ~~twenty-four~~ 24-month period shall be subject to immediate suspension of
9 his or her registration, pending a hearing and determination at office of administrative trials
10 and hearings (OATH) or its successor agency, as applicable.

11 **§28-401.19.4 Restriction on disciplined licensees.** A person who previously held a license that
12 was surrendered subsequent to commencement of a Department disciplinary action, or had their
13 license revoked or was denied renewal, may be prohibited from serving as an officer, director,
14 partner, manager, or licensed individual of a licensed business, whether or not the individual had
15 knowledge of or participated in the prohibited acts or omissions for which the license was
16 surrendered, revoked or denied renewal. The election or appointment of that person by another
17 licensee shall constitute grounds for disciplinary action.

18 **§28-401.20 Cooperation required.** Any person, including any corporation, partnership, business or
19 other entity, issued a license or certificate of competence by the department shall, pursuant to a
20 request or order of the commissioner or any other city agency or office, cooperate fully and
21 completely with respect to any department or city agency or office investigation. Evidence of
22 cooperation shall include, but is not limited to, appearing before the department or other city agency
23 or office, answering questions completely and accurately, and providing any and all requested
24 documents. Failure to comply with such request or order may subject such person to disciplinary
25 measures authorized by law, including but not limited to suspension or revocation of the license or
26 certificate of competence.

27 **§28-401.20.1 Service of request or order.** Such request or order by the commissioner or other
28 city agency or office shall be mailed by regular mail to the person named therein to his or her
29 last known business or home address at least ten days before such appearance and shall contain
30 the name of the person, date, time and place of such appearance and, if known or applicable, a
31 description of any requested documents. If the appearance or information is required
32 immediately, the request or order may be transmitted via facsimile or delivered to the person's
33 last known business or home address prior to the date and time specified therein.

34 **§28-401.21 Judicial review of determinations.** Notwithstanding any other provision of law to the
35 contrary, decisions, orders and interpretations of the commissioner made pursuant to this chapter
36 shall not be subject to review by the board of standards and appeals. Final decisions and orders of
37 the commissioner made pursuant to this chapter shall be subject to review pursuant to article 78 of
38 the civil practice law and rules.

39 **§28-401.22 Deactivation of license.** In the event that the holder of a license is no longer actively
40 engaged as a licensee in a trade or business licensed by the department, the licensee may submit his
41 or her license for deactivation pursuant to department rules. During the period of deactivation, the
42 licensee must continue to pay the license renewal fee required under this chapter for each year of the

1 deactivation period. The holder of a deactivated license may not practice in the trade or business as
2 a licensee or hold himself or herself out as a licensee during the period of deactivation. Application
3 for reactivation of a deactivated license without reexamination shall be made within a time period
4 prescribed by rule and subject to a demonstration of work experience in the trade satisfactory to the
5 commissioner during the time that the license was deactivated.

6 **ARTICLE 402**
7 **SITE SAFETY MANAGER CERTIFICATE**

8 **§28-402.1 Certificate required.** It shall be unlawful to perform the duties and responsibilities of a
9 site safety manager, as specified in chapter 33 of the New York city building code, unless such work
10 is performed by a person certified as a site safety manager under the provisions of this article and
11 department rules.

12 **§28-402.2 Qualifications.** All applicants for a site safety manager certificate shall submit satisfactory
13 proof establishing that the applicant:

- 14 1. ~~[Is a registered design professional and has three years of experience supervising construction~~
15 ~~or demolition of major buildings as the term major building is defined in chapter 33 of the~~
16 ~~New York city building code, and within one year prior to application has satisfactorily~~
17 ~~completed a 40-hour course approved by the department;]~~ Has, within one (1) year prior to
18 application, satisfactorily completed a course that is at least forty (40) hours in length and
19 approved by the department in construction and demolition site safety;
- 20 2. ~~[Has a Certified Safety Professional (“CSP”) designation from the Board of Certified Safety~~
21 ~~Professionals (“BCSP”) and has three years of experience supervising construction or~~
22 ~~demolition of major buildings as the term major building is defined in chapter 33 of the New~~
23 ~~York city building, and within one year prior to application has satisfactorily completed a 40-~~
24 ~~hour course approved by the department;]~~ Possesses a valid Site Safety Training (SST)
25 Supervisor Card; and
- 26 3. ~~[Has eight years of construction supervision experience within the 10 years prior to~~
27 ~~application, including five years supervising construction or demolition of major buildings as~~
28 ~~the term major building is defined in chapter 33 of the New York city building code, and~~
29 ~~within one year prior to application has satisfactorily completed a 40-hour course approved~~
30 ~~by the department;]~~ Meets one of the following experience criteria:
 - 31 3.1. Is a registered design professional and has at least three (3) years of field experience,
32 within the five (5) years prior to application, either (i) serving in a supervisory role with
33 responsibility over workers engaged in construction or demolition work subject to a site
34 safety plan at major buildings in the city of New York, or (ii) providing site safety
35 oversight during construction or demolition work subject to a site safety plan at major
36 buildings in the city of New York, including but not limited to conducting site safety
37 risk assessments, developing or implementing site safety hazard control measures,
38 managing site safety operations, or performing inspections to verify compliance with
39 requirements imposed by chapter 33 of the New York city building code and related
40 rules;

- 1 3.2. Holds a Certified Safety Professional (CSP) certification from the Board of Certified
2 Safety Professionals (BCSP) and has at least three (3) years of field experience, within
3 the five (5) years prior to application, either (i) serving in a supervisory role with
4 responsibility over workers engaged in construction or demolition work subject to a site
5 safety plan at major buildings in the city of New York, or (ii) providing site safety
6 oversight during construction or demolition work subject to a site safety plan at major
7 buildings in the city of New York, including but not limited to conducting site safety
8 risk assessments, developing or implementing site safety hazard control measures,
9 managing site safety operations, or performing inspections to verify compliance with
10 safety requirements imposed by law;
- 11 3.3. Is a New York city certified site safety coordinator and has at least three (3) years of
12 experience, within the five (5) years prior to application, serving as a designated site
13 safety coordinator during the construction or demolition of major buildings in New York
14 city;
- 15 3.4. Is a New York city registered concrete safety manager and has at least four (4) years of
16 experience, within the seven (7) years prior to application, serving as a designated
17 concrete safety manager during the construction or demolition of major buildings in the
18 city of New York;
- 19 3.5. Holds a Construction Health and Safety Technician (CHST) certification from the Board
20 of Certified Safety Professionals (BCSP) and has at least four (4) years of field
21 experience, within the eight (8) years prior to application, either (i) serving in a
22 supervisory role with responsibility over workers engaged in construction or demolition
23 work subject to a site safety plan at major buildings in the city of New York, or (ii)
24 providing site safety oversight during construction or demolition work subject to a site
25 safety plan at major buildings in the city of New York, including but not limited to
26 conducting site safety risk assessments, developing or implementing site safety hazard
27 control measures, managing site safety operations, or performing inspections to verify
28 compliance with safety requirements imposed by law;
- 29 3.6. Has at least five (5) years of experience, within the eight (8) years prior to application,
30 servin g in a supervisory role with full-time responsibility over workers engaged in
31 construction or demolition work subject to a site safety plan at major buildings in the
32 city of New York;
- 33 3.7. Has eight (8) years of experience, within the ten (10) years prior to application, as a
34 New York city buildings department enforcement official, as determined by the
35 commissioner. At least four (4) years of the experience must have been in the inspection
36 of major buildings under construction or demolition for compliance with the provisions
37 of chapter 33 of the New York city building code and related rules;
- 38 3.8. Has completed an 18-month on-the-job site safety manager training program conducted
39 under the direct supervision of a certified site safety manager during the construction or
40 demolition of major buildings in the city of New York. Such on-the-job training program
41 shall conform to rules promulgated by the department. During the on-the-job training
42 program, the applicant shall only serve as a site safety manager in training, and shall

1 serve in such role on a full-time basis. The supervising site safety manager shall register
2 the trainee with the department prior to the commencement of the training program and
3 shall certify the trainee’s satisfactory completion of the training program at the
4 conclusion of the program; or

5 3.9. Has successfully completed a site safety manager apprenticeship program approved by
6 the New York State Department of Labor.

7 [~~4. Has completed an 18 month on the job training program working on major buildings as that~~
8 ~~term is defined in chapter 33 under the direct and continuing supervision of a certified site~~
9 ~~safety manager. Such on the job training program shall conform to rules promulgated by the~~
10 ~~department. The supervising site safety manager shall certify the trainee’s satisfactory~~
11 ~~completion of the training program. In addition, the applicant shall provide proof that, within~~
12 ~~one year prior to the date of application, he or she has satisfactorily completed a 40 hour~~
13 ~~course approved by the department;]~~

14 [~~5. Has equivalent education and construction experience as determined by the department and~~
15 ~~within one year prior to application has satisfactorily completed a 40 hour course approved~~
16 ~~by the department; or]~~

17 [~~6. Has three years of experience as a certified site safety coordinator and within one year prior~~
18 ~~to application has satisfactorily completed a 40 hour course approved by the department.]~~

19 §28-402.3 Fitness to perform work. As a condition of certificate renewal, a certified site safety
20 manager shall provide evidence satisfactory to the department that he or she is fit to perform the
21 work.

22 **ARTICLE 403**
23 **SITE SAFETY COORDINATOR CERTIFICATE**

24 **§28-403.1 Certificate required.** It shall be unlawful to perform the duties and responsibilities of a
25 site safety coordinator, as specified in chapter 33 of the New York city building code, unless such
26 work is performed by a person certified as a site safety coordinator under the provisions of this article
27 and department rules.

28 **§28-403.2 Qualifications.** All applicants for a site safety coordinator certificate shall submit
29 satisfactory proof establishing that the applicant:

- 30 1. [~~Is a registered design professional and has two years of experience supervising construction~~
31 ~~or demolition of major buildings as the term major building is defined in chapter 33 of the~~
32 ~~New York city building code, and within one year prior to application has satisfactorily~~
33 ~~completed an 8 hour course approved by the department;]~~ Has, within one (1) year prior to
34 application, satisfactorily completed a course that is at least forty (40) hours in length and
35 approved by the department in construction and demolition site safety;
- 36 2. [~~Has a Construction Health and Safety Technician (“CHST”) designation from the Board of~~
37 ~~Certified Safety Professionals (“BCSP”) and has two years of experience supervising~~
38 ~~construction or demolition of major buildings as the term major buildings is defined in~~

chapter 33 of the New York city building code, and within one year prior to application has satisfactorily completed an 8 hour course approved by the department;] Possesses a valid Site Safety Training (SST) Supervisor Card; and

3. ~~[Has five years of construction supervision or construction safety experience within the 10 years prior to application, including three years supervising construction or demolition of major buildings as the term major building is defined in chapter 33 of the New York city building code, and within one year prior to application has satisfactorily completed an 8 hour course approved by the department; or]~~ Meets one of the following experience criteria:

3.1. Is a registered design professional and has at least two (2) years of field experience, within the five (5) years prior to application, either (i) serving in a supervisory role with responsibility over workers engaged in construction or demolition work subject to a site safety plan at major buildings in the city of New York, or (ii) providing site safety oversight during construction or demolition work subject to a site safety plan at major buildings in the city of New York, including but not limited to conducting site safety risk assessments, developing or implementing site safety hazard control measures, managing site safety operations, or performing inspections to verify compliance with requirements imposed by chapter 33 of the New York city building code and related rules;

3.2. Holds a Certified Safety Professional (CSP) certification from the Board of Certified Safety Professionals (BCSP) and has at least two (2) years of field experience, within the five (5) years prior to application, either (i) serving in a supervisory role with responsibility over workers engaged in construction or demolition work subject to a site safety plan at major buildings in the city of New York, or (ii) providing site safety oversight during construction or demolition work subject to a site safety plan at major buildings in the city of New York, including but not limited to conducting site safety risk assessments, developing or implementing site safety hazard control measures, managing site safety operations, or performing inspections to verify compliance with safety requirements imposed by law;

3.3. Is a New York city registered concrete safety manager and has at least three (3) years of experience, within the seven (7) years prior to application, serving as a designated concrete safety manager during the construction or demolition of major buildings in the city of New York;

3.4. Holds a Construction Health and Safety Technician (CHST) certification from the Board of Certified Safety Professionals (BCSP) and has at least three (3) years of field experience, within the seven (7) years prior to application, either (i) serving in a supervisory role with responsibility over workers engaged in construction or demolition work subject to a site safety plan at major buildings in the city of New York, or (ii) providing site safety oversight during construction or demolition work subject to a site safety plan at major buildings in the city of New York, including but not limited to conducting site safety risk assessments, developing or implementing site safety hazard control measures, managing site safety operations,

1 or performing inspections to verify compliance with safety requirements imposed
2 by law;

3 3.5. Has at least four (4) years of experience, within the seven (7) years prior to
4 application, serving in a supervisory role with full-time responsibility over workers
5 engaged in construction or demolition work subject to a site safety plan at major
6 buildings in the city of New York; or

7 3.6. Has five (5) years of experience, within the eight (8) years prior to application, as a
8 New York city buildings department enforcement official, as determined by the
9 commissioner. At least two and a half (2.5) years of the experience must have been
10 in the inspection of major buildings under construction or demolition for
11 compliance with the provisions of chapter 33 of the New York city building code
12 and related rules.

13 §28-403.3 Fitness to perform work. As a condition of certificate renewal, a certified site safety
14 coordinator shall provide evidence satisfactory to the department that he or she is fit to perform the
15 work.

16 **ARTICLE 404**
17 **RIGGER LICENSE**

18 **§28-404.1 Rigger license required.** It shall be unlawful to hoist or lower any suspended article,
19 including but not limited to suspended scaffolds, on the outside of any building [~~in the city~~] unless
20 such work is performed by or under the direct and continuing supervision of a person licensed as a
21 rigger under the provisions of this article. The provisions of this article shall also apply to the erection
22 or dismantling of a tower crane [~~or a climber crane on a building and to the use of a derrick in their~~
23 ~~removal, except that such erection or dismantling may be performed by or under the direct and~~
24 ~~continuing supervision of a licensed climber or tower crane rigger in accordance with rules~~
25 ~~promulgated by the department].~~

26 **[Exception] Exceptions:** The provisions of this article shall not apply to:

- 27 1. The hoisting or lowering of signs if the person so doing possesses a license as a sign
28 hanger, as provided in this chapter;
- 29 2. The loading or unloading of a material delivery truck if the material loaded or unloaded
30 is not raised more than 12 feet (3658 mm) above the bed of the truck during the loading
31 or unloading process; [~~or~~]
- 32 3. The hoisting or lowering of suspended articles on the outside of a building [~~in the city~~]
33 where chapter 33 of the New York city building code authorizes such articles to be
34 hoisted or lowered by or under the supervision of a qualified and/or competent person [-];
35 or
- 36 4. The assembly or disassembly of a self-erecting tower crane, provided such operation is
37 supervised by an assembly/disassembly director in accordance with rules promulgated by
38 the commissioner.

1 §28-404.2 Classification. Rigger licenses shall be classified as follows:

- 2 1. **Master rigger license.** Authorizes the holder thereof to install or use a suspended scaffold, or
3 to hoist or lower any suspended article [~~with a hoisting machine~~], irrespective of weight, on
4 the outside of any building.
- 5 2. **Special rigger license.** Authorizes the holder thereof to:
 - 6 2.1. Install or use a suspended scaffold; and
 - 7 2.2. Hoist or lower any suspended article not exceeding 2,000 pounds (907 kg) in weight on
8 the outside of any building with [a] hoisting [~~machine~~] equipment, provided the
9 manufacturer rated capacity of such hoisting [~~machine~~] equipment does not exceed
10 2,000 pounds (907 kg).
- 11 3. [~~Climber or tower~~] **Tower crane rigger license.** Authorizes the holder thereof to assemble,
12 jump or disassemble a tower crane [~~or a climber crane~~], or to supervise such work, and to
13 install or use a derrick(s) in conjunction with such work and supervise such installation or use
14 of the derrick.

15 §28-404.3 [~~Additional qualifications~~] **Qualifications.** [Applicants] All applicants for a rigger
16 license shall [have the additional qualifications as set forth in sections 28-404.3.1 through 28-404.3.3]
17 submit satisfactory proof establishing that the applicant meets the qualifications, as set forth below,
18 for the type of license sought.

19 §28-404.3.1 **Master rigger license qualifications.** All applicants for a master rigger license shall
20 submit satisfactory proof establishing that the applicant:

- 21 1. [~~Has at least five years of practical experience in the hoisting and rigging business within~~
22 ~~the seven years prior to application~~] Possesses valid certifications for both rigging
23 supervision and lift direction. The certifications must be acceptable to the commissioner
24 and be issued by a rigging supervision and lift direction certification program that is
25 accredited by the National Commission for Certifying Agencies (NCCA) or the American
26 National Standards Institute (ANSI). The certifications shall cover areas including, but
27 not limited to, the inspection and use of rigging hardware, rigging techniques, signaling,
28 hazards associated with rigging, and calculations and problem solving with respect to
29 rigging;
- 30 2. [~~Has knowledge of and is able to explain the risks incident to such business and~~
31 ~~precautions to be taken in connection therewith, safe loads and computation thereof, types~~
32 ~~of rigging, size and strength of ropes, cables, blocks, poles, derricks, shear legs and other~~
33 ~~tools used in connection with such business; and~~] Has, within the one (1) year prior to
34 application, satisfactorily completed a department-approved training course for lift
35 directing that is at least 32 hours in length and in accordance with the requirements of
36 section 28-424.3 of this code;
- 37 3. [~~Has satisfactorily completed a department approved training course of not less than thirty~~
38 ~~hours. Any person who, within the three years prior to the date of the application, has~~
39 ~~successfully completed at least a thirty-hour training course need not take a second thirty-~~
40 ~~hour course, provided such person can provide to the department a dated certificate as set~~
41 ~~forth in this section. Such person shall, however, take a department approved eight-hour~~

1 re-certification course within three years of the initial course and every three years
2 thereafter. Successful completion of the training or re-certification course shall be
3 evidenced by a dated certificate issued by the provider of the training or re-certification
4 course. The certificate shall include such information as specified by the department by
5 rule. The certificate, or a valid wallet card version thereof, shall be readily available to the
6 commissioner upon request. Such training or recertification course shall be conducted (i)
7 pursuant to a registered New York state department of labor training program, or (ii) by a
8 provider approved by the department.] Has, within the one (1) year prior to application,
9 satisfactorily completed a department-approved training course for rigging supervision
10 that is at least 32 hours in length and in accordance with the requirements of section
11 3316.9.2 of the New York city building code; and

12 4. Meets one of the following experience criteria:

13 4.1. Has at least five (5) years of experience, within the seven (7) years prior to
14 application, working as a designated master rigging foreman in the city of New
15 York under the direct and continuing supervision of a licensed master rigger;

16 4.2. Is a licensed professional engineer and, within the five (5) years prior to
17 application, has developed and provided onsite verification of the critical pick
18 plan in accordance with section 3316.9.1 of the New York city building code
19 for at least twenty-five (25) separate New York city certificates of on-site
20 inspections; or

21 4.3. Has at least five (5) years of experience, within the seven (7) years prior to
22 application, working as a licensed lift director in the city of New York.

23 **§28-404.3.2 Special rigger license qualifications.** All applicants for a special rigger license shall
24 submit satisfactory proof establishing that the applicant:

25 1. [~~Has at least one year of practical experience in the hoisting and rigging business within~~
26 ~~the three years prior to application~~] Has, within the one (1) year prior to application,
27 satisfactorily completed a department-approved training course for special riggers that
28 is at least 16 hours in length;

29 2. [~~Has knowledge of and is able to explain the risks incident to such business and~~
30 ~~precautions to be taken in connection therewith~~] Has, within the one (1) year prior to
31 application, satisfactorily completed a department-approved training course for
32 suspended scaffold supervision that is at least 32 hours in length and in accordance with
33 the requirements of section 3314.4.5.3 of the New York city building code; and

34 3. [~~Has satisfactorily completed a department-approved training course of not less than thirty~~
35 ~~hours. Any person who, within the three years prior to the date of the application, has~~
36 ~~successfully completed at least a thirty-hour training course need not take a second thirty-~~
37 ~~hour course, provided such person can provide to the department a dated certificate as set~~
38 ~~forth in this section. Such person shall, however, take a department approved eight hour~~
39 ~~re-certification course within three years of the initial course and every three years~~
40 ~~thereafter. Successful completion of the training or re-certification course shall be~~
41 ~~evidenced by a dated certificate issued by the provider of the training or re-certification~~
42 ~~course. The certificate shall include such information as specified by the department by~~
43 ~~rule. The certificate, or valid wallet card version thereof, shall be readily available to the~~

1 commissioner upon request. Such training or recertification course shall be conducted (i)
2 pursuant to a registered New York state department of labor training program, or (ii) by a
3 provider approved by the department.] Meets one of the following experience criteria:

4 3.1. Has at least two (2) years of experience, within the three (3) years prior to
5 application, working as a designated special rigging foreman in the city of New
6 York under the direct and continuing supervision of a licensed special rigger; or

7 3.2. Has at least three (3) years of experience, within the five (5) years prior to
8 application, supervising the installation or use of suspended scaffolds in the
9 city of New York in accordance with section 3314.4 of the New York city
10 building code.

11 **§28-404.3.3 [Climber or tower] Tower crane rigger license qualifications.** All applicants for
12 a [climber or] tower crane rigger license shall submit satisfactory proof establishing that the
13 applicant:

14 1. [~~Has at least five years of practical experience in the climber or tower crane rigging~~
15 ~~business within the seven years prior to application;~~] Has, within the one (1) year prior to
16 application, satisfactorily completed a department-approved training course for tower
17 crane rigging that is at least 30 hours in length and in accordance with the requirements of
18 section 3319.10.1 of the New York city building code; and

19 2. [~~Has knowledge of and is able to explain the risks incident to such business and~~
20 ~~precautions to be taken in connection therewith, including connecting pins, cables,~~
21 ~~anchorage, platform or pad, plumb of mast, torque of bolts, supervision of rigging and~~
22 ~~hoisting of loads, placement of components, and coordination of sequencing; and] Has at
23 least five (5) years of practical experience in the tower crane rigging business in the city
24 of New York within the seven (7) years prior to application.~~

25 [3. ~~Has satisfactorily completed a department-approved training course of not less than thirty~~
26 ~~hours. Any person who, within the three years prior to the date of the application, has~~
27 ~~successfully completed at least a thirty-hour training course need not take a second thirty-~~
28 ~~hour course, provided such person can provide to the department a dated certificate as set~~
29 ~~forth in this section. Such person shall, however, take a department-approved eight-hour~~
30 ~~re-certification course within three years of the initial course and every three years~~
31 ~~thereafter. Successful completion of the training or re-certification course shall be~~
32 ~~evidenced by a dated certificate issued by the provider of the training or re-certification~~
33 ~~course. The certificate shall include such information as specified by the department by~~
34 ~~rule. The certificate, or a valid wallet card version thereof, shall be readily available to the~~
35 ~~commissioner upon request. Such training or recertification course shall be conducted (i)~~
36 ~~pursuant to a registered New York state department of labor training program, or (ii) by a~~
37 ~~provider approved by the department.]~~

38 **§28-404.4 Additional requirements.** The additional requirements set forth in sections 28-404.4.1
39 through 28-404.4.3 shall apply to licensed riggers:

40 **§28-404.4.1 Danger warning.** Every licensed [~~master and special~~] rigger shall, while rigging
41 operations are in progress at a job site, place, conspicuously, at such job site two plates or signs
42 not less than 18 inches (457 mm) by 24 inches (610 mm) in size (i) displaying the word “danger”

1 in letters not less than 6 inches (152 mm) high, and (ii) disclosing the rigger’s name, business
2 address, type of rigger license and license number.

3 **§28-404.4.2 Rigger place of business.** Every licensed master and special rigger shall have a
4 place of business located within the city and shall display prominently at such place of business
5 a plate or sign marked with the words “master rigger” or “special rigger,” respectively, and his
6 or her license number immediately [~~there under~~] thereunder. A master, special and tower [~~or~~
7 ~~climber~~] rigger shall be a sole proprietor, a partner in the partnership or an officer of the
8 corporation and shall be allowed to associate his or her license with only one other rigger
9 business. Such businesses shall be located at the same place of business.

10 **§28-404.4.3 Fitness to perform work.** As a condition of license renewal [~~or reinstatement~~], a
11 licensed master or special rigger shall provide evidence satisfactory to the department that he or
12 she is fit to perform the work.

13 **ARTICLE 405**
14 **HOISTING MACHINE OPERATOR LICENSE**

15 **§28-405.1 Hoisting machine operator license required.** It shall be unlawful for any persons to take
16 charge of or operate any power-operated hoisting machine used for hoisting purposes or cableways
17 under the jurisdiction of the department, unless such person is licensed under the provisions of this
18 article [~~or is a holder of a certificate of qualification as a hoisting machine operator issued prior to~~
19 ~~December 6, 1968 and not allowed to lapse~~].

20 **Exceptions:**

- 21 1. Operators of machinery that is exempted from the requirements of section 3319.1 of the
22 New York city building code.
- 23 2. Operators of mobile cranes of a limited size and capacity, or operators of mobile cranes
24 performing a limited use, and exempted from the requirements of this article [~~under~~
25 chapter 33 of the New York city building code, or exempted] in accordance with rules
26 promulgated by the commissioner.
- 27 [~~2-~~] 3. [~~Hoisting~~] Operators of hoisting machines with a manufacturer’s rated capacity of
28 one ton or less.
- 29 [~~3-~~] 4. [~~Power-operated~~] Operators of power-operated scaffolds and window-washing
30 machines.
- 31 5. Learners supervised in accordance with the rules of the department by a licensed
32 hoisting machine operator.

33 **§28-405.2 Classification.** Hoisting machine operator licenses shall be classified as follows:

- 34 1. **Class A license:** [~~Basic license~~] License to operate cranes with a [total] boom [less than] ,
35 including jibs and any other extensions to the boom, not exceeding 200 feet (60 960 mm) in
36 length, derricks, and [eableways, excluding truck-mounted tower cranes that exceed 200 feet
37 (60 960 mm) in height] other hoisting machines. This license shall not authorize the operation
38 of a truck-mounted tower crane or a self-erecting tower crane when such crane exceeds 200

1 feet (60 960 mm) in height. This license further shall not authorize the operation of a
2 cableway.

3 **2. Class B license:** [~~Endorsement on basic license to include the operation of~~] License to
4 operate any hoisting machinery, except that to operate hoisting machinery with a boom,
5 including jibs and other extensions, exceeding 300 feet (91 440 mm) in length, or a truck-
6 mounted or self-erecting tower crane that exceeds 300 feet (91 440 mm) in height, the
7 licensee must hold a rating, issued by the department, for the specific make and model of
8 hoisting machine.

9 **3. Class C license:** [~~Special hoisting machine operator license to operate a specified class of~~
10 ~~hoisting machine of limited size and capacity as follows:~~]

11 [~~Class C1:~~] License to operate wheel mounted cranes with telescoping, hydraulic,
12 articulating, or folding booms, including jibs and any other extensions to the boom, not
13 exceeding 200 feet (60 960 mm) in length [~~(60 960 mm)~~] with a manufacturer's rated
14 capacity of 50 tons ([~~54~~] 45.36 t) or less[;] , as well as to operate any hoisting machine within
15 the scope of a limited license.

16 **4. Limited licenses:** Limited hoisting machine operator licenses shall be classified as follows:

17 **4.1. Limited license for articulating boom cranes.** Limited license to operate boom
18 trucks with an articulating boom, including jibs and any other extensions to the boom,
19 not exceeding 200 feet (60 960 mm) in length with a manufacturer's rated capacity of
20 50 tons (45.36 t) or less.

21 **4.2. [~~Class C2: License]~~ Limited license for boom trucks.** Limited license to operate
22 boom trucks with telescoping, hydraulic, articulating, or folding booms, including jibs
23 and any other extensions to the boom, not exceeding 200 feet (60 960mm) in length
24 with a manufacturer's rated capacity of 50 tons ([~~54~~] 45.36 t) or less [;]. This license
25 shall also authorize the operation of any hoisting machine within the scope of a limited
26 license for mini cranes.

27 **4.3. Limited license for mini cranes.** Limited license to operate mobile cranes, other than
28 boom trucks, with a telescoping, hydraulic, articulating, or folding boom, including
29 jibs and any other extensions to the boom, not exceeding 50 feet (15 240 mm) in length
30 with a manufacturer's rated capacity of 3 tons (2.72 t) or less.

31 **4.4. [~~Class C3: License]~~ Limited license for sign hanging cranes.** Limited license to
32 operate boom trucks with telescoping, hydraulic, articulating, or folding booms,
33 including jibs and any other extensions to the boom, not exceeding 135 feet (41 148
34 mm) in length with a manufacturer's rated capacity of [~~three~~] 3 tons (2.72 t) or less,
35 used exclusively for the erection, maintenance, or removal of signs.

36 **4.5. Additional limited licenses via rule.** The commissioner may, via rule, establish
37 additional limited hoisting machine operator licenses. Such additional licenses must be
38 limited as to the type, size, and capacity of hoisting machinery authorized to be operated
39 by a holder of the license.

40 **§28-405.3 [Additional] Experience qualifications.** Applicants for a hoisting machine operator
41 license shall [~~have~~] meet the following [~~additional~~] experience qualifications.

1 **§28-405.3.1 Class A license.** An applicant for a class A [~~basic~~] hoisting machine operator license
2 shall have at least three (3) years of experience, within the five (5) years prior to application,
3 operating hoisting machines in the city of New York in the presence of and under the direct [and
4 continuing] supervision of a licensed class A or class B hoisting machine operator. Such
5 experience shall have been obtained operating hoisting machines of a size, type, and capacity as
6 specified in rules promulgated by the commissioner.

7 **§28-405.3.2 Class B license.** An applicant for a class B hoisting machine operator license shall
8 have the following qualifications.

9 **§28-405.3.2.1 Licensing [~~Endorsement~~] qualifications.** An applicant for a class B hoisting
10 machine operator license shall: ~~(i) have a class A [basic] hoisting machine operator license [;~~
11 ~~and shall have at least two years of experience prior to application under the direct and~~
12 ~~continuing supervision of a class B licensed hoisting machine operator operating the~~
13 ~~equipment for which he or she is applying for endorsement and shall satisfactorily~~
14 ~~demonstrate by operation that he or she is competent to operate a crane with a boom,~~
15 ~~including jibs and other extensions, exceeding 200 feet (60 960 mm) in length or truck-~~
16 ~~mounted tower crane exceeding 200 feet (60 960 mm) in height, or as otherwise provided in~~
17 ~~rules of the department.] and have held such class A license for at least five (5) years prior~~
18 ~~to application; (ii) have at least three (3) years of experience, within the eight (8) years prior~~
19 ~~to application, operating, in the city of New York as a class A licensed hoisting machine~~
20 ~~operator, mobile cranes with a manufacturer's rated capacity in excess of 50 tons (45.36 t) or~~
21 ~~tower cranes; and (iii) separately, while holding the class A license, have at least one (1) year~~
22 ~~of experience, within the five (5) years prior to application, operating cranes in the city of~~
23 ~~New York with a boom, including jibs and any other extensions to the boom, greater than~~
24 ~~200 feet (60 960 mm) in length as a learner in the presence of and under the direct supervision~~
25 ~~of a licensed class B hoisting machine operator.~~

26 **§28-405.3.2.2 Licensing ratings qualifications.** An applicant for a class B hoisting machine
27 operator licensing rating shall have a class B hoisting machine operator license and shall
28 satisfactorily demonstrate that he or she is competent to operate a hoisting machine with a
29 boom, including jibs and any other extensions to the boom, exceeding 300 feet (91 440 mm)
30 in length or a truck-mounted tower crane exceeding 300 feet (91 440 mm) in height. Unless
31 otherwise provided in rules of the department, such [~~competence~~] competency shall be
32 demonstrated by operation, practical examination, or completion of simulator training and
33 shall be specific to the make and model of the hoisting machine for which the rating [~~shall~~]
34 is to be issued. In addition to holding a rating, such hoisting machine operator must complete
35 any orientation required by the department.

36 **§28-405.3.3 Class C license.** An applicant for a class C [~~special~~] hoisting machine operator
37 license shall have at least two (2) years of experience, within the three (3) years prior to
38 application, operating hoisting machines in the presence of and under the direct [and continuing]
39 supervision of a licensed hoisting machine operator [and have satisfactorily passed a practical
40 examination in the operation of equipment for which such license is to be issued]. Such
41 experience shall have been obtained operating hoisting machines of a size, type, and capacity as
42 specified in rules promulgated by the commissioner.

43 **§28-405.3.4 Limited licenses.** An applicant for a limited hoisting machine operator license shall
44 have at least two (2) years of experience, within the three (3) years prior to application, in the

1 presence of and under the direct supervision of a licensed hoisting machine operator. Such
2 experience shall have been obtained operating hoisting machines of a size, type, and capacity as
3 specified in rules promulgated by the commissioner.

4 **Exception:** The commissioner may, by rule, establish alternative pathways for individuals
5 who, on or before the date that is two years after the effective date of this provision, apply for
6 a limited license for articulating boom cranes or a limited license for mini cranes.

7 **§28-405.4 Fitness to perform work.** As a condition of license issuance and renewal, ~~and~~
8 ~~reinstatement,~~ a [licensed] hoisting machine operator shall provide evidence satisfactory to the
9 department that he or she is fit to perform the work.

10 **§28-405.5 Insurance exemption.** Unless otherwise required by rule, licensed hoisting machine
11 operators are exempt from the insurance requirements of section 28-401.9.

12 **§28-405.6 Certification required.** The commissioner shall, by rule, require hoisting machine
13 operators to possess one or more certifications for the operation of hoisting machinery. Such
14 certifications shall be based on the passage of a written and a practical examination for the type of
15 hoisting machinery authorized to be operated by the certification.

16 **ARTICLE 406**
17 **CONCRETE TESTING LABORATORY LICENSE**

18 **§28-406.1 Concrete testing laboratory license required.** Testing of concrete required by this code
19 or other applicable laws or rules shall be conducted by a concrete testing laboratory licensed in
20 accordance with this article.

21 **§28-406.1.1 Term of license.** The term of a concrete testing laboratory license shall be one (1)
22 year and may be renewed every year thereafter.

23 **§28-406.2 Qualifications.** All applicants for a concrete testing laboratory license shall maintain a
24 laboratory within 50 miles (80 467 m) of the city and shall submit satisfactory proof establishing
25 that the business is conducted by qualified personnel in accordance with procedures, safety
26 requirements and professional standards as set forth in rules of the department. The department shall
27 inspect an applicant's place of business and equipment and conduct an investigation of applicant's
28 personnel in a manner to be set forth in department rules prior to the issuance or renewal of a license.

29 **§28-406.3 Additional requirements.** The following additional requirements shall apply to concrete
30 testing laboratories:

31 **§28-406.3.1 Director.** Each laboratory shall have in responsible charge a director who shall be a
32 full-time employee of the laboratory and shall not serve as the director of more than one licensed
33 laboratory at a time. The director shall be a registered design professional, comply with
34 additional qualification requirements as set forth in department rules, and shall personally
35 supervise all technical functions of the laboratory relating to testing of concrete and concrete
36 materials as required in this code and in rules of the department.

1. Has at least seven (7) years total experience, within the ten (10) years prior to application, in the installation of plumbing systems and the planning or design [~~-, and installation,-~~] of plumbing systems under the direct and continuing supervision of a licensed master plumber in the United States, with at least two (2) years of such experience as a registered journeyman plumber in accordance with the provisions of article 409 [~~-, except that during the three years immediately following July 1, 2008, there shall be no requirement for such registered journeyman plumber experience~~];
2. Has received a bachelor's degree in mechanical engineering or appropriate engineering technology from an accredited college or university and has at least five (5) years total experience, within the seven (7) years prior to application, in the installation of plumbing systems and the planning or design [~~and installation~~] of plumbing systems under the direct and continuing supervision of a licensed master plumber in the United States, where at least two (2) years of such experience were in New York city;
3. Is an architect or engineer with at least three (3) years of experience, within the five (5) years prior to application, in the installation of plumbing systems and the planning or design [~~-, and installation,-~~] of plumbing systems. All required experience must be under the direct and continuing supervision of a licensed master plumber in the United States, [~~where~~] and at least one (1) year of such experience [~~was~~] must be in New York city;
4. Has at least seven (7) years total experience, within the ten (10) years prior to application, with at least two (2) years of such experience working [~~in the~~] with installation of plumbing systems and in the planning or design [~~-, and installation,-~~] of plumbing systems under the direct and continuing supervision of a licensed master plumber in the United States. The balance of such required experience may be obtained by performing maintenance, replacement and repair plumbing work on existing buildings while in the employ of a city agency under the direct and continuing supervision of a licensed master plumber supervisor employed by the city agency. [~~Three years after July 1, 2008 the~~] The two (2) years' experience in the installation of plumbing systems and in the planning or design [~~-, and installation,-~~] of plumbing systems set forth above may only be satisfied by working as a registered journeyman plumber; or
5. Has experience as an employee of a government agency, or a private inspection agency or other entity [~~-, acceptable to the commissioner~~] as specified in department rules, whose duties primarily involve the inspection of plumbing work for compliance with the New York city plumbing code and/or other laws relating to the installation, alteration or repair of plumbing systems [~~which~~] that shall be credited for fifty percent (50%) of the number of years that he or she has been satisfactorily employed in such duties within the ten (10) year period prior to application, which, however, in no event, shall exceed two and one-half (2.5) years credit of satisfactory experience. The balance of the required seven (7) years must have been obtained by working with installation of plumbing systems and in the planning or design [~~-, and installation,-~~] of plumbing systems under the direct and continuing supervision of a licensed master plumber in the United States, except that the requirement of paragraph 1 of this section [~~28-408.3.1~~] that an applicant's working experience must have been within the ten (10) year period prior to application shall not apply to such balance of the work experience required pursuant to this paragraph.

1 §28-408.3.2 **Armed services.** Applicants who were engaged in plumbing work as above
2 provided prior to entering the armed services of the United States shall be permitted to credit
3 their time in the service as experience in the plumbing business, as above provided; but such
4 service credit shall not exceed one-third of the time required for experience.

5 §28-408.4 **Certificate of competence, ~~and~~ license [~~plate~~] and [~~seal~~].** The commissioner shall
6 issue a certificate of competence, license [~~plate~~] and [~~seal~~] seal, in accordance with the following:

7 §28-408.4.1 **Certificate of competence.** A certificate of competence shall be issued by the
8 commissioner to an applicant who satisfactorily complies with the experience and examination
9 requirements of this chapter for a license, upon payment of the fee. Such certificate shall contain
10 the full name of the individual and a certificate number, the date of issuance, and shall be signed
11 by the commissioner.

12 §28-408.4.2 **Effect of issuance.** The issuance of a certificate of competence shall constitute
13 evidence that the person named therein is qualified, upon payment of applicable fees, to obtain
14 a [~~plate and~~] seal while the certificate is valid [~~except that a city employee while in the employ~~
15 ~~of the city shall only be entitled to obtain a seal~~].

16 §28-408.4.3 [~~Plate and/or seal~~] **Seal required.** The holder of a certificate shall not be entitled
17 to perform work or hold himself or herself out to perform work as a licensed master plumber
18 until such [~~plate and/or~~] seal [~~have~~] has been obtained. Further, no holder of a certificate of
19 competence shall enter into any contractual agreement to install or alter any plumbing, gas
20 piping, or any piping system, other than an employment agreement with a master plumber
21 business or a city agency.

22 §28-408.4.4 [~~Effect of failure~~] **Failure to obtain [~~plate and/or~~] seal.** If a holder of a certificate
23 of competence has held the certificate for five (5) years without a [~~plate and/or~~] seal, then the
24 commissioner may require said person to submit an affidavit and supporting documentation
25 satisfactory to the department stating that over the five (5) year period the individual has been
26 engaged in the installation of plumbing systems and the planning or the design [~~and~~
27 ~~installation~~] of plumbing systems in the United States under the direct and continuing
28 supervision of a licensed master plumber. If the holder's qualifications are not satisfactory to the
29 commissioner, the commissioner may require such person to submit to reexamination or to
30 provide evidence of retained proficiency. [~~In addition, additional~~] Additional fees will be due, as
31 set forth in this chapter.

32 §28-408.4.5 **Requirement for obtaining a license [~~plate~~] and [~~seal~~].** A holder of a
33 certificate of competence or an applicant who has satisfied all requirements for a master plumber
34 license shall obtain:

- 35 1. A license [~~plate~~] and [~~seal~~] seal issued upon establishing a master plumbing business
36 conforming to the requirements of this article and rules promulgated by the department;
37 or
- 38 2. A license and seal issued upon demonstrating employment with a city agency. The license
39 shall clearly state: "The bearer of this master plumber license is a government employee
40 and as such is not authorized to engage in plumbing contract work outside of his/her

1 government employment and within such government employment shall only engage in
2 [~~maintenance, replacement and repair~~] plumbing work on existing buildings.” [No plate
3 shall be issued to a licensed master plumber employed by a city agency.]

4 **§28-408.4.6 Issuance.** A certificate of competence or a license [~~, plate,~~] and [~~/or~~] seal as a master
5 plumber shall be issued only to an individual.

6 **§28-408.4.7 Duplication prohibited.** Not more than one license [~~, plate~~] and [~~/or~~] seal shall be
7 issued to an individual and no individual shall make or cause to be made a duplicate of such
8 license [~~, plate or~~] and seal.

9 **§28-408.5 Surrender of license [~~, plate~~] or seal.** Upon the death or the retirement of a licensed
10 master plumber, or upon the surrender, revocation or suspension of his or her license, his or her
11 license, [~~plate~~] and [~~/or~~] seal shall immediately be surrendered to the commissioner. Nothing
12 contained herein shall be construed to prevent the legal representative of a deceased licensee, with
13 the consent of the commissioner, from retaining such [~~plate and~~] seal for the purpose of completing
14 all unfinished work of the deceased licensee for which plans have been approved and a permit issued,
15 provided such work is performed by or under the direct and continuing supervision of a licensed
16 master plumber and is completed within one (1) year from the date of the death of the original
17 licensee. Retired licensees and the legal representatives of deceased licensees shall schedule for
18 inspection, withdraw or have another licensee re-file any open application filed under such license
19 in accordance with department procedures.

20 **§28-408.6 Master plumber business required.** No individual, corporation, partnership or other
21 business association shall conduct a plumbing [~~contracting~~] contractor business in the city of New
22 York, or employ the name “plumber” or “plumbing” in its business name unless such business is a
23 master plumber business as follows:

- 24 1. No less than 51 percent of the control and voting capital stock of such plumbing [~~contracting~~]
25 contractor business is owned by one or more individuals who are licensed master plumbers
26 [~~who cannot be terminated from the public contracting business by any person or entity~~] ,
27 except as otherwise provided;
- 28 2. All plumbing or gas piping work performed by such entity is performed by or under the direct
29 and continuing supervision of such licensed master plumber;
- 30 3. The person in charge of such work is such licensed master plumber; and
- 31 4. The persons actually performing such work are in the direct employ of such master plumber
32 business as authorized by the code.

33 **Exception:** A company, corporation, partnership or other business association or its
34 predecessor that was engaged in plumbing work prior to January 25, 1990 may continue to
35 do so in any one or more of such business forms without complying with the foregoing, if (i)
36 application was made to the department prior to July 25, 1990, and (ii) necessary evidence
37 was furnished on or prior to January 25, 1991, that such company, corporation, partnership
38 or other business association or its predecessor had employed an average of ten or more
39 journeymen plumbers doing plumbing work for at least five days a week for a period of ten

1 (10) years or more out of the twenty (20) years preceding July 25, 1990, provided, that such
2 plumbing business continues to have all plumbing work conducted under the management
3 and direct and continuing supervision of a licensed master plumber in the direct employ of
4 such plumbing business and that such licensed master plumber is not otherwise interested in,
5 associated with or employed by any other plumbing business operating in this city except as
6 a joint venture in which such master plumber's employer is one of the joint venturers.

7 **§28-408.6.1 Use.** Nothing herein contained shall be construed to prohibit the use of a master
8 plumber license by the holder thereof for or on behalf of a partnership, corporation or other
9 business association, provided that such partnership, corporation or other business is a master
10 plumber business.

11 **§28-408.6.2 Identification.** All business vehicles, advertising, websites and stationery used in
12 connection with a master plumber business shall display prominently the full name of the
13 licensee, the words "N.Y.C. licensed plumber," the licensee's number and the licensee's business
14 address. If the business is conducted under a trade name, or by a partnership or corporation, the
15 trade name, partnership or corporate name shall be placed immediately above the full name or
16 names of the licensed master plumber or licensed master plumbers [~~to whom the plates were~~
17 ~~issued~~]. Prior to using, the trade name, partnership or corporate name must have been disclosed
18 to the department in a form and manner required by the department.

19 **§28-408.6.3 Withdrawal of license.** If a licensed master plumber withdraws from a master
20 plumbing business operating pursuant to such individual's license, the right of the business to
21 perform plumbing work shall lapse if the provisions of this [~~section 28-408.6~~] article are no
22 longer satisfied. If a licensed master plumber's license is revoked or suspended, such licensee
23 will be deemed withdrawn from such business.

24 **§28-408.6.4 Ownership limitations.** An individual who is a licensed master plumber whose
25 interest or ownership in a master plumber business constitutes any portion of the 51 percent
26 interest or control required by [~~this~~] section 28-408.6 shall be allowed to possess an interest or
27 ownership in only one other master plumber business, where such interest or ownership would
28 constitute any portion of the 51 percent interest or control required by [~~this~~] section 28-408.6.
29 Both master plumber businesses in which the licensed master plumber has an interest shall be
30 located at the same place of business. For the purposes of [~~this~~] section 28-408.6, where two or
31 more individuals who are licensed master plumbers possess an interest or ownership in any
32 master plumber business [~~which~~] that together represents more than 51 percent of the interest or
33 control of such entity, all of such licensees shall be deemed to possess a portion of the 51 percent
34 interest or control required by [~~this~~] section 28-408.6.

35 **§28-408.6.5 Joint ventures.** Nothing contained in [~~this~~] section 28-408.6 shall be construed to
36 prevent a master plumber business from entering into a joint venture of limited duration for a
37 particular project with another master plumber business. The terms of a joint venture must be in
38 writing, and documentation of the joint venture must be submitted to the department for approval
39 prior to the initiation of work under such venture.

40 **§28-408.6.6 Supervision.** The master plumber shall conduct his or her business to provide direct
41 and continuing supervision in accordance with the provisions of this code.

- 1 1. Has at least seven (7) years total experience, within the ten (10) years prior to application,
2 in the performance of fire suppression piping work, including the planning or design [~~;~~
3 ~~and installation,~~] of fire suppression piping systems under the direct and continuing
4 supervision of a licensed master fire suppression piping contractor in the United States
5 with the class of license for which application is made, with at least two (2) years of such
6 experience as a registered journeyman fire suppression piping installer in accordance with
7 the provisions of article 411 [~~;~~ ~~except that during the three years immediately following~~
8 ~~July 1, 2008, there shall be no requirement for such registered journeyman fire~~
9 ~~suppression piping installer experience~~];
- 10 2. Has received a bachelor's degree in mechanical engineering, fire protection engineering
11 or appropriate engineering technology from an accredited college or university and has
12 at least five (5) years total experience, within the seven (7) years prior to application, in
13 the performance of fire suppression piping work, including the planning or design [~~;~~
14 ~~and installation,~~] of fire suppression piping systems under the direct and continuing
15 supervision of a licensed master fire suppression piping contractor in the United States
16 [~~for~~] with the class of license for which application is made, at least two (2) of which
17 were in New York city;
- 18 3. Is an architect or engineer with at least three (3) years of experience, within the five (5)
19 years prior to application, in the performance of fire suppression piping work, including
20 the planning or design [~~;~~ ~~and installation,~~] of fire suppression piping systems. All required
21 experience must be under the direct and continuing supervision of a licensed master fire
22 suppression piping contractor in the United States [~~for~~] with the class of license for which
23 application is made, [~~where~~] and at least one (1) year of such experience [~~was~~] must be
24 in New York city;
- 25 4. Has at least seven (7) years total experience, within the ten (10) years prior to application,
26 with at least two (2) years of such experience [~~working~~] in the performance of fire
27 suppression piping work, including the planning or design [~~;~~ ~~and installation,~~] of fire
28 suppression piping systems under the direct and continuing supervision of a licensed
29 master fire suppression piping contractor in the United States with the class of license for
30 which application is made. The balance of such required experience may be obtained by
31 performing maintenance, replacement and repair of fire suppression piping work on
32 existing buildings while in the employ of a city agency under the direct and continuing
33 supervision of a licensed master fire suppression piping contractor supervisor employed
34 by the city agency with the class of license for which application is made. [~~Three years~~
35 ~~after the effective date of this article the~~] The two (2) years of experience in the planning
36 or design [~~;~~ ~~and installation,~~] of fire suppression piping systems set forth above may only
37 be satisfied by working as a registered journeyman fire suppression piping installer; or
- 38 5. Has experience as an employee of a government agency, or a private inspection agency
39 or other entity, [acceptable to the commissioner] as specified in department rules, whose
40 duties primarily involve the inspection of [~~plumbing work~~] fire suppression systems for
41 compliance with [~~this~~]-the New York city plumbing code and/or other laws relating to
42 the installation, alteration or repair of fire suppression piping systems [~~which~~] that shall
43 be credited for fifty percent (50%) of the number of years that he or she has been
44 satisfactorily employed in such duties within the ten (10) year period prior to application,

1 which, however, in no event, shall exceed two and one-half (2½) years credit of
2 satisfactory experience. The balance of the required seven (7) years must have been
3 obtained [by working] in the performance of fire suppression piping work and in the
4 planning or design [~~and installation,~~] of fire suppression piping systems under the direct
5 and continuing supervision of a licensed fire suppression piping contractor in the United
6 States with the class of license for which application is made except that the requirement
7 of paragraph 1 of this section [~~28-410.4.1~~] that an applicant's working experience must
8 have been within the ten (10) year period prior to application shall not apply to such
9 balance of the work experience required pursuant to this paragraph.

10 **§28-410.4.1.1 Domestic water-supplied system experience.** Work on 30 or fewer sprinkler
11 heads off the domestic water shall be considered qualifying experience for a master fire
12 suppression piping contractor license pursuant to this section. Such experience shall qualify
13 when the applicant is working as a licensed master plumber, or an individual working under
14 the direct and continuing supervision of either a licensed master plumber or a master fire
15 suppression piping contractor. The balance of the experience required under all qualification
16 bases must be in the performance of fire suppression piping work as defined in section 28-
17 401.3 under the direct and continuing supervision of a licensed fire suppression piping
18 contractor.

19 **§28-410.4.1.1.1 Class A license.** An applicant for a class A fire suppression piping
20 contractor license may be permitted to use no more than eighteen (18) months of
21 experience working on 30 or fewer sprinkler heads towards satisfying the experience
22 requirements in section 28 410.4.1 items 1 and 2, and no more than six (6) months towards
23 satisfying the experience requirements in section 28-410.1 items 4 and 5.

24 **§28-410.4.1.1.2 Class B license.** An applicant for a class B fire suppression piping
25 contractor license may be permitted to use no more than three (3) years of experience
26 working on 30 or fewer sprinkler heads towards satisfying the experience requirements in
27 section 28-410.4.1 items 1 and 2, and no more than one (1) year towards satisfying the
28 experience requirements in section 28 410.4.1 items 4 and 5.

29 **§28-410.4.2 Armed services.** Applicants who were engaged in fire suppression piping work
30 prior to entering the armed services of the United States shall be permitted to credit their time in
31 the service as experience in the fire suppression piping business, as above provided; but such
32 service credit shall not exceed one-third of the time required for experience.

33 **§28-410.5 Certificate of competence, and license [~~plate~~] and [~~seal~~].** The commissioner shall
34 issue a certificate of competence, license [~~plate~~] and [~~seal~~] in accordance with the following:

35 **§28-410.5.1 Certificate of competence.** A certificate of competence shall be issued by the
36 commissioner to an applicant who satisfactorily complies with the experience and examination
37 requirements of this article for a license, upon payment of the fee. Such certificate shall contain
38 the full name of the individual and a certificate number, and shall be signed by the commissioner.

39 **§28-410.5.2 Effect of issuance.** The issuance of a certificate of competence shall constitute
40 evidence that the person named therein is qualified, upon payment of applicable fees, to obtain

1 a [~~plate and~~] seal while the certificate is valid [~~except that a city employee while in the employ~~
2 ~~of the city shall only be entitled to obtain a seal~~].

3 **§28-410.5.3 [~~Plate and/or seal~~] Seal required.** The holder of a certificate of competence shall
4 not be entitled to perform work or hold himself or herself out to perform work as a licensed
5 master fire suppression piping contractor until such [~~plate and/or~~] seal [~~have~~] has been obtained.
6 Further, no holder of a certificate of competence shall enter into any contractual agreement to
7 install or alter any fire suppression piping system other than an employment agreement with a
8 master fire suppression piping business or a city agency.

9 **§28-410.5.4 Failure to obtain [~~plate and/or~~] seal.** If a holder of a certificate of competence has
10 held the certificate for five (5) years without a [~~plate and/or~~] seal, then the commissioner may
11 require said person to submit an affidavit and supporting documentation satisfactory to the
12 department stating that over the five (5) year period the individual has been engaged in the
13 performance of fire suppression piping work, including the planning or design [~~, and installation,~~
14 of fire suppression piping systems in the United States under the direct and continuing
15 supervision of a licensed master fire suppression piping contractor. If the holder's qualifications
16 are not satisfactory to the commissioner, the commissioner may require such person to submit to
17 reexamination or to provide evidence of retained proficiency. [~~In addition, additional~~] Additional
18 fees will be due, as set forth in this chapter.

19 **§28-410.5.5 [~~License plate and/or seal~~] Requirement for obtaining a license and seal.** A
20 holder of a certificate of competence or an applicant who has satisfied all requirements for a
21 master fire suppression piping contractor license shall obtain:

- 22 1. A license [~~, plate~~] and seal issued upon establishing a fire suppression piping contracting
23 business conforming to the requirements of this article and any rules promulgated by the
24 department; or
- 25 2. A license and seal issued upon demonstrating employment with a city agency. The license
26 shall clearly state: "The bearer of this master fire suppression piping contractor license is
27 a government employee and as such is not authorized to engage in fire suppression piping
28 contract work outside of his/her government employment and within such government
29 employment shall only engage in [~~maintenance, replacement and repair~~] fire suppression
30 piping work on existing buildings." [~~No plate shall be issued to a licensed master fire~~
31 ~~suppression piping contractor employed by a city agency.~~]

32 **§28-410.5.6 Issuance.** A certificate of competence or a license [~~, plate and/~~] or seal as a master
33 fire suppression piping contractor shall be issued only to an individual.

34 **§28-410.5.7 Duplication prohibited.** Not more than one license [~~, plate and/~~] or seal shall be
35 issued to an individual, and no individual shall make or cause to be made a duplicate of such
36 license [~~, plate~~] or seal.

37 [~~§28-410.6 Waiver of examinations. Any license issued without examination pursuant to an~~
38 ~~application filed prior to July 25, 1990 pursuant to the provisions of law in effect prior to July 1,~~
39 ~~2008 that has not lapsed as of July 1, 2008, shall be renewable pursuant to the provisions of this~~
40 ~~code.~~]

1 ~~§28-410.7~~ **§28-410.6 Surrender of license [~~,plate~~] and [~~/or~~] seal.** Upon the death or the retirement
2 of a licensed master fire suppression piping contractor, or upon the surrender, revocation or
3 suspension of his or her license, his or her license [~~,plate~~] and seal shall immediately be surrendered
4 to the commissioner. Nothing contained herein shall be construed to prevent the legal representative
5 of a deceased licensee, with the consent of the commissioner, from retaining such [~~plate and~~] seal
6 for the purpose of completing all unfinished work of such deceased licensee for which plans have
7 been approved and a permit issued, provided such work is performed by or under the direct and
8 continuing supervision of a licensed master fire suppression piping contractor and is completed
9 within one (1) year from the date of the death of the original licensee. Retired licensees and the legal
10 representatives of deceased licensees shall schedule for inspection, withdraw or have another
11 licensee re-file any open application filed under such license in accordance with department
12 procedures.

13 ~~§28-410.8~~ **§28-410.7 Master fire suppression piping contractor business required.** No
14 individual, corporation, partnership or other business association shall conduct a fire suppression
15 piping [~~contracting~~] contractor business in the city of New York, or employ the name “fire
16 suppression piping” in its business name, unless the business is a master fire suppression business
17 as follows:

- 18 1. No less than 51 percent of the control and voting capital stock of such fire suppression piping
19 [~~contracting~~] contractor business is owned by one or more individuals who are licensed
20 master fire suppression piping contractors [~~who cannot be terminated from the fire~~
21 ~~suppression piping contracting business by any person or entity~~], except as otherwise
22 provided; [~~and~~]
- 23 2. All fire suppression piping work performed by such entity is performed by or under the direct
24 and continuing supervision of such licensed master fire suppression piping contractor;
- 25 3. The person in charge of such work is such licensed master fire suppression piping contractor;
26 and
- 27 4. The persons actually performing such work are in the direct employ of such master fire
28 suppression piping contractor business as authorized by the code.

29 **Exception:** A company, corporation, partnership or other business association or its
30 predecessor that was engaged in fire suppression piping contractor work prior to January 25,
31 1990 may continue to do so in any one or more of such business forms without complying
32 with the foregoing, if (i) application was made to the department prior to July 25, 1990, and
33 (ii) necessary evidence was furnished on or prior to January 25, 1991, that such company,
34 corporation, partnership or other business association or its predecessor had employed an
35 average of 10 or more journeymen doing fire suppression piping contractor work for at least
36 five days a week for a period of ten (10) years or more out of the twenty 20 years preceding
37 July 25,1990, provided, that such business continues to have all fire suppression piping
38 contractor work conducted under the management and direct and continuing supervision of
39 a licensed master fire suppression contractor in the direct employ of such business and that
40 such licensed master fire suppression contractor is not otherwise interested in, associated
41 with or employed by any other licensed master fire suppression contracting business

1 operating in this city except as a joint venture in which such licensed master fire suppression
2 contractor's employer is one of the joint venturers.

3 ~~§28-410.8.1~~ **§28-410.7.1 Use.** Nothing herein contained shall be construed to prohibit the use
4 of a master fire suppression piping contractor license by the holder thereof for or on behalf of a
5 partnership, corporation or other business association, provided that such partnership,
6 corporation or other business is a master fire suppression piping contractor business.

7 ~~§28-410.8.2~~ **§28-410.7.2 Identification.** All business vehicles, advertising, websites and
8 stationery used in connection with a master fire suppression piping contractor business shall
9 display prominently the full name of the licensee, the words "N.Y.C. licensed fire suppression
10 piping contractor – class A, B or C," the licensee's number and the licensee's business address.
11 If the business is conducted under a trade name, or by a partnership or corporation, the trade
12 name, partnership or corporate name shall be placed immediately above the full name or names
13 of the licensed master fire suppression piping contractor or licensed master fire suppression
14 piping contractors ~~[to whom the plates were issued]~~. Prior to using, the trade name, partnership
15 or corporate name must have been disclosed to the department in a manner required by the
16 department.

17 ~~§28-410.8.3~~ **§28-410.7.3 Withdrawal of [licensee] license.** If a licensed master fire
18 suppression piping contractor withdraws from a master fire suppression piping contractor
19 business operating pursuant to such individual's license, the right of the business to perform fire
20 suppression piping work shall lapse if the provisions of this article are no longer satisfied. If a
21 licensed master fire suppression piping contractor's license is revoked or suspended, such
22 licensee will be deemed withdrawn from such business.

23 ~~§28-410.8.4~~ **§28-410.7.4 Ownership limitations.** An individual who is a licensed master fire
24 suppression piping contractor whose interest or ownership in a master fire suppression piping
25 contractor business constitutes any portion of the 51 percent interest or control required by this
26 section ~~[28-410.8] 28-410.7~~ shall be allowed to possess an interest or ownership in only one
27 other fire suppression piping contractor business where such interest or ownership would
28 constitute any portion of the 51 percent interest or control required by this section ~~[28-410.8]~~
29 28-410.7. Both fire suppression piping contractor businesses in which the licensed master fire
30 suppression piping contractor has an interest shall be located at the same place of business. For
31 the purposes of this section ~~[28-410.8] 28-410.7,~~ where two or more individuals who are licensed
32 master fire suppression piping contractors possess an interest or ownership in any master fire
33 suppression piping contractor business ~~[which] that~~ together represents more than 51 percent of
34 the interest or control of such entity, all of such licensees shall be deemed to possess a portion
35 of the 51 percent interest or control required by this section ~~[28-410.8] 28-410.7.~~

36 ~~§28-410.8.5~~ **§28-410.7.5 Joint ventures.** Nothing contained in this section ~~[28-410.8] 28-410.7~~
37 shall be construed to prevent a master fire suppression piping contractor business from entering
38 into a joint venture of limited duration for a particular project with another master fire
39 suppression piping contractor business. The terms of a joint venture must be in writing, and
40 documentation of the joint venture must be submitted to the department for approval prior to the
41 initiation of work under such venture.

1 ~~§28-410.8.6~~ **§28-410.7.6 Supervision.** The master fire suppression piping contractor shall
2 conduct his or her business to provide direct and continuing supervision in accordance with the
3 provisions of this ~~article~~ code.

4 ~~[Exception: The provisions of this section 28-410.8.6 shall not apply to minor alterations or~~
5 ~~ordinary repairs, as defined in this code, and/or to maintenance of a fire suppression piping~~
6 ~~system.]~~

7 ~~§28-410.9~~ **§28-410.8 Fitness to perform work.** As a condition of license renewal, a licensed
8 master fire suppression piping contractor shall provide evidence satisfactory to the department that
9 such licensee is fit to perform the work.

10 **ARTICLE 411**
11 **JOURNEYMAN FIRE SUPPRESSION PIPING**
12 **INSTALLER REGISTRATION**

13 **§28-411.1 Journeyman fire suppression piping installer registration** ~~[;—additional]~~
14 **qualifications.** ~~[Upon satisfactory completion of a New York state recognized training program or~~
15 ~~affirmation of an applicant's qualifications by an employer licensed master fire suppression piping~~
16 ~~contractor or, in the case of a city agency, a supervising licensed master fire suppression piping~~
17 ~~contractor and upon written stipulation of same by the applicant, the] The commissioner shall~~
18 ~~register an applicant as a journeyman fire suppression piping installer~~ who has such
19 ~~qualifications [shall reflect] reflecting~~ a progressive understanding, proficiency and competence in
20 the fire suppression piping trade, including:

- 21 1. A working familiarity with the code and technical standards with regard to fire suppression
22 piping, and the ability to apply the code requirements correctly;
- 23 2. The application of basic fire suppression theory and the utilization of trade skills on the job
24 site;
- 25 3. A working knowledge of the tools of the trade and the ability to utilize them properly; and
- 26 4. An ability to draft simple diagrams and interpret from drawings for the purpose of the fire
27 suppression piping work in which the applicant is engaged.

28 **§28-411.2 Experience.** The applicant for journeyman fire suppression piping installer registration
29 ~~[shall have a]~~ must demonstrate that he or she has a progressive understanding, proficiency and
30 competence in the fire suppression trade by having:

- 31 1. A minimum of five (5) years of full-time experience in the performance of fire suppression
32 piping work under the direct and continuing supervision of a licensed master fire suppression
33 piping contractor or equivalent, where at least one (1) year of such experience shall have
34 been in the city of New York [-]; or
- 35 2. Has satisfactorily completed a New York State recognized training program in fire
36 suppression piping.

1 **~~§28-411.3 [No required expiration, renewal or reissuance]~~ Registration need not be renewed.**
2 The registration for journeyman fire suppression piping installer shall have no expiration and shall
3 not require renewal or reissuance.

4 **~~§28-411.4 [Required statement]~~ Registration card.** The registration shall clearly state: “This
5 registration is NOT A LICENSE, and the holder is NOT AUTHORIZED TO PERFORM FIRE
6 SUPPRESSION PIPING WORK in New York city except under the direct and continuing
7 supervision of a Licensed Master Fire Suppression Piping Contractor.”

8 **ARTICLE 412**
9 **OIL-BURNING EQUIPMENT INSTALLER LICENSE**

10 **§28-412.1 Oil-burning equipment installer license required.** It shall be unlawful to install oil-
11 burning equipment in the city unless such work is performed by or under the direct and continuing
12 supervision of a person licensed as an oil-burning equipment installer under the provisions of this
13 article.

14 **~~§28-412.2 [Classifications. Oil-burning]~~ Use.** An oil-burning equipment installer [~~licenses shall be~~
15 ~~classified as follows:~~]

16 ~~[1. Class A oil-burning equipment installer license. Licenses the holder thereof]~~ license
17 permits the license holder to install any type of oil-burning equipment [~~, as an independent~~
18 ~~contractor with].~~ The license holder shall have full responsibility for the manner in which the
19 work is done, and for the material and equipment used, and for the control and direct and
20 continuing supervision of the persons employed on the work. Such equipment shall include,
21 but not be limited to, burners, boilers and generators.

22 ~~[2. Class B oil-burning equipment installer license. Licenses the holder thereof to install oil-~~
23 ~~burning equipment for the use of domestic fuel oils from number one fuel oil to and including~~
24 ~~number four fuel oil, as an independent contractor with full responsibility for the manner in~~
25 ~~which the work is done, for the materials and equipment used, and for the control and direct~~
26 ~~and continuing supervision of the persons employed on the work.]~~

27 **§28-412.3 Qualifications.** Applicants for an oil-burning equipment installer license shall [~~have the~~
28 ~~qualifications set forth in sections 28-412.3.1 through 28-412.3.2.~~]

29 ~~[\§28-412.3.1 Experience for Class A license. All applicants for a class A oil-burning equipment~~
30 ~~installer license shall]~~ submit satisfactory proof establishing that the applicant has had at least
31 four (4) years of practical experience, within the seven (7) years prior to application, in the
32 installation of oil-burning equipment under the direct and continuing supervision of a [~~Class A-~~
33 ~~] licensed oil-burning equipment installer in the city [~~, including at least one year experience in~~~~
34 ~~the installation of oil-burning equipment for the use of number five and number six fuel oils].~~

35 ~~[\§28-412.3.2 Experience for Class B license. All applicants for a class B oil-burning equipment~~
36 ~~installer license shall submit satisfactory proof establishing that the applicant has had at least~~
37 ~~three years practical experience within the five years prior to application in the installation of~~
38 ~~oil-burning equipment under the direct and continuing supervision of a licensed oil-burning~~
39 ~~equipment installer in the city.]~~

1 **§28-412.4 Fitness to perform work.** As a condition of license renewal [~~and reinstatement~~] , a
2 licensed oil-burning equipment installer shall provide evidence satisfactory to the department that
3 such licensee is fit to perform the work.

4 **§28-412.5 Oil-burning equipment installer place of business.** Every licensed oil-burning
5 equipment installer shall have a place of business within the city. A licensed oil-burning equipment
6 installer shall be a sole proprietor, a partner in the partnership or an officer of the corporation. A
7 licensed oil-burning equipment installer shall be allowed to associate his or her license with only one
8 other oil-burning business. Such businesses shall be located at the same place of business.

9 **§28-412.6 Seal.** At the time of issuance of an oil-burning equipment installer license and upon
10 payment of the required fee, the commissioner shall issue to the licensee a seal containing the full
11 name of the license holder and the words “licensed oil-burning equipment installer”. The license
12 holder shall not be entitled to perform work or hold himself or herself out as a licensed oil-burning
13 equipment installer until such seal has been obtained. The seal shall remain the property of the city
14 of New York. Upon revocation of an oil-burning equipment installer’s license or death of the licensee
15 or failure of a licensee to renew such license, the seal must be surrendered to the department. If the
16 seal is lost or stolen, and an affidavit is submitted by the licensee establishing such fact, a new seal
17 shall be issued upon application and payment of a fee.

18 **§28-412.6.1 Use of seal.** All documents that are required to be filed with any department or agency
19 of the city of New York shall bear the stamp of the seal as well as the signature of the licensee.
20 The licensed oil burner equipment installer performing the work and services shall personally sign
21 and seal all applications and other documents required to be filed by the department.

22 **ARTICLE 413**
23 **HIGH-PRESSURE BOILER**
24 **OPERATING ENGINEER LICENSE**

25 **§28-413.1 High-pressure boiler operating engineer license required.** It shall be unlawful to
26 operate any high-pressure boiler for any purpose whatsoever, in the city of New York or in connection
27 with any vessel on the waters in and around the city not subject to the jurisdiction of the United States,
28 unless such boiler is operated by or under the direct and continuing supervision and in the presence
29 of a person having a high-pressure boiler operating engineer license under the provisions of this
30 article.

31 **Exceptions:** A licensed high-pressure boiler operating engineer is not required to operate a high-
32 pressure boiler that meets all of the following conditions:

- 33 1. The boiler is a stand-alone boiler;
- 34 2. If the boiler is a steam boiler, the boiler has less than 100 square feet (9.3 m²) of heating
35 surface;
- 36 3. If the boiler is a steam boiler, it is capable of generating less than 1750 pounds (794 kg)
37 per hour of steam; or if the boiler is a hot water boiler, it is capable of generating less than
38 2 million btu/h of hot water;

- 1 4. The boiler has a safety relief valve setting of 200 psig (1379 kPa) or less;
- 2 5. The boiler room enclosure is in compliance with section 508 of the New York city building
- 3 code; and
- 4 6. There is a carbon monoxide detector in the boiler room interlocked with the boiler.

5 **§28-413.2 Qualifications.** Applicants for a high-pressure boiler operating engineer license shall
6 present satisfactory proof that:

- 7 1. Applicant [~~was employed as a fireman, oiler, general assistant, journeyman, boiler maker or~~
8 ~~machinist~~] has practical experience in the operation, maintenance, replacement,
9 modification, assembly, or repair of high pressure boilers under the direct and continuing
10 supervision of a licensed high-pressure boiler operating engineer in the city for a period of
11 not less than five (5) years within the seven (7) year period preceding the date of the
12 application; [~~however, in lieu of the experience requirement contained in this paragraph, an~~
13 ~~applicant for a high pressure boiler operating engineer license who is employed in a fossil~~
14 ~~fuel production plant located in the Rockaway Peninsula area of Queens county may submit~~
15 ~~satisfactory proof establishing that the applicant has obtained at least five years experience~~
16 ~~within the seven years preceding the date of the application which shall include at least two~~
17 ~~years of experience obtained during employment under the direct and continuing supervision~~
18 ~~of a licensed high pressure boiler operating engineer in a steam generating plant located~~
19 ~~outside of the city of New York but within the state of New York that is owned and operated~~
20 ~~by a licensed public utility company, and shall also include a separate period of at least three~~
21 ~~years of experience obtained comparable position as approved by the commissioner, in such~~
22 ~~steam generating plant;~~]
- 23 2. Applicant received a bachelor's degree in mechanical engineering from an accredited school
24 or college and had one (1) year of experience in the operation and maintenance of high-
25 pressure boilers under the direct and continuing supervision of a licensed high-pressure boiler
26 operating engineer [~~in the city~~] within the two (2) year period preceding the date of the
27 application;
- 28 3. Applicant has held, for a minimum of four (4) years, either a certificate as an engineer issued
29 by a board of examining engineers duly established and qualified pursuant to the laws of the
30 United States or any state or territory thereof, or a certificate as a marine engineer issued by
31 the United States Coast Guard [~~, and a~~]. In addition, an applicant shall have a minimum of
32 one (1) year of experience in the city in the operation and maintenance of stationary high-
33 pressure boiler plants under the direct and continuing supervision of a licensed high-pressure
34 boiler operating engineer within the seven (7) years preceding the date of the application [~~;~~
35 ~~provided that the applicant shall have filed with such application a signed statement that the~~
36 ~~applicant is the person named in said certificate together with the supporting signed~~
37 ~~statements by three licensed high pressure boiler operating engineers employed in the city of~~
38 ~~New York at the time of making of such signed statements];~~
- 39 4. Applicant exercised [~~direct and continuing~~] supervision, care, operation and maintenance
40 over a steam generating plant of a governmental building [~~having boilers~~] for a minimum of
41 five (5) years, within the seven (7) year period preceding the date of the application, with

1 each boiler having a minimum of 150 or more horsepower [~~for a minimum of five years and~~
2 ~~had a minimum of one~~]. One (1) year of such experience shall be on high-pressure boilers
3 under the direct and continuing supervision of a licensed high-pressure boiler operating
4 engineer in the city [~~within the seven year period preceding the date of the application~~];

5 5. Applicant successfully completed a New York state approved apprenticeship training
6 program of at least two (2) years, and after the completion of such program had at least three
7 (3) years' experience, within the seven (7) years preceding the date of the application, in the
8 operation and maintenance of high-pressure boilers in the city under the direct and continuing
9 supervision of a licensed high-pressure boiler operating engineer;

10 6. Applicant has held a Commission from the National Board of Boiler and Pressure Vessel
11 Inspectors for a period of seven (7) years, and has a minimum of five (5) years of high
12 pressure boiler operation, maintenance, and/or inspection experience under such commission
13 within the seven (7) year period preceding the application; or

14 [~~7. Applicant has held a Qualifications of High Capacity Fossil Fuel Operator (QFO) operator~~
15 ~~certification from ASME, and has a minimum of five years of high pressure boiler operation,~~
16 ~~maintenance, and/or inspection experience under such QFO certification within the seven~~
17 ~~year period preceding the application; or]~~

18 [~~8.~~] 7. Applicant has held a high pressure certification/high pressure license for a period of five
19 (5) years from other jurisdictions acceptable to the commissioner, provided such jurisdiction
20 follows the ASME Boiler and Pressure Vessel Code, and was employed under such
21 certification and/or license for a period of not less than five (5) of the last seven (7) years in
22 the operation, maintenance and/or inspection of high pressure boilers.

23 **§28-413.3 Fitness to perform work.** As a condition of license renewal [~~and reinstatement~~] , a
24 licensed high-pressure boiler operating engineer shall provide evidence satisfactory to the
25 department that such licensee is fit to perform the work.

26 [~~§28-413.4 Individuals holding portable high-pressure boiler operating engineer license on the~~
27 ~~effective date of this section.~~ Notwithstanding section 28-413.2, upon application, individuals who
28 hold a portable high-pressure boiler operating engineer license on the effective date of this section
29 may be issued a high-pressure boiler operating engineer license without examination. Such
30 application shall be deemed to be an application for renewal of a license pursuant to this chapter.]

31 **ARTICLE 414**
32 **RESERVED**

33 **ARTICLE 415**
34 **SIGN HANGER LICENSE**

35 **§28-415.1 Sign hanger license required.** It shall be unlawful to hoist or lower or to hang or attach
36 any sign upon or on the outside of any building or structure in the city unless such work is performed
37 by or under the direct and continuing supervision of a person licensed as a sign hanger under the
38 provisions of this article.

1 **§28-415.2 Exemptions.** The provisions of this article shall not apply to the following:

- 2 1. Signs not exceeding 75 square feet (7 m²) in area, measured on one face only, nor exceeding
3 25 pounds (11 kg) in weight;
- 4 2. Signs supported directly on the ground; or
- 5 3. Directional signs; or
- 6 4. Temporary signs erected during the construction or alteration of a building and related to
7 such work; or
- 8 5. The erection or placing of any signs by employees of the city, any city department or other
9 city agency.

10 **§28-415.3 Classification.** Such licenses shall be classified as follows:

- 11 1. **Master sign hanger license.** Authorizes the holder thereof to hoist or lower or to hang or
12 attach any sign, irrespective of weight, upon or on the outside of any building.
- 13 2. **Special sign hanger license.** Authorizes the holder thereof to hoist or lower or to hang or
14 attach any sign not exceeding one hundred fifty square feet in area, measured on one face
15 only, nor exceeding one thousand two hundred pounds in weight, upon or on the outside of
16 any building.

17 **§28-415.4 Additional qualifications.** Applicants for a sign hanger license shall have the additional
18 qualifications set forth in sections 28-415.4.1 through 28-415.4.2.

19 **§28-415.4.1 Master sign hanger qualifications.** All applicants for a master sign hanger license
20 shall submit satisfactory proof establishing that the applicant has at least five (5) years of
21 practical experience in sign hanging as a designated master sign hanging foreman within the
22 seven (7) years preceding the date of the license application under the direct and continuing
23 supervision of a licensed master sign hanger [~~;~~ ~~and the~~]. The applicant shall also have [a]
24 knowledge of and ability to read plans and specifications relating to sign construction and
25 erection, including supporting framework and other supports, and [a] knowledge of the problems
26 and practices of sign construction and hanging and be familiar with the equipment and tools used
27 in sign hanging.

28 **§28-415.4.2 Special sign hanger qualifications.** All applicants for a special sign hanger license
29 shall submit satisfactory proof establishing that the applicant has at least three (3) years of
30 practical experience in sign hanging as a designated special sign hanging foreman within the five
31 (5) years preceding the date of the license application under the direct and continuing supervision
32 of a licensed sign hanger [~~;~~ ~~and the~~]. The applicant shall also have [a] knowledge and ability to
33 read plans and specifications relating to sign construction and erection, including supporting
34 framework and other supports, and [a] knowledge of the problems and practices of sign
35 construction and hanging and be familiar with the equipment and tools used in sign hanging.

36 **§28-415.5 Additional requirements.** The additional requirements set forth in sections 28-415.5.1
37 through 28-415.5.2 shall apply to sign hangers:

- 1 9. Master fire suppression piping contractors licensed pursuant to this chapter; and
2 10. Master electricians licensed pursuant to subchapter one of chapter 3 of title 27 of the
3 administrative code.

4 **§28-416.3 Rules.** The commissioner shall promulgate rules for the proper and efficient
5 administration and enforcement of this article. Unless required by rule, a registered filing
6 representative shall not be required to take an examination or to complete continuing education
7 courses as a condition for renewal of the registration.

8 **ARTICLE 417**
9 **[BOARDS] RESERVED**

10 ~~[§28-417.1 Plumbing and fire suppression piping contractor license board. The commissioner~~
11 ~~shall appoint annually and may remove in his or her discretion each member of a plumbing and fire~~
12 ~~suppression piping contractor license board that shall have as its purpose the following:]~~

- 13 ~~[1. To advise the commissioner regarding the character and fitness of applicants for certificates~~
14 ~~of competence and licenses who have passed the required examination.]~~
- 15 ~~[2. To advise the commissioner regarding allegations of illegal practices on the part of licensed~~
16 ~~master plumbers, licensed master fire suppression piping contractors, master plumber~~
17 ~~businesses or master fire suppression piping businesses.]~~
- 18 ~~[3. To advise the commissioner regarding plumbing and fire suppression piping practices, code~~
19 ~~applications, regulations and legislation.]~~
- 20 ~~[4. To perform such other responsibilities as may be requested by the commissioner and as set~~
21 ~~forth in rules promulgated by the department.]~~

22 ~~[§28-417.1.1 Removal. The commissioner may remove any member of the license board and~~
23 ~~shall fill any vacancy therein.]~~

24 ~~[§28-417.1.2 Membership. Membership of the board shall consist of:]~~

- 25 ~~[1. Two officers or employees of the department;]~~
- 26 ~~[2. Five licensed master plumbers, three of whom shall be selected from nominees of the~~
27 ~~New York city contracting plumbing association whose members perform the largest~~
28 ~~dollar value of work within the city and one of whom shall be the holder of a class A or~~
29 ~~class B master fire suppression piping contractor license. The two remaining licensed~~
30 ~~master plumber board member positions shall be from the next largest plumbing~~
31 ~~association in the city of New York.]~~
- 32 ~~[3. Two licensed master fire suppression piping contractors, both of whom shall hold a class~~
33 ~~A license and shall be selected from nominees of the New York city sprinkler/fire~~
34 ~~suppression piping contractors association whose members perform the largest dollar~~
35 ~~value of work within the city;]~~
- 36 ~~[4. A registered journeyman plumber from the organization representing the largest number~~
37 ~~of registered journeyman plumbers;]~~

1 [5. A registered journeyman fire suppression piping installer from the organization
2 representing the largest number of registered journeyman fire suppression piping
3 installers;]

4 [6. An engineer having at least five years experience in the planning or design, and
5 installation, of plumbing systems;]

6 [7. An architect;]

7 [8. An engineer who is a full member of the society of fire protection engineers;]

8 [9. Two officers or employees of the fire department representing the fire commissioner;
9 and]

10 [10.— A real estate owner or manager or representative thereof.]

11 ~~§28-417.1.3 Organization of the board.~~ A member of the board who is an officer or employee
12 of the department representing the commissioner shall serve as chairperson and all members
13 shall serve without compensation. Nine members including the chairperson, who shall be entitled
14 to vote, shall constitute a quorum of the board for the transaction of business. In the absence of
15 a member or in the event of a vacancy, an alternate member of the board, may vote in the place
16 and stead of the member for whom he or she is the alternate or on account of whom the vacancy
17 exists. Alternate members shall be appointed and removed at the commissioner's discretion. All
18 actions shall be conducted by majority vote except as otherwise provided, and the board shall
19 keep minutes of its proceedings and records of its investigations. Except as otherwise determined
20 by the chairperson, the board shall meet at least once a month.]

21 ~~§28-417.1.4 Advisory and support personnel.~~ The board may request the commissioner to
22 appoint duly authorized representatives to conduct investigations and other activities incidental
23 to the functions of the license board. Such appointees shall be non voting members of the
24 committee to which they are appointed, and may include personnel who are not department
25 employees who shall serve without compensation. In addition the commissioner may designate
26 such employees of the department as the commissioner deems necessary to the service and
27 support of the license board.]

28 **ARTICLE 418**
29 **GENERAL CONTRACTOR REGISTRATION**

30 **§28-418.1 Requirement of registration.** ~~[On and after November 1, 2008, it]~~ It shall be unlawful
31 for a person to conduct business as a general contractor unless such person holds a general contractor
32 registration in accordance with the provisions of this article.

33 **§28-418.1.1 Expiration of registration.** A general contractor registration shall expire on the
34 third anniversary of such registration or such other date as determined by the commissioner by
35 rule so as to distribute the expiration dates of the registrations evenly over the course of a year.

36 **§28-418.2 Unlawful use of general contractor title.** ~~[On and after November 1, 2008, it]~~ It shall be
37 unlawful to use or cause to be used the title registered general contractor or any other title in a manner
38 as to convey the impression that an individual, corporation, partnership or other business entity, or
39 any person it employs, is a registered general contractor, unless such individual, corporation,
40 partnership or other business entity is registered in accordance with the provisions of this article.

1 **§28-418.3 Application requirements.** An application for a general contractor registration or
2 renewal shall be made in writing to the commissioner on a form provided by the department and
3 shall be accompanied by following:

- 4 1. If the applicant is an individual: the applicant's full name, residence address, business address
5 and business telephone number;
- 6 2. If the applicant is a corporation:
 - 7 2.1. The corporate name, address and telephone number of the applicant's principal office
8 or place of business;
 - 9 2.2. The date and state of incorporation;
 - 10 2.3. The name, residence address and residence telephone number of all corporate officers
11 and registered agents and any person owning an interest of ten percent or more in the
12 corporation;
 - 13 2.4. Proof that the corporation is in good standing under the laws of the state of New York;
- 14 3. If the applicant is a partnership:
 - 15 3.1. The name, address and telephone number of the applicant's principal office or place of
16 business;
 - 17 3.2. The name, residence address and residence telephone number of all partners;
- 18 4. The registration fee;
- 19 5. A verified statement that the applicant is financially solvent;
- 20 6. The name and address of the principal location from which the applicant has engaged in the
21 business of general contracting at any time within the last five (5) years;
- 22 7. If the applicant is not a sole proprietor, proof that the applicant is authorized to do business
23 in the state of New York;
- 24 8. Proof of insurance as required by section 28-401.9;
- 25 9. The name and address of the officer, principal or director of the applicant who is primarily
26 responsible for the registrant's compliance with the requirements of this code or any rule
27 adopted [~~there under~~] thereunder;
- 28 10. Any other information that the commissioner may require.

29 **§28-418.3.1 Financial solvency.** For the purposes of this article, financial solvency shall mean
30 that the applicant's operating capital shall exceed [~~twenty-five thousand dollars~~] \$25,000.

31 **§28-418.4 Warranties.** A warranty shall be provided to the buyer of a new one-, two- or three-
32 family structure that accords with the provisions of article [~~thirty-six-B~~] 36-B of the New York state
33 general business law, including the following:

- 34 1. One (1) year from and after the warranty date the home will be free from defects due to a
35 failure to have been constructed in a skillful manner;

2. Two (2) years from and after the warranty date the plumbing, electrical, heating, cooling and ventilation systems of the home will be free from defects due to a failure by the builder to have installed such systems in a skillful manner; and
3. Six (6) years from and after the warranty date the home will be free from material defects, including, but not limited to, any construction that is not in compliance with the building code or the zoning resolution of the city of New York.

§28-418.4.1 Modification prohibited. Except as otherwise provided in section [~~seven hundred seventy seven b~~] 777-b of [~~such~~] article [~~thirty six B~~] 360-B of the New York state general business law, no such warranty shall be modified or excluded in any way.

§28-418.5 Duties and responsibilities. The general contractor shall comply with sections 28-418.5.1 through 28-418.5.3.

§28-418.5.1 Subcontractor information. The general contractor shall be responsible for providing information to the department about his or her subcontractors and the particular work they perform on jobs for which the department has issued permits to the general contractor. Such information shall be provided in a format and at the times specified in the rules of the department.

§28-418.5.2 Technical reports. The general contractor shall maintain at the work site such technical reports as specified in the rules of the department and shall make such reports available to department personnel on request.

§28-418.5.3 Notice of pending disciplinary actions. The general contractor shall notify all of its suppliers of any pending suspension or revocation actions against such general contractor and shall provide an affidavit to the department stating that this notification has been made.

ARTICLE 419 SEIZURE AND FORFEITURE

§28-419.1 General. [~~On and after November 1, 2008~~] The vehicles and tools used in connection with unlicensed or unregistered activity at the work site of a new residential structure containing no more than three dwelling units shall be subject to seizure and forfeiture.

§28-419.2 Definitions. For purposes of this article, the following terms shall have the following meanings.

1. The term “owner” as applied to vehicles shall mean an owner as defined in section one hundred twenty-eight and in subdivision three of section three hundred eighty-eight of the vehicle and traffic law.
2. The term “security interest” as applied to vehicles shall mean a security interest as defined in subdivision k of section two thousand one hundred one of the vehicle and traffic law.
3. The term “unlicensed activity” shall mean the conduct of any activity at a work site for the construction of a residential structure containing no more than three dwelling units without a license for which a license is required under any law, rule or regulation enforced by the commissioner of buildings, and the term “unregistered activity” shall mean the conduct of any activity at a work site for the construction of a residential structure containing no more

1 than three dwelling units without a registration for which a registration is required under any
2 law or regulation enforced by the commissioner of buildings.

3 **§28-419.3 Seizure procedure.** The following provisions shall govern seizure of vehicles and tools
4 pursuant to this article.

5 **§28-419.3.1 Seizure.** Any police officer or authorized officer or authorized employee of the
6 department may seize any vehicle and any tools contained therein that such police officer or
7 authorized officer or authorized employee has reasonable cause to believe is being used in
8 connection with unlicensed or unregistered activity, upon service on the owner or operator of the
9 vehicle of a notice of violation for engaging in such activity. Any vehicle and tools seized
10 pursuant to this section shall be delivered into the custody of the department or other appropriate
11 agency.

12 **§28-419.3.2 Written demand.** The owner or operator of the vehicle and/or tools may make a
13 written demand for a hearing for the return of the seized property. Notice of the right to a hearing
14 shall be provided to the operator at the time of seizure of the vehicle and/or tools, and a copy of
15 such notice shall be sent by mail to the registered and/or title owner of the vehicle, if other than
16 the operator, and to the owner of the tools if other than the owner or operator of the vehicle and
17 if reasonably ascertainable, within five business days of the seizure. The department shall
18 schedule the hearing at the office of administrative trials and hearings (OATH) or its successor
19 agency, as applicable, for a date within ten business days after receipt of the demand and shall
20 notify the operator and the owner(s) of the opportunity to participate in the hearing and the date
21 thereof.

22 **§28-419.3.3 Claimant.** A claimant seeking release of the vehicle and tools at the hearing may be
23 either the person from whom the vehicle and tools were seized, if that person was in lawful
24 possession of the vehicle and tools, or the owner if different from such person.

25 **§28-419.3.4 Determination.** The OATH judge shall issue a determination within five business
26 days after the conclusion of the hearing.

27 **§28-419.3.5 Return pending hearing.** The department shall establish a procedure whereby an
28 owner or operator who wishes to have the vehicle and/or tools returned pending the hearing shall
29 post a bond in an amount determined by the department, but in no event less than an amount
30 sufficient to cover any applicable removal and storage fees as well as fines and penalties.

31 **§28-419.3.6 Return without hearing.** The department shall establish a procedure whereby an
32 owner or operator may request the return of the vehicle and/or tools without a hearing if such
33 owner or operator:

- 34 1. Establishes that the vehicle and/or tools were seized in error, or
- 35 2. Immediately applies for licensure or registration pursuant to the applicable provisions of
36 this code and pays an amount not to exceed removal and storage fees and any fines or
37 penalties that could have been imposed under the provisions of this code.

38 Where the owner or operator establishes that the vehicle and/or tools were seized in error,
39 the department shall expeditiously return such vehicle and/or tools.

1 **§28-419.4 Abandoned property.** Any vehicle and/or tools for which a written demand for return of
2 the vehicle and/or tools or for a hearing pursuant to section 28-419.3.2 has not been made within
3 [~~thirty~~] 30 days of service of the notice of violation on the operator of the vehicle and/or tools or
4 within [~~thirty~~] 30 days of service of the notice of violation on the owner of the vehicle and/or tools
5 if the owner is not the operator of the vehicle and/or tools shall be deemed abandoned and shall be
6 disposed of by the department pursuant to applicable law.

7 **§28-419.5 Combined hearings.** The department may choose to have the underlying violation
8 adjudicated before the office of administrative trials and hearings in accordance with sections 28-
9 419.5.1 through 28-419.5.3.

10 **§28-419.5.1 Combined hearing and determination.** Upon notice to the respondent, the
11 department may choose to have the violation underlying the seizure returnable to and heard at
12 OATH and may combine the hearing on the underlying violation with the hearing for the return
13 of the seized property. At such combined hearing, the OATH judge shall make a determination
14 as to both and may impose any penalty that could be imposed in a proceeding before the
15 environmental control board for the underlying violation. The OATH judge shall issue a
16 determination within five business days after the conclusion of the hearing.

17 **§28-419.5.2 Release following finding of no violation.** If the OATH judge finds that the vehicle
18 and/or tools were not used in connection with unlicensed or unregistered activity, the department
19 shall promptly release such vehicle and/or tools.

20 **§28-419.5.3 Release following finding of violation.** If the OATH judge finds that the vehicle
21 and/or tools were used in connection with unlicensed or unregistered activity, the department
22 may release such vehicle and/or tools upon payment of all applicable fines and civil penalties
23 and all reasonable costs of removal and storage, or may commence a forfeiture action within
24 twenty business days after the date of the judge's determination.

25 **§28-419.6 Separate hearings.** In the event that the adjudication of the violation underlying the
26 seizure is not held at OATH, and a determination is made that the vehicle and tools were not used in
27 connection with unlicensed or unregistered activity, the department shall promptly release such
28 vehicle and/or tools.

29 **§28-419.7 Forfeiture procedure.** The following provisions shall govern forfeiture of vehicles and
30 tools pursuant to this article.

31 **§28-419.7.1 Commencement of forfeiture.** A forfeiture action pursuant to this article shall be
32 commenced by the filing of a summons with a notice or a summons and complaint in accordance
33 with the civil practice law and rules. Such summons with notice or a summons and complaint
34 shall be served in accordance with the civil practice law and rules on the vehicle operator, the
35 owner of the tools, if different from the vehicle operator, and owner of the vehicle, and on all
36 owners of the subject vehicle listed in the records maintained by the department of motor
37 vehicles, or for vehicles not registered in the state of New York, in the records maintained by the
38 state of registration. Except as otherwise provided in this article, a vehicle and/or tools that are
39 the subject of such action shall remain in the custody of the department or other appropriate
40 agency pending the final determination of the forfeiture action.

1 **§28-419.7.2 Notice of forfeiture.** Notice of the institution of the forfeiture action shall be given
2 by certified mail to all persons holding a security interest in such vehicle or tools, if known, if
3 such security interest in the vehicle has been filed with the department of motor vehicles pursuant
4 to the provisions of title ten of the vehicle and traffic law, at the address set forth in the records
5 of such department, or, for vehicles not registered in the state of New York, all persons holding
6 a security interest in such vehicle if such security interest has been filed with the state of
7 registration and which persons are made known by such state to the department, at the address
8 provided by such state of registration.

9 **§28-419.7.3 Security interest.** Any person with a security interest in such vehicle or tools who
10 receives notice of the institution of the forfeiture action who claims an interest in such vehicle or
11 tools subject to forfeiture may assert a claim in such action for satisfaction of such person's
12 security interest in such vehicle or tools.

13 **§28-419.7.4 Forfeiture subject to security interest.** Forfeiture shall be made subject to the
14 interest of a person who claims an interest in the vehicle or tools, where such person establishes
15 that:

- 16 1. The use of the vehicle or tools for the conduct that was the basis for the seizure of the
17 vehicle and tools occurred without the knowledge of such person, or if such person had
18 knowledge of such use, that such person did not consent to such use by doing all that
19 could reasonably have been done to prevent such use, and that such person did not
20 knowingly obtain such interest in the vehicle or tools in order to avoid the forfeiture of
21 such vehicle or tools, or
- 22 2. The conduct that was the basis for such seizure was committed by any person other than
23 such person claiming an interest in the vehicle or tools, while such property was
24 unlawfully in the possession of a person who acquired possession thereof in violation of
25 the criminal laws of the United States or any state.

26 **§28-419.7.5 Disposition.** The department or agency having custody of the vehicle and tools, after
27 judicial determination of forfeiture, shall, at its discretion, either (i) retain such vehicle and tools
28 for the official use of the city; or (ii) by public notice of at least five days, sell such forfeited
29 vehicle and tools at public sale. The net proceeds of any such sale shall be paid into the general
30 fund of the city.

31 **§28-419.7.6 Amount of award.** In any forfeiture action commenced pursuant to this article,
32 where the court awards a sum of money to one or more persons in satisfaction of such person's
33 interest in the forfeited vehicle and tools, the total amount awarded to satisfy such interest or
34 interests shall not exceed the amount of the net proceeds of the sale of the forfeited vehicle and
35 tools after deduction of the lawful expenses incurred by the city, including reasonable costs of
36 removal and storage of the vehicle and tools between the time of seizure and the date of sale.

37 **ARTICLE 420**
38 **REQUIREMENT OF SAFETY REGISTRATION NUMBER**

39 **§28-420.1 Requirement of application for safety registration number.** [~~On and after October 1,~~
40 ~~2009, no~~] No safety registration recipient shall conduct business for the purposes that would qualify

1 the person as a safety registration recipient unless such person has received the required safety
2 registration number from the department.

3 **§28-420.2 Application requirements.** An application for a safety registration number shall be made
4 in writing to the commissioner on a form provided by the department and shall be accompanied by
5 the following:

- 6 1. If the applicant is an individual: the applicant's full name, residence address, business
7 address, and business telephone number, and an [~~email~~] electronic mail address for the receipt
8 of notifications;
- 9 2. If the applicant is a corporation:
 - 10 2.1. The corporate name, address, telephone number and [~~email~~] electronic mail address of
11 the applicant's principal office or place of business for the receipt of notifications;
 - 12 2.2. The date and state of incorporation;
 - 13 2.3. Proof that the corporation is in good standing under the laws of the state of New York;
- 14 3. If the applicant is a partnership:
 - 15 3.1. The name, address, telephone number and [~~email~~] electronic mail address of the
16 applicant's principal office or place of business for the receipt of notifications;
 - 17 3.2. The name and telephone number of all partners;
- 18 4. The name, telephone number and [~~e-mail~~] electronic mail address of all corporate officers
19 and registered agents and any person owning or controlling an interest of ten percent or more
20 in the applicant's business;
- 21 5. The name, address[;] and telephone number of any entity in which the applicant is an
22 employee, participates in the management of, or in which the applicant has a controlling
23 interest and which files for permits with the department [-];
- 24 6. The name and address of the principal location from which the applicant has engaged in the
25 business that would qualify it as a safety registration recipient at any time within the last five
26 (5) years;
- 27 7. If the applicant is not a sole proprietor, proof that the applicant is authorized to do business
28 in the state of New York;
- 29 8. Proof of insurance as required by Title 28 of this code and the rules of the department;
- 30 9. The name, address and [~~e-mail~~] electronic mail address of the officer, principal or director of
31 the applicant who is designated to receive official notices from the department;
- 32 10. The name, address and telephone number and [~~e-mail~~] electronic mail address of the
33 officer(s), principal(s) or director(s) of the applicant who should be contacted in the event of
34 an emergency; and
- 35 11. The commissioner shall waive the requirements of items one through seven of section 28-
36 420.2 for any applicant who has submitted a Vendex questionnaire to the [~~Mayor's Office of~~
37 ~~Contract Services~~] mayor's office of contract services within the previous three (3) years
38 provided that the questionnaire contains the information required by this article and who

1 provides a copy of the Vendex questionnaire to the department with such proof of submission
2 as the department may require.

3 **§28-420.3 Duties and [Responsibilities] responsibilities.** The recipient of a safety registration
4 number shall comply with the following requirements:

- 5 1. Subcontractor information. The recipient of a safety registration number shall maintain at
6 each work site the names, business addresses and contact information of the superintendent(s)
7 of the subcontractors who hold subcontracts with the prime contractor, as well as the
8 particular work they perform, and shall make such information available to department
9 personnel upon request;
- 10 2. Special inspection reports. The recipient of a safety registration number shall maintain at the
11 work site such special inspection reports as specified in the building code and shall make
12 such reports available to department personnel on request.

13 **§28-420.4 Submission of plan to reduce rate of immediately hazardous violations.** The
14 commissioner may require any safety registration recipient to provide the department with a plan to
15 improve its rate of immediately hazardous violations. The plan must be approved by the
16 [Department] department and may include such measures as employment of a safety compliance
17 officer to ensure compliance with the approved plan.

18 **§28-420.5 Submission of a report to the city council.** Within six months of the date by which all
19 safety registration recipients shall have been required by section 28-420.1 [~~of this article~~] to have a
20 safety registration number, the commissioner shall, after consultation with representatives of
21 affected industries, including but not limited to representatives and employers of building and
22 construction industry labor organizations and real estate owners, submit to the mayor and the city
23 council recommendations for the establishment of objective criteria on which the commissioner may
24 base a determination to commence a proceeding to suspend, revoke, or refuse to renew a safety
25 registration number as well as the data used in the analysis and formulation of such
26 recommendations. Within three months of the submission, the council shall review and may amend
27 this provision to incorporate standards for the revocation and non-renewal of a safety registration
28 number.

29 **§28-420.6 Expiration of safety registration number.** A safety registration number shall expire on
30 the third anniversary that such safety registration number was issued or such other date as determined
31 by the commissioner by rule so as to evenly distribute the expiration dates of the safety registration
32 numbers.

33 **§28-420.7 Unlawful use of safety registration number.** [~~On and after October 1, 2009, it~~] It shall
34 be unlawful to represent or cause to be represented that a person who would qualify as a safety
35 registration recipient has been issued a safety registration number by the department or to otherwise
36 convey the impression that an individual, corporation, partnership or other business entity, or any
37 person it employs, conducts business for the purposes that would qualify it as a safety registration
38 recipient that has been issued a safety registration number, unless such individual, corporation,
39 partnership or other business entity has received a safety registration number from the department
40 in accordance with the provisions of this article.

1 **ARTICLE 421**
2 **ELEVATOR AGENCY DIRECTOR LICENSE**

3 **§28-421.1 Elevator agency director license required.** It shall be unlawful to perform elevator work
4 as defined by this chapter or perform and/or witness inspections and tests or enter into contracts
5 pursuant to article 304 of chapter 3 of this code unless licensed pursuant to this article. Each elevator
6 agency shall designate one director in responsible charge who shall be licensed pursuant to this
7 article. The designated director in responsible charge shall be in the direct employ of the agency
8 and shall supervise all the operations of the agency. All elevator work shall be performed by
9 individuals who are under the direct and continuing supervision of the elevator agency director as
10 defined in section 28-401.3 of this ~~chapter~~ of this code. All elevator work performed by such
11 agency pursuant to article 304 of chapter 3 of this code shall be performed by or under the direct
12 and continuing supervision of the designated director in responsible charge.

13 **§28-421.1.1 Additional directors.** In addition to the designated director in responsible charge,
14 the agency may have other individuals in its employ who may be issued elevator agency director
15 licenses pursuant to this article.

16 **§28-421.2 Qualifications.** All applicants for an elevator agency director license shall submit
17 satisfactory proof establishing that the applicant has satisfactorily completed, within two (2) years
18 prior to the date of application, a course that is at least thirty (30) hours in length and approved by the
19 United States department of labor and the occupational safety and health administration in general
20 industry training; and also satisfies one of the following:

- 21 1. Has at least ten (10) years of practical experience in the supervision of the assembly,
22 installation, maintenance, repair, design or inspection of elevators within the fifteen (15) years
23 prior to application; or
- 24 2. Is an engineer or architect and has at least five (5) years of experience in the supervision of
25 the assembly, installation, maintenance, repair, review and approval of design documents or
26 inspection of elevators within the seven (7) years prior to application.

27 **§28-421.3 Restriction.** Each elevator agency director shall supervise and perform elevator work or
28 inspections and tests pursuant to article 304 of chapter 3 of this code for only one (1) elevator agency,
29 and shall not inspect and/or test elevators or perform elevator work on related devices as an inspector,
30 director or elevator agency helper for any other elevator agency.

31 **§28-421.4 Place of business.** Every licensed elevator agency shall have a place of business within
32 the city in conformance with department rules and regulations. A licensed private elevator inspection
33 agency director shall be allowed to associate his or her license with only one other private elevator
34 inspection agency. Such businesses shall be located at the same place of business.

35 **ARTICLE 422**
36 **ELEVATOR AGENCY INSPECTOR LICENSE**

37 **§28-422.1 Elevator agency inspector license required.** It shall be unlawful to witness and/or
38 perform inspections and tests on behalf of an elevator agency pursuant to article 304 of chapter 3 of
39 this code unless licensed pursuant to this article. Licensed inspectors shall perform such work under

1 the direct and continuing supervision of a designated director in responsible charge licensed pursuant
2 to article 421 of this chapter.

3 **§28-422.2 Qualifications.** All applicants for an elevator agency inspector license shall submit
4 satisfactory proof establishing that the applicant has satisfactorily completed, within two (2) years
5 prior to the date of application, a course that is at least ten (10) hours in length and approved by the
6 United States department of labor and the occupational safety and health administration in general
7 industry standards; and also satisfies the following:

8 1. Has at least seven (7) years of practical experience in the inspection of elevators, or as an
9 elevator mechanic within the ten (10) years prior to application.

10 **§28-422.3 Restriction.** Each elevator agency shall perform work pursuant to article 304 of chapter 3
11 of this code for only one elevator agency, and shall not witness and/or perform inspections and/or test
12 elevators or related devices as an inspector, technician or director for any other elevator agency.

13 **ARTICLE 423**
14 **QUALIFICATION FOR GAS WORK**

15 **§28-423.1 Qualification required.** For the purposes of this article, “gas work” means work covered
16 by section 101.2 of the New York city fuel gas code, where such work is required by this code to be
17 performed under the direct and continuing supervision of a licensed master plumber, provided that
18 the term “gas work” shall not include periodic inspections required pursuant to article 318 of chapter
19 3 of title 28 of the administrative code. On and after January 1, 2020, it shall be unlawful to perform
20 gas work unless such work is performed by:

- 21 1. A licensed master plumber; or
22 2. A person working under the direct and continuing supervision of a licensed master plumber if
23 such person:
24 2.1. Holds a gas work qualification pursuant to this article; or
25 2.2. Holds a limited gas work qualification pursuant to this article and is performing such
26 work under the [~~personal and immediate~~] direct supervision of (i) a person who holds a
27 gas work qualification pursuant to this article or (ii) a licensed master plumber.

28 **Exception:** The provisions of this article shall not apply to gas work performed, serviced and
29 maintained by utility corporations and subject to the jurisdiction of the New York state public
30 service commission.

31 **§28-423.2 Applications for gas work qualification.** [~~The commissioner shall issue gas work~~
32 ~~qualifications in accordance with sections 28-423.2.1 and 28-423.2.2.~~]

33 [~~§28-423.2.1 Applications for gas work qualification submitted before January 1, 2019. The~~
34 ~~commissioner shall issue a gas work qualification to a person who before January 1, 2019, submits~~
35 ~~satisfactory proof establishing that such person is a registered journeyman plumber pursuant to~~
36 ~~article 409 of this chapter.~~]

1 ~~§28-423.2.2 Applications for gas work qualification submitted on or after January 1, 2019.~~
2 The commissioner shall issue a gas work qualification to a person who ~~[on or after January 1,~~
3 ~~2019,]~~ submits satisfactory proof establishing that such person:

- 4 1. Has demonstrated an understanding of and proficiency and competency with gas work,
5 including (i) a working familiarity with the fuel gas code and the ability to apply the
6 requirements of such code correctly, (ii) the application of skills relating to gas work on
7 the job site, (iii) a working knowledge of the tools for gas work and the ability to utilize
8 such tools properly and (iv) an ability to draft simple diagrams and interpret from drawings
9 for the purpose of performing gas work, by satisfying a requirement that the commissioner
10 shall establish by rule; and
- 11 2. Satisfies one or more of the following:
 - 12 2.1. Such person is a registered journeyman plumber pursuant to article 409 of this
13 chapter;
 - 14 2.2. Such person successfully completed an apprenticeship in plumbing through a
15 program approved by the New York state department of labor and has at least one
16 (1) year of full-time experience performing or supervising plumbing work under the
17 direct and continuing supervision of a licensed master plumber; or
 - 18 2.3. Such person has at least five (5) years of full-time experience performing or
19 supervising plumbing work under the direct and continuing supervision of a licensed
20 master plumber, provided that at least one (1) year of such experience occurred in
21 the city.

22 ~~§28-423.2.3~~ **28-423.2.1 Concurrent applications.** The commissioner shall establish a
23 procedure for concurrently applying for a journeyman plumber registration pursuant to article 409
24 of this chapter and a gas work qualification pursuant to this section. No application fee shall be
25 charged to an applicant for a gas work qualification if such applicant (i) is, at the time such
26 application is filed, a registered journeyman plumber pursuant to such article or (ii) is applying
27 concurrently for a journeyman plumber registration pursuant to such article and a gas work
28 qualification.

29 **§28-423.3 Applications for limited gas work qualification.** ~~[The commissioner shall issue limited~~
30 ~~gas work qualifications in accordance with sections 28-423.3.1 and 28-423.3.2.]~~

31 ~~§28-423.3.1 Applications for limited gas work qualification submitted before January 1,~~
32 ~~2019.~~ The commissioner shall issue a limited gas work qualification to a person who before
33 January 1, 2019, submits satisfactory proof that such person has at least six months of full time
34 experience performing plumbing work under the direct and continuing supervision of a licensed
35 master plumber.]

36 ~~§28-423.3.2 Applications for limited gas work qualification submitted on or after January~~
37 ~~1, 2019.]~~ The commissioner shall issue a limited gas qualification to a person who ~~[on or after~~
38 ~~January 1, 2019]~~ submits satisfactory proof establishing that such person:

- 39 1. Has at least six months of full-time experience performing plumbing work under the direct
40 and continuing supervision of a licensed master plumber; and

1 2. Satisfies one or more of the following:

2 2.1. Such person has successfully completed a training program that (i) relates to gas
3 work, (ii) is at least sixteen (16) hours and (iii) is approved by the commissioner;

4 2.2. Such person is an apprentice in plumbing registered in an apprenticeship program
5 approved by the New York state department of labor; or

6 2.3. Such person satisfies such other requirement for demonstrating competence with gas
7 work as the commissioner may establish by rule.

8 **§28-423.4 Expiration.** The gas work qualification shall have no expiration and need not be renewed
9 or reissued. The limited gas work qualification shall expire five (5) years after issuance and may not
10 be renewed.

11 **ARTICLE 424**
12 **LIFT DIRECTOR REGISTRATION**

13 **§28-424.1 Lift director required.** It shall be unlawful for a crane or derrick that requires or
14 possesses a certificate of on-site inspection, or which, in accordance with rules promulgated by
15 the commissioner, is subject to supervision by a licensed master rigger in lieu of a certificate of
16 on-site inspection, to perform any of the following tasks unless a lift director is present at the site
17 during all times when:

18 1. The crane or derrick is picking a load;

19 2. The crane is traveling at the site, including but not limited to being moved onto or off of
20 cribbing or up or down a ramp;

21 3. The crane or derrick is being placed into a parked condition or otherwise being taken out
22 of service;

23 4. The crane's or derrick's boom/jib is being laid down or jackknifed;

24 5. The crane's or derrick's boom/jib is being raised from a laid down or jackknifed position;
25 or

26 6. Other special protective measures for wind are being installed or removed.

27 ~~[Exception:]~~ **Exceptions:** The requirement for a lift director does not apply to ~~[the]~~:

28 1. The assembly or disassembly of a crane or derrick, nor to the use of an assist crane or
29 derrick during assembly/disassembly, provided an assembly/disassembly director is
30 supervising the assembly/disassembly operation in accordance with rules promulgated
31 by the commissioner.

32 2. Dedicated pile drivers.

33 **§28-424.2 Registration required.** Eighteen months after the department has established the
34 requirements for the department-approved training course for lift directors as set forth in item 1 of
35 section 28-424.3, it shall be unlawful for any person to act as a lift director or to perform the duties
36 of a lift director unless such person is registered as a lift director pursuant to this article, or is
37 licensed as a master rigger pursuant to article 404 of this chapter, or is a master rigging foreman

1 designated in accordance with rules promulgated by the commissioner and acting as a lift director
2 under the direct and continuing supervision of the licensed master rigger.

3 **§28-424.3 Qualifications.** Applicants for a lift director registration shall submit satisfactory proof
4 establishing that the applicant:

5 1. Has successfully completed a department-approved training course for lift directing that is
6 at least 32 hours in length. Such lift directing training course shall cover topics relating to
7 mobile cranes, tower cranes, and derricks, including but not limited to roles and
8 responsibilities of site personnel, operational planning, weather warnings, conducting on-
9 site meetings, and log and reporting requirements. Successful completion of a lift directing
10 training course shall be based upon passage of a written exam, and evidenced by the
11 issuance of a certificate card that is in accordance with the provisions of item 2.5 of section
12 3316.9.2 of the New York city building code; and

13 2. Meets one of the following:

14 2.1. Possesses a valid certification as a lift director. The certification must be acceptable
15 to the commissioner and be issued by a lift director certification program that is
16 accredited by the National Commission for Certifying Agencies (NCCA) or the
17 American National Standards Institute (ANSI);

18 2.2. Has at least two (2) years' experience, within the three (3) years prior to application,
19 supervising rigging operations in New York city in accordance with section 3316.9.1
20 of the New York city building code;

21 2.3. Has been licensed as a New York city class A, class B, or class C hoisting machine
22 operator for at least three (3) years prior to application; or

23 [~~2.4. Is a master rigging foreman designated in accordance with rules promulgated by the~~
24 ~~commissioner; or~~]

25 [~~2.5.~~] 2.4. Such applicant has at least one (1) year of experience as a lift director in
26 New York city in accordance with rules promulgated by the commissioner, prior to
27 the date that registration as a lift director is required pursuant to section 28-424.2.

28 **ARTICLE 425**
29 **ELEVATOR AGENCY TECHNICIAN LICENSE**

30 **§28-425.1 Elevator agency technician license required.** It shall be unlawful to perform elevator
31 work as defined in this chapter, unless that work is performed by or under the direction of an elevator
32 agency technician and under the supervision of a designated director of an elevator agency licensed
33 pursuant to article 421 of this chapter.

34 **§28-425.2 Restricted elevator agency technician license.** A restricted class of lift mechanic license
35 shall be known as "accessibility technician". Such class of license shall be restricted to performing
36 work involving platform lifts including those installed in private residences which are covered by the
37 provisions of ASME [~~(American society of mechanical engineers) codes and standards~~] A18.1 [~~-~~
38 ~~2005~~]. An applicant for such restricted license [~~shall complete an application approved by the board~~
39 ~~and~~] shall have at least (3) three years of verified work experience in constructing, maintaining and
40 repairing those lifts covered by ASME A18.1 [~~-2005~~] and shall provide to the commissioner a

1 certificate of completion of an accessibility training program for lifts under the scope of A18.1 [-
2 2005] such as the certified accessibility training provided by the national association of elevator
3 contractors, or an equivalent program as [~~deemed~~] determined by the department.

4 **§28-425.3 Qualifications.** An applicant for an elevator agency technician license or a restricted
5 elevator agency technician license must possess a valid elevator mechanic’s license issued by the
6 New York state department of labor in accordance with the provisions of article 33 of the New York
7 state labor law. Such state license must remain valid during the term of the city license. The agency
8 may, by rule, establish qualifications for elevator agency technicians, including, but not limited to,
9 acceptable proof that an applicant has worked on elevator construction, maintenance or repair with
10 direct and [~~immediate~~] continuing supervision in this state for a specified period of time prior to the
11 effective date of this article; provided, however, that the provisions of this section and any rules
12 adopted pursuant thereto shall not be inconsistent with the requirements for elevator mechanics
13 contained in article [~~thirty-three~~] 33 of the New York state labor law and nothing herein shall prevent
14 the enactment by local law, ordinance, or rule of additional requirements.

15 **§28-425.4 Exemptions.** No elevator agency technician license shall be required for the outfitting,
16 removal, refinishing, or replacement of interior finishes, including wall panels, drop ceilings,
17 handrails and flooring, removal or replacement of interior lighting, recladding of doors, transoms and
18 front return panels, finishing or ornamental work on car operating panels.

19 **§28-425.5 Term of license.** The term of an elevator agency technician license and a restricted elevator
20 agency technician license shall be two (2) years.

21 **ARTICLE 426**
22 **ELEVATOR AGENCY HELPER**

23 **§28-426.1 Qualifications.** The agency may, by rule, establish qualifications for elevator agency
24 helpers.

25 **ARTICLE 427**
26 **PERMITS**

27 **§28-427.1 Applications and permits.** All applications/permits issued to elevator contractors shall
28 appear on the department of buildings website within forty-eight (48) hours of issuance. The
29 information required to be published must include, at a minimum, the date of issuance, the work
30 covered by the permit, the elevator contractor or contractors involved and location and type of work
31 to be performed. The department shall maintain and publish a registry of all licensed elevator agency
32 helpers, technicians, and inspectors, which shall list and identify, all licensed elevator agency helpers,
33 technicians, and inspectors, doing business in the city of New York. The department shall make the
34 registry available on its website.

35 **§28-427.2 Licensing and permitting exemptions.** Whenever an emergency exists in this state due
36 to a disaster or act of god, which imperils the health, safety or welfare of an individual or individuals
37 and placing such individual or individuals in imminent danger of injury or death and the number of
38 persons in the state holding licenses granted by the New York state elevator safety and standards
39 advisory board established by section 956 of article 33 of the New York state labor law is insufficient
40 to cope with such emergency, any person certified by a licensed elevator contractor to have an

1 acceptable combination of documented experience and education to perform elevator work without
2 direct and immediate supervision shall seek an emergency elevator mechanic's license from the
3 commissioner within five (5) business days after commencing work requiring a license. The
4 commissioner shall issue emergency elevator mechanic's licenses to address the emergency that
5 exists. The licensed elevator contractor shall furnish proof of competency as the commissioner may
6 require. Each such license shall recite that it is valid for a period of fifteen (15) days from the date
7 thereof and for such particular elevators or geographical areas as the commissioner may designate to
8 address the emergency and otherwise shall entitle the licensee to the rights and privileges of an
9 elevator mechanic's license issued in this article. The commissioner shall renew an emergency
10 elevator mechanic's license during the existence of an emergency as needed. No fee shall be charged
11 for any emergency elevator mechanic's license or renewal thereof.

12 **§28-427.3 License renewal.** The renewal of all licenses granted under the provisions of this section
13 shall be conditioned upon the submission of a certificate of completion of a course designed to ensure
14 the continuing education of licensees on new and existing national, state, and local conveyances codes
15 and standards and on technology and technical education and workplace safety. Such course shall
16 consist of not less than eight (8) hours annually and shall be completed preceding any such license
17 renewal. The commissioner shall establish requirements for continuing education and training
18 programs, and shall approve such programs, as well as maintain a list of approved programs, which
19 shall be made available to license applicants, permit applicants, renewal applicants and other
20 interested parties upon request. The commissioner shall promulgate rules and regulations setting forth
21 the criteria for approval of such programs, the procedures to be followed in applying for such
22 approval, and other rules and regulations as the commissioner deems necessary and proper to
23 effectuate the purposes of this section. The renewal of all licenses granted under the provisions of this
24 section shall be conditioned upon the submission of a certificate of completion of a course designed
25 to ensure the continuing education of licensees on new and existing regulations of the department.
26 Such course shall consist of not less than eight (8) hours of instruction that shall be attended and
27 completed annually prior to any such license renewal. The courses shall be taught through continuing
28 education providers that may include, but shall not be limited to, association seminars, and labor
29 training programs or programs that deliver an approved apprenticeship and are registered with the
30 department or the New York state apprenticeship training council. The commissioner shall approve
31 the continuing education providers.

32 **§28-427.4 Renewal fees.** The commissioner shall assess a fee for each training program completion
33 certificate and for each refresher training program completion certificate, provided, however, that in
34 no event shall the cost of such certificates be assessed by the sponsor of such training program against
35 the participants.

36 **§28-427.5 Recordkeeping.** All instructors shall be exempt from the requirements of the preceding
37 section with regard to their application for license renewal provided that such applicant was qualified
38 as an instructor at any time during the one (1) year immediately preceding the scheduled date for such
39 renewal. Approved training providers shall keep uniform records, for a period of six (6) years, of
40 attendance of licensees following a format approved by the commissioner and such records shall be
41 available for inspection by the commissioner at his or her request. Approved training providers shall
42 be responsible for the security of all attendance records and certificates of completion; provided,
43 however, that falsifying or knowingly allowing another to falsify such attendance records or

1 certificates of completion shall constitute grounds for suspension or revocation of the approval
2 required under this section.

3 **ARTICLE 428**
4 **CONSTRUCTION SUPERINTENDENT LICENSE**

5 **§28-428.1 License required.** It shall be unlawful to perform the duties and responsibilities of a
6 construction superintendent, as specified in chapter 33 of the New York city building code, unless
7 such work is performed by a person licensed as a construction superintendent under the provisions
8 of this article and department rules.

9 **§28-428.2 Qualifications.** All applicants for a construction superintendent license shall submit
10 satisfactory proof establishing that the applicant:

- 11 1. Has, within one (1) year prior to application, satisfactorily completed a course that is at
12 least forty-hours (40) in length and approved by the department in construction and
13 demolition site safety;
- 14 2. Possesses a valid Site Safety Training (SST) Supervisor Card; and
- 15 3. Either:
 - 16 3.1. Has at least three (3) years of experience, within the five (5) years prior to application,
17 serving as a full-time project supervisor with on-site responsibility over the
18 construction or demolition of buildings in the city of New York; or
 - 19 3.2. Has at least five (5) years of experience, within the eight (8) years prior to application,
20 serving as a full-time project supervisor with on-site responsibility over the
21 construction or demolition of buildings in the United States.

22 **§28-428.3 Previous registrants.** Individuals who, as of the effective date of this section, held a
23 valid registration as a construction superintendent in accordance with rules promulgated by the
24 commissioner shall be deemed to hold a license as a construction superintendent.

25 **§28-428.4 Fitness to perform work.** As a condition of license renewal, a licensed construction
26 superintendent shall provide evidence satisfactory to the department that such licensee is fit to
27 perform the work.

28 § 5. Item 1 of section 28-502.4 of the administrative code of the city of New York, as
29 added by local law number 33 for the year 2007, is amended to read as follows:

- 30 1. The list shall include all signs, sign structures and sign locations located (i) within a distance
31 of 900 linear feet (274 m) from and within view of an arterial highway; or (ii) within a
32 distance of 200 linear feet (60 960 mm) from and within view of a public park with an area
33 of 1/2 acre [~~(5000 m)~~] (2023 m²) or more.

34 § 6. Section 28-504.1 of the administrative code of the city of New York, as amended
35 by local law number 105 for the year 2016, is amended to read as follows:

1 **§28-504.1 Bicycle access to certain office buildings.** This section shall apply to buildings that
2 satisfy each of the following conditions: (i) the main occupancy of such building is offices that are
3 classified as occupancy group B, (ii) such building was in existence on December 11, 2009, or a
4 permit for such building has been issued on or before such date but such building has not yet been
5 completed, (iii) such building has a freight elevator that either complies with [~~ASME 17.1~~] ASME
6 A17.1 with regard to the carrying of passengers on freight elevators, as referenced in chapter 35 of
7 the New York city building code, or is operated by a freight elevator operator, and (iv) is not subject
8 to the bicycle parking provisions of sections 25-80, 36-70 and 44-60 of the New York city zoning
9 resolution. It shall be presumed that if a freight elevator is available for carrying freight, it is available
10 for carrying bicycles.

11 § 7. Section 28-504.1.1 of the administrative code of the city of New York, as
12 renumbered and amended by local law number 105 for the year 2016, is amended to read as follows:

13 **§28-504.1.1 Request for bicycle access.** The tenant or subtenant of a building to which this
14 section is applicable may request in writing, on a form provided by the department of
15 transportation, that the owner of such building complete a bicycle access plan in accordance with
16 section [~~28-504.1.2~~] 28-504.1.2 and provide bicycle access in accordance with such plan. Such
17 request shall include a certification by such tenant or subtenant that there is sufficient space
18 within such tenant’s or subtenant’s premises to store the requested number of bicycles in a
19 manner that does not violate the building or fire code or any other applicable law, rule or code,
20 or which would impede ingress or egress to such premises or building. Such request shall be sent
21 to such owner by certified mail, return receipt requested, and a copy of the request shall be filed
22 with the department of transportation.

23 § 8. Section 28-504.1.2 of the administrative code of the city of New York, as
24 renumbered and amended by local law number 105 for the year 2016, is amended to read as follows:

25 **§28-504.1.2 Bicycle access plan.** Bicycle access plans shall comply with sections 28-504.1.2.1
26 through [~~28-504.1.2.3~~] 28-504.1.2.4.

27 § 9. Items 1.2, 1.3 and 2 of section 28-504.1.2.2 of the administrative code of the
28 city of New York, as renumbered and amended by local law number 105 for the year 2016, are
29 amended to read as follows:

- 30 1.2. Bicycles will be allowed to be transported to and from such elevator along each
31 route that is used to transport freight to and from such elevator, to the extent
32 practicable and where such routes do not present substantial safety risks; [~~and~~]
- 33 1.3. No escort by building personnel will be required for a person transporting a
34 bicycle to or from such elevator if no such escort is required when a person is
35 transporting freight to or from such elevator; and

1 2. Provisions allowing bicycles to be brought in or out of such building using one or more
2 designated passenger elevators that the building owner may designate as temporary freight
3 elevators at any time when no freight elevator satisfying the conditions of item [~~2.4~~] 1 is
4 operational;

5 § 10. Section 28-504.6 of the administrative code of the city of New York, as added
6 by local law number 106 for the year 2016, is amended to read as follows:

7 **§28-504.6 Foldable bicycles on passenger elevators in residential buildings.** In any building
8 classified in occupancy group R, it shall be unlawful for an owner to bar a tenant or subtenant from
9 transporting a foldable bicycle on a passenger elevator provided that such bicycle is fully folded.
10 For purposes of this section, the term “foldable bicycle” means a bicycle designed to fold into a
11 compact assembly not exceeding 20 inches (508 mm) by 36 inches (914 mm) by 32 inches (813
12 mm).

13 § 11. The definitions of “low income housing” and “owner” in section 28-505.2 of
14 the administrative code of the city of New York, as added by local law number 1 for the year 2018,
15 are amended to read as follows:

16 **LOW INCOME HOUSING.** The term “low income housing” has the same meaning as in section
17 27-2093.1 of the New York city housing maintenance code [~~7~~].

18 **OWNER.** The term “owner” has the same meaning as in section 27-2004 of the New York city
19 housing maintenance code [~~7~~].

20 § 12. Section 28-505.6 of the administrative code of the city of New York, as added
21 by local law number 1 for the year 2018, is amended to read as follows:

22 **§28-505.6 Time period for approval or rejection of construction documents.** The time period in
23 which the commissioner is required to approve or reject an application for construction document
24 approval or resubmission thereof pursuant to this code shall commence from the date that the
25 commissioner receives the documents required pursuant to item 3 of section 28-505.4.

26 § 2. Chapter 1 of the New York city building code, as amended by local law
27 number 141 for the year 2013, section 107.11 as amended by and section 107.11.3 as added by
28 local law number 97 for the year 2017, section 110.3.7 as added by local law number 154 for the
29 year 2017, and section 107.9.2 as amended by local law number 195 for the year 2018, is
30 amended to read as follows:

- 1 3. Emergency preparedness and planning, including the orderly evacuation of occupants of
2 a building, structure or premises in the event of fire, explosion, biological, chemical or
3 hazardous material incident or release, natural disaster or other emergency, or the threat
4 thereof;
- 5 4. The prevention, mitigation and control of hazards to firefighters and emergency
6 responders during emergency operations; and
- 7 5. The operation and maintenance of any manual, automatic or other fire alarm or fire
8 extinguishing device, equipment or system.

9 **101.4.6 Energy.** The provisions of the *New York City Energy Conservation Code* shall apply to
10 all matters governing the design, construction and alteration of buildings for energy efficiency.

11 **SECTION BC 102**
12 **APPLICABILITY**

13 **102.1 General.** Where there is a conflict between a general requirement and a specific requirement,
14 the specific requirement shall govern. Where, in any specific case, different sections of this code
15 specify different materials, methods of construction or other requirements, the most restrictive shall
16 govern.

17 **102.2 Reserved.**

18 **102.3 Application of references.** References to chapter or section numbers, or to provisions not
19 specifically identified by number, shall be construed to refer to such chapter, section or provision of
20 this code.

21 **102.4 Referenced standards.** The standards referenced in this code and in the rules of the
22 department shall be considered part of the requirements of this code to the prescribed extent of each
23 such reference. Where differences occur between provisions of this code and referenced standards,
24 the provisions of this code shall apply. Refer to Article 103 of Chapter 1 of Title 28 of the
25 *Administrative Code* for additional provisions relating to referenced standards.

26 **102.4.1 Editions of referenced standards.** References to standards in this code shall be to the
27 editions of those standards provided for in Chapter 35 of this code, or as otherwise provided by
28 rule.

29 **102.5 Partial invalidity.** In the event that any part or provision of this code is held to be illegal or
30 void, this shall not have the effect of making void or illegal any of the other parts or provisions.

31 **102.6 Existing structures.** The legal occupancy of any structure lawfully in existence at the time of
32 the adoption or a subsequent amendment of this code shall be permitted to continue without change,
33 except as is otherwise specifically provided in this code or as is deemed necessary by the
34 commissioner for the general safety and welfare of the occupants and the public. Refer to Chapter 1
35 of Title 28 of the *Administrative Code* for additional provisions relating to existing structures.

1 **[105.5] 106.5 Foundation and earthwork permits.** In addition to the requirements of Chapter 1 of
2 Title 28 of the *Administrative Code* and Chapter 33 of this code, applications for foundation and
3 earthwork permits shall include:

- 4 1. **Notice to adjoining owners.** Proof of notice to adjoining owners as required by Section
5 3304.3.2.
- 6 2. **Liens.** Satisfactory evidence that the property is free from any lien for unpaid city taxes,
7 assessments, water rates, bail bonds, or judgments obtained by the city, together with consent
8 in writing of the mortgagee, if there is a mortgage upon the property, and the consent in
9 writing of the surrogate's court or supreme court, if the owner of the property is a minor or
10 incompetent.

11 **[105.5.1] 106.5.1 Notice to the department of commencement of foundation and earthwork.**
12 The foundation and earthwork permit shall be issued on the condition that the applicant will
13 provide written notice to the department at least 24 but no more than 48 hours prior to the
14 commencement of the foundation or earthwork as required by Section 3304.3.1.

15 **[105.6] 106.6 Full demolition permits.** In addition to the requirements of Chapter 1 of Title 28 of
16 the *Administrative Code* and Chapter 33 of this code, applications for full demolition permits shall
17 include:

- 18 1. **Utility certifications.** Certifications by the respective utility companies or governmental
19 agencies having jurisdiction that all gas, electric, water, steam and other service lines to the
20 building have been disconnected as required by Section 3303.2.5.
- 21 2. **Notice to adjoining owners.** Proof of notice to adjoining owners as required by Section
22 3306.3.2.
- 23 3. **Certification of rodent extermination.** Certification in accordance with department rules
24 that the building has been treated effectively for rodent extermination as required by Section
25 3306.9.13.

26 **[105.6.1] 106.6.1 Notice to department of commencement of demolition work.** The full
27 demolition permit shall be issued on the condition that the applicant will provide written notice
28 to the department at least 48 hours prior to the commencement of demolition work.

29 **[105.7] 106.7 Sign permits.** In addition to the requirements of Chapter 1 of Title 28 of the
30 *Administrative Code*, permits for the erection, alteration or installation of signs shall be subject to
31 the special provisions set forth in Sections ~~[105.7.1]~~ 106.7.1 through ~~[105.7.5]~~ 106.7.5.

32 **[105.7.1] 106.7.1 Identification number.** Every sign permit shall have an identification number.

33 **[105.7.2] 106.7.2 Changing copy or structural change of sign or sign structure.** The changing
34 of copy on a sign not permitted for changeable copy or any structural change of the sign or sign
35 structure shall require a new permit pursuant to this code.

36 **[105.7.3] 106.7.3 Permit does not constitute authorization for illegal sign.** The issuance of a
37 permit for the erection, alteration or installation of a sign or sign structure issued pursuant to this
38 code shall not be deemed to constitute permission or authorization to maintain a sign that would
39 otherwise be illegal without a maintenance permit for an outdoor sign if required pursuant to this

1 code and department rule or that is otherwise illegal pursuant to any other provision of law nor
2 shall any permit issued hereunder constitute a defense in an action or proceeding with respect to
3 such an unlawful sign.

4 **[105.7.4] 106.7.4 Name and business address of licensed sign hanger.** The application shall
5 contain the name and business address of the licensed sign hanger who is to perform or supervise
6 the proposed work.

7 **[105.7.5] 106.7.5 Outdoor advertising company.** If the sign or sign location is under the control
8 of an outdoor advertising company, as defined in Chapter 5 of Title 28 of the *Administrative*
9 *Code*, the application shall be accompanied by the name and, where provided by rule, the
10 registration number of such outdoor advertising company.

11 **[105.8] 106.8 Temporary construction [equipment] installation permits.** In addition to the
12 requirements of Chapter 1 of Title 28 of the *Administrative Code*, permits for the erection,
13 installation and use of temporary construction [equipment] installations shall be subject to the special
14 provisions set forth in Sections [105.8.1] 106.8.1 through [105.8.3] 106.8.3.

15 **[105.8.1] 106.8.1 Application.** The need for each specific item of temporary construction
16 [equipment] installation shall be stated on the application.

17 **[105.8.2] 106.8.2 Term of permit.** Notwithstanding any other provision of this code, a temporary
18 construction [equipment] installation permit shall expire 1 year from the date of issuance, or
19 when the permit holder's insurance or street obstruction bond expires, whichever is earlier. Such
20 permit shall be renewable. Such permit must be in effect at all times during which the
21 [equipment] temporary construction installation is at the work site.

22 **[105.8.3] 106.8.3 Special provisions for renewal of permit for a sidewalk shed.** An application
23 for the renewal of a temporary construction [equipment] installation permit for a sidewalk shed
24 used in connection with the alteration of a building shall be accompanied by a report, acceptable
25 to the department, prepared by a registered design professional who has examined that part of
26 the premises on which the work requiring the use of a sidewalk shed is being performed. Such
27 report shall document the condition of the applicable part of the premises and the scope of work
28 that has been performed thereon since the issuance of the permit and shall provide an estimate
29 of the additional time needed to complete the work.

30 **[105.9] 106.9 Mandatory sewer and catch basin work required by Section 24-526 of the**
31 ***Administrative Code*.** In addition to the requirements of Chapter 1 of Title 28, an applicant for a
32 permit who is required pursuant to Section 24-526 of the *Administrative Code* to construct or repair
33 defects in sewers or catch basins that lie outside the property shall submit certification from the
34 Department of Environmental Protection that the applicant or owner has provided the Department
35 of Environmental Protection with:

- 36 1. A performance bond or other security satisfactory to the Department of Environmental
37 Protection and approved as to form by the Law Department for the full cost, as estimated by
38 the Department of Environmental Protection, of constructing the part of the storm water
39 drainage system for such property which shall lay outside the property line and repairing
40 defects in such construction, if and as required by Section 24-526 of the *Administrative Code*;

- 1 2. Any license or other written instrument that the Department of Environmental Protection or
2 the Law Department may reasonably request that gives the Department of Environmental
3 Protection, its agents and contractors and the surety for a performance bond described in Item
4 1 above the legal right to enter private property to perform the work described in Item 1
5 above, pursuant to the terms of the performance bond or in accordance with the conditions
6 of acceptance of other security described in Item 1 above, and the legal right to connect to,
7 to extend or to discharge storm water into any private sewer authorized as a point of disposal
8 pursuant to Section 24-526 of the *Administrative Code*, in the event that the owner of property
9 fails to do so, if and as required pursuant to Section 24-526 of the *Administrative Code*;
- 10 3. Insurance of a kind and in an amount that the Department of Environmental Protection and
11 the Law Department deem satisfactory to insure the city fully for all risks of loss, damage to
12 property or injury to or death of persons to whomsoever occurring, arising out of or in
13 connection with the performance of all work described in this section.

14 **106.10 Permits with respect to limited alteration applications.** For permits with respect to
15 limited alteration applications, refer to Sections 28-101.5 and 28-104.6, Exception 1, of the
16 *Administrative Code*.

17 ~~[SECTION BC 106]~~
18 ~~[RESERVED]~~

19 **SECTION BC 107**
20 **CONSTRUCTION DOCUMENTS**

21 **107.1 General.** Construction documents shall comply with Chapter 1 of Title 28 of the
22 *Administrative Code*, this section and other applicable provisions of this code and its referenced
23 standards.

24 **107.2 Required construction documents.** In addition to the requirements of [~~Chapter 1~~] Article 104
25 of Title 28 of the *Administrative Code*, the applicant shall submit any and all of the documents
26 specified in Sections 107.3 through [~~107.15~~] 107.16 as appropriate to the nature and extent of the
27 work proposed.

28 **107.2.1 Composite plans.** Composite plans showing architectural, structural, and mechanical
29 parts and related energy use systems of a building may be submitted provided that a clear
30 understanding of each part and system is not impaired.

31 **107.2.2 Multiple building developments.** The same set of plans may be used for several
32 buildings of the same construction, if such buildings are located on adjoining lots under the same
33 ownership, and if applications for construction document approval for the lots are filed
34 simultaneously.

35 **107.3 Lot diagram.** The lot diagram shall show compliance with the *New York City Zoning*
36 *Resolution*, indicating the size, height, and location of the proposed construction including parking
37 and curb cuts; all existing structures on the zoning lot and their distances from lot and street lines;
38 the established grade and existing curb elevations; and the proposed final grade elevations of the site
39 shown by contours or spot grades at reasonable intervals. The lot diagram shall be drawn in
40 accordance with an accurate boundary survey to the city datum, made by a land surveyor, which

1 shall be attached to and form part of the application. A complete zoning analysis shall accompany
2 the lot diagram with citation to the relevant sections of the *New York City Zoning Resolution*.

3 **107.4 Building classification statement.** The statement shall identify:

- 4 1. The occupancy group or groups that apply to parts of the building in accordance with Section
5 302;
- 6 2. The occupancy group of the main use or dominant occupancy of the building;
- 7 3. The construction [~~class~~] type of the building in accordance with Section 602;
- 8 4. The structural occupancy/risk category in accordance with Table 1604.5;
- 9 5. The height of the building as defined in Section 502.1;
- 10 6. The applicable measurements to the highest and lowest level of Fire Department access;
- 11 7. Whether the building is inside or outside of the fire districts; [~~and~~]
- 12 8. Whether the building is inside or outside a flood hazard area; and
- 13 9. For multiple dwellings, the multiple dwelling classification as established by the *New York*
14 *State Multiple Dwelling Law*.

15 **107.5 Means of egress plans.** Floor and roof plans shall show compliance with the requirements of
16 Chapter 10, with sufficient notations indicating egress features and complete egress analysis as
17 required by this code.

18 **107.6 Architectural plans.** Construction documents for all buildings shall provide detailed drawings
19 of all architectural elements of the building showing compliance with the code, including but not
20 limited to doors, windows and interior finish schedules, details necessary to substantiate all required
21 fire-protection characteristics, details demonstrating compliance with the *New York City Energy*
22 *Conservation Code* and details demonstrating compliance with all accessibility requirements of this
23 code. [~~Site safety features shall be shown where applicable.~~] Plans shall also provide details of the
24 exterior wall envelope as required, including but not limited to flashing, insulation, vapor retarder,
25 intersections with dissimilar materials, corners, end details, control joints, intersections at roof, eaves
26 or parapets, means of drainage, water-resistive membrane and details around openings.

27 **Exception:** Where a curtain wall system is to be employed containing elements that are normally
28 detailed on shop or working drawings, approval of construction documents shall be conditioned
29 upon deferred submittal of such shop or working drawings showing the approval of the registered
30 design professional who prepared the architectural construction documents, or of a signed
31 statement by such registered design professional that such drawings were prepared to his or her
32 satisfaction. In such cases, submittal of construction documents showing compliance with the
33 *New York City Energy Conservation Code* related to such curtain wall may also be deferred.
34 Such deferred submittal of construction documents must demonstrate that the estimated annual
35 energy use for the envelope in the energy analysis submitted as part of the initial filing is not
36 exceeded.

1 **107.7 Structural plans.** Structural plans shall include the data and information described in this
2 section and in Chapter 16. Structural calculations shall be made available to the department upon
3 request.

4 **Exceptions:**

- 5 1. Where structural elements are normally detailed on shop or working drawings, approval
6 of construction documents shall be conditioned upon deferred submittal of such shop or
7 working drawings showing the approval of the registered design professional who
8 prepared the structural construction documents, or of a signed statement by such
9 registered design professional that such drawings were prepared to his or her satisfaction.
- 10 2. In cases where the detailing of structural elements has been made on the basis of fire-
11 resistance ratings, load tables, or similar data as given in manufacturer's catalogues,
12 approval of construction documents shall be conditional upon submission of a
13 manufacturer's designation attesting to the accuracy of the data and indicating that such
14 data were derived in conformance with the provisions of this code. Where the detailing
15 of structural elements has been made on the basis of data published in technical
16 documents of recognized authority issued or accredited by the agency or association
17 promulgating the applicable referenced standard, such manufacturer's designation will
18 not be required.

19 **107.7.1 Foundation plans.** Foundation plans shall show compliance with the requirements of
20 Chapter 18 of this code regarding foundation design and shall show the plan locations, design
21 loads, design elevations of the bottoms, and details as to sizes, reinforcements, and construction
22 of all footings, piers, foundation walls, pile groups, and pile caps. The foundation systems
23 shown on plans shall be of a type indicated in the geotechnical report required by Section
24 1803.6. The levels of footings of adjacent structures shall be indicated or, if the adjacent
25 structures are pile supported, this shall be stated. Where applicable, the plans shall include
26 underpinning details. In addition, there shall be a statement indicating the character and
27 minimum class of the soil strata required for the support of the foundation; the allowable soil
28 pressure used for the design of footings; and the character, class, and presumptive bearing
29 capacity of the bearing stratum to which piling is required to penetrate. The types and design
30 capacities of piling and the records of required borings or test pits shall also be shown. In
31 addition, foundation plans shall include insulation details as required by the *New York City*
32 *Energy Conservation Code.*

33 **107.7.2 Floor plans.** Floor plans and sections showing all structural requirements shall be
34 provided for all levels.

35 **107.7.3 Detailed drawings.** Drawings shall show sizes, sections, and locations of members, and
36 such other information as may be required to indicate clearly all structural elements and special
37 structural engineering features.

38 **107.7.4 Column schedules.** Column schedules shall show the design load contributed by the
39 framing at any level and the total accumulated design load at each level.

1 **107.7.5 Truss forces.** Where trusses are employed, a diagram or table shall indicate the loads or
2 moments in the various members under the design loading conditions. The requirement for a
3 diagram or table may be waived when the trusses consist of elements selected from load tables
4 or similar data, subject to the requirements for verification described in this code.

5 **107.7.6 Prestressing forces.** Where pre-stressed members are employed, a schedule or table shall
6 show the total prestressing forces and the method and sequence of application.

7 **107.8 Earthwork plans.** Where the application is sought solely for or includes earthwork,
8 excavation or fill operations, including but not limited to site decontamination, soil remediation and
9 grading, the applicant shall submit 1) a lot diagram showing the exact location of the lot and
10 dimensions to the nearest corner; and 2) plans showing the exact location, extent, and depth or height
11 of the proposed earthwork, excavation or fill operation and any existing utilities, foundations or other
12 infrastructure potentially impacted by the earthwork, excavation or fill operation. For excavation
13 operations, the plans shall also indicate the levels of footings of all adjacent structures or, if the
14 adjacent structures are pile supported, this shall be stated. Where applicable, the plans shall also
15 include underpinning details, soil information in accordance with Chapter 18, and a final grading
16 plan representing the lot after all earthwork, excavation or fill operations have been completed.

17 **107.9 Fire protection system plans.** Construction documents for fire protection systems shall
18 include a plot plan to scale indicating the location of the system in relation to the rest of the building
19 and shall comply with Sections 107.9.1 through 107.9.4. Such plans shall not be required in
20 connection with applications for limited standpipe alterations and limited sprinkler alterations.

21 **107.9.1 Sprinkler systems.** Sprinkler systems plans shall comply with Section 903.1.2.

22 **107.9.2 Alternative automatic fire-extinguishing systems.** Notwithstanding any other
23 provision of this code, design and installation documents for the installation of alternative
24 automatic fire-extinguishing systems shall be filed with and reviewed by the Fire Department for
25 compliance with this code, the *New York City Fire Code* and other applicable laws and
26 regulations in accordance with Section 105 of the *New York City Fire Code*.

27 **107.9.3 Standpipe systems.** Standpipe systems plans shall comply with Section 905.1.1.

28 **107.9.4 Fire alarm and detection systems.** Fire alarm and detection systems plans shall comply
29 with Section 907.1.1.

30 **107.10 Sign installation plans.** Construction documents for sign applications shall comply with
31 Section [~~H 105.2 in Appendix H~~] H105.2 of Appendix H.

32 **107.11 Discharge of sewage and discharge and/or management of stormwater runoff.**
33 Applications for construction document approval shall comply with Sections 107.11.1, 107.11.2
34 and 107.11.3.

35 **107.11.1 Sewage.** Applications for construction document approval shall include submittal
36 documents relating to the availability and feasibility of a public sanitary or public combined
37 sewer and/or other approved discharge for sewage in accordance with Sections 107.11.1.1 and
38 107.11.1.2 for the following types of applications:

- 1 1. New buildings that include any fixtures that produce sewage;
- 2 2. Alterations that require an increase in size to an existing sanitary or combined sewer
- 3 connection; and/or
- 4 3. Alterations requiring a new connection to a sanitary or combined sewer.

5 **107.11.1.1 Connection feasible and available.** Where a public sanitary or combined sewer
6 is certified by the Department of Environmental Protection or certified by an applicant in
7 accordance with rules of such department to be available and connection thereto feasible,
8 the applicant shall submit:

- 9 1. **Department of Environmental Protection certification of availability and**
10 **feasibility.** A sewer certification issued by the Department of Environmental
11 Protection that a public sanitary or combined sewer is available and connection
12 thereto is feasible. Applications for such certification shall be made to the
13 Department of Environmental Protection on forms specified by such department
14 (Department of Environmental Protection “house/site connection proposal
15 application” or other form as specified in the rules of such department) and shall be
16 reviewed and approved by such department in accordance with the rules of such
17 department. Such certification may be conditioned by such department on part or
18 all of the sewage to be disposed of with an on-site disposal system or with the use
19 of an alternative disposal system; or
- 20 2. **Applicant certification of availability and feasibility.** A certification submitted
21 by the applicant to the Department of Environmental Protection in accordance with
22 the rules of such department that a public sanitary or combined sewer is available
23 and connection thereto is feasible, in such cases where the availability and
24 feasibility of connection to a public sanitary or combined sewer are allowed to be
25 certified by the applicant pursuant to such rules. Such certification shall be on forms
26 specified by such department (Department of Environmental Protection “house/site
27 connection proposal application” or other form as specified in the rules of such
28 department).

29 **107.11.1.2 Connection not feasible or not available.** Where a public sanitary or combined
30 sewer is not available, or where connection thereto is not feasible, the applicant shall
31 submit:

- 32 1. **Department of Environmental Protection or applicant certification of**
33 **unavailability or non-feasibility.** (i) A certification issued by the Department of
34 Environmental Protection that a public sanitary or combined sewer is not available
35 or that connection to an available sewer is not feasible. Such certification shall be
36 on forms specified by such department (Department of Environmental Protection
37 “house/site connection proposal application” or other form as specified in the rules
38 of such department) or (ii) A certification submitted by the applicant to the
39 Department of Environmental Protection that a public sanitary or combined sewer
40 is not available or that connection thereto is not feasible, in such cases where the
41 availability and feasibility of connection to a public sanitary or combined sewer are

1 allowed to be certified by the applicant pursuant to the rules of such department.
2 Such certification shall be on forms specified by such department (Department of
3 Environmental Protection “house/site connection proposal application” or other
4 form as specified in the rules of such department); and

- 5 2. **On-site disposal.** A proposal for the design and construction of a system for the on-
6 site disposal of sewage conforming to the provisions of this code and other
7 applicable laws and rules including but not limited to minimum required distances
8 from lot lines or structures and subsoil conditions. Construction documents for such
9 system shall be subject to the approval of the department.

10 **107.11.2 Stormwater.** Applications for construction document approval shall include
11 submittal documents relating to the availability and feasibility of a public combined or storm
12 sewer or other approved method for stormwater discharge in accordance with Sections
13 107.11.2.1 and 107.11.2.2 for the following types of applications:

- 14 1. New buildings;
15 2. Alterations of buildings proposing horizontal building enlargement; and/or
16 3. Alterations that increase impervious surfaces on the tax lot.

17 **Exceptions:**

- 18 1. Applications for construction document approval for the alteration of an existing
19 one- or two-family dwelling need not include such submittal documents, where the
20 [~~area~~] footprint of a proposed horizontal building enlargement and any proposed
21 increase in impervious surfaces combined is less than or equal to 200 square feet
22 (19 m²). Construction documents shall include the amount of proposed increase in
23 impervious area.

24 1.1 This exception shall not apply if the horizontal building enlargement and
25 increase in impervious surface related to the current application for construction
26 document approval and any other enlargement or increase in impervious surface
27 made on the same tax lot after July 1, 2008 together exceed 200 square feet (19
28 m²).

- 29 2 Applications for construction document approval for the alteration of a building
30 need not include such submittal documents, where the [~~area of a~~] increase in area
31 of the footprint resulting from a proposed horizontal building enlargement and any
32 proposed increase in impervious surfaces on a lot combined is less than or equal to
33 1,000 square feet (93 m²), and on-site disposal of stormwater conforming to the
34 provisions of the applicable laws and rules as determined by the department is
35 proposed for such enlargement and/or increase in impervious surface. Construction
36 documents shall include the amount of proposed increase in impervious area.

37 2.1 This exception shall not apply where on-site disposal cannot be designed to
38 conform to the provisions of the applicable laws and rules including but not

1 limited to minimum required distances from lot lines or structures or subsoil
2 conditions as determined by the department.

3 2.2 This exception shall not apply if the horizontal building enlargement and
4 increase in impervious surface related to the current application for construction
5 document approval and all other enlargements or increases in impervious
6 surface made on the same tax lot after July 1, 2008 together exceed 1000 square
7 feet (93 m²).

8 **107.11.2.1 Connection feasible and available.** Where a public combined or storm sewer
9 is certified by the Department of Environmental Protection or certified by an applicant in
10 accordance with rules of such department to be available and connection thereto is feasible,
11 applicants shall submit:

12 1 **Department of Environmental Protection certification of availability and**
13 **feasibility.** A sewer certification issued by the Department of Environmental
14 Protection that a public storm or combined sewer is available and connection thereto
15 is feasible. Applications for such certification shall be made to the Department of
16 Environmental Protection on forms specified by such department (Department of
17 Environmental Protection “house/site connection proposal application” or other
18 form as specified in the rules of such department) and shall be reviewed and
19 approved by such department in accordance with the rules of such department. Such
20 certification may be conditioned by such department on part or all of the stormwater
21 runoff to be disposed of through an on-site detention or retention system, or by use
22 of alternative disposal methods including but not limited to ditches, swales or
23 watercourses; or

24 2 **Applicant certification of availability and feasibility.** A certification submitted
25 by the applicant to the Department of Environmental Protection in accordance with
26 the rules of such department that a public storm or combined sewer is available and
27 connection thereto is feasible, in such cases where the availability and feasibility of
28 connection to a public storm or combined sewer are allowed to be certified by the
29 applicant pursuant to such rules. Such certification shall be on forms specified by
30 such department (Department of Environmental Protection “house/site connection
31 proposal application” or other form as specified in the rules of such department).

32 **107.11.2.2 Connection not feasible or not available.** Where a public combined or storm
33 sewer is not available, or where connection thereto is not feasible, applicants shall submit:

34 1. **Department of Environmental Protection or applicant certification of**
35 **unavailability or non-feasibility.** (i) Certification issued by the Department of
36 Environmental Protection that a public storm or combined sewer is not available or
37 that connection thereto is not feasible. Such certification shall be on forms specified
38 by such department (Department of Environmental Protection “house/site
39 connection proposal application” or other form as specified in the rules of such
40 department); or (ii) Certification submitted by the applicant to the Department of
41 Environmental Protection that a public storm or combined sewer is not available or
42 that connection thereto is not feasible, in such cases where the availability and

1 feasibility of connection to a public storm or combined sewer are allowed to be
2 certified by the applicant pursuant to rules of such department. Certification shall
3 be on forms specified by such department (Department of Environmental Protection
4 “house/site connection proposal application” or other form as specified in the rules
5 of such department); and

- 6 2. **On-site disposal.** A proposal for the design and construction of a system for the on-
7 site disposal of stormwater conforming to the provisions of this code and other
8 applicable laws and rules including but not limited to minimum required distances
9 from lot lines or structures and subsoil conditions. Construction documents for such
10 system shall be subject to the approval of the department.

11 **107.11.3 Post-construction stormwater management facilities.** A post-construction
12 stormwater management facility that is constructed as part of a covered development project
13 shall comply with the rules of the Department of Environmental Protection and with this code.

14 **107.12 Predemolition photographs.** In addition to the requirements of Section 3306.3, construction
15 documents for full demolition shall comply with the following requirements for archival
16 photographs:

- 17 1. **Number required.** Applications shall contain two sets of photographs of the building or
18 buildings to be demolished or removed. Both sets shall be received by the department on
19 behalf of the New York City Landmarks Preservation Commission and the New York City
20 Municipal Archives Division of the Department of Records and Information Services.
- 21 2. **Format.** The photographs shall conform to the standards and specifications established by
22 rules promulgated by the commissioner upon the advice of the commissioner of the
23 Department of Records and Information Services and the chairperson of the Landmarks
24 Preservation Commission.

25 **Exception:** Applications made on behalf of the New York City Department of Housing
26 Preservation and Development or made pursuant to Article 215 of Chapter 2 of Title 28
27 of the *Administrative Code* are exempt from the requirements of this section.

28 **107.13 Energy efficiency plans.** Construction documents shall include compliance documentation
29 as required by the *New York City Energy Conservation Code*.

30 **107.14 Mechanical and fuel gas plans.** Construction documents for gas piping, heating, ventilation,
31 refrigeration and other mechanical work to be performed shall be submitted as per *New York City*
32 *Mechanical and Fuel Gas Codes*.

33 **107.15 Plumbing plans.** Construction documents for plumbing work to be performed shall be
34 submitted as per the *New York City Plumbing Code*.

35 **107.16 Flood zone compliance plans.** Flood zone compliance plans demonstrating compliance with
36 Appendix G shall be submitted with applications for construction document approval for projects
37 located within a flood hazard area, or where required by Appendix G.

1 **107.17 Retention of construction and submittal documents.** Refer to Section 28-104.12 of the
2 *Administrative Code.*

3 **107.18 Construction documents for extension or relocation of an existing chimney or vent.**
4 Where an owner of a new or altered taller building is required by Section 801 of the *New York City*
5 *Mechanical Code*, Section 501 of the *New York City Fuel Gas Code*, or Section 2113 of this code, to
6 extend, alter or relocate an existing chimney or vent on an affected building, the construction
7 documents for the new or altered taller building shall comply with the requirements of Section
8 107.18.1 of this code.

9 **107.18.1 Chimney and vent plan.** At the time of initial filing for construction, a chimney and
10 vent plan shall be included as part of the construction documents. Such chimney and vent plan
11 shall include the following information for all chimneys and vents within 100 feet (30 480 mm)
12 of construction:

- 13 1. A drawing identifying the location of each existing chimney and vent.
- 14 2. A chimney and vent schedule containing the following information for each chimney and
15 vent:
 - 16 2.1. The cross-sectional area of the chimney or vent outlet.
 - 17 2.2. The horizontal distance measured from the adjacent construction to the outlet
 - 18 2.3. The elevation of the outlet.
 - 19 2.4. The appliance, mechanical system, or fireplace to which the chimney or vent is
20 attached, including the flue gas temperature, or a notation that this information is not
21 yet known.
 - 22 2.5. If extension, alteration, or relocation is required and describing the expected work.
- 23 3. Calculations demonstrating which chimneys and vents require no alteration based on the
24 termination requirements including but not limited to those found in Section 503.5.4 of
25 the *New York City Fuel Gas Code* and Section 801.20 of the *New York City Mechanical*
26 *Code*.

27 **SECTION BC 108**
28 **TEMPORARY STRUCTURES AND USES**

29 **108.1 General.** Refer to Chapter 1 of Title 28 of the *Administrative Code*.

30 **SECTION BC 109**
31 **FEEES**

32 **109.1 Payment of fees.** Refer to Chapter 1 of Title 28 of the *Administrative Code*.

1 **110.3.5 Energy code compliance inspections.** Inspections shall be made to determine
2 compliance with approved construction documents.

3 **110.3.6 Other inspections.** In addition to the inspections specified above, the commissioner is
4 authorized to make or require other inspections of any construction work to ascertain compliance
5 with the provisions of this code and other laws that are enforced by the department.

6 **110.3.7 Tenant protection plan compliance inspections.** For buildings undergoing work for
7 which a tenant protection plan is required by Article 120 of Title 28 of the *Administrative Code*,
8 inspections shall be made by the department to determine compliance with the tenant protection
9 plan.

10 **110.4 Special inspections.** Special inspections required by this code or by the commissioner shall
11 be performed by special inspection agencies.

12 **110.5 Final inspection.** Refer to Article 116 of Chapter 1 of Title 28 of the *Administrative Code*.

13 **110.6 Issuance of certificate of compliance.** Upon satisfactory inspection of service equipment and
14 the satisfaction of all the requirements for sign-off, the department shall issue a certificate of
15 compliance as applicable for the following service equipment:

- 16 1. Elevators;
- 17 2. Escalators;
- 18 3. Moving walkways;
- 19 4. Heating systems; and
- 20 5. Dumbwaiters.

21 **110.7 Approved inspection agencies.** Refer to Articles 114 and 115 of Chapter 1 of Title 28 of the
22 *Administrative Code*.

23 **110.8 Inspection requests.** Refer to Chapter 1 of Title 28 of the *Administrative Code*.

24 **110.9 Satisfactory inspection report required.** Portions of work requiring inspection may be
25 sequenced or phased to allow continuing progress of that work provided that work shall not be done
26 beyond the point indicated in each successive required inspection for that phase. The inspector shall
27 either indicate the portion of the construction that is satisfactory as completed, or notify the permit
28 holder or the superintendent of construction wherein the same fails to comply with this code. Any
29 portions that do not comply shall be corrected and such portion shall not be covered or concealed
30 until corrected. The person performing the inspection shall complete a report of satisfactory
31 inspection. Refer to Chapter 1 of Title 28 of the *Administrative Code*.

32 **SECTION BC 111**
33 **CERTIFICATE OF OCCUPANCY**

34 **111.1 General.** Refer to Chapter 1 of Title 28 of the *Administrative Code*.

1
2
3
4
5
6
7
8
9
10
11
12
13
14
15
16
17
18
19
20
21
22
23
24
25
26
27
28
29
30
31
32

**SECTION BC 112
SERVICE UTILITIES**

112.1 General. Refer to Chapter 1 of Title 28 of the *Administrative Code*.

**SECTION BC 113
RESERVED**

**SECTION BC 114
VIOLATIONS**

114.1 General. Refer to Chapter 2 of Title 28 of the *Administrative Code*.

**SECTION BC 115
STOP WORK ORDER**

115.1 General. Refer to Chapter 2 of Title 28 of the *Administrative Code*.

**SECTION BC 116
UNSAFE STRUCTURES AND EQUIPMENT**

116.1 General. Refer to Chapters 2 and 3 of Title 28 of the *Administrative Code*.

§ 3. Chapter 2 of the New York city building code, is REPEALED and a new chapter

2 is added to read as follows:

CHAPTER 2
DEFINITIONS

SECTION BC 201
GENERAL

201.1 Scope. Unless otherwise expressly stated, the following words and terms shall, for the purposes of this code, have the meanings shown in this chapter.

201.2 Interchangeability. Words used in the present tense include the future; words stated in the masculine gender include the feminine and neuter; the singular number includes the plural and the plural, the singular.

201.3 Terms defined in other codes. Where terms are not defined in this code and are defined in the *New York City Fuel Gas Code, New York City Fire Code, New York City Mechanical Code, New York City Electrical Code, New York City Plumbing Code, or the New York City Energy Conservation Code*, such terms shall have the meanings ascribed to them as in those codes.

201.3.1 Terms defined in the general administrative provisions. The following terms are defined in Section 28-101.5 of the *Administrative Code*:

1968 BUILDING CODE.

1 **1968 OR PRIOR CODE BUILDINGS OR STRUCTURES (PRIOR CODE**
2 **BUILDINGS).**

3 **ACCEPTANCE OR ACCEPTED.**

4 **ADDITION.**

5 **ADMINISTRATIVE CODE.**

6 **ALTERATION.**

7 **APPROVAL OR APPROVED.**

8 **APPROVED AGENCY.**

9 **APPROVED FABRICATOR.**

10 **APPROVED INSPECTION AGENCY.**

11 **APPROVED TESTING AGENCY.**

12 **ARCHITECT.**

13 **BUILDING.**

14 **CHARTER.**

15 **CERTIFICATE OF COMPLIANCE.**

16 **CITY.**

17 **COMMISSIONER.**

18 **CONSTRUCTION DOCUMENTS.**

19 **DAY.**

20 **DEFERRED SUBMITTAL.**

21 **DEMOLITION.**

22 **DEMOLITION, FULL.**

23 **DEMOLITION, PARTIAL.**

24 **DEPARTMENT.**

25 **ENGINEER.**

26 **ENLARGEMENT.**

1 **ENVIRONMENTAL CONTROL BOARD or ECB.**
2 **EXISTING BUILDING OR STRUCTURE.**
3 **FABRICATED ITEM.**
4 **FIRE PROTECTION PLAN.**
5 **HEREAFTER.**
6 **HERETOFORE.**
7 **INTERIM CERTIFICATE OF OCCUPANCY.**
8 **INSPECTION CERTIFICATE.**
9 **LABEL.**
10 **LABELED.**
11 **LAND SURVEYOR.**
12 **LANDSCAPE ARCHITECT.**
13 **LETTER OF COMPLETION.**
14 **LIMITED ALTERATION APPLICATION.**
15 **LIMITED OIL-BURNING APPLIANCE ALTERATIONS.**
16 **LIMITED PLUMBING ALTERATIONS.**
17 **LIMITED SPRINKLER ALTERATIONS.**
18 **LIMITED STANDPIPE ALTERATIONS. Category 2**
19 **LISTED.**
20 **MAIN USE OR DOMINANT OCCUPANCY (OF A BUILDING).**
21 **MANUFACTURER'S DESIGNATION.**
22 **MARK.**
23 **MATERIALS.**
24 **OCCUPANCY.**
25 **OWNER.**

1 **PARTY WALL.**
2 **PERMIT.**
3 **PERSON.**
4 **PREMISES.**
5 **PRIOR CODE BUILDING.**
6 **PROFESSIONAL CERTIFICATION.**
7 **PROGRESS INSPECTION.**
8 **PROJECT.**
9 **REGISTERED DESIGN PROFESSIONAL.**
10 **REGISTERED DESIGN PROFESSIONAL OF RECORD.**
11 **REQUIRED.**
12 **RETAINING WALL.**
13 **SERVICE EQUIPMENT.**
14 **SIGN-OFF.**
15 **SINGLE ROOM OCCUPANCY MULTIPLE DWELLING.**
16 **SPECIAL INSPECTION.**
17 **SPECIAL INSPECTION AGENCY.**
18 **SPECIAL INSPECTOR.**
19 **STRUCTURE.**
20 **SUBMITTAL DOCUMENTS.**
21 **SUPERINTENDENT OF CONSTRUCTION (CONSTRUCTION**
22 **SUPERINTENDENT).**
23 **USE (USED).**
24 **UTILITY COMPANY OR PUBLIC UTILITY COMPANY.**
25 **UTILITY CORPORATION OR PUBLIC UTILITY CORPORATION.**
26 **WORK NOT CONSTITUTING MINOR ALTERATIONS OR ORDINARY REPAIRS.**

1 1. The person responsible for conducting such training confirms the identification of the person
2 taking such training in a manner established by the department.

3 2. While such training is being conducted, the site of such training is actively observed by or on
4 behalf of the person responsible for conducting such training.

5 3. Such training complies with any other requirements the department establishes by rule.

6 **ADHERED MASONRY VENEER.** Veneer secured and supported through the adhesion of an
7 approved bonding material applied to an approved backing.

8 **ADJUSTMENT (SCAFFOLD).** The calibration or modification of a scaffold, including any part or
9 component, that does not meet the definition of installation, removal, repair, maintenance, or use, and
10 does not constitute normal use or operation of the scaffold.

11 **AEROSOL.** A product that is dispensed from an aerosol container by a propellant, classified as
12 follows:

13 **Level 1.** Aerosol products with a total chemical heat of combustion that is greater than 0 and less
14 than or equal to 8,600 British thermal units per pound (Btu/lb) (20 kJ/g).

15 **Level 2.** Aerosol products with a total chemical heat of combustion that is greater than 8,600
16 Btu/lb (20 kJ/g), but less than or equal to 13,000 Btu/lb (30 kJ/g).

17 **Level 3.** Aerosol products with a total chemical heat combustion that is greater than 13,000 Btu/lb
18 (30 kJ/g).

19 **AGGREGATE.** In roofing, crushed stone, crushed slag or water-worn gravel used for surfacing for
20 roof coverings.

21 **AGRICULTURAL, BUILDING.** A structure designed and constructed to house farm implements,
22 hay, grain, poultry, livestock or other horticultural products. This structure shall not be a place of
23 human habitation or a place of employment where agricultural products are processed, treated or
24 packaged, nor shall it be a place used by the public.

26 **AIR-INFLATED STRUCTURE.** A structure that uses air-pressurized membrane beams, arches or
27 other elements to enclose space. Occupants of such a structure do not occupy the pressurized area
28 used to support the structure.

29 **AIR-SUPPORTED STRUCTURE.** A building wherein the shape of the structure is attained and
30 maintained by elevated air pressure and occupants of the structure are within the elevated pressure
31 area. Air-supported structures are of two basic types:

32 **Double skin.** Similar to a single skin, but with an attached liner that is separated from the outer
33 skin and provides an airspace which serves for insulation, acoustic, aesthetic or similar purposes.

- 1 **Single skin.** Where there is only the single outer skin and the air pressure is directly against that
2 skin.
- 3 **AISLE.** An unenclosed exit access component that defines and provides a path of egress travel.
- 4 **AISLE ACCESSWAY.** That portion of an exit that leads to an aisle.
- 5 **ALARM NOTIFICATION APPLIANCE.** A fire alarm system component such as a bell, horn,
6 speaker, light or text display that provides audible, tactile or visible outputs, or any combination
7 thereof.
- 8 **ALARM SIGNAL.** A signal indicating an emergency requiring immediate action, such as a signal
9 indicative of fire.
- 10 **ALARM VERIFICATION FEATURE.** A feature of automatic fire detection and alarm systems to
11 reduce unwanted alarms wherein smoke detectors report alarm conditions for a minimum period of
12 time, or confirm alarm conditions within a given time period, after being automatically reset, in order
13 to be accepted as a valid alarm-initiation signal.
- 14 **ALLOWABLE STRESS DESIGN.** A method of proportioning structural members, such that
15 elastically computed stresses produced in the members by nominal loads do not exceed specified
16 allowable stresses (also called "working stress design").
- 17 **ALTERNATE LOAD PATH.** A secondary or redundant load path capable of transferring the load
18 from one structural element to other structural elements.
- 19 **ALTERNATE LOAD PATH METHOD.** A design approach that accounts for an extreme event by
20 providing alternate load paths for elements that are no longer able to carry load. In an alternate load
21 path design, key elements are considered notionally removed, one at a time, and the structure is
22 designed to transfer the loads from the removed element to other structural elements, as required by
23 Section 1617.
- 24 **ALTERNATING TREAD DEVICE.** A device that has a series of steps between 50 and 70 degrees
25 (0.87 and 1.22 rad) from horizontal, usually attached to a center support rail in an alternating manner
26 so that the user does not have both feet on the same level at the same time.
- 27 **AMBULATORY CARE FACILITY.** Buildings or portions thereof used to provide medical,
28 surgical, psychiatric, nursing or similar care on a less than 24-hour basis to individuals who are
29 rendered incapable of self-preservation by the services provided.
- 30 **ANCHOR BUILDING.** An exterior perimeter building of a group other than H having direct access
31 to a covered mall building but having required means of egress independent of the mall.
- 32 **ANCHORED MASONRY VENEER.** Veneer secured and supported through the adhesion of an
33 approved bonding material applied to an approved backing.
- 34 **ANIMAL SERVICE FACILITY.** The following facilities where animals are sheltered on a 24-hour
35 basis: animal hospitals, kennels, pounds, veterinary clinics and pet shops.

- 1 **ANNULAR SPACE.** The opening around the penetrating item.
- 2 **ANNUNCIATOR.** A unit containing one or more indicator lamps, alphanumeric displays or other
3 **equivalent means in which each indication provides status information about a circuit, condition or**
4 **location.**
- 5 **APARTMENT.** A dwelling unit providing permanent provisions for both sanitation and kitchen
6 **facilities, occupied or arranged to be occupied by not more than one family maintaining a common**
7 **household.**
- 8 **APARTMENT, STUDENT.** An apartment occupied or arranged to be occupied by students enrolled
9 **at a single accredited college or university and maintaining a common household pursuant to a lease,**
10 **sublease, or occupancy agreement directly with such college or university.**
- 11 **ARCHITECTURAL TERRA COTTA.** Plain or ornamental hard-burned modified clay units, larger
12 **in size than brick, with glazed or unglazed ceramic finish.**
- 13 **AREA (Masonry).**
- 14 **Gross cross-sectional.** The area delineated by the out-to-out specified dimensions of masonry in
15 **the plane under consideration.**
- 16 **Net cross-sectional.** The area of masonry units, grout and mortar crossed by the plane under
17 **consideration based on out-to-out specified dimensions.**
- 18 **AREA, BUILDING.** The area included within surrounding exterior walls (or exterior walls and
19 **firewalls) exclusive of vent shafts and courts. Areas of the building not provided with surrounding**
20 **walls shall be included in the building area if such areas are included within the horizontal projection**
21 **of the roof or floor above.**
- 22 **AREA OF RESCUE ASSISTANCE.** An area where persons unable to use stairways can remain
23 **temporarily to await instructions or assistance during emergency evacuation.**
- 24 **AREA OF SPORT ACTIVITY.** That portion of an indoor or outdoor space where the play or
25 **practice of a sport occurs.**
- 26 **AREAWAY.** A space below grade adjacent to a building open to the outer air and enclosed by walls.
- 27 **ARTICULATING BOOM CRANE.** A crane whose boom consists of a series of folding, pin
28 **connected structural members, typically manipulated to extend or retract by power from hydraulic**
29 **cylinders.**
- 30 **ASPECT RATIO.** The height of any portion of a building divided by its least dimension at the
31 **elevation from which the height is being measured.**
- 32 **ASPHALT.** A dark brown to black bitumen pitch that melts readily and which appears in nature in
33 **asphalt beds or is produced as a by-product of the petroleum industry.**

- 1 **ASPHALT CONCRETE or ASPHALT PAVING.** A mixture of liquid asphalt and graded
2 aggregate used as a paving material.
- 3 **ASSEMBLY SPACE.** Any part of a place of assembly, exclusive of the stage, that is occupied by
4 numbers of persons during the major period of occupancy. Every tier of seating shall be considered a
5 separate assembly space.
- 6 **ASSISTED RESCUE PATH.** A portion of the accessible means of egress which begins at the area
7 of rescue assistance and terminates at the public way.
- 8 **ATRIUM.** An opening connecting two or more stories other than enclosed stairways, elevators,
9 hoistways, escalators, plumbing, electrical, air-conditioning or any other vertical openings that are
10 not required to be enclosed by other provisions of this code, which is closed at the top and not defined
11 as a mall. Stories, as used in this definition, do not include balconies within assembly groups or
12 mezzanines that comply with Section 505.
- 13 **ATTIC.** The space between the ceiling beams of the top story and the roof rafters.
- 14 **AUDIBLE ALARM NOTIFICATION APPLIANCE.** A notification appliance that alerts by the
15 sense of hearing.
- 16 **AUGERED-CAST-IN-PLACE PILES.** Augered-cast-in-place piles are constructed by pumping
17 grout into an augered hole during the withdrawal of the auger. The pile is reinforced with a single
18 reinforcing bar, a reinforcing steel cage or a structural steel section.
- 19 **AUTOCLAVED AERATED CONCRETE (AAC).** Low-density cementitious product of calcium
20 silicate hydrates, whose material specifications are defined in ASTM C 1386.
- 21 **AUTOMATIC.** As applied to fire protection devices, a device or system providing an emergency
22 function without the necessity for human intervention and activated as a result of a predetermined
23 temperature rise, rate of temperature rise and/or the presence of combustion products.
- 24 **AUTOMATIC FIRE-EXTINGUISHING SYSTEM.** An approved system of devices and
25 equipment that automatically detects a fire and discharges an approved fire-extinguishing agent onto
26 or in the area of a fire.
- 27 **AUTOMATIC SMOKE DETECTION SYSTEM.** A fire alarm system that has initiation devices
28 that utilize smoke detectors for protection of an area such as a room or space with detectors to provide
29 early warning of fire.
- 30 **AUTOMATIC SPRINKLER SYSTEM.** A fire suppression or control device that operates
31 automatically when its heat-activated element is heated to its thermal rating or above, allowing water
32 to discharge over a specified area.
- 33 **AUTOMATIC WATER MIST SYSTEM.** A system consisting of a water supply, a pressure source,
34 and a distribution piping system with attached nozzles, which, at or above a minimum operating
35 pressure defined by its listing, discharges water in fine droplets meeting the requirements of NFPA
36 750 for the purpose of the control, suppression or extinguishment of a fire. Such systems include wet-

1 pipe, dry-pipe and pre-action types. The systems are designed as engineered, pre-engineered, local-
2 application or total flooding systems.

3 **AVERAGE AMBIENT SOUND LEVEL.** The root mean square, A-weighted sound pressure level
4 measured over a 24-hour period, or the time any person is present, whichever time period is less.

5 **AWNING.** An architectural projection that provides weather protection, identity or decoration and
6 is wholly supported by the building to which it is attached. An awning is comprised of a lightweight
7 frame structure over which a covering is attached.

8 **AXIS OF ROTATION.** The vertical axis around which the crane superstructure rotates.

9 **AXLE.** The shaft or spindle with which or about which a wheel rotates. On truck and wheel mounted
10 cranes, it refers to a type of axle assembly including housing, gearing, differential, bearings, and
11 mounting appurtenances.

12 **A-ZONE.** An area of special flood hazard without high-velocity wave action. When not shown on
13 the FIRMS, the water surface elevation may be determined from available data by the registered
14 design professional of record in accordance with Section G103.3. See also “Area of special flood
15 hazard.”

16 **BACKING.** The wall or surface to which the veneer is secured.

17 **BALCONY, EXTERIOR.** An exterior floor projecting from and supported by a structure without
18 additional independent supports.

19 **BALED COTTON.** A natural seed fiber wrapped in and secured with industry accepted materials,
20 typically consisting of burlap, woven polypropylene, polyethylene or cotton or sheet polyethylene,
21 secured with wire or bands. The term baled cotton includes lint removed from the cottonseed (linters)
22 and residual materials from the ginning process (motes).

23 **BALED COTTON, DENSELY PACKED.** Baled cotton with a packing density of not less than 22
24 pounds per cubic foot (360 kg/m³). A bale of densely packed baled cotton typically measures 55
25 inches (1397 mm) in length, 21 inches (533.4 mm) in width, and 27.6 to 35.4 inches (701 to 899 mm)
26 in height.

27 **BALLAST.** In roofing, ballast comes in the form of large stones or paver systems or light-weight
28 interlocking paver systems and is used to provide uplift resistance to components of the roof assembly
29 systems that are not adhered or mechanically attached to the roof deck.

30 **BARRICADE (EXPLOSIVE).** A structure or other artificial or natural barrier constructed in
31 connection with the storage, handling and use of explosives that is designed to withstand the rapid
32 release of energy in an explosion and provides a shield from the impact of such explosion. A straight
33 line from the top of any sidewall of a building containing explosives to the eaveline of any magazine
34 or other building or to a point 12 feet (3658 mm) above the center of a railway shall pass through
35 such barrier.

36 **Artificial barricade.** An artificial mound or revetment, including a barrier constructed of
37 sandbags, with a minimum thickness of 3 feet (914 mm).

- 1 **Natural barricade.** Terrain or other natural features of the ground.
- 2 **BARRIER, TEMPORARY.** An approved temporary fence, permanent fence, the wall of a
3 permanent structure, any other structure, or any combination thereof that prevents access to the
4 swimming pool by any person not engaged in the installation or construction of the swimming pool
5 during its installation or construction.
- 6 **BASE FLOOD.** The flood having a 1-percent chance of being equaled or exceeded in any given year.
- 7 **BASE FLOOD ELEVATION.** The elevation of the base flood, including wave height, as specified
8 on FEMA FIRMs 360497 or as determined in accordance with Section G103.3. In areas designated
9 as ZONE AO, the base flood elevation shall be the elevation of the highest existing grade of the
10 building's perimeter plus the depth number (in feet) specified on the flood hazard map.
- 11 **BASE (MOUNTING).** The traveling base on which the rotating superstructure of a crawler crane is
12 mounted.
- 13 **BASEMENT.** A story partly below the grade plane and having less than one-half its clear height
14 (measured from finished floor to finished ceiling) below the grade plan (see "Story" and "Story above
15 grade plane"). A basement shall be considered a story above grade plane.
- 16 **BASEMENT (FOR FLOOD ZONE PURPOSES).** The portion of a building having its floor
17 subgrade (below ground level) on all sides. This definition of "Basement" is limited in application to
18 the provisions of Appendix G.
- 19 **BEARER (PUTLOG).** A horizontal transverse scaffold member (which may be supported by legs
20 or runners) upon which the scaffold platform rests and joins scaffold uprights, posts, poles, and similar
21 members.
- 22 **BED JOINT.** The horizontal layer of mortar on which a masonry unit is laid.
- 23 **BIRD HAZARD INSTALLATIONS.** Monolithic glazing installations that provide a clear line of
24 sight on the exterior of buildings, including, but not limited to, glass awnings, glass handrails and
25 guards, glass wind break panels, or glass acoustic barriers.
- 26 **BLEACHERS.** Tiered seating supported on a dedicated structural system and two or more rows high
27 and is not a building element (see "Grandstand").
- 28 **BOARDER (ROOMER, LODGER).** A person who pays a consideration for living within the
29 household and does not occupy such space as an incident of employment.
- 30 **BOILING POINT.** The temperature at which the vapor pressure of a liquid equals the atmospheric
31 pressure of 14.7 pounds per square inch (psia) (101 kPa) or 760 mm of mercury. Where an accurate
32 boiling point is unavailable for the material in question, or for mixtures which do not have a constant
33 boiling point, for the purposes of this classification, the 20-percent evaporated point of a distillation
34 performed in accordance with ASTM D 86 shall be used as the boiling point of the liquid.

- 1 **BOOM (CRANE OR DERRICK).** A section or strut, of which the heel (lower end) is affixed to a
2 base, carriage, or support, and whose upper end supports a cable and sheaves where the load is lifted
3 by means of rope and a hook.
- 4 **BOOM POINT.** The outer extremity of the crane boom, containing the hoist sheave assembly.
- 5 **BRACED WALL LINE.** A straight line through the building plan that represents a location of the
6 lateral resistance provided by wall bracing.
- 7 **BRACED WALL PANEL.** A full-height section of wall constructed to resist in-plane shear loads
8 through interaction of framing members, sheathing material and anchors. The panel's length meets
9 the requirements of its particular bracing method and contributes toward the total amount of bracing
10 required along its braced wall line.
- 11 **BRAKE.** A device used for retarding or stopping motion.
- 12 **BREAKAWAY WALL.** An open lattice wall subject to flooding that is not required to provide
13 structural support to a building or other structure and that is designed and constructed such that, under
14 base flood or lesser flood conditions, it will collapse under specific lateral-loading forces in such a
15 way that (i) it allows the free passage of floodwaters, and (ii) it does not damage the structure or the
16 supporting foundation system.
- 17 **BREAKOUT.** For revolving doors, a process whereby wings or door panels can be pushed open
18 manually for means of egress travel.
- 19 **BRICK.**
- 20 **Calcium silicate (sand lime brick).** A pressed and subsequently autoclaved unit that consists of
21 sand and lime, with or without the inclusion of other materials.
- 22 **Clay or shale.** A solid or hollow masonry unit made of clay or shale, usually formed into a
23 rectangular prism, then burned or fired in a kiln; brick is a ceramic product.
- 24 **Concrete.** A concrete masonry unit made from portland cement, water, and suitable aggregates,
25 with or without the inclusion of other materials.
- 26 **BUCKET HOIST.** A power or manually operated bucket that (i) is temporarily installed at a
27 construction or demolition site, (ii) moves vertically on guide members to raise or lower material, and
28 (iii) is controlled from a point outside the conveyance.
- 29 **BUILDING ELEMENT.** A fundamental component of building construction, listed in Table 601,
30 which may or may not be of fire-resistance-rated construction and is constructed of materials based
31 on the building type of construction.
- 32 **BUILDING, ENCLOSED.** A building that does not comply with the requirements for open or
33 partially enclosed buildings.
- 34 **BUILDING LINE.** The line established by law, beyond which a building shall not extend, except
35 as specifically provided by law.

1 **BUILDING, LOW-RISE.** Enclosed or partially enclosed buildings that comply with the following
2 conditions:

- 3 1. Mean roof height, h , less than or equal to 60 feet (18 288 mm).
- 4 2. Mean roof height, h , does not exceed least horizontal dimension.

5 **BUILDING, OPEN.** A building having each wall at least 80 percent open. This condition is
6 expressed for each wall by the equation:

$$7 \quad A_o \geq 0.8A_g \quad \text{(Equation 2-1)}$$

8 where:

9 A_o = Total area of openings in a wall that receives positive external pressure, in square feet (m²).

10 A_g = The gross area of that wall in which A_o is identified, in square feet (m²).

11 **BUILDING, PARTIALLY ENCLOSED.** A building that complies with both of the following
12 conditions:

- 13 1. The total area of openings in a wall that receives positive external pressure exceeds the sum
14 of the areas of openings in the balance of the building envelope (walls and roof) by more than
15 10 percent; and
- 16 2. The total area of openings in a wall that receives positive external pressure exceeds 4 square
17 feet (0.37 m²) or 1 percent of the area of that wall, whichever is smaller, and the percentage
18 of openings in the balance of the building envelope does not exceed 20 percent. These
19 conditions are expressed by the following equations:

$$20 \quad A_o > 1.10A_{oi} \quad \text{(Equation 2-2)}$$

$$21 \quad A_o > 4 \text{ square feet (0.37m}^2\text{) or } > 0.01A_g, \text{ whichever is smaller, and } A_{oi}/A_{gi} \leq 0.20$$

$$22 \quad \text{(Equation 2-3)}$$

23

1 where:

2 A_o, A_g are as defined for an open building.

3 A_{oi} = The sum of the areas of openings in the building envelope (walls and roof) not
4 including A_o , in square feet (m^2).

5 A_{gi} = The sum of the gross surface areas of the building envelope (walls and roof) not
6 including A_g , in square feet (m^2).

7 **BUILDING, SIMPLE DIAPHRAGM.** A building in which wind loads are transmitted through floor
8 and roof diaphragms to the vertical lateral-force-resisting systems.

9 **BUILDING-INTEGRATED PHOTOVOLTAIC (BIPV) PRODUCT.** A building product that
10 incorporates photovoltaic modules and functions as a component of the building envelope.

11 **BUILDINGS AND OTHER STRUCTURES, FLEXIBLE.** Buildings and other structures that
12 have a fundamental natural frequency less than 1 Hz.

13 **BUILT-UP ROOF COVERING.** Two or more layers of felt cemented together and surfaced with a
14 cap sheet, mineral aggregate, smooth coating or similar surfacing material.

15 **BULKHEAD.** An enclosed rooftop structure enclosing a shaft, stairway, tank or service equipment,
16 or other space not designed or used for human occupancy.

17 **CABARET.** Any room, place or space in which any musical entertainment, singing, dancing or other
18 similar amusement is permitted in connection with an eating and drinking establishment.

19 **CABLE-RESTRAINED, AIR-SUPPORTED STRUCTURE.** A structure in which the uplift is
20 resisted by cables or webbings that are anchored to either foundations or dead men. Reinforcing cable
21 or webbing is attached by various methods to the membrane or is an integral part of the membrane.
22 This is not a cable-supported structure.

23 **CABLEWAY.** A device used for hoisting, lowering, and transporting loads within a prescribed path,
24 longitudinally and laterally. The load block (upper) travels on a rope catenary system having span
25 ends that are supported on fixed or movable towers (masts) or other elevated supports.

26 **CAISSON PILES.** Steel cased piles constructed by advancing a steel shell seated into rock and
27 drilling of an uncased socket within the rock. The shell and socket are filled with a steel core section
28 or steel reinforcing, and concrete or grout.

29 **CANOPY.** A permanent structure or architectural projection of rigid construction over which a
30 covering is attached that provides weather protection, identity or decoration, which shall be
31 structurally independent or supported by attachment to a building on one end and by not fewer than
32 one stanchion at the outer end.

33 **CARBON DIOXIDE EXTINGUISHING SYSTEMS.** A system supplying carbon dioxide (CO_2)
34 from a pressurized vessel through fixed pipes and nozzles. The system includes a manual- or
35 automatic-actuating mechanism.

- 1 **CARBON MONOXIDE ALARM.** A listed single- or multiple-station alarm responsive to carbon
2 monoxide.
- 3 **CARBON MONOXIDE DETECTOR.** A listed device that senses carbon monoxide.
- 4 **CARBON MONOXIDE-PRODUCING EQUIPMENT.** Any furnace, boiler, water heater,
5 fireplace, cooking appliance, gas clothes dryer, apparatus, appliance or device that burns coal,
6 kerosene, oil, wood, fuel gases and other petroleum products including, but not limited to, methane,
7 natural gas, liquefied natural gas and manufactured fuel gases.
- 8 **CARE SUITE.** In Group I-2 occupancies, a group of treatment rooms, care recipient sleeping rooms
9 and the support rooms or spaces and circulation space within the suite where staff are in attendance
10 for supervision of all care recipients within the suite, and the suite is in compliance with the
11 requirements of Section 407.4.4.
- 12 **CARPORT.** A structure or portion of a structure, accessory to a Group R-2 or R-3 occupancy, open
13 on at least two sides and unenclosed for at least 50 percent of perimeter, used for the parking or
14 storage of passenger motor vehicles. Such facility shall not exceed 650 square feet (60.45 m²) in area
15 and one story in height.
- 16 **CAST STONE.** A building stone manufactured from portland cement concrete precast and used as a
17 trim, veneer or facing on or in buildings or structures.
- 18 **CEILING LIMIT.** The maximum concentration of an air-borne contaminant to which one may be
19 exposed. The ceiling limits utilized are those published in DOL 29 CFR Part 1910.1000. The ceiling
20 Recommended Exposure Limit (REL-C) concentrations published by the U.S. National Institute for
21 Occupational Safety and Health (NIOSH), Threshold Limit Value – Ceiling (TLV-C) concentrations
22 published by the American Conference of Governmental Industrial Hygienists (ACGIH), Ceiling
23 Workplace Environmental Exposure Level (WEEL-Ceiling) Guides published by the American
24 Industrial Hygiene Association (AIHA), and other approved, consistent measures are allowed as
25 surrogates for hazardous substances not listed in DOL 29 CFR Part 1910.1000.
- 26 **CEILING RADIATION DAMPER.** See Dampers, Types of.
- 27 **CELL.** See Section 408.1.1.
- 28 **CELL.** As used in Chapter 21, a void space having a gross cross-sectional area greater than 1^{1/2}
29 square inches (967 mm²).
- 30 **CELL TIER.** See Section 408.1.1.
- 31 **CELLAR.** That portion of a building that is partly or wholly underground, and having one-half or
32 more of its clear height (measured from finished floor to finished ceiling) below the grade plane.
33 Cellars shall not be counted as stories in measuring the height of the buildings.
- 34 **CEMENT BOARD.** A fiber reinforced cementitious panel most commonly used under flooring or
35 as a tile backing board. Cement board shall include discrete nonasbestos fiber-cement interior
36 substrate sheets or nonasbestos fiber-mat reinforced cement substrate sheets.

1 **CEMENT PLASTER.** A mixture of portland or blended cement, portland cement or blended cement
2 and hydrated lime, masonry cement or plastic cement and aggregate and other approved materials as
3 specified in this code.

4 **CEMENTED SOIL.** Soil in which the particles are held together by a chemical agent, such as
5 calcium carbonate, such that a hand-size sample cannot be crushed into powder or individual soil
6 particles by finger pressure.

7 **CERAMIC FIBER BLANKET.** A high-temperature mineral wool insulation material made of
8 alumina-silica ceramic or calcium magnesium silicate soluble fibers and weighing 4 to 10 pounds per
9 square cubic foot (pcf) (64 to 160 kg/m³).

10 **CERTIFICATE OF APPROVAL.** A certificate issued by the department upon review and approval
11 of the engineering and testing of a specific make and model of hoisting equipment to ensure
12 compliance with the applicable provisions of this code.

13 **CERTIFICATE OF OPERATION.** A certificate issued by the department upon satisfactory
14 inspection of a specific piece of hoisting equipment to ensure that the equipment is in compliance
15 with this code.

16 **CERTIFICATE OF ON-SITE INSPECTION.** A certificate issued by the department based on a
17 site-specific inspection of the placement and founding of hoisting equipment.

18 **CHILD CARE FACILITIES.** See Section 308.2.1.

19 **CHIMNEY.** A primarily vertical structure containing one or more flues used to remove hot gases
20 from burning fuel, refuse, or from industrial processes to the outdoor atmosphere.

21 **Factory-built chimney.** A listed and labeled chimney composed of factory-made components,
22 assembled in the field in accordance with manufacturer's instructions and the conditions of the listing.

23 **Masonry chimney.** A field-constructed chimney composed of solid masonry units, bricks, stones,
24 or concrete.

25 **Metal chimney.** A field-constructed chimney of metal.

26 **CHIMNEY TYPES.**

27 **High-heat appliance type.** An approved chimney for removing the products of combustion from
28 fuel-burning, high-heat appliances producing combustion gases in excess of 2,000°F (1093°C)
29 measured at the appliance flue outlet (see Section 2113.11.3).

30 **Low-heat appliance type.** An approved chimney for removing the products of combustion from
31 fuel-burning, low-heat appliances producing combustion gases not in excess of 1,000°F (538°C)
32 under normal operating conditions, but capable of producing combustion gases of 1,400°F
33 (760°C) during intermittent forces firing for periods up to 1 hour. Temperatures shall be measured
34 at the appliance flue outlet.

1 **Medium-heat appliance type.** An approved chimney for removing the products of combustion
2 from fuel-burning, medium-heat appliances producing combustion gases between 1,000°F
3 (538°C) and 2,000°F (1093°C) measured at the appliance flue outlet (see Section 2113.11.2).

4 **CIRCULATION PATH.** An exterior or interior way of passage from one place to another for
5 pedestrian travel, including that within accessible spaces.

6 **CLAMSHELL.** A shovel bucket with two jaws that clamp together by their own weight when it is
7 lifted by a closing line.

8 **CLEAN AGENT.** Electrically nonconducting, volatile or gaseous fire extinguishant that does not
9 leave a residue upon evaporation.

10 **CLIMBER CRANE.** A tower crane that can be raised to a new working height, either by adding
11 tower sections to the top of the crane (top climbing), or by a system in which the entire crane is raised
12 inside the structure (inside climbing).

13 **CLINIC, OUTPATIENT.** Buildings or portions thereof used to provide medical care on less than a
14 24-hour basis to persons who are not rendered incapable of self-preservation by the services provided.

15 **CLOSED SYSTEM.** The use of any compressed gas and the use of a solid or liquid hazardous
16 material in equipment or a vessel or system that remains closed during normal operations, such that
17 vapors emitted during the operation of such equipment, vessel or system are not liberated outside of
18 the equipment, vessel or system and the gas or hazardous material is not exposed to the atmosphere
19 during such operation. Examples of closed systems include hazardous materials conveyed through a
20 pipng system into closed equipment of a closed vessel or system.

21 **CLOSED-CIRCUIT TELEPHONE.** A telephone with a dedicated line such as a house phone,
22 courtesy phone or phone that must be used to gain entrance to a facility.

23 **COASTAL A-ZONE.** An area within a special flood hazard area, shown on FEMA FIRMs 360497
24 as an area bounded by a “Limit of Moderate Wave Action,” landward of a V-Zone or landward of an
25 open coast without mapped V-Zones. In a Coastal A-Zone, the principal source of flooding must be
26 astronomical tides, storm surges, seiches, or tsunamis, and not riverine flooding. During the base
27 flood conditions, the potential for breaking wave heights must be greater than or equal to 1 foot, 6
28 inches (457 mm). In no case shall an area of special flood hazard be deemed a coastal A-Zone unless
29 and until it has been identified as such on the adopted FEMA FIRMs 360497.

30 **COASTAL HIGH HAZARD AREA.** Area within the area of special flood hazard extending from
31 offshore to the inland limit of a primary dune along an open coast and any other area that is subject
32 to high-velocity wave action from storms and shown on FEMA FIRMs 360497 as velocity Zone V,
33 VO, VE or V1-30.

34 **COHESIVE SOIL.** Clay (fine grained soil), or soil with a high clay content, which has cohesive
35 strength. Cohesive soil does not crumble, can be excavated with vertical side slopes, and is plastic
36 when moist. Cohesive soil is hard to break up when dry, and exhibits significant cohesion when
37 submerged. Cohesive soils include clayey silt, sandy clay, silty clay, clay and organic clay.

- 1 **COLLAPSE (STRUCTURAL).** Failure of a structural element to the extent that it can no longer
2 support any load.
- 3 **COLLAR JOINT.** Vertical longitudinal space between wythes of masonry or between masonry
4 wythe and backup construction that is permitted to be filled with mortar or grout.
- 5 **COLLECTING SAFE AREA.** See Section 1002.1.2.
- 6 **COLLECTOR.** A horizontal diaphragm element parallel and in line with the applied force that
7 collects and transfers diaphragm shear forces to the vertical elements of the lateral-force-resisting
8 system or distributes forces within the diaphragm or both.
- 9 **COMBINATION FIRE/SMOKE DAMPER.** See Dampers, Types of.
- 10 **COMBINATION SIGN.** A sign incorporating any combination of the features of pole, projecting
11 and roof signs.
- 12 **COMBINED HEAT AND POWER SYSTEMS.** Equipment that simultaneously produces
13 electricity and heat from a single fuel source.
- 14 **COMBUSTIBLE DUST.** Finely divided solid material that is 420 microns or less in diameter, will
15 pass through a U.S. standard No. 40 sieve and, when dispersed in air in sufficient concentrations, can
16 be ignited by a flame, spark or other source of ignition.
- 17 **COMBUSTIBLE FIBERS.** Readily ignitable and free-burning materials in fibrous or shredded
18 form, such as cocoa fiber, cotton, excelsior, hay, hemp, henequen, istle, jute, kapok, oakum, sisal,
19 Spanish moss, straw, tow, wastepaper or other natural or synthetic fibers that possess similar qualities,
20 but excluding densely packed baled cotton.
- 21 **Exception:** Moss used for medicinal purposes.
- 22 **COMBUSTIBLE LIQUID.** For the purposes of transportation, a combustible liquid as defined in
23 the regulations of the United States of Transportation, as set forth in 49 CFR 173.120. For all other
24 purposes, a liquid, other than a compressed gas or cryogenic fluid, having a closed cup flash point at
25 or above 100°F (38°C) classified as follows:
- 26 **Class II.** Liquids having a closed cup flash point at or above 100°F (38°C) and below 140°F
27 (60°C).
- 28 **Class IIIA.** Liquids having a closed cup flash point at or above 140°F (60°C) and below 200°F
29 (93°C).
- 30 **Class IIIB.** Liquids having a closed cup flash point at or above 200°F (93°C).
- 31 **COMMERCIAL COOKING SYSTEM.** A system consisting of commercial cooking equipment,
32 exhaust hood, filters, exhaust duct system, fire suppression system and other related appurtenances
33 designed to capture grease-laden cooking vapors and exhaust them safely to the outdoors.

1 **COMMERCIAL MOTOR VEHICLE.** A motor vehicle used to transport passengers or goods
2 where the motor vehicle:

3 1. Has a gross vehicle weight rating of 10,000 pounds (4540 kg) or more; or

4 2. Is designed to transport 16 or more passengers, including the driver.

5 **COMMERCIAL TRUCK MOUNTED CRANE (BOOM TRUCK).** A mobile crane consisting of
6 a rotating superstructure (center post or turntable), boom, operating machinery, and one or more
7 operator's stations mounted on a frame attached to a commercial truck chassis.

8 **COMMON PATH OF EGRESS TRAVEL.** That portion of exit access that the occupants are
9 required to traverse before two separate and distinct paths of egress travel to two exits are available.
10 Paths that merge are common paths of travel. Common paths of egress travel shall be included within
11 the permitted travel distance.

12 **COMMON USE.** Interior or exterior circulation paths, rooms, spaces or elements that are made
13 available for the shared use of two or more people but are not for public use.

14 **COMPACTED CONCRETE PILES.** Compacted concrete piles are constructed by filling a driven
15 casing with low-strength concrete and compacting the concrete as the casing is withdrawn.

16 **COMPETENT PERSON.** One who is capable of identifying existing and predictable hazards in the
17 surroundings or conditions that are unsanitary, hazardous or dangerous, and who has authorization to
18 take prompt corrective measures to eliminate such hazards.

19 **COMPLETED STEEL FLOOR.** Any floor, in a building whose primary structural system consists
20 of structural steel, where the structural floor system, including the final walkable structural surface,
21 has been installed and has achieved its required strength for construction loading.

22 **COMPONENTS AND CLADDING.** Elements of the building envelope that do not qualify as part
23 of the main wind force-resisting system.

24 **COMPOSITE PILES.** Composite piles consist of two or more approved pile types joined together.

25 **COMPRESSED GAS.** A material, or mixture of materials that:

26 1. Is a gas at 68°F (20°C) or less at 14.7 psia (101 kPa) of pressure; and

27 2. Has a boiling point of 68°F (20°C) or less at 14.7 psia (101 kPa) that is either liquefied,
28 nonliquefied or in solution at that temperature and pressure, except those gases which have no
29 other health- or physical-hazard properties are not considered to be compressed until the
30 pressure in the packaging exceeds 41 psia (282 kPa) at 68°F (20°C).

31 The states of compressed gases are categorized as follows:

32 **Nonliquefied compressed gases.** Gases, other than those in solution, which are in packaging
33 under the charged pressure and are entirely gaseous at a temperature of 68°F (20°C).

1 **Liquefied compressed gases.** Gases that, in a packaging under the charged pressure, are partially
2 liquid at a temperature of 68°F (20°C).

3 **Compressed gases in solution.** Nonliquefied gases that are dissolved in a solvent.

4 **Compressed gas mixtures.** A mixture of two or more compressed gases contained in a single
5 packaging, the hazard properties of which are represented by the properties of the mixture as a
6 whole.

7 **CONCEALED SPACES.** Enclosed spaces within partitions, walls, floors, roofs, stairs, furring, pipe
8 chases and column enclosures and other similar spaces.

9 **CONCRETE.**

10 **Carbonate aggregate.** Concrete made with aggregates consisting mainly of calcium or
11 magnesium carbonate, such as limestone or dolomite, and containing 40 percent or less quartz,
12 chert, or flint.

13 **Cellular.** A lightweight insulating concrete made by mixing a preformed foam with portland
14 cement slurry and having a dry unit weight of approximately 30 pcf (480 kg/m³).

15 **Lightweight aggregate.** Concrete made with aggregates of expanded clay, shale, slag or slate or
16 sintered fly ash or any natural lightweight aggregate meeting ASTM C 330 and possessing
17 equivalent fire-resistance properties and weighing 85 to 115 pcf (1360 to 1840 kg/m³).

18 **Perlite.** A lightweight insulating concrete having a dry unit weight of approximately 30 pcf (480
19 kg/m³) made with perlite concrete aggregate. Perlite aggregate is produced from a volcanic rock
20 that, when heated, expands to form a glass-like material of cellular structure.

21 **Sand-lightweight.** Concrete made with a combination of expanded clay, shale, slag, slate,
22 sintered fly ash, or any natural lightweight aggregate meeting ASTM C 330 and possessing
23 equivalent fire-resistance properties and natural sand. Its unit weight is generally between 105
24 and 120 pcf (1680 and 1920 kg/m³).

25 **Siliceous aggregate.** Concrete made with normal-weight aggregates consisting mainly of silica
26 or compounds other than calcium or magnesium carbonate, which contains more than 40-percent
27 quartz, chert, or flint.

28 **Vermiculite.** A lightweight insulating concrete made with vermiculite concrete aggregate that is
29 laminated micaceous material produced by expanding the ore at high temperatures. When added
30 to a portland cement slurry the resulting concrete has a dry unit weight of approximately 30 pcf
31 (480 kg/m³).

32 **CONCRETE-FILLED STEEL PIPE AND TUBE PILES.** Concrete-filled steel pipe and tube piles
33 are constructed by driving a steel pipe or tube section into the soil and filling the pipe or tube section
34 with concrete. The steel pipe or tube section is left in place during and after the deposition of the
35 concrete. For the purposes of this code, these piles shall be considered driven piles.

1 **CONCRETE WASHOUT WATER.** Wastewater from the rinsing of equipment used to mix,
2 transport, convey, and/or place concrete. Such equipment shall include, but not be limited to, concrete
3 buckets, concrete hose lines and pumps, boots, shovels, finishing tools, wheelbarrows, motorized
4 concrete carts, concrete pour funnels and the chute of concrete mixer trucks.

5 **Exceptions:**

6 1. This term shall not include wastewater from the rinsing of equipment involved in the
7 preparation, conveyance or application of concrete that is:

8 1.1. mixed on site if the total quantity of concrete is less than or equal to one and one
9 half cubic yards (1.146m³), or

10 1.2. from bagged ready mix if the total quantity of concrete is less than or equal to
11 sixty (60) eighty pound (36.287 kg) bags, or eighty (80) sixty pound (27.215 kg)
12 bags, or the equivalent.

13 2. This term shall not include wastewater from the rinsing of the wheels, undercarriage or
14 chassis of concrete mixer trucks.

15 **CONGREGATE LIVING UNIT.** A dwelling unit, comprised of one or more habitable rooms
16 separated by nonrated partitions, occupied or arranged to be occupied by more than one family or by
17 persons who are not maintaining a common household. Creation of or conversion to such unit shall
18 be subject to Section 27-2077 of the *New York City Housing Maintenance Code*.

19 **CONSTANTLY ATTENDED LOCATION.** A designated location at a facility staffed by trained
20 personnel on a continuous basis where alarm or supervisory signals are monitored and facilities are
21 provided for notification of the Fire Department of other emergency services.

22 **CONSTRUCTION.** The excavation, erection, alteration, and repair of buildings or any component
23 parts, including all operations incidental thereto.

24 **CONTAINER GARDEN.** A plant or plants maintained in a pot or planters located on a roof, terrace,
25 or other horizontal exterior area.

26 **CONTINUOUS GAS DETECTION SYSTEM.** A gas detection system where the analytical
27 instrument is maintained in continuous operation and sampling is performed without interruption.
28 Analysis is allowed to be performed on a cyclical basis at intervals not to exceed 30 minutes.

29 **CONTROL AREA.** Spaces within a building where quantities of hazardous materials not exceeding
30 the maximum allowable quantities per control area are stored, handled, or used, including any
31 dispensing. See also definition of "Outdoor control area" in the *New York City Fire Code*.

32 **CONTROLLED LOW-STRENGTH MATERIAL.** A self-compacted, cementitious material used
33 primarily as a backfill in place of compacted fill.

34 **CONVENTIONAL LIGHT-FRAME CONSTRUCTION.** A type of construction whose primary
35 structural elements are formed by a system of repetitive wood-framing members. See Section 2308
36 for conventional light-frame construction provisions.

1 **CORNER SCAFFOLD (ANGLE SCAFFOLD).** A suspended scaffold consisting of an assembly
2 of two or more platforms connected nonlinearly and designed and manufactured to fit around a corner
3 or a projecting part of a building.

4 **CORRIDOR.** An enclosed exit access component that defines and provides a path of egress travel
5 to an exit. Corridors shall be either interior or public.

6 **Corridor, interior.** A corridor that serves only one tenant. In Group E occupancies, corridors
7 serving only one institution shall be deemed as serving a single tenant.

8 **Corridor, public.** A corridor that serves more than one tenant.

9 **CORROSIVE MATERIAL.** A material that causes full thickness destruction of human skin at the
10 site of contact within a specified period of time when tested by methods set forth in DOTn regulations
11 49 CFR 173.136 and 173.137, or a liquid that has a severe corrosion rate on steel or aluminum based
12 on the criteria set forth in DOTn regulations 49 CFR 173.173(c)(2).

13 **CORROSION RESISTANCE.** The ability of a material to withstand deterioration of its surface or
14 its properties when exposed to its environment.

15 **COUNTERWEIGHT.** Weight used to supplement the weight of the machine in order to provide
16 stability for lifting loads.

17 **COURT.** An open, uncovered space, unobstructed to the sky, bounded on three or more sides by
18 exterior building walls or other enclosing devices.

19 **COVERED DEVELOPMENT PROJECT.** See Section 28-104.11.1 of the *Administrative Code*.

20 **COVERED MALL BUILDING.** A single building enclosing a number of tenants and occupants
21 such as retail stores, drinking and dining establishments, entertainment and amusement facilities,
22 passenger transportation terminals, offices, and other similar uses wherein two or more tenants have
23 a main entrance into one or more malls. For the purpose of this chapter, anchor buildings shall not be
24 considered as part of the covered mall building. The term "Covered Mall Building" shall include open
25 mall buildings as defined below.

26 **Mall.** A roofed or covered common pedestrian area within a covered mall building that serves as
27 access for two or more tenants and not to exceed three levels that are open to each other. The term
28 "mall" shall include open malls as defined below.

29 **Open mall.** An unroofed common pedestrian way serving a number of tenants not exceeding
30 three levels. Circulation at levels above grade shall be permitted to include open exterior balconies
31 leading to exits discharging at grade.

32 **Open mall building.** Several structures housing a number of tenants, such as retail stores,
33 drinking and dining establishments, entertainment and amusement facilities, offices and other
34 similar uses, wherein two or more tenants have a main entrance into one or more open malls. For
35 the purposes of Chapter 4, anchor buildings are not considered as part of the open mall building.

36 **CRANE.** A power operated machine that can (i) hoist, lower, and horizontally move a suspended load,
37 or (ii) lift, lower, and horizontally swing a load utilizing a boom, jib, arm, or similar member, regardless

1 of whether it is fixed, folds, telescopes, or articulates. The definition of crane includes, but is not
2 limited to, an articulating boom crane, mobile crane, tower crane, dedicated pile driver, and rotating
3 telehandler. The definition of crane shall not include a derrick or cableway.

4 **CRAWLER CRANE.** A mobile crane consisting of a rotating superstructure with a power plant,
5 operating machinery, and boom, mounted on a base and equipped with crawler treads for travel.

6 **CRIPPLE WALL.** A framed stud wall extending from the top of the foundation to the underside of
7 floor framing for the lowest occupied floor level.

8 **CRITICAL PICK.** The attachment and detachment of loads from the hook of hoisting equipment
9 used to hoist or lower loads on the outside of a building that involves one or more of the following:

10 1. An article that is at or above 95 percent of approved rated capacity of the hoisting equipment
11 or rigging equipment;

12 2. An article that is asymmetrical and is not provided with lifting connections by the
13 manufacturer or fabricator;

14 3. An article that has a wind sail area exceeding 500 square feet (46 m²);

15 4. A pick that may present an added risk because of clearance, drift, or other interference;

16 5. An article that is fragile or of thin shell construction and is not provided with standard rigging
17 ears;

18 6. A pick that requires multiple power-operated hoisting equipment (tandem pick); or

19 7. A pick that require out of the ordinary rigging equipment, methods, or setup.

20 **CROSS AISLE.** An unenclosed exit access component in a place of assembly usually parallel to
21 rows of seats, connecting aisles or connecting an aisle and an exit. For the purposes of Chapter 10, a
22 cross aisle is not an aisle.

23 **CROSS-LAMINATED TIMBER (CLT).** A prefabricated engineered wood product made of at least
24 three orthogonal layers of graded sawn lumber or structural composite lumber (SCL) that are
25 laminated by gluing with structural adhesives.

26 **CRYOGENIC FLUID.** A liquid having a boiling point lower than -130°F (-89.9°C) at 14.7 pounds
27 per square inch absolute (psia) (an absolute pressure of 101.3 kPa).

28 **CURB LEVEL.** As defined in the *New York City Zoning Resolution*.

29 **CURB LINE.** The line coincident with the face of the street curb adjacent to the roadway.

30 **CURTAIN WALL.** A curtain wall or panel wall system is a nonload-bearing building wall, in
31 skeleton frame construction, attached and supported to the structure at every floor or other periodic
32 locations. Assemblies may include glass, metal, precast concrete or masonry elements arranged so as

1 not to exert common action under load and to move independently of each other and the supporting
2 structure.

3 **CUSTODIAL CARE FACILITY.** A building or part thereof occupied by persons, on less than a
4 24-hour basis and not overnight, who because of age, disability or other reasons, receive personal
5 care services by individuals other than parents or guardians, relatives by blood, marriage, domestic
6 partnership, or adoption, in a place other than the home of the person cared for.

7 **DALLE GLASS.** A decorative composite glazing material made of individual pieces of glass that
8 are embedded in a cast matrix of concrete or epoxy.

9 **DAMPERS, TYPES OF.**

10 **Ceiling radiation damper.** A listed device, installed in a ceiling membrane of a fire-resistance-
11 rated floor/ceiling or roof/ceiling assembly to limit automatically the radiative heat transfer
12 through an air inlet/outlet opening. Ceiling radiation dampers include air terminal units, ceiling
13 dampers and ceiling air diffusers.

14 **Combination fire/smoke damper.** A listed device, installed in ducts and air transfer openings
15 designed to close automatically upon the detection of heat and resist the passage of flame and
16 smoke. The device is installed to operate automatically controlled by a smoke detection system,
17 and where required, is capable of being positioned from a fire command center.

18 **Fire damper.** A listed device, installed in ducts and air transfer openings designed to close
19 automatically upon detection of heat and restrict the passage of flame. Fire dampers are classified
20 for use in either static systems that will automatically shut down in the event of a fire, or in
21 dynamic systems that continues to operate during a fire. A dynamic fire damper is tested and rated
22 for closure under elevated temperature airflow.

23 **Smoke damper.** A listed device, installed in ducts and air transfer openings designed to resist the
24 passage of air and smoke. The device is installed to operate automatically, controlled by a smoke
25 detection system, and where required, is capable of being positioned from a fire command center.

26 **DAMPPROOFING.** Dampproofing is a protective measure applied to building foundation walls and
27 slabs to prevent moisture from passing into interior spaces.

28 **DAY BOX.** A portable magazine designed to hold explosive materials constructed in accordance
29 with the requirements for a Type 3 magazine as defined and classified in the *New York City Fire*
30 *Code.*

31 **DEAD END.** A portion of a corridor in which the travel to an exit is in one direction only.

32 **DEAD LOAD.** The weight of materials of construction incorporated into the building, including but
33 not limited to walls, floors, roofs, ceilings, stairways, built-in partitions, finishes, cladding and other
34 similarly incorporated architectural and structural items, and the weight of fixed service equipment,
35 such as cranes, plumbing stacks and risers, electrical feeders, heating, ventilating and air-conditioning
36 systems and automatic sprinkler systems.

1 **DEBRIS.** Rubbish, waste, discarded material, or the remains of something broken down, demolished,
2 or destroyed.

3 **DEBRIS NET or NETTING.** A netting of a fine mesh of a size and strength sufficient to catch
4 debris, such as falling tools and materials.

5 **DECK.** An exterior floor supported on at least two opposing sides by an adjacent structure and/or
6 posts, piers, or other independent supports.

7 **DECORATIVE GLASS.** A carved, leaded or Dalle glass or glazing material whose purpose is
8 decorative or artistic, not functional; whose coloring, texture or other design qualities or components
9 cannot be removed without destroying the glazing material and whose surface, or assembly into which
10 it is incorporated, is divided into segments.

11 **DECORATIVE MATERIALS.** All materials applied over the building interior finish for decorative,
12 acoustical or other effect (such as curtains, draperies, fabrics, streamers and surface coverings), and all
13 other materials utilized for decorative effect (such as batting, cloth, cotton, hay, stalks, straw, vines,
14 leaves, trees, moss and similar items), including foam plastics and materials containing foam plastics.
15 Decorative materials do not include floor coverings, ordinary window shades, interior finish and
16 materials 0.025 inch (0.64 mm) or less in thickness applied directly to and adhering tightly to a
17 substrate.

18 **DECORATIVE SHROUD.** A listed partial combustible enclosure for aesthetic purposes that is
19 installed at the termination of a venting system that surrounds or conceals the chimney or vent cap.

20 **DEDICATED PILE DRIVER.** A power operated machine that is designed primarily to drive,
21 hammer, press, or vibrate piles into the earth ("pile drive"). These machines typically have the ability
22 to both hoist the material that will be pile driven and to pile drive that material.

23 **DEEP FOUNDATIONS.** Deep foundations are comprised of concrete, grout, wood or steel
24 structural elements either driven, drilled or jacked into the ground or cast in place. Deep foundations
25 are relatively slender in comparison to their length, with lengths exceeding 12 times the least
26 horizontal dimension. Deep foundations derive their load-carrying capacity through skin friction, end
27 bearing, or a combination thereof.

28 **DEFLAGRATION.** An exothermic reaction, such as the extremely rapid oxidation of a flammable
29 dust or vapor in air, in which the reaction progresses through the unburned material at a rate less than
30 the velocity of sound. A deflagration can have an explosive effect.

31 **DELUGE SPRINKLER SYSTEM.** A sprinkler system employing open sprinklers attached to a
32 piping system connected to a water supply through a valve that is opened by the operation of a
33 detection system installed in the same areas as the sprinklers. When this valve opens, water flows into
34 the piping system and discharges from all sprinklers attached thereto.

35 **DEMOLITION.** Full or partial demolition.

36 **Full demolition.** The dismantling, razing, or removal of all of a building or structure, including
37 all operations incidental thereto.

- 1 **Partial demolition.** The dismantling, razing, or removal of structural members, floors, interior
2 bearing walls, and/or exterior walls or portions thereof, including all operations incidental thereto.
- 3 **DERRICK.** An apparatus consisting of a mast or equivalent member held at the end by guys or
4 braces, with or without a boom, for use with a hoisting mechanism and operating ropes, for lifting or
5 lowering a load and moving it horizontally.
- 6 **DESIGN EARTHQUAKE GROUND MOTION.** The earthquake ground motion that buildings and
7 structures are specifically proportioned to resist in Section 1613.
- 8 **DESIGN FLOOD ELEVATION.** The applicable elevation specified in ASCE 24, Tables 2-1, 4-1,
9 5-1, 6-1, or 7-1, depending on the flood design class designated in ASCE 24, Table 1-1.
- 10 **DESIGN STRENGTH.** The product of the nominal strength and a resistance factor (or strength
11 reduction factor).
- 12 **DETACHED BUILDING.** A separate single-story building, without a basement or crawl space, used
13 for the storage, handling or use of hazardous materials and located an approved distance from other
14 buildings and structures.
- 15 **DETECTABLE WARNING.** A standardized surface feature built in or applied to walking surfaces
16 or other elements to warn a person who is blind or has low vision of hazards on a circulation path.
- 17 **DETECTOR, HEAT.** A fire detector that senses heat – either abnormally high temperature or rate
18 of rise, or both.
- 19 **DETONATION.** An exothermic reaction with explosive effect that utilizes shock compression as
20 the principal heating mechanism and generates a shock wave in the material that establishes and
21 maintains a reaction that progresses through the material at a rate greater than the velocity of sound.
- 22 **DETOXIFICATION FACILITIES.** See Section 308.2.1.
- 23 **DEVELOPMENT.** See Section G201.1.2.
- 24 **DEWATERING.** The removal of surface or ground water from a site by pumping or evaporation.
- 25 **DIAPHRAGM.** A horizontal or sloped system acting to transmit lateral forces to vertical elements
26 of the lateral force-resisting system. When the term "diaphragm" is used, it shall include horizontal
27 bracing systems.
- 28 **Diaphragm, blocked.** In light-frame construction, a diaphragm in which all sheathing edges not
29 occurring on a framing member are supported on and fastened to blocking.
- 30 **Diaphragm boundary.** In light-frame construction, a location where shear is transferred into or
31 out of the diaphragm sheathing. Transfer is either to a boundary element or to another force-
32 resisting element.
- 33 **Diaphragm chord.** A diaphragm boundary element perpendicular to the applied load that is
34 assumed to take axial stresses due to the diaphragm moment.

1 **Diaphragm, unblocked.** A diaphragm that has edge nailing at supporting members only.
2 Blocking between supporting structural members at panel edges is not included. Diaphragm
3 panels are field nailed to supporting members.

4 **DIMENSIONS.**

5 **Nominal.** The specified dimension plus an allowance for the joints with which the units are to be
6 laid. Nominal dimensions are usually stated in whole numbers. Thickness is given first, followed
7 by height and then length.

8 **Specified.** Dimensions specified for the manufacture or construction of a unit, joint or element.

9 **DIRECT AND CONTINUING SUPERVISION.** See Section 28-401.3 of the *Administrative Code.*

10 **DIRECT EMPLOY.** See Section 28-401.3 of the *Administrative Code.*

11 **DISMANTLING.** The final process of taking apart, piece by piece, in a specific sequence, the
12 components of a tower crane. Dismantling shall include jumping.

13 **DISPENSING.** The pouring or transferring by other means of any material from a container, tank or
14 similar vessel, which would release dusts, fumes, mists, vapors, or gases to the atmosphere, unless
15 such release is prevented by a device, equipment or system designed for that purpose.

16 **DISPLAY SIGN.** The area made available by the sign structure for the purpose of displaying the
17 advertising message.

18 **DOOR, BALANCED.** A door equipped with double-pivoted hardware so designed as to cause a
19 semicounterbalanced swing action when opening.

20 **DRAFT STOP.** A material, device or construction installed to resist the movement of air within open
21 spaces of concealed areas of building components such as crawl spaces, floor/ceiling assemblies,
22 roof/ceiling assemblies and attics.

23 **DRAG STRUT.** See "Collector."

24 **DRILLED DISPLACEMENT PILES.** Rotary displacement piles installed by rotating a helical
25 auger segment into the ground with both a vertical force and a torque. The soil is displaced laterally
26 within the ground (with minimum spoil generated) and the void created is filled with grout or
27 concrete.

28 **DRIVEN UNCASSED PILES.** Driven uncased piles are constructed by driving a steel shell into the
29 soil to shore an unexcavated hole that is later filled with concrete. The steel casing is lifted out of the
30 hole during the deposition of the concrete. Driven uncased piles are not permitted under the provisions
31 of this code.

32 **DRUM.** The cylindrical member around which a rope is wound for raising and lowering the load or
33 boom.

1 **DRY-CHEMICAL EXTINGUISHING AGENT.** A powder composed of small particles, usually
2 of sodium bicarbonate, potassium bicarbonate, urea-potassium-based bicarbonate, potassium chloride
3 or monoammonium phosphate, with added particulate material supplemented by special treatment to
4 provide resistance to packing, resistance to moisture absorption (caking) and the proper flow
5 capabilities.

6 **DRY (SOIL).** Soil that does not exhibit visible signs of moisture content.

7 **DWELLING.** A building or structure that is occupied in whole or in part as the home, residence or
8 sleeping place of one or more families.

9 **DWELLING, MULTIPLE.** A dwelling that is either rented, leased, let or hired out, to be occupied,
10 or is occupied, as the residence or home of three or more families living independently of each other.
11 A multiple dwelling does not include a building used for occupancies in Groups I-2, I-3 or I-4.

12 **DWELLING, ONE-FAMILY.** Any building or structure designed and occupied exclusively for
13 residence purposes on a long-term basis for more than a month at a time by not more than one family.
14 One-family dwelling shall also be deemed to include a dwelling located in a series of one-family
15 dwellings each of which faces or is accessible to a legal street or public thoroughfare, provided that
16 each such dwelling unit is equipped as a separate dwelling unit with all essential services, and also
17 provided that each such unit is arranged so that it may be approved as a legal one-family dwelling.

18 **DWELLING, TWO-FAMILY.** Any building or structure designed and occupied exclusively for
19 residence purposes on a long-term basis for more than a month at a time by not more than two families.
20 Two-family dwellings shall also be deemed to include a dwelling located in a series of two-family
21 dwellings each of which faces or is accessible to a legal street or public thoroughfare, provided that
22 each such dwelling is equipped as a separate dwelling with all essential services, and also provided
23 that each such dwelling is arranged so that it may be approved as a legal two-family dwelling.

24 **DWELLING UNIT.** A single unit consisting of one or more habitable rooms and occupied or
25 arranged to be occupied as a unit separate from all other units within a dwelling.

26 **DWELLING UNIT (ACCESSIBILITY).** As used in Chapter 11 and Appendix E, a single unit
27 providing complete, independent living facilities for one or more persons, including permanent
28 provisions for living, sleeping, eating, cooking and sanitation.

29 **DWELLING UNIT OR SLEEPING UNIT, MULTISTORY.** See "Multistory unit".

30 **DWELLING UNIT OR SLEEPING UNIT, TYPE B.** See "Type B unit".

31 **EAVE HEIGHT, *h*.** The distance from the ground surface adjacent to the building to the roof eave
32 line at the particular wall. If the distance of the eave varies along the wall, the average distance shall
33 be used.

34 **EFFECTIVE WIND AREA.** See ASCE 7.

35 **EGRESS, COURT.** A court or yard that provides access to a public right of way for one or more
36 exits.

- 1 **ELECTRIC SIGN.** A sign containing electrical wiring, but not including signs illuminated by an
2 exterior light source.
- 3 **ELECTRICAL CIRCUIT PROTECTIVE SYSTEM.** A specific listed construction of devices,
4 materials, or coatings installed as a fire-resistive barrier system applied to electrical system
5 components, such as cable trays, conduits and other raceways, open run cables and conductors, cables,
6 and conductors in accordance with UL 2196.
- 7 **ELEMENT (STRUCTURAL).** A structural member or structural assembly.
- 8 **ELEVATOR LANDING.** That portion of a floor, balcony, or platform used to receive and discharge
9 passengers or freight adjacent to an elevator hoistway.
- 10 **EMERGENCY ALARM SYSTEM.** A system to provide indication and warning of an emergency
11 condition involving a release of hazardous material or other hazardous material incident.
- 12 **EMERGENCY CONTROL STATION.** An approved location on the premises of a semiconductor
13 fabrication facility staffed by trained personnel that monitor the operation of equipment and systems
14 including alert and alarm signals.
- 15 **EMERGENCY ESCAPE AND RESCUE OPENING.** An operable window, door or other similar
16 device that provides for a means of escape and access for rescue in the event of an emergency.
- 17 **EMERGENCY VOICE/ALARM COMMUNICATIONS.** Dedicated manual or automatic
18 facilities for originating and distributing voice instructions, as well as alert and evacuation signals
19 pertaining to a fire or other emergency, to the occupants of a building.
- 20 **EMPLOYEE WORK AREA.** All or any portion of a space used only by employees and only for
21 work. Corridors, toilet rooms, kitchenettes and break rooms are not employee work areas.
- 22 **ENGINEERED WOOD RIM BOARD.** A full-depth structural composite lumber, wood structural
23 panel, structural glued laminated timber or prefabricated wood I-joist member designed to transfer
24 horizontal (shear) and vertical (compression) loads, provide attachment for diaphragm sheathing,
25 siding and exterior deck ledgers, and provide lateral support at the ends of floor or roof joists or
26 rafters.
- 27 **ENLARGED BASE PILES.** Enlarged base piles are cast-in-place concrete piles constructed with a
28 base that is larger than the diameter of the remainder of the pile. The enlarged base is designed to
29 increase the load-bearing area of the pile in end bearing. Enlarged base piles include piles installed
30 by driving a precast concrete tip or by compacting concrete into the base of the pile to form an
31 enlarged base.
- 32 **EQUIPMENT.** Tools, machinery, or other implements used to facilitate construction or demolition
33 work.
- 34 **EQUIPMENT PLATFORM.** An unoccupied, elevated platform used exclusively for mechanical
35 systems or industrial process equipment, including the associated elevated walkways, stairways,
36 alternating tread devices and ladders necessary to access the platform (see Section 505.3).

- 1 **ERECTION.** The assembly and placement of tower crane sections and components into place,
2 including all operations incidental thereto. Erection shall include jumping.
- 3 **ESSENTIAL FACILITIES.** Buildings and other structures that are intended to remain operational
4 in the event of extreme environmental loading from flood, wind, snow or earthquakes.
- 5 **EXCAVATION.** The removal of earth from its natural position; except for any incidental removal
6 that occurs during the course of auguring, drilling, vibrating, or driving.
- 7 **EXHAUSTED ENCLOSURE.** A device, typically consisting of a hood equipped with a fan, that
8 serves to capture and exhaust fumes, mist, vapors and gases generated at a workstation or other local
9 environment. An exhausted enclosure does not include a room provided with general ventilation.
- 10 **EXISTING CONSTRUCTION (FOR FLOOD ZONE PURPOSES).** See Section G201.1.2.
- 11 **EXISTING STRUCTURE (FOR FLOOD ZONE PURPOSES).** See Section G201.1.2.
- 12 **EXIT.** That portion of a means of egress system, which is separated from other interior spaces of a
13 building or structure by fire-resistance-rated construction and opening protective as required to
14 provide a protected path of egress travel between the exit access and the exit discharge. Exits include
15 exterior exit doors at the level of exit discharge, interior exit stairways and ramps, exit passageways,
16 exterior exit stairways, exterior exit ramps and horizontal exits, but do not include access stairs, aisles,
17 exit access doors opening to corridors, or corridors.
- 18 **EXIT ACCESS.** That portion of a means of egress system that leads from any occupied portion of a
19 building or structure to an exit.
- 20 **EXIT ACCESS DOORWAY.** A door or access point along the path of egress travel from an
21 occupied room, area or space where the path of egress enters an intervening room, corridor,
22 unenclosed exit access stair or unenclosed exit access ramp.
- 23 **EXIT ACCESS RAMP.** A ramp within the exit access portion of the means of egress system.
- 24 **EXIT ACCESS STAIRWAY.** A stairway within the exit access portion of the means of egress
25 system.
- 26 **EXIT DISCHARGE.** That portion of a means of egress system between the termination of an exit
27 and a public way.
- 28 **EXIT DISCHARGE, LEVEL OF.** The story at the point at which an exit terminates and an exit
29 discharge begins.
- 30 **EXIT, HORIZONTAL.** An exit that provides a path of egress travel from one building to an area in
31 another building on approximately the same level, or a path of egress travel through or around a wall
32 or partition to an area on approximately the same level in the same building, or a bridge or tunnel
33 between two buildings, which affords safety from fire and smoke from the area of incidence and areas
34 communicating therewith.

1 **EXIT PASSAGEWAY.** An exit component that is separated from other interior spaces of a building
2 or structure by fire-resistance-rated construction and opening protectives, and provides for a protected
3 path of egress travel in a horizontal direction to an exit component or to the exit discharge.

4 **EXPANDED VINYL WALL COVERING.** Wall covering consisting of a woven textile backing,
5 an expanded vinyl base coat layer and a non-expanded vinyl skin coat. The expanded base coat layer
6 is a homogenous vinyl layer that contains a blowing agent. During processing, the blowing agent
7 decomposes, causing this layer to expand by forming closed cells. The total thickness of the wall
8 covering is approximately 0.055 inch to 0.070 inch (1.4 mm to 1.8 mm).

9 **EXPLOSION.** An effect produced by the sudden violent expansion of gases, whether or not
10 accompanied by a shock wave or disruption, of enclosing materials, including the effects of the
11 following sources of explosion:

- 12 1. Chemical changes such as rapid oxidation, deflagration or detonation, decomposition of
13 molecules and runaway polymerization (usually detonations).
- 14 2. Physical changes such as pressure tank ruptures.
- 15 3. Atomic changes (nuclear fission or fusion).

16 **EXPLOSIVE.** A chemical compound, mixture or device, the primary or common purpose of which
17 is to function by explosion. The term includes, but is not limited to, dynamite, black powder, pellet
18 powder, initiating explosives, detonators, safety fuses, squibs, detonating cord, igniter cord and
19 igniters.

20 The term "explosive" includes any material determined to be within the scope of Chapter 40 of
21 Title 18 of the United States Codes, and any material classified as an explosive by the hazardous
22 materials regulations of the United States Department of Transportation, as set forth in 49 CFR
23 Section 173.52, except fireworks. Explosives are classified in accordance with the following United
24 States Department of Transportation classification and other terms in common usage:

25 **UN/DOTn Class 1 explosives.**

26 **Division 1.1.** Explosives that present a mass explosion hazard.

27 **Division 1.2.** Explosives that present a projection hazard but not a mass explosion hazard.

28 **Division 1.3.** Explosives that present a fire hazard and either a minor blast hazard or a minor
29 projection hazard, or both, but not a mass explosion hazard.

30 **Division 1.4.** Explosives that present a minor explosion hazard. The explosive effects are
31 largely confined to the package and no projection of fragments of appreciable size or range is
32 to be expected. Such explosives are not subject to mass explosion when exposed to fire.

33 **Division 1.5.** Explosives that present a mass explosion hazard but which are so insensitive
34 that there is very little probability of initiation or of transition from burning to detonation
35 under normal conditions of transport.

36 **Division 1.6.** Explosives consisting of extremely insensitive articles that do not present a mass
37 explosion hazard, and present a negligible probability of accidental initiation or propagation.

1 **High explosive.** Explosives, including dynamite, that, when detonated, are characterized by a
2 high rate of reaction, high pressure development, and the presence of a detonation wave, and that
3 can be caused to detonate by means of a No. 8 test blasting cap, when unconfined.

4 **Low explosive.** Explosives that will burn or deflagrate when ignited, and which are characterized
5 by a rate of reaction that is less than the speed of sound, and low pressure development. Examples
6 of low explosives include black powder, igniter cords, igniters, safety fuses, small arms
7 ammunition and primers, and propellants, 1.3C.

8 **Mass-detonating explosives.** Division 1.1, 1.2 and 1.5 explosives that, whether individually or
9 in combination, or loaded into ammunition or containers, explode virtually instantaneously when
10 a small portion is subjected to fire, concussion, impact, the impulse of an initiating agent, or the
11 effect of a considerable discharge of energy from without, with severe explosive effect, including
12 the potential for structural damage to adjacent objects, and explosive propagation to other
13 explosives stored in proximity, such that two or more quantities in proximity must be considered
14 as one for quantity-distance purposes.

15 **EXTERIOR EXIT RAMP.** An exit component that serves to meet one or more means of egress
16 design requirements, such as required number of exits or exit access travel distance, and is open to
17 yards, courts or public ways.

18 **EXTERIOR EXIT STAIRWAY.** A stairway that is open on at least one side, except for required
19 structural columns, beams, handrails and guards. The adjoining open areas shall be either yards, courts
20 or public ways. The other sides of the exterior exit stairway need not be open.

21 **EXTERIOR INSULATION AND FINISH SYSTEMS (EIFS).** EIFS are nonstructural, nonload-
22 bearing, exterior wall cladding systems that consist of an insulation board attached either adhesively
23 or mechanically, or both, to the substrate, an integrally reinforced base coat and a textured protective
24 finish coat.

25 **EXTERIOR INSULATION AND FINISH SYSTEMS (EIFS) WITH DRAINAGE.** An EIFS that
26 incorporates a means of drainage applied over a water-resistive barrier.

27 **EXTERIOR SURFACES.** Weather-exposed surfaces.

28 **EXTERIOR WALL.** A wall, bearing or nonbearing, that is used as an enclosing wall for a building,
29 other than a fire wall, and that has a slope of 60 degrees (1.05 rad) or greater with the horizontal plane.

30 **EXTERIOR WALL COVERING.** A material or assembly of materials applied on the exterior side
31 of exterior walls for the purpose of providing a weather-resisting barrier, insulation or for aesthetics,
32 including but not limited to, veneers, siding, exterior insulation and finish systems, architectural trim
33 and embellishments such as cornices, soffits, facias, gutters and leaders.

34 **EXTERIOR WALL ENVELOPE.** A system or assembly of exterior wall components, including
35 exterior wall finish materials, that provides protection of the building structural members, including
36 framing and sheathing materials, and conditioned interior space, from the detrimental effects of the
37 exterior environment.

1 **F RATING.** The time period that the through-penetration firestop system limits the spread of fire
2 through the penetration when tested in accordance with ASTM E 814 or UL 1479.

3 **FABRIC PARTITION.** A partition consisting of a finished surface made of fabric, without a
4 continuous rigid backing, that is directly attached to a framing system in which the vertical framing
5 members are spaced greater than 4 feet (1219 mm) on center.

6 **FABRICATION AREA.** An area within a semiconductor fabrication facility in which processes
7 using hazardous production materials are conducted.

8 **FACILITY.** All or any portion of buildings, structure, site improvements, elements and pedestrian
9 or vehicular routes located on a site.

10 **FACTORED LOAD.** The product of a nominal load and a load factor.

11 **FAMILY.**

12 1. A single person occupying a dwelling unit and maintaining a common household with not
13 more than two boarders, roomers or lodgers;

14 2. Two or more persons related by blood, adoption, legal guardianship, marriage or domestic
15 partnership; occupying a dwelling unit and maintaining a common household with not more
16 than two boarders, roomers or lodgers;

17 3. Not more than three unrelated persons occupying a dwelling unit and maintaining a common
18 household;

19 4. Not more than three unrelated persons occupying a dwelling unit in a congregate housing or
20 shared living arrangement and maintaining a common household;

21 5. Members of a group home;

22 6. Foster children placed in accordance with provisions of the *New York State Social Services*
23 *Law*, their foster parent(s), and other persons related to the foster parents by blood, marriage
24 or domestic partnership; where all residents occupy and maintain a common household with
25 not more than two boarders, roomers or lodgers; or

26 7. Up to seven unrelated students enrolled at a single accredited college or university occupying
27 a student apartment and maintaining a common household pursuant to a lease, sublease, or
28 occupancy agreement directly with such college or university, provided that:

29 7.1. The entire structure in which the dwelling unit is located is fully sprinklered in
30 accordance with Chapter 9 of this code;

31 7.2. Such occupancy does not exceed the maximums contained in Section 27-2075(a) of the
32 *New York City Housing Maintenance Code*;

33 7.3. Prior to commencement of such occupancy, and on an annual basis thereafter such
34 college or university has submitted a fire safety plan containing fire safety and

1 evacuation procedures for such dwelling unit that is acceptable to the Fire Commissioner
2 and in compliance with any rules promulgated by the Fire Commissioner; and

3 7.4. The dwelling unit complies with additional occupancy and construction requirements as
4 may be established by rule by the Housing Preservation and Development
5 Commissioner.

6 A common household is deemed to exist if all household members have access to all parts of the
7 dwelling unit. Lack of access to all parts of the dwelling unit establishes a rebuttable presumption that
8 no common household exists.

9 **FENESTRATION.** Skylights, roof windows, vertical windows (fixed or moveable), opaque doors,
10 glazed doors, glazed block and combination opaque/glazed doors. Fenestration includes products with
11 glass and nonglass glazing materials.

12 **FIBERBOARD.** A fibrous, homogeneous panel made from lignocellulosic fibers (usually wood or
13 cane) and having a density of less than 31 pounds per cubic foot (pcf) (497 kg/m³) but more than 10
14 pcf (160 kg/m³).

15 **FIBER REINFORCED POLYMER.** A polymeric composite material consisting of reinforcement
16 fibers, such as glass, impregnated with a fiber-bonding polymer which is then molded and hardened.
17 Fiber-reinforced polymers are permitted to contain cores laminated between fiber-reinforced polymer
18 facings.

19 **FIBER-CEMENT SIDING.** A manufactured, fiber-reinforcing product made with an inorganic
20 hydraulic or calcium silicate binder formed by chemical reaction and reinforced with discrete organic
21 or inorganic nonasbestos fibers, or both. Additives that enhance manufacturing or product
22 performance are permitted. Fiber cement siding products have either smooth or textured faces and are
23 intended for exterior wall and related applications.

24 **FIBERGLASS REINFORCED POLYMER.** A polymeric composite material consisting of glass
25 reinforcement fibers impregnated with a fiber-binding polymer which is then molded and hardened.

26 **FILM SIGN.** A flat section of a material that is extremely thin in comparison to its length and breadth
27 and has a nominal maximum thickness of 0.01 inch (0.25 mm).

28 **FIRE ALARM BOX, MANUAL.** See "Manual Fire Alarm Box."

29 **FIRE ALARM CONTROL UNIT.** A system component that receives inputs from automatic and
30 manual fire alarm devices and may be capable of supplying power to detection devices and
31 transponders or off-premises transmitters. The control unit may be capable of providing a transfer of
32 power to the notification appliances and transfer of condition to relays or devices.

33 **FIRE ALARM SIGNAL.** A signal initiated by a fire alarm-initiating device such as a manual fire
34 alarm box, automatic fire detector, waterflow switch, or other device whose activation is indicative
35 of the presence of a fire or fire signature.

- 1 **FIRE ALARM SYSTEM.** A system or portion of a combination system consisting of components
2 and circuits arranged to monitor and annunciate the status of fire alarm or supervisory signal-initiating
3 devices and to initiate the appropriate response to those signals.
- 4 **FIRE AREA.** The aggregate floor area enclosed and bounded by fire walls, fire barriers, exterior
5 walls and/or horizontal assemblies of a building. Areas of the building not provided with surrounding
6 walls shall be included in the fire area if such areas are included within the horizontal projection of
7 the roof or floor next above.
- 8 **FIRE BARRIER.** A fire-resistance-rated wall assembly of materials complying with Section 707
9 designed to restrict the spread of fire in which continuity of the fire-resistance rating is maintained.
- 10 **FIRE COMMAND CENTER.** The principal attended or unattended location where the status of
11 detection, alarm communications and control systems is displayed, and from which the systems can
12 be manually controlled.
- 13 **FIRE DAMPER.** See Dampers, Types of.
- 14 **FIRE DETECTOR, AUTOMATIC.** A device designed to detect the presence of a fire signature
15 and to initiate action.
- 16 **FIRE DOOR.** The door component of a fire door assembly.
- 17 **FIRE DOOR ASSEMBLY.** Any combination of a fire door, frame, hardware, and other accessories
18 that together, as an opening protective, provide a specific degree of fire protection to the opening.
- 19 **FIRE DOOR ASSEMBLY, FLOOR.** See "Floor fire door assembly."
- 20 **FIRE EXIT HARDWARE.** Panic hardware that is listed for use on fire door assemblies.
- 21 **FIRE LANE.** A public or private road, roadway lane, parking lot lane or other surface designed to
22 allow vehicular access, that has been specifically designated by means of signs or roadway markings
23 as a priority thoroughfare for fire apparatus.
- 24 **FIRE PARTITION.** A vertical assembly of materials complying with Section 708, designed to
25 restrict the spread of fire in which openings are protected.
- 26 **FIRE PROTECTION RATING.** The period of time that an opening protective assembly will
27 maintain the ability to confine a fire as determined by tests prescribed in Section 716. Ratings are
28 stated in hours or minutes.
- 29 **FIRE PROTECTION SYSTEM.** Approved devices, equipment and systems or combinations of
30 systems used to detect a fire, activate an alarm, extinguish or control a fire, control or manage smoke
31 and products of a fire or any combination thereof.
- 32 **FIRE PUMP.** A pump exclusively used to boost water supply pressures in a fire protection system.
- 33 **FIRE PUMP, AUTOMATIC STANDPIPE.** A fire pump located at or below street level or as
34 required, at the design flood elevation, that supplies the lower 300 feet (91.4 m) of an automatic

1 standpipe system or a combined standpipe and sprinkler system. This does not apply to manual wet
2 standpipe systems which are combined with sprinkler systems.

3 **FIRE PUMP, FOAM.** A fire pump used to boost water supply pressures in a fire protection system
4 where such system uses firefighting foam as an additive.

5 **FIRE PUMP, LIMITED SERVICE.** A fire pump with a motor rating not exceeding 30 hp and
6 utilizing a limited service fire pump controller.

7 **FIRE PUMP, SPECIAL SERVICE.** A fire pump that is located above street level, and above flood
8 level, and that receives its water supply from a gravity tank or suction tank.

9 **FIRE PUMP, SPRINKLER BOOSTER PUMP.** A fire pump that supplies sprinkler systems only.

10 **FIRE PUMP, WATER MIST SYSTEM.** A fire pump used to boost water supply pressures in a fire
11 protection system where such system utilizes water misting technology.

12 **FIRE RESISTANCE.** That property of materials or their assemblies that prevents or retards the
13 passage of excessive heat, hot gases or flames under conditions of use.

14 **FIRE SAFETY FUNCTIONS.** Building and fire control functions that are intended to increase the
15 level of life safety for occupants or to control the spread of harmful effects of fire.

16 **FIRE SEPARATION DISTANCE.** The distance measured from the building face to one of the
17 following:

18 1. The closest interior tax lot line;

19 2. To the centerline of a street, an alley or public space; or

20 3. To an imaginary line between two buildings on the same tax lot.

21 The distance shall be measured at right angles from the face of the wall.

22 **FIRE WALL.** A fire-resistance-rated smoke-tight wall having protected openings, which restricts
23 the spread of fire and extends continuously from the foundation to or through the roof, with sufficient
24 structural stability under fire conditions to allow collapse of construction on either side without
25 collapse of the wall.

26 **FIRE WINDOW ASSEMBLY.** A window, as an opening protective, constructed and glazed to give
27 protection against the passage of fire, smoke and hot gases.

28 **FIREBLOCKING.** A building material or materials approved for use as fireblocking to resist the
29 free passage of flame or hot gases to other areas of the building through concealed spaces.

30 **FIRECUT.** A sloping cut on the ends of wood beams, joists and rafters resting on masonry or
31 concrete walls.

1 **FIREPLACE.** A hearth and fire chamber or similar prepared place in which a fire may be made and
2 that is built in conjunction with a chimney.

3 **FIREPLACE THROAT.** The opening between the top of the firebox and the smoke chamber.

4 **FIRE-RATED GLAZING.** Glazing with either a fire protection rating or a fire-resistance rating.

5 **FIRE-RESISTANCE RATING.** The period of time a building element, component or assembly
6 maintains the ability to withstand fire exposure, continues to perform a given structural function, or
7 both, as determined by the tests, or the methods based on tests, prescribed in Section 703.

8 **FIRE-RESISTANT JOINT SYSTEM.** An assemblage of specific materials or products that are
9 designed, tested, and fire-resistance rated in accordance with either ASTM E 1966 or UL 2079 to
10 resist for a prescribed period of time the passage of fire through joints made in or between fire-
11 resistance-rated assemblies.

12 **FIRESTOPPING.** A through-penetration firestop or a membrane penetration firestop.

13 **FIREWORKS.** Any article or device that does not present a mass explosion hazard, that is
14 manufactured or used to produce a visible or audible effect for entertainment or other display purposes
15 by combustion, deflagration or detonation that meets the definition of 1.4G fireworks or 1.3G
16 fireworks as set forth herein.

17 **Fireworks, 1.3G.** Large firework devices, classified as UN0335 by the United States Department
18 of Transportation regulations, intended for use in fireworks displays and designed to produce
19 audible or visible effects by combustion, deflagration or detonation including firecrackers
20 containing more than 130 milligrams (2 grains) of explosive composition, aerial shells containing
21 more than 40 grams of pyrotechnic material, and other display pieces which exceeds the limits
22 for classification as 1.4G fireworks.

23 **Fireworks, 1.4G.** Small firework devices, classified as UN 0336 by United States Department of
24 Transportation regulations, containing restricted amounts of pyrotechnic materials designed
25 primarily to produce visible or audible effects by combustion.

26 **FISSURED (SOIL).** A soil material that has a tendency to break along definite planes of fracture
27 with little resistance, or a material that exhibits open cracks, such as tension cracks, in an exposed
28 surface.

29 **FIXED BASE OPERATOR (FBO).** A commercial business granted the right by the airport sponsor
30 to operate on an airport and provide aeronautical services, such as fueling, hangaring, tie-down and
31 parking, aircraft rental, aircraft maintenance and flight instruction.

32 **FIXED HEADED PILE (DEEP FOUNDATION).** A pile connected to a pile cap in a manner that
33 prevents rotation of the pile head.

34 **FIXED SEATING.** Furniture or fixture designed and installed for the use of sitting and secured in
35 place including bench-type seats and seats with or without backs or arm rests.

36 **FLAME SPREAD.** The propagation of flame over a surface.

1 **FLAME SPREAD INDEX.** A comparative measure, expressed as a dimensionless number, derived
2 from visual measurements of the spread of flame versus time for a material tested in accordance with
3 ASTM E 84 or UL 723.

4 **FLAMMABLE GAS.** A material which has a boiling point and becomes a gas at 68°F (20°C) or less
5 at 14.7 pounds per square inch absolute (psia) (101 kPa) of pressure which:

6 1. Is ignitable at 14.7 psia (101 kPa) when in a mixture of 13 percent or less by volume with air,
7 in accordance with testing procedures set forth in ASTM E 681; or

8 2. Has a flammable range at 14.7 psia (101 kPa) with air of at least 12 percent, regardless of the
9 lower explosive limit, in accordance with testing procedures set forth in ASTM E 681.

10 The limits specified shall be determined at 14.7 psia (101 kPa) of pressure and a temperature of
11 68°F (20°C) in accordance with ASTM E 681.

12 **FLAMMABLE LIQUEFIED GAS.** A liquefied gas that, under a charged pressure, is partially liquid
13 at a temperature of 68°F (20°C) and which is flammable.

14 **FLAMMABLE LIQUID.** For the purposes of transportation, a flammable liquid as defined in the
15 regulations of the United States Department of Transportation, as set forth in 49 CFR 173.120. For
16 all other purposes, a liquid, other than a compressed gas or cryogenic fluid, having a closed cup flash
17 point below 100°F (38°C) classified as follows:

18 **Class IA.** Liquids having a flash point below 73°F (23°C) and a boiling point below 100°F (38°C).

19 **Class IB.** Liquids having a flash point below 73°F (23°C) and a boiling point at or above 100°F
20 (38°C).

21 **Class IC.** Liquids having a flash point at or above 73°F (23°C) and below 100°F (38°C).

22 **FLAMMABLE MATERIAL.** A material capable of being readily ignited from common sources of
23 heat or at a temperature of 600°F (316°C) or less.

24 **FLAMMABLE SOLID.** A solid, other than a blasting agent or other explosive, whether in elemental
25 or alloy form, that is capable of causing fire through friction, absorption or moisture, spontaneous
26 chemical change, or heat retained from manufacturing or processing, or which has an ignition
27 temperature below 212°F (100°C) or which burns so vigorously and persistently when ignited as to
28 create a serious hazard. A chemical shall be considered a flammable solid if upon testing using the
29 method prescribed in CPSC regulations, as set forth in 16 CFR 1500.44, if it ignites and burns with a
30 self-sustained flame at a rate greater than 0.1 inch (2.5 mm) per second along its major axis.

31 **FLAMMABLE VAPORS OR FUMES.** The concentration of flammable constituents in air that
32 exceed 25 percent of their lower flammable limit (LFL).

33 **FLASH POINT.** The minimum temperature in degrees Fahrenheit at which a liquid will give off
34 sufficient vapors to form an ignitable mixture with air near the surface or in the container, but will
35 not sustain combustion. The flash point of a liquid shall be determined by appropriate test procedure
36 and apparatus as specified in ASTM D 56, ASTM D 93 or ASTM D 3278.

1 **FLIGHT.** A continuous run of rectangular treads, winders or combination thereof from one landing
2 to another.

3 **FLOOD or FLOODING.** A general and temporary condition of partial or complete inundation of
4 normally dry land from:

- 5 1. The overflow of inland or tidal waters.
- 6 2. The unusual and rapid accumulation or runoff of surface waters from any source.

7 **FLOOD DESIGN CLASS.** See Section G201.1.2.

8 **FLOOD HAZARD AREA.** The following two areas:

9 1. The area within a flood plain subject to a 1-percent or greater chance of flooding in any year.
10 Also defined as the “special flood hazard area”.

11 2. Where buildings are classified as Flood Design Class 4, the area within a flood plain
12 delineated as shaded X-Zones.

13 **FLOOD INSURANCE RATE MAP (FIRM).** An official map of a community on which the Federal
14 Emergency Management Agency (FEMA) has delineated both the special flood hazard areas and the
15 risk premium zones applicable to the community.

16 **FLOOD INSURANCE STUDY (FIS).** The official report provided by the Federal Emergency
17 Management Agency (FEMA) containing the Flood Insurance Rate Map (FIRM), the water surface
18 elevation of the base flood and supporting technical data.

19 **FLOOD-DAMAGE-RESISTANT MATERIALS.** Any construction material, including finishes,
20 capable of withstanding direct and prolonged contact with floodwaters without sustaining any damage
21 that requires more than cosmetic repair.

22 **FLOODPROOFING, DRY.** For buildings and structures that are nonresidential (for flood zone
23 purposes), a combination of design modifications that results in the building’s or structure’s being
24 water tight to the design flood elevation, including the attendant utility and sanitary facilities, with
25 walls substantially impermeable to the passage of water and with structural components having the
26 capacity to resist loads as identified in ASCE 7.

27 **FLOODPROOFING, WET.** A floodproofing method designed to permit parts of the structure below
28 the design flood elevation that are used for parking, storage, building access, or crawl space to
29 intentionally flood, by equalizing hydrostatic pressures and by relying on the use of flood damage-
30 resistant materials and construction techniques.

31 **FLOODWAY.** The channel of the river, creek or other watercourse and the adjacent land areas that
32 must be reserved in order to discharge the base flood without cumulatively increasing the water
33 surface elevation more than a designated height. Floodways are mapped only in the Boroughs of the
34 Bronx and Staten Island.

35 **FLOOR AREA, GROSS.** The floor area within the inside perimeter of the exterior walls of the
36 building under consideration, exclusive of courts, without deduction for corridors, stairways, closets,

- 1 the thickness of interior walls, columns or other features. The floor area of a building, or portion
2 thereof, not provided with surrounded exterior walls shall be the usable area under the horizontal
3 projection of the roof or floor above. The gross floor area shall not include interior courts.
- 4 **FLOOR AREA, NET.** The actual occupied area not including the thickness of walls, partitions,
5 columns, furred-in spaces, fixed cabinets, equipment, and unoccupied accessory areas such as
6 corridors, stairways, toilet rooms, mechanical rooms and closets.
- 7 **FLOOR FIRE DOOR ASSEMBLY.** A combination of a fire door, a frame, hardware and other
8 accessories installed, as an opening protective, in a horizontal plane, which together provide a specific
9 degree of fire protection to a through opening in a fire-resistance-rated floor (see Section 712.1.13.1).
- 10 **FLOOR SURFACE AREA.** See Section 28-101.4.5.2 of the *Administrative Code*.
- 11 **FLUE.** A passageway within a chimney or vent through which gaseous combustion products pass.
- 12 **FLUE APPLIANCE.** The passage(s) within an appliance through which combustion products pass
13 from the combustion chamber of the appliance to the draft hood inlet opening on an appliance
14 equipped with a draft hood or to the outlet of the appliance on an appliance not equipped with a draft
15 hood.
- 16 **FLUE GASES.** Products of combustion and excess air.
- 17 **FLUE LINER (LINING).** A system or material used to form the inside surface of a flue in a chimney
18 vent, for the purpose of protecting the surrounding structure from the effects of combustion products
19 and for conveying combustion products without leakage into the atmosphere.
- 20 **FLY GALLERY.** A raised floor area above a stage from which the movement of scenery and
21 operation of other stage effects are controlled.
- 22 **FLY-THROUGH CONDITIONS.** One or more panels of glass that provide a clear line of sight
23 through such elements creating the illusion of a void leading to the other side, including parallel glass
24 elements, at a distance of 17 feet (5182 mm) or less, or a convergence of glass sides creating a
25 perpendicular, acute or obtuse corner.
- 26 **FOAM PLASTIC INSULATION.** A plastic that is intentionally expanded by the use of a foaming
27 agent to produce a reduced-density plastic containing voids consisting of open or closed cells
28 distributed throughout the plastic for thermal insulating or acoustical purposes and that has a density
29 less than 20 pounds per cubic foot (pcf) (320 kg/m³).
- 30 **FOAM-EXTINGUISHING SYSTEM.** A special system discharging a foam made from
31 concentrates mechanically over the area to be protected.
- 32 **FOLDING AND TELESCOPIC SEATING.** Tiered seating having an overall shape and size that
33 is capable of being reduced for purposes of moving or storing and is not a building element.
- 34 **FOOD COURT.** See Section 402.2.

1 **FOOTING.** A foundation element consisting of an enlargement of a foundation pier or foundation
2 wall, wherein the soil materials along the side of and underlying the element may be visually inspected
3 prior to and during its construction.

4 **FOUNDATION PIER.** An isolated vertical foundation member whose horizontal dimension
5 measured at right angles to its thickness does not exceed three times its thickness and whose height
6 is equal to or less than four times its thickness.

7 **FREE HEADED PILE.** A pile with a head that is free to rotate.

8 **FRONTAGE SPACE.** A street or an open space adjoining a building not less than 30 feet (9144
9 mm) in any dimension. Such open space shall be accessible from a street by a driveway, lane, private
10 road or alley at least 20 feet (6096 mm) in width. Such open space including accessways shall be
11 permanently maintained free of all obstructions that might interfere with its use by the Fire
12 Department.

13 **FUNCTIONALLY DEPENDENT FACILITY.** See Section G201.1.2.

14 **GABLE.** The triangular portion of a wall beneath the end of a dual-slope, pitched, or mono-slope
15 roof or portion thereof and above the top plates of the story or level of the ceiling below.

16 **GAS CABINET.** A fully enclosed, noncombustible enclosure used to provide an isolated
17 environment for compressed gas containers in storage or use, including any doors and access ports
18 for exchanging containers and accessing pressure-regulating controls.

19 **GAS ROOM.** A separately ventilated, fully enclosed room in which only compressed gases and
20 associated equipment and supplies are stored or used.

21 **GEOTECHNICAL CAPACITY OF DEEP FOUNDATIONS.** The load that can be supported by
22 the soil or rock surrounding deep foundation as determined using a recognized method of analysis or
23 as established by load tests. The geotechnical capacity can be developed through skin friction, end
24 bearing, or a combination thereof.

25 **GLASS FIBERBOARD.** Fibrous glass roof insulation consisting of inorganic glass fibers formed
26 into rigid boards using a binder. The board has a top surface faced with asphalt and kraft reinforced
27 with glass fiber.

28 **GRADE (LUMBER).** The classification of lumber in regard to strength and utility in accordance
29 with American Softwood Lumber Standard DOC PS 20 and the grading rules of an approved lumber
30 rules-writing agency.

31 **GRADE PLANE.** A reference plane representing the level of the curb as established by the city
32 engineer in the Borough President's office, measured at the center of the front of a building. Where a
33 building faces on more than one street, the grade plane shall be the average of the levels of the curbs
34 at the center of each front.

35 **Exception:** The grade plan shall not be referenced to the level of the curb, but shall be considered
36 the average elevation of the final grade adjoining all exterior walls of a building, calculated from

1 final grade elevations taken at intervals of 10 feet (3048 mm) around the perimeter of the building
2 where:

3 1. No curb elevation has been legally established on the city map; or
4 2. Every part of the building is setback more than 25 feet (7620 mm) from a street line.

5 **GRANDSTAND.** Tiered seating supported on a dedicated structural system and two or more rows
6 high and is not a building element (see "Bleachers").

7 **GRANULAR SOIL.** Gravel, sand, or silt (coarse grained soil) with little or no clay content. Granular
8 soil has no cohesive strength. Some moist granular soils exhibit apparent cohesion. Granular soil
9 cannot be molded when moist and crumbles easily when dry.

10 **GREEN ROOF SYSTEM.** See definition for "VEGETATIVE ROOF."

11 **GRIDIRON.** The structural framing over a stage supporting equipment for hanging or flying scenery
12 and other stage effects.

13 **GROSS LEASABLE AREA.** See Section 402.2.

14 **GROUND SIGN.** A billboard or similar type of sign that is supported by one or more uprights, poles
15 or braces in or upon the ground other than a combination sign or pole sign, as defined by this code.

16 **GROUP HOME.** A facility for the care and maintenance of not fewer than seven nor more than 12
17 children, supervised by the New York State Board of Social Welfare, and operated pursuant to and
18 meeting any additional construction requirements of Section 374-C of the *New York State Social*
19 *Services Law* and applicable regulations of the New York State Department of Social Services. Such
20 a facility occupied by more than 12 children shall be classified as Group I-1.

21 **GROUT.** A plastic mixture of cementitious materials, aggregates, and water, with or without
22 admixtures, initially produced to pouring consistency without segregation of the constituents during
23 placement, or the equivalent of such mixtures, conforming to ASTM C 476.

24 **GUARD.** A building component or a system of building components located at or near the open sides
25 of elevated walking surfaces that minimizes the possibility of a fall from the walking surface to a
26 lower level.

27 **GUARDRAIL SYSTEM (SCAFFOLD).** A vertical barrier as described in Section 3314.8
28 consisting of, but not limited to, top rails, mid rails and posts, erected to prevent falling from a scaffold
29 platform or walkway to lower levels.

30 **GUY.** A rope used to steady or secure the mast or other members in the desired position.

31 **GYPSON BOARD.** Gypsum wallboard, gypsum sheathing, gypsum base for gypsum veneer plaster,
32 exterior gypsum soffit board, predecorated gypsum board or water-resistant gypsum backing board
33 complying with the standards listed in Tables 2506.2, 2507.2 and Chapter 35.

1 **GYPSUM PANEL PRODUCTS.** The general name for a family of sheet products consisting
2 essentially of gypsum.

3 **GYPSUM PLASTER.** A mixture of calcined gypsum or calcined gypsum and lime and aggregate
4 and other approved materials as specific in this code.

5 **GYPSUM VENEER PLASTER.** Gypsum plaster applied to an approved base in one or more coats
6 normally not exceeding 1/4 inch (6.4 mm) in total thickness.

7 **HABITABLE SPACE.** All rooms and spaces within a dwelling unit in Group R or I-1, including
8 bedrooms, living rooms, studies, recreation rooms, kitchens, dining rooms and other similar spaces.

9 **Exception:** The following spaces within a dwelling unit shall not be considered habitable space:

- 10 1. A dining space 55 square feet (5.1 m²) or less located off a living room, foyer or kitchen;
- 11 2. A kitchenette;
- 12 3. A bathroom or toilet room;
- 13 4. A laundry room; and
- 14 5. A corridor, passageway, or private hall; and a foyer used as an entrance hall in a dwelling
15 unit: not exceeding 10 percent of the total floor area of the dwelling unit; or not exceeding
16 20 percent of the floor area of the dwelling unit where every habitable room is at least 20
17 percent larger than the required minimum room sizes established by the New York City
18 Housing Maintenance Code.

19 **HALL CALL CONSOLE.** A collection of features arranged in close proximity to one another, the
20 purpose of which is to call a destination-oriented elevator car to an elevator landing on which the
21 console is provided. Such features can be provided as a single assembly or as individual elements
22 functioning together.

23 **HALOGENATED EXTINGUISHING SYSTEM.** A fire-extinguishing system using one or more
24 atoms of an element from the halogen chemical series; fluorine, chlorine, bromine and iodine.

25 **HANDHELD DEVICE (DEMOLITION).** Equipment, mechanical or non-mechanical, utilized to
26 physically demolish a building or structure, or elements of a building or structure, that is held, lifted,
27 moved, and operated by a single person. A handheld device shall also include any item accessory to
28 such equipment, including but not limited to a compressor, regardless of if such accessory item is
29 held, lifted, moved, and operated by a single person. A handheld device does not include remote
30 controlled equipment.

31 **HANDLING (HAZARDOUS MATERIAL).** The movement of a material in its container, the
32 removal of the material from its container, or any other action or process that may affect the material,
33 other than its storage or use.

34 **HANDRAIL.** A horizontal or sloping rail intended for grasping by the hand for guidance or support.

- 1 **HARDBOARD.** A fibrous-felted, homogeneous panel made from lignocellulosic fibers consolidated
2 under heat and pressure in a hot press to a density not less than 31 pcf (497 kg/m³).
- 3 **HAZARDOUS MATERIALS.** Those chemicals or substances that are physical hazards or health
4 hazards as defined and classified in the *New York City Fire Code* and this code, whether the materials
5 are in usable or waste condition.
- 6 **HAZARDOUS PRODUCTION MATERIAL (HPM).** A solid, liquid or gas associated with
7 semiconductor manufacturing that has a degree-of-hazard rating in health, flammability or instability
8 of Class 3 or 4 as defined in NFPA 704 and that is used directly in research, laboratory or production
9 processes that have as their end product materials that are not hazardous.
- 10 **HEAD JOINT.** Vertical mortar joint placed between masonry units within the wythe at the time the
11 masonry units are laid.
- 12 **HEALTH HAZARD.** A classification of a chemical for which there is statistically significant
13 evidence that acute or chronic health effects are capable of occurring in exposed persons. The term
14 "health hazard" includes chemicals that are toxic or highly toxic, and corrosive.
- 15 **HEAVY DUTY SCAFFOLD.** A supported scaffold capable of supporting loads of up to 75 pounds
16 per square foot (366.15 kg/m²), and not more than those imposed by workers and heavy material,
17 including but not limited to stone.
- 18 **HEAVY DUTY SIDEWALK SHED.** A sidewalk shed designed to carry a live load of at least 300
19 pounds per square foot (1465 kg/m²).
- 20 **HEIGHT, BUILDING.** The vertical distance from the grade plane to the average height of the
21 highest roof surfaces.
- 22 **HELICAL PILES.** Helical piles are manufactured deep foundation steel elements consisting of a
23 shaft and one or more helical bearing plates (helices) screwed into the ground by application of torque
24 on the shaft. The various products marketed as screw piles, torque anchors, and helical piles are
25 considered helical piles.
- 26 **HELIPAD.** A structural surface that is used for the landing, taking off, taxiing and parking of
27 helicopters.
- 28 **HELIPORT.** An area of land or water or a structural surface that is used, or intended for the use, for
29 the landing and taking off of helicopters, and any appurtenant areas that are used, or intended for use,
30 for heliport buildings or other heliport facilities.
- 31 **HELISTOP.** The same as "heliport," except that no fueling, defueling, maintenance, repairs or
32 storage of helicopters is permitted.
- 33 **HIGHLY TOXIC MATERIAL.** A chemical that is lethal at the following doses or concentrations:
- 34 1. A chemical that has a median lethal dose (LD₅₀) of 50 milligrams or less per kilogram of body
35 weight when administered orally to albino rats weighing between 200 and 300 grams each;

1 2. A chemical that has a median lethal dose (LD₅₀) of 200 milligrams or less per kilogram of
2 body weight when administered by continuous contact for 24 hours (or less if death occurs
3 within 24 hours) with the bare skin of albino rabbits weighing between 2 and 3 kilograms
4 each; or

5 3. A chemical that has a median lethal concentration (LC₅₀) in air of 200 parts per million by
6 volume or less of gas or vapor, or 2 milligrams per liter or less of mist, fume or dust, when
7 administered by continuous inhalation for 1 hour (or less if death occurs within 1 hour) to
8 albino rats weighing between 200 and 300 grams each.

9 **HIGH-PRESSURE BOILER.** See Section 28-401.3 of the *Administrative Code*.

10 **HIGH-PRESSURE DECORATIVE EXTERIOR-GRADE COMPACT LAMINATE (HPL).**
11 An exterior wall covering fabricated using HPL in a specific assembly including joints, seams,
12 attachments, substrate, framing and other details as appropriate to a particular design.

13 **HIGH-RISE BUILDING.** A building with an occupied floor located more than 75 feet (22
14 860 mm) above the lowest level of fire department vehicle access.

15 **HISTORIC STRUCTURE.** A building or structure which is a designated New York City landmark
16 or interior landmark, is located within a designated New York City historic district, or is listed on the
17 New York State or National Register of Historic Places.

18 **HISTORIC STRUCTURE (FLOOD-RESISTANT CONSTRUCTION).** See Section G201.1.2.

19 **HOISTING EQUIPMENT.** Power or manually operated equipment that raises or lowers a
20 suspended load. The definition of hoisting equipment shall also include a hoisting machine, bucket
21 hoist, material hoist, personnel hoist, or industrial rope access equipment. The definition of hoisting
22 equipment shall not include an elevator, mast climber, or scaffold.

23 **HOISTING MACHINE.** A power operated machine that lifts or lowers a suspended load utilizing
24 a drum and a rope. The definition of hoisting machine shall also include a crane, derrick, cableway,
25 or telehandler. The definition of hoisting machine shall not include an elevator, mast climber, or
26 scaffold.

27 **HOISTING MECHANISM.** A hoist drum and rope reeving system used for lifting and lowering
28 loads.

29 **HOISTWAY.** The hoistway is the opening through a building or structure for the travel of elevators,
30 dumbwaiters, or material lifts, extending from the pit floor to the roof or floor above.

31 **HOLD-DOWN.** See “TIE-DOWN”.

32 **HORIZONTAL ASSEMBLY.** A fire-resistance-rated floor or roof assembly of materials designed
33 to restrict the spread of fire in which continuity of the fire-resistance rating is maintained.

34 **HOSPITALS AND PSYCHIATRIC CENTERS.** See Section 308.2.

35 **HOUSING UNIT.** See Section 408.1.1.

- 1 **H-PILES.** Steel H-piles are constructed by driving a steel H-shaped section into the ground.
- 2 **HPM FLAMMABLE LIQUID.** An HPM liquid that is defined as either a Class I flammable liquid
3 or a Class II or Class IIIA combustible liquid.
- 4 **HPM ROOM.** A room used in conjunction with or serving a Group H-5 occupancy, where HPM is
5 stored or used and that is classified as a Group H-2, H-3 or H-4 occupancy.
- 6 **HURRICANE-PRONE REGIONS.** New York City is within the hurricane-prone region for Risk
7 Category II, III, and IV buildings.
- 8 **HYDROGEN FUEL GAS ROOM.** A separately ventilated, fully enclosed room designed to
9 exclusively house the generation of gaseous hydrogen for immediate on-premises use in indoor fuel
10 cells or other energy production process, and incidental indoor storage of gaseous hydrogen. A
11 hydrogen fuel gas room is not intended to house the production or dispensing of hydrogen motor
12 fuel.
- 13 **I-4 MIX.** A type of heavy duty asphaltic concrete mix containing 0.75 inch (19 mm) nominal
14 maximum size aggregate with 25 percent to 50 percent of the aggregate capable of passing through
15 a No. 8 sieve and in which all sand contained in the mix is crushed.
- 16 **ICE-SENSITIVE STRUCTURE.** A structure for which the effect of an atmospheric ice load
17 governs the design of a structure or portion thereof. This includes, but is not limited to, lattice
18 structures, guyed masts, overhead lines, light suspension and cable-stayed bridges, aerial cable
19 systems (e.g., for ski lifts or logging operations), amusement rides, open catwalks and platforms,
20 flagpoles and signs.
- 21 **IMMEDIATELY DANGEROUS TO LIFE AND HEALTH (IDLH).** The concentration of air-
22 borne contaminants that poses a threat of death, immediate or delayed permanent adverse health
23 effects, or effects that could prevent escape from such an environment as established by the National
24 Institute of Occupational Safety and Health (NIOSH) based on both toxicity and flammability. It
25 generally is expressed in parts per million by volume (ppm v/v) or milligrams per cubic meter
26 (mg/m³). If adequate data do not exist for precise establishment of IDLH concentrations, an
27 independent certified industrial hygienist, industrial toxicologist, appropriate regulatory agency or
28 other source approved by the Fire Commissioner shall make such determination.
- 29 **IMPACT LOAD.** The load resulting from moving machinery, elevators, craneways, vehicles and
30 other similar forces and kinetic loads, pressure and possible surcharge from fixed of moving loads.
- 31 **IMPORTANCE FACTOR, I.** A factor that accounts for the degree of hazard to human life and
32 damage to property.
- 33 **INCAPABLE OF SELF-PRESERVATION.** Persons who, because of age, physical limitations,
34 mental limitations, chemical dependency or medical treatment, cannot respond as an individual to
35 an emergency situation.
- 36 **INCIDENT.** An occurrence directly caused by construction or demolition activity or site conditions
37 that result in one or more of the following:

- 1 1. A fatality to a member of the public;
- 2 2. Any type of injury to a member of the public;
- 3 3. A fatality to a worker;
- 4 4. An injury to a worker that requires transport by emergency medical services or requires
5 immediate emergency care at a hospital or offsite medical clinic;
- 6 5. Any complete or partial structural collapse or material failure;
- 7 6. Any complete or partial collapse or failure of pedestrian protection, scaffolding, hoisting
8 equipment, or material handling equipment; or
- 9 7. Any material fall exterior to the building or structure.

10 **INCOMPATIBLE MATERIALS.** Materials that, if mixed or combined, could explode, generate
11 heat, gases or other byproducts, or react in such a way that are hazardous to life or property.

12 **INDUSTRIAL ROPE ACCESS.** The use of rope access equipment in which a person descends or
13 ascends on a rope, or traverses along a rope, and in which the ropes are used as the primary means
14 of support and positioning. Industrial rope access does not include window washing.

15 **INERT GAS.** A gas that is capable of reacting with other materials only under abnormal conditions
16 such as high temperatures, pressures and similar extrinsic physical forces. Within the context of the
17 code, inert gases do not exhibit either physical or health properties as defined (other than acting as a
18 simple asphyxiant) or hazard properties other than those of a compressed gas. Some of the more
19 common inert gases include argon, helium, krypton, neon, nitrogen and xenon.

20 **INITIATING DEVICE.** A system component that originates transmission of a change-of-state
21 condition, such as in a smoke detector, manual fire alarm box or supervisory switch.

22 **INSTALLING/INSTALLATION/INSTALL (SCAFFOLD).** The initial installation or
23 reinstallation of a scaffold at a site.

24 **Initial installation (scaffold).** The initial assembly, set-up, or placement of a scaffold at a site.

25 **Reinstallation (scaffold).** The addition, relocation, or removal of any part, component, or
26 attachment to a scaffold at a site, including but not limited to counterweights, tie-backs,
27 anchorage, or connections to the building or structure, that occurs subsequent to the initial
28 installation, and which does not otherwise occur in an automated, automatic fashion, as part of
29 the normal use of the scaffold.

30 **INTENDED TO BE OCCUPIED AS A RESIDENCE.** This refers to a dwelling unit or sleeping
31 unit that can or will be used all or part of the time as the occupant's place of abode.

32 **INTERIOR EXIT RAMP.** An exit component that serves to meet one or more means of egress
33 design requirements, such as required number of exits or exit access travel distance, and provides
34 for a protected path of egress travel to the exit discharge or public way.

- 1 **INTERIOR EXIT STAIRWAY.** A stairway not meeting the definition of an exterior exit stairway.
- 2 **INTERIOR FINISH.** Interior finish includes interior wall and ceiling finish and interior floor finish.
- 3 **INTERIOR FLOOR FINISH.** The exposed floor surfaces of buildings including coverings applied
4 over a finished floor or stair, including risers.
- 5 **INTERIOR FLOOR-WALL BASE.** Interior floor finish trim used to provide a functional or
6 decorative border at the intersection of walls and floors.
- 7 **INTERIOR SURFACES.** Surfaces other than weather-exposed surfaces.
- 8 **INTERIOR WALL AND CEILING FINISH.** The exposed interior surfaces of buildings
9 including, but not limited to: fixed or movable walls and partitions; toilet room privacy partitions;
10 columns; ceilings; and interior wainscoting, paneling or other finish applied structurally or for
11 decoration, acoustical correction, surface insulation, structural fire resistance or similar purposes,
12 but not including trim.
- 13 **INTERLAYMENT.** A layer of felt or nonbituminous saturated felt not less than 18 inches (457 mm)
14 wide, shingled between each course of a wood-shake roof covering.
- 15 **INTUMESCENT FIRE-RESISTANT COATINGS.** Thin film liquid mixture applied to substrates
16 which expands into a protective foamed layer to provide fire-resistant protection of the substrates
17 when exposed to flame or intense heat.
- 18 **JIB.** An extension attached to the boom point to provide added boom length for lifting specified
19 loads. The jib may be in line with the boom or offset to various angles in the vertical plane of the
20 boom.
- 21 **JOINT.** The opening in or between adjacent assemblies that is created due to building tolerances,
22 or is designed to allow independent movement of the building in any plane caused by thermal,
23 seismic, wind or any other loading.
- 24 **JUMP (JUMPING or CLIMBING).** The raising or lowering of a tower crane to a new working
25 height. This can include, but is not limited to, the process of adding or removing mast or tower
26 sections to equipment that has already been erected.
- 27 **KEY ELEMENT.** An element of the structural system, including its connections, that meets one or
28 more of the following criteria:
- 29 1. An element which when lost, results in more than local collapse.
- 30 2. An element that braces a key element, the failure of which results in failure of the key element
31 (further secondary elements need not be considered key elements).
- 32 3. An element whose tributary area exceeds 3,000 square feet (279 m²) on a single level.
- 33 **KITCHEN.** A room with 80 square feet (7.4 m²) or more of floor area that is intended, arranged,
34 designed or used for cooking or warming of food.

- 1 **KITCHENETTE.** A space with less than 80 square feet (7.4 m²) of floor area that is intended,
2 arranged, designed or used for cooking or warming of food.
- 3 **L RATING.** The air leakage rating of a through-penetration firestop system or a fire-resistant joint
4 system when tested in accordance with UL 1479 or UL 2079, respectively.
- 5 **LABORATORY BUILDING.** See Section 427.4.
- 6 **LABORATORY CHEMICAL.** See Section 427.4.
- 7 **LABORATORY, NONPRODUCTION.** See Section 427.4.
- 8 **LABORATORY UNIT.** See Section 427.4.
- 9 **LAYERED (SOIL).** Two or more distinctly different soil or rock types arranged in layers.
10 Micaceous seams or weakened planes in rock or shale are considered layered.
- 11 **LETTER OF MAP AMENDMENT (LOMA).** See Section G201.1.2.
- 12 **LETTER OF MAP REVISION BASED ON FILL (LOMR-F).** See Section G201.1.2.
- 13 **LETTER OF MAP REVISION (LOMR).** See Section G201.1.2.
- 14 **LIGHT DUTY SCAFFOLD.** A supported scaffold capable of supporting loads of up to 25 pounds
15 per square foot (122.05 kg/m²), and not more than those imposed by workers and lightweight
16 material, including but not limited to wood or paint.
- 17 **LIGHT DUTY SIDEWALK SHED.** A sidewalk shed designed to carry a live load of at least 150
18 pounds per square foot (732.3 kg/m²).
- 19 **LIGHT-DIFFUSING SYSTEM.** Construction consisting in whole or in part of lenses, panels, grids
20 or baffles made with light-transmitting plastics positioned below independently mounted electrical
21 light sources, skylights or light-transmitting plastic roof panels. Lenses, panels, grids and baffles that
22 are part of an electrical fixture shall not be considered as a light-diffusing system.
- 23 **LIGHT-FRAME CONSTRUCTION.** A type of construction whose vertical and horizontal
24 structural elements are primarily formed by a system of repetitive wood or cold-formed steel framing
25 members.
- 26 **LIGHT-TRANSMITTING PLASTIC ROOF PANELS.** Structural plastic panels other than
27 skylights that are fastened to structural members, or panels or sheathing, and that are used as light-
28 transmitting media in the plane of the roof.
- 29 **LIGHT-TRANSMITTING PLASTIC WALL PANELS.** Plastic materials that are fastened to
30 structural members, or to structural panels or sheathing, and that are used as light-transmitting media
31 in exterior walls.
- 32 **LIMIT STATE.** A condition beyond which a structure or member becomes unfit for service and is
33 judged to be no longer useful for its intended function (serviceability limit state) or to be unsafe
34 (strength limit state).

1 **LIMITED AREA SPRINKLER SYSTEM.** An automatic sprinkler system serving fewer than 6
2 sprinkler heads on any single connection.

3 **LIMITED SITE SAFETY TRAINING (SST) CARD.** A card that is issued before the SST full
4 compliance date, in a form and manner established by the department and that satisfies each of the
5 following conditions:

6 1. Such card is issued by an SST provider to a person who submits an application to such
7 provider demonstrating, in a form and manner established by the department, that such
8 applicant satisfies the requirements of Item 1.1, 1.2 or 1.3:

9 1.1. Such applicant has successfully completed (i) an OSHA 10-hour class and (ii) 20
10 additional SST credits specified by the department, including eight SST credits
11 relating to safeguarding against the dangers posed by falling workers and objects.

12 1.2. Such applicant has successfully completed an OSHA 30-hour class.

13 1.3. Such applicant has successfully completed a 100-hour training program.

14 2. If such applicant completed the training to comply with Item 1.1, 1.2 or 1.3 but did not
15 complete such training within the five years preceding submission of such application, such
16 applicant has, in the one-year period preceding submission of such application, completed at
17 least eight SST credits specified by the department.

18 3. Such card is issued by an SST provider who does not require applicants to submit any
19 information except for (i) the information necessary to establish that the requirements in Item
20 1 have been satisfied, as specified by the department, (ii) a photograph of the applicant and
21 (iii) such additional information as the department may allow by rule.

22 4. Such card expires on the day before the SST full compliance date and is not renewable.

23 **LIQUEFACTION.** For granular soils, liquefaction is defined as the loss of shear strength in soils
24 resulting from increased pore-water pressure and reduced effective stress that may develop as a result
25 of cyclic loading during earthquakes. For cohesive soils with a plasticity index of less than 20,
26 liquefaction is defined as any transient softening and increased cyclic shear strains that may occur
27 during earthquakes.

28 **LIQUID.** A material that has a melting point that is equal to or less than 68°F (20°C) and a boiling
29 point that is greater than 68°F (20°C) at 14.7 pounds per square inch absolute (psia) (101 kPa). When
30 not otherwise identified, the term "liquid" includes both flammable and combustible liquids.

31 **LIQUID STORAGE ROOM.** A room classified as Group H-3 occupancy used for the storage of
32 flammable or combustible liquids in an unopened condition.

33 **LIQUID USE, DISPENSING AND MIXING ROOM.** A room in which Class I, II and IIIA
34 flammable or combustible liquids are used, dispensed or mixed in open containers.

1 **LIVE LOAD.** A load produced by the use and occupancy of the building or other structure and do
2 not include construction or environmental loads such as wind load, snow load, rain load, earthquake
3 load, flood load or dead load.

4 **LIVE LOAD (ROOF).** A load on a roof produced:

- 5 1. During maintenance by workers, equipment and materials;
- 6 2. During the life of the structure by movable objects such as planters or other small decorative
7 appurtenances that are not occupancy related; or
- 8 3. By the use and occupancy of the roof such as for roof gardens or assembly areas.

9 **LOAD AND RESISTANCE FACTOR DESIGN (LRFD).** A method of proportioning structural
10 members and their connections using load and resistance factors such that no applicable limit state is
11 reached when the structure is subjected to appropriate load combinations. The term "LRFD" is used
12 in the design of steel and wood structures.

13 **LOAD BLOCK, LOWER.** The assembly of hook or shackle, swivel, sheaves, pins, and frame
14 suspended by the hoisting ropes.

15 **LOAD BLOCK, UPPER.** The assembly of shackle, swivel, sheaves, pins, and frame suspended from
16 the boom point.

17 **LOAD EFFECTS.** Forces and deformations produced in structural members by the applied loads.

18 **LOAD FACTOR.** A factor that accounts for deviations of the actual load from the nominal load; for
19 uncertainties in the analysis that transforms the load into a load effect, and for the probability that
20 more than one extreme load will occur simultaneously.

21 **LOAD RATING CHART.** A full and complete range of manufacturer's load ratings at all stated
22 operating radii, boom angles, work areas, boom lengths and configurations, jib lengths and angles (or
23 offset), as well as alternative ratings for use and nonuse of optional equipment, such as outriggers and
24 extra counterweights, that affect ratings.

25 **LOAD RATINGS.** Crane and derrick ratings in pounds (kilograms) established by the manufacturer
26 in accordance with standards set forth in rules promulgated by the commissioner.

27 **LOAD (WORKING).** The external load, in pounds (kilograms), applied to the crane or derrick,
28 including the weight or auxiliary load attaching equipment, such as lower load blocks, shackles, and
29 slings.

30 **LOADS.** Forces or other actions that result from the weight of building materials, occupants and their
31 possessions, environmental effects, differential movement and restrained dimensional changes.
32 Permanent loads are those loads in which variations over time are rare or of small magnitude, such as
33 dead loads. All other loads are variable loads (see also "Nominal loads").

34 **LOCAL COLLAPSE.** Failure of a structural element that results in the collapse of areas being
35 directly supported by that element and not extending vertically more than three stories.

1 **LOT.** A portion or parcel of land considered as a unit.

2 **LOT.** A portion or parcel of land considered as a unit.

3 **LOT LINE.** A line dividing one lot from another, or from a street or any public place.

4 **LOT, TAX.** A portion or parcel of land classified as such by the department of finance. Where a
5 tax lot line shifts in a vertical plane, the commissioner shall determine the manner in which
6 provisions of this code apply with respect to measurements to or from such tax lot lines, in order to
7 protect public safety.

8 **LOW ENERGY POWER-OPERATED DOOR.** Swinging door that opens automatically upon an
9 action by a pedestrian such as pressing a push plate or waving a hand in front of a sensor. The door
10 closes automatically, and operates with decreased forces and decreased speeds (See "Power-assisted
11 door" and "Power-operated door").

12 **LOWER FLAMMABLE LIMIT (LFL).** The minimum concentration of vapor in air at which
13 propagation of flame will occur in the presence of an ignition source. The LFL is sometimes referred
14 to as "LEL" or "lower explosive limit."

15 **LOWEST FLOOR.** The lowest floor of the lowest enclosed area, including crawl spaces and
16 basements (for flood zone purposes).The lowest floor shall not include any wet floodproofed spaces
17 usable solely for vehicle parking, building access, storage or crawl space, provided that such enclosure
18 is not built so as to render the structure in violation of Appendix G, including that:

19 1. Such enclosure shall allow for the automatic entry and exit of floodwaters;

20 2. Such enclosure shall be constructed solely of flood-resistant materials and finishes;

21 3. Such enclosure shall have a floor elevation equal to or higher than the outside adjacent grade
22 on at least one side; and

23 4. Such outside adjacent grade shall slope down, towards the source of flooding, providing
24 positive drainage by gravity, thus preventing accumulations of water under or in the structure
25 after the floodwaters recede without the use of pumps, pipes or drains.

26 **MAILBOXES.** Receptacles for the receipt of documents, packages or other deliverable matter.
27 Mailboxes include, but are not limited to, post office boxes and receptacles provided by commercial
28 mail-receiving agencies, apartment houses and schools.

29 **MAIN WIND FORCE-RESISTING SYSTEM.** An assemblage of structural elements assigned to
30 provide support and stability for the overall structure. The system generally receives wind loading
31 from more than one surface.

32 **MAINTENANCE (SCAFFOLD).** Regular or periodic upkeep as specified by the manufacturer to
33 keep the scaffold, including all parts or components, in like new condition and safe working order,
34 and that does not otherwise meet the definition of an installation, removal, or repair.

35 **MAJOR BUILDING.** An existing or proposed building 10 or more stories or 125 feet (38 100 mm)
36 or more in height, or an existing or proposed building with a building footprint of 100,000 square feet

1 (30 480 m²) or more regardless of height, or an existing or proposed building so designated by the
2 commissioner due to unique hazards associated with the construction or demolition of the structure.

3 **MANUAL FIRE ALARM BOX.** A manually operated device used to initiate an alarm signal.

4 **MANUFACTURE DATE (Crane).** For a particular crane, the earlier of the following dates:

5 1. The date the crane was originally manufactured for its intended purpose.

6 2. The date that the oldest major component of the crane was originally manufactured.

7 **MANUFACTURED HOME.** See Section G201.1.2.

8 **MANUFACTURED HOME PARK OR SUBDIVISION.** See Section G201.1.2.

9 **MARKET VALUE OF STRUCTURE.** See Section G201.1.2.

10 **MARQUEE.** A permanent roofed structure attached to and supported by the building and that
11 projects into the public right-of-way.

12 **MASONRY.** A built-up construction or combination of building units or materials of clay, shale,
13 concrete, glass, gypsum, stone or other approved units bonded together with or without mortar or
14 grout or other accepted methods of joining.

15 **Glass unit masonry.** Masonry composed of glass units bonded by mortar.

16 **Plain masonry.** Masonry in which the tensile resistance of the masonry is taken into consideration
17 and the effects of stresses in reinforcement are neglected.

18 **Reinforced masonry.** Masonry construction in which reinforcement acting in conjunction with
19 the masonry is used to resist forces.

20 **Solid masonry.** Masonry consisting of solid masonry units laid contiguously with the joints
21 between the units filled with mortar.

22 **Unreinforced (plain) masonry.** Masonry in which the tensile resistance of masonry is taken into
23 consideration and the resistance of the reinforcing steel, if present, is neglected.

24 **MASONRY UNIT.** Brick, tile, stone, glass block or concrete block conforming to the requirements
25 specified in Section 2103.

26 **Hollow.** A masonry unit whose net cross-sectional area in any plane parallel to the load-bearing
27 surface is less than 75 percent of its gross cross-sectional area measured in the same plane.

28 **Solid.** A masonry unit whose net cross-sectional area in every plane parallel to the load-bearing
29 surface is 75 percent or more of its gross cross-sectional area measured in the same plane.

30 **MASS CONCRETE.** Any volume of concrete with dimensions large enough to require that measures
31 be taken to cope with generation of heat from hydration of the cement and attendant volume change
32 to minimize cracking, reduction of compressive strength, and/or delayed ettringite formation.

1 **MAST CLIMBER.** A powered device consisting of an elevating platform mounted on a base or
2 chassis and mast, that when erected is capable of supporting personnel, material, equipment and tools
3 on a deck or platform that is capable of traveling vertically in infinitely adjustable increments to reach
4 the desired work level.

5 **MASTIC FIRE-RESISTANT COATINGS.** Liquid mixture applied to a substrate by brush, roller,
6 spray or trowel that provides fire-resistant protection of a substrate when exposed to flame or intense
7 heat.

8 **MATERIAL HANDLING EQUIPMENT.** Power or manually operated equipment that moves or
9 transports material or personnel during the construction or demolition of a building or structure.
10 Material handling equipment shall not include an elevator, hoisting equipment, mast climber, or
11 scaffold.

12 **MATERIAL HOIST (MATERIAL HOISTING EQUIPMENT).** A power or manually operated
13 platform, car, or cage, that (i) is temporarily installed at a construction or demolition site, (ii) moves
14 vertically on guide members to raise or lower material, and (iii) is controlled from a point outside the
15 conveyance.

16 **MAXIMUM CONSIDERED EARTHQUAKE GEOMETRIC MEAN (MCE_G) PEAK**
17 **GROUND ACCELERATION.** The most severe earthquake effects considered by this standard
18 determined for geometric mean peak ground acceleration and without adjustment for targeted risk.
19 The MCE_G peak ground acceleration adjusted for site effects (PGAM) is used in this standard for
20 evaluation of liquefaction, lateral spreading, seismic settlements, and other soil-related issues. The
21 PGAM values adjusted for site effects are provided in Table 1816.2.1 or can be derived from the site-
22 specific procedures provided in Section 21.5 of ASCE 7.

23 **MAXIMUM CONSIDERED EARTHQUAKE (MCE) GROUND MOTION.** The most severe
24 earthquake effects considered by this code more specifically defined in the terms, maximum
25 considered earthquake geometric mean (MCE_G) peak ground acceleration and risk-targeted maximum
26 considered earthquake (MCE_R) ground motion response acceleration.

27 **MEAN ROOF HEIGHT.** The average of the roof eave height and the height to the highest point on
28 the roof surface, except that eave height shall be used for roof angle of less than or equal to 10
29 degrees (0.1745 rad).

30 **MEANS OF EGRESS.** A continuous and unobstructed path of vertical and horizontal egress travel
31 from any occupied portion of a building or structure to a public way. A means of egress consists of
32 three separate and distinct parts: the exit access, the exit and the exit discharge.

33 **MECHANICAL-ACCESS OPEN PARKING GARAGE.** Open parking garages employing
34 parking machines, lifts, elevators or other mechanical device for vehicles moving from and to street
35 level and in which public occupancy is prohibited above the street level.

36 **MECHANICAL DEMOLITION EQUIPMENT.** Mechanically driven or powered equipment that
37 is utilized to physically demolish a building or structure, or elements of a building or structure, either
38 within or exterior to the building or structure, or that is utilized to move debris or material within the

1 building or structure. Mechanical demolition equipment shall not include mechanically driven or
2 powered equipment that is utilized to move debris or material outside of the building or structure.

3 **MECHANICAL EQUIPMENT SCREEN.** A partially enclosed rooftop structure used to
4 aesthetically conceal heating, ventilating and air conditioning (HVAC) electrical or mechanical
5 equipment from view.

6 **MECHANICAL SYSTEMS (STRUCTURAL).** For the purposes of determining seismic loads in
7 this code, mechanical systems shall also include fire protection, plumbing and fuel gas systems as
8 specified therein.

9 **MEDIUM DUTY SCAFFOLD.** A supported scaffold capable of supporting loads of up to 50 pounds
10 per square foot (244.1 kg/m²), and not more than those imposed by workers and moderate material,
11 including but not limited to brick and pipe.

12 **MEMBRANE PENETRATION.** A breach in one side of a floor-ceiling, roof-ceiling or wall
13 assembly to accommodate an item installed into or passing through the breach.

14 **MEMBRANE-COVERED CABLE STRUCTURE.** A nonpressurized structure in which a mast
15 and cable system provides support and tension to the membrane weather barrier and the membrane
16 imparts stability to the structure.

17 **MEMBRANE-COVERED FRAME STRUCTURE.** A nonpressurized building wherein the
18 structure is composed of a rigid framework to support a tensioned membrane that provides the weather
19 barrier.

20 **MEMBRANE-PENETRATION FIRESTOP.** A material, device, or assemblage of specific
21 materials or products that is designed, tested and fire-resistance rated to resist for a prescribed time
22 period the passage of flame and heat through openings in a protective membrane in order to
23 accommodate cables, cable trays, conduit, tubing, piping or similar items.

24 **MEMBRANE-PENETRATION FIRESTOP SYSTEM.** An assemblage consisting of a fire-
25 resistance-rated floor-ceiling, roof-ceiling or wall assembly, one or more penetrating items installed
26 into or passing through the breach in one side of the assembly and the materials or devices, or both,
27 installed to resist the spread of fire into the assembly for a prescribed period of time.

28 **MERCHANDISE PAD.** A merchandise pad is an area for display of merchandise surrounded by
29 aisles, permanent fixtures or walls. Merchandise pads contain elements such as nonfixed and
30 moveable fixtures, cases, racks, counters and partitions from which customers browse or shop.

31 **METAL COMPOSITE MATERIAL (MCM).** A factory-manufactured panel consisting of metal
32 skins bonded to both faces of a plastic core.

33 **METAL COMPOSITE MATERIAL (MCM) SYSTEM.** An exterior wall covering fabricated
34 using MCM in a specific assembly including joints, seams, attachments, substrate, framing and other
35 details as appropriate to a particular design.

36 **METAL ROOF PANEL.** An interlocking metal sheet having a minimum installed weather exposure
37 of 3 square feet (.279 m²) per sheet.

- 1 **METAL ROOF SHINGLE.** An interlocking metal sheet having an installed weather exposure less
2 than 3 square feet (.279 m²) per sheet.
- 3 **MEZZANINE.** An intermediate level or levels between the floor and ceiling of any story in
4 accordance with Section 505.
- 5 **MICROPILE.** A micropile is a drilled and grouted deep foundation element with a diameter that
6 measures 5 inches (127 mm) to 14 inches (356 mm) that develops its load-carrying capacity by means
7 of a bond zone in soil (also commonly known as a minipile).
- 8 **MINERAL BOARD.** A rigid felted thermal insulation board consisting of either felted mineral fiber
9 or cellular beads of expanded aggregate formed into flat rectangular units.
- 10 **MINERAL FIBER.** Insulation composed principally of fibers manufactured from rock, slag or glass,
11 with to without binders.
- 12 **MINERAL WOOL.** Synthetic vitreous fiber insulation made by melting predominantly igneous rock
13 or furnace slag, and other inorganic materials, and then physically forming the melt into fibers.
- 14 **MINOR ALTERATIONS.** See Section 105.4.2 of the *Administrative Code*.
- 15 **MOBILE CRANE.** A crane equipped with rubber-tired wheels or crawler treads for travel. The
16 definition of mobile crane shall include, but is not limited, to a commercial truck mounted crane,
17 crawler crane, wheel mounted crane (multiple control stations) or wheel mounted crane (single
18 control station). The definition of mobile crane shall not include a truck mounted crane or a self-
19 erecting tower crane.
- 20 **MOBILE SCAFFOLD.** A powered or unpowered, portable, caster, track or wheel-mounted
21 supported scaffold.
- 22 **MODIFIED BITUMEN ROOF COVERING.** One or more layers of polymer-modified asphalt
23 sheets. The sheet materials shall be fully adhered or mechanically attached to the substrate or held in
24 place with an approved ballast layer.
- 25 **MOIST (SOIL).** A condition in which a soil looks and feels damp. Moist cohesive soil can easily be
26 shaped into a ball and rolled into small diameter threads before crumbling. Moist granular soil that
27 contains some cohesive material will exhibit signs of cohesion between particles.
- 28 **MONOPOLE SIGN.** A ground sign wholly supported by a single pole structure.
- 29 **MORTAR.** A mixture consisting of cementitious materials, fine aggregates, water, with or without
30 admixtures, that is used to construct unit masonry assemblies.
- 31 **MORTAR, SURFACE-BONDING.** A mixture to bond concrete masonry units that contains
32 hydraulic cement, glass fiber reinforcement with or without inorganic fillers or organic modifiers and
33 water.
- 34 **MULTILEVEL ASSEMBLY SEATING.** Seating that is arranged in distinct levels where each
35 level is comprised of either multiple rows, or single row of box seats accessed from a separate level.

- 1 **MULTIPLE-STATION ALARM DEVICE.** Two or more single-station alarm devices that can be
2 interconnected such that actuation of one causes all integral or separate audible alarms to operate. A
3 multiple-station alarm device can consist of one single-station alarm device having connections to
4 other detectors or to a manual fire alarm box.
- 5 **MULTIPLE-STATION SMOKE ALARM.** Two or more single-station alarm devices that are
6 capable of interconnection such that actuation of one causes the appropriate alarm signal to operate
7 in all interconnected alarms and not connected to a fire alarm system.
- 8 **MULTIPOINT ADJUSTABLE SUSPENDED SCAFFOLD.** A suspended scaffold consisting of a
9 platform(s) that is suspended by more than two ropes from overhead supports and equipped with a
10 means to raise and lower the platform to the desired work levels.
- 11 **MULTISTORY UNIT.** A dwelling unit or sleeping unit with habitable space located on more than
12 one story.
- 13 **NAILING, BOUNDARY.** A special nailing pattern required by design at the boundaries of
14 diaphragms.
- 15 **NAILING, EDGE.** A special nailing pattern required by design at the edges of each panel within the
16 assembly of a diaphragm or shear wall.
- 17 **NAILING, FIELD.** Nailing required between the sheathing panels and framing members at locations
18 other than boundary nailing and edge nailing.
- 19 **NATIONAL GEODETIC VERTICAL DATUM (NGVD).** The national vertical datum standard
20 established in 1929; used as a reference for establishing elevations within a floodplain.
- 21 **NATURALLY DURABLE WOOD.** The heartwood of the following species except for the
22 occasional piece with corner sapwood, provided 90 percent or more of the width of each side on
23 which it occurs is heartwood:
- 24 **Decay resistant.** Redwood, cedar, black locust and black walnut.
- 25 **Termite resistant.** Redwood, Alaska yellow cedar, Eastern red cedar and Western red cedar.
- 26 **NEW CONSTRUCTION.** See Section G201.1.2.
- 27 **NOMINAL LOADS.** The magnitudes of the loads specified in Chapter 16 (dead, live, soil, wind,
28 snow, rain, flood and earthquake).
- 29 **NOMINAL SIZE (LUMBER).** The commercial size designation of width and depth, in standard
30 sawn lumber and glued-laminated lumber grades; somewhat larger than the standard net size of
31 dressed lumber, in accordance with DOC PS 20 for sawn lumber and with the ANSI/AWC NDS for
32 glued-laminated lumber.
- 33 **NONCOMBUSTIBLE MEMBRANE STRUCTURE.** A membrane structure in which the
34 membrane and all component parts of the structure are noncombustible.

- 1 **NONRESIDENTIAL (FOR FLOOD ZONE PURPOSES).** A building or structure that either:
- 2 1. Contains no space classified in Group I-1, R-1, R-2 or R-3, and contains no space that is
3 accessory, as such term is defined in the New York City Zoning Resolution, to any Group I-
4 1, R-1, R-2 or R-3 occupancy; or
- 5 2. Contains such space(s), but also contains space at or below the DFE that is not accessory, as
6 such term is defined in the New York City Zoning Resolution, to a Group I-1, R-1, R-2 or R-
7 3 occupancy.
- 8 **NORMAL TEMPERATURE AND PRESSURE (NTP).** A temperature of 70°F (21°C) and a
9 pressure of 1 atmosphere (14.7 psia (101 kPa)).
- 10 **NORTH AMERICAN VERTICAL DATUM (NAVD).** The national vertical datum standard
11 established in 1988, used as a reference for establishing elevations within a floodplain.
- 12 **NOSING.** The leading edge of treads of stairs and of landings at the top of stairway flights.
- 13 **NOTATIONS.** For Chapter 16, see Section 1602.1.
- 14 **NOTATIONS.** For Chapter 21, see Section 2102.1.
- 15 **NOTIFICATION ZONE.** See "Zone, notification."
- 16 **NURSING HOMES.** See Section 308.2.2.
- 17 **OCCUPANT LOAD.** The number of persons for which the means of egress of a building or portion
18 thereof is designed.
- 19 **OCCUPANT SENSOR.** A device that detects the presence or absence of people
20 within an area and causes lighting, equipment, or appliances to be regulated
21 accordingly.
- 22 **OCCUPIABLE SPACE.** A room or enclosed space, other than a habitable space, designed for
23 human occupancy or use in which individuals may remain for a period of time for rest, amusement,
24 treatment, education, dining, shopping, employment, labor or other similar purposes.
- 25 **OPEN-ENDED CORRIDOR.** An interior corridor that is open on each end and connects to an
26 exterior stairway or ramp at each end with no intervening doors or separation from the corridor.
- 27 **OPEN EXTERIOR SPACE.** See Section 1002.1.2.
- 28 **OPEN PARKING GARAGE.** A structure or portion of a structure with the openings as described
29 in Section 406.5.2 that is used for the parking or storage of private motor vehicles as described in
30 Section 406.5.3.
- 31 **OPEN PARKING LOT.** An exterior space with surfacing at grade used for the storage or sale of
32 more than four motor vehicles, including but not limited to parking lots, motor vehicles sales lots,
33 and accessory open parking spaces.

1 **OPEN SYSTEM.** The use of a solid or liquid hazardous material in equipment or a vessel or system
2 that remains open during normal operation such that vapors are emitted during the operation of such
3 equipment, vessel or system and the material is exposed to the atmosphere during such operation.
4 Examples of open systems for solids and liquids include dispensing from or into open beakers or
5 containers, dip tank and plating tank operations.

6 **ORDINARY REPAIRS.** See Section 105.4.2 of the *Administrative Code*.

7 **ORGANIC PEROXIDE.** An organic compound having a double oxygen or peroxy (-O-O-) in its
8 chemical structure. Organic peroxides can present an explosion hazard (detonation or deflagration),
9 can be shock sensitive, or can be susceptible to decomposition into various unstable compounds over
10 an extended period of time and are classified as follows based upon their hazardous properties:

11 **Class I.** Organic peroxides that are capable of deflagration but not detonation.

12 **Class II.** Organic peroxides that burn very rapidly and that pose a moderate reactivity hazard.

13 **Class III.** Organic peroxides that burn rapidly and that pose a moderate reactivity hazard.

14 **Class IV.** Organic peroxides that burn in the same manner as ordinary combustibles and that pose
15 a minimal reactivity hazard.

16 **Class V.** Organic peroxides that burn with less intensity than ordinary combustibles or do not
17 sustain combustion and that pose no reactivity hazard.

18 **Unclassified detonable.** Organic peroxides that are capable of detonation and pose an extremely
19 high explosion hazard through rapid explosive decomposition.

20 **ORTHOGONAL.** To be in two horizontal directions, at 90 degrees (1.57 rad) to each other.

21 **OSHA.** The United States Department of Labor Occupational Safety and Health Administration.

22 **OSHA 10-HOUR CLASS.** A class that includes 10 or more hours in construction industry safety
23 and health that is intended for workers and satisfies the following conditions:

24 1. Such class is (i) approved by OSHA and conducted in accordance with the OSHA outreach
25 training program or (ii) an equivalent 10 or more hour class approved by the department.

26 2. Such class consists of in-person training, actively proctored online training or, if such training
27 is conducted before the effective date of the local law that added this definition, online
28 training.

29 **OSHA 30-HOUR CLASS.** A class that includes 30 or more hours in construction industry safety
30 and health that is intended for supervisors and satisfies the following conditions:

31 1. Such class is (i) approved by OSHA and conducted in accordance with the OSHA outreach
32 training program or (ii) an equivalent 30 or more hour class approved by the department.

1 2. Such class consists of in-person training, actively proctored online training or, if such training
2 is conducted before the effective date of the local law that added this definition, online
3 training.

4 **OTHER STRUCTURES.** Structures, other than buildings, for which loads are specified in Chapter
5 16.

6 **OUTRIGGER (CRANE).** Extendable or fixed members attached to the mounting base that rest on
7 supports at the outer ends used to support the crane.

8 **OUTRIGGER (SCAFFOLD).** The structural member of a supported scaffold used to increase the
9 base width of a scaffold in order to provide support for and increased stability of the scaffold.

10 **OUTRIGGER BEAM (THRUSTOUT).** The structural member of a suspended scaffold or
11 outrigger scaffold that provides support for the scaffold by extending the scaffold point of attachment
12 to a point out and away from the structure or building.

13 **OUTRIGGER SCAFFOLD.** A supported scaffold consisting of a platform resting on outrigger
14 beams (thrustouts) projecting beyond the wall or face of the building or structure, the inboard ends of
15 which are secured inside the building or structure.

16 **OXIDIZER.** A material that readily yields oxygen or other oxidizing gas or that readily reacts to
17 promote or initiate combustion of combustible materials, and if heated or contaminated can result in
18 vigorous self-sustained decomposition, classified as follows:

19 **Class 4.** An oxidizer that can undergo an explosive reaction due to contamination or exposure to
20 thermal or physical shock and causes a severe increase in the burning rate of combustible materials
21 with which it comes into contact.

22 **Class 3.** An oxidizer that causes a severe increase in the burning rate of combustible materials
23 with which it comes in contact.

24 **Class 2.** An oxidizer that causes a moderate increase in the burning rate of combustible materials
25 with which it comes in contact.

26 **Class 1.** An oxidizer that causes a readily measurable increase in the burning rate of combustible
27 materials with which it comes in contact, but less than a moderate increase.

28 **OXIDIZING GAS.** A gas that can support and accelerate combustion of other materials more than
29 air does.

30 **PANEL (PART OF A STRUCTURE).** The selection of a floor, wall or roof comprised between the
31 supporting frame of two adjacent rows of columns and girders or column bands of floor or roof
32 construction.

33 **PANIC HARDWARE.** A door-latching assembly incorporating a device that releases the latch upon
34 the application of a force in the direction of egress travel.

35 **PARKING GARAGE.** A structure or portion of a structure, other than a private garage or carport,

1 used for the parking or storage of motor vehicles.

2 **PARTICLEBOARD.** A generic term for a panel primarily composed of cellulosic materials (usually
3 wood), generally in the form of discrete pieces or particles, as distinguished from fibers. The
4 cellulosic material is combined with synthetic resin or other suitable bonding system by a process in
5 which the interparticle bond is created by the bonding system under heat and pressure.

6 **PATIENT CARE AREA (FOR FLOOD ZONE PURPOSES).** Any space meeting the following
7 conditions:

- 8 1. The space is located within a building or structure, or portion thereof, that is classified in
9 Group I-2; and
- 10 2. The space is primarily used for the provision of medical services to persons, including, but
11 not limited to, consultation, evaluation, monitoring and treatment services.

12 **Exceptions:** The following spaces shall not be considered patient care areas (for flood zone
13 purposes):

- 14 1. “Emergency rooms or departments” as defined in 10 NYCRR 700.2(a)(2) and
- 15 2. Spaces primarily used for the provision of medical services identified in 10 NYCRR
16 703.6(c)(2)(i).

17 **PENETRATION FIRESTOP.** A through-penetration firestop or a membrane-penetration firestop.

18 **PENTHOUSE.** An enclosed rooftop structure that is designed or used for human occupancy.

19 **PERFORMANCE CATEGORY.** A designation of wood structural panels as related to the panel
20 performance used in Chapter 23.

21 **PERMANENT PRESTRESSED ROCK AND SOIL ANCHORS.** Corrosion-protected tendons
22 consisting of bars or strands installed in drilled and grouted holes in soil or rock that are stressed.

23 **PERSONAL CARE SERVICE.** The care of residents who do not require chronic or convalescent
24 medical or nursing care. Personal care involves responsibility for the safety of the resident while
25 inside the building.

26 **PERSONNEL HOIST.** A mechanism and its hoistway that is (i) temporarily installed at a
27 construction or demolition site, and (ii) is equipped with a car that moves vertically on guide members
28 to raise or lower workers or workers and materials.

29 **PHOTOSENSOR.** A device that detects the presence of visible light.

30 **PHOTOLUMINESCENT.** Having the property of emitting light that continues for a length of time
31 after excitation by visible or invisible light has been removed.

32 **PHOTOVOLTAIC MODULE.** A complete, environmentally protected unit consisting of solar
33 cells, optics and other components, exclusive of tracker, designed to generate DC power when
34 exposed to sunlight.

- 1 **PHOTOVOLTAIC PANEL.** A collection of modules mechanically fastened together, wired and
2 designed to provide a field-installable unit.
- 3 **PHOTOVOLTAIC PANEL SYSTEM.** A system that incorporates discrete photovoltaic panels that
4 converts solar radiation into electricity, including rack support systems.
- 5 **PHOTOVOLTAIC SHINGLES.** A roof covering resembling shingles that incorporates
6 photovoltaic modules.
- 7 **PHYSICAL HAZARD.** A chemical for which there is evidence that it is a combustible liquid,
8 compressed gas, cryogenic explosive, flammable gas, flammable liquid, flammable solid, organic
9 peroxide, oxidizer, pyrophoric or unstable (reactive) or water-reactive material.
- 10 **PHYSIOLOGICAL WARNING THRESHOLD LEVEL.** A concentration of air-borne
11 contaminants, normally expressed in parts per million (ppm) or milligrams per cubic meter (mg/m³),
12 that represents the concentration at which persons can sense the presence of the contaminant due to
13 odor, irritation or other quick-acting physiological response. When used in conjunction with the
14 permissible exposure limit (PEL), the physiological warning threshold levels are those consistent with
15 the classification system used to establish the PEL. See the definition of "Permissible exposure limit
16 (PEL)" in the *New York City Fire Code*.
- 17 **PIER FOUNDATION.** A pier foundation is a shallow foundation element of masonry or cast-in-
18 place concrete construction. Piers are relatively short in comparison to their width, with lengths less
19 than or equal to 12 times the least horizontal dimension of the pier. Piers derive their load-carrying
20 capacity from end bearing on soil or rock.
- 21 **PILE DRIVER.** Equipment that is configured to drive, hammer, press, or vibrate piles into the earth
22 ("pile drive").
- 23 **PINRAIL.** A rail on or above a stage through which belaying pins are inserted and to which lines are
24 fastened.
- 25 **PLACE OF ASSEMBLY.** A building, structure, or portion thereof, excluding a dwelling unit, but
26 including outdoor spaces, used or intended to be used for the gathering of a group of persons for
27 purposes such as civic, social, or religious functions, recreation, food or drink consumption,
28 educational or instructional purposes, awaiting transportation, or similar group activities when such
29 use requires a place of assembly Certificate of Operation pursuant to Section 303.7.
- 30 **PLASTIC, APPROVED.** Any thermoplastic, thermosetting or reinforced thermosetting plastic
31 material that conforms to combustibility classifications specified in the section applicable to the
32 application and plastic type.
- 33 **PLASTIC, COMPOSITE.** A generic designation that refers to wood/plastic composites and plastic
34 lumber.
- 35 **PLASTIC GLAZING.** Plastic materials that are glazed or set in frame or sash and not held by
36 mechanical fasteners that pass through the glazing material.

- 1 **PLASTIC LUMBER.** A manufactured product made primarily of plastic materials (filled or
2 unfilled) that is generally rectangular in cross section.
- 3 **PLASTIC (SOIL).** A property of a soil that allows the soil to be deformed or molded without
4 cracking, or appreciable volume change.
- 5 **PLATFORM (SPECIAL USE).** See Section 410.2.2.
- 6 **PLATFORM.** A work surface elevated above lower levels. Platforms can be constructed using
7 individual wood planks, fabricated planks or fabricated decks.
- 8 **POLE SIGN.** A sign wholly supported by a sign structure in the ground.
- 9 **POLYPROPYLENE SIDING.** A shaped material, made principally from polypropylene
10 homopolymer or copolymer, which in some cases contains fillers or reinforcements, that is used to
11 clad exterior walls of buildings.
- 12 **PORCELAIN TILE.** Tile that conforms to the requirements of ANSI 137.1.3 for ceramic tile having
13 an absorption of 0.5 percent or less in accordance with ANSI 137.4.1-Class Table and ANSI 137.1.6.1
14 Allowable Properties by Tile Type-Table 10.
- 15 **POSITIVE ROOF DRAINAGE.** The drainage condition in which consideration has been made for
16 all loading deflections of the roof deck, including ponding instability, and additional slope has been
17 provided to ensure drainage of the roof within 48 hours of precipitation.
- 18 **POST-CONSTRUCTION STORMWATER MANAGEMENT FACILITY.** See Section 28-
19 104.11.1 of the *Administrative Code*.
- 20 **POST-FIRE SMOKE PURGE SYSTEM.** A mechanical or natural ventilation system intended to
21 move smoke from the smoke zone to the exterior of the building. Such systems are intended for the
22 timely restoration of operations and overhaul activities once a fire is extinguished. Post-fire smoke
23 purge systems are not intended or designed to be life safety systems.
- 24 **POST-FIRM DEVELOPMENT.** See Section G201.1.2.
- 25 **POST-FIRM STRUCTURE.** See Section G201.1.2.
- 26 **POWER BUGGIES.** An automotive vehicle designed or used for the transportation of materials on
27 or about construction or demolition sites. It shall not include automobiles, motor trucks, general
28 purpose tractors, or excavating or similar material handling machinery.
- 29 **POWER-ASSISTED DOOR.** Swinging door that opens by reduced pushing or pulling force on the
30 door-operating hardware. The door closes automatically after the pushing or pulling force is released
31 and functions with decreased forces. See “Low-energy power-operated door” and “Power-operated
32 door”.
- 33 **POWER-OPERATED DOOR.** Swinging, sliding, or folding door that opens automatically when
34 approached by a pedestrian or opens automatically upon an action by a pedestrian. The door closes

1 automatically and includes provisions such as presence sensors to prevent entrapment. See “Low-
2 energy power-operated door” and “Power-assisted door”.

3 **PRE-FIRM DEVELOPMENT.** See Section G201.1.2.

4 **PRE-FIRM STRUCTURE.** See Section G201.1.2.

5 **PREFABRICATED WOOD I-JOIST.** Structural member manufactured using sawn or structural
6 composite lumber flanges and wood structural panel webs bonded together with exterior exposure
7 adhesives, which forms an "I" cross-sectional shape.

8 **PRESIGNAL SYSTEM.** A fire alarm system having a feature that allows initial fire alarm signals
9 to sound in a constantly attended central location and for which a human action is subsequently
10 required to achieve a general alarm, or a feature that allows the control equipment to delay the general
11 alarm by more than 1 minute after the start of the alarm processing.

12 **PRESSURIZATION.** Creation and maintenance of pressure levels in zones of a building, including
13 elevator shafts and stairwells, that are higher than the pressure level at the smoke source, such pressure
14 levels being produced by positive pressures of a supply of uncontaminated air; by exhausting air and
15 smoke at the smoke source; or by a combination of these methods.

16 **PRESTRESSED MASONRY.** Masonry in which internal stresses have been introduced to
17 counteract potential tensile stresses in masonry resulting from applied loads.

18 **PRIMARY FUNCTION AREAS.** An area of a building or facility containing a major activity for
19 which the building or facility is intended is a primary function area.

20 **PRIMARY STRUCTURAL FRAME.** The primary structural frame shall include all of
21 the following structural members:

- 22 1. The columns;
- 23 2. Structural members having direct connections to the columns, including girders,
24 beams, trusses and spandrels;
- 25 3. Members of the floor construction and roof construction having direct connections
26 to the columns; and
- 27 4. Bracing members that are essential to the vertical stability of the primary structural
28 frame under gravity loading, shall be considered part of the primary structural
29 frame whether or not the bracing member carries gravity loads.

30 **PRIVATE GARAGE.** An enclosed structure or portion of a structure, accessory to a Group R-2 or
31 R-3 occupancy, used for the parking or storage of passenger motor vehicles. Such facility shall not
32 exceed 650 square feet (60 m²) in area and one story in height.

33 **PROJECTING SIGN.** A sign other than a wall sign that projects from and is supported by a wall of
34 a building or structure.

35 **PROSCENIUM WALL.** The wall that separates the stage from the auditorium or assembly seating
36 area.

- 1 **PUBLIC ENTRANCE.** An entrance that is not a service entrance.
- 2 **PUBLIC WAY.** A street, alley or other parcel of land open to the outside air leading to a street that
3 has been deeded, dedicated or otherwise permanently appropriated to the public for public use and
4 which has a clear width and height of not less than 10 feet (3048 mm).
- 5 **PUBLIC-USE AREAS.** Interior or exterior rooms or spaces that are made available to the general
6 public.
- 7 **PYROPHORIC MATERIAL.** A material with an auto-ignition temperature in air, at or below a
8 temperature of 130°F (54°C).
- 9 **PYROTECHNIC MATERIAL.** A chemical mixture consisting predominantly of solids that, upon
10 ignition, are capable of producing a controlled, self-sustaining, and self-contained exothermic
11 reaction, that functions without external oxygen, resulting in a visible or audible effect by combustion,
12 deflagration, or detonation.
- 13 **QUALIFIED PERSON.** A person who, by possession of a recognized degree, certificate, or
14 professional standing, or who by extensive knowledge, training, and experience, has successfully
15 demonstrated his or her ability to solve or resolve problems related to the subject matter, the work, or
16 the project.
- 17 **RADIANT BARRIER.** A material having a low-emittance surface of 0.1 or less installed in building
18 assemblies.
- 19 **RAMP.** A walking surface that has a running slope steeper than one unit vertical in 20 units horizontal
20 (5-percent slope).
- 21 **RAMP-ACCESS OPEN PARKING GARAGE.** Open parking garages employing a series of
22 continuously rising floors or a series of interconnecting ramps between floors permitting the
23 movement of vehicles under their own power from and to the street level.
- 24 **RECLAIMED ASPHALT PAVEMENT.** Asphalt pavement that has been processed for reuse in
25 asphaltic concrete.
- 26 **RECORD DRAWINGS.** Drawings ("as built") that document the location of all devices,
27 appliances, wiring sequences, wiring methods and connections of the components of a fire alarm
28 system as installed.
- 29 **RECREATIONAL VEHICLE.** See Section G201.1.2.
- 30 **REFLECTIVE PLASTIC CORE FOIL INSULATION.** An insulation material packaged in rolls,
31 that is less than ½ inch (12.7 mm) thick, with at least one exterior low emittance surface (0.1 or less)
32 and a core material containing voids or cells.
- 33 **REFUGE AREA.** A floor area to which egress is made through a horizontal exit.
- 34 **RELIGIOUS WORSHIP, PLACE OF.** A building or portion thereof intended for the performance
35 of religious services.

1 **REMOVING/REMOVAL/REMOVE (SCAFFOLD).** The final process of taking apart a scaffold
2 in a specific sequence and removing it from the site.

3 **REPAIR (SCAFFOLD).** Work performed to restore a scaffold, or any part or component, to like
4 new condition and safe working order following decay, wear, or damage. The definition of repair
5 shall also include the replacement of a part or component.

6 **REPLACEMENT (SCAFFOLD).** A repair involving the exchange or substitution of one part or
7 component with another identical or similar part or component in order to restore a scaffold, or any
8 part or component, to like new condition and safe working order following decay, wear, or damage.

9 **REROOFING.** The process of recovering or replacing an existing roof covering. See "Roof recover"
10 and "Roof replacement."

11 **RESIDENTIAL AIRCRAFT HANGAR.** An accessory building less than 2,000 square feet (186
12 m²) and 20 feet (6096 mm) in building height constructed on a one- or two-family property where
13 aircraft are stored. Such use will be considered as a residential accessory use incidental to the
14 dwelling.

15 **RESIDENTIAL CARE/ASSISTED LIVING FACILITIES.** A building or part thereof housing
16 persons, on a 24-hour basis, who because of age, mental disability or other reasons, live in a
17 supervised residential environment that provides personal care services. The occupants are capable
18 of self-preservation and are capable of responding to an emergency situation without physical
19 assistance from staff. This classification shall include, but not limited to, the following: residential
20 board and care facilities, assisted living facilities, halfway houses, congregate care facilities, social
21 rehabilitation facilities, alcohol and drug abuse rehabilitation centers and convalescent facilities.

22 **RESIDENTIAL (FOR FLOOD ZONE PURPOSES).** A building or structure containing any space
23 that is either:

- 24 1. Classified in Group I-1, R-1, R-2, or R-3; or
25 2. Accessory, as such term is defined in the New York City Zoning Resolution, to any Group I-
26 1, R-1, R-2, or R-3 occupancy.

27 **Exception:** Such a building or structure shall be considered nonresidential (for flood zone
28 purposes) when also containing space at or below the DFE that is not accessory, as such term is
29 defined in the New York City Zoning Resolution, to a Group I-1, R-1, R-2, or R-3 occupancy.

30 **RESISTANCE FACTOR.** A factor that accounts for deviations of the actual strength from the
31 nominal strength and the manner of consequences of failure (also called "strength reduction factor").

32 **RESPONSE RATIO.** The ratio of an ultimate response quantity (e.g., deflection) to its value at yield.

33 **RESTRICTED ENTRANCE.** An entrance that is made available for public use but on a controlled
34 basis, and that is not a service entrance.

35 **RETAINING WALL.** A wall that resists lateral or other forces caused by soil, rock, water or other
36 materials, thereby limiting lateral displacement and the movement of the supported materials.
37 Basement walls and vault walls that are parts of buildings and underground structures, including but

1 not limited to utility vault structures, tunnels, transit stations, and swimming pools, are not considered
2 retaining walls.

3 **RETRACTABLE AWNING.** A retractable awning is a cover with a frame that retracts against a
4 building or other structure to which it is entirely supported.

5 **RIM BOARD.** In light-frame construction, a full depth structural member designed to transfer
6 horizontal (shear) and vertical (compression) loads, provide attachment for diaphragm sheathing,
7 siding and exterior deck ledgers, and provide lateral support at the ends of floor or roof joists or
8 rafters.

9 **RISK CATEGORY.** A categorization of buildings and other structures for determination of flood,
10 wind, snow, ice and earthquake loads based on the risk associated with unacceptable performance.

11 **RISK-TARGETED MAXIMUM CONSIDERED EARTHQUAKE (MCE_R) GROUND**
12 **MOTION RESPONSE ACCELERATIONS.** The most severe earthquake effects considered by
13 this standard determined for the orientation that results in the largest maximum response for
14 horizontal ground motions and with adjustment for targeted risk. The MCE_R Ground Motion values
15 can be determined from general procedure in Section 1613.3.3 of this code or can be derived from
16 the site specific procedures provided in Sections 21.1 and 21.2 of ASCE 7.

17 **ROPE.** A continuous line of material comprised of a number of twisted or braided strands of fiber
18 (natural or synthetic) or metal wire.

19 **ROOF ASSEMBLY.** A system designed to provide weather protection and resistance to design
20 loads. The system consists of a roof covering and roof deck or a single component serving as both the
21 roof covering and the roof deck. A roof assembly includes the roof deck, vapor retarder, substrate or
22 thermal barrier, insulation and roof covering.

23 **ROOF COVERING.** The covering applied to the roof deck for weather resistance, fire classification
24 or appearance.

25 **ROOF COVERING SYSTEM.** See "Roof assembly."

26 **ROOF DECK.** The flat or sloped surface constructed on top of the exterior walls of a building or
27 other supports for the purpose of enclosing the story below, or sheltering an area, to protect it from
28 the elements, not including its supporting members or vertical supports.

29 **ROOF RECOVER.** The process of installing an additional roof covering over a prepared existing
30 roof covering without removing the existing roof covering.

31 **ROOF REPAIR.** Reconstruction or renewal of any part of an existing roof for the purposes of its
32 maintenance.

33 **ROOF REPLACEMENT.** The process of removing the existing roof covering, repairing any
34 damaged substrate and installing a new roof covering.

35 **ROOF SIGN.** A sign erected on or above a roof or parapet of a building or structure.

1 **ROOF VENTILATION.** The natural or mechanical process of supplying conditioned or
2 unconditioned air to, or removing such air from, attics, cathedral ceilings or other enclosed spaces
3 over which a roof assembly is installed.

4 **ROOFTOP STRUCTURE.** An enclosed or unenclosed structure on or above the roof of any part of
5 a building.

6 **ROOMING HOUSE.** A dwelling (i) which was originally erected as single- or two-family private
7 dwelling pursuant to the *New York City Building Code* in effect prior to December 6, 1968, (ii) which
8 is a "Class B converted dwelling" as such term is defined in the *New York City Housing Maintenance*
9 *Code*, and (iii) which has more than half of its habitable rooms as sleeping units. The creation of or
10 conversion to a rooming house shall be limited by Section 27-2077 of the *New York City Housing*
11 *Maintenance Code*.

12 **ROTATING TELEHANDLER.** A telehandler whose boom is mounted on a rotating or slewing
13 superstructure.

14 **ROTATION.** The angle, measured at the ends of a member, whose tangent is equal to the deflection
15 of the member at midspan divided by half the length of the member.

16 **RUNBACK STRUCTURE.** A temporary system of hoistway landing runways, vertical supports and
17 horizontal diaphragms designed to bridge between the hoistway and the parent structure and to
18 transmit both vertical and horizontal loads to the supporting structure and/or foundation.

19 **RUNNING BOND.** The placement of masonry units such that head joints in successive courses are
20 horizontally offset at least one-quarter the unit length.

21 **SAFE AREA.** See Section 1002.1.2.

22 **SAFETY NETTING SYSTEM (SAFETY NETTING).** Debris or structural nets, installed
23 vertically or horizontally, along with all supports, components, and connections.

24 **Horizontal safety netting.** A safety netting system, installed horizontally, consisting of structural
25 netting lined with debris netting.

26 **Vertical safety netting.** A safety netting system, installed vertically, consisting of debris netting.

27 **SALLYPORT.** See Section 408.1.1.

28 **SAND DUNES.** Naturally occurring accumulations of sand in ridges or mounds landward of a beach.

29 **SCAFFOLD.** Any temporary elevated platform and its supporting structure (including points of
30 anchorage) used for supporting workers or workers and material, including but not limited to
31 supported scaffolds, suspended scaffolds, and mobile scaffolds.

32 **SCAFFOLD CONTROLLING ENTITY.** The contractor or other entity that exercises
33 responsibility for the site where the scaffold is located.

1 **SCISSOR STAIRWAY.** Two interlocking stairways providing two separate paths of egress located
2 within one stairwell enclosure.

3 **SCUPPER.** An opening in a wall or parapet that allows water to drain from a roof.

4 **SEATING SECTION.** See Section 1002.1.2.

5 **SECONDARY MEMBERS.** The following structural members shall be considered
6 secondary members and not part of the primary structural frame:

7 1. Structural members not having direct connections to the columns;
8 2. Members of the floor construction not having direct connections to the
9 columns; and

10 3. Bracing members other than those that are part of the primary structural frame.

11 **SEISMIC DESIGN CATEGORY.** A classification assigned to a structure based on its risk category
12 and the severity of the design earthquake ground motion at the site.

13 **SEISMIC FORCE-RESISTING SYSTEM.** The part of the structural system that has been
14 considered in the design to provide the required resistance to the prescribed seismic forces.

15 **SELF-CLOSING.** As applied to a fire door or other opening, means equipped with a listed and
16 approved device that will ensure closing after having been opened.

17 **SELF-ERECTING TOWER CRANE.** A tower crane that adjusts its operating radius by means of
18 a trolley traversing a jib and that; (i) possesses a vertical or nearly vertical tower or mast that is bottom
19 slewing and mounted on fixed, traveling, or mobile bases; and (ii) is capable of folding and unfolding
20 to facilitate transit from site to site with minimal assembly.

21 **SELF-LUMINOUS.** Illuminated by a self-contained power source, other than batteries, and operated
22 independently of external power sources.

23 **SELF-SERVICE STORAGE FACILITY.** Real property designed and used for the purpose of
24 renting or leasing individual storage spaces to customers for the purpose of storing and removing
25 personal property on a self-service basis.

26 **SERVICE CORRIDOR.** A fully enclosed passage other than one designated as a required means of
27 egress, through which HPM can be moved during handling.

28 **SERVICE ENTRANCE.** An entrance solely for delivery of goods or services.

29 **SERVICES.** Includes, but is not limited to, toilet rooms, drinking fountains, public telephones and
30 food.

31 **SHADED X-ZONE.** The land in the floodplain delineated as subject to a 0.2-percent or greater
32 chance of flooding, but less than one percent chance of flooding, in any given year. Such areas are
33 designated on the Flood Insurance Rate Map (FIRM) as shaded X-Zones.

- 1 **SHAFT.** An enclosed space extending through one or more stories of a building, connecting vertical
2 openings in successive floors, or floors and roof.
- 3 **SHAFT ENCLOSURE.** The walls or construction forming the boundaries of a shaft.
- 4 **SHALLOW FOUNDATION.** A shallow foundation is an individual or strip footing, a mat
5 foundation, a slab-on-grade foundation or a similar foundation element.
- 6 **SHEAR WALL.** A wall designed to resist lateral forces parallel to the plane of a wall.
- 7 **Shear wall, perforated.** A wood structural panel sheathed wall with openings, that has not been
8 specifically designed and detailed for force transfer around openings.
- 9 **Shear wall segment, perforated.** A section of shear wall with full-height sheathing that meets
10 the height-to-width ratio limits of Section 4.3.4 of AWC SDPWS.
- 11 **SHORE, MULTI-STAGE.** Formwork assemblies on a single level comprised of discontinuous
12 vertical post elements stacked on top of each other.
- 13 **SIDELITES.** Fixed transparent panels that form part of or are immediately adjacent to and within 6
14 feet (1829 mm) horizontally of the vertical edge of an opening in which transparent doors are located.
15 A sidelite shall consist of transparent material in which the transparent area above a reference line 18
16 inches (457 mm) above the adjacent ground, floor or equivalent surface is 80 percent or more of the
17 remaining area of the panel above such reference line.
- 18 **SIGN.** Any letter, figure, character, mark, plane, point, marquee sign, design, poster, pictorial,
19 picture, stroke, stripe, line, trademark, reading matter or illuminated service, which shall be
20 constructed, placed, attached, painted, erected, fastened or manufactured in any manner whatsoever,
21 so that the same shall be used for the attraction of the public to anyplace, subject, person, firm,
22 corporation, public performance, article, machine or merchandise, whatsoever, which is displayed in
23 any manner outdoors. Every sign shall be classified and conform to the requirements of that
24 classification as set forth in this code.
- 25 **SIGN STRUCTURE.** Any structure that supports or is capable of supporting a sign as defined in
26 this code.
- 27 **SINGLE-PLY MEMBRANE.** A roofing membrane that is field applied using one layer of
28 membrane material (either homogeneous or composite) rather than multiple layers.
- 29 **SINGLE-POINT ADJUSTABLE SUSPENDED SCAFFOLD.** A suspended scaffold consisting of
30 a platform suspended by one rope from an overhead support and equipped with means to permit the
31 movement of the platform to desired work levels.
- 32 **SINGLE-STATION SMOKE ALARM.** An assembly incorporating the detector, the control
33 equipment and the alarm-sounding device in one unit, operated from a power supply either in the unit
34 or obtained at the point of installation.
- 35 **SITE.** A parcel of land bounded by a lot line or a designated portion of a public right-of-way.

1 **SITE CLASS.** A classification assigned to a site based on the types of soils present and their
2 engineering properties as defined in Section 1613.3.2.

3 **SITE COEFFICIENTS.** The values of, F_a , and, F_v , indicated in Tables 1613.3.3(1) and 1613.3.3(2),
4 respectively.

5 **SITE-FABRICATED STRETCH SYSTEM.** A system, fabricated on site and intended for
6 acoustical, tackable or aesthetic purposes, that is comprised of three elements: (a) a frame (constructed
7 of plastic, wood, metal or other material) used to hold fabric in place, (b) a core material (infill, with
8 the correct properties for the application), and (c) an outside layer, comprised of a textile, fabric or
9 vinyl, that is stretched taut and held in place by tension or mechanical fasteners via the frame.

10 **SITE SAFETY TRAINING (SST) CARD.** A card that is issued in a form and manner established
11 by the department and that satisfies each of the following conditions:

12 1. Such card is issued by an SST provider to a person who submits an application to such
13 provider demonstrating, in a form and manner established by the department, that such
14 applicant satisfies the requirements of Item 1.1, 1.2 or 1.3:

15 1.1. Such applicant has successfully completed (i) an OSHA 10-hour class and (ii) 30-45
16 additional SST credits specified by the department, including eight SST credits relating
17 to safeguarding against the dangers posed by falling workers and objects.

18 1.2. Such applicant has successfully completed (i) an OSHA 30-hour class and (ii) 10-25
19 additional SST credits specified by the department, including eight SST credits relating
20 to safeguarding against the dangers posed by falling workers and objects.

21 1.3. Such applicant has successfully completed a 100-hour training program.

22 2. If such applicant completed the training to comply with Item 1.1, 1.2 or 1.3 but did not
23 complete such training within the five years preceding submission of such application, such
24 applicant has, in the one-year period preceding submission of such application, completed at
25 least eight SST credits specified by the department.

26 3. Such card is issued by an SST provider who does not require applicants to submit any
27 information except for (i) the information necessary to establish that the requirements in Item
28 1 have been satisfied, as specified by the department, (ii) a photograph of the applicant and
29 (iii) such additional information as the department may allow by rule.

30 4. Such card expires five years after issuance and is renewable upon a showing by the applicant
31 that such applicant has, in the one-year period preceding submission of such renewal
32 application, successfully completed eight SST credits specified by the department.

33 **SITE SAFETY TRAINING (SST) CREDIT.** One hour of training that satisfies each of the
34 requirements of Item 1, 2 and 3:

35 1. Such training relates to a topic identified by department rule.

1 2. If such training is conducted on or after the effective date of the local law that added this
2 definition, such training is in-person training or actively proctored online training.

3 3. If such training is conducted on or after March 1, 2018, such training is conducted by an SST
4 provider.

5 **SITE SAFETY TRAINING (SST) FULL COMPLIANCE DATE.** March 1, 2021.

6 **SITE SAFETY TRAINING (SST) PROVIDER.** An entity that satisfies the requirements of Items
7 1 and 2:

8 1. Such entity satisfies the conditions of Item 1.1, 1.2, 1.3 or 1.4:

9 1.1. Such entity is a not-for-profit organization with a history of at least three years of
10 experience in providing construction-related workforce development, construction-
11 related education or site safety training, which may be demonstrated by submitting
12 training logs to the department or in a form and manner otherwise determined by the
13 department, and training offered by such entity is offered by a person who has (i)
14 successfully completed all applicable OSHA or department requirements for
15 conducting OSHA 10-hour classes and OSHA 30-hour classes and is authorized to
16 conduct such classes and (ii) if such person is conducting training for SST credits other
17 than training that is part of an OSHA 10-hour class or OSHA 30-hour class, such
18 person demonstrates sufficient knowledge of this chapter in a form and manner
19 established by the department. Such entity shall not be required to demonstrate any
20 professional standing, approval, licensure, accreditation or certification, including
21 approval, licensure, accreditation or certification pursuant to paragraph (2) of
22 subdivision d of section 105-03 of subchapter E of chapter 100 of title 1 of the rules
23 of the city of New York, as in effect on January 1, 2018, beyond showing that such
24 entity and a person offering training on behalf of such entity satisfy the requirements
25 set forth in the preceding sentence. Where the department provides content, developed
26 in accordance with department-approved course requirements, for the delivery of SST
27 credits, such entity shall deliver SST credits in accordance with such content. Where
28 the department does not provide content for the delivery of SST credits, such entity
29 shall be responsible for the development of content in accordance with department-
30 approved course requirements. Such content and the delivery of such content may be
31 subject to approval or audit by the department.

32 1.2. Such entity is providing training through a 100-hour training program.

33 1.3. Such entity has been approved by the department to conduct a 40-hour course
34 approved by the department pursuant to Article 402 of Chapter 4 of Title 28 of the
35 Administrative Code.

36 1.4. The department may establish by rule additional ways for an entity to satisfy the
37 requirements of this Item 1. If the department elects to promulgate such rules, an entity
38 shall be deemed to satisfy this Item 1 if such entity satisfies the requirements set forth
39 in such rules or if such entity satisfies the requirements set forth in Item 1.1, 1.2 or 1.3.

1 2. On and after the SST full compliance date, such entity has certified to the department that
2 such entity satisfies at least one of the following conditions:

3 2.1. Such entity has a language access plan for training that relates to SST credits such
4 entity offers and such plan complies with requirements established by an agency or
5 office designated by the mayor.

6 2.2. Such entity satisfies each of the following conditions:

7 2.2.1. Such entity is able to provide instruction in a language that students
8 understand.

9 2.2.2. If a student's vocabulary is limited, such entity will accommodate that
10 limitation.

11 2.2.3. A person offering training on behalf of such entity is fluent in the training
12 language or will use translators or interpreters and any such translators or
13 interpreters will have a background in occupational safety and health.

14 **SITE SAFETY TRAINING (SST) SECOND COMPLIANCE DATE.** December 1, 2019, or, if
15 the department publishes a finding by September 1, 2019, that there is insufficient capacity to provide
16 the training required by Section 3321 this code code to the workers who would need such training, a
17 later date established by the department, provided that such date is not later than June 1, 2020.

18 **SITE SAFETY TRAINING (SST) SUPERVISOR CARD.** A card that satisfies each of the
19 following conditions:

20 1. Such card is issued in a form and manner established by the department to a person who
21 demonstrates that such person has an SST card and has successfully completed an OSHA 30-
22 hour class.

23 2. Such card expires five years after issuance and is renewable upon a showing by the applicant
24 that such applicant has, in the one-year period preceding such submission of such renewal
25 application, successfully completed 16 SST credits specified by the department.

26 **SITE SAFETY TRAINING (SST) TASK FORCE.** The task force established pursuant to Section
27 28-103.28 of the Administrative Code.

28 **SKYLIGHT, UNIT.** A factory-assembled, glazed fenestration unit, containing one panel of glazing
29 material that allows for natural lighting through an opening in the roof assembly while preserving
30 the weather-resistant barrier of the roof.

31 **SKYLIGHTS AND SLOPED GLAZING.** Glass or other transparent or translucent glazing
32 material installed at a slope of 15 degrees (0.26 rad) or more from vertical. Glazing material in
33 skylights, including unit skylights, solariums, sunrooms, roofs and sloped walls, are included in this
34 definition.

35 **SLEEPING UNIT.** A dwelling unit, which may contain either toilet or kitchen facilities but not both.
36 Any sleeping unit housing more than one family shall also be classified as a congregate living unit.

1 The creation of or conversion to sleeping units shall be limited by Section 27-2077 of the *New York*
2 *City Housing Maintenance Code.*

3 **SLEEPING UNIT (ACCESSIBILITY).** As used in Chapter 11 and Appendix E, a room or space
4 in which people sleep, which can also include permanent provisions for living, eating, and either
5 sanitation or kitchen facilities but not both. Such rooms and spaces that are also part of a dwelling
6 unit are not sleeping units.

7 **SMALL WIND TURBINE.** A turbine with a swept area smaller than 200 m² that generates a voltage
8 below 1000 V (AC) or 1500 V (DC).

9 **SMALL WIND TURBINE TOWER.** A structure that supports a small wind turbine.

10 **SMOKE.** Air-borne solid and liquid particulates and gases evolved when a material undergoes
11 pyrolysis or combustion, including the quality of air that is entrained or otherwise mixed into the
12 mass.

13 **SMOKE ALARM.** A single- or multiple-station alarm responsive to smoke and not connected to a
14 fire alarm system. See "Multiple-station smoke alarm" and "Single-station smoke alarm."

15 **SMOKE BARRIER.** A continuous membrane, either vertical or horizontal, such as a wall, floor, or
16 ceiling assembly, that is designed and constructed in accordance with Section 709 to restrict the
17 movement of smoke.

18 **SMOKE COMPARTMENT.** A space within a building enclosed by smoke barriers on all sides,
19 including the top and bottom.

20 **SMOKE CONTROL MODE.** A predefined operational configuration of a system or device for the
21 purpose of smoke control.

22 **SMOKE CONTROL SYSTEM, MECHANICAL.** An engineered system that includes all methods
23 that can be used singly or in combination to modify smoke movement.

24 **SMOKE CONTROL SYSTEM, PASSIVE.** A system of smoke barriers arranged to limit the
25 migration of smoke.

26 **SMOKE CONTROL ZONE.** A space within a building enclosed by smoke barriers that is part of a
27 smoke control system.

28 **SMOKE DAMPER.** See Dampers, Types of.

29 **SMOKE DETECTOR.** A listed device that senses visible or invisible particles of combustion or
30 smoke.

31 **SMOKE PARTITION.** A continuous vertical assembly that is designed and constructed to restrict
32 the movement of smoke and is not generally required to have a fire-resistance rating in accordance
33 with Section 710.

1 **SMOKE-DEVELOPED INDEX.** A comparative measure, expressed as a dimensionless number,
2 derived from measurements of smoke obscuration versus time for a material tested in accordance with
3 ASTM E 84.

4 **SMOKEPROOF ENCLOSURE.** An exit stairway, ramp or passageway designed and constructed
5 so that the movement of the products of combustion produced by a fire occurring in any part of the
6 building into the enclosure is limited.

7 **SMOKE-PROTECTED ASSEMBLY SEATING.** Seating served by means of egress that is not
8 subject to smoke accumulation within or under a structure.

9 **SOIL AND FOUNDATION WORK (SOIL OR FOUNDATION WORK).** Excavation, fill,
10 grading, augering, boring, or drilling, whether in soil or rock; or the installation or removal of
11 foundations, piles, underpinning, sheeting, shoring, or supports of excavation.

12 **SOLID.** A material that has a melting point, decomposes or sublimates at a temperature greater than
13 68°F (20°C).

14 **SPECIAL AMUSEMENT BUILDING.** A special amusement building is any temporary or
15 permanent building or portion thereof that is occupied for amusement, entertainment or educational
16 purposes and that contains a device or system that conveys passengers or provides a walkway along,
17 around or over a course in any direction so arranged that the means of egress path is not readily
18 apparent due to visual or audio distractions or is intentionally confounded or is not readily available
19 because of the nature of the attraction or more of conveyance through the building or structure.

20 **SPECIAL FLOOD HAZARD AREA.** Land in the floodplain subject to a 1% or greater chance of
21 flooding in any given year; area delineated on the Flood Insurance Rate Map as Zone A, AE, A1-30,
22 A99, AR, AO, AH, V, VO, VE, or V1-30. Such areas include A-Zones, Coastal A-Zones, and V-
23 Zones.

24 **SPECIAL INSPECTION, CONTINUOUS.** The observation of work requiring special inspection
25 by a special inspector who is continuously present in the area where the work is being performed
26 while the work is being performed.

27 **SPECIAL INSPECTION, PERIODIC.** The intermittent observation of work requiring special
28 inspection by a special inspector who is present in the area where the work has been or is being
29 performed and at the completion of the work. All work requiring special inspection shall remain
30 accessible and exposed until approved by the special inspector.

31 **SPECIFIC LOCAL LOAD.** A load applied to a structural element or structural system as specified
32 in Section 1617.6.

33 **SPECIFIC LOCAL RESISTANCE METHOD.** A design approach that accounts for extreme event
34 loads by providing sufficient strength for elements that may fail. In a specific local resistance design,
35 key elements are designed for specific local loads as required by Section 1617.

36 **SPECIFIED COMPRESSIVE STRENGTH OF MASONRY, f'_m .** Minimum compressive
37 strength, expressed as force per unit of net cross-sectional area, required of the masonry used in

- 1 construction by the approved construction documents, and upon which the project design is based.
2 Whenever the quantity f'_m is under the radical sign, the square root of numerical value only is intended
3 and the result has units of pounds per square inch (psi) (Mpa).
- 4 **SPLICE.** The result of a factory and/or field method of joining or connecting two or more lengths of
5 a fire-resistant joint system into a continuous entity.
- 6 **SPRAYED FIRE-RESISTANT MATERIALS.** Cementitious or fibrous materials that are sprayed
7 to provide fire-resistant protection of the substrates.
- 8 **STABLE (ROCK).** A condition in which natural solid mineral matter (rock) can be excavated with
9 vertical sides and remain intact while exposed.
- 10 **STACK EFFECT.** The vertical airflow within buildings caused by the temperature-created density
11 differences between the building interior and exterior or between two interior spaces.
- 12 **STAGE.** A space within a building utilized for entertainment or presentations, which includes
13 overhead hanging curtains, drops, scenery or stage effects other than lighting and sound.
- 14 **STAIR.** A change in elevation, consisting of two or more risers.
- 15 **STAIR TOWER (SCAFFOLD STAIRWAY/TOWER).** A tower comprised of scaffold
16 components and that contains internal stairway units and rest platforms. These towers are used to
17 provide access to scaffold platforms and other elevated points such as floors and roofs.
- 18 **STAIRWAY.** One or more flights of stairs, either exterior or interior, with the necessary landings
19 and platforms connecting them, to form a continuous and uninterrupted passage from one level to
20 another.
- 21 **STAIRWAY, SPIRAL.** A stairway having a closed circular form in its plan view with uniform
22 section-shaped treads attached to and radiating from a minimum-diameter-supporting column.
- 23 **STANDARD CUBIC FEET (SCF).** Cubic feet of gas at normal temperature and pressure (NTP).
- 24 **STANDARD GUARDRAIL SYSTEM (SCAFFOLD).** See “Guardrail system (scaffold).”
- 25 **STAND-OFF BRACKET (SUSPENDED SCAFFOLD).** A rigid member that attaches to a cornice
26 hook (c-hook) in order to provide additional outreach from the face of the parapet or wall.
- 27 **STANDPIPE SYSTEM.** Piping, installed in a building or structure, that serves to supply water to
28 hose connections at one or more locations in a building or structure, for firefighting purposes.
- 29 **STANDPIPE SYSTEM, CLASSES OF.** Standpipe classes are as follows:
- 30 **Class I system.** A system providing 2¹/₂-inch (64 mm) hose connections to supply water for use
31 by the Fire Department and those trained in handling heavy fire streams.
- 32 **Class II system.** A system providing 1¹/₂-inch (38 mm) hose stations to supply water for use
33 primarily by the building occupants or by the Fire Department during initial response.

1 **Class III system.** A system providing 1½-inch (38 mm) hose stations to supply water for use by
2 building occupants and 2½-inch (64 mm) hose connections to supply a larger volume of water
3 for use by the Fire Department and those trained in handling heavy fire streams.

4 **STANDPIPE SYSTEM, TYPES OF.** Standpipe system types are as follows:

5 **Automatic dry.** A dry standpipe system, normally filled with pressurized air, that is arranged
6 through the use of a device, such as dry pipe valve, to admit water into the system piping
7 automatically upon the opening of a hose valve. The water supply for an automatic dry standpipe
8 system shall be capable of supplying the system demand.

9 **Automatic wet.** A wet standpipe system that has a water supply that is capable of supplying the
10 system demand automatically.

11 **Manual dry.** A dry standpipe system that does not have a permanent water supply attached to the
12 system. Manual dry standpipe systems require water from a Fire Department pumper to be
13 pumped into the system through the Fire Department connection in order to meet the system
14 demand.

15 **Manual wet.** A wet standpipe system connected to a water supply for the purpose of maintaining
16 water within the system but that does not have a water supply capable of delivering the system
17 demand attached to the system. Manual-wet standpipe systems require water from a Fire
18 Department pumper to be pumped into the system in order to meet the system demand.

19 **Semiautomatic dry.** A dry standpipe system that is arranged through the use of a device, such as
20 a deluge valve, to admit water into the system piping upon activation of a remote control device
21 location at a hose connection. A remote control activation device shall be provided at each hose
22 connection. The water supply for a semiautomatic dry standpipe system shall be capable of
23 supplying the system demand.

24 **START OF CONSTRUCTION.** See Section G201.1.2.

25 **STEEL CONSTRUCTION, COLD-FORMED.** That type of construction made up entirely or in
26 part of steel structural members cold formed to shape from sheet or strip steel such as roof deck, floor
27 and wall panels, studs, floor joists, roof joists and other structural elements.

28 **STEEL ELEMENT, STRUCTURAL.** Any steel structural member of a building or structure
29 consisting of rolled shapes, pipe, hollow structural sections, plates, bars, sheets, rods or steel castings
30 other than cold-formed steel, or steel joist members.

31 **STEEL JOIST.** Any steel structural member of a building or structure made of hot-rolled or cold-
32 formed solid or open-web sections, or riveted or welded bars, strip or sheet steel members, or slotted
33 and expanded, or otherwise deformed rolled sections.

34 **STEEP SLOPE.** A roof slope greater than two units vertical in 12 units horizontal (17-percent
35 slope).

36 **STONE MASONRY.** Masonry composed of field, quarried or cast stone units bonded by mortar.

- 1 **STORAGE CABINET.** See Section 427.4.
- 2 **STORAGE, HAZARDOUS MATERIALS.** The keeping, retention or leaving of hazardous
3 materials in closed containers, tanks, cylinders, or similar vessels; or vessels supplying operations
4 through closed connections to the vessel.
- 5 **STORAGE ROOM.** See Section 427.4.
- 6 **STORM SHELTER.** See Section 423.2.
- 7 **Community storm shelter.** See Section 423.2.
- 8 **Residential storm shelter.** See Section 423.2.
- 9 **STORMWATER CONSTRUCTION PERMIT.** See Section 28-104.11.1 of the *Administrative*
10 *Code.*
- 11 **STORY.** That portion of a building included between the upper surface of a floor and the upper
12 surface of the floor or roof next above (also see "Basement" and "Mezzanine"). It is measured as the
13 vertical distance from top to top of two successive tiers of beams or finished floor surfaces and, for
14 the topmost story, from the top of the floor finish to the top of the ceiling joists or, where there is not
15 a ceiling, to the top of the roof rafters.
- 16 **STORY ABOVE GRADE PLANE.** Any story having its finished floor surface entirely above grade
17 plane, except that a basement shall also be considered a story above grade plane (see "Story" and
18 "Basement").
- 19 **STREET.** A thoroughfare, including sidewalks and roadways, dedicated or devoted to public use by
20 legal mapping or other lawful means, or a public way.
- 21 **STREET FLOOR.** A floor, usually the principal entrance floor, that is not more than one-half story
22 above or below grade at the location from which egress is provided to the street.
- 23 **STREET LINE.** A lot line separating a street from other land.
- 24 **STRENGTH DESIGN.** A method of proportioning structural members such that the computed
25 forces produced in the members by factored loads do not exceed the member design strength (also
26 called "load and resistance factor design" (LRFD)). The term "strength design" is used in the design
27 of concrete and masonry structural elements.
- 28 **STRENGTH.**
- 29 **Design strength.** Nominal strength multiplied by a strength reduction factor.
- 30 **Nominal strength.** Strength of a member or cross-section calculated in accordance with these
31 provisions before application of any strength-reduction factors.
- 32 **Required strength.** Strength of a member or cross-section required to resist factored loads.

1 **STRENGTH, NOMINAL.** The capacity of a structure or member to resist the effects of loads, as
2 determined by computations using specified material strengths and dimensions and equations derived
3 from accepted principles of structural mechanics or by field tests or laboratory tests of scaled models,
4 allowing for modelling effects and differences between laboratory and field conditions.

5 **STRENGTH, REQUIRED.** Strength of a member, cross section or connection required to resist
6 factored loads or related internal moments and forces in such combinations as stipulated by these
7 provisions.

8 **STRIPPING OPERATIONS.** Removal on the floor of any parts of the concrete formwork including
9 shoring, bracing and other supports.

10 **STRUCTURAL COMPOSITE LUMBER.** Structural member manufactured using wood elements
11 bonded together with exterior adhesives. Examples of structural composite lumber are:

12 **Laminated strand lumber (LSL).** A composite of wood strand elements with wood fibers
13 primarily oriented along the length of the member, where the least dimension of the wood strand
14 elements is 0.10 inch (2.54 mm) or less and their average lengths not less than 150 times the least
15 dimension of the wood strand elements.

16 **Laminated veneer lumber (LVL).** A composite of wood veneer sheet elements with wood fibers
17 primarily oriented along the length of the member, where the veneer element thicknesses are 0.25
18 inches (6.4 mm) or less.

19 **Oriented strand lumber (OSL).** A composite of wood strand elements with wood fibers
20 primarily oriented along the length of the member, where the least dimension of the wood strand
21 elements is 0.10 inch (2.54 mm) or less and their average lengths not less than 75 times and less
22 than 150 times the least dimension of the strand elements.

23 **Parallel strand lumber (PSL).** A composite of wood strand elements with wood fibers primarily
24 oriented along the length of the member where the least dimension of the wood strand elements
25 is 0.25 inches (6.4 mm) or less and their average lengths not less than 300 times the least
26 dimension of the wood strand elements.

27 **STRUCTURAL GLUED-LAMINATED TIMBER.** An engineered, stress-rated product of a
28 timber laminating plant, comprised of assemblies of specially selected and prepared wood laminations
29 in which the grain of all laminations is approximately parallel longitudinally and the laminations are
30 bonded with adhesives.

31 **STRUCTURAL NET (STRUCTURAL NETTING).** A system of nets capable of complying with
32 the prototype test described in ANSI A10.11.

33 **SUBMERGED SOIL.** Soil which is underwater or is free seeping.

34 **SUBSTANTIAL DAMAGE.** Damage of any origin sustained by a structure whereby the cost of
35 restoring the structure to its before-damaged condition would equal or exceed 50 percent of the market
36 value of the structure before the damage occurred.

1 **SUBSTANTIAL IMPROVEMENT.** Any repair, reconstruction, rehabilitation, addition or
2 improvement of a building or structure, the cost of which equals or exceeds 50 percent of the market
3 value of the structure before the improvement or repair is started. If the structure has sustained
4 substantial damage, any repairs are considered substantial improvement regardless of the actual repair
5 work performed. The term does not, however, include either:

6 1. Any project for improvement of a building required to correct pre-FIRM health, sanitary or
7 safety code violations identified by the commissioner, the Fire Commissioner, the Commissioner
8 of Housing Preservation and Development, or the Commissioner of Health and Mental Hygiene,
9 and that are the minimum necessary to assure safe living conditions; or

10 2. Any alteration of a historic structure provided that the alteration will not preclude the
11 structure's continued designation as a historic structure.

12 **SUN CONTROL DEVICE.** An architectural projection that provides protection against solar
13 radiation entering a building through glazed areas and is supported by the building to which it is
14 attached. Sun control device includes, but is not limited to, a fixed, retractable or rotating sun control
15 device. A fixed sun control device has no moving parts and is typically composed of horizontal
16 overhangs or vertical fins. A retractable sun control device extends or retracts, and in the extended
17 position casts a shadow on designated portions of the building. A rotating sun control device may be
18 of fixed or adjustable length and pivots at its base. Sun control device shall not include awnings and
19 scanopies.

20 **SUNROOM.** A one-story structure attached to a building with a glazing area in excess of 40 percent
21 of the gross area of the structure's exterior walls and roof.

22 **SUPERINTENDENT OF CONSTRUCTION.** See Chapter 1 of Title 28 of the *Administrative*
23 *Code.*

24 **SUPERSTRUCTURE.** The rotating upper frame structure of the machine and the operating
25 machinery mounted thereon.

26 **SUPERVISING STATION.** A facility that receives signals from protected premises' fire alarm
27 systems and at which personnel are in attendance at all times to respond to these signals.

28 **Supervising station, central.** A supervising station that is listed and approved by the Fire
29 Department for central station service.

30 **Supervising station, proprietary.** A supervising station under the same ownership as the
31 protected premises' fire alarm system(s) that it supervises (monitors) and to which alarm,
32 supervisory, or trouble signals are received and where personnel are in attendance at all times to
33 supervise operation and investigate signals.

34 **Supervising station, remote.** A supervising station to which alarm, supervisory, or trouble
35 signals or any combination of those signals emanating from protected premises' fire alarm
36 systems are received and where personnel are in attendance at all times to respond.

37 **SUPERVISORY SERVICE.** The service required to monitor performance of guard tours and the
38 operative condition of fixed suppression systems or other systems for the protection of life and
39 property.

1 **SUPERVISORY SIGNAL.** A signal indicating the need for action in connection with the
2 supervision of guard tours, fire suppression systems or equipment, fire alarm systems, or the
3 maintenance features of related systems.

4 **SUPERVISORY SIGNAL-INITIATING DEVICE.** An initiation device, such as a valve
5 supervisory switch, water-level indicator or low-air pressure switch on a dry-pipe sprinkler system,
6 whose change of state signals an off-normal condition and its restoration to normal of a fire protection
7 or life safety system, or a need for action in connection with the supervision of guard tours, fire
8 suppression systems or equipment, fire alarm systems, or the maintenance features of related systems.

9 **SUPPORTED SCAFFOLD.** One or more platforms supported by outrigger beams, brackets, poles,
10 legs, uprights, posts, frames, including prefabricated frames that are mechanized but not motorized,
11 or any similar rigid support, including back structures connecting hoistways to buildings, and includ-
12 ing structures where sidewalk protection is constructed as an integral part of the apparatus.

13 **SUSCEPTIBLE BAY.** A roof or portion thereof with:

- 14 1. A slope less than 1/4-inch per 1 foot (0.0208 rad); or
- 15 2. On which water is impounded, in whole or in part, and the secondary drainage system is
16 functional but the primary drainage system is blocked.

17 A roof surface with a slope of 1/4-inch per 1 foot (0.0208 rad) or greater towards points of free
18 drainage is not a susceptible bay.

19 **SUSPENDED SCAFFOLD.** One or more platforms suspended by ropes or other means from an
20 overhead structure.

21 **SUSPENDED SCAFFOLD FOREMAN.** An individual, male or female, designated by and working
22 under the direct and continuing supervision of a licensed master or special rigger, or a licensed master
23 or special sign hanger, in accordance with the rules of the department.

24 **SUSTAINABLE ROOFING ZONE.** Areas of a roof assembly where a solar photovoltaic electricity
25 generating system, a green roof system, or a combination thereof, is installed.

26 **SWIMMING POOL.** Any indoor or outdoor swimming, wading, spa, or special-purpose pool.

27

1 **Exceptions:**

- 2 1. Portable, freestanding wading pools containing water less than 24 inches (610 mm) in depth.
3 2. Float tanks or relaxation tanks sized for use by one person at a time.
4 3. Pools used for religious purposes.
5 4. Spa pools used for prescribed medical therapy or rehabilitation and under medical
6 supervision.

7 **SWIMMING POOL, PRIVATE.** A swimming pool that is accessory to a one- or two-family
8 dwelling, or to a single-dwelling unit of a multiple dwelling, and that is solely for the use of the
9 occupants for noncommercial purposes.

10 **SWIMMING POOL, PUBLIC.** A swimming pool that is not a private swimming pool. Public
11 swimming pools include swimming pools that are accessory to bathing establishments as such term
12 is defined in the *New York City Health Code*, whether owned or operated by city agencies, or
13 commercial interests or private entities, including, but not limited to, public or private schools,
14 corporations, hotels, motels, camps, apartment houses, condominiums, country clubs, gymnasia and
15 health establishments.

16 **SWING.** Rotation of the superstructure for movement of loads in a horizontal direction about the axis
17 of rotation.

18 **T RATING.** The time period that the penetration firestop system, including the penetrating item,
19 limits the maximum temperature rise to 325°F (163°C) above its initial temperature through the
20 penetration on the nonfire side when tested in accordance with ASTM E 814 or UL 1479.

21 **TECHNICAL PRODUCTION AREA.** Open elevated areas or spaces intended for entertainment
22 technicians to walk on and occupy for servicing and operating entertainment technology systems and
23 equipment. Galleries, including fly and lighting galleries, gridirons, catwalks, and similar areas are
24 designed for these purposes.

25 **TELEHANDLER.** A machine that consists of a powered chassis onto which is mounted an
26 extendable boom. The outer end of the boom can be fitted with various lifting or manipulative devices,
27 including but not limited to pallet forks.

28 **TEMPORARY CONSTRUCTION INSTALLATIONS.** Installations that are not part of the
29 permanent structure and that are installed to facilitate construction or demolition work, and are
30 intended to be taken apart or removed after a limited period following their installation. Such
31 installations include, but are not limited to, scaffolds, sidewalk sheds, fences, tower cranes, run back
32 structures, and similar construction and demolition related installations.

33 **TEMPORARY SIGN.** A sign, with display area 500 square feet (46.5 m²) or less, erected for a
34 period of 30 days or less.

35 **TEMPORARY SITE SAFETY TRAINING (SST) CARD.** A card that is issued in a form and
36 manner established by the department and that satisfies each of the following conditions:

1 1. Such card is issued by an SST provider to a person who demonstrates that such person has
2 successfully completed an OSHA 10-hour class and who is a new entrant to the construction
3 or demolition work force as determined by such provider pursuant to department rules.

4 2. Such card expires six months after issuance and is not renewable.

5 **TEMPORARY STRUCTURES.** Tents, grandstands, platforms, reviewing stands, outdoor
6 bandstands, stages, sculptures, and similar miscellaneous structures erected for a limited period.

7 **TENABLE ENVIRONMENT.** An environment in which the concentration and location of smoke
8 is limited or otherwise restricted to allow for ready evaluation through the space.

9 **TENSILE MEMBRANE STRUCTURE.** A membrane structure having a shape that is determined
10 by tension in the membrane and in the geometry of the support structure. Typically, the structure
11 consists of both flexible elements (e.g. membrane and cables), non-flexible elements (e.g. struts,
12 masts beams and arches), and the anchorage (e.g. supports and foundations). This includes frame
13 supported tensile membrane structures.

14 **TENT.** A nonpressurized membrane structure of a fabric weather barrier supported by poles and
15 guys, in which the fabric weather barrier does not impart stability to the structure. Tents need not be
16 fully enclosed on the sides.

17 **THERMAL ISOLATION.** Physical and space conditioning separation from conditioned space(s).
18 The conditioned space(s) shall be controlled as separate zones for heating and cooling or conditioned
19 by separate equipment.

20 **THERMOPLASTIC MATERIAL.** A plastic material that is capable of being repeatedly softened
21 by increase of temperature and hardened by decrease of temperature.

22 **THERMOSETTING MATERIAL.** A plastic material that is capable of being changed into a
23 substantially nonreformable product when cured.

24 **THROUGH-PENETRATION.** A breach in both sides of a floor, floor-ceiling or wall assembly to
25 accommodate an item passing through the breaches.

26 **THROUGH-PENETRATION FIRESTOP SYSTEM.** An assemblage consisting of a fire-
27 resistance-rated floor, floor-ceiling, or wall assembly, one or more penetrating items passing through
28 the breaches in both sides of the assembly and the materials or devices, or both, installed to resist the
29 spread of fire through the assembly for a prescribed period of time.

30 **TIE-DOWN (HOLD-DOWN).** A device used to resist uplift of the chords of shear walls.

31 **TIE, WALL.** Metal connector that connects wythes of masonry walls together.

32 **TILE, STRUCTURAL CLAY.** A hollow masonry unit composed of burned clay, shale, fire clay or
33 mixture thereof, and having parallel cells.

34 **TIRES, BULK STORAGE OF.** Storage of tires where the area available for storage exceeds 20,000
35 cubic feet (566 m³).

1 **TOOL.** See “Equipment.”

2 **TOWER CRANE.** A crane that utilizes a vertical mast or tower to support a working boom (jib) in
3 an elevated position. Loads are suspended from the working boom. While the working boom may be
4 of the fixed type (horizontal or angled) or have luffing capability, it can always rotate to swing loads,
5 either by rotating on the top of the tower (top slewing) or by the rotation of the tower (bottom slewing).
6 The tower base may be fixed in one location or ballasted and moveable between locations. The
7 definition of a tower crane shall include a climber crane. The definition of a tower crane shall not
8 include mobile cranes that are configured with luffing jib and/or tower attachments.

9 **TOWNHOUSE.** A single-family dwelling constructed in a group of three or more attached units in
10 which each unit extends from the foundation to roof and with open space on at least two sides.

11 **TOXIC MATERIAL.** A chemical that is lethal at the following doses or concentrations:

12 1. A chemical that has a median lethal dose (LD₅₀) of more than 50 milligrams per 1 kilogram,
13 but not more than 500 milligrams per kilogram of body weight when administered orally to
14 albino rats weighing between 200 and 300 grams each; or

15 2. A chemical that has a median lethal dose (LD₅₀) of more than 200 milligrams per 1 kilogram
16 but not more than 1,000 milligrams per kilogram of body weight when administered by
17 continuous contact for 24 hours (or less if death occurs within 24 hours) with the bare skin of
18 albino rabbits weighing between 2 and 3 kilograms each; or

19 3. A chemical that has a median lethal concentration (LC₅₀) in air of more than 200 parts per
20 million but not more than 2,000 parts per million by volume of gas or vapor, or more than 2
21 milligrams per liter but not more than 20 milligrams per liter of mist, fume or dust, when
22 administered by continuous inhalation for 1 hour (or less if death occurs within 1 hour) to
23 albino rats weighing between 200 and 300 grams each.

24 **Exception:** For purposes of this code, chlorine shall be classified as a highly toxic material.

25 **TRANSIENT.** Occupancy of a dwelling unit or sleeping unit for not more than 30 days.

26 **TRANSIENT AIRCRAFT.** Aircraft based at another location and that is at the transient location for
27 not more than 90 days.

28 **TRANSIENT LODGING.** A building, facility or portion thereof, excluding inpatient medical care
29 facilities and long-term care facilities, that contains one or more dwelling units or sleeping units.
30 Examples of transient lodging include, but are not limited to, resorts, group homes, hotels, motels,
31 dormitories, homeless shelters, halfway houses and social service lodging.

32 **TRANSIT.** The moving or transporting of a crane from one jobsite to another.

33 **TRANSPARENT.** The property of a material which is not opaque and through which objects lying
34 beyond are clearly visible.

1 **TRANSPARENT DOOR.** A door, manually or power actuated, fabricated of transparent material,
2 in which the transparent area above a reference line 18 inches (457 mm) above the bottom edge of
3 the door is 80 percent or more of the remaining area of the door above such reference line.

4 **TRANSPARENT SAFETY GLAZING MATERIALS.** Materials which will clearly transmit light
5 and also minimize the possibility of cutting or piercing injuries resulting from breakage of the
6 material. Materials covered by this definition include laminated glass, heat-toughened glass, case-
7 hardened glass or chemically tempered glass), wired glass, and plastic glazing.

8 **TRAVEL.** The function of the machine moving under its own power from one location to another on
9 a jobsite.

10 **TREATED WOOD.** Wood products that are conditioned to enhance fire-retardant or preservative
11 properties.

12 **Fire-retardant-treated wood.** Wood products that, when impregnated with chemicals by a
13 pressure process or other means during manufacture, exhibit reduced surface-burning
14 characteristics and resist propagation of fire.

15 **Preservative-treated wood.** Wood products that, conditioned with chemicals by a pressure
16 process or other means, exhibit reduced susceptibility to damage by moisture, mold, fungi, insects
17 or marine borers.

18 **TRENCH.** A narrow excavation (in relation to its length) made below the surface of the ground. In
19 general, the depth is greater than the width, but the width of a trench (measured at the bottom) is not
20 greater than 15 feet (4572 mm). If forms or other structures are installed or constructed in an
21 excavation so as to reduce the dimension measured from the forms or structure to the side of the
22 excavation to 15 feet (4572 mm) or less (measured at the bottom of the excavation), the excavation
23 is also considered to be a trench.

24 **TRIM.** Picture molds, chair rails, baseboards, handrails, door and window frames and similar
25 decorative or protective materials used in fixed applications.

26 **TROUBLE SIGNAL.** A signal initiated by the fire alarm system or device indicative of a fault in a
27 monitored circuit or component.

28 **TWO-POINT SUSPENDED SCAFFOLD (SWING STAGE).** A suspended scaffold consisting of
29 a platform supported by hangers (stirrups) suspended by two ropes from overhead supports and
30 equipped with means to permit the raising and lowering of the platform to desired working levels.

31 **TYPE A SOIL.** Cohesive soils with an unconfined compressive strength of 1.5 ton per square foot (tsf)
32 (144 kPa) or greater. Examples of cohesive soils are: clay, silty clay, sandy clay, clay loam and, in some
33 cases, silty clay loam and sandy clay loam. Cemented soils such as caliche and hardpan are also
34 considered Type A. However, no soil is Type A if:

35 (i) The soil is fissured;

36 (ii) The soil is subject to vibration from heavy traffic, pile driving, or similar effects;

1 (iii) The soil has been previously disturbed;

2 (iv) The soil is part of a sloped, layered system where the layers dip into the excavation on a slope of
3 four horizontal to one vertical (4H:1V) or greater; or

4 (v) The material is subject to other factors that would require it to be classified as a less stable
5 material.

6 **TYPE B SOIL.** Soils that meet one of the following:

7 (i) Cohesive soil with an unconfined compressive strength greater than 0.5 tsf (48 kPa) but less than
8 1.5 tsf (144 kPa);

9 (ii) Granular cohesionless soils including: angular gravel (similar to crushed rock), silt, silt loam,
10 sandy loam and, in some cases, silty clay loam and sandy clay loam;

11 (iii) Previously disturbed soils except those which would otherwise be classed as Type C soil;

12 (iv) Soil that meets the unconfined compressive strength or cementation requirements for Type A,
13 but is fissured or subject to vibration;

14 (v) Dry rock that is not stable; or

15 (vi) Material that is part of a sloped, layered system where the layers dip into the excavation on a
16 slope less steep than four horizontal to one vertical (4H:1V), but only if the material would
17 otherwise be classified as Type B.

18 **TYPE B UNIT.** A dwelling unit or sleeping unit designed and constructed for accessibility in
19 accordance with this code and the provisions for Type B units in ICC A117.1, consistent with the
20 design and construction requirements of the federal Fair Housing Act.

21 **TYPE B+NYC UNIT.** A dwelling unit or sleeping unit designed and constructed for accessibility in
22 accordance with this code and Section 1004 (Type B Units) of ICC A117.1, except as modified by
23 Sections 1107.2.1 through 1107.2.8 of this code.

24 **TYPE C SOIL.** Soils that meet one of the following:

25 (i) Cohesive soil with an unconfined compressive strength of 0.5 tsf (48kPa) or less;

26 (ii) Granular soils including gravel, sand, and loamy sand;

27 (iii) Submerged soil or soil from which water is freely seeping;

28 (iv) Submerged rock that is not stable, or

29 (v) Material in a sloped, layered system where the layers dip into the excavation or a slope of four
30 horizontal to one vertical (4H:1V) or steeper.

1 **UNCONFINED COMPRESSIVE STRENGTH (SOIL).** The load per unit area at which a soil will
2 fail in compression. It can be determined by laboratory testing, or estimated in the field using a pocket
3 penetrometer, by thumb penetration tests, and other methods.

4 **UNDERLAYMENT.** One or more layers of approved material over which a roof covering is applied.

5 **UNDERPINNING.** The alteration of an existing foundation to transfer loads to a lower bearing
6 stratum using new piers, piles, or other structural support elements installed below the existing
7 foundation.

8 **UNENCLOSED PERIMETER.** Any exterior portion of a building that is not solidly enclosed
9 with the permanent façade, including the windows; or any exterior edge of a roof that is not
10 enclosed with its permanent parapet or guardrail.

11 **UNSTABLE (REACTIVE) MATERIAL.** A material, other than an explosive, which in the pure
12 state or as commercially produced, will vigorously polymerize, decompose, condense or become self-
13 reactive and undergo other violent chemical changes, including explosion, when exposed to heat,
14 friction or shock, or in the absence of an inhibitor, or in the presence of contaminants, or in contact
15 with incompatible materials. Unstable (reactive) materials shall be classified as follows:

16 **Class 4.** Materials that in themselves are readily capable of detonation or explosive decomposition
17 or explosive reaction at normal temperatures and pressures. This class includes materials that are
18 sensitive to mechanical or localized thermal shock at normal temperatures and pressures.

19 **Class 3.** Materials that in themselves are capable of detonation or of explosive decomposition or
20 explosive reaction but which require a strong initiating source or which must be heated under
21 confinement before initiation. This class includes materials that are sensitive to thermal or
22 mechanical shock at elevated temperatures and pressures.

23 **Class 2.** Materials that in themselves are normally unstable and readily undergo violent chemical
24 change but do not detonate. This class includes materials that can undergo chemical change with
25 rapid release of energy at normal temperatures and pressures, and that can undergo violent
26 chemical change at elevated temperatures and pressures.

27 **Class 1.** Materials that in themselves are normally stable but which can become unstable at
28 elevated temperatures and pressure.

29 **USE (MATERIAL).** Placing a material into action, including solids, liquids and gases.

30 **USE/USING (SCAFFOLD).** Any work or activity performed on or from the scaffold. In addition,
31 for a suspended scaffold, the use of the scaffold shall include the operation of the scaffold at the
32 site, provided during such operation any vertical or horizontal relocation of the scaffold does not
33 require a modification to the counterweight, or does not require the placement, relocation, or
34 removal of any anchorage, attachment, outrigger beam, tie-back, or connection to the building or
35 structure.

36 **VALUE (OF ALTERATIONS, TO DETERMINE REQUIRED ACCESSIBILITY).** The value of
37 alterations shall be determined by adding the estimated cost of the proposed alteration, including

1 minor alterations but excluding ordinary repairs, computed as of the time of submitting the application
2 for construction document approval, or, where no permit is required, computed at the time of the
3 work, to the actual cost of any and all alterations and minor alterations made in the preceding 12-
4 month period. Where the alteration includes an enlargement, the value of the alteration shall include
5 the cost of the enlargement.

6 **VALUE (OF ALTERATIONS, TO DETERMINE REQUIRED FIRE PROTECTION).** The
7 value of alterations shall be determined by adding the estimated cost of the proposed alteration,
8 excluding minor alterations and ordinary repairs computed as of the time of submitting the application
9 for construction document approval, to the actual cost of any and all alterations made in the preceding
10 12-month period. Where the proposed alteration includes an enlargement, the value of such alteration
11 shall also include the cost of the enlargement.

12 **VALUE (OF EXISTING BUILDING OR SPACE).** The value of an existing building shall be
13 determined at the option of the applicant on the basis of one and one-quarter times the current assessed
14 valuation of the building, as adjusted by the current State equalization rate, or on the basis of the
15 current replacement cost of the building. The value of an existing space shall be determined on the
16 basis of the current replacement cost of the space. Satisfactory evidence of current replacement cost
17 shall be submitted to the commissioner. Where the alteration includes an enlargement, the value of
18 the existing building shall be determined without including the value of the enlargement.

19 **VAPOR-PERMEABLE MEMBRANE.** A material or covering having a permeance rating of 5
20 perms (52.9 10⁻¹⁰ kg/Pa.s. m²) or greater, when tested in accordance with the desiccant method using
21 Procedure A of ASTM E 96. A vapor-permeable material or covering permits the passage of moisture
22 vapor.

23 **VAPOR RETARDER CLASS.** A measure of a material or assembly's ability to limit the amount of
24 moisture that passes through that material or assembly. Vapor retarder class shall be defined using
25 the desiccant method of ASTM E 96 as follows:

26 Class I: 0.1 perm or less.

27 Class II: 0.1 < perm < 1.0 perm.

28 Class III: 1.0 < perm < 10 perm.

29 **VARIANCE.** See Section G201.1.2.

30 **VAULT.** Any space below the surface of a street that is covered over, except those openings that are
31 used exclusively as places for descending, by means of steps to the cellar or basement of any building.

32 **VEGETATIVE ROOF.** A system constructed in-situ consisting of either a roof assembly and
33 additional landscape material components, including growing media, engineered soils, filter fabric,
34 integral drainage systems and roof surface to facilitate the growth of vegetation or a pre-vegetated
35 tray or trays no more than 6 inches (152 mm) high and assembled on top of a roof covering.

36 **VEHICLE BARRIER.** A component or a system of components near open sides or walls of garage
37 floors or ramps that acts as a restraint for vehicles.

38 **VEHICULAR GATE.** A gate that is intended for use at a vehicular entrance or exit and that is not
39 intended for use by pedestrian traffic.

- 1 **VENEER.** A facing attached to a wall for the purpose of providing ornamentation, protection or
2 insulation, but not counted as adding strength to the wall. Veneers are nonstructural in that they do
3 not carry any load other than their own weight.
- 4 **VENTILATION.** The natural or mechanical process of supplying conditioned or unconditioned air
5 to, or removing such air from, any space.
- 6 **VINYL SIDING.** A shaped material, made principally from rigid polyvinyl chloride (PVC) that is
7 used as an exterior wall covering.
- 8 **VISIBLE ALARM NOTIFICATION APPLIANCE.** A notification appliance that alerts by the
9 sense of sight.
- 10 **V-ZONE.** Velocity Zones V, VO, VE, or V1-30 (See Coastal High Hazard Area).
- 11 **WALKABLE FLOOR (CONCRETE CONSTRUCTION).** A floor where the concrete slab has
12 been poured and the formwork stripped.
- 13 **WALKABLE FLOOR (PRECAST CONCRETE CONSTRUCTION).** A floor where the frame
14 is erected and the precast concrete floor is fixed in place.
- 15 **WALKABLE FLOOR (STEEL CONSTRUCTION).** A floor where the frame is erected and the
16 deck is tack welded or fixed in place.
- 17 **WALKWAY, PEDESTRIAN.** A walkway used exclusively as a pedestrian trafficway.
- 18 **WALL.** A vertical element with a horizontal length-to-thickness ratio greater than three, used to
19 enclose space.
- 20 **Cavity wall.** A wall built of masonry units or of concrete, or a combination of these materials,
21 arranged to provide an airspace within the wall, and in which the inner and outer parts of the wall
22 are tied together with metal ties.
- 23 **Dry-stacked, surface-bonded walls.** A wall built of concrete masonry units where the units are
24 stacked dry, without mortar on the bed or head joints, and where both sides of the wall are coated
25 with a surface-bonding mortar.
- 26 **Parapet wall.** The part of any wall entirely above the roof line.
- 27 **WALL, LOAD-BEARING.** Any wall meeting either of the following classifications:
- 28 1. Any metal or wood stud wall that supports more than 100 pounds per linear foot (1459
29 N/m) of vertical load in addition to its own weight.
- 30 2. Any masonry or concrete wall that supports more than 200 pounds per linear foot
31 (2919 N/m) of vertical load in addition to its own weight.
- 32 **WALL, NONLOAD-BEARING.** Any wall that is not a load-bearing wall.
- 33 **WALL SIGN.** Any sign attached to or erected against the wall of a building or structure, projecting
34 no more than 15 inches (381 mm) from the face of the wall, with the exposed face of the sign in a
35 plane parallel to the plane of said wall.

1 **WATERPROOFING.** Waterproofing is a protective measure applied to building foundation walls
2 and slabs to prevent moistures and liquid water from passing into interior spaces.

3 **WATER-REACTIVE MATERIAL.** A material that explodes; violently reacts; produces
4 flammable, toxic or other hazardous gases; or generates enough heat to cause auto-ignition or ignition
5 of combustibile materials upon exposure to water or moisture. Water-reactive materials are classified
6 as follows:

7 **Class 3.** Materials that react explosively with water without requiring heat or confinement.

8 **Class 2.** Materials that react violently with water or cause water to boil upon contact; produce
9 flammable, toxic or other hazardous gases upon contact with water; or upon contact with water
10 generate sufficient heat to cause auto-ignition of adjoining combustibile materials.

11 **Class 1.** Materials that may react with water with some release of energy, but not violently.

12 **WATER-RESISTIVE BARRIER.** A material behind an exterior wall covering that is intended to
13 resist liquid water that has penetrated behind the exterior wall covering from further intruding into
14 the exterior wall assembly.

15 **WEATHER-EXPOSED SURFACES.** Surfaces of walls, ceilings, floors, roofs, soffits and similar
16 surfaces exposed to the weather except the following:

17 1. Ceilings and roof soffits enclosed by walls, fascia, bulkheads or beams that extend a minimum
18 of 12 inches (305 mm) below such ceiling or roof soffits.

19 2. Walls or portions of walls beneath an unenclosed roof area, where located a horizontal
20 distance form an open exterior opening equal to at least twice the height of the opening.

21 3. Ceiling and roof soffits located a minimum horizontal distance of 10 feet (3048 mm) from the
22 outer edges of the ceiling or roof soffits.

23 **WET-CHEMICAL EXTINGUISHING SYSTEM.** A solution of water and potassium-carbonate-
24 based chemical, potassium-acetate-based chemical or a combination thereof, forming a fire-
25 extinguishing agent.

26 **WHEEL MOUNTED CRANE (MULTIPLE CONTROL STATIONS).** A mobile crane
27 consisting of a rotating superstructure, operating machinery, and operator's station and boom,
28 mounted on a crane carrier equipped with axles and rubber-tired wheels for travel, a power source(s),
29 and having separate stations for driving and operating.

30 **WHEEL MOUNTED CRANE (SINGLE CONTROL STATION).** A mobile crane consisting of
31 a rotating superstructure, operating machinery, and boom, mounted on a crane carrier equipped with
32 axles and rubber-tired wheels for travel, a power source, and having a single control station for driving
33 and operating.

34 **WHEELCHAIR SPACE.** A space for a single wheelchair and its occupant.

35 **WIND SPEED, V (BASIC).** Basic design wind speeds.

- 1 **WIND SPEED, V_{asd} . (ALLOWABLE STRESS DESIGN).** Allowable stress design wind speeds.
- 2 **WIND-BORNE DEBRIS REGION.** Areas within hurricane-prone regions located:
- 3 1. Within 1 mile (1.61 km) of the coastal mean high water line where the basic design wind
4 speed, V , is 130 mph (58 m/s) or greater.
- 5 For Risk Category IV buildings and structures, and Risk Category III health care facilities, the
6 wind-borne debris region shall be based on the basic design wind speed for Risk Category IV on
7 Table 1609.3.
- 8 **WINDER.** A stair tread with nonparallel edges.
- 9 **WIRE BACKING.** Horizontal strands of tautened wire attached to surfaces of vertical supports that,
10 when covered with the building paper, provide a backing for cement plaster.
- 11 **WIRELESS PROTECTION SYSTEM.** A system or a part of a system that can transmit and receive
12 signals without the aid of wire.
- 13 **WOOD SHEAR PANEL.** A wood floor, roof or wall component sheathed to act as a shear wall or
14 diaphragm.
- 15 **WOOD STRUCTURAL PANEL.** A panel manufactured from veneers, wood strands or wafers or
16 a combination of veneer and wood strands or wafers bonded together with waterproof synthetic resins
17 or other suitable bonding systems. Examples of wood structural panels are:
- 18 **Composite panels.** A wood structural panel that is comprised of wood veneer and reconstituted
19 wood-based material and bonded together with waterproof adhesive;
- 20 **Oriented strand board (OSB).** A mat-formed wood structural panel comprised of thin
21 rectangular wood strands arranged in cross-aligned layers with surface layers normally arranged
22 in the long panel direction and bonded with waterproof adhesive; or
- 23 **Plywood.** A wood structural panel comprised of plies of wood veneer arranged in cross-aligned
24 layers. The plies are bonded with waterproof adhesive that cures on application of heat and
25 pressure.
- 26 **WOOD/PLASTIC COMPOSITE.** A composite material made primarily from wood or cellulose-
27 based materials and plastic.
- 28 **WORKING DECK (CONCRETE CONSTRUCTION).** The level where the floor is being formed.
- 29 **WORKING DECK (DEMOLITION).** The level where the floor is being broken up.
- 30 **WORKING DECK (PRECAST CONCRETE CONSTRUCTION).** The level where the floor is
31 being placed.
- 32 **WORKING DECK (STEEL CONSTRUCTION).** The floor where the metal decking and steel
33 components are being placed before concrete is poured.

1 **WORKSTATION.** A defined space within a fabrication area in which a specific function, laboratory
2 procedure or research activity relating to semiconductor manufacture is conducted. A workstation
3 may include equipment using HPM, hazardous materials storage cabinets, flammable liquid storage
4 cabinets or gas cabinets, ventilation equipment, fire protection devices, detection devices, and
5 electrical devices.

6 **WYTHE.** Each continuous, vertical section of a wall, one masonry unit in thickness.

7 **YARD.** An open space, other than a court, unobstructed from the ground to the sky, except where
8 specifically provided by this code, on the lot on which a building is situated.

9 **ZERO CLEARANCE VESTIBULE.** A limited space on the elevator lobby between the exterior of
10 the hoistway door and the security door attached to the elevator hoistway.

11 **ZONE.** A defined area within the protected premises. A zone can define an area from which a signal
12 can be received, an area to which a signal can be sent or an area in which a form of control can be
13 executed.

14 **ZONE, NOTIFICATION.** An area within a building or facility covered by notification appliances
15 that are activated simultaneously.

16 § 4. Chapter 3 of the New York city building code, as added by local law number 33
17 for the year 2007, sections 302.1, 303.1, 306.1, 306.2, 306.3, 306.4, 307.1, 307.2, 307.3, 307.4, 307.5,
18 307.6, 307.7, 308.2, 308.2.2, 308.3, 308.4, 308.5, 309.1, 309.2, 310, 310.1.1, 310.1.2, 310.2, 311.2,
19 and 311.3, and tables 307.1(1) and 307.1(2), and the title of section 308 as amended by, and sections
20 304.1.1, 307.1.1, and 308.3.1 as added by local law number 141 for the year 2013, and section 304.1
21 as amended by local law number 78 for the year 2015, is amended to read as follows:

22 **CHAPTER 3**
23 **USE AND OCCUPANCY CLASSIFICATION**

24 **SECTION BC 301**
25 **GENERAL**

26 **301.1 Scope.** The provisions of this chapter shall control the classification of all buildings and
27 structures, and spaces therein, as to use and occupancy.

28 **SECTION BC 302**
29 **CLASSIFICATION**

30 **302.1 General.** Structures or portions of structures shall be classified with respect to occupancy in
31 one or more of the groups listed below. A room or space that is intended to be occupied at different
32 times for different purposes shall comply with all of the requirements that are applicable to each of
33 the purposes for which the room or space will be occupied. Structures with multiple occupancies or

1 uses shall comply with Section 508. Where a structure, or portion thereof, is proposed for a purpose
2 [~~which~~] that is not specifically provided for in this code, such structure, or portion thereof, shall be
3 classified in the group [~~which~~] that the occupancy most nearly resembles, according to the fire safety
4 and relative hazard involved, and as approved by the commissioner.

- 5 1. Assembly (see Section 303): Groups A-1, A-2, A-3, A-4 and A-5.
- 6 2. Business (see Section 304): Group B.
- 7 3. Educational (see Section 305): Group E.
- 8 4. Factory and Industrial (see Section 306): Groups F-1 and F-2.
- 9 5. High Hazard (see Section 307): Groups H-1, H-2, H-3, H-4 and H-5.
- 10 6. Institutional (see Section 308): Groups I-1, I-2, I-3 and I-4.
- 11 7. Mercantile (see Section 309): Group M.
- 12 8. Residential (see Section 310): Groups R-1, R-2 and R-3.
- 13 9. Storage (see Section 311): Groups S-1 and S-2.
- 14 10. Utility and Miscellaneous (see Section 312): Group U.

15 For a listing of occupancy group classifications that corresponds with uses listed in the *New York*
16 *City Zoning Resolution*, refer to department rules.

17 **SECTION BC 303**
18 **ASSEMBLY GROUP A**

19 **303.1 Assembly Group A.** Assembly Group A occupancy includes, among others, the use of a
20 building or structure or a portion thereof, excluding a dwelling unit, for the gathering of any number
21 of persons for purposes such as civic, social or religious functions, recreation, food or drink
22 consumption, awaiting transportation, or similar group activities; or when occupied by 75 persons
23 or more for educational or instructional purposes.

24 [~~Exceptions:~~]

25 **303.1.1 Definitions.** The following term is defined in Chapter 2:

26 **PLACE OF ASSEMBLY.**

27 **303.1.2 Buildings and nonaccessory tenant spaces.** [~~1-~~] A building or nonaccessory tenant
28 space used for assembly purposes with an occupant load of fewer than 75 persons shall be
29 classified as a Group B occupancy, except that the number of plumbing fixtures for such a
30 building or space is permitted to be calculated in accordance with the requirements for assembly
31 occupancies.

1 **303.1.3 Accessory assembly spaces.** [~~2-~~] A room or space used for assembly purposes with an
2 occupant load of fewer than 75 persons and accessory to another occupancy shall be classified
3 as a Group B occupancy or as part of that occupancy, except that the number of plumbing fixtures
4 for such a room or space is permitted to be calculated in accordance with the requirements for
5 assembly occupancies.

6 [~~Assembly occupancies shall include the following.~~]**303.2 Assembly Group A-1.** Group A-1
7 occupancy includes assembly uses, usually with fixed seating, intended for the production and
8 viewing of the performing arts or motion pictures including, but not limited to:

9 Motion picture theaters

10 Symphony and concert halls

11 Television and radio studios admitting an audience

12 Theaters

13 [~~A-2~~] **303.3 Assembly Group A-2.** Group A-2 occupancy includes assembly uses intended for food
14 and/or drink consumption including, but not limited to:

15 Banquet halls

16 Cabarets

17 [~~Cafeterias, except as provided for in A-3]~~

18 [~~Dance halls]~~

19 [~~Night clubs]~~

20 Casinos (gaming areas)

21 Nightclubs, including dance halls

22 Restaurants, cafeterias (except as provided for in A-3), and similar dining facilities

23 Taverns and bars

24 [~~A-3~~] **303.4 Assembly Group A-3.** Group A-3 occupancy includes assembly uses intended for
25 worship, recreation or amusement and other assembly uses not classified elsewhere in Group A
26 including, but not limited to:

27 Amusement arcades

28 Art galleries

29 Bowling alleys

30 Cafeterias for children up to and including the 12th grade

- 1 Classrooms and instructional rooms with 75 persons or more; such rooms with fewer than 75
- 2 persons shall be classified as Group B or E
- 3 Community halls
- 4 Courtrooms
- 5 Custodial care facilities with 75 or more persons, providing care to persons over the age of 2,
- 6 where no more than four occupants are incapable of responding to an emergency situation
- 7 without physical assistance from staff
- 8 Dance studio or instruction (not including food or drink consumption)
- 9 Exhibition halls
- 10 Funeral parlors
- 11 Gymnasiums (without spectator seating)
- 12 [~~Religious houses of worship~~]
- 13 Indoor swimming pools (without spectator seating)
- 14 Indoor tennis courts (without spectator seating)
- 15 Lecture halls
- 16 Museums
- 17 Places of religious worship (Houses of worship)
- 18 [~~Waiting areas in transportation terminals~~]
- 19 Pool and billiard parlors
- 20 School auditoriums
- 21 Waiting areas in transportation terminals
- 22 [~~A-4~~] **303.5 Assembly Group A-4.** Group A-4 occupancy includes assembly uses intended for
- 23 viewing of indoor sporting events and activities with spectator seating including, but not limited to:
- 24 Arenas
- 25 Skating rinks
- 26 Swimming pools
- 27 Tennis courts
- 28 [~~A-5~~] **303.6 Assembly Group A-5.** Group A-5 occupancy includes assembly uses intended for
- 29 participation in or viewing outdoor activities including, but not limited to:
- 30 Amusement park structures
- 31 Bleachers
- 32 Grandstands
- 33 Stadiums

1 ~~[303.2]~~ **303.7 Certificate of Operation.** A Certificate of Operation shall be required, as per Section
2 28-117.1, for the following ~~[places of]~~ assembly occupancies:

- 3 1. Indoor ~~[places of]~~ assembly occupancies used or intended for use by 75 persons or more,
4 including open spaces at 20 feet (6096 mm) or more above or below grade plane, such as
5 roofs or roof terraces.
- 6 2. Outdoor ~~[places of]~~ assembly occupancies used and intended for use by 200 persons or more.

7 **SECTION BC 304**
8 **BUSINESS GROUP B**

9 **304.1 Business Group B.** Business Group B occupancy includes, among others, the use of a building
10 or structure, or a portion thereof, for office, professional, service-type transactions, or for conducting
11 public or civic services, including the incidental storage of records and accounts and the incidental
12 storage of limited quantities of stocks of goods for office use or purposes. Business Group B
13 occupancies shall include, but not be limited to, the following:

- 14 Airport traffic control towers
- 15 Ambulatory ~~[health]~~ care facilities
- 16 Animal hospitals, kennels and pounds, veterinary clinics and pet shops
- 17 Banks
- 18 Barber and beauty shops
- 19 Civic administration offices
- 20 Clinic outpatient, including group medical centers, and neighborhood family care centers
- 21 Custodial care facilities with fewer than 75 persons, providing care to persons over the age of 2,
22 where no more than four occupants are incapable of responding to an emergency situation
23 without physical assistance from staff
- 24 Dry cleaning and laundries; pick-up and delivery stations and self-service
- 25 Educational occupancies for students above the 12th grade, where not classified in Group A. Such
26 occupancy may be used occasionally for educational purposes offered to children through the
27 12th grade
- 28 Electronic data processing
- 29 Laboratories; nonproduction testing and research, as per Section ~~[424]~~ 427
- 30 Libraries when not classified in Group E
- 31 Motor vehicle showrooms
- 32 Offices
- 33 Post offices
- 34 Photocopying and printing shops using electronic printing equipment
- 35 Professional services (architects, attorneys, dentists, physicians, engineers, etc.)
- 36 Radio and television stations not admitting an audience

1 Telephone exchanges
2 Training and skill development not ~~[within]~~ in a school or academic program (this shall include,
3 but not be limited to, tutoring centers, martial arts studios, gymnastics and similar uses
4 regardless of the ages served, and where not classified as a Group A occupancy)

5 ~~[304.1.1]~~ **304.2 Definitions.** The following ~~[words and]~~ terms ~~[shall, for the purposes of this section~~
6 ~~and as used elsewhere in this code, have the meanings shown herein.]~~ are defined in Chapter 2:

7 **AMBULATORY CARE FACILITY.**

8 **CLINIC, OUTPATIENT.** ~~[Buildings or portions thereof used to provide medical care on less than~~
9 ~~a 24-hour basis to individuals who are not rendered incapable of self-preservation by the services~~
10 ~~provided.]~~

11 **SECTION BC 305**
12 **EDUCATIONAL GROUP E**

13 **305.1 Educational Group E.** Educational Group E occupancy includes, among others, the use of a
14 building or structure, or a portion thereof, by five or more persons at any one time for educational
15 purposes offered to children through the 12th grade and where no more than two children are under
16 the age of 2, including but not limited to the following:

- 17 Academies
- 18 Day care facilities where no more than two children are under the age of 2
- 19 Libraries accessory to Group E occupancies
- 20 Schools

21 **Exceptions:**

- 22 1. Classrooms and instructional rooms with 75 or more persons shall be classified as Group
23 A-3.
- 24 2. Day care services provided within a dwelling unit as described in Section 310.
- 25 3. Custodial care facilities with up to 30 children under the age of 2 are permitted to be
26 classified as Group E when the rooms where such children are cared for are located on
27 the level of exit discharge and each of these child care rooms has an exit door directly to
28 the exterior.

29 **305.2 Reserved.**

30 **SECTION BC 306**
31 **FACTORY GROUP F**

32 **306.1 Factory Industrial Group F.** Factory Industrial Group F occupancy includes, among others,
33 the use of a building or structure, or a portion thereof, for assembling, disassembling, fabricating,
34 finishing, manufacturing, packaging, repair, cleaning, laundering or processing operations that are
35 not classified as a Group H hazardous occupancy. Factory Industrial Group F occupancy also
36 includes certain mechanical and/or electrical equipment rooms in accordance with Section 306.3.

1 **306.2 [~~Factory Industrial F-1 Moderate Hazard Occupancy~~] Moderate-hazard factory**
2 **industrial, Group F-1.**

3 Factory industrial uses [~~which~~] that are not classified as Factory Industrial F-2 Low Hazard shall be
4 classified as F-1 Moderate Hazard and shall include, but not be limited to, the following:

- 5 Aircraft (manufacturing, not to include repair)
- 6 Aircraft repairs
- 7 Automobiles and other motor vehicles, manufacturing
- 8 Automobiles and other motor vehicles, repairs
- 9 Bakeries
- 10 Beverages; over [~~16 percent~~] 16-percent alcohol content
- 11 Boats
- 12 Boat repairs
- 13 Brooms or brushes
- 14 Canvas or similar fabric
- 15 Carpets and rugs
- 16 Carpets and rugs, cleaning, using or storing solvents having a flash point between 100°F (38°C)
17 and 138.2°F (59°C) (Tag closed cup)
- 18 Clothing
- 19 Disinfectants
- 20 Dry cleaning and dyeing using or storing solvents having a flash point between 100°F (38°C)
21 and 138.2°F (59°C) (Tag closed cup)
- 22 Electric generation plants
- 23 Electrical substations
- 24 Engines (including rebuilding)
- 25 Food processing, except meat slaughtering or preparation of fish for packing
- 26 Food processing establishments and commercial kitchens not adjoining a restaurant, cafeteria or
27 similar dining facilities
- 28 Furniture
- 29 Hemp products
- 30 Jute products
- 31 Laboratories; for production (moderate-hazard), that may involve the synthesis or storage of
32 materials that constitute a physical or health hazard in quantities below those found in Tables
33 307.1(1) and 307.1(2)
- 34 Leather products

- 1 Metals; finishing, plating, grinding, sharpening, polishing, cleaning, rustproofing, heat treatment
- 2 or similar processes
- 3 Millwork (sash and door)
- 4 Motion pictures filming (without spectators)
- 5 Musical instruments
- 6 Optical goods
- 7 Paper mills or products
- 8 Photographic film
- 9 Plastic products
- 10 Printing or publishing
- 11 Recreational vehicles
- 12 Refuse incineration
- 13 Shoes
- 14 Soaps and detergents
- 15 Textiles
- 16 Tobacco
- 17 Trailers
- 18 Upholstering
- 19 Wood; distillation
- 20 Woodworking (cabinet) using no more than 2 quarts (1.9 L) per day or storing no more than 20
- 21 gallons (75.7 L) of paint, varnish, lacquer or shellac

22 **306.3** [~~Factory Industrial F-2~~] **Low-hazard** [~~Occupancy~~] **factory industrial, Group F-2.** Factory
 23 industrial uses that involve the cleaning, laundering, fabrication or manufacturing of noncombustible
 24 materials [~~which~~] that during finishing, packing or processing do not involve a significant fire hazard
 25 shall be classified as F-2 occupancies and shall include, but not be limited to, the following:

- 26 Appliances
- 27 Athletic equipment
- 28 Automobile laundries
- 29 Automobile wrecking establishments
- 30 Beverages; up to and including [~~16-percent~~] 16-percent alcohol content; bottling works
- 31 Beverages; nonalcoholic
- 32 Bicycles
- 33 Brick and masonry
- 34 Business machines

- 1 Cameras and photo equipment
- 2 Carpets and rugs, cleaning, using or storing solvents having a flash point above 138.2°F (59°C)
- 3 (Tag closed cup)
- 4 Ceramic products
- 5 Commercial kitchens adjoining restaurants, cafeterias (including those classified in Group A-3),
- 6 or similar dining facilities
- 7 Construction and agricultural machinery
- 8 Dry cleaning and dyeing using or storing solvents having a flash point above 138.2°F (59°C)
- 9 (Tag closed cup)
- 10 Electronics
- 11 Food processing; meat slaughtering or preparation of fish for packing
- 12 Foundries
- 13 Glass products
- 14 Gypsum
- 15 Ice
- 16 Laboratories; for production (low-hazard), that may involve the synthesis or storage of materials
- 17 that constitute a physical or health hazard in quantities below those found in Tables 307.1(1)
- 18 and 307.1(2)
- 19 Laundries
- 20 Machinery
- 21 Mechanical and/or electrical equipment rooms that are neither identified as incidental uses in
- 22 Table 509 nor classified as the occupancy within which they are located per Section 508.1
- 23 Metal products (fabrication and assembly), not including flammable metals and alloys listed in
- 24 Section 307
- 25 Plastic products; nonflammable
- 26 Printing; incidental to primary use, area not exceeding 2,000 square feet (185.8 m²)
- 27 Television filming (without spectators)
- 28 **306.4 Location restrictions.** Locations of spaces classified in Factory Group F may be restricted
- 29 within a building containing a Group R occupancy pursuant to Section 510.8.

30 **SECTION BC 307**
31 **HIGH-HAZARD GROUP H**

32 **307.1 [~~High-Hazard~~ High-hazard] Group H.** [~~High-Hazard~~ High-hazard] Group H occupancy
33 includes, among others, the use of a building or structure, or a portion thereof, that involves the
34 manufacturing, processing, generation or storage of materials that constitute a physical or health
35 hazard in quantities in excess of those allowed in control areas complying with Section 414, based on
36 the maximum allowable quantity limits for control areas set forth in Tables 307.1(1) and 307.1(2).

1 Hazardous occupancies are classified in Groups H-1, H-2, H-3, H-4 and H-5 and shall be in
2 accordance with this section, the requirements of Section 415 and the *New York City Fire Code*.

3 [~~Exceptions: The following shall not be classified as Group H, but shall be classified as the~~
4 ~~occupancy that they most nearly resemble.~~]

5 **307.1.1 Uses other than Group H.** An occupancy that stores, uses or handles hazardous materials as
6 described in one or more of the following items shall not be classified as Group H, but shall be
7 classified as the occupancy that it most nearly resembles.

- 8 1. Buildings and structures occupied for the application of flammable finishes, provided that
9 such buildings or areas conform to the requirements of [~~Section 416 and~~] the *New York*
10 *City Fire Code* and Section 416 of this code.
- 11 2. Wholesale and retail sales and storage of flammable and combustible liquids in mercantile
12 occupancies conforming to the *New York City Fire Code*.
- 13 3. Closed piping system containing flammable or combustible liquids or gases utilized for
14 the operation of machinery or equipment.
- 15 4. Cleaning establishments that utilize combustible liquid solvents having a flash point of
16 140°F (60°C) or higher in closed systems employing equipment listed by an approved
17 testing agency, provided that this occupancy is separated from all other areas of the
18 building by 1-hour fire barriers constructed in accordance with Section 707 or 1-hour
19 horizontal assemblies constructed in accordance with Section [~~712~~] 711, or both.
- 20 5. Cleaning establishments that utilize a liquid solvent having a flash point at or above
21 200°F (93°C).
- 22 6. Liquor stores and distributors without bulk storage.
- 23 7. Refrigeration systems.
- 24 8. The storage or utilization of materials for agricultural purposes on the premises.
- 25 9. Stationary batteries utilized for facility emergency or standby power, [~~uninterrupted~~]
26 uninterruptable power supply or telecommunication facilities, provided that the batteries
27 are provided with safety venting caps and ventilation is provided in accordance with the
28 *New York City Mechanical Code*.
- 29 10. [~~Corrosives shall not include personal or household products in their original packaging~~
30 ~~used in retail display or commonly used building materials.~~] Corrosive personal or
31 household products in their original packaging used in retail display.
- 32 11. Commonly used corrosive building materials.
- 33 [~~11.~~] 12. Buildings and structures occupied for aerosol storage shall be classified as Group S-
34 1, provided that such buildings conform to the requirements of the *New York City Fire*
35 *Code*.

1 [42.] 13. Display and storage of nonflammable solid and nonflammable or
2 noncombustible liquid hazardous materials in quantities not exceeding the maximum
3 allowable quantity per control area in Group M or S occupancies complying with Section
4 414.2.5.

5 [43.] 14. The storage of black powder, smokeless propellant and small arms primers in
6 Groups M and R-3 and special industrial explosive devices in Groups B, F, M and S,
7 provided such storage conforms to the quantity limits and requirements prescribed in the
8 *New York City Fire Code*.

9 [44.] 15. Laboratories for nonproduction testing, research, experimental, instructional
10 or educational purposes, in compliance with Section [424] 427.

11 ~~[307.1.1 Hazardous materials. Hazardous materials in any quantity shall conform to the~~
12 ~~requirements of this code, including Section 414, and the *New York City Fire Code*.]~~

13

TABLE 307.1(1)
MAXIMUM ALLOWABLE QUANTITY PER CONTROL AREA OF HAZARDOUS MATERIALS POSING A PHYSICAL HAZARD^{a,j,m,n,q}

MATERIAL	CLASS	GROUP WHEN THE MAXIMUM ALLOWABLE QUANTITY IS EXCEEDED ^d	STORAGE ^b			USE-CLOSED SYSTEMS ^b			USE-OPEN SYSTEMS ^b		
			Solid Pounds (cubic feet)	Liquid Gallons (pounds)	Gas SCF	Solid Pounds (cubic feet)	Liquid gallons (pounds)	Gas SCF	Solid Pounds (cubic feet)	Liquid gallons (pounds)	
Combustible Liquid ^{c, i, r}	II	H-2 or H-3		120 ^{d, e}			120 ^d			30 ^d	
	IIIA	H-2 or H-3	Not Applicable	330 ^{d, e}	Not Applicable	Not Applicable	330 ^d	Not Applicable	Not Applicable	80 ^d	
	IIIB	Not Applicable		13,200 ^{e, f}			13,200 ^f			3,300 ^f	
Combustible fiber	Loose	H-3	(100)	Not Applicable	Not Applicable	(100)	Not Applicable	Not Applicable	(20)	Not Applicable	
	Baled ^s		(1,000)			(200)					
Cryogenics flammable	Not Applicable	H-2	Not Applicable	45 ^d	Not Applicable	Not Applicable	45 ^d	Not Applicable	Not Applicable	10 ^d	
Cryogenics oxidizing	Not Applicable	H-3	Not Applicable	45 ^d	Not Applicable	Not Applicable	45 ^d	Not Applicable	Not Applicable	10 ^d	
Explosives	Division 1.1	H-1	1 ^{e, g}	(1) ^{e, g}	Not Applicable	0.25 ^g	(0.25) ^g	Not Applicable	0.25 ^g	(0.25) ^g	
	Division 1.2	H-1	1 ^{e, g}	(1) ^{e, g}		0.25 ^g	(0.25) ^g		0.25 ^g	(0.25) ^g	
	Division 1.3	H-1 or H-2	5 ^{e, g}	(5) ^{e, g}		1 ^g	(1) ^g		1 ^g	(1) ^g	
	Division 1.4	H-3	50 ^{e, g}	(50) ^{e, g}		50 ^g	(50) ^g		Not Applicable	Not Applicable	Not Applicable
	Division 1.4G	H-3	125 ^{d, e, 1}	Not Applicable		Not Applicable	Not Applicable		Not Applicable	Not Applicable	Not Applicable
	Division 1.5	H-1	1 ^{e, g}	(1) ^{e, g}		0.25 ^g	(0.25) ^g		0.25 ^g	(0.25) ^g	
Division 1.6	H-1	1 ^{d, e, g}	Not Applicable	Not Applicable	Not Applicable	Not Applicable	Not Applicable	Not Applicable			
Flammable gas	Gaseous	H-2	Not Applicable	Not Applicable	1,000 ^{d, e}	Not Applicable	Not Applicable	1,000 ^{d, e}	Not Applicable	Not Applicable	
	Liquefied		(150) ^{d, e}	(150) ^{d, e}							
Flammable liquids ^{s, k}	IA ^o	H-2 or H-3	Not Applicable	30 ^{d, e}	Not Applicable	Not Applicable	30 ^d	Not Applicable	Not Applicable	10 ^d	
	IB and IC		120 ^{d, e}	120 ^d		30 ^d					
Combination Flammable liquid (IA ^o , IB, IC)	Not Applicable	H-2 or H-3	Not Applicable	120 ^{d, e, h}	Not Applicable	Not Applicable	120 ^{d, h}	Not Applicable	Not Applicable	30 ^{d, h}	
Flammable solids ⁵	Not Applicable	H-3	Pigs, ingots, billets, heavy castings	1,000 ^{d, e}	Not Applicable	1,000 ^d	Not Applicable	1,000 ^d	Not Applicable	Not Applicable	
			Light castings, light metallic products	125 ^{d, e}		125 ^d		25 ^d			
			Scraps, shavings, powders, dusts	1 ^{d, e}		1 ^d		1 ^d			
			All others	125 ^{d, e}		125 ^d		25 ^d			
Inert gas	Gaseous	Not Applicable	Not Applicable	Not Applicable	Not Limited	Not Applicable	Not Applicable	Not Limited	Not Applicable	Not Applicable	
	Liquefied		Not Applicable				Not Applicable				
Cryogenic inert	Not Applicable	Not Applicable	Not Applicable	Not Applicable	Not Limited	Not Applicable	Not Applicable	Not Limited	Not Applicable	Not Applicable	
Organic peroxide ^p	Unclassified Detonable	H-1	1 ^{e, g}	(1) ^{e, g}	Not Applicable	0.25 ^g	(0.25) ^g	Not Applicable	0.25 ^g	(0.25) ^g	
	I	H-2	5 ^{d, e}	(5) ^{d, e}		1 ^d	(1) ^d		1 ^d	(1) ^d	
	II	H-3	50 ^{d, e}	(50) ^{d, e}		50 ^d	(50) ^d		10 ^d	(10) ^d	
	III	H-3	125 ^{d, e}	(125) ^{d, e}		125 ^d	(125) ^d		25 ^d	(25) ^d	
	IV	Not Applicable	Not Limited	Not Limited		Not Limited	Not Limited		Not Limited	Not Limited	

TABLE 307.1(1)
MAXIMUM ALLOWABLE QUANTITY PER CONTROL AREA OF HAZARDOUS MATERIALS POSING A PHYSICAL HAZARD^{a,j,m,n,q}

MATERIAL	CLASS	GROUP WHEN THE MAXIMUM ALLOWABLE QUANTITY IS EXCEEDED ^d	STORAGE ^b			USE-CLOSED SYSTEMS ^b			USE-OPEN SYSTEMS ^b	
			Solid Pounds (cubic feet)	Liquid Gallons (pounds)	Gas SCF	Solid Pounds (cubic feet)	Liquid gallons (pounds)	Gas SCF	Solid Pounds (cubic feet)	Liquid gallons (pounds)
	V	Not Applicable	Not Limited	Not Limited		Not Limited	Not Limited		Not Limited	Not Limited
Oxidizer	4	H-1	1 ^g	(1) ^{e, g}	Not Applicable	0.25 ^g	(0.25) ^g	Not Applicable	0.25 ^g	(0.25) ^g
	3 ^k	H-2	10 ^{d, e}	(10) ^{d, e}		2 ^d	(2) ^d		2 ^d	(2) ^d
	2	H-3	250 ^{d, e}	(250) ^{d, e}		250 ^d	(250) ^d		50 ^d	(50) ^d
	1	H-3	4,000 ^{e, f}	(4,000) ^{e, f}		4,000 ^f	(4,000) ^f		1,000 ^f	(1,000) ^f
Oxidizing gas	Gaseous	H-3	Not Applicable	Not Applicable	1,500 ^{d, e}	Not Applicable	Not Applicable	1,500 ^{d, e}	Not Applicable	Not Applicable
	Liquefied		Not Applicable	(150) ^{d, e}	Not Applicable		(150) ^{d, e}			
Pyrophoric material ^p detonable	Not Applicable	H-1	1 ^{e, g}	(1) ^{e, g}	10 ^{e, g}	0.25 ^g	(0.25) ^g	2 ^{e, g}	0	0
Pyrophoric material nondetonable	Not Applicable	H-2	4 ^{e, g}	(4) ^{e, g}	50 ^{e, g}	1 ^g	(1) ^g	10 ^{e, g}	0	0
Unstable (reactive) ^p detonable	4	H-1	1 ^{e, g}	(1) ^{e, g}	10 ^{e, g}	0.25 ^g	(0.25) ^g	2 ^{e, g}	0.25 ^g	(0.25) ^g
	3	H-1	1 ^{e, g}	(1) ^{e, g}	10 ^{e, g}	0.25 ^g	(0.25) ^g	2 ^{e, g}	0.25 ^g	(0.25) ^g
Unstable (reactive) nondetonable	4	H-1	1 ^{e, g}	(1) ^{e, g}	10 ^{e, g}	0.25 ^g	(0.25) ^g	2 ^{e, g}	0.25 ^g	(0.25) ^g
	3	H-1 or H-2	5 ^{d, e}	(5) ^{d, e}	50 ^{d, e}	1 ^d	(1) ^d	10 ^{d, e}	1 ^d	(1) ^d
	2	H-3	50 ^{d, e}	(50) ^{d, e}	250 ^{d, e}	50 ^d	(50) ^d	250 ^{d, e}	10 ^d	(10) ^d
	1	Not Applicable	Not Limited	Not Limited	750 ^{d, e}	Not Limited	Not Limited	Not Limited	Not Limited	Not Limited
Water-reactive detonable ^p	3	H-1	1 ^{e, g}	(1) ^{e, g}	Not Applicable	0.25 ^g	(0.25) ^g	Not Applicable	0.25 ^g	(0.25) ^g
	2	H-1	1 ^{e, g}	(1) ^{e, g}		0.25 ^g	(0.25) ^g		0.25 ^g	(0.25) ^g
Water-reactive nondetonable	3	H-2	5 ^{d, e}	(5) ^{d, e}	Not Applicable	5 ^d	(5) ^d	Not Applicable	1 ^d	(1) ^d
	2	H-3	50 ^{d, e}	(50) ^{d, e}		50 ^d	(50) ^d		10 ^d	(10) ^d
	1	Not Applicable	Not Limited	Not Limited		Not Limited	Not Limited		Not Limited	Not Limited

For SI: 1 cubic foot = 0.028 m³, 1 pound = 0.454 kg, 1 gallon = 3.785 L.

- a. For use of control areas, see [Section 2703.8.3 of] the *New York City Fire Code* and Section 414.2 of this code.
- b. The aggregate quantity in storage, handling and use shall not exceed the quantity listed for storage.
- c. The quantities of alcoholic beverages in retail and wholesale sales occupancies shall not be limited providing the liquids are packaged in individual containers not exceeding 1.3 gallons. In retail and wholesale sales occupancies, the quantities of medicines, foodstuffs, consumer or industrial products, and cosmetics containing not more than 50 percent by volume of water-miscible liquids with the remainder of the solutions not being flammable shall not be limited, provided that such materials are packaged in individual containers not exceeding 1.3 gallons.
- d. Maximum allowable quantities, except for liquefied petroleum gas and flammable liquid motor fuel, shall be increased 100 percent in buildings protected throughout by a sprinkler system. Where Note e also applies, the increase for both notes shall be applied cumulatively.
- e. Maximum allowable quantities, except for liquefied petroleum gas and flammable liquid motor fuel, shall be increased 100 percent when stored in approved storage cabinets, gas cabinets, exhausted enclosures or listed safety cans. Listed safety cans shall be in accordance with [Section 2705.1.10 of] the *New York City Fire Code*. Where Note d also applies, the increase for both notes shall be applied cumulatively.
- f. Quantities shall not be limited in a building protected throughout by a sprinkler system.
- g. Allowed only in buildings protected throughout by a sprinkler system.
- h. Containing not more than the maximum allowable quantity per control area of Class IA, Class IB or Class IC flammable liquids.
- i. [Stationary] The maximum allowable quantity shall not apply to fuel oil storage [tanks shall comply] that complies with the requirements of [the *New York City Construction Codes*, including] Section 1305 of the *New York City Mechanical Code*.
- j. Quantities shown in the table in parentheses have the units shown in parentheses at the head of the column.
- k. A maximum quantity of 200 pounds of solid or 20 gallons of liquid Class 3 oxidizers is allowed when such materials are necessary for maintenance, and operation of equipment when the storage containers and the manner of storage are approved.
- l. Reserved.
- m. For gallons of liquids, divide the amount in pounds by 10 in accordance with [Section 2703.1.2 of] the *New York City Fire Code*.
- n. For storage and display quantities in Group M and storage quantities in Group S occupancies complying with [the requirements of Section 2703.11 of the *New York City Fire Code*, see Table 2703.11.1 of] the *New York City Fire Code*.
- o. For purposes of this table, gasoline and other flammable liquid motor fuels are classified as a Class IA flammable liquid.
- p. Unclassified detonable organic peroxides [(see Chapter 39 of the *New York City Fire Code*)], detonable pyrophoric materials [(see Chapter 41 of the *New York City Fire Code*)], detonable unstable (reactive) materials [(see Chapter 43 of the *New York City Fire Code*)] and detonable water-reactive materials [(see Chapter 44 of the *New York City Fire Code*)] shall be treated as explosives for purposes of storage, handling and use [(see Chapter 33 of the *New York City Fire Code*)] in accordance with the *New York City Fire Code*.

- q. The maximum allowable quantities shall be limited by [Section 2706 of] the *New York City Fire Code* for non-production laboratories classified as Occupancy Group B.
 r. For storage of flammable and combustible liquids in Group M occupancy, see [Chapter 34 of] the *New York City Fire Code*.
 s. Densely-packed baled cotton that complies with the packing requirements of ISO 8115 shall not be included in this material class.

TABLE 307.1(2)
MAXIMUM ALLOWABLE QUANTITY PER CONTROL AREA OF HAZARDOUS MATERIAL
POSING A HEALTH HAZARD^{a,b,c,i,j}

MATERIAL	STORAGE ^d			USE-CLOSED SYSTEMS ^d			USE-OPEN SYSTEMS ^d	
	Solid pounds	Liquid gallons (pounds) ^e	Gas SCF ^e (pounds)	Solid pounds ^e	Liquid gallons (pounds) ^e	Gas SCF ^e (pounds)	Solid pounds ^e	Liquid gallons (pounds) ^e
Corrosive	5,000	500	Gaseous 810 ^f Liquefied (150) ^h	5,000	500	Gaseous 810 ^f Liquefied (150) ^h	1,000	100
Highly toxic	10	(10) ^h	Gaseous 20 ^g Liquefied (4) ^{g,h}	10	(10) ^h	Gaseous 20 ^g Liquefied (4) ^{g,h}	3	(3) ^h
Toxic	500	(500) ^h	Gaseous 810 ^f Liquefied (150) ^{f,h}	500	(500) ^h	Gaseous 810 ^f Liquefied (150) ^{f,h}	125	(125) ^h

For SI: 1 cubic foot = 0.028 m³, 1 pound = 0.454 kg, 1 gallon = 3.785 L.

- a. For use of control areas, see the *New York City Fire Code* and Section 414.2 of this code.
 b. In retail and wholesale sales occupancies, the quantities of medicines, foodstuffs, consumer or industrial products, and cosmetics, containing not more than 50 percent by volume of water-miscible liquids and with the remainder of the solutions not being flammable, shall not be limited, provided that such materials are packaged in individual containers not exceeding 1.3 gallons.
 c. For storage and display quantities in Group M and storage quantities in Group S occupancies complying with the *New York City Fire Code*.
 d. The aggregate quantity in storage, handling and use shall not exceed the quantity listed for storage.
 e. Maximum allowable quantities shall be increased 100 percent in buildings equipped throughout with an approved automatic sprinkler system in accordance with Section 903.3.1.1. Where Note f also applies, the increase for both notes shall be applied accumulatively.
 f. Maximum allowable quantities may be increased 100 percent when stored in approved storage cabinets, gas cabinets or exhausted enclosures as specified in the *New York City Fire Code*. Where Note e also applies, the increase for both notes shall be applied accumulatively.
 g. Allowed only when stored in approved exhausted gas cabinets or exhausted enclosures as specified in the *New York City Fire Code*.
 h. Quantities shown in the table in parenthesis [indicate quantity] have the units shown in parenthesis at the head of [each] the column.
 i. For gallons of liquids, divide the amount in pounds by 10 in accordance with the *New York City Fire Code*.
 j. The maximum allowable quantities shall be limited by Section [424] 427 for chemical laboratories classified as Occupancy Group B and operating as nonproduction facilities for testing, research, experimental, instructional or education purposes.

307.1.2 Hazardous materials. Hazardous materials in any quantity shall conform to the requirements of this code, including Section 414 of this code, and the *New York City Fire Code*.

307.2 Definitions. The following [words and] terms [shall, for the purposes of this section and as used elsewhere in this code, have the meanings shown herein.] are defined in Chapter 2:

[A product that is dispensed from an aerosol container by a propellant, classified as follows:]

Level 1. [Aerosol products with a total chemical heat of combustion that is greater than 0 and less than or equal to 8,600 British thermal units per pound (Btu/lb) (20 kJ/g).]

Level 2. [Aerosol products with a total chemical heat of combustion that is greater than 8,600 Btu/lb (20 kJ/g), but less than or equal to 13,000 Btu/lb (30 kJ/g).]

Level 3. [Aerosol products with a total chemical heat of combustion that is greater than 13,000 Btu/lb (30 kJ/g).]

BALED COTTON. [A natural seed fiber wrapped in and secured with industry accepted materials, typically consisting of burlap, woven polypropylene, polyethylene or cotton or sheet polyethylene, secured with wire or bands. The term baled cotton includes lint removed from the cottonseed (linters) and residual materials from the ginning process (motes).]

1 **BALED COTTON, DENSELY PACKED.** [~~Baled cotton with a packing density of at least 22~~
2 ~~pounds per cubic foot (360 kg/m³). A bale of densely packed baled cotton typically measures 55~~
3 ~~inches (1397 mm) in length, 21 inches (533.4 mm) in width, and 27.6 to 35.4 inches (701 to 899 mm)~~
4 ~~in height.~~]

5 **BARRICADE.** [~~A structure or other artificial or natural barrier constructed in connection with the~~
6 ~~storage, handling and use of explosives that is designed to withstand the rapid release of energy in~~
7 ~~an explosion and provides a shield from the impact of such explosion. A straight line from the top~~
8 ~~of any sidewall of a building containing explosives to the eaveline of any magazine or other building~~
9 ~~or to a point 12 feet (3658 mm) above the center of a railway or highway shall pass through such~~
10 ~~barrier.~~]

11 **Artificial barricade.** [~~An artificial mound or revetment, including a barrier constructed of~~
12 ~~sandbags, with a minimum thickness of 3 feet (914 mm).~~]

13 **Natural barricade.** [~~Terrain or other natural features of the ground.~~]

14 **BOILING POINT.** [~~The temperature at which the vapor pressure of a liquid equals the atmospheric~~
15 ~~pressure of 14.7 pounds per square inch (psi) (101 kPa) gage or 760 mm of mercury. Where an~~
16 ~~accurate boiling point is unavailable for the material in question, or for mixtures which do not have~~
17 ~~a constant boiling point, for the purposes of this classification, the 20 percent evaporated point of a~~
18 ~~distillation performed in accordance with ASTM D 86 shall be used as the boiling point of the liquid.~~]

19 **CLOSED SYSTEM.** [~~The use of any compressed gas and the use of a solid or liquid hazardous~~
20 ~~material in equipment or a vessel or system that remains closed during normal operations, such that~~
21 ~~vapors emitted during the operation of such equipment, vessel or system are not liberated outside of~~
22 ~~the equipment, vessel or system and the gas or hazardous material is not exposed to the atmosphere~~
23 ~~during such operation. Examples of closed systems include hazardous materials conveyed through a~~
24 ~~piping system into closed equipment or a closed vessel or system.~~]

25 **COMBUSTIBLE DUST.** [~~Finely divided solid material that is 420 microns or less in diameter, will~~
26 ~~pass through a U.S. standard No. 40 sieve and, when dispersed in air in insufficient concentrations,~~
27 ~~can be ignited by a flame, spark or other source of ignition.~~]

28 **COMBUSTIBLE FIBERS.** [~~Readily ignitable and free burning materials in fibrous or shredded~~
29 ~~form, such as cocoa fiber, cotton, excelsior, hay, hemp, henequen, istle, jute, kapok, oakum, sisal,~~
30 ~~Spanish moss, straw, tow, wastepaper or other natural or synthetic fibers that possess similar~~
31 ~~qualities, but excluding densely packed baled cotton.~~]

32 [~~**Exception:** Moss used for medicinal purposes.~~]

33 **COMBUSTIBLE LIQUID.** [~~For the purposes of transportation, a combustible liquid as defined in~~
34 ~~the regulations of the United States Department of Transportation, as set forth in 49 CFR 173.120.~~
35 ~~For all other purposes, a liquid, other than a compressed gas or cryogenic fluid, having a closed cup~~
36 ~~flash point at or above 100°F (38°C) classified as follows:~~]

37 **Class II.** [~~Liquids having a closed cup flash point at or above 100°F (38°C) and below 140°F~~
38 ~~(60°C).~~]

1 **Class IIIA.** [~~Liquids having a closed cup flash point at or above 140°F (60°C) and below 200°F~~
2 ~~(93°C).~~]

3 **Class IIIB.** [~~Liquids having a closed cup flash point at or above 200°F (93°C).~~]

4 **COMPRESSED GAS.** [~~A material, or mixture of materials which~~
5 ~~[1. Is a gas at 68°F (20°C) or less at 14.7 psia (101 kPa) of pressure; and]~~
6 ~~[2. Has a boiling point of 68°F (20°C) or less at 14.7 psia (101 kPa) that is either liquefied,~~
7 ~~nonliquefied or in solution at that temperature and pressure, except those gases which have~~
8 ~~no other health or physical hazard properties are not considered to be compressed until the~~
9 ~~pressure in the packaging exceeds 41 psia (28 kPa) at 68°F (20°C).]~~

10 ~~[The states of compressed gases are categorized as follows:]~~

11 ~~[**Nonliquefied compressed gases.** Gases, other than those in solution, which are in a packaging~~
12 ~~under the charged pressure and are entirely gaseous at a temperature of 68°F (20°C).]~~

13 ~~[**Liquefied compressed gases.** Gases that, in a packaging under the charged pressure, are~~
14 ~~partially liquid at a temperature of 68°F (20°C).]~~

15 ~~[**Compressed gases in solution.** Nonliquefied gases that are dissolved in a solvent.]~~

16 ~~[**Compressed gas mixtures.** A mixture of two or more compressed gases contained in a single~~
17 ~~packaging, the hazard properties of which are represented by the properties of the mixture as a~~
18 ~~whole.]~~

19 **CONTROL AREA.** [~~Spaces within a building where quantities of hazardous materials not~~
20 ~~exceeding the maximum allowable quantities per control area are stored, handled, or used, including~~
21 ~~any dispensing. See also definition of “Outdoor control area” in the *New York City Fire Code.*]~~

22 **CORROSIVE MATERIAL.** [~~A material that causes full thickness destruction of human skin at the~~
23 ~~site of contact within a specified period of time when tested by methods set forth in DOTn regulations~~
24 ~~49 CFR 173.136 and 173.137, or a liquid that has a severe corrosion rate on steel or aluminum based~~
25 ~~on the criteria set forth in DOTn regulations 49 CFR 173.173(c)(2).]~~

26 **CRYOGENIC FLUID.** [~~A liquid having a boiling point lower than 130°F (-89.9°C) at 14.7 pounds~~
27 ~~per square inch absolute (psia) (an absolute pressure of 101.3 kPa).]~~

28 **DAY BOX.** [~~A portable magazine designed to hold explosive materials constructed in accordance~~
29 ~~with the requirements for a Type 3 magazine as defined and classified in Chapter 33 of the *New*~~
30 ~~*York City Fire Code.*]~~

31 **DEFLAGRATION.** [~~An exothermic reaction, such as the extremely rapid oxidation of a flammable~~
32 ~~dust or vapor in air, in which the reaction progresses through the unburned material at a rate less~~
33 ~~than the velocity of sound. A deflagration can have an explosive effect.]~~

1 **DETONATION.** [~~An exothermic reaction with explosive effect that utilizes shock compression as~~
2 ~~the principal heating mechanism and generates a shock wave in the material that establishes and~~
3 ~~maintains a reaction that progresses through the material at a rate greater than the velocity of sound.~~]

4 **DISPENSING.** [~~The pouring or transferring by other means of any material from a container, tank~~
5 ~~or similar vessel, which would release dusts, fumes, mists, vapors, or gases to the atmosphere, unless~~
6 ~~such release is prevented by a device, equipment or system designed for that purpose.~~]

7 **EXPLOSION.** [~~An effect produced by the sudden violent expansion of gases, whether or not~~
8 ~~accompanied by a shock wave or disruption, of enclosing materials, including the effects of the~~
9 ~~following sources of explosion:~~]

10 [1. ~~Chemical changes such as rapid oxidation, deflagration or detonation, decomposition of~~
11 ~~molecules and runaway polymerization (usually detonations).~~]

12 [2. ~~Physical changes such as pressure tank ruptures.~~]

13 [3. ~~Atomic changes (nuclear fission or fusion).~~]

14 **EXPLOSIVE.** [~~Any chemical compound, mixture or device, the primary or common purpose of~~
15 ~~which is to function by explosion. The term includes, but is not limited to, dynamite, black powder,~~
16 ~~pellet powder, initiating explosives, detonators, safety fuses, squibs, detonating cord, igniter cord,~~
17 ~~and igniters.~~]

18 [~~The term “explosive” includes any material determined to be within the scope of *Chapter 40 of Title*~~
19 ~~*18 of the United States Code* and any material classified as an explosive by the hazardous materials~~
20 ~~regulations of the United States Department of Transportation, as set forth in 49 CFR 173.52, except~~
21 ~~fireworks. Explosives are classified in accordance with the following United States Department of~~
22 ~~Transportation classification and other terms in common usage.~~]

23 **High explosive.**

24 **Low explosive.**

25 **Mass-detonating explosives.**

26 **UN/DOTn Class 1 explosives.**

27 **Division 1.1.**[~~Explosives that have a mass explosion hazard.~~]

28 **Division 1.2.**[~~Explosives that have a projection hazard but not a mass explosion hazard.~~]

29 **Division 1.3.** [~~Explosives that have a fire hazard and either a minor blast hazard or a minor~~
30 ~~projection hazard or both, but not a mass explosion hazard.~~]

31 **Division 1.4.** [~~Explosives that pose a minor explosion hazard. The explosive effects are~~
32 ~~largely confined to the package and no projection of fragments of appreciable size or range~~
33 ~~is to be expected. Such explosives are not subject to mass explosion when exposed to fire.~~]

1 **Division 1.5.** [~~Explosives that present a mass explosion hazard, but which are so insensitive~~
2 ~~that there is very little probability of initiation or of transition from burning to detonation~~
3 ~~under normal conditions of transport.~~]

4 **Division 1.6.** [~~Explosives consisting of extremely insensitive articles that do not present a~~
5 ~~mass explosion hazard, and present a negligible probability of accidental initiation or~~
6 ~~propagation.~~]

7 [~~**High explosive.** Explosives, including dynamite, that, when detonated, are characterized by a~~
8 ~~high rate of reaction, high pressure development, and the presence of a detonation wave, and~~
9 ~~that can be caused to detonate by means of a No. 8 test blasting cap, when unconfined.~~]

10 [~~**Low explosive.** Explosives that will burn or deflagrate when ignited, and which are~~
11 ~~characterized by a rate of reaction that is less than the speed of sound, and low pressure~~
12 ~~development. Examples of low explosives include black powder, igniter cords, igniters, safety~~
13 ~~fuses, small arms ammunition and primers, and propellants, 1.3C.~~]

14 [~~**Mass-detonating explosives.** Division 1.1, 1.2 and 1.5 explosives that, whether individually~~
15 ~~or in combination, or loaded into ammunition or containers, explode virtually instantaneously~~
16 ~~when a small portion is subjected to fire, concussion, impact, the impulse of an initiating agent,~~
17 ~~or the effect of a considerable discharge of energy from without, with severe explosive effect,~~
18 ~~including the potential for structural damage to adjacent objects, and explosive propagation to~~
19 ~~other explosives stored in proximity, such that two or more quantities in proximity must be~~
20 ~~considered as one for quantity-distance purposes.~~]

21 **FIREWORKS.** [~~Any article or device that does not present a mass explosion hazard, that is~~
22 ~~manufactured or used to produce a visible or audible effect for entertainment or other display~~
23 ~~purposes by combustion, deflagration or detonation that meets the definition of 1.4G fireworks or~~
24 ~~1.3G fireworks as set forth herein.~~]

25 **Fireworks, 1.3G.**[~~Large fireworks devices, classified as UN0335 by the United States~~
26 ~~Department of Transportation regulations, intended for use in fireworks displays and designed~~
27 ~~to produce audible or visible effects by combustion, deflagration or detonation including~~
28 ~~firecrackers containing more than 130 milligrams (2 grains) of explosive composition, aerial~~
29 ~~shells containing more than 40 grams of pyrotechnic material, and other display pieces which~~
30 ~~exceed the limits for classification as 1.4G fireworks.~~]

31 **Fireworks, 1.4G.**[~~Small fireworks devices, classified as UN 0336 by United States Department~~
32 ~~of Transportation regulations, containing restricted amounts of pyrotechnic materials designed~~
33 ~~primarily to produce visible or audible effects by combustion.~~]

34 **FLAMMABLE GAS.** [~~A material which has a boiling point and becomes a gas at 68°F (20°C) or~~
35 ~~less at 14.7 pounds per square inch absolute (psia) (101 kPa) of pressure which:]~~

36 [~~1. Is ignitable at 14.7 psia (101 kPa) when in a mixture of 13 percent or less by volume with~~
37 ~~air, in accordance with testing procedures set forth in ASTM E 681; or]~~

1 ~~[2. Has a flammable range at 14.7 psia (101 kPa) with air of at least 12 percent, regardless of the~~
2 ~~lower explosive limit, in accordance with testing procedures set forth in ASTM E 681.]~~

3 ~~[The limits specified shall be determined at 14.7 psia (101 kPa) of pressure and a temperature of~~
4 ~~68°F (20°C) in accordance with ASTM E 681.]~~

5 **FLAMMABLE LIQUEFIED GAS.** ~~[A liquefied compressed gas which, under a charged pressure,~~
6 ~~is partially liquid at a temperature of 68°F (20°C) and which is flammable.]~~

7 **FLAMMABLE LIQUID.** ~~[For the purposes of transportation, a flammable liquid as defined in the~~
8 ~~regulations of the United States Department of Transportation, as set forth in 49 CFR 173.120. For~~
9 ~~all other purposes, a liquid, other than a compressed gas or cryogenic fluid, having a closed cup flash~~
10 ~~point below 100°F (38°C) classified as follows:]~~

11 **Class IA.** ~~[Liquids having a flash point below 73°F (23°C) and a boiling point below 100°F~~
12 ~~(38°C).]~~

13 **Class IB.** ~~[Liquids having a flash point below 73°F (23°C) and a boiling point at or above 100°F~~
14 ~~(38°C).]~~

15 **Class IC.** ~~[Liquids having a flash point at or above 73°F (23°C) and below 100°F (38°C)]~~

16 **FLAMMABLE MATERIAL.** ~~[A material capable of being readily ignited from common sources~~
17 ~~of heat or at a temperature of 600°F (316°C) or less.]~~

18 **FLAMMABLE SOLID.** ~~[A solid, other than a blasting agent or other explosive, whether in~~
19 ~~elemental or alloy form, that is capable of causing fire through friction, absorption or moisture,~~
20 ~~spontaneous chemical change, or heat retained from manufacturing or processing, or which has an~~
21 ~~ignition temperature below 212°F (100°C) or which burns so vigorously and persistently when~~
22 ~~ignited as to create a serious hazard. [A chemical shall be considered a flammable solid if upon~~
23 ~~testing using the method prescribed in CPSC regulations, as set forth in 16 CFR 1500.44, if it ignites~~
24 ~~and burns with a self-sustained flame at a rate greater than 0.1 inch (2.5 mm) per second along its~~
25 ~~major axis.]~~

26 **FLASH POINT.** ~~[The minimum temperature in degrees Fahrenheit at which a liquid will give off~~
27 ~~sufficient vapors to form an ignitable mixture with air near the surface or in the container, but will~~
28 ~~not sustain combustion. The flash point of a liquid shall be determined by appropriate test procedure~~
29 ~~and apparatus as specified in ASTM D 56, ASTM D 93 or ASTM D 3278.]~~

30 **HANDLING.** ~~[The movement of a material in its container, the removal of the material from its~~
31 ~~container, or any other action or process that may affect the material, other than its storage or use.]~~

32 **HAZARDOUS MATERIALS.** ~~[Those chemicals or substances that are physical hazards or health~~
33 ~~hazards as defined and classified in this section and the *New York City Fire Code*, whether the~~
34 ~~materials are in usable or waste condition.]~~

35 **HEALTH HAZARD.** ~~[A classification of a chemical for which there is statistically significant~~
36 ~~evidence that acute or chronic health effects are capable of occurring in exposed persons. The term~~
37 ~~“health hazard” includes chemicals that are toxic or highly toxic, and corrosive.]~~

1 **HIGHLY TOXIC MATERIAL.** [A chemical that is lethal at the following doses or concentrations:]

2 [1. A chemical that has a median lethal dose (LD₅₀) of 50 milligrams or less per kilogram of body
3 weight when administered orally to albino rats weighing between 200 and 300 grams each;
4 or]

5 [2. A chemical that has a median lethal dose (LD₅₀) of 200 milligrams or less per kilogram of
6 body weight when administered by continuous contact for 24 hours (or less if death occurs
7 within 24 hours) with the bare skin of albino rabbits weighing between 2 and 3 kilograms
8 each; or]

9 [3. A chemical that has a median lethal concentration (LC₅₀) in air of 200 parts per million by
10 volume or less of gas or vapor, or 2 milligrams per liter or less of mist, fume or dust, when
11 administered by continuous inhalation for 1 hour (or less if death occurs within 1 hour) to
12 albino rats weighing between 200 and 300 grams each.]

13 **INCOMPATIBLE MATERIALS.** [Materials that, if mixed or combined, could explode, generate
14 heat, gases or other byproducts, or react in such a way hazardous to life or property.]

15 **INERT GAS.** [A gas that is capable of reacting with other materials only under abnormal
16 conditions such as high temperatures, pressures and similar extrinsic physical forces. Within the
17 context of the code, inert gases do not exhibit either physical or health properties as defined (other
18 than acting as a simple asphyxiant) or hazard properties other than those of a compressed gas.
19 Some of the more common inert gases include argon, helium, krypton, neon, nitrogen and xenon.]

20 **OPEN SYSTEM.** [The use of a solid or liquid hazardous material in equipment or a vessel or system
21 that remains open during normal operation such that vapors are emitted during the operation of such
22 equipment, vessel or system and the material is exposed to the atmosphere during such operation.
23 Examples of open systems for solids and liquids include dispensing from or into open beakers or
24 containers, dip tank and plating tank operations.]

25 **ORGANIC PEROXIDE.** [An organic compound having a double oxygen or peroxy (-O-O-) in its
26 chemical structure. Organic peroxides can present an explosion hazard (detonation or deflagration),
27 can be shock sensitive, or can be susceptible to decomposition into various unstable compounds over
28 an extended period of time and are classified as follows based upon their hazardous properties:]

29 **Class I.** [Organic peroxides that are capable of deflagration but not detonation.]

30 **Class II.** [Organic peroxides that burn very rapidly and that pose a moderate reactivity hazard.]

31 **Class III.** [Organic peroxides that burn rapidly and that pose a moderate reactivity hazard.]

32 **Class IV.** [Organic peroxides that burn in the same manner as ordinary combustibles and that
33 pose a minimal reactivity hazard.]

34 **Class V.** [Organic peroxides that burn with less intensity than ordinary combustibles or do not
35 sustain combustion and that pose no reactivity hazard.]

1 **Unclassified detonable.**~~[Organic peroxides that are capable of detonation and pose an extremely~~
2 ~~high explosion hazard through rapid explosive decomposition.]~~

3 **OXIDIZER.** ~~[A material that readily yields oxygen or other oxidizing gas or that readily reacts to~~
4 ~~promote or initiate combustion of combustible materials, and if heated or contaminated can result in~~
5 ~~vigorous self-sustained decomposition, classified as follows:]~~

6 ~~[Class 1. An oxidizer that causes a readily measurable increase in the burning rate of combustible~~
7 ~~materials with which it comes in contact, but less than a moderate increase.]~~

8 ~~[Class 2. An oxidizer that causes a moderate increase in the burning rate of combustible materials~~
9 ~~with which it comes in contact.]~~

10 ~~[Class 3. An oxidizer that causes a severe increase in the burning rate of combustible materials~~
11 ~~with which it comes in contact.]~~

12 ~~[Class 4. An oxidizer that can undergo an explosive reaction due to contamination or exposure~~
13 ~~to thermal or physical shock and causes a severe increase in the burning rate of combustible~~
14 ~~materials with which it comes into contact.]~~

15 **Class 4.**

16 **Class 3.**

17 **Class 2.**

18 **Class 1.**

19 **OXIDIZING GAS.** ~~[A gas that can support and accelerate combustion of other materials more than~~
20 ~~air does.]~~

21 **PHYSICAL HAZARD.** ~~[A chemical for which there is evidence that it is a combustible liquid,~~
22 ~~compressed gas, cryogenic, explosive, flammable gas, flammable liquid, flammable solid, organic~~
23 ~~peroxide, oxidizer, pyrophoric or unstable (reactive) or water reactive material.]~~

24 **PYROPHORIC MATERIAL.** ~~[A material with an autoignition temperature in air, at or below a~~
25 ~~temperature of 130°F (54°C).]~~

26 **PYROTECHNIC MATERIAL.** ~~[A chemical mixture consisting predominantly of solids that,~~
27 ~~upon ignition, are capable of producing a controlled, self-sustaining, and self-contained exothermic~~
28 ~~reaction, that functions without external oxygen, resulting in a visible or audible effect by~~
29 ~~combustion, deflagration, or detonation.]~~

30 **STANDARD CUBIC FEET (SCF).** ~~[Cubic feet of gas at normal temperature and pressure (NTP).]~~

31 **TOXIC MATERIAL.** ~~[A chemical that is lethal at the following doses or concentrations:]~~

1 [1. A chemical that has a median lethal dose (LD₅₀) of more than 50 milligrams per kilogram, but
2 not more than 500 milligrams per kilogram of body weight when administered orally to albino
3 rats weighing between 200 and 300 grams each; or]

4 [2. A chemical that has a median lethal dose (LD₅₀) of more than 200 milligrams per kilogram
5 but not more than 1,000 milligrams per kilogram of body weight when administered by
6 continuous contact for 24 hours (or less if death occurs within 24 hours) with the bare skin of
7 albino rabbits weighing between 2 and 3 kilograms each; or]

8 [3. A chemical that has a median lethal concentration (LC₅₀) in air of more than 200 parts per
9 million but not more than 2,000 parts per million by volume of gas or vapor, or more than 2
10 milligrams per liter but not more than 20 milligrams per liter of mist, fume or dust, when
11 administered by continuous inhalation for 1 hour (or less if death occurs within 1 hour) to
12 albino rats weighing between 200 and 300 grams each.]

13 [**Exception:** For purposes of this code, chlorine shall be classified as a highly toxic material.]

14 **UNSTABLE (REACTIVE) MATERIAL.** [A material, other than an explosive, which in the pure
15 state or as commercially produced, will vigorously polymerize, decompose, condense or become
16 self-reactive and undergo other violent chemical changes, including explosion, when exposed to
17 heat, friction or shock, or in the absence of an inhibitor, or in the presence of contaminants, or in
18 contact with incompatible materials. Unstable (reactive) materials are shall be classified as follows:]

19 [**Class 1.** Materials that in themselves are normally stable but which can become unstable at
20 elevated temperatures and pressure.]

21 [**Class 2.** Materials that in themselves are normally unstable and readily undergo violent
22 chemical change but do not detonate. This class includes materials that can undergo chemical
23 change with rapid release of energy at normal temperatures and pressures, and that can undergo
24 violent chemical change at elevated temperatures and pressures.]

25 [**Class 3.** Materials that in themselves are capable of detonation or of explosive decomposition
26 or explosive reaction but which require a strong initiating source or which must be heated under
27 confinement before initiation. This class includes materials that are sensitive to thermal or
28 mechanical shock at elevated temperatures and pressures.]

29 [**Class 4.** Materials that in themselves are readily capable of detonation or explosive
30 decomposition or explosive reaction at normal temperatures and pressures. This class includes
31 materials that are sensitive to mechanical or localized thermal shock at normal temperatures and
32 pressures.]

33 **Class 4.**

34 **Class 3.**

35 **Class 2.**

36 **Class 1.**

1 **WATER-REACTIVE MATERIAL.** [~~A material that explodes; violently reacts; produces~~
2 ~~flammable, toxic or other hazardous gases; or generates enough heat to cause auto ignition or~~
3 ~~ignition of combustible materials upon exposure to water or moisture. Water reactive materials are~~
4 ~~classified as follows:]~~

5 [~~Class 1. Materials that may react with water with some release of energy, but not violently.]~~

6 [~~Class 2. Materials that react violently with water or cause water to boil upon contact; produce~~
7 ~~flammable, toxic or other hazardous gases upon contact with water; or upon contact with water~~
8 ~~generate sufficient heat to cause auto ignition of adjoining combustible materials.]~~

9 [~~Class 3. Materials that react explosively with water without requiring heat or confinement.]~~

10 **Class 3.**

11 **Class 2.**

12 **Class 1.**

13 **307.3 [~~High-Hazard] High-hazard Group H-1.~~** Buildings and structures containing materials that
14 [~~present] pose~~ a detonation hazard shall be classified as Group H-1. Such materials shall include, but
15 not be limited to, the following:

16 Detonable pyrophoric materials

17 Explosives:

18 Division 1.1

19 Division 1.2

20 Division 1.3

21 Division 1.4

22 Division 1.5

23 Division 1.6

24 Organic peroxides, unclassified detonable

25 Oxidizers, Class 4

26 Unstable (reactive) materials, Class 3 detonable and Class 4

27 [**Exception:** Materials]

28 **307.3.1 Occupancies containing explosives not classified as H-1.** The following occupancies
29 containing explosive materials shall be classified as follows:

30 1. Division 1.3 explosive materials that are used and maintained in a form where either
31 confinement or configuration will not elevate the hazard from a mass fire to mass
32 explosion hazard shall be allowed in H-2 occupancies.

1 ~~[Division 1.4]~~

2 **[Exception:]**

3 2. Articles, including articles packaged for shipment, that are not regulated as ~~[an]~~ a Division
4 1.4 explosive under Bureau of Alcohol, Tobacco ~~[and]~~, Firearms ~~[regulations]~~ and
5 Explosives regulations, or unpackaged articles used in process operations that do not
6 propagate a detonation or deflagration between articles shall be allowed in H-3
7 occupancies.

8 ~~[Division 1.5]~~

9 ~~[Division 1.6]~~

10 ~~[Organic peroxides, unclassified detonable]~~

11 ~~[Oxidizers, Class 4]~~

12 ~~[Unstable (reactive) materials, Class 3 detonable and Class 4]~~

13 ~~[Pyrophoric materials, detonable]~~

14 ~~[Water reactive materials, Class 2 and 3, detonable]~~

15 No part of this section shall be construed to authorize the manufacture, storage, sale or use of
16 explosives, including fireworks, if otherwise prohibited by the *New York City Fire Code* and unless
17 in compliance with the requirements of the *New York City Fire Code*.

18 **307.4 ~~[High-Hazard]~~ High-hazard Group H-2.** Buildings and structures containing materials that
19 ~~[present]~~ pose a deflagration hazard or a hazard from accelerated burning shall be classified as Group
20 H-2. Such materials shall include, but not be limited to, the following:

21 Class I, II or IIIA flammable or combustible liquids ~~[which]~~ that are used or stored in normally
22 open containers or systems, or in closed containers or systems pressurized at more than 15 ~~[psi~~
23 ~~(103.4 kPa) gage.]~~ pounds per square inch gauge (103.4 kPa)

24 Combustible dusts where manufactured, generated or used in such a manner that the concentration
25 and conditions create a fire or explosion hazard based on information prepared in accordance
26 with Section 414.1.3

27 Cryogenic fluids, flammable

28 Flammable gases

29 Organic peroxides, Class I

30 Oxidizers, Class 3, that are used or stored in normally open containers or systems, or in closed
31 containers or systems pressurized at more than 15 ~~[psi (103.3 kPa) gage.]~~ pounds per square
32 inch gauge (103 kPa)

33 Pyrophoric liquids, solids and gases, nondetonable

34 Unstable (reactive) materials, Class 3, nondetonable

1 Water-reactive materials, Class 3, nondetonable

2 No part of this section shall be construed to authorize an LPG-distribution facility if otherwise
3 prohibited by the *New York City Fire Code*.

4 **307.5 [~~High-Hazard~~ High-hazard Group H-3.** Buildings and structures containing materials that
5 readily support combustion or [~~present~~] that pose a physical hazard shall be classified as Group H-3.
6 Such materials shall include, but not be limited to, the following:

7 Class I, II or IIIA flammable or combustible liquids [~~which~~] that are used or stored in normally
8 closed containers or systems pressurized at [~~less than 15 psi (103.3 kPa) gage.~~] 15 pounds per
9 square inch gauge (103 kPa) or less

10 Combustible fibers, other than densely packed baled cotton, where manufactured, generated or
11 used in such a manner that the concentration and conditions create a fire or explosion hazard
12 based on information prepared in accordance with Section 414.1.3

13 Cryogenic fluids, oxidizing

14 Flammable solids

15 Organic peroxides, [~~Classes~~] Class II and III

16 Oxidizers, [~~Classes~~] Class 1 and 2

17 Oxidizing gases

18 Unstable (reactive) materials, Class 2

19 Water-reactive materials, Class 2, nondetonable

20 **307.6 [~~High-Hazard~~ High-hazard Group H-4.** Buildings and structures containing materials that
21 are health hazards shall be classified as Group H-4. Such materials shall include, but not be limited
22 to, the following:

23 Corrosives

24 Highly toxic materials

25 Toxic materials

26 **307.7 High-hazard Group H-5[structures].** Semiconductor fabrication facilities and comparable
27 research and development areas in which hazardous production materials (HPM) are used and the
28 aggregate quantity of materials is in excess of those listed in Tables 307.1(1) and 307.1(2) shall be
29 classified as Group H-5. Such facilities and areas shall be designed and constructed in accordance
30 with Section [~~415.8~~] 415.11.

31 **307.8 Multiple hazards.** Buildings and structures containing a material or materials representing
32 hazards that are classified in one or more of Groups H-1, H-2, H-3 and H-4 shall conform to the code
33 requirements for each of the occupancies so classified.

1 **SECTION BC 308**
2 **INSTITUTIONAL GROUP I**

3 **308.1 Institutional Group I.** Institutional Group I occupancy includes, among others, the use of a
4 building or structure, or a portion thereof, in which [~~people are cared for or live in a supervised~~
5 ~~environment, having physical limitations because of health or age are harbored for medical treatment~~
6 ~~or other care or treatment,~~] care or supervision is provided to persons who are or are not capable of
7 self-preservation without physical assistance or in which [~~people~~] persons are detained for penal or
8 correctional purposes or in which the liberty of the occupants is restricted. Institutional occupancies
9 shall be classified as Group I-1, I-2, I-3 or I-4.

10 [~~308.1.1~~] **308.2 Definitions.** [~~For definitions of terms related to Group I occupancy classification, see~~
11 ~~Section 310.2.~~] This section contains provisions for definitions of terms defined elsewhere in this
12 code as well as the terms with definitions specific to this section.

13 **308.2.1 Terms defined elsewhere in this code.** The following terms are defined in Chapter 2:

14 **24-HOUR BASIS.**

15 **CARE SUITE.**

16 **INCAPABLE OF SELF-PRESERVATION.**

17 **308.2.2 Definitions specific to this section.** The following words and terms shall, for the purposes
18 of this section, have the meanings shown herein:

19 **CHILD CARE FACILITIES.** Facilities that provide care on a 24-hour basis to more than 5
20 children, under the age of 2.

21 **DETOXIFICATION FACILITIES.** Facilities that serve patients who are provided treatment
22 for substance abuse on a 24-hour basis and who are incapable of self-preservation or who are
23 harmful to themselves or others.

24 **HOSPITALS AND PSYCHIATRIC CENTERS.** Buildings or portions thereof used on a 24-
25 hour basis for the medical, psychiatric, obstetrical or surgical treatment of inpatients who are
26 incapable of self-preservation.

27 **NURSING HOMES.** Nursing homes are long-term care facilities on a 24-hour basis, including
28 both intermediate care facilities and skilled nursing facilities, serving more than five persons and
29 any of the persons are incapable of self-preservation.

30 [~~308.2~~] **308.3 Institutional Group I-1.** [~~This~~] Institutional Group I-1 occupancy shall include
31 buildings, structures or parts thereof housing persons, on a 24-hour basis, who because of age, mental
32 disability or other reasons, live in a supervised residential environment that provides personal care
33 services. The occupants are capable of self-preservation and capable of responding to an emergency
34 situation without physical assistance from staff. Such occupancy shall be subject to the *New York*
35 *State Multiple Dwelling Law*. This group shall include, but not be limited to, the following:

36 Adult homes, where occupants are capable of self-preservation (see Section [~~308.2.1~~] 308.3.1)

- 1 Alcohol and drug abuse rehabilitation centers
- 2 Assisted living facilities
- 3 Community residences or intermediate-care facilities (see Section [~~308.2.2~~] 308.3.2)
- 4 Congregate care facilities
- 5 Convalescent facilities
- 6 Enriched housing, where occupants are capable of self-preservation (see Section [~~308.2.1~~]
- 7 308.3.1)
- 8 Halfway houses
- 9 Overnight facilities for children where all supervised occupants are under the age of 18, with no
- 10 more than two children under the age of 2
- 11 Residential care facilities
- 12 Social rehabilitation facilities

13 [~~308.2.1~~] **308.3.1 Adult homes and enriched housing.** Adult homes and enriched housing
 14 facilities operated pursuant to and meeting the additional construction requirements of Section
 15 460 of the *New York State Social Services Law* and regulations of the New York State
 16 Department of Health offering care on a 24-hour basis to persons capable of self-preservation,
 17 in the same building, shall be classified as Group I-1.

18 **Exception:** Such a facility offering supervised care on a 24-hour basis for no more than 16
 19 occupants capable of self-preservation, in the same building, may be classified in Group R
 20 in accordance with Section 310.

21 [~~308.2.2~~] **308.3.2 Community residences or intermediate-care facilities.** Community
 22 residences or intermediate-care facilities, operated pursuant to and meeting the additional
 23 construction requirements of the *New York State Mental Hygiene Law* and applicable regulations
 24 of the New York State Office of Mental Health and Office for People with Developmental
 25 Disabilities shall be classified as Group I-1.

26 **Exceptions:** Such facilities limited to 14 residents capable of self-preservation and three staff
 27 members per dwelling unit shall be classified as:

- 28 1. Group R-1, where such facility does not occupy more than two dwelling units in a
- 29 residential building classified as R-1 of Type I or II construction, or one dwelling unit
- 30 in any other type of construction, and occupied on a transient basis; or
- 31 2. Group R-2 where such facility does not occupy more than two dwelling units in a
- 32 residential building classified R-2 of Type I or II construction, or one dwelling unit
- 33 in any other type of construction, and occupied on a long-term basis; or

3. Group R-3 where the number of dwelling units in the building does not exceed two.

~~[308.3]~~ **308.4 Institutional Group I-2.** ~~[This occupancy]~~ Institutional Group I-2 shall include buildings and structures used for medical, surgical, psychiatric, nursing or personal care on a 24-hour basis or overnight of more than two children under the age of 2, or more than three persons who are not capable of self-preservation and not capable of responding to an emergency situation without physical assistance from staff. This group shall include, but not be limited to, the following:

~~Adult homes, where occupants are not capable of self-preservation[, operated pursuant to and meeting the additional construction requirements of Section 460 of the *New York State Social Services Law* and regulations of the New York State Department of Health] (see Section 308.4.1)~~

Child care facilities

Community residences or intermediate-care facilities, where occupants are not capable of self-preservation, operated pursuant to and meeting the additional construction requirements of the *New York State Mental Hygiene Law* and applicable regulations of the New York State Office of Mental Health and Office for People with Developmental Disabilities

Detoxification facilities

Exception: Such a facility offering care on a 24-hour basis for three or fewer persons who are not capable of self-preservation may occupy not more than one dwelling unit in a Group R occupancy.

~~Enriched Housing, where occupants are not capable of self-preservation[, operated pursuant to and meeting the additional construction requirements of Section 460 of the *New York State Social Services Law* and regulations of the New York State Department of Health] (see Section 308.4.1)~~

Hospitals

Nursing homes

~~[Mental hospitals]~~ Psychiatric centers where patients are not under restraint

~~[Detoxification facilities]~~

~~[**Exception:** Such a facility offering care on a 24-hour basis for three or fewer persons who are not capable of self-preservation may occupy not more than one dwelling unit in a Group R occupancy.]~~

308.4.1 Adult homes and enriched housing. Adult homes and enriched housing facilities operated pursuant to and meeting the additional construction requirements of Section 460 of the *New York State Social Services Law* and regulations of the New York State Department of Health offering care on a 24-hour basis to persons not capable of self-preservation, in the same building, shall be classified as Group I-2.

1 ~~[308.3.1 Definitions. The following words and terms shall, for the purposes of this section and as~~
2 ~~used elsewhere in this code, have the meanings shown herein.]~~

3 ~~[CHILD CARE FACILITIES. Facilities that provide care on a 24-hour basis to more than five~~
4 ~~children, under the age of 2.]~~

5 ~~[DETOXIFICATION FACILITIES. Facilities that serve patients who are provided treatment~~
6 ~~for substance abuse on a 24-hour basis and who are incapable of self-preservation or who are~~
7 ~~harmful to themselves or others.]~~

8 ~~[HOSPITALS AND MENTAL HOSPITALS. Buildings or portions thereof used on a 24-hour~~
9 ~~basis for the medical, psychiatric, obstetrical or surgical treatment of inpatients who are incapable~~
10 ~~of self-preservation.]~~

11 ~~[NURSING HOMES. Nursing homes are long-term care facilities on a 24-hour basis, including~~
12 ~~both intermediate care facilities and skilled nursing facilities, serving more than five persons and~~
13 ~~any of the persons are incapable of self-preservation.]~~

14 ~~[308.4]~~ **308.5 Institutional Group I-3.** ~~[This]~~ Institutional Group I-3 occupancy shall include
15 buildings and structures that are inhabited by more than five persons who are under restraint or
16 security. ~~[A]~~ A Group I-3 facility is occupied by persons who are generally incapable of self-
17 preservation due to security measures not under the occupants' control. This group shall include, but
18 not be limited to, the following:

19 Correctional centers

20 Detention centers

21 Jails

22 ~~[Mental hospitals]~~ Psychiatric centers where patients are under restraint

23 Prerelease centers

24 Prisons

25 Reformatories

26 Buildings of Group I-3 shall be classified as one of the occupancy conditions ~~[indicated]~~ specified
27 ~~in Section 408.1]~~ Sections 308.5.1 through 308.5.5.

28 **308.5.1 Condition 1.** This occupancy condition shall include buildings in which free movement
29 is allowed from sleeping areas, and other spaces where access or occupancy is permitted, to the
30 exterior via means of egress without restraint. A Condition 1 facility is permitted to be constructed
31 as Group R.

32 **308.5.2 Condition 2.** This occupancy condition shall include buildings in which free movement
33 is allowed from sleeping areas and any other occupied smoke compartment to one or more other
34 smoke compartments. Egress to the exterior is impeded by locked exits.

1 **308.5.3 Condition 3.** This occupancy condition shall include buildings in which free movement
2 is allowed within individual smoke compartments, such as within a residential unit comprised of
3 individual sleeping units and group activity spaces, where egress is impeded by remote controlled
4 release of means of egress from such a smoke compartment to another smoke compartment.

5 **308.5.4 Condition 4.** This occupancy condition shall include buildings in which free movement
6 is restricted from an occupied space. Remote-controlled release is provided to permit movement
7 from sleeping units, activity spaces and other occupied areas within the smoke compartment to
8 other smoke compartments.

9 **308.5.5 Condition 5.** This occupancy condition shall include buildings in which free movement
10 is restricted from an occupied space. Staff-controlled manual release is provided to permit
11 movement from sleeping units, activity spaces and other occupied areas within the smoke
12 compartment to other smoke compartments.

13 [~~308.5~~] **308.6 Institutional Group I-4.** [~~This group~~] Institutional Group I-4 occupancy shall include
14 custodial care facilities providing care to more than two children under the age of 2, or to more than
15 four persons over the age of 2 who are not capable of responding to an emergency situation without
16 physical assistance from the staff. Such occupancy shall include, but not be limited to, adult custodial
17 care facilities and day nurseries.

18 **Exceptions:**

- 19 1. Custodial care facility as described in Section 303.
- 20 2. Custodial care facility as described in Section 304.
- 21 3. Custodial care facility as described in Exception 3 of Section 305.1.
- 22 4. Such facility providing care within a dwelling unit as described in Section 310.
- 23 5. Such facility providing care to children under the age of 2 in religious houses of worship
- 24 during religious functions.

25 **SECTION BC 309**
26 **MERCANTILE GROUP M**

27 **309.1 Mercantile Group M.** Mercantile Group M occupancy includes, among others, the use of a
28 building or structure or a portion thereof[;] for the display and sale of merchandise, and involves
29 stocks of goods, wares or merchandise incidental to such purposes and accessible to the public.
30 Mercantile occupancies shall include, but not be limited to, the following:

- 31 Department stores
- 32 Drug stores
- 33 Markets
- 34 Motor fuel-dispensing facilities

1 Retail or wholesale stores

2 Sales rooms

3 **309.2 Quantity of hazardous materials.** The aggregate quantity of nonflammable solid and
4 nonflammable or noncombustible liquid hazardous materials stored or displayed in a single control
5 area of a Group M occupancy shall not exceed the quantities in Table 414.2.5(1).

6 **SECTION BC 310**
7 **RESIDENTIAL GROUP R**

8 **310.1 Residential Group R.** Residential Group R includes, among others, the use of a building or
9 structure, or a portion thereof, for dwelling or sleeping purposes when not classified as an Institutional
10 Group I. Buildings containing three or more dwelling units shall be subject to the *New York State*
11 *Multiple Dwelling Law*. Residential occupancies shall be classified as Group R-1, R-2, or R-3.

12 [~~310.1.1 Group R-1. This occupancy shall include:~~]

13 [~~1. Residential buildings or spaces occupied, as a rule, transiently, for a period less than one~~
14 ~~month, as the more or less temporary abode of individuals or families who are lodged~~
15 ~~with or without meals, including, but not limited to, the following:~~]

16 [~~Class B multiple dwellings as defined in Section 27-2004 of the *New York City*~~
17 ~~*Housing Maintenance Code* and Section 4 of the *New York State Multiple Dwelling*~~
18 ~~*Law*, where not classified in Group I-1.]~~

19 [~~Club houses~~]

20 [~~Hotels (transient)~~]

21 [~~Motels (transient)~~]

22 [~~Rooming houses (boarding houses — transient)~~]

23 [~~Settlement houses~~]

24 [~~Vacation timeshares~~]

25 [~~2. College or school student dormitories, except for student apartments classified as an R-~~
26 ~~2-occupancy]~~

27 [~~3. Congregate living units owned and operated by a government agency or not for profit~~
28 ~~organization, where the number of occupants in the dwelling unit exceeds the limitations~~
29 ~~of a family as defined, including, but not limited to, the following:~~]

30 [~~Adult homes or enriched housing with 16 or fewer occupants requiring supervised~~
31 ~~care within the same building on a 24-hour basis]~~

32 [~~Fraternity and sorority houses~~]

1 [Homeless shelters]

2 ~~[310.1.2 Group R-2. This occupancy shall include buildings or portions thereof containing~~
3 ~~sleeping units or more than two dwelling units that are occupied for permanent resident purposes~~
4 ~~as defined in subparagraph (a) of paragraph eight of subdivision a of Section 27-2004 of the New~~
5 ~~York City Housing Maintenance Code. Such occupancy shall be subject to the New York State~~
6 ~~Multiple Dwelling Law. This group shall include, but not be limited to, the following:]~~

7 [Adult homes or enriched housing with 16 or fewer occupants requiring supervised care on
8 a 24-hour basis in the same building, provided that the number of occupants per dwelling
9 unit does not exceed the definition of a family]

10 [Apartment houses]

11 [Apartment hotels (nontransient)]

12 [Class A multiple dwellings as defined in Section 27-2004 of the New York City Housing
13 Maintenance Code and Section 4 of the New York State Multiple Dwelling Law, where not
14 classified in Group I-1:]

15 [1. Dwelling units where the resident of the unit provides custodial care to no more than
16 four persons on less than a 24-hour basis and not overnight, where not classified in
17 Group I-1.]

18 [2. Dwelling units where the resident of the unit provides child custodial care as a family
19 day care home registered with the New York City Department of Health and Mental
20 Hygiene in accordance with the New York State Social Services Law with no more
21 than six children between the ages of 2 and 13, or with no more than five children if
22 any are under the age of 2, receiving supervised care on less than a 24-hour basis and
23 not overnight, where not classified in Group I-1.]

24 [Convents and monasteries with more than 20 occupants in the building]

25 [Student apartments]

26 ~~[310.1.3 Group R-3. This occupancy shall include buildings or portions thereof containing no~~
27 ~~more than 2 dwelling units, occupied, as a rule, for shelter and sleeping accommodation on a~~
28 ~~long-term basis for a month or more at a time, and are not classified in Group R-1, R-2 or I. This~~
29 ~~group shall include, but not be limited to, the following:]~~

30 [Convents and monasteries with fewer than 20 occupants in the building]

31 [Group homes]

32 [One and two family dwellings, including the following:]

33 [1. Dwelling units where the resident of the unit provides custodial care to no more than
34 four persons on less than a 24-hour basis and not overnight.]

1 ~~[2. Dwelling units where the resident of the unit provides child custodial care as a family~~
2 ~~day care home registered with the New York City Department of Health and Mental~~
3 ~~Hygiene in accordance with the New York State Social Services Law with no more~~
4 ~~than six children between the ages of 2 and 13, or with no more than five children if~~
5 ~~any are under the age of 2, receiving supervised care on less than a 24-hour basis and~~
6 ~~not overnight.]~~

7 **310.2 Definitions.** The following ~~[words and]~~ terms ~~[shall, for the purposes of this section and as~~
8 ~~used elsewhere in this code, have the meanings shown herein.]~~ are defined in Chapter 2:

9 **APARTMENT.** ~~[A dwelling unit providing permanent provisions for both sanitation and kitchen~~
10 ~~facilities, occupied or arranged to be occupied by not more than one family maintaining a common~~
11 ~~household.]~~

12 **APARTMENT, STUDENT.**~~[An apartment occupied or arranged to be occupied by students~~
13 ~~enrolled at a single accredited college or university and maintaining a common household pursuant~~
14 ~~to a lease, sublease, or occupancy agreement directly with such college or university.]~~

15 **BOARDER (ROOMER, LODGER).**~~[A person who pays a consideration for living within the~~
16 ~~household and does not occupy such space as an incident of employment.]~~

17 **CONGREGATE LIVING UNIT.** ~~[A dwelling unit, comprised of one or more habitable rooms~~
18 ~~separated by nonrated partitions, occupied or arranged to be occupied by more than one family or~~
19 ~~by persons who are not maintaining a common household. Creation of or conversion to such unit~~
20 ~~shall be subject to Section 27-2077 of the *New York City Housing Maintenance Code*.]~~

21 **CUSTODIAL CARE FACILITY.** ~~[A building or part thereof occupied by persons, on less than a~~
22 ~~24-hour basis and not overnight, who because of age, disability or other reasons, receive personal~~
23 ~~care services by individuals other than parents or guardians, relatives by blood, marriage, domestic~~
24 ~~partnership, or adoption, in a place other than the home of the person cared for.]~~

25 **DWELLING.** ~~[A building or structure which is occupied in whole or in part as the home, residence~~
26 ~~or sleeping place of one or more families.]~~

27 **DWELLING, MULTIPLE.** ~~[A dwelling which is either rented, leased, let or hired out, to be~~
28 ~~occupied, or is occupied, as the residence or home of three or more families living independently of~~
29 ~~each other. A multiple dwelling does not include a building used for occupancies in Groups I-2, I-3~~
30 ~~or I-4.]~~

31 **DWELLING, ONE-FAMILY.** ~~[Any building or structure designed and occupied exclusively for~~
32 ~~residence purposes on a long-term basis for more than a month at a time by not more than one family.~~
33 ~~One-family dwellings shall also be deemed to include a dwelling located in a series of one-family~~
34 ~~dwellings each of which faces or is accessible to a legal street or public thoroughfare, provided that~~
35 ~~each such dwelling unit is equipped as a separate dwelling unit with all essential services, and also~~
36 ~~provided that each such unit is arranged so that it may be approved as a legal one-family dwelling.]~~

37 **DWELLING, TWO-FAMILY.** ~~[Any building or structure designed and occupied exclusively for~~
38 ~~residence purposes on a long-term basis for more than a month at a time by not more than two~~

1 families. Two family dwellings shall also be deemed to include a dwelling located in a series of two-
2 family dwellings each of which faces or is accessible to a legal street or public thoroughfare,
3 provided that each such dwelling is equipped as a separate dwelling with all essential services, and
4 also provided that each such dwelling is arranged so that it may be approved as a legal two-family
5 dwelling.]

6 **DWELLING UNIT.** [~~A single unit consisting of one or more habitable rooms and occupied or~~
7 ~~arranged to be occupied as a unit separate from all other units within a dwelling.~~]

8 **FAMILY.**

9 [1. ~~A single person occupying a dwelling unit and maintaining a common household with not~~
10 ~~more than two boarders, roomers or lodgers; or]~~

11 [2. ~~Two or more persons related by blood, adoption, legal guardianship, marriage or domestic~~
12 ~~partnership; occupying a dwelling unit and maintaining a common household with not more~~
13 ~~than two boarders, roomers or lodgers; or]~~

14 [3. ~~Not more than three unrelated persons occupying a dwelling unit and maintaining a common~~
15 ~~household; or]~~

16 [4. ~~Not more than three unrelated persons occupying a dwelling unit in a congregate housing or~~
17 ~~shared living arrangement and maintaining a common household; or]~~

18 [5. ~~Members of a group home; or]~~

19 [6. ~~Foster children placed in accordance with provisions of the *New York State Social Services*~~
20 ~~*Law*, their foster parent(s), and other persons related to the foster parents by blood, marriage~~
21 ~~or domestic partnership; where all residents occupy and maintain a common household with~~
22 ~~not more than two boarders, roomers or lodgers; or]~~

23 [7. ~~Up to seven unrelated students enrolled at a single accredited college or university occupying~~
24 ~~a student apartment and maintaining a common household pursuant to a lease, sublease, or~~
25 ~~occupancy agreement directly with such college or university, provided that:]~~

26 [7.1. ~~The entire structure in which the dwelling unit is located is fully sprinklered in~~
27 ~~accordance with Chapter 9; and]~~

28 [7.2. ~~Such occupancy does not exceed the maximums contained in Section 27-2075(a) of the~~
29 ~~*New York City Housing Maintenance Code*; and]~~

30 [7.3. ~~Prior to commencement of such occupancy, and on an annual basis thereafter such~~
31 ~~college or university has submitted a fire safety plan containing fire safety and~~
32 ~~evacuation procedures for such dwelling unit that is acceptable to the fire commissioner~~
33 ~~and in compliance with any rules promulgated by the Fire Commissioner; and]~~

34 [7.4. ~~The dwelling unit complies with additional occupancy and construction requirements~~
35 ~~as may be established by rule by the Housing Preservation and Development~~
36 ~~Commissioner.]~~

1 ~~[A common household is deemed to exist if all household members have access to all parts of the~~
2 ~~dwelling unit. Lack of access to all parts of the dwelling unit establishes a rebuttable presumption~~
3 ~~that no common household exists.]~~

4 **GROUP HOME.** ~~[A facility for the care and maintenance of not fewer than seven nor more than 12~~
5 ~~children, supervised by the New York State Board of Social Welfare, and operated pursuant to and~~
6 ~~meeting any additional construction requirements of Section 374-C of the *New York State Social*~~
7 ~~*Services Law* and applicable regulations of the New York State Department of Social Services. Such~~
8 ~~a facility occupied by more than 12 children shall be classified as Group I-1.]~~

9 **PERSONAL CARE SERVICE.** ~~[The care of residents who do not require chronic or convalescent~~
10 ~~medical or nursing care. Personal care involves responsibility for the safety of the resident while~~
11 ~~inside the building.]~~

12 **RESIDENTIAL CARE/ASSISTED LIVING FACILITIES.** ~~[A building or part thereof housing~~
13 ~~persons, on a 24 hour basis, who because of age, mental disability or other reasons, live in a~~
14 ~~supervised residential environment which provides personal care services. The occupants are capable~~
15 ~~of self-preservation and are capable of responding to an emergency situation without physical~~
16 ~~assistance from staff. This classification shall include, but not be limited to, the following: residential~~
17 ~~board and care facilities, assisted living facilities, halfway houses, congregate care facilities, social~~
18 ~~rehabilitation facilities, alcohol and drug abuse rehabilitation centers and convalescent facilities.]~~

19 **ROOMING HOUSE.** ~~[A dwelling (i) which was originally erected as a single or two family private~~
20 ~~dwelling pursuant to the *New York City Building Code* in effect prior to December 6, 1968, (ii) which~~
21 ~~is a “Class B converted dwelling” as such term is defined in the *New York City Housing Maintenance*~~
22 ~~*Code*, and (iii) which has more than half of its habitable rooms as sleeping units. The creation of or~~
23 ~~conversion to a rooming house shall be limited by Section 27-2077 of the *New York City Housing*~~
24 ~~*Maintenance Code*.]~~

25 **SLEEPING UNIT.** ~~[A dwelling unit, which may contain either toilet or kitchen facilities but not~~
26 ~~both. Any sleeping unit housing more than one family shall also be classified as a congregate living~~
27 ~~unit. The creation of or conversion to sleeping units shall be limited by Section 27-2077 of the *New*~~
28 ~~*York City Housing Maintenance Code*.]~~

29 **TRANSIENT.** ~~[Occupancy of a dwelling unit or sleeping unit for not more than 30 days.]~~

30 **310.3 Residential Group R-1.** Residential Group R-1 occupancies shall include:

- 31 1. Residential buildings or spaces occupied, as a rule, transiently, for a period less than one
32 month, as the more or less temporary abode of individuals or families who are lodged with
33 or without meals, including, but not limited to, the following:

34 Class B multiple dwellings as defined in Section 27-2004 of the *New York City Housing*
35 *Maintenance Code* and Section 4 of the *New York State Multiple Dwelling Law*, where
36 not classified in Group I-1.

37 Club houses

1 Hotels (transient)

2 Motels (transient)

3 Rooming houses (boarding houses—transient)

4 Settlement houses

5 Vacation timeshares

6 2. College or school student dormitories, except for student apartments classified as an R-2
7 occupancy

8 3. Congregate living units owned and operated by a government agency or not-for-profit
9 organization, where the number of occupants in the dwelling unit exceeds the limitations of
10 a family as defined, including, but not limited to, the following:

11 Adult homes or enriched housing with 16 or fewer occupants requiring supervised care within
12 the same building on a 24-hour basis

13 Fraternity and sorority houses

14 Homeless shelters

15 **310.4 Residential Group R-2.** Residential Group R-2 occupancies shall include buildings or portions
16 thereof containing sleeping units or more than two dwelling units that are occupied for permanent
17 resident purposes as defined in subparagraph (a) of paragraph 8 of subdivision a of Section 27-2004
18 of the *New York City Housing Maintenance Code*. Such occupancy shall be subject to the *New York*
19 *State Multiple Dwelling Law*. This group shall include, but not be limited to, the following:

20 Adult homes or enriched housing with 16 or fewer occupants requiring supervised care on a 24-
21 hour basis in the same building, provided that the number of occupants per dwelling unit
22 does not exceed the definition of a family

23 Apartment houses

24 Apartment hotels (nontransient)

25 Class A multiple dwellings as defined in Section 27-2004 of the *New York City Housing*
26 *Maintenance Code* and Section 4 of the *New York State Multiple Dwelling Law*, where not
27 classified in Group I, including the following:

28 1. Dwelling units where the resident of the unit provides custodial care to no more than four
29 persons on less than a 24-hour basis and not overnight, where not classified in Group I.

30 2. Dwelling units where the resident of the unit provides child custodial care as a family day
31 care home registered with the New York City Department of Health and Mental Hygiene
32 in accordance with the *New York State Social Services Law*, with no more than six
33 children between the ages of 2 and 13, or with no more than five children if any are under

1 the age of 2, receiving supervised care on less than a 24-hour basis and not overnight,
2 where not classified in Group I.

3 Convents and monasteries with more than 20 occupants in the building

4 Student apartments

5 **310.5 Residential Group R-3.** Residential Group R-3 occupancies shall include buildings or portions
6 thereof containing no more than 2 dwelling units, occupied, as a rule, for shelter and sleeping
7 accommodation on a long-term basis for a month or more at a time, and are not classified in Group
8 R-1, R-2 or I. This group shall include, but not be limited to, the following:

9 Convents and monasteries with 20 or fewer occupants in the building

10 Group homes

11 One- and two-family dwellings, including the following:

- 12 1. Dwelling units where the resident of the unit provides custodial care to no more than
13 four persons on less than a 24-hour basis and not overnight.
- 14 2. Dwelling units where the resident of the unit provides child custodial care as a family
15 day care home registered with the New York City Department of Health and Mental
16 Hygiene in accordance with the *New York State Social Services Law* for three to six
17 children for more than three hours per day per child but less than 24 hours per day. A
18 family day care provider may, however, care for seven or eight children at any one
19 time if no more than six of the children are less than school age and such children
20 receive services only during the periods set forth in the *New York State Social Services*
21 *Law*.
- 22 3. Dwelling units where the resident of the unit provides child custodial care as a group
23 family day care home registered with the New York City Department of Health and
24 Mental Hygiene in accordance with the *New York State Social Services Law* for seven
25 to 12 children of all ages for more than three hours a day per child but less than 24
26 hours per day. There may be an additional four children if such children are of school
27 age and such children receive services only during the periods set forth in the *New*
28 *York State Social Services Law*.

29 **SECTION BC 311**
30 **STORAGE GROUP S**

31 **311.1 Storage Group S.** Storage Group S occupancy includes, among others, the use of a building
32 or structure, or a portion thereof, for storage, such as for warehouses, storage rooms, freight depots
33 and distribution centers, when not classified as a hazardous occupancy.

34 **311.1.1 Accessory storage spaces.** A room or space used for storage purposes that is less than
35 100 square feet (9.3 m²) in area and accessory to another occupancy shall be classified as part of
36 that occupancy. The aggregate area of such rooms or spaces shall not exceed the allowable area
37 limits of Section 508.2.3.

38 **311.2 Moderate-hazard storage, Group S-1.**~~[Buildings]~~ Storage Group S-1 occupancies are
39 buildings occupied for storing any flammable or combustible materials that are likely to permit the

- 1 development and production of fire with moderate rapidity including, but not limited to, storage of
2 the following:
- 3 Aerosols, Levels 2 and 3
 - 4 Aircraft hangar (storage and repair)
 - 5 Bags; cloth, burlap and paper
 - 6 Bamboos and rattan
 - 7 Baskets
 - 8 Belting; canvas and leather
 - 9 Books and paper in rolls or packs
 - 10 Boots and shoes
 - 11 Buttons, including cloth covered, pearl or bone
 - 12 Cardboard and cardboard boxes
 - 13 Clothing, woolen wearing apparel
 - 14 Cordage
 - 15 Dry boat storage (indoor, not accessory to Group R)
 - 16 Furniture
 - 17 Furs
 - 18 Glues, mucilage, pastes and size
 - 19 Grains
 - 20 Horns and combs, other than celluloid
 - 21 Leather
 - 22 Linoleum
 - 23 Lumber
 - 24 Photo engravings
 - 25 Resilient flooring
 - 26 Silks
 - 27 Soaps
 - 28 Sugar
 - 29 Tires, bulk storage of
 - 30 Tobacco, cigars, cigarettes and snuff
 - 31 Upholstery and mattresses
 - 32 Wax candles

1 **311.3 Low-hazard storage, Group S-2.** [~~Includes~~] Storage Group S-2 occupancies include, among
2 others, buildings used for the storage of noncombustible materials such as products on wood pallets
3 or in paper cartons with or without single thickness divisions; or in paper wrappings. Such products
4 are permitted to have a negligible amount of plastic trim, such as knobs, handles or film wrapping.
5 Group S-2 storage uses shall include, but not be limited to, storage of the following:

6 Asbestos

7 Beverages up to and including [~~16 percent~~] 16-percent alcohol in metal, glass or ceramic
8 containers

9 Cement in bags

10 Chalk and crayons

11 Dairy products in nonwaxed coated paper containers

12 Dry cell batteries

13 Electrical coils

14 Electrical motors

15 Empty cans

16 Food products

17 Foods in noncombustible containers

18 Fresh fruits and vegetables in nonplastic trays or containers

19 Frozen foods

20 Glass

21 Glass bottles, empty or filled with noncombustible liquids

22 Gypsum board

23 Inert pigments

24 Ivory

25 Meats

26 Metal cabinets

27 Metal desks with plastic tops and trim

28 Metal parts

29 Metals

30 Mirrors

31 Oil-filled and other types of distribution transformers

32 Parking garages, open or enclosed

33 Porcelain and pottery

34 Stoves

1 Talc and soapstones
2 Washers and dryers

3 **SECTION BC 312**
4 **UTILITY AND MISCELLANEOUS GROUP U**

5 **312.1 General.** Buildings and structures of an accessory character and miscellaneous structures not
6 classified in any specific occupancy shall be constructed, equipped and maintained to conform to the
7 requirements of this code commensurate with the fire and life hazard incidental to their occupancy.
8 Group U shall include, but not be limited to, the following:

9 Carports

10 Fences more than 6 feet (1829 mm) [~~high~~] in height

11 Private garages as per Section 406.1

12 Retaining walls

13 Sheds or greenhouses accessory to Group R-3 occupancies, that are freestanding, less than 120
14 square feet (11.15 m²) in area, not permanently affixed to the ground, and used for household
15 goods or items associated with the garden or lawn. Any other shed shall be classified as either
16 S-1 or S-2.

17 Tanks

18 Towers

19 § 5. Chapter 4 of the New York city building code, as added by local law number 33
20 of 2007, sections 402, 403, 404, 405, 406, 407, 408, 409, 410, 411, 412, 413, 414, 415, 416, 417, 418
21 as amended by, sections 419, 420, 421, 422, 423 as added by, local law number 141 for the year 2013,
22 section 402.3 as amended by local law 195 for the year 2018, section 403.4.8.2 as amended by local
23 law number 51 for the year 2014, is amended to read as follows:

24 **CHAPTER 4**
25 **SPECIAL DETAILED REQUIREMENTS BASED ON USE AND OCCUPANCY**

26 **SECTION BC 401**
27 **SCOPE**

28 **401.1 Detailed use and occupancy requirements.** In addition to the occupancy and construction
29 requirements in this code, the provisions of this chapter apply to the special uses and occupancies
30 described herein.

1 SECTION BC 402
2 COVERED MALL AND OPEN MALL BUILDINGS

3 **402.1 [Scope] Applicability.** The provisions of this section shall apply to buildings or structures
4 defined herein as covered or open mall buildings not exceeding three floor levels at any point nor
5 more than three stories above grade plane. Except as specifically required by this section, covered
6 and open mall buildings shall meet applicable provisions of this code.

7 **Exceptions:**

- 8 1. Foyers and lobbies of Groups B, R-1 and R-2 are not required to comply with this section.
9 2. Buildings need not comply with the provisions of this section where they fully comply
10 with other applicable provisions of this code.

11 **402.1.1 Occupancy classification.** A mall in compliance with the provisions of this section shall
12 be classified as occupancy [~~group~~] Group M.

13 **402.1.2 Open space.** A covered mall building and attached anchor buildings and parking garages
14 shall be surrounded on all sides by a permanent open space of not less than 60 feet (18 288 mm).
15 An open mall building and anchor buildings and parking garages adjoining the perimeter line shall
16 be surrounded on all sides by a permanent open space of not less than 60 feet (18 288 mm).

17 **Exception:** The permanent open space of 60 feet (18 288 mm) shall be permitted to be reduced
18 to not less than 40 feet (12 192 mm), provided the following requirements are met:

- 19 1. The reduced open space shall not be allowed for more than 75 percent of the perimeter
20 of the covered mall building and anchor buildings or of the perimeter line of the open
21 mall building and anchor buildings;
22 2. The exterior wall facing the reduced open space shall have a fire-resistance rating of
23 not less than three hours;
24 3. Openings in the exterior wall facing the reduced open space shall have opening
25 protectives with a fire protection rating of not less than three hours; and
26 4. Group E, H, I or R occupancies are not located within the covered or open mall
27 building or anchor buildings.

28 **402.1.3 Open mall building perimeter line.** For the purpose of this code, a perimeter line shall
29 be established. The perimeter line shall encircle all buildings and structures that comprise the open
30 mall building and shall encompass any open-air interior walkways, open-air courtyards or similar
31 open-air spaces. The perimeter line shall define the extent of the open mall building. Anchor
32 buildings and parking structures shall be outside of the perimeter line and are not considered as
33 part of the open mall building.

34 **402.2 Definitions.** ~~[The following words and terms shall, for the purposes of this chapter and as used~~
35 ~~elsewhere in this code, have the meanings shown herein.]~~ This section contains terms defined
36 elsewhere in this code, and terms with definitions that are specific to this section.

1 **402.2.1 Terms defined elsewhere in this code.** The following terms are defined in Chapter 2:

2 **ANCHOR BUILDING.** [~~An exterior perimeter building of a group other than H having direct~~
3 ~~access to a covered mall building but having required means of egress independent of the mall.~~]

4 **COVERED MALL BUILDING.** [~~A single building enclosing a number of tenants and~~
5 ~~occupants such as retail stores, drinking and dining establishments, entertainment and~~
6 ~~amusement facilities, passenger transportation terminals, offices, and other similar uses wherein~~
7 ~~two or more tenants have a main entrance into one or more malls. For the purpose of this chapter,~~
8 ~~anchor buildings shall not be considered as a part of the covered mall building. The term “covered~~
9 ~~mall building” shall include open mall buildings as defined below.~~]

10 **Mall.** [~~A roofed or covered common pedestrian area within a covered mall building that serves~~
11 ~~as access for two or more tenants and not to exceed three levels that are open to each other.~~
12 ~~The term “mall” shall include open malls as defined below.~~]

13 **Open mall.** [~~An unroofed common pedestrian way serving a number of tenants not exceeding~~
14 ~~three levels. Circulation at levels above grade shall be permitted to include open exterior~~
15 ~~balconies leading to exits discharging at grade.~~]

16 **Open mall building.** [~~Several structures housing a number of tenants, such as retail stores,~~
17 ~~drinking and dining establishments, entertainment and amusement facilities, offices, and other~~
18 ~~similar uses, wherein two or more tenants have a main entrance into one or more open malls.~~
19 ~~For the purpose of Chapter 4, anchor buildings are not considered as a part of the open mall~~
20 ~~building.~~]

21 **402.2.2 Definitions specific to this section.** The following terms shall, for the purposes of this
22 section, have the meanings shown herein:

23 **FOOD COURT.** A public seating area located in the mall that serves adjacent food
24 preparation tenant spaces.

25 **GROSS LEASABLE AREA.** The total floor area designed for tenant occupancy and
26 exclusive use. The area of tenant occupancy is measured from the centerlines of joint
27 partitions to the outside of the tenant walls. All tenant areas, including areas used for storage,
28 shall be included in calculating gross leasable area.

29 **402.3 Fire protection plan.** A fire protection plan shall be provided to the Fire Department pursuant
30 to Article 109 of Title 28.

31 [~~402.4 Means of egress.~~ The covered mall building shall be provided with means of egress as
32 required by this code. Where there is a conflict between the requirements of this code and the
33 requirements of this section, the requirements of this section shall apply.]

34 [~~402.4.1 Occupant load.~~ The calculated occupant load used to determine the required number
35 of means of egress shall be in accordance with this section.]

36 [~~402.4.1.1 Occupant load of tenant spaces.~~ The occupant load permitted in any individual
37 tenant space in a covered mall building shall be determined in accordance with Chapter 10.

1 ~~Means of egress requirements for individual tenant spaces shall be based on the occupant~~
2 ~~load thus determined.]~~

3 **[402.4.1.2 Occupant load of mall.** ~~In determining required means of egress of the mall, the~~
4 ~~total occupant load in the mall shall include the occupant load attributed to the mall as~~
5 ~~determined by Section 402.4.1.2.1, plus the occupant load of the food court as determined by~~
6 ~~Section 402.4.1.2.3, if any.]~~

7 **[402.4.1.2.1 Occupant load formula.** ~~To determine the occupant load attributed to the~~
8 ~~mall, the gross leasable area (square feet), excluding any food court and anchor buildings,~~
9 ~~shall be divided by the occupant load factor (OLF) value determined by Equation 4-1.]~~

10 ~~$[OLF = (0.00007)(GLA) + 25]$~~ **[(Equation 4-1)]**

11 ~~[where:]~~

12 ~~[OLF = The occupant load factor (square feet per person).]~~

13 ~~[GLA = The gross leasable area (square feet).]~~

14 **[Exception:** ~~Tenant spaces attached to a covered mall building but with a means of~~
15 ~~egress system that is totally independent of the covered mall building shall not be~~
16 ~~considered as gross leasable area for determining the required means of egress for the~~
17 ~~covered mall building.]~~

18 **[402.4.1.2.2 OLF range.** ~~The occupant load factor (OLF) is not required to be less than~~
19 ~~30 and shall not exceed 50.]~~

20 **[402.4.1.2.3 Food courts.** ~~The occupant load of a food court shall be determined in~~
21 ~~accordance with Section 1004 and shall be added to the occupant load of the mall.]~~

22 **[402.4.1.3 Anchor buildings.** ~~The occupant load of anchor buildings opening into the mall~~
23 ~~shall not be included in computing the total number of occupants for the covered mall~~
24 ~~building.]~~

25 **[402.4.2 Number of means of egress.** ~~The required number of means of egress shall be~~
26 ~~determined in accordance with this section.]~~

27 **[402.4.2.1 Number of means of egress within tenant spaces.** ~~Wherever the distance of travel~~
28 ~~to the mall from any location within a tenant space used by persons other than employees~~
29 ~~exceeds 75 feet (22 860 mm) or the tenant space exceeds an occupant load of 50, no fewer~~
30 ~~than two means of egress shall be provided.]~~

31 **[402.4.2.2 Number of means of egress from the mall.** ~~The number of means of egress from~~
32 ~~the mall shall be determined in accordance with Chapter 10 and shall be based upon an~~
33 ~~occupant load calculated in accordance with Section 402.4.1.2.]~~

34 **[402.4.3 Arrangements of means of egress.** ~~Means of egress shall be arranged in accordance~~
35 ~~with this section.]~~

1 ~~[402.4.3.1 Anchor building means of egress. Required means of egress for anchor buildings~~
2 ~~shall be provided independently from the mall means of egress system. The occupant load of~~
3 ~~anchor buildings opening into the mall shall not be included in determining means of egress~~
4 ~~requirements for the mall. The path of egress travel of malls shall not exit through anchor~~
5 ~~buildings. Malls terminating at an anchor building where no other means of egress has been~~
6 ~~provided shall be considered as a dead-end mall.]~~

7 ~~[402.4.3.2 Tenant spaces requiring more than one means of egress. Where more than one~~
8 ~~means of egress is required from an individual tenant space as determined by Chapter 10, not~~
9 ~~more than 50 percent of the occupant load shall discharge into the mall.]~~

10 ~~[402.4.3.3 Large assembly occupancy. Assembly occupancies with an occupant load of 500~~
11 ~~or more shall be so located in the covered mall building such that their entrance will be~~
12 ~~immediately adjacent to a principal entrance to the mall and shall have not less than one-half~~
13 ~~of their required means of egress opening directly to the exterior of the covered mall~~
14 ~~building.]~~

15 ~~[402.4.4 Distance to exits. The maximum permitted travel distance to exits in covered mall~~
16 ~~buildings shall be in accordance with this section.]~~

17 ~~[402.4.4.1 Distance to exits within tenant spaces. The maximum travel distance from any~~
18 ~~point within an individual tenant space to its entrance to the mall or to an exit shall not exceed~~
19 ~~200 feet (60 960 mm).]~~

20 ~~[402.4.4.2 Distance to exits within the mall. The maximum distance of travel from any point~~
21 ~~within a mall to an exit shall not exceed 200 feet (60 960 mm).]~~

22 ~~[402.4.5 Access to exits. Where more than one exit is required, they shall be so arranged that it~~
23 ~~is possible to travel in either direction from any point in a mall to separate exits. However, in~~
24 ~~dead ends not exceeding a length equal to twice the width of the mall measured at the narrowest~~
25 ~~location within the dead end portion of the mall, one direction of travel shall be permitted. The~~
26 ~~minimum width of an exit passageway or corridor from a mall shall be 66 inches (1676 mm).]~~

27 ~~[402.4.5.1 Exit passageway enclosures. Where exit passageway enclosures provide a~~
28 ~~secondary means of egress from a tenant space, doors to the exit passageway enclosures shall~~
29 ~~be minimum 1-hour fire doors with panic hardware. Such doors shall be self-closing and be~~
30 ~~so maintained or shall be automatic closing by smoke detection.]~~

31 ~~[402.4.6 Service areas fronting on exit passageways. Mechanical rooms, electrical rooms,~~
32 ~~building service areas and service elevators are permitted to open directly into exit passageways~~
33 ~~provided that the exit passageway is separated from such rooms by fire barriers providing the~~
34 ~~same fire-resistance rating as required for the exit passageway. Door swings from these rooms~~
35 ~~shall not project into the minimum width of such exit passageways.]~~

36 ~~[402.5 Mall width. For the purpose of providing required egress, malls are permitted to be~~
37 ~~considered as corridors but need not comply with the requirements of Section 1005.1 of this code~~
38 ~~where the width of the mall is as specified in this section.]~~

1 ~~[402.5.1 Minimum width. The minimum width of the mall shall be 20 feet (6096 mm). The mall~~
2 ~~width shall be sufficient to accommodate the occupant load served. There shall be a minimum~~
3 ~~of 10 feet (3048 mm) clear width to a height of 8 feet (2438 mm) between any projection of a~~
4 ~~tenant space bordering the mall and the nearest kiosk, vending machine, bench, display opening,~~
5 ~~food court or other obstruction to means of egress travel.]~~

6 ~~[402.5.2 Minimum width open mall. The minimum floor and roof opening width above grade~~
7 ~~shall be 20 feet (6096 mm) in open malls.]~~

8 ~~[402.6 Types of construction. Covered mall buildings, including anchor buildings, shall be only of~~
9 ~~Type I, II, and IV construction. Their areas shall not be limited provided that the covered mall~~
10 ~~building and attached anchor buildings and parking garages are surrounded on all sides by a perma-~~
11 ~~nent open space of not less than 60 feet (18 288 mm) and the anchor buildings do not exceed three~~
12 ~~stories in height. The height of covered mall buildings, including anchor buildings, of Type IIB~~
13 ~~construction shall be limited to one story. The allowable height and area of anchor buildings greater~~
14 ~~than three stories in height shall comply with Section 503, as modified by Sections 504 and 506. The~~
15 ~~construction type of open parking garages and enclosed parking garages shall comply with Sections~~
16 ~~406.3 and 406.4, respectively.]~~

17 ~~[402.6.1 Reduced open space. The permanent open space of 60 feet (18 288 mm) shall be~~
18 ~~permitted to be reduced to not less than 40 feet (12 192 mm), provided the following~~
19 ~~requirements are met:]~~

20 ~~[1. The reduced open space shall not be allowed for more than 75 percent of the perimeter~~
21 ~~of the covered mall building and anchor buildings.]~~

22 ~~[2. The exterior wall facing the reduced open space shall have a minimum fire resistance~~
23 ~~rating of 3 hours.]~~

24 ~~[3. Openings in the exterior wall facing the reduced open space shall have opening~~
25 ~~protectives with a minimum fire protection rating of 3 hours.]~~

26 ~~[4. Group E, H, I or R occupancies are not within the covered mall building or anchor~~
27 ~~stores.]~~

28 **402.4 Construction.** The construction of covered and open mall buildings, anchor buildings and
29 parking garages associated with a mall building shall comply with Sections 402.4.1 through 402.4.3.

30 **402.4.1 Area and types of construction.** The building area and type of construction of covered
31 mall or open mall buildings, anchor buildings and parking garages shall comply with this section.

32 **402.4.1.1 Covered and open mall buildings.** Covered and open mall buildings shall be of
33 Type I, II or IV construction. The height of covered mall buildings of Type IIB construction
34 shall be limited to one story. The areas of covered mall buildings or open mall buildings shall
35 not be limited provided that the covered mall building or open mall building and attached
36 anchor buildings and parking garages are surrounded on all sides by a permanent open space
37 in accordance with Section 402.1.2.

1 402.4.1.2 Anchor buildings. Anchor buildings shall be of Type I, II or IV construction. The
2 height of anchor buildings, of Type IIB construction, shall be limited to one story. The
3 allowable height and area of anchor buildings greater than three stories in height shall comply
4 with Section 503, as modified by Sections 504 and 506.

5 402.4.1.3 Parking garage. The building area and building height of any parking garage, open
6 or enclosed, shall be based on the type of construction as required by Sections 406.5 and
7 406.6, respectively.

8 [402.7] 402.4.2 Fire-resistance-rated separation. Fire-resistance-rated separation is not
9 required between tenant spaces and the mall. Fire-resistance-rated separation is not required
10 between a food court and adjacent tenant spaces or the mall.

11 402.4.2.1 Tenant separations. Each tenant space shall be separated from other tenant spaces
12 by a fire partition complying with Section 708. A tenant separation wall is not required
13 between any tenant space and the mall.

14 402.4.2.2 Anchor building separation. An anchor building shall be separated from the
15 covered or open mall building by fire walls complying with Section 706.

16 **Exceptions:**

17 1. Anchor buildings of not more than three stories above grade that have an
18 occupancy classification of the same uses permitted as tenants of the covered mall
19 building shall be separated by 2-hour fire-resistance-rated fire barriers complying
20 with Section 707. Openings between such buildings and the mall need not be
21 protected.

22 2. The exterior walls of anchor buildings separated from an open mall building by an
23 open mall shall comply with Table 602.

24 [402.7.1] 402.4.2.3 [Attached garage] Parking garages. An attached [~~parking~~] garage for
25 the storage of passenger vehicles having a capacity of not more than nine persons and open
26 parking garages shall be considered as a separate building where it is separated from the
27 covered or open mall building or anchor building by not less than 2-hour fire barriers
28 constructed in accordance with Section 707 or horizontal assemblies constructed in
29 accordance with Section [712] 711, or both.

30 **[Exception: Where an] Parking garages, open [parking garage] or enclosed [parking**
31 **garage is], which are separated from [the] covered mall [building] buildings, open mall**
32 **buildings or anchor [building by a distance greater than 10 feet (3048 mm), the] buildings,**
33 **shall comply with the provisions of Table 602[shall apply].**

34 Pedestrian walkways and tunnels that [~~attach the open parking garage or enclosed~~
35 ~~parking garage]~~ connect garages to the [~~covered~~] mall [~~building~~] buildings or anchor
36 [~~building~~] buildings shall be constructed in accordance with Section 3104.

1 ~~[402.7.2 Tenant separations. Each tenant space shall be separated from other tenant spaces by~~
2 ~~a fire partition complying with Section 709. A tenant separation wall is not required between any~~
3 ~~tenant space and the mall.]~~

4 **402.4.3 Open mall construction.** Floor assemblies in, and roof assemblies over, the open mall of
5 an open mall building shall be open to the atmosphere for not less than 20 feet (9096 mm),
6 measured perpendicular from the face of the tenant spaces on the lowest level, from edge of
7 balcony to edge of balcony on upper floors and from edge of roof line to edge of roof line. The
8 openings within, or the unroofed area of, an open mall shall extend from the lowest/grade level
9 of the open mall through the entire roof assembly. Balconies on upper levels of the mall shall not
10 project into the required width of the opening.

11 **402.4.3.1 Pedestrian walkways.** Pedestrian walkways connecting balconies in an open mall
12 shall be located not less than 20 feet (9096 mm) from any other pedestrian walkway.

13 ~~[402.7.3 Anchor building separation. An anchor building shall be separated from the covered~~
14 ~~mall building by fire walls complying with Section 706.]~~

15 ~~[Exception: Anchor buildings of not more than three stories above grade that have an~~
16 ~~occupancy classification of the same uses permitted as tenants of the covered mall building~~
17 ~~shall be separated by 2-hour fire resistive fire barriers complying with Section 707. Openings~~
18 ~~between such buildings and the mall need not be protected.]~~

19 ~~[402.8 Interior finish. Interior wall and ceiling finishes within the mall and exits shall have a~~
20 ~~minimum flame spread index and smoke developed index of Class B in accordance with Chapter 8.~~
21 ~~Interior floor finishes shall meet the requirements of Section 804.]~~

22 ~~[402.9]~~ **402.5 Automatic sprinkler system.** ~~[The covered]~~ Covered and open mall [building]
23 buildings and buildings connected shall be [provided] equipped throughout with an automatic
24 sprinkler system in accordance with Section 903.3.1.1, [that] which shall comply with all of the
25 following:

- 26 1. The automatic sprinkler system shall be complete and operative throughout occupied space in
27 the ~~[covered]~~ mall building prior to occupancy of any of the tenant spaces. Unoccupied tenant
28 spaces shall be similarly protected unless provided with approved ~~[alternate]~~ alternative
29 protection.
- 30 2. Sprinkler protection for the mall of a covered mall building shall be controlled independently
31 [independent] from that provided for tenant spaces or [anchors] anchor buildings.
- 32 3. Sprinkler protection for the tenant spaces of an open mall building shall be controlled
33 independently from that provided for anchor buildings.
- 34 4. Sprinkler protection shall be provided beneath exterior circulation balconies located adjacent
35 to an open mall.
- 36 5. Where tenant spaces are supplied by the same system, they shall be independently controlled.

1 **Exception:** An automatic sprinkler system shall not be required in spaces or areas of open parking
2 garages separated from the covered or open mall building in accordance with Section 402.4.2.3
3 and constructed in accordance with Section [406.2] 406.5.

4 ~~[402.9.1 Standpipe system. The covered mall building shall be equipped with a standpipe system~~
5 ~~as required by Section 905.3.3.]~~

6 **402.6 Interior finishes and features.** Interior finishes within the mall and installations within the
7 mall shall comply with Sections 402.6.1 through 402.6.4.

8 **402.6.1 Interior finish.** Interior wall and ceiling finishes within the mall of a covered mall
9 building and within the exits of covered or open mall buildings shall have a minimum flame
10 spread index and smoke-developed index of Class B in accordance with Chapter 8. Interior floor
11 finishes shall meet the requirements of Section 804.

12 ~~[402.10 Smoke control. A smoke control system shall be provided in accordance with Section 909~~
13 ~~for malls greater than one story in height.]~~

14 ~~[Exception: A smoke control system is not required in an open mall.]~~

15 ~~[402.11]~~ **402.6.2 Kiosks.** Kiosks and similar structures (temporary or permanent) located within
16 the mall of a covered mall building or within the perimeter line of an open mall building shall
17 meet the following requirements:

- 18 1. Combustible kiosks or other similar structures shall not be located within ~~[the]~~ a covered
19 or open mall unless constructed of any of the following materials:
 - 20 1.1. Fire-retardant-treated wood complying with Section 2303.2.
 - 21 1.2. Foam plastics having a maximum heat release rate not greater than 100 kW (105
22 Btu/h) when tested in accordance with the exhibit booth protocol in UL 1975 or
23 when tested in accordance with NFPA 289 using the 20 kW ignition source.
 - 24 1.3. Aluminum composite material (ACM) having a flame spread index of not more
25 than 25 and a smoke-developed index of not more than 450 when tested as an
26 assembly in the maximum thickness intended for use in accordance with ASTM
27 E 84 or UL 723.
- 28 2. ~~[Kiosks]~~ Covered kiosks or similar covered structures located within the covered mall
29 building shall be provided with an approved [fire suppression and detection] automatic
30 sprinkler system and detection devices where required by the *New York City Fire Code*
31 and Section 903.3.3 of this code.
- 32 3. The ~~[minimum]~~ horizontal separation between kiosks or groupings thereof and other
33 similar structures within the mall shall be not less than 20 feet (6096 mm).
- 34 4. Each kiosk or similar structure or groupings thereof shall have ~~[a maximum]~~ an area ~~[of]~~
35 not greater than 300 square feet (28 m²).

1 ~~[402.12] 402.6.3 Children's [playground] play structures. [Structures intended as children's~~
2 ~~playgrounds that exceed 10 feet (3048 mm) in height and 150 square feet (14 m²) in area shall~~
3 ~~comply with Sections 402.12.1 through 402.12.4.] Children's play structures located within the~~
4 ~~mall of a covered mall building or within the perimeter line of an open mall building shall comply~~
5 ~~with Section 424. The horizontal separation between children's play structures, kiosks and similar~~
6 ~~structures within the mall shall be not less than 20 feet (6096 mm).~~

7 ~~[402.12.1 Materials. Children's playground structures shall be constructed of noncombustible~~
8 ~~materials or of combustible materials that comply with the following:]~~

9 ~~[1. Fire retardant treated wood.]~~

10 ~~[2. Light transmitting plastics complying with Section 2606.]~~

11 ~~[3. Foam plastics (including the pipe foam used in soft contained play equipment structures)~~
12 ~~having a maximum heat release rate not greater than 100 kilowatts when tested in~~
13 ~~accordance with UL 1975.]~~

14 ~~[4. Aluminum composite material (ACM) meeting the requirements of Class A interior finish~~
15 ~~in accordance with Chapter 8 when tested as an assembly in the maximum thickness~~
16 ~~intended for use.]~~

17 ~~[5. Textiles and films complying with the flame propagation performance criteria contained~~
18 ~~in NFPA 701.]~~

19 ~~[6. Plastic materials used to construct rigid components of soft contained play equipment~~
20 ~~structures (such as tubes, windows, panels, junction boxes, pipes, slides and decks)~~
21 ~~exhibiting a peak rate of heat release not exceeding 400 kW/m² when tested in accordance~~
22 ~~with ASTM E 1354 at an incident heat flux of 50 kW/m² in the horizontal orientation at a~~
23 ~~thickness of 6 mm.]~~

24 ~~[7. Ball pool balls, used in soft contained play equipment structures, having a maximum heat~~
25 ~~release rate not greater than 100 kilowatts when tested in accordance with UL 1975. The~~
26 ~~minimum specimen test size shall be 36 inches by 36 inches (914 mm by 914 mm) by an~~
27 ~~average of 21 inches (533 mm) deep, and the balls shall be held in a box constructed of~~
28 ~~galvanized steel poultry netting wire mesh.]~~

29 ~~[8. Foam plastics shall be covered by a fabric, coating or film meeting the flame propagation~~
30 ~~performance criteria of NFPA 701.]~~

31 ~~[9. The floor covering placed under the children's playground structure shall exhibit a Class~~
32 ~~I interior floor finish classification, as described in Section 804, when tested in accordance~~
33 ~~with NFPA 253.]~~

34 ~~[402.12.2 Fire protection. Children's playground structures located within the mall shall be~~
35 ~~provided with the same level of approved fire suppression and detection devices required for~~
36 ~~kiosks and similar structures.]~~

1 ~~[402.12.3 Separation. Children's playground structures shall have a minimum horizontal~~
2 ~~separation from other structures within the mall of 20 feet (6090 mm).]~~

3 ~~[402.12.4 Area limits. Children's playground structures shall not exceed 300 square feet (28 m²)~~
4 ~~in area.]~~

5 ~~[402.13 Security grilles and doors. Horizontal sliding or vertical security grilles or doors that are a~~
6 ~~part of a required means of egress shall conform to the following:]~~

7 ~~[1. They shall remain in the full open position during the period of occupancy by the general~~
8 ~~public.]~~

9 ~~[2. Doors or grilles shall not be brought to the closed position when there are 10 or more~~
10 ~~persons occupying spaces served by a single exit or 50 or more persons occupying spaces~~
11 ~~served by more than one exit.]~~

12 ~~[3. The doors or grilles shall be openable from within without the use of any special~~
13 ~~knowledge or effort where the space is occupied.]~~

14 ~~[4. Where two or more exits are required, not more than one half of the exits shall be~~
15 ~~permitted to include either a horizontal sliding or vertical rolling grille or doors.]~~

16 ~~[402.14 Standby power. Covered mall buildings exceeding 50,000 square feet (4645 m²) shall be~~
17 ~~provided with standby power systems that are capable of operating the emergency voice/alarm~~
18 ~~communication system.]~~

19 ~~[402.15 Emergency voice/alarm communication system. Covered mall buildings exceeding 50,000~~
20 ~~square feet (4645 m²) in total floor area shall be provided with an emergency voice/alarm~~
21 ~~communication system. Emergency voice/alarm communication systems serving a mall, required or~~
22 ~~otherwise, shall be accessible to the Fire Department. The system shall be provided in accordance~~
23 ~~with Section 907.2.12.2.]~~

24 ~~[402.16] 402.6.4 Plastic signs. Plastic signs affixed to the storefront of any tenant space facing~~
25 ~~[the] a mall or open mall shall be limited as specified in Sections [402.16.1] 402.6.4.1 through~~
26 ~~[402.16.5] 402.6.4.5.~~

27 ~~[402.16.1] 402.6.4.1 Area. Plastic signs shall be not [exceed] more than 20 percent of the wall~~
28 ~~area facing the mall.~~

29 ~~[402.16.2] 402.6.4.2 Height and width. Plastic signs shall be not [exceed a height of] greater~~
30 ~~than 36 inches (914 mm) in height, except [if] that where the sign is vertical, the height shall~~
31 ~~be not [exceed] greater than 96 inches (2438 mm) and the width shall be not [exceed] greater~~
32 ~~than 36 inches (914 mm).~~

33 ~~[402.16.3] 402.6.4.3 Location. Plastic signs shall be located [a minimum distance of] not~~
34 ~~less than 18 inches (457 mm) from adjacent tenants.~~

35 ~~[402.16.4] 402.6.4.4 Plastics other than foam plastics. Plastics other than foam plastics used~~
36 ~~in signs shall be [light transmitting] lighttransmitting plastics complying with Section 2606.4~~

1 or shall have a self-ignition temperature of 650°F (343°C) or greater when tested in
2 accordance with ASTM D 1929, and a flame spread index not greater than 75 and smoke-
3 developed index not greater than 450 when tested in the manner intended for use in accordance
4 with ASTM E 84 or UL 723 or meet the acceptance criteria of Section [~~803.2.1~~] 803.1.2.1
5 when tested in accordance with NFPA 286.

6 [~~402.16.4.1~~] **402.6.4.4.1 Encasement.** Edges and backs of plastic signs in the mall shall
7 be fully encased in metal.

8 [~~402.16.5~~] **402.6.4.5 Foam plastics.** Foam plastics used in signs shall have flame-retardant
9 characteristics such that the sign has a maximum heat-release rate of 150 kilowatts when tested
10 in accordance with UL 1975 or when tested in accordance with NFPA 289 using the 20 kW
11 ignition source, and the foam plastics shall have the physical characteristics specified in this
12 section. Foam plastics used in signs installed in accordance with Section [~~402.14~~] 402.6.4
13 shall not be required to comply with the flame spread and smoke-developed [~~indexes~~] indices
14 specified in Section 2603.3.

15 [~~402.16.5.1~~] **402.6.4.5.1 Density.** The [~~minimum~~] density of foam plastics used in signs
16 shall be not [~~be~~] less than 20 pounds per cubic foot (pcf) (320 kg/m³).

17 [~~402.16.5.2~~] **402.6.4.5.2 Thickness.** The thickness of foam plastic signs shall be not [~~be~~]
18 greater than 1/2 inch (12.7 mm).

19 **402.7 Emergency systems.** Covered and open mall buildings, anchor buildings and associated
20 parking garages shall be provided with emergency systems complying with Sections 402.7.1 through
21 402.7.5.

22 **402.7.1 Standpipe system.** Covered and open mall buildings shall be equipped throughout with
23 a standpipe system as required by Section 905.3.3.

24 **402.7.2 Smoke control.** Where a covered mall building contains an atrium, a smoke control
25 system shall be provided in accordance with Section 404.5.

26 **402.7.3 Emergency power.** Covered mall buildings greater than 50,000 square feet (4645 m²) in
27 area and open mall buildings greater than 50,000 square feet (4645 m²) within the established
28 perimeter line shall be provided with emergency power that is capable of operating the emergency
29 voice/alarm communication system in accordance with Section 2702.

30 **402.7.4 Emergency voice/alarm communication system.** Where the total floor area is greater
31 than 50,000 square feet (4645 m²) within either a covered mall building or within the perimeter
32 line of an open mall building, an emergency voice/alarm communication system shall be
33 provided.

34 Emergency voice/alarm communication systems serving a mall, required or otherwise, shall
35 be accessible to the fire department. The systems shall be provided in accordance with Section
36 907.5.2.2.

1 **[402.17] 402.7.5 Fire Department access to equipment.** Rooms or areas containing controls for
2 air-conditioning systems, automatic fire-extinguishing systems, automatic sprinkler systems or
3 other detection, suppression or control elements shall be identified for use by the Fire Department.

4 **402.8 Means of egress.** Covered mall buildings, open mall buildings and each tenant space within a
5 mall building shall be provided with means of egress as required by this section and this code. Where
6 there is a conflict between the requirements of this code and the requirements of Sections 402.8.1
7 through 402.8.8, the requirements of Sections 402.8.1 through 402.8.8 shall apply.

8 **402.8.1 Mall width.** For the purpose of providing required egress, malls are permitted to be
9 considered as corridors but need not comply with the requirements of Section 1005.1 of this code
10 where the width of the mall is as specified in this section.

11 **402.8.1.1 Minimum width.** The aggregate clear egress width of the mall in either a covered
12 or open mall building shall be not less than 20 feet (6096 mm). The mall width shall be
13 sufficient to accommodate the occupant load served. No portion of the minimum required
14 aggregate egress width shall be less than 10 feet (3048 mm) measured to a height of 8 feet
15 (2438 mm) between any projection of a tenant space bordering the mall and the nearest kiosk,
16 vending machine, bench, display opening, food court or other obstruction to means of egress
17 travel.

18 **402.8.2 Occupant load.** The calculated occupant load used to determine the required number of
19 means of egress shall be in accordance with this section.

20 **402.8.2.1 Occupant load of tenant spaces.** The occupant load permitted in any individual
21 tenant space in a covered mall building shall be determined in accordance with Chapter 10.
22 Means of egress requirements for individual tenant spaces shall be based on the occupant
23 load thus determined.

24 **402.8.2.2 Occupant load of mall.** In determining required means of egress of the mall, the
25 total occupant load in the mall shall include the occupant load attributed to the mall as
26 determined by Section 402.8.2.3, plus the occupant load of the food court as determined by
27 Section 402.8.2.5, if any.

28 **402.8.2.3 Occupant load formula.** To determine the occupant load attributed to the mall, the
29 gross leasable area (square feet), excluding any food court and anchor buildings, shall be
30 divided by the occupant load factor (OLF) value determined by Equation 4-1.

31
$$OLF = (0.00007)(GLA) + 25 \qquad \qquad \qquad \text{(Equation 4-1)}$$

32 where:

33 OLF = The occupant load factor (square feet per person).

34 GLA = The gross leasable area (square feet).

35 **Exception:** Tenant spaces attached to a covered mall building but with a means of egress
36 system that is totally independent of the covered mall building shall not be considered as
37 gross leasable area for determining the required means of egress for the covered mall
38 building.

1 **402.8.2.4 OLF range.** The occupant load factor (OLF) is not required to be less than 30 and
2 shall not exceed 50.

3 **402.8.2.5 Food courts.** The occupant load of a food court shall be determined in accordance
4 with Section 1004 and shall be added to the occupant load of the mall.

5 **402.8.2.6 Anchor buildings.** The occupant load of anchor buildings opening into the mall
6 shall not be included in computing the total number of occupants for the covered mall
7 building.

8 **402.8.3 Number of means of egress.** The required number of means of egress shall be
9 determined in accordance with this section.

10 **402.8.3.1 Number of means of egress within tenant spaces.** Wherever the distance of travel to
11 the mall from any location within a tenant space used by persons other than employees exceeds
12 75 feet (22 860 mm) or the tenant space exceeds an occupant load of 74, no fewer than two means
13 of egress shall be provided.

14 **402.8.3.2 Number of means of egress from the mall.** The number of means of egress from the
15 mall shall be determined in accordance with Chapter 10 and shall be based upon an occupant
16 load calculated in accordance with Section 402.8.2.

17 **402.8.4 Arrangements of means of egress.** Means of egress shall be arranged in accordance with
18 this section.

19 **402.8.4.1 Anchor building means of egress.** Required means of egress for anchor buildings
20 shall be provided independently from the mall means of egress system. The occupant load of
21 anchor buildings opening into the mall shall not be included in determining means of egress
22 requirements for the mall. The path of egress travel of malls shall not exit through anchor
23 buildings. Malls terminating at an anchor building where no other means of egress has been
24 provided shall be considered as a dead-end mall.

25 **402.8.4.2 Tenant spaces requiring more than one means of egress.** Where more than one
26 means of egress is required from an individual tenant space as determined by Chapter 10, not
27 more than 50 percent of the occupant load shall discharge into the mall.

28 **402.8.4.3 Large assembly occupancy.** Assembly occupancies with an occupant load of 500
29 or more shall be so located in the covered mall building such that their entrance will be
30 immediately adjacent to a principal entrance to the mall and shall have not less than one-half
31 of their required means of egress opening directly to the exterior of the covered mall building.

32 **402.8.5 Distance to exits.** Within each individual tenant space in a covered or open mall building,
33 the distance of travel from any point to an exit or entrance to the mall shall be not greater than
34 200 feet (60 960 mm).

35 The distance of travel from any point within a mall of a covered mall building to an exit shall
36 be not greater than 200 feet (60 960 mm). The maximum distance of travel from any point within
37 an open mall to the perimeter line of the open mall building shall be not greater than 200 feet (60
38 960 mm).

1 **402.8.6 Access to exits.** Where more than one exit is required, they shall be so arranged that it is
2 possible to travel in either direction from any point in a mall of a covered mall building to separate
3 exits or from any point in an open mall of an open mall building to two separate locations on the
4 perimeter line, provided neither location is an exterior wall of an anchor building or parking
5 garage. The width of an exit passageway or corridor from a mall shall be not less than 66 inches
6 (1676 mm).

7 **Exception:** Access to exits is permitted by way of a dead-end mall that does not exceed a
8 length equal to twice the width of the mall measured at the narrowest location within the dead-
9 end portion of the mall.

10 **402.8.6.1 Exit passageway enclosures.** Where exit passageway enclosures provide a
11 secondary means of egress from a tenant space, doors to the exit passageway enclosures shall
12 be minimum 1-hour fire doors with panic hardware. Such doors shall be self-closing and be
13 so maintained or shall be automatic closing by smoke detection.

14 **402.8.7 Service areas fronting on exit passageways.** Mechanical rooms, electrical rooms,
15 building service areas and service elevators are permitted to open directly into exit passageways
16 provided that the exit passageway is separated from such rooms by fire barriers providing the
17 same fire-resistance rating as required for the exit passageway. Door swings from these rooms
18 shall not project into the minimum width of such exit passageways.

19 **402.8.8 Security grilles and doors.** Horizontal sliding or vertical security grilles or doors that are
20 a part of a required means of egress shall conform to the following:

- 21 1. Doors and grilles shall remain in the full open position during the period of occupancy by
22 the general public.
- 23 2. Doors or grilles shall not be brought to the closed position when there are 10 or more
24 persons occupying spaces served by a single exit or 50 or more persons occupying spaces
25 served by more than one exit.
- 26 3. The doors or grilles shall be openable from within without the use of any special
27 knowledge or effort where the space is occupied.
- 28 4. Where two or more exits are required, not more than one-half of the exits shall be
29 permitted to include either a horizontal sliding or vertical rolling grille or door.

30 **SECTION BC 403**
31 **HIGH-RISE BUILDINGS**

32 **403.1 Applicability.** High-rise buildings shall comply with Sections 403.2 through 403.8.

33 **Exception:** The provisions of ~~[this section]~~ Sections 403.2 through 403.8 shall not apply to the
34 following buildings and structures:

- 35 1. Air traffic control towers in accordance with Section 412.3.
- 36 2. Buildings occupied entirely by Group R-3 classification.

- 1 3. Open parking garages in accordance with Section ~~[406.3]~~ 406.5.
- 2 4. ~~[Buildings with an occupancy in]~~ The portion of a building containing a Group A-5
3 occupancy in accordance with Section ~~[303.4]~~ 303.6.
- 4 5. ~~[Low hazard special]~~ Special industrial occupancies in accordance with Section 503.1.1.
- 5 6. Buildings with ~~[an occupancy in]~~:
 - 6 6.1. A Group H-1[;] occupancy;
 - 7 6.2. A Group H-2 ~~[or H-3]~~ occupancy in accordance with Section ~~[415]~~ 415.8, 415.9.2,
8 415.9.3 or 426.1; or
 - 9 6.3. A Group H-3 occupancy in accordance with Section 415.8.

10 **403.2 Construction.** The construction of high-rise buildings shall comply with the provisions of
11 Sections 403.2.1 through 403.2.4.

12 **403.2.1 Types of construction.** The following modifications to the minimum fire-resistance
13 rating of the building elements in Table 601 shall be as follows:

- 14 1. High rise buildings 420 feet (128 m) or greater in building height shall be constructed of
15 Type IA construction.
- 16 2. For high rise buildings not greater than 420 feet (128 m) in building height, and
17 constructed to meet the fire-resistance rating requirements of Type IB or IIA construction,
18 the required fire-resistance rating of columns supporting floors shall be constructed to
19 meet Type IA construction.

20 **403.2.2 Seismic considerations.** For seismic considerations, see Chapter 16.

21 **403.2.3 Structural integrity of interior exit [enclosures] stairways and elevator hoistway**
22 **enclosures.** For all high-rise buildings, exit enclosures for interior exit stairways and elevator
23 hoistway enclosures shall comply with Sections 403.2.3.1 through 403.2.3.4.

24 **Exception:** Where fire-resistance rating is not required by this code for the enclosure or
25 portions thereof.

26 **403.2.3.1 Wall assembly.** The wall assemblies making up the ~~[exit]~~ enclosures for interior
27 exit stairways and elevator hoistway enclosures shall meet or exceed Soft Body Impact
28 Classification Level 2 as measured by the test method described in ASTM C 1629/C 1629M.

29 **403.2.3.2 Wall assembly materials.** The face of the wall assemblies making up the ~~[exit]~~
30 enclosures for interior exit stairways and elevator hoistway enclosures that are not exposed to
31 the interior of the enclosures for interior exit [enclosure] stairways or elevator hoistway
32 enclosure shall be constructed in accordance with one of the following methods:

1. The wall assembly shall incorporate [~~not less~~] no fewer than two layers of impact-resistant construction board each of which meets or exceeds Hard Body Impact Classification Level 2 as measured by the test method described in ASTM C 1629/C 1629M.
2. The wall assembly shall incorporate [~~not less~~] no fewer than one layer of impact-resistant construction material that meets or exceeds Hard Body Impact Classification Level 3 as measured by the test method described in ASTM C 1629/C 1629M.
3. The wall assembly incorporates multiple layers of any material, tested in tandem, that [~~meet~~] meets or [~~exceed~~] exceeds Hard Body Impact Classification Level 3 as measured by the test method described in ASTM C 1629/C 1629M.

403.2.3.3 Concrete and masonry walls. Concrete or masonry walls shall be deemed to satisfy the requirements of Sections 403.2.3.1 and 403.2.3.2.

403.2.3.4 Other wall assemblies. Any other wall assembly that provides impact resistance equivalent to that required by Sections 403.2.3.1 and 403.2.3.2 for Hard Body Impact Classification Level 3, as measured by the test method described in ASTM C 1629/C 1629M, shall be permitted.

403.2.4 Sprayed fire-resistant materials (SFRM). The bond strength of the SFRM installed throughout the building shall be in accordance with Table 403.2.4.

**TABLE 403.2.4
MINIMUM BOND STRENGTH**

HEIGHT OF BUILDING ^a	SFRM MINIMUM BOND STRENGTH
Up to 420 feet	430 psf
Greater than 420 feet	1,000 psf

For SI: 1 foot = 304.8 mm, 1 pound per square foot (psf) = 0.0479 kW/m².
a. Above the lowest level of fire department vehicle access.

403.3 Automatic sprinkler system. Buildings and structures shall be equipped throughout with an automatic sprinkler system in accordance with Section 903.3.1.1[~~-A~~] and a secondary water supply [~~shall be provided~~] where required by Section [903.3.5.2] 403.3.3.

403.3.1 Number of sprinkler risers and system design. Each sprinkler system zone in buildings that are more than 300 feet [~~(9144 m)~~] (91 440 mm) in building height shall be supplied by [~~a minimum of~~] no fewer than two risers. Each riser shall supply sprinklers on alternate floors. If more than two risers are provided for a zone, sprinklers on adjacent floors shall not be supplied from the same riser.

403.3.1.1 Riser location. [~~Each sprinkler riser~~] Sprinkler risers shall be placed in interior exit [enclosures] stairways and ramps that are remotely located in accordance with Section [4015.2] 1007.1.

403.3.2 Water supply to required fire pumps. Required fire pumps shall be provided with water supplies in accordance with Section 905.2 and NFPA 14 as modified by Appendix Q of this code.

1 **403.3.3 Secondary on-site water supply.** A secondary on-site water supply equal to the
2 hydraulically calculated sprinkler demand, including the hose stream requirement, shall be
3 provided for high-rise buildings in Seismic Design Category C or D as determined by this code,
4 and in any high-rise building with occupied floors located more than 500 feet (152 m) above the
5 lowest level of fire department vehicle access. The secondary on-site water supply shall have a
6 duration of not less than 30 minutes as determined by the occupancy hazard classification in
7 accordance with NFPA 13 as modified by Appendix Q of this code.

8 **403.3.4 Fire pump room.** Fire pumps shall be located in rooms protected in accordance with
9 Section 913.2.1.

10 **403.4 Emergency systems.** The detection, alarm and emergency systems of high-rise buildings shall
11 comply with Sections 403.4.1 through 403.4.8.

12 **403.4.1 Smoke detection.** Smoke detection shall be provided in accordance with Section
13 907.2.13.1.

14 **403.4.2 Fire ~~[alarms systems]~~ alarm system.** A fire alarm system shall be provided in
15 accordance with Section 907.2.13.

16 **403.4.3 Standpipe system.** A high-rise building shall be equipped with a standpipe system as
17 required by Section 905.3.

18 **403.4.4 Emergency voice/alarm communication [systems] system.** An emergency voice/alarm
19 communication system shall be provided in accordance with Section 907.5.2.2.

20 ~~[403.4.4]~~ **403.4.5 Emergency responder radio coverage.** Emergency responder radio coverage
21 shall be provided in accordance with the *New York City Fire Code* and Section 907.2.13.2 of this
22 code.

23 ~~[403.4.5]~~ **403.4.6 Fire command.** A fire command center complying with Section 911 shall be
24 provided in a location approved by the Fire Department.

25 ~~[403.4.6]~~ **403.4.7 Post-fire smoke purge.** A post-fire smoke purge system shall be installed in
26 accordance with Section ~~[916]~~ 917.

27 ~~[403.4.7]~~ **403.4.8 Standby and emergency power.** A standby power system complying with
28 Section 2702 and Section 3003 shall be provided for the standby power loads specified in ~~[Section~~
29 ~~403.4.7.2 and 403.4.7.3]~~ Section 403.4.8.3. An emergency power system complying with Section
30 2702 shall be provided for the emergency power loads specified in Section 403.4.8.4.

31 ~~[403.4.7.1 Special requirements for standby power systems.]~~ **403.4.8.1 Equipment room.**
32 If the standby or emergency power system ~~[is]~~ includes a generator set inside a building, the
33 system shall be located in a separate room ~~[enclosed with 2-hour fire-resistance-rated fire~~
34 ~~barrier assemblies. System supervision with manual start and transfer features shall be~~
35 ~~provided at the fire command center]~~ in accordance with Section 2702.1.2.2.

36 **403.4.8.2 Fuel line piping protection.** Fuel lines supplying a generator set inside a building
37 shall comply with Section 1305.9 of the *New York City Mechanical Code*.

1 **403.4.8.3 Standby power systems.** A standby power system complying with Section 2702
2 shall be provided for standby power loads specified in Sections 403.4.8.3.1 and 403.4.8.3.2.
3 Fuel sources for generators shall be in accordance with Section 2702.1.1.

4 **[403.4.7.2] 403.4.8.3.1 Standby power loads in occupancies other than Group R-2.** In
5 buildings of any occupancy group other than Group R-2, the following are classified as
6 standby power loads:

- 7 1. Power and lighting for fire command center required by Section ~~[403.4.5]~~ 403.4.6;
- 8 2. Ventilation and automatic fire detection equipment for smokeproof enclosures;
- 9 3. Elevators, in accordance with Section 3003; and
- 10 4. Stair pressurization systems when provided.

11 **[403.4.7.3] 403.4.8.3.2 Standby power loads in Group R-2 occupancies.** Group R-2
12 occupancies in buildings greater than 125 feet (38 100 mm) in height shall be required to
13 provide a standby power system to support the following loads:

- 14 1. Power and lighting for fire command center required by Section ~~[403.4.5]~~ 403.4.6;
- 15 2. Ventilation and automatic fire detection equipment for smokeproof enclosures;
- 16 3. At least one elevator serving all floors, or one elevator per bank where different
17 banks serve different portions of the building; and
- 18 4. Stair pressurization systems when provided.

19 **[403.4.8] 403.4.8.4 Emergency power systems.** An emergency power system complying
20 with Section 2702 shall be provided for emergency power loads specified in Sections
21 ~~[403.4.8.1]~~ 403.4.8.4.1 and ~~[403.4.8.2]~~ 403.4.8.4.3. Fuel sources for generators shall be in
22 accordance with Section 2702.1.1.

23 **[403.4.8.1] 403.4.8.4.1 Emergency power loads in occupancies other than Group R-**
24 **2.** In buildings of any occupancy group other than Group R-2, the following are classified
25 as emergency power loads:

- 26 1. Exit signs and means of egress illumination required by Chapter 10;
- 27 2. Elevator car lighting;
- 28 3. Emergency voice/alarm communications systems, including Fire Department in-
29 building Auxiliary Radio Communication systems (ARCs);
- 30 4. Automatic fire detection systems;
- 31 5. Fire alarm systems; and

- 1 6. Electrically powered fire pumps, including manual fire pumps, automatic fire
2 pumps, and sprinkler booster pumps.

3 **[403.4.8.2] 403.4.8.4.2 Emergency power loads in Group R-2 occupancies.** Group R-
4 2 occupancies in buildings greater than 125 feet (38 100 mm) in height shall be required
5 to provide an emergency power system to support the following loads:

- 6 1. Exit signs and means of egress illumination required by Chapter 10;
7 2. Emergency voice communications systems, including Fire Department in-
8 building Auxiliary Radio Communication systems (ARCs); and
9 3. Electrically powered fire pumps, unless electrical power to the motor is taken
10 ahead of the main from the street side of the house service switch.

11 **403.4.8.4.3 Emergency power loads in Group R-2 occupancies 125 feet or less in**
12 **height.** Group R-2 occupancies in buildings 125 feet (38 100 mm) or less in height shall
13 be required to provide an emergency power system to support the following loads:

- 14 1. Emergency voice communications systems in buildings containing Group R-2
15 occupancies in accordance with Section 907.5.2.2 of this code, or where otherwise
16 provided. Batteries in accordance with the *New York City Electrical Code* are
17 permitted to serve as the secondary power supply for such systems.
18 2. Fire Department in-building Auxiliary Radio Communication systems (ARCs) in
19 buildings containing Group R-2 occupancies in accordance with Section 916.3 of
20 this code, or where otherwise provided. Batteries in accordance with the *New York*
21 *City Electrical Code* are permitted to serve as the secondary power supply for
22 such systems.

23 **403.5 Means of egress and evacuation.** The means of egress in high-rise buildings shall comply
24 with Sections 403.5.1 through 403.5.6.

25 **403.5.1 Remoteness of interior exit [~~stairway enclosures~~] stairways.** [~~The required~~] Required
26 interior exit [~~stairway enclosures~~] stairways shall be separated by a distance not less than 30 feet
27 (9144 mm) or not less than ¼ [~~one-fourth~~] of the length of the maximum overall diagonal
28 dimension of the building or area to be served, whichever is less. The distance shall be measured
29 in a straight line between the nearest points of the enclosure surrounding the interior exit [~~stairway~~
30 ~~enclosures~~] stairways. In buildings with three or more interior exit [~~stairway enclosures, at least~~]
31 stairways, no fewer than two of the interior exit [~~stairway enclosures~~] stairways shall comply with
32 this section. Stairs sharing any common wall, floors, ceilings, scissor stair assemblies, or other
33 enclosures shall be counted as one interior exit stairway.

34 **Exception:** Group R-2 occupancies.

35 **403.5.2 Additional exit stairway.** For buildings other than Group R-2 that are more than 420 feet
36 (128 m) in building height, one additional exit stairway meeting the requirements of Sections
37 [~~1009~~] 1011 and [~~1022~~] 1023 shall be provided in addition to the minimum number of exits

1 required by Section [4024.4] 1006.3. The total width of any combination of remaining exit
2 stairways with one exit stairway removed shall not be less than the total width required by Section
3 1005.1. Stairs sharing any common wall, floors, ceilings, scissor stair assemblies, or other
4 enclosures shall not be considered the additional exit stairway required by this section.

5 **Exceptions:** An additional exit stairway shall not be required to be installed in any of the
6 following instances:

7 1. In buildings where all passenger elevators for general public use and all other elevators
8 used for occupant self-evacuation comply with Sections 3008.1 through 3008.11;

9 2. In buildings where all of the following conditions are met:

10 2.1. The commissioner has approved a timed egress analysis establishing the egress
11 time it would take for a full building evacuation, utilizing the stairs required
12 by Section [4024.4] 1006 and the additional stair that would have been required
13 pursuant to Section 403.5.2;

14 2.2. The commissioner has approved a timed egress analysis establishing the egress
15 time it would take for a full building evacuation, utilizing the combination of
16 the stairs required by Section [4024.4] 1006 and elevators used for occupant
17 self-evacuation as follows:

18 2.2.1. Such analysis need only utilize a number of designated elevators
19 designed for occupant self-evacuation necessary to demonstrate an
20 evacuation time that is less than the time established in Exception 2.1;
21 and

22 2.2.2. Every bank of passenger elevators for general public use shall be served
23 by at least one such designated elevator;

24 2.3. All elevators in the building that either are passenger elevators for general
25 public use or are used for occupant self-evacuation shall comply with Sections
26 3008.1 through 3008.11. However, the standby power generating equipment
27 required by Section 3008.9 need only be sized to satisfy the loads required to
28 simultaneously operate those elevators identified in the timed egress analysis
29 described in Exception 2.2.

30 The minimum number of exits required by Section [4024.4] 1006 are all at least
31 25 percent wider than the exit width required by Chapter 10. The increase in the stair
32 width shall not be utilized in the timed egress analyses required by Exceptions 2.1 and
33 2.2[; or].

34 [~~3. Where the application for construction document approval is submitted within 18~~
35 ~~months after the date of enactment of the local law that added this section.]~~

36 **403.5.3 Stairway door operation.** Doors opening into interior stair enclosures shall not be locked
37 from either side. However, a door locked from the stair side may be permitted provided that such

1 door is equipped with an automatic fail safe system for opening in the event of the activation of
2 any automatic fire detection system, or when any elevator recall is activated, or when any signal
3 is received from the fire command center. Such door shall be deemed as openable from the stair
4 side. Stair reentry signs shall be posted throughout the stairway indicating that reentry is provided
5 only during fire emergencies. Such signs shall be in accordance with Section [~~1030.4.2~~] 1031.4.2.

6 **Exception:** In schools classified as Group E occupancies that require “lockdown drills” as per
7 Section 807 of the New York State Education Law, stairway egress doors from occupied
8 spaces are permitted to be locked from the side opposite the egress side for the duration of the
9 lockdown drill, provided they are openable from the occupied side for egress and are unlocked
10 upon directions from the school administrative personnel following the completion of the
11 lockdown drill.

12 **403.5.3.1 Stairway communication system.** A telephone or other two-way communications
13 system connected to an approved constantly attended station shall be provided at not less than
14 every fifth floor in each stairway where the doors to the stairway are locked in accordance
15 with Section 403.5.3.

16 **403.5.4 Smokeproof [exit] enclosures.** Every required interior exit stairway serving floors more
17 than 75 feet (22 860 mm) above the lowest level of fire department vehicle access shall comply
18 with Sections 909.20 and [~~1022.9~~] 1023.11.

19 **Exception [~~for R-2 occupancies~~]:** Smokeproof enclosures are not required in occupancy
20 Group R-2 unless provided pursuant to Exception 2 of Section [~~916.1~~] 917.1.

21 **403.5.5 Luminous egress path markings.** Luminous egress path markings shall be provided in
22 accordance with Section [~~1024~~] 1025 and Appendix S.

23 **Exception:** Egress paths serving Group R-2.

24 **403.5.6 Emergency escape and rescue.** Emergency escape and rescue openings [~~required by~~]
25 specified in Section [~~1029~~] 1030 are not required.

26 **403.6 Elevators.** Elevator [~~operation and~~] installation and operation in high-rise buildings shall [~~be~~
27 ~~in accordance~~] comply with Chapter 30 and Sections 403.6.1 and 403.6.2.

28 **403.6.1 Fire service access elevator.** In buildings with an occupied floor more than 120 feet (36
29 576 mm) above the lowest level of fire department vehicle access, a minimum of one fire service
30 access elevator shall be provided in accordance with Section 3007.

31 **403.6.2 Occupant evacuation elevators.** Where installed in accordance with Section 3008,
32 passenger elevators for general public use shall be permitted to be used for occupant self-
33 evacuation.

34 **403.6.3 Elevator lobbies.** Elevator lobbies shall be provided in accordance with Sections
35 [~~708.14.1 and 708.14.2~~] 3006.1.1 and 3006.1.2.

1 **403.7 Outdoor air intakes.** For high-rise buildings, outdoor air intakes serving spaces above the
2 second story and serving spaces greater than 10,000 square feet (929 m²) of floor area shall be located
3 in accordance with Section 401.5 of the *New York City Mechanical Code*.

4 **Exception:** Group R-2 occupancy.

5 **403.8 Open web steel joists.** The use of open web steel joists shall be prohibited in high-rise
6 buildings until the commissioner promulgates rules establishing minimum acceptable fireproofing
7 methods.

8 **SECTION BC 404**
9 **ATRIUMS**

10 **404.1 General.** In other than Group H occupancies, and where permitted by [~~Exception 5 in~~] Section
11 [~~708.2~~] 712.1.7, the provisions of [~~this section~~] Sections 404.1 through 404.10 shall apply to buildings
12 or structures containing vertical openings defined [~~herein~~] as [~~atriums.~~]“atriums.”

13 **404.1.1 [Definition] Definitions.** The following [~~word and~~] term [~~shall, for the purposes of this~~
14 ~~chapter and as used elsewhere in this code, have the meaning shown herein.~~] is defined in Chapter
15 2:

16 **ATRIUM.** [~~An opening connecting three or more stories other than enclosed stairways, elevators,~~
17 ~~hoistways, escalators, plumbing, electrical, air conditioning or any other vertical openings that~~
18 ~~are not required to be enclosed by other provisions of this code, which is closed at the top and~~
19 ~~not defined as a mall. Stories, as used in this definition, do not include balconies within assembly~~
20 ~~groups or mezzanines that comply with Section 505.]~~

21 **404.2 Use.** The floor of the atrium shall not be used for other than low fire hazard uses[;] and only
22 approved materials and decorations in accordance with the *New York City Fire Code* shall be used in
23 the atrium space.

24 **Exception:** The atrium floor area is permitted to be used for any approved use where the
25 individual space is provided with an automatic sprinkler system in accordance with Section
26 903.3.1.1.

27 **404.3 Automatic sprinkler protection.** An approved automatic sprinkler system shall be installed
28 throughout the entire building.

29 **Exceptions:**

- 30 1. That area of a building adjacent to or above the atrium need not be sprinklered provided
31 that portion of the building is separated from the atrium portion by not less than 2-hour
32 fire barriers constructed in accordance with Section 707 or horizontal assemblies
33 constructed in accordance with Section [~~712~~] 711, or both.
- 34 2. Where the ceiling of the atrium is more than 55 feet (16 764 mm) above the floor, sprinkler
35 protection at the ceiling of the atrium is not required.

36 **404.4 Fire alarm system.** A fire alarm system shall be provided in accordance with Section 907.2.14.

1 **404.5 Smoke control.** A smoke control system shall be installed in accordance with Section 909.

2 **Exception:** In other than Groups I-1 and I-2, and covered mall buildings containing an atrium
3 pursuant to Section 402.7.2, smoke control is not required for atriums that connect only two
4 stories.

5 **404.6 Enclosure of atriums.** Atrium spaces shall be separated from adjacent spaces by a 1-hour fire
6 barrier constructed in accordance with Section 707 or a horizontal assembly constructed in accordance
7 with Section ~~[712]~~ 711, or both.

8 **Exceptions:**

9 1. A fire barrier is not required where a glass or glass-block wall forming a smoke partition
10 [~~where automatic~~] is provided. The glass or glass-block wall shall comply with all of the
11 following:

12 1.1. Automatic sprinklers are [~~spaced 6 feet (1829 mm) or less~~] provided along both
13 sides of the separation wall and doors, or on the room side only if there is not a
14 walkway on the atrium side[~~, and~~]. The sprinklers shall be located between 4 inches
15 and 12 inches (102 mm and 305 mm) away from the glass and [~~so~~] at intervals along
16 the glass not greater than 6 feet (1829 mm). The sprinkler system shall be designed
17 so that the entire surface of the glass is wet upon activation of the sprinkler system
18 without obstruction[~~. The glass shall be installed in a gasketed frame so that the~~
19 framing system deflects without breaking (loading) the glass before the sprinkler
20 system operates.];

21 1.2. The glass wall shall be installed in a gasketed frame in a manner that the framing
22 system deflects without breaking (loading) the glass before the sprinkler system
23 operates; and

24 1.3. Where glass doors are provided in the glass wall, they shall be either self-closing or
25 automatic-closing.

26 2. The adjacent spaces of any three floors of the atrium shall not be required to be separated
27 from the atrium where such spaces are accounted for in the design of the smoke control
28 system.

29 **404.7 Standby power.** Equipment required to provide smoke control shall be [~~connected to a~~]
30 provided with standby power [~~system~~] in accordance with Section 909.11.

31 **404.8 Interior finish.** The interior finish of walls and ceilings of the atrium shall be not [~~be~~] less than
32 Class B with no reduction in class for sprinkler protection.

33 ~~**404.9 [Travel distance.** In other than the lowest level of the atrium, where the required means of~~
34 ~~egress is through the atrium space, the portion of exit access travel distance within the atrium space~~
35 ~~shall not exceed 200 feet (60 960 mm). The travel distance requirements for areas of buildings open~~
36 ~~to the atrium and where access to the exits is not through the atrium, shall comply with the~~

1 ~~requirements of Section 1016.]~~ **Exit access travel distance.** Exit access travel distance for areas
2 open to an atrium shall comply with the requirements of this section.

3 **404.9.1 Egress not through the atrium.** Where required access to the exits is not through the
4 atrium, exit access travel distance shall comply with Section 1017.

5 **404.9.2 Exit access travel distance at the level of exit discharge.** Where the path of egress travel
6 is through an atrium space, exit access travel distance at the level of exit discharge shall be
7 determined in accordance with Section 1017.

8 **404.9.3 Exit access travel distance at other than the level of exit discharge.** Where the path of
9 egress travel is not at the level of exit discharge from the atrium, that portion of the total permitted
10 exit access travel distance that occurs within the atrium shall be not greater than 200 feet (60 960
11 mm).

12 **404.10 Interior exit stairways.** A maximum of 50 percent of interior exit stairways are permitted to
13 egress through an atrium on the level of exit discharge in accordance with Section 1028.

14 **SECTION BC 405**
15 **UNDERGROUND BUILDINGS AND SPACES**

16 **405.1 General.** The provisions of [~~this section~~] Sections 405.2 through 405.9 apply to building spaces
17 having a floor level used for human occupancy more than 30 feet (9144 mm) below the finished floor
18 of the lowest level of exit discharge.

19 **Exceptions:** The provisions of Section 405 are not applicable to the following buildings or
20 portions of buildings:

- 21 1. One- and two-family dwellings, sprinklered in accordance with Section 903.3.1.3.
- 22 2. Parking garages provided with automatic sprinkler systems in compliance with Section
23 405.3.
- 24 3. Fixed guideway transit systems.
- 25 4. Grandstands, bleachers, stadiums, arenas and similar facilities.
- 26 5. Where the lowest story is the only story that would qualify the building as an underground
27 building and has an area not [~~exceeding~~] greater than 1,500 square feet (139 m²) and has
28 an occupant load less than 10.
- 29 6. Pumping stations and other similar mechanical spaces intended only for limited periodic
30 use by service or maintenance personnel.

31 **405.2 Construction requirements.** The underground portion of the building shall be of Type I
32 construction.

33 **405.3 Automatic sprinkler system.** The highest level of exit discharge serving the underground
34 portions of the building and all levels below shall be equipped with an automatic sprinkler system

1 installed in accordance with Section 903.3.1.1. Water-flow switches and control valves shall be
2 supervised in accordance with Section 903.4.

3 **405.4 Compartmentation.** Compartmentation shall be in accordance with Sections 405.4.1 through
4 405.4.3.

5 **405.4.1 Number of compartments.** A building having a floor level more than 60 feet (18 288
6 mm) below the finished floor of the lowest level of exit discharge shall be divided into [~~a~~
7 ~~minimum—of~~] no fewer than two compartments of approximately equal size. Such
8 compartmentation shall extend through the highest level of exit discharge serving the underground
9 portions of the building and all levels below.

10 **Exception:** The lowest story need not be compartmented where the area [~~does~~] is not [~~exceed~~]
11 greater than 1,500 square feet (139 m²) and has an occupant load of less than 10.

12 **405.4.2 Compartment separation.** The separation between the two compartments shall be of
13 minimum 2-hour fire barrier wall construction that shall extend from floor slab to floor deck
14 above. Penetrations between the two compartments shall be limited to plumbing and electrical
15 piping and conduit that are firestopped in accordance with Section [~~713~~] 714. Doorways shall be
16 protected by fire door assemblies that are automatic-closing by smoke detection in accordance
17 with Section [~~715.4.8.3~~] 716.5.9.3 and are installed in accordance with NFPA 105 and Section
18 [~~715.4.3~~] 716.5.3 of this code. Where provided, each compartment shall have an air supply and
19 an exhaust system independent of the other compartments.

20 **405.4.3 Elevators.** Where elevators are provided, each compartment shall have direct access to
21 an elevator. Where an elevator serves more than one compartment, an elevator lobby shall be
22 provided and shall be separated from each compartment by a 2-hour fire barrier. Doors shall be
23 gasketed, have a drop sill, and be automatic-closing by smoke detection [~~installed~~] in accordance
24 with Section [~~715.4.8.3~~] 716.5.9.3.

25 **405.5 Smoke control system.** A smoke control system shall be provided in accordance with Sections
26 405.5.1 and 405.5.2.

27 **405.5.1 Control system.** A smoke control system is required to control the migration of products
28 of combustion in accordance with Section 909 and the provisions of this section. Smoke control
29 shall restrict movement of smoke to the general area of fire origin and maintain means of egress
30 in a usable condition.

31 **405.5.2 Compartment smoke control system.** Where compartmentation is required, each
32 compartment shall have an independent smoke control system. The system shall be automatically
33 activated and capable of manual operation in accordance with Sections 907.2.18 and 907.2.19.

34 **405.6 Fire alarm systems.** A fire alarm system shall be provided where required by Sections 907.2.18
35 and 907.2.19.

36 **405.7 Means of egress.** Means of egress shall be in accordance with Sections 405.7.1 and 405.7.2.

1 **405.7.1 Number of exits.** Each floor level shall be provided with [~~a minimum of~~] no fewer than
2 two exits. Where compartmentation is required by Section 405.4, each compartment shall have [~~a~~
3 ~~minimum of~~] no fewer than one exit and shall also have [~~an~~] no fewer than one exit access
4 doorway into the adjoining compartment.

5 **405.7.2 Smokeproof enclosure.** Every required stairway serving floor levels more than 30 feet
6 (9144 mm) below its level of exit discharge shall comply with the requirements for a smokeproof
7 enclosure as provided in Section [~~4022.9~~] 1023.11.

8 **405.8 Standby and emergency power.** A standby power system complying with Section 2702 shall
9 be provided for the standby power loads specified in Section 405.8.1. An emergency power system
10 complying with Section 2702 shall be provided for the emergency power loads specified in Section
11 405.8.2.

12 **405.8.1 Standby power loads.** The following loads are classified as standby power loads:

- 13 1. Smoke control system[;].
- 14 2. Ventilation and automatic fire detection equipment for smokeproof enclosures[;].
- 15 3. Fire pumps[;].
- 16 4. Elevators, as required in [~~accordance with~~] Section 3003; and
- 17 5. Stair pressurization systems when provided.

18 [~~405.9 Emergency power. An emergency power system complying with Section 2702 shall be~~
19 ~~provided for emergency power loads specified in Section 405.9.1.~~]

20 [~~405.9.1~~] **405.8.2 Emergency power loads.** The following loads are classified as emergency
21 power loads:

- 22 1. Emergency voice/alarm communications systems, including Fire Department in-building
23 Auxiliary Radio Communication systems (ARCs) provided where required or installed
24 voluntarily in accordance with Section [~~917~~] 916;
- 25 2. Fire alarm systems;
- 26 3. Automatic fire detection systems;
- 27 4. Elevator car lighting; and
- 28 5. Means of egress and exit sign illumination as required by Chapter 10.

29 [~~405.10~~] **405.9 Standpipe system.** The underground building shall be [~~provided~~] equipped
30 throughout with a standpipe system in accordance with Section 905.

1 SECTION BC 406
2 MOTOR-VEHICLE-RELATED OCCUPANCIES

3 ~~406.1 [Private garages and carports.]~~ General. Motor-vehicle-related occupancies shall comply
4 with Sections 406.1 through 406.8.

5 406.2 Definitions. The following terms are defined in Chapter 2:

6 CARPORT.

7 MECHANICAL-ACCESS OPEN PARKING GARAGE.

8 OPEN PARKING GARAGE.

9 PRIVATE GARAGE.

10 RAMP-ACCESS OPEN PARKING GARAGE.

11 406.3 Private garages and carports. Private garages and carports shall comply with Sections 406.3.1
12 through 406.3.5.

13 [~~406.1.1~~] 406.3.1 Classification. Private garages and carports[~~, as defined by this section,~~] shall
14 be classified as Group U occupancy.

15 [~~406.1.2 Definitions.~~ The following words and terms shall, for the purposes of this chapter and
16 as used elsewhere in this code, have the meanings shown herein.]

17 [~~CARPORT.~~ A structure or portion of a structure, accessory to a Group R-2 or R-3 occupancy,
18 open on at least two sides and unenclosed for at least 50 percent of perimeter, used for the parking
19 or storage of passenger motor vehicles. Such facility shall not exceed 650 square feet (60.45 m²)
20 in area and one story in height.]

21 [~~PRIVATE GARAGE.~~ An enclosed structure or portion of a structure, accessory to a Group R-
22 2 or R-3 occupancy, used for the parking or storage of passenger motor vehicles. Such facility
23 shall not exceed 650 square feet (60 m²) in area and one story in height.]

24 406.3.2 Clear height. In private garages and carports, the clear height in vehicle and pedestrian
25 traffic areas shall be not less than 7 feet (2134 mm). Vehicle and pedestrian areas accommodating
26 van-accessible parking shall comply with Section 1106.5.

27 [~~406.1.3~~] 406.3.3 Floor construction. Private garage and carport floors shall be of concrete or
28 equivalent noncombustible material that will not absorb flammable liquids. The area of floor
29 used for parking of vehicles shall be sloped to facilitate the movement of liquids to a drain. The
30 sills of all door openings connecting a dwelling unit to a private garage shall be raised at least 4
31 inches (102 mm) above the floor level of the garage.

32 **Exception:** Asphalt surfaces shall be permitted at ground level in carports.

1 **[406.1.3.1] 406.3.3.1 Ramps.** Ramps shall have a gradient not exceeding one in seven, with
2 nonslip surfaces, and shall be located entirely within the property line. However, upon
3 application to the commissioner, steeper gradients may be accepted, but in no event greater
4 than one in three.

5 **[406.1.4] 406.3.4 Separation.** Separations shall comply with the following:

- 6 1. The private garage shall be separated from the dwelling unit and its attic area by means
7 of a minimum 1-hour fire-rated construction. Garages beneath habitable rooms shall be
8 separated from all habitable rooms above by not less than 1-hour fire-rated construction.
9 Openings from a private garage directly into a room used for sleeping purposes shall not
10 be permitted.
- 11 2. No air used for heating, cooling or ventilation shall be circulated through private
12 garages to dwelling areas.
- 13 3. A separation is not required between a Group R-3 occupancy and a carport, provided the
14 carport does not have any enclosed areas above.
- 15 4. For free standing private garages where the fire separation distance from the nearest
16 exterior wall is less than 5 feet (1524 mm), such exterior walls shall have a fire-resistance
17 rating not less than one hour.

18 **[406.1.5] 406.3.5 Automatic garage door openers.** Automatic garage door openers, ~~[if]~~ where
19 provided, shall be listed in accordance with UL 325.

20 **[406.2 Parking garages, open or enclosed] 406.4 Public parking garages.**

21 ~~[406.2.1 Classification.]~~ Parking garages, other than private parking garages, shall be classified as
22 public parking garages and shall comply with the provisions of Sections 406.4.2 through 406.4.10
23 and shall be classified as either an open parking garage [as per Section 406.3,] or an enclosed [as
24 per Section 406.4] parking garage. Open parking garages shall also comply with Section 406.5.
25 Enclosed parking garages shall also comply with Section 406.6. [Parking garages shall also comply
26 with the special provisions of] See Section 510 for special provisions for parking garages.

27 **[406.2.2] 406.4.1 Clear height.** The clear height of each floor level in vehicle and pedestrian
28 traffic areas shall be not ~~[be]~~ less than 7 feet (2134 mm). Vehicle and pedestrian areas
29 accommodating van-accessible parking ~~[required by Section 1106.5]~~ shall ~~[conform to ICC~~
30 ~~A117.1]~~ comply with Section 1106.5.

31 **[406.2.3] 406.4.2 Guards.** Guards shall be provided in accordance with Section ~~[1013]~~ 1015.
32 Guards serving as vehicle barrier systems shall comply with Sections ~~[406.2.4]~~ 406.4.3 and ~~[1013]~~
33 1015.

34 **[406.2.4] 406.4.3 Vehicle barrier systems.** Vehicle ~~[barrier systems]~~ barriers not less than 2 feet
35 9 inches (835 mm) ~~[high]~~ in height shall be placed ~~[at the end of drive lanes and at the end of~~
36 ~~parking spaces]~~ where the vertical distance from the floor of a drive lane or parking space to the

1 ground or surface directly below is greater than 1 foot (305 mm). Vehicle [~~barrier systems~~]
2 barriers shall comply with the loading requirements of Section [~~1607.7.3~~] 1607.9.

3 **Exception:** Vehicle barriers are not required in vehicle storage compartments in a mechanical
4 access parking garage.

5 [~~406.2.5~~] **406.4.4 Ramps.** Ramps shall have a gradient not exceeding one in seven, with nonslip
6 surfaces. A level landing having a minimum dimension of 20 feet (6096 mm) shall be provided
7 at the discharge point of all ramps at the street level, within the property line. Ramps used for the
8 movement of motor vehicles need not be enclosed when serving tiers above grade. Vehicle ramps
9 may serve as part of a means of egress [~~provided that such ramp complies with the requirements~~
10 ~~of Sections 1018.1.1 and 1018.1.2~~] in accordance with Section 1006.4.

11 [~~406.2.6~~] **406.4.5 Floor surface.** Parking surfaces shall be of concrete or similar noncombustible
12 and nonabsorbent materials.

13 The area of floor used for parking of vehicles shall be sloped to facilitate the movement of
14 liquids to a drain.

15 **Exceptions:**

- 16 1. Asphalt parking surfaces [~~are~~] shall be permitted at ground level.
- 17 2. Floors of Group S-2 parking garages shall not be required to have a sloped surface.

18 [~~406.2.7~~] **406.4.6 Separation.** Parking garages shall be separated from other occupancies in
19 accordance with Section [~~510~~] 508.1.

20 [~~406.2.8~~] **406.4.7 Special hazards.** [~~Openings from a parking garage to~~] Connection of a parking
21 garage with any room in which there is a fuel-fired appliance shall be by means of a vestibule
22 providing a two-doorway separation. Such vestibule and doorway shall be minimum 1-hour rated
23 construction.

24 **Exception:** A single door [~~, in compliance with Table 715.4,~~] shall be [~~permitted,~~] allowed
25 provided the sources of ignition in the appliance are [~~at least~~] not less than 18 inches (457
26 mm) above the floor.

27 [~~406.2.9~~] **406.4.8 Attached to rooms.** Openings from a parking garage directly into a room used
28 for sleeping purposes shall not be permitted.

29 [~~406.2.10~~] **406.4.9 Fire-fighter aisles.** In any parking garage or lot, one or more aisles, at least
30 24 inches (610 mm) in width, shall be provided to permit access by fire-fighting personnel to all
31 parts of the garage or lot. There shall not be more than three rows of parked motor vehicles
32 between aisles.

33 [~~406.2.11~~] **406.4.10 Electric vehicle charging stations.** Parking garages shall be capable of
34 supporting electrical vehicle charging stations in accordance with this section. Electrical raceway
35 to the electrical supply panel serving the garage shall be capable of providing a minimum of 3.1
36 kW of electrical capacity to at least 20 percent of the parking spaces of the garage. The electrical

1 room supplying the garage must have the physical space for an electrical supply panel sufficient
2 to provide 3.1kW of electrical capacity to at least 20 percent of the parking spaces of the garage.
3 Such raceway and all components and work appurtenant thereto shall be in accordance with the
4 *New York City Electrical Code*.

5 **Exceptions:**

- 6 1. The provisions of this section shall not apply to parking garages for buildings of
7 Occupancy Group M (Mercantile).
- 8 2. The commissioner may waive compliance with this section if the commissioner
9 determines that the parking garage is a temporary facility that will be in service no
10 longer than [3] three years.
- 11 3. The provisions of this section shall not apply to parking garages for buildings in which
12 not less than [fifty] 50 percent of the residential units are for households earning up to
13 [sixty] 60 percent of the area median income as determined by the United States
14 Department of Housing and Urban Development.

15 **[406.3] 406.5 Open parking garages.** Open parking garages shall comply with Sections 406.5.1
16 through 406.5.11.

17 ~~[406.3.1 Scope. Except where specific provisions are made in Sections 406.3.2 through 406.3.13,~~
18 ~~other requirements of this code shall apply.]~~

19 ~~[406.3.2 Definitions. The following words and terms shall, for the purposes of this chapter and~~
20 ~~as used elsewhere in this code, have the meanings shown herein.]~~

21 ~~[MECHANICAL ACCESS OPEN PARKING GARAGES. Open parking garages employing~~
22 ~~parking machines, lifts, elevators or other mechanical devices for vehicles moving from and to~~
23 ~~street level and in which public occupancy is prohibited above the street level.]~~

24 ~~[OPEN PARKING GARAGE. A structure or portion of a structure with the openings as~~
25 ~~described in Section 406.3.3.1 that is used for the parking or storage of private motor vehicles as~~
26 ~~described in Section 406.3.4.]~~

27 ~~[RAMP ACCESS OPEN PARKING GARAGES. Open parking garages employing a series of~~
28 ~~continuously rising floors or a series of interconnecting ramps between floors permitting the~~
29 ~~movement of vehicles under their own power from and to the street level.]~~

30 **[406.3.3] 406.5.1 Construction.** Open parking garages shall be of Type I, II or IV construction.
31 Open parking garages shall meet the design requirements of Chapter 16. For vehicle [~~barrier~~
32 ~~systems~~] barriers, see Section [406.2.4] 406.4.3.

33 **[406.3.3.1] 406.5.2 Openings.** For natural ventilation purposes, the exterior side of the structure
34 shall have uniformly distributed openings on two or more sides. The area of such openings in
35 exterior walls on a tier [~~must~~] shall be [~~at least~~] not less than 20 percent of the total perimeter wall
36 area of each tier. The aggregate length of the openings considered to be providing natural

1 ventilation shall ~~constitute a minimum of~~ be not less than 40 percent of the perimeter of the tier.
 2 Interior walls shall be ~~at least~~ not less than 20 percent open with uniformly distributed openings.

3 **Exception:** Openings are not required to be distributed over 40 percent of the building
 4 perimeter where the required openings are uniformly distributed over two opposing sides of
 5 the building.

6 **406.5.2.1 Openings below grade.** Where openings below grade provide required natural
 7 ventilation, the outside horizontal clear space shall be 1 ½ times the depth of the opening. The
 8 width of the horizontal clear space shall be maintained from grade down to the bottom of the
 9 lowest required opening.

10 **[406.3.4] 406.5.3 Uses.** Mixed uses shall be allowed in the same building as an open parking
 11 garage subject to the provisions of Sections ~~402.7.1~~ 402.4.2.3, ~~406.3.13~~ 406.5.11, 508.1,
 12 510.3, 510.4[~~7~~] and 510.7.

13 **[406.3.5] 406.5.4 Area and height.** Area and height of open parking garages shall be limited as
 14 set forth in Chapter 5 for Group S-2 occupancies.

15 **TABLE [406.3.5] 406.5.4**
 16 **OPEN PARKING GARAGES AREA AND HEIGHT**

TYPE OF CONSTRUCTION	AREA PER TIER (square feet)	HEIGHT (in tiers)		
		Ramp access	Mechanical access	
			Automatic sprinkler system	
			No	Yes
IA	Unlimited	Unlimited	Unlimited	Unlimited
IB	Unlimited	12 tiers	12 tiers	18 tiers
IIA	50,000	10 tiers	10 tiers	15 tiers
IIB	50,000	8 tiers	8 tiers	12 tiers
IV	50,000	4 tiers	4 tiers	4 tiers

17 For SI: 1 square foot = 0.0929 m².

18
 19 **[406.3.5.1] 406.5.4.1 Single use.** ~~When~~ Where the open parking garage is used exclusively
 20 for the parking or storage of private motor vehicles, with no other uses in the building, the
 21 area and height shall be permitted to comply with Table ~~406.3.5~~ 406.5.4.

22 **Exception:** The grade-level tier is permitted to contain an office, waiting and toilet rooms
 23 having a total combined area of not more than 1,000 square feet (93 m²). Such area need
 24 not be separated from the open parking garage.

25 In open parking garages having a spiral or sloping floor, the horizontal projection of the
 26 structure at any cross section shall not exceed the allowable area per parking tier. In the case
 27 of an open parking garage having a continuous spiral floor, each 9 feet 6 inches (2896 mm)
 28 of height, or portion thereof, shall be considered a tier.

29 The clear height of a parking tier shall be not ~~be~~ less than 7 feet (2134 mm), except that
 30 a lower clear height is permitted in mechanical-access open parking garages where approved
 31 by the commissioner.

1 **[406.3.6] 406.5.5 Area and height increases.** The allowable area and height of open parking
2 garages shall be increased in accordance with the provisions of this section. Garages with sides
3 open on three-fourths of the building's perimeter are permitted to be increased by 25 percent in
4 area and one tier in height. Garages with sides open around the entire building's perimeter are
5 permitted to be increased by 50 percent in area and one tier in height. For a side to be considered
6 open under the above provisions, the total area of openings along the side shall not be less than
7 50 percent of the interior area of the side at each tier and such openings shall be equally distributed
8 along the length of the tier. For purposes of calculating the interior area of the side, the height
9 shall not exceed 7 feet (2134 mm).

10 Allowable tier areas in Table ~~[406.3.5]~~ **406.5.4** shall be increased for open parking garages
11 constructed to heights less than the table maximum. The gross tier area of the garage shall not
12 exceed that permitted for the higher structure. ~~[At least]~~ No fewer than three sides of each such
13 larger tier shall have continuous horizontal openings not less than 30 inches (762 mm) in clear
14 height extending for ~~[at least]~~ not less than 80 percent of the length of the sides and no part of
15 such larger tier shall be more than 200 feet (60 960 mm) horizontally from such an opening. In
16 addition, each such opening shall face a street or yard accessible to a street with a width of ~~[at~~
17 ~~least]~~ not less than 30 feet (9144 mm) for the full length of the opening, and standpipes shall be
18 provided in each such tier.

19 Open parking garages of Type II construction, with all sides open, shall be unlimited in
20 allowable area where the building height does not exceed 75 feet (22 860 mm). For a side to be
21 considered open, the total area of openings along the side shall be not ~~[be]~~ less than 50 percent of
22 the interior area of the side at each tier and such openings shall be equally distributed along the
23 length of the tier. For purposes of calculating the interior area of the side, the height shall not
24 exceed 7 feet (2134 mm). All portions of tiers shall be within 200 feet (60 960 mm) horizontally
25 from such openings or other natural ventilation openings as defined in Section ~~[406.3.3.1]~~ **406.5.2**.
26 These openings shall be permitted to be provided in courts with a minimum dimension of 20 feet
27 (6096 mm) for the full width of the openings.

28 **[406.3.7] 406.5.6 Fire separation distance.** Exterior walls and openings in exterior walls shall
29 comply with Tables 601 and 602. The distance from an adjacent property line shall be determined
30 in accordance with Table 602 and Section 705.

31 **[406.3.8] 406.5.7 Means of egress.** Open parking garages shall meet the means of egress
32 requirements of Chapter 10. However, where no persons other than parking attendants are
33 permitted, required exit stairways shall not be less than 36 inches (914 mm) wide.

34 **[406.3.9] 406.5.8 Standpipes.** Standpipes shall be installed where required by the provisions of
35 Section 905.

36 ~~**[406.3.10 Sprinkler systems.** Automatic sprinkler systems and standpipes shall be installed in~~
37 ~~accordance with the provisions of Section 903. An automatic dry sprinkler system may be~~
38 ~~installed in unheated garages.]~~

39 **[406.3.11] 406.5.9 Enclosure of vertical openings.** Enclosure shall not be required for vertical
40 openings.

1 ~~[406.3.12]~~ **406.5.10 Ventilation.** Openings specified in Section ~~[406.3.3.1]~~ 406.5.2 shall satisfy
2 natural ventilation requirements. Additional mechanical ventilation shall not be required.

3 ~~[406.3.13]~~ **406.5.11 Prohibitions.** The following uses and alterations are not permitted:

- 4 1. Vehicle repair work.
- 5 2. Parking of commercial vehicles, buses, trucks and similar vehicles.
- 6 3. Partial or complete closing of required openings in exterior walls by tarpaulins or any
7 other means.
- 8 4. Dispensing of fuel.

9 ~~[406.4]~~ **406.6 Enclosed parking garages.** Parking garages and portions thereof that do not meet the
10 definition of “Open parking garages” shall be classified as an enclosed parking garage and shall meet
11 the requirements of this section.

12 ~~[406.4.1]~~ **406.6.1 Heights and areas.** Enclosed parking garages shall be limited to the allowable
13 heights and areas specified in ~~[Table 503 as modified by Sections 504, 506, and 507]~~ Chapter 5.
14 Permitted roof parking shall not be considered as a separate story.

15 ~~[406.4.2]~~ **406.6.2 Ventilation.** A mechanical ventilation system shall be provided in accordance
16 with the *New York City Mechanical Code*.

17 **406.6.3 Automatic sprinkler system.** Automatic sprinkler systems and standpipes shall be
18 installed in accordance with the provisions of Section 903. An automatic dry sprinkler system
19 may be installed in unheated garages.

20 **406.6.4 Means of egress.** Enclosed parking garages shall meet the means of egress requirements
21 of Chapter 10.

22 ~~[406.5]~~ **406.7 Motor fuel-dispensing facilities.**

23 ~~[406.5.1 Construction.]~~ Motor fuel-dispensing facilities shall be designed and constructed in
24 accordance with the *New York City Fire Code* and Sections ~~[406.5.1]~~ 406.7.1 through ~~[406.5.3]~~
25 406.7.3 of this code.

26 ~~[406.5.2]~~ **406.7.1 Vehicle fueling pad.** The vehicle shall be fueled on noncoated concrete or other
27 approved paving material having a resistance not exceeding 1 megohm as determined by the
28 methodology in ~~[EN]~~ CEN 1081.

29 ~~[406.5.3]~~ **406.7.2 Canopies.** Canopies under which fuels are dispensed shall have a clear,
30 unobstructed height of not less than 14 feet (4267 mm) to the lowest projecting element in the
31 vehicle drive-through area. Canopies and their supports over pumps shall be of noncombustible
32 materials. However, panels constructed of light-transmitting plastic materials shall be permitted
33 to be installed in canopies erected over motor vehicle fuel-dispensing station fuel dispensers,
34 provided the panels are located ~~[at least]~~ not less than 10 feet (3048 mm) from any building on
35 the same property and face yards or streets not less than 40 feet (12 192 mm) in width on the other

1 sides. The aggregate areas of plastics shall be not [exceed] greater than 1,000 square feet (93 m²).
2 The maximum area of any individual panel shall be not [exceed] greater than 100 square feet (9.3
3 m²).

4 **[406.5.3.1] 406.7.2.1 Canopies used to support gaseous hydrogen systems.** Where
5 flammable compressed gases are permitted by the *New York City Fire Code* to be located
6 on the roof of a canopy that is used to shelter dispensing operations, such canopy shall be
7 in accordance with the following:

- 8 1. The canopy shall meet or exceed Type I construction requirements.
- 9 2. Operations located under canopies shall be limited to refueling only.
- 10 3. The canopy shall be constructed in a manner that prevents the accumulation of
11 hydrogen gas.

12 **[406.5.4] 406.7.3 Storage tanks.** Motor fuel storage tanks shall be installed below ground, except
13 as authorized by the rules of the Fire Department. The installation and venting of storage tanks
14 shall be in accordance with the rules of the Fire Department and the requirements of the *New*
15 *York City Fire Code*. Storage tanks installed below ground shall comply with the following:

- 16 1. The top of the storage tanks shall be at least 24 inches (610 mm) below finished grade
17 and at least 24 inches (610 mm) below the level of any cellar or basement floor within 10
18 feet (3048 mm) of the tanks.
- 19 2. Storage tanks shall be located so that the forces from any building foundation and support
20 loads are not transmitted to the tanks. The distance from any part of a storage tank to the
21 nearest wall of any basement, pit or cellar, or from any property line that may be built
22 upon, shall not be less than 36 inches (914 mm).
- 23 3. Storage tanks shall be covered with a structurally supported reinforced concrete slab at
24 least 8 inches (203 mm) thick, extending at least 12 inches (305 mm) beyond the
25 horizontal outlines of the storage tanks, and placed over a cover of suitable clean backfill
26 material. Such slab shall be designed and reinforced in accordance with ACI 318. All
27 concrete shall have a minimum compressive strength of 4,000 pounds per square inch (27
28 580 kPa) at 28 days.
- 29 4. Storage tanks shall be placed on a 12-inch (305 mm) thick concrete base slab or installed
30 in such other manner, secured against flotation, and approved by the department.

31 **[406.6] 406.8 Repair garages.**

32 **[406.6.1 General.]** Repair garages shall be constructed in accordance with the *New York City*
33 *Fire Code* and Sections ~~[406.6.1]~~ 406.8.1 through ~~[406.6.6]~~ 406.8.6 of this code. This occupancy
34 shall not include motor fuel-dispensing facilities, as regulated in Section ~~[406.5]~~ 406.7.

35 **[406.6.2] 406.8.1 Mixed uses.** Mixed uses shall be allowed in the same building as a repair garage
36 subject to the provisions of Section 508.1.

1 **[406.6.3] 406.8.2 Ventilation.** Repair garages shall be mechanically ventilated in accordance with
2 the *New York City Mechanical Code*. The ventilation system shall be controlled at the entrance to
3 the garage.

4 **[406.6.4] 406.8.3 Floor surface.** Repair garage floors shall be of concrete or similar
5 noncombustible and nonabsorbent materials.

6 **Exception:** Slip-resistant, nonabsorbent, interior floor finishes having a critical radiant flux
7 not more than 0.45 W/cm², as determined by NFPA 253, shall be permitted.

8 **[406.6.5] 406.8.4 Heating equipment.** Heating equipment shall be installed in accordance with
9 the *New York City Mechanical Code*.

10 **[406.6.6] 406.8.5 Gas detection system.** Repair garages used for the repair of vehicles fueled by
11 CNG, LNG, or hydrogen, shall be provided with an approved flammable gas-detection system.

12 **[406.6.6.1] 406.8.5.1 System design.** The flammable gas-detection system shall be listed or
13 approved and shall be calibrated to the types of fuels or gases used by vehicles to be repaired.
14 The gas detection system shall be designed to activate when the level of flammable gas
15 exceeds 25 percent of the lower [~~explosive~~] flammable limit (LFL). Gas detection shall [~~also~~]
16 be provided in lubrication or chassis [~~repair~~] service pits of repair garages used for repairing
17 nonodorized LNG-fueled vehicles.

18 **406.8.5.1.1 Gas detection system components.** Gas detection system control units shall
19 be listed and labeled in accordance with UL 864 or UL 2017. Gas detectors shall be listed
20 and labeled in accordance with UL 2075 for use with the gases and vapors being detected.

21 **[406.6.6.2] 406.8.5.2 Operation.** Activation of the gas detection system shall result in all of
22 the following:

- 23 1. Initiation of distinct audible and visual alarm signals in the repair garage.
- 24 2. Deactivation of all heating systems located in the repair garage.
- 25 3. Activation of the mechanical ventilation and exhaust system, where the system is
26 interlocked with gas detection.

27 **[406.6.6.3] 406.8.5.3 Failure of the gas detection system.** Failure of the gas detection system
28 shall result in the deactivation of the heating system, activation of the mechanical ventilation
29 system [~~when~~] where the system is [~~inter-locked~~] interlocked with the gas detection system
30 and cause a trouble signal to sound in an approved location.

31 **406.8.6 Automatic sprinkler system.** A repair garage shall be equipped with an automatic
32 sprinkler system in accordance with Section 903.2.4.2.

33 **[406.7] 406.9 Open parking lots.**

34 **[406.7.1 General.]** The provisions of this section shall govern the construction of open parking
35 lots and to all such existing premises hereafter enlarged or changed in location.

1 ~~[406.7.2]~~ **406.9.1 Definitions.** The following ~~[words and terms shall, for the purposes of this~~
2 ~~chapter and as used elsewhere in this code, have the meanings shown herein.]~~ term is defined in
3 Chapter 2:

4 **OPEN PARKING LOT.** ~~[An exterior space with surfacing at grade used for the storage or sale~~
5 ~~of more than four motor vehicles, including but not limited to parking lots, motor vehicles sales~~
6 ~~lots, and accessory open parking spaces.]~~

7 ~~[406.7.3]~~ **406.9.2 Permit required.** Any premise intended to be occupied for the storage or sale
8 of motor vehicles on an open parking lot shall require an application to be filed with the
9 department in order to obtain a Certificate of Occupancy. Such Certificate of Occupancy shall
10 indicate the maximum number of vehicles to be accommodated and the type of vehicle, whether
11 private passenger or commercial, to be stored. An application for or including an open parking
12 lot shall be accompanied by a plan exhibiting the following:

- 13 1. Dimensions of the lot and its location in relation to adjoining streets; ~~[and]~~
- 14 2. Any structure(s) existing or to be erected on the plot; ~~[and]~~
- 15 3. The relative elevations of the parking area, curbs and adjoining yards or courts; ~~[and]~~
- 16 4. Structures, retaining walls, and open spaces on adjoining premises; ~~[and]~~
- 17 5. Retaining walls to be built; ~~[and]~~
- 18 6. Location and dimensions of curb cuts, driveways, and enclosures; ~~[and]~~
- 19 7. Drainage diagram; ~~[and]~~
- 20 8. Specification of surfacing material; ~~[and]~~
- 21 9. Parking stall layout with dimensions; ~~[and]~~
- 22 10. Analysis exhibiting compliance with the New York City Zoning Resolution; and
- 23 11. Other information as may be requested by the commissioner.

24 A copy of the plan or diagram approved by the department shall be kept on the premises.
25 Certified, reduced size, legible copies may be used for this purpose. When an attendant's shelter
26 is provided on the parking lot, the Certificate of Occupancy issued shall be posted and maintained
27 under glass in the shelter.

28 ~~[406.7.4]~~ **406.9.3 Locations prohibited.** All vehicular activities associated with the operation of
29 open parking lots shall be entirely within the property lines of the premises. Vehicles shall not
30 be permitted to encroach upon the sidewalks. No motor vehicle may be stored or parked in any
31 location where it would obstruct a required window or required exit of any adjacent building.

1 **[406.7.5] 406.9.4 Surfacing.** All driveways, parking stalls, and open spaces used for the parking
2 or storage of motor vehicles shall be surfaced with concrete asphalt, or equivalent durable,
3 dustless material.

4 **[406.7.5.1] 406.9.4.1 Drainage.** Open parking lots shall be graded and maintained such that
5 no drainage will flow onto abutting sidewalks and adjoining properties.

6 **[406.7.5.2] 406.9.4.2 Nonporous surfaces.** Where the surface paving of an open parking lot
7 is nonporous, such lot shall be drained as required by the *New York City Plumbing Code*.

8 **[406.7.5.3] 406.9.4.3 Resurfacing.** Resurfacing of existing open parking lots shall comply
9 with this section.

10 ~~**[406.7.6 Curb cuts.** For the purpose of this section, a curb cut shall include all splays when~~
11 ~~determining the total length of cut curb. Unless otherwise required by the New York City Zoning~~
12 ~~Resolution, all curb cuts shall comply with the following requirements:]~~

13 ~~[1. The aggregate length of curb cuts shall not exceed 60 percent of any street frontage~~
14 ~~100 feet (30 480 mm) or less in length. No single curb cut shall exceed 30 feet (9144~~
15 ~~mm) in length, and there shall not be more than two curb cuts on any street frontage~~
16 ~~100 feet (30 480 mm) or less in length. The minimum distance between two curb cuts~~
17 ~~shall be 5 feet (1524 mm).]~~

18 ~~[2. For each 50 feet (15 240 mm) of street frontage length over 100 feet (30 480 mm), an~~
19 ~~additional curb cut no greater than 30 feet (9144 mm) in length may be permitted.]~~

20 ~~[3. No curb cut shall commence within 8 feet (2438 mm) of a side lot line, except that on~~
21 ~~corner lots and lots with street frontage length of 50 feet (15 240 mm) or less, the~~
22 ~~curb cut may commence 30 inches (762 mm) from the side lot line.]~~

23 ~~[4. No curb cut, including splays, shall be less than 10 feet (3048 mm) in length.]~~

24 ~~**[406.7.7 Driveways.** Driveways serving passenger vehicles shall be a minimum of 8 feet (2438~~
25 ~~mm) in width and shall not exceed the length of the curb cut, not including the lengths of the~~
26 ~~splays. For all other motor vehicles, the minimum width of driveways shall be 10 feet (3048~~
27 ~~mm). Portions of the driveway located between the curb line and the lot line shall be paved in~~
28 ~~accordance with the requirements of the Department of Transportation for the construction of~~
29 ~~sidewalks.]~~

30 **[406.7.8] 406.9.5 Curbs and bumpers.** Open parking lots shall be completely separated from
31 adjoining premises and public sidewalks by curbs or bumpers of concrete, masonry, steel, heavy
32 timber, or other similar and equally substantial materials, and shall be securely anchored so as to
33 stop motor vehicles. Curbs and bumpers shall be at least 8 inches (203 mm) high and 8 inches
34 (203 mm) wide.

35 **[406.7.8.1] 406.9.5.1 Openings.** Openings in required perimeter curbs and bumpers shall
36 be permitted only for drainage, for motor vehicle entrances and exits, and for pedestrian
37 entrances and exits. The width of an opening for motor vehicle access shall not exceed the

1 length of the curb cut, not including the lengths of the splays. When an opening for
2 pedestrian access is adjacent to a motor vehicle access opening, the two openings shall be
3 separated by a permanent and substantial post. In no case shall any pedestrian entrance or
4 exit exceed 5 feet (1524 mm) in width.

5 **[406.7.9] 406.9.6 Accessory uses and occupancies.** Parking lot offices, attendant shelters,
6 storage facilities, and similar structures used in conjunction with open parking lots may be
7 provided as an accessory use and shall comply with the applicable code provisions. Such
8 accessory structures may be constructed of combustible materials subject to the limitations of
9 Section D105.1 of Appendix D.

10 **[406.7.9.1] 406.9.6.1 Motor fuel-dispensing facilities.** Motor fuel-dispensing facilities,
11 accessory to open parking lots, shall comply with the requirements of the *New York City Fire*
12 *Code* and Section ~~[406.5]~~ 406.8 of this code. Motor fuel pumps shall be located at least 30
13 feet (9144 mm) from any parking space or interior lot line.

14 **[406.7.10] 406.9.7 Special provisions applicable to large open parking lots.** Open parking lots
15 storing 10 or more motor vehicles shall also be subject to the special provisions of this section.

16 **[406.7.10.1] 406.9.7.1 Curbs and bumpers.** Bumpers shall be situated not less than 1 foot
17 (305 mm) from the perimeter edge of the open parking lot where vehicles are parked parallel
18 to such perimeter edge, and not less than 4 feet (1219 mm) from the perimeter edge where
19 vehicles are parked perpendicular to such perimeter edge. Openings shall be limited as
20 provided for in Section ~~[406.7.8.1]~~ 406.9.5.1.

21 **Exception:** A steel guardrail or other substantial barrier designed in accordance with the
22 provisions of Section ~~[406.7.3]~~ 1607.9, that will prevent any part of a vehicle from
23 extending across a property line, may be accepted in lieu of bumpers.

24 **[406.7.10.2] 406.9.7.2 Screen enclosures.** Open parking lots shall provide a perimeter screen
25 enclosure as per this section unless otherwise required by the *New York City Zoning*
26 *Resolution*. Such screen enclosure may be constructed as a masonry wall, woven wire fence,
27 iron picket fence, or uniformly painted fence of fire-resistant material at least 4 feet (1219
28 mm) high, but not more than 8 feet (2438 mm) above finished grade, subject to the limitations
29 of Section 3111. Such enclosures shall completely separate the lot from adjoining premises
30 and public sidewalks. Openings shall be limited as provided for in Section ~~[406.7.8.1]~~
31 406.9.5.1.

32 **Exception:** Screening shall not be required for any portion of the lot adjacent to an
33 existing wall located at the lot line.

34 **[406.7.10.3] 406.9.7.3 Illumination.** Open parking lots operating between 6 p.m. and 6 a.m.
35 shall be adequately illuminated to a minimum of 1 ~~[foot-candle]~~ footcandle (10.8 lux)
36 measured at grade level, distributed over the entire area. Illumination provided with reflectors
37 or floodlights shall be arranged such that the illumination is directed downward and away
38 from adjacent premises.

1 **[406.7.10.4] 406.9.7.4 Fire-fighter aisles.** In any open parking lot, one or more aisles, at least
2 24 inches (610 mm) in width, shall be provided to permit access by ~~[fire-fighting]~~ fire-
3 fighting personnel to all parts of the garage or lot. There shall not be more than three rows of
4 parked motor vehicles between aisles.

5 **[406.7.11] 406.9.8 Electric vehicle charging stations.** Open parking lots shall be capable of
6 supporting electric vehicle charging stations in accordance with this section. A minimum of 20
7 percent of the parking spaces in an open parking lot shall be equipped with electrical raceway
8 capable of providing a minimum supply of 11.5 kVA to an ~~[EVSE]~~ electrical vehicle supply
9 equipment (EVSE) from an electrical supply panel. The raceway shall be no smaller than 1 inch
10 (25 mm). The electrical supply panel serving such parking spaces must have at least 3.1 kW of
11 available capacity for each stall connected to it with raceway. Such raceway and all components
12 and work appurtenant thereto shall be in accordance with the *New York City Electrical Code*.

13 **Exceptions:**

- 14 1. The provisions of this section shall not apply to open parking lots for buildings of
15 ~~[occupancy group]~~ Occupancy Group M (Mercantile).
- 16 2. The commissioner may waive compliance with this section if the commissioner
17 determines that the open parking lot is a temporary facility that will be in service no
18 longer than 3 years.
- 19 3. The provisions of this section shall not apply to open parking lots for buildings in which
20 not less than fifty percent of the residential units are for households earning up to sixty
21 percent of the area median income as determined by the United States Department of
22 Housing and Urban Development.

23 **406.10 Curb cuts and driveways.** Except where specifically provided for in the *New York City*
24 *Zoning Resolution*, all curb cuts and driveways shall be constructed in accordance with Sections
25 406.10.1 and 406.10.2. All sidewalks and driveways or portions thereof that are structurally
26 supported shall be designed for loads prescribed in Chapter 16.

27 **406.10.1 Curb cuts.** For the purpose of this section, a curb cut shall include all splays when
28 determining the total length of cut curb. All curb cuts shall comply with the following
29 requirements:

- 30 1. The aggregate length of curb cuts shall not exceed 60 percent of any street frontage
31 100 feet (30 480 mm) or less in length. No single curb cut shall exceed 30 feet (9144
32 mm) in length, and there shall not be more than two curb cuts on any street frontage
33 100 feet (30 480 mm) or less in length. The minimum distance between two curb cuts
34 shall be 5 feet (1524 mm).
- 35 2. For each 50 feet (15 240 mm) of street frontage length over 100 feet (30 480 mm), an
36 additional curb cut no greater than 30 feet (9144 mm) in length may be permitted.
- 37 3. No curb cut shall commence within 8 feet (2438 mm) of a side lot line.

Exceptions:

1. For open parking lots on corner lots and on lots with street frontage length of 50 feet (15 240 mm) or less, the curb cut may commence no less than 30 inches (762 mm) from the side lot line.
2. In open or enclosed parking garages where a level landing having a minimum dimension of 20 feet (6096 mm) is provided at the discharge point of all ramps at the street level within the property line, the curb cut may commence no less than 30 inches (762 mm) from a side lot line.
4. No curb cut, including splays, shall be less than 10 feet (3048 mm) in length.

406.10.2 Driveways. Driveways serving passenger vehicles shall be a minimum of 8 feet (2438 mm) in width and shall not exceed the length of the curb cut, not including the lengths of the splays. For all other motor vehicles, the minimum width of driveways shall be 10 feet (3048 mm). Portions of the driveway located between the curb line and the lot line shall be paved in accordance with the requirements of the Department of Transportation for the construction of sidewalks.

406.11 Battery-powered industrial trucks, equipment and mobility devices. Buildings or portions thereof that contain or store battery-powered industrial trucks, equipment and mobility devices shall be designed and constructed in accordance with Section 309.3 of the New York City Fire Code.

**SECTION BC 407
GROUP I-2**

407.1 General. Occupancies in Group I-2 shall comply with the provisions of Sections 407.1 through ~~[407.9]~~ 407.10 and other applicable provisions of this code.

407.2 Corridors continuity and separation. Corridors in occupancies in Group I-2 shall be continuous to the exits and shall be separated from other areas in accordance with Section 407.3 except spaces conforming to Sections 407.2.1 through ~~[407.2.4]~~ 407.2.6.

407.2.1 Waiting and similar areas. Waiting areas and similar spaces constructed as required for corridors shall be permitted to be open to a corridor, only where all of the following criteria are met:

1. The spaces are not occupied ~~[for patient]~~ as care recipient's sleeping [units] rooms, treatment rooms, [hazardous or] incidental [accessory occupancies] uses in accordance with Section ~~[508.2]~~ 509, or hazardous uses.
2. The open space is protected by an automatic fire detection system installed in accordance with Section 907.

1 3. The corridors onto which the spaces open, in the same smoke compartment, are protected
2 by an automatic fire detection system installed in accordance with Section 907, or the
3 smoke compartment in which the spaces are located is equipped throughout with quick-
4 response sprinklers in accordance with Section 903.3.2.

5 4. The space is arranged so as not to obstruct access to the required exits.

6 **407.2.2 [Nurses'] Care providers' stations.** Spaces for care providers', supervisory staff,
7 doctors' and nurses' charting, communications and related clerical areas shall be permitted to be
8 open to the corridor, [when] where such spaces are constructed as required for corridors.

9 **407.2.3 [Mental health] Psychiatric treatment areas.** Areas wherein [~~mental health patients]~~
10 psychiatric care recipients who are not capable of self-preservation are housed, or group meeting
11 or multipurpose therapeutic spaces other than incidental [~~accessory occupancies]~~ uses in
12 accordance with Section 509, under continuous supervision by facility staff, shall be permitted to
13 be open to the corridor, where the following criteria are met:

14 1. Each area does not exceed 1,500 square feet (140 m²).

15 2. The area is located to permit supervision by the facility staff.

16 3. The area is arranged so as not to obstruct any access to the required exits.

17 4. The area is equipped with an automatic fire detection system installed in accordance with
18 Section 907.2.

19 5. Not more than one such space is permitted in any one smoke compartment.

20 6. The walls and ceilings of the space are constructed as required for corridors.

21 **407.2.4 Gift shops.** Gift shops and associated storage that are less than 500 square feet (46 m²)
22 in area shall be permitted to be open to the corridor [~~provided the gift shop and storage areas are~~
23 ~~fully sprinklered and storage areas are protected in accordance with Section 508.2.] where such~~
24 spaces are constructed as required for corridors.

25 **407.2.5 Nursing home housing units.** In Group I-2 occupancies, in areas where nursing home
26 residents are housed, shared living spaces, group meeting or multipurpose therapeutic spaces shall
27 be permitted to be open to the corridor, where all of the following criteria are met:

28 1. The walls and ceilings of the space are constructed as required for corridors.

29 2. The spaces are not occupied as resident sleeping rooms, treatment rooms, incidental uses
30 in accordance with Section 509, or hazardous uses.

31 3. The open space is protected by an automatic fire detection system installed in accordance
32 with Section 907.

33 4. The corridors onto which the spaces open, in the same smoke compartment, are protected
34 by an automatic fire detection system installed in accordance with Section 907, or the

1 smoke compartment in which the spaces are located is equipped throughout with quick-
2 response sprinklers in accordance with Section 903.3.2.

3 5. The space is arranged so as not to obstruct access to the required exits.

4 **407.2.6 Nursing home cooking facilities.** In Group I-2 occupancies, rooms or spaces that contain
5 a cooking facility with domestic cooking appliances shall be permitted to be open to the corridor
6 where all of the following criteria are met:

7 1. The number of care recipients housed in the smoke compartment is not greater than 30.

8 2. The number of care recipients served by the cooking facility is not greater than 30.

9 3. Only one cooking facility area is permitted in a smoke compartment.

10 4. The types of domestic cooking appliances permitted are limited to ovens, cooktops,
11 ranges, warmers and microwaves.

12 5. The corridor is a clearly identified space delineated by construction or floor pattern,
13 material or color.

14 6. The space containing the domestic cooking facility shall be arranged so as not to obstruct
15 access to the required exit.

16 7. A domestic cooking hood installed and constructed in accordance with Section 505 of the
17 *New York City Mechanical Code* is provided over the cooktop or range.

18 8. The domestic cooking hood provided over the cooktop or range shall be equipped with
19 an automatic fire-extinguishing system of a type recognized for protection of domestic
20 cooking equipment. Preengineered automatic extinguishing systems shall be tested in
21 accordance with UL 300A and listed and labeled for the intended application. The system
22 shall be installed in accordance with this code, its listing and the manufacturer's
23 instructions.

24 9. A manual actuation device for the hood suppression system shall be installed in
25 accordance with Sections 904.12.1 and 904.12.2.

26 10. An interlock device shall be provided such that upon activation of the hood suppression
27 system, the power or fuel supply to the cooktop or range will be turned off.

28 11. A shut-off for the fuel and electrical power supply to the cooking equipment shall be
29 provided in a location that is accessible only to staff.

30 12. A timer shall be provided that automatically deactivates the cooking appliances within a
31 period of not more than 120 minutes.

32 13. A portable fire extinguisher shall be installed in accordance with Section 906 of the *New*
33 *York City Fire Code*.

1 **407.3 Corridor [~~walls~~] wall construction.** Corridor walls shall be constructed as smoke partitions
2 in accordance with Section [~~711~~] 710.

3 **407.3.1 Corridor doors.** Corridor doors, other than those in a wall required to be rated by Section
4 509.4 or for the enclosure of a vertical opening or an exit, shall not have a required fire protection
5 rating and shall not be required to be equipped with self-closing or automatic-closing devices, but
6 shall provide an effective barrier to limit the transfer of smoke and shall be equipped with positive
7 latching. Roller latches are not permitted. Other doors shall conform to Section [~~715.4~~] 716.5.

8 **407.4 Means of egress.** Group I-2 occupancies shall be provided with means of egress complying
9 with Chapter 10 and Sections 407.4.1 through 407.4.4. The fire and emergency preparedness plans
10 provided in accordance with Section 1001.4 of this codeshall identify the building components
11 necessary to support a defend-in-place emergency response in accordance with the *New York City*
12 *Fire Code.*

13 **407.4.1 Direct access to a corridor.** Habitable rooms in Group I-2 occupancies shall have an exit
14 access door leading directly to a corridor.

15 **Exceptions:**

- 16 1. Rooms with exit doors opening directly to the outside at ground level.
- 17 2. Rooms arranged as care suites complying with Section 407.4.4.

18 [~~407.3.2~~] **407.4.1.1 Locking devices.** Locking devices that restrict access to [~~the patient~~] a
19 care recipient's room from the corridor[;] and that are operable only by staff from the corridor
20 side[;] shall not restrict the means of egress from the [~~patient~~] care recipient's room [except
21 for patient rooms in mental health facilities].

22 **Exceptions:**

- 23 1. This section shall not apply to rooms in psychiatric treatment and similar care
24 areas.
- 25 2. Locking arrangements in accordance with Section 1010.1.9.6.

26 **407.4.2 Distance of travel.** The distance of travel between any point in a Group I-2 occupancy
27 sleeping room, not located in a care suite, and an exit access door in that room shall be not greater
28 than 50 feet (15 240 mm).

29 **407.4.3 Projections in nursing home corridors.** In nursing homes of Group I-2 occupancies,
30 where the corridor width is a minimum of 96 inches (2440 mm), projections shall be permitted
31 for furniture where all of the following criteria are met:

- 32 1. The furniture is attached to the floor or to the wall.
- 33 2. The furniture does not reduce the clear width of the corridor to less than 72 inches (1830
34 mm) except where other encroachments are permitted in accordance with Section 1005.7.

1 3. The furniture is positioned on only one side of the corridor.

2 4. Each arrangement of furniture is 50 square feet (4.6 m²) maximum in area.

3 5. Furniture arrangements are separated by 10 feet (3048 mm) minimum.

4 6. Placement of furniture is considered as part of the fire and emergency preparedness plans
5 in accordance with Section 1001.4.

6 **407.4.4 Group I-2 care suites.** Care suites in Group I-2 shall comply with Sections 407.4.4.1
7 through 407.4.4.4 and either Section 407.4.4.5 or 407.4.4.6.

8 **407.4.4.1 Exit access through care suites.** Exit access from all other portions of a building
9 not classified as a care suite shall not pass through a care suite. In a care suite required to have
10 more than one exit, one exit access is permitted to pass through an adjacent care suite provided
11 all of the other requirements of Sections 407.4 and 1016.2 are satisfied.

12 **407.4.4.2 Separation.** Care suites shall be separated from other portions of the building,
13 including other care suites, by a smoke partition complying with Section 710.

14 **407.4.4.3 Access to corridor.** Movement from habitable rooms shall not require passage
15 through more than three doors and 100 feet (30 480 mm) distance of travel within the suite.

16 **Exception:** The distance of travel shall be permitted to be increased to 125 feet (38 100
17 mm) where an automatic smoke detection system is provided throughout the care suite
18 and installed in accordance with NFPA 72 as modified by Appendix Q of this cde.

19 **407.4.4.4 Doors within care suites.** Doors in care suites serving habitable rooms shall be
20 permitted to comply with one of the following:

21 1. Manually operated horizontal sliding doors permitted in accordance with Exception 9
22 to Section 1010.1.2.1.

23 2. Power-operated doors permitted in accordance with Exception 7 to Section 1010.1.2.1.

24 3. Means of egress doors complying with Section 1010.

25 **407.4.4.5 Care suites containing sleeping room areas.** Sleeping rooms shall be permitted to
26 be grouped into care suites where one of the following criteria is met:

27 1. The care suite is not used as an exit access for more than eight care recipient beds.

28 2. The arrangement of the care suite allows for direct and constant visual supervision into
29 the sleeping rooms by care providers.

30 3. An automatic smoke detection system is provided in the sleeping rooms and installed
31 in accordance with NFPA 72 as modified by Appendix Q of this code.

1 **407.4.4.5.1 Area.** Care suites containing sleeping rooms shall be not greater than 7,500
2 square feet (696 m²) in area.

3 **Exception:** Care suites containing sleeping rooms shall be permitted to be not greater
4 than 10,000 square feet (929 m²) in area where an automatic smoke detection system
5 is provided throughout the care suite and installed in accordance with NFPA 72 as
6 modified by Appendix Q of this code.

7 **407.4.4.5.2 Exit access.** Any sleeping room, or any care suite that contains sleeping
8 rooms, of more than 1,000 square feet (93 m²) shall have no fewer than two exit access
9 doors from the care suite located in accordance with Section 1007.

10 **407.4.4.6 Care suites not containing sleeping rooms.** Areas not containing sleeping rooms,
11 but only treatment areas and the associated rooms, spaces or circulation space, shall be
12 permitted to be grouped into care suites and shall conform to the limitations in Sections
13 407.4.4.6.1 and 407.4.4.6.2.

14 **407.4.4.6.1 Area.** Care suites of rooms, other than sleeping rooms, shall have an area not
15 greater than 12,500 square feet (1161 m²).

16 **Exception:** Care suites not containing sleeping rooms shall be permitted to be not
17 greater than 15,000 square feet (1394 m²) in area where an automatic smoke detection
18 system is provided throughout the care suite in accordance with Section 907.

19 **407.4.4.6.2 Exit access.** Care suites, other than sleeping rooms, with an area of more than
20 2,500 square feet (232 m²) shall have no fewer than two exit access doors from the care
21 suite located in accordance with Section 1007.1.

22 ~~[407.4]~~ **407.5 Smoke barriers.** Smoke barriers shall be provided to subdivide every story used by
23 [patients for sleeping or] persons receiving care, treatment or sleeping and to divide other stories with
24 an occupant load of 50 or more persons, into [at least] no fewer than two smoke compartments. Such
25 stories shall be divided into smoke compartments with an area of not more than 22,500 square feet
26 [~~(2090 m²)~~] (2090 m²) in nursing homes in Group I-2, and not more than 40,000 square feet (3716
27 m²) in detoxification facilities, hospitals and psychiatric centers in Group I-2, and the [travel] distance
28 of travel from any point in a smoke compartment to a smoke barrier door shall be not [exceed] greater
29 than 200 feet (60 960 mm). The smoke barrier shall be in accordance with Section [740] 709.

30 ~~[407.4.1]~~ **407.5.1 Refuge area.** [At least 30 net square feet (2.8 m²) per patient shall be provided
31 within the aggregate area of corridors, patient rooms, treatment rooms, lounge or dining areas and
32 other low hazard areas on each side of each smoke barrier. On floors not housing patients confined
33 to a bed or litter, at least 6 net square feet (0.56 m²) per occupant shall be provided on each side
34 of each smoke barrier for the total number of occupants in adjoining smoke compartments.]
35 Refuge areas shall be provided within each smoke compartment. The size of the refuge area shall
36 accommodate the occupants and care recipients from the adjoining smoke compartment. Where
37 a smoke compartment is adjoined by two or more smoke compartments, the minimum area of the
38 refuge area shall accommodate the largest occupant load of the adjoining compartments. The size
39 of the refuge area shall provide the following:

- 1 1. Not less than 30 net square feet (2.8 m²) for each care recipient confined to bed or stretcher.
- 2 2. Not less than 6 square feet (0.56 m²) for each ambulatory care recipient not confined to
- 3 bed or stretcher and for other occupants.

4 Areas or spaces permitted to be included in the calculation of refuge area are corridors,
5 sleeping areas, treatment rooms, lounge or dining areas and other low-hazard areas.

6 **[407.4.2] 407.5.2 Independent egress.** A means of egress shall be provided from each smoke
7 compartment created by smoke barriers without having to return through the smoke compartment
8 from which means of egress originated.

9 **[407.4.3] 407.5.3 Horizontal assemblies.** Horizontal assemblies supporting smoke barriers
10 required by this section shall be designed to resist the movement of smoke ~~and shall comply with~~
11 ~~Section 712.9].~~ Elevator lobbies shall be in accordance with Section 3006.1.

12 **[407.5] 407.6 Automatic sprinkler system.** Smoke compartments containing ~~[patient]~~ sleeping
13 ~~[units]~~ rooms shall be equipped throughout with an automatic fire sprinkler system in accordance
14 with ~~[Section] Sections 903.3.1.1 and 903.3.2.~~ ~~[The smoke compartments shall be equipped with~~
15 ~~approved quick-response or residential sprinklers in accordance with Section 903.3.2.]~~

16 **407.7 Fire alarm system.** A fire alarm system shall be provided in accordance with Section 907.2.6.

17 **[407.7] 407.8 Automatic fire detection.** Corridors in nursing homes (both intermediate-care and
18 skilled nursing facilities)~~], detoxification facilities]~~ and spaces permitted to be open to the corridors
19 by Section 407.2 shall be equipped with an automatic fire detection system installed in accordance
20 with Section 907. ~~[Hospitals]~~ Detoxification facilities, hospitals and psychiatric centers shall be
21 equipped with smoke detection as required in Section 407.2.

22 **Exceptions:**

- 23 1. Corridor smoke detection is not required where ~~[patient]~~ sleeping ~~[units]~~ rooms are
24 provided with smoke detectors that comply with UL 268. Such detectors shall provide a
25 visual display on the corridor side of each ~~[patient]~~ sleeping ~~[unit]~~ room and an audible
26 and visual alarm at the ~~[nursing]~~ care provider's station attending each unit.
- 27 2. Corridor smoke detection is not required where ~~[patient]~~ sleeping ~~[unit]~~ room doors are
28 equipped with automatic door-closing devices with integral smoke detectors on the unit
29 sides installed in accordance with their listing, provided that the integral detectors perform
30 the required alerting function.

31 **[407.8] 407.9 Secured yards.** Grounds are permitted to be fenced and gates therein are permitted to
32 be equipped with locks, provided that safe dispersal areas having 30 net square feet (2.8 m²) for bed
33 and ~~[litter patients]~~ stretcher care recipients and 6 net square feet (0.56 m²) for ~~[ambulatory patients]~~
34 ambulatory care recipients and other occupants are located between the building and the fence. Such
35 provided safe dispersal areas shall ~~[not]~~ be located not less than 50 feet (15 240 mm) from the building
36 they serve.

1 ~~[407.9 Hyperbaric facilities. Hyperbaric facilities in Group I-2 occupancies shall meet the~~
2 ~~requirements contained in Chapter 20 of NFPA 99.]~~ **407.10 Electrical systems.** In Group I-2
3 occupancies, the essential electrical system for electrical components, equipment and systems shall
4 be designed and constructed in accordance with the provisions of NFPA 99 and Chapter 27 of this
5 code.

6 **SECTION BC 408**
7 **GROUP I-3**

8 **408.1 General.** Occupancies in Group I-3 shall comply with the provisions of Sections 408.1 through
9 ~~[408.10]~~ 408.11 and other applicable provisions of this code (see Section ~~[308.4]~~ 308.5).

10 **408.1.1 [Definition] Definitions specific to this section.** The following ~~[words and]~~ terms shall,
11 for the purposes of this ~~[chapter and as used elsewhere in this code]~~ section, have the meanings
12 shown herein~~[-]~~:

13 **CELL.** A room within a housing unit in a detention or correctional facility used to confine
14 inmates or prisoners.

15 **CELL TIER.** Levels of cells vertically stacked above one another within a housing unit.

16 **HOUSING UNIT.** A dormitory or a group of cells with a common dayroom in Group I-3.

17 **SALLYPORT.** A security vestibule with two or more doors or gates where the intended
18 purpose is to prevent continuous and unobstructed passage by allowing the release of only one
19 door or gate at a time.

20 ~~[408.1.2 Occupancy conditions. Buildings of Group I-3 shall be classified as one of the~~
21 ~~occupancy conditions indicated in Sections 408.1.2.1 through 408.1.2.5.]~~

22 ~~[408.1.2.1 Condition 1. This occupancy condition shall include buildings in which free~~
23 ~~movement is allowed from sleeping areas, and other spaces where access or occupancy is~~
24 ~~permitted, to the exterior via means of egress without restraint. A Condition 1 facility is~~
25 ~~permitted to be constructed as Group R.]~~

26 ~~[408.1.2.2 Condition 2. This occupancy condition shall include buildings in which free~~
27 ~~movement is allowed from sleeping areas and any other occupied smoke compartment to one~~
28 ~~or more other smoke compartments. Egress to the exterior is impeded by locked exits and~~
29 ~~exit is not under an occupant's control.]~~

30 ~~[408.1.2.3 Condition 3. This occupancy condition shall include buildings in which free~~
31 ~~movement is allowed within individual smoke compartments, such as within a residential~~
32 ~~unit comprised of individual sleeping unit(s) and/or group activity spaces, where egress is~~
33 ~~impeded by remote-controlled door release, leading by means of egress from such a smoke~~
34 ~~compartment to another smoke compartment.]~~

35 ~~[408.1.2.4 Condition 4. This occupancy condition shall include buildings in which free~~
36 ~~movement is restricted from an occupied space. Remote-controlled release is provided to~~
37 ~~permit movement from sleeping units, activity spaces and other occupied areas within the~~

1 smoke compartment to other smoke compartments and egress to the outside is impeded by
2 locked exit and remote door release.]

3 [~~408.1.2.5 Condition 5. This occupancy condition shall include buildings in which free~~
4 ~~movement is restricted from an occupied space. Staff controlled manual release is provided~~
5 ~~to permit movement from sleeping units, activity spaces and other occupied areas within the~~
6 ~~smoke compartment to other smoke compartments.]~~

7 **408.2 Other occupancies.** Buildings or portions of buildings in Group I-3 occupancies where security
8 operations necessitate the locking of required means of egress shall be permitted to be classified as a
9 different occupancy. Occupancies classified as other than Group I-3 shall meet the applicable
10 requirements of this code for that occupancy [~~provided~~] where provisions [~~shall be~~] are made for the
11 release of occupants at all times.

12 Means of egress from detention and correctional occupancies that traverse other use areas shall,
13 as a minimum, conform to requirements for detention and correctional occupancies.

14 **Exception:** It is permissible to exit through a horizontal exit into other contiguous occupancies
15 that do not conform to detention and correctional occupancy egress provisions but that do comply
16 with requirements set forth in the appropriate occupancy, as long as the occupancy is not a Group
17 H use.

18 **408.3 Means of egress.** Except as modified or as provided for in this section, the means of egress
19 provisions of Chapter 10 shall apply.

20 **408.3.1 Door width.** Doors to resident sleeping units shall have a clear width of not less than 28
21 inches (711 mm).

22 **408.3.2 Sliding doors.** Where doors in a means of egress are of the horizontal-sliding type, the
23 force to slide the door to its fully open position shall be not [~~exceed~~] greater than 50 pounds (220
24 N) with a perpendicular force against the door of 50 pounds (220 N).

25 **408.3.3 Guard tower doors.** A hatch or trap door not less than 16 square feet [~~(610 m²)~~] (1.49
26 m²) in area through the floor and having [~~minimum~~] dimensions of not less than 2 feet (610 mm)
27 in any direction shall be permitted to be used as a portion of the means of egress from guard
28 towers.

29 **408.3.4 Spiral stairways.** Spiral stairways that conform to the requirements of Section [~~4009.9~~]
30 1011.10 are permitted for access to and between staff locations.

31 **408.3.5 Ship ladders.** Ship ladders shall be permitted for egress from control rooms or elevated
32 facility observation rooms in accordance with Section [~~4009.11~~] 1011.15.

33 **408.3.6 Exit discharge.** Exits are permitted to discharge into a fenced or walled courtyard.
34 Enclosed yards or courts shall be of a size to accommodate all occupants, [~~a minimum of~~] be
35 located not less than 50 feet (15 240 mm) from the building [~~with a net~~] and have an area of not
36 less than 15 square feet (1.4 m²) per person.

1 **408.3.7 Sallyports.** A sallyport shall be permitted in a means of egress where there are provisions
2 for continuous and unobstructed passage through the sallyport during an emergency egress
3 condition.

4 **408.3.8** ~~[Exit enclosures. One of the required exit enclosures]~~ **Interior exit stairway and ramp**
5 **construction.** One interior exit stairway or ramp in each building shall be permitted to have
6 glazing installed in doors and interior walls at each landing level providing access to the
7 ~~[enclosure]~~ interior exit stairway or ramp, provided that the following conditions are met:

- 8 1. The ~~[vertical]~~ interior exit ~~[enclosure]~~ stairway or ramp shall not serve more than four
9 floor levels.
- 10 2. Exit doors shall ~~be~~ not ~~[be]~~ less than ~~[3/4 hour]~~ 3/4 hour fire ~~[doors]~~ door assemblies
11 complying with Section ~~[715.4]~~ 716.5.
- 12 3. The total area of glazing at each floor level shall not exceed 5,000 square inches ~~[(3 m²)]~~
13 3.2 m² and individual panels of glazing shall not exceed 1,296 square inches (0.84 m²).
- 14 4. The glazing shall be protected on both sides by an automatic sprinkler system. The
15 sprinkler system shall be designed to wet completely the entire surface of any glazing
16 affected by fire when actuated.
- 17 5. The glazing shall be in a gasketed frame and installed in such a manner that the framing
18 system will deflect without breaking (loading) the glass before the sprinkler system
19 operates.
- 20 6. Obstructions, such as curtain rods, drapery traverse rods, curtains, drapes or similar
21 materials shall not be installed between the automatic sprinklers and the glazing.

22 **408.4 Locks.** Egress doors are permitted to be locked in accordance with the applicable use condition.
23 Doors from a refuge area to the ~~[exterior]~~ outside are permitted to be locked with a key in lieu of
24 locking methods described in Section 408.4.1. The keys to unlock the exterior doors shall be available
25 at all times and the locks shall be operable from both sides of the door.

26 **408.4.1 Remote release.** Remote release of locks on doors in a means of egress shall be provided
27 with reliable means of operation, remote from the resident living areas, to release locks on all
28 required doors. In Occupancy ~~[Conditions]~~ Condition 3 or 4, the arrangement, accessibility and
29 security of the release ~~[mechanism(s)]~~ mechanisms required for egress shall be such that with the
30 minimum available staff at any time, the lock mechanisms are capable of being released within 2
31 minutes.

32 **Exception:** Provisions for remote locking and unlocking of occupied rooms in Occupancy
33 Condition 4 are not required provided that not more than 10 locks are necessary to be unlocked
34 in order to move occupants from one smoke compartment to a refuge area within 3 minutes.
35 The opening of necessary locks shall be accomplished with not more than two separate keys.

36 **408.4.2 Power-operated doors and locks.** Power-operated sliding doors or power-operated locks
37 for swinging doors shall be operable by a manual release mechanism at the door~~[-and either~~

1 emergency]. Emergency power [~~or a remote mechanical operating release~~] shall be provided for
2 the doors and locks in accordance with Section 2702.

3 **[Exception] Exceptions:**

4 1. Emergency power is not required in facilities with 10 or fewer locks [~~or less~~]
5 complying with the exception to Section 408.4.1.

6 2. Emergency power is not required where remote mechanical operating releases are
7 provided.

8 **408.4.3 Redundant operation.** Remote release, mechanically operated sliding doors or remote
9 release, mechanically operated locks shall be provided with a mechanically operated release
10 mechanism at each door, or shall be provided with a redundant remote release control.

11 **408.4.4 Relock capability.** Doors remotely unlocked under emergency conditions shall not
12 automatically relock when closed unless specific action is taken at the remote location to enable
13 doors to relock.

14 **408.5 Protection of vertical openings.** Any vertical opening shall be protected by a shaft enclosure
15 in accordance with Section [~~708~~] 713, or shall be in accordance with Sections 408.5.1 and 408.5.2.

16 **408.5.1 Floor openings.** Openings in floors within a housing unit are permitted without a shaft
17 enclosure, provided all of the following conditions are met:

- 18 1. The entire normally occupied areas so interconnected are open and unobstructed so as to
19 enable observation of the areas by supervisory personnel;
- 20 2. Means of egress capacity is sufficient for all occupants from all interconnected cell tiers
21 and areas;
- 22 3. The height difference between the floor levels of the highest and lowest cell tiers shall not
23 exceed 23 feet (7010 mm); and
- 24 4. Egress from any portion of the cell tier to an exit or exit access door shall not require travel
25 on more than one additional floor level within the housing unit.

26 **408.5.2 Shaft openings in communicating floor levels.** Where a floor opening is permitted
27 between communicating floor levels of a housing unit in accordance with Section 408.5.1,
28 plumbing chases serving vertically stacked individual cells contained within the housing unit shall
29 be permitted without a shaft enclosure.

30 **408.6 Smoke barrier.** Occupancies in Group I-3 shall have smoke barriers complying with Sections
31 408.8 and [~~710~~] 709 to divide every story occupied by residents for sleeping, or any other story having
32 an occupant load of 50 or more persons, into [~~at least~~] no fewer than two smoke compartments.

33 **Exception:** Spaces having a direct exit to one of the following, provided that the locking
34 arrangement of the doors involved complies with the requirements for doors at the smoke barrier
35 for the use condition involved:

- 1 1. A public way.
- 2 2. A building separated from the resident housing area by a 2-hour fire-resistance-rated
- 3 assembly or 50 feet (15 240 mm) of open space.
- 4 3. A secured yard or court having a holding space 50 feet (15 240 mm) from the housing area
- 5 that provides 6 square feet (0.56 m²) or more of refuge area per occupant, including
- 6 residents, staff and visitors.

7 **408.6.1 Smoke compartments.** The [~~maximum~~] number of residents in any smoke compartment
8 shall be not more than 200. The [~~travel~~] distance of travel to a door in a smoke barrier from any
9 room door required as exit access shall be not [~~exceed~~] greater than 150 feet (45 720 mm). The
10 [~~travel~~] distance of travel to a door in a smoke barrier from any point in a room shall be not
11 [~~exceed~~] greater than 200 feet (60 960 mm).

12 **408.6.2 Refuge area.** [~~At least~~] Not less than 6 net square feet (0.56 m²) per occupant shall be
13 provided on each side of each smoke barrier for the total number of occupants in adjoining smoke
14 compartments. This space shall be readily available wherever the occupants are moved across the
15 smoke barrier in a fire emergency.

16 **408.6.3 Independent egress.** A means of egress shall be provided from each smoke compartment
17 created by smoke barriers without having to return through the smoke compartment from which
18 means of egress originates.

19 **408.7 Security glazing.** In occupancies in Group I-3, windows and doors in 1-hour fire barriers
20 constructed in accordance with Section 707, fire partitions constructed in accordance with Section
21 [~~709~~] 708 and smoke barriers constructed in accordance with Section [~~710~~] 709 shall be permitted to
22 have security glazing installed provided that the following conditions are met. Such glazing shall be
23 subject to the requirements in Chapter 24.

- 24 1. Individual panels of glazing shall not exceed 1,296 square inches (0.84 m²).
- 25 2. The glazing shall be protected on both sides by an automatic sprinkler system. The sprinkler
- 26 system shall be designed to, when actuated, wet completely the entire surface of any glazing
- 27 affected by fire.
- 28 3. The glazing shall be in a gasketed frame and installed in such a manner that the framing system
- 29 will deflect without breaking (loading) the glass before the sprinkler system operates.
- 30 4. Obstructions, such as curtain rods, drapery traverse rods, curtains, drapes or similar materials
- 31 shall not be installed between the automatic sprinklers and the glazing.

32 **408.8 Subdivision of resident housing areas.** Sleeping areas and any contiguous day room, group
33 activity space or other common spaces where residents are housed shall be separated from other
34 spaces in accordance with Sections 408.8.1 through 408.8.4.

35 **408.8.1 Occupancy Conditions 3 and 4.** Each sleeping area in Occupancy Conditions 3 and 4
36 shall be separated from the adjacent common spaces by a smoke-tight partition where the [~~travel~~]

1 distance of travel from the sleeping area through the common space to the corridor exceeds 50
2 feet (15 240 mm).

3 **408.8.2 Occupancy Condition 5.** Each sleeping area in Occupancy Condition 5 shall be separated
4 from adjacent sleeping areas, corridors and common spaces by a smoke-tight partition.
5 Additionally, common spaces shall be separated from the corridor by a smoke-tight partition.

6 **408.8.3 Openings in room face.** The aggregate area of openings in a solid sleeping room face in
7 Occupancy Conditions 2, 3, 4 and 5 shall not exceed 120 square inches [~~(77 419 mm²)~~] (0.077
8 m²). The aggregate area shall include all openings including door undercuts, food passes and
9 grilles. Openings shall be not more than 36 inches (914 mm) above the floor. In Occupancy
10 Condition 5, the openings shall be closeable from the room side.

11 **408.8.4 Smoke-tight doors.** Doors in openings in partitions required to be smoke tight by Section
12 408.8 shall be substantial doors, of construction that will resist the passage of smoke. Latches and
13 door closures are not required on cell doors.

14 **408.9 Windowless buildings.** For the purposes of this section, a windowless building or portion of a
15 building is one with nonopenable windows, windows not readily breakable or without windows.
16 Windowless buildings shall be provided with an engineered smoke control system to provide a tenable
17 environment for exiting from the smoke compartment in the area of fire origin in accordance with
18 Section 909 for each windowless smoke compartment.

19 **408.10 Fire alarm system.** A fire alarm system shall be provided in accordance with Section
20 907.2.6.3.

21 **408.11 Automatic sprinkler system.** Group I-3 occupancies shall be equipped throughout with an
22 automatic sprinkler system in accordance with Section 903.2.6.

23 **SECTION BC 409**
24 **MOTION PICTURE PROJECTION ROOMS**

25 **409.1 General.** The provisions of Sections 409.1 through 409.5 of this code shall apply to rooms in
26 which ribbon-type cellulose acetate or other safety film is utilized in conjunction with electric arc,
27 xenon or other light-source projection equipment that develops hazardous gases, dust or radiation.
28 The projection, use or storage of film having a nitrocellulose base (commonly known as nitrate film)
29 shall not be permitted except under conditions specified in special permits when issued by the Fire
30 Department. Safety film meeting the specification and test standards of NFPA 40 may be projected,
31 used or stored.

32 **409.1.1 Projection room required.** Every motion picture machine projecting film as mentioned
33 within the scope of this section shall be enclosed in a projection room. Appurtenant electrical
34 equipment, such as rheostats, transformers and generators, shall be within the projection room or
35 in an adjacent room of equivalent construction.

36 **409.2 Construction of projection rooms.** Every projection room shall be of permanent construction
37 consistent with the construction requirements for the type of building in which the projection room is
38 located. Openings are not required to be protected.

1 The room shall have a floor area of not less than 80 square feet (7.44 m²) for a single machine
2 and ~~[at least]~~ not less than 40 square feet (3.7 m²) for each additional machine. Each motion picture
3 projector, floodlight, spotlight or similar piece of equipment shall have a clear working space of not
4 less than 30 inches by 30 inches (762 mm by 762 mm) on each side and at the rear thereof, but only
5 one such space shall be required between two adjacent projectors. The projection room and the rooms
6 appurtenant thereto shall have a ceiling height of not less than 7 feet 6 inches (2286 mm). The
7 aggregate of openings for projection equipment shall not exceed 25 percent of the area of the wall
8 between the projection room and the auditorium. Openings shall be provided with glass or other
9 approved material, so as to close completely the opening.

10 **409.3 Projection room and equipment ventilation.** Ventilation shall be provided in accordance with
11 the *New York City Mechanical Code*.

12 **409.3.1 Supply air.** Each projection room shall be provided with adequate air supply inlets so
13 arranged as to provide well-distributed air throughout the room. Air inlet ducts shall provide an
14 amount of air equivalent to the amount of air being exhausted by projection equipment. Air is
15 permitted to be taken from the outside; from adjacent spaces within the building, provided the
16 volume and infiltration rate is sufficient; or from the building air-conditioning system, provided
17 it is so arranged as to provide sufficient air when other systems are not in operation.

18 **409.3.2 Exhaust air.** Projection rooms are permitted to be exhausted through the lamp exhaust
19 system. The lamp exhaust system shall be positively interconnected with the lamp so that the lamp
20 will not operate unless there is the required airflow. Exhaust air ducts shall terminate at the
21 exterior of the building in such a location that the exhaust air cannot be readily recirculated into
22 any air supply system. The projection room ventilation system is permitted to also serve
23 appurtenant rooms, such as the generator and rewind rooms.

24 **409.3.3 Projection machines.** Each projection machine shall be provided with an exhaust duct
25 that will draw air from each lamp and exhaust it directly to the outside of the building. The lamp
26 exhaust is permitted to serve to exhaust air from the projection room to provide room air
27 circulation. Such ducts shall be of rigid materials, except for a flexible connector approved for the
28 purpose. The projection lamp or projection room exhaust system, or both, is permitted to be
29 combined but shall not be interconnected with any other exhaust or return system, or both, within
30 the building.

31 **409.4 Lighting control.** Provisions shall be made for control of the auditorium lighting and the means
32 of egress lighting systems of theaters from inside the projection room and from ~~[at least]~~ not less than
33 one other convenient point in the building.

34 **409.5 Miscellaneous equipment.** Each projection room shall be provided with rewind and film
35 storage facilities.

36 **SECTION BC 410**
37 **STAGES~~AND~~, PLATFORMS AND TECHNICAL PRODUCTION AREAS**

38 **410.1 Applicability.** The provisions of Sections 410.1 through ~~[410.10]~~ 410.11 shall apply to all parts
39 of buildings and structures that contain stages or platforms and similar appurtenances as herein
40 defined.

1 **410.2 Definitions.** [~~The following words and terms shall, for the purposes of this section and as used~~
2 ~~elsewhere in this code, have the meanings shown herein.~~] This section contains terms defined
3 elsewhere in the code, and terms with definitions that are specific to this section.

4 **410.2.1 Terms defined elsewhere in the code.** The following terms are defined in Chapter 2:

5 **FLY GALLERY.** [~~A raised floor area above a stage from which the movement of scenery and~~
6 ~~operation of other stage effects are controlled.~~]

7 **GRIDIRON.** [~~The structural framing over a stage supporting equipment for hanging or flying~~
8 ~~scenery and other stage effects.~~]

9 **PINRAIL.** [~~A rail on or above a stage through which belaying pins are inserted and to which~~
10 ~~lines are fastened.~~]

11 [~~**PLATFORM.** A raised area within a building used for worship, the presentation of music, plays~~
12 ~~or other entertainment; the head table for special guests; the raised area for lecturers and~~
13 ~~speakers; boxing and wrestling rings; theater in the round stages; and similar purposes wherein~~
14 ~~there are no overhead hanging curtains, drops, scenery or stage effects other than lighting and~~
15 ~~sound. A temporary platform is one installed for not more than 30 days.~~]

16 **PROSCENIUM WALL.** [~~The wall that separates the stage from the auditorium or assembly~~
17 ~~seating area.~~]

18 **STAGE.** [~~A space within a building utilized for entertainment or presentations, which includes~~
19 ~~overhead hanging curtains, drops, scenery or stage effects other than lighting and sound.~~]

20 **TECHNICAL PRODUCTION AREA.**

21 **410.2.2 Definitions specific to this section.** The following term shall, for the purposes of this
22 section, have the meaning shown herein:

23 **PLATFORM.** A raised area within a building used for worship, the presentation of music, plays
24 or other entertainment; the head table for special guests; the raised area for lecturers and speakers;
25 boxing and wrestling rings; theater-in-the-round stages; and similar purposes wherein, other than
26 horizontal sliding curtains, there are no overhead hanging curtains, drops, scenery or stage effects
27 other than lighting and sound. A temporary platform is one installed for not more than 30 days.

28 **410.3 Stages.** Stage construction shall comply with Sections 410.3.1 through 410.3.7.

29 **410.3.1 Stage construction.** Stage floors shall be constructed of materials as required for floors
30 for the type of construction of the building in which such stages are located. Where areas below
31 the stage are used for other occupancies, such stage floor shall be constructed in accordance with
32 the requirements for separated occupancies as per Chapter 5.

33 **Exceptions:**

- 1 1. Stages of Type IIB or IV construction with a nominal 2-inch (51 mm) wood deck,
2 provided that the stage is separated from other areas in accordance with Section
3 410.3.4.
- 4 2. In all types of construction, the finished floor shall be constructed of wood or approved
5 noncombustible materials. Openings through stage floors shall be equipped with tight-
6 fitting, solid wood trap doors with approved safety locks. The room or space below
7 the stage into which the traps or lifts open shall be completely enclosed by
8 construction having at least the fire-resistance rating required for the stage floor, and
9 such room or space shall not be used as a workshop or storage area. Storage shall not
10 be deemed to include the location in this area of scenery or scenic elements used
11 during a performance. However, no combustible material that has a flame spread
12 rating greater than 25 or that has not been rendered flameproof in accordance with
13 the rules of the Fire Commissioner may be stored in this location at any time.

14 **410.3.1.1 Stage height and area.** Stage areas shall be measured to include the entire
15 performance area and adjacent backstage and support areas not separated from the
16 performance area by fire-resistance-rated construction. Stage height shall be measured from
17 the lowest point on the stage floor to the highest point of the roof or floor deck above the
18 stage.

19 **410.3.2 [Galleries] Technical production areas: galleries, gridirons, catwalks and pinrails.**
20 Beams designed only for the attachment of portable or fixed theater equipment, gridirons,
21 galleries and catwalks shall be constructed of noncombustible materials. Floors of fly galleries
22 and catwalks shall be constructed of noncombustible material. These areas shall not be
23 considered to be floors, stories, mezzanines or levels in applying this code.

24 **410.3.3 Exterior stage doors.** Where protection of openings is required, exterior exit doors shall
25 be protected with fire door assemblies that comply with Section ~~[715]~~ 716. Exterior openings that
26 are located on the stage for means of egress or loading and unloading purposes, and that are likely
27 to be open during occupancy of the theater, shall be constructed with vestibules to prevent air
28 drafts into the auditorium.

29 **410.3.4 Proscenium wall.** Where the stage height is greater than 40 feet (12 192 mm), all portions
30 of the stage shall be completely separated from the seating area by a proscenium wall with not
31 less than a 2-hour fire-resistance rating extending continuously from the foundation to the roof.

32 **410.3.5 Proscenium curtain.** Where a proscenium wall is required to have a fire-resistance
33 rating, the stage opening shall be provided with one of the following:

- 34 1. A fire curtain complying with NFPA 80; or
- 35 2. An approved stage water curtain and sprinklers complying with Section 410.7 and
36 Section 903.3.1.1 of this code, and the following:
 - 37 2.1. A deluge valve actuated by a “rate of rise system” and “fixed temperature system”
38 shall control the water curtain system;

- 1 2.2. The heat actuating devices shall be located on not more than 10-foot (3048 mm)
2 centers around the perimeter of the sprinklered area stage or as otherwise required
3 for the type of device used to assure operation of the system;
- 4 2.3. In addition to the automatic controls, manual-operating devices shall be located at
5 the voice/alarm communication system required by Section [410.8] 410.9, and
6 adjacent to at least one exit from the stage. Such exit shall be remote from the
7 voice/alarm communication system; ~~and~~
- 8 2.4. ~~[The operation of the deluge valve shall activate the emergency ventilating~~
9 ~~equipment required in Section 410.3.7 and the deluge valve shall be provided with~~
10 ~~central station supervision in addition to a local alarm.] All valves controlling~~
11 ~~deluge and sprinkler supplies on stages where the stage height is greater than 40~~
12 ~~feet (12 192 mm) shall be provided with tamper switches wired to an annunciator~~
13 ~~panel located at the voice/alarm communication system required by Section 410.9;~~
- 14 2.5 The operation of any section of the sprinkler system on stages where the stage
15 height is greater than 40 feet (12 192 mm) or the operation of the deluge system
16 shall activate the emergency ventilating equipment required in Section 410.3.7 and
17 shall be provided with central station supervision in addition to the required local
18 alarm; and
- 19 2.6 The water flow alarm, tamper switches, the sprinkler system on stages where the
20 stage height is greater than 40 feet (12 192 mm), and deluge system equipment
21 shall be provided with central station supervision in addition to the required local
22 alarm.

23 **410.3.6 Scenery.** All scenery or scenic elements shall be of noncombustible materials, or of
24 materials having a flame-spread rating not exceeding 25, or of materials that have been rendered
25 flameproof in compliance with the rules of the Fire Commissioner. Scenery and scenic elements
26 not complying with the above requirements may be used only when expressly permitted by the
27 Fire Department.

28 **410.3.7 Stage ventilation.** Emergency ventilation shall be provided for stages larger than 1,000
29 square feet (93 m²) in floor area, or with a stage height greater than 40 feet (12 192 mm). Such
30 ventilation shall comply with Section 410.3.7.1 or 410.3.7.2.

31 **410.3.7.1 Roof vents.** Two or more vents constructed to open automatically by approved heat-
32 activated devices and with an aggregate clear opening area of not less than 5 percent of the
33 area of the stage shall be located near the center and above the highest part of the stage area.
34 Supplemental means shall be provided for manual operation of the ventilator. Curbs shall be
35 provided as required for skylights in Section 2610.2. Vents shall be labeled.

36 **410.3.7.2 Smoke control.** Smoke control in accordance with Section 909 shall be provided to
37 maintain the smoke layer interface not less than 6 feet (1829 mm) above the highest level of
38 the assembly seating or above the top of the proscenium opening where a proscenium wall is
39 provided in compliance with Section 410.3.4.

1 **410.4 Platform construction.** Permanent platforms shall be constructed of materials as required for
2 the type of construction of the building in which the permanent platform is located. Permanent
3 platforms are permitted to be constructed in accordance with the following:

- 4 1. The area below the platform shall be enclosed on all sides with solid construction.
- 5 2. Platforms constructed of untreated wood shall not exceed an area of 400 square feet (37 m²).
6 Platforms constructed of fire-retardant-treated wood shall not exceed an area of 1,200 square
7 feet (111 m²). Platforms constructed of noncombustible materials shall not be limited in area.
- 8 3. Where wood is used, the floor of the platform shall be at least 1-inch (25 mm) nominal
9 thickness. Such floor shall be laid on a solid, noncombustible backing, or shall have all spaces
10 between supporting members fireblocked with noncombustible material.

11 Where the space beneath the permanent platform is used for storage or any other purpose other
12 than equipment, wiring or plumbing, the floor construction shall not be less than 1-hour fire-resistant-
13 rated construction. Where the space beneath the permanent platform is used only for equipment,
14 wiring or plumbing, the underside of the permanent platform need not be protected.

15 **410.4.1 Temporary platforms.** Platforms installed for a period of not more than 30 days are
16 permitted to be constructed of any materials permitted by ~~the~~ this code. The space between the
17 floor and the platform above shall only be used for plumbing and electrical wiring to platform
18 equipment.

19 **410.5 Dressing and appurtenant rooms.** Dressing and appurtenant rooms shall comply with
20 Sections 410.5.1 ~~through~~ and ~~[410.5-4]~~ 410.5.2.

21 **410.5.1 Separation from stage.** The stage shall be separated from dressing rooms, scene docks,
22 property rooms, workshops, storerooms and compartments appurtenant to the stage and other
23 parts of the building by fire barriers constructed in accordance with Section 707 or horizontal
24 assemblies constructed in accordance with Section ~~[712]~~ 711, or both. The ~~minimum~~ fire-
25 resistance rating shall be not less than 2 hours for stage heights greater than 50 feet (15 240 mm)
26 and not less than 1 hour for stage heights of 50 feet (15 240 mm) or less.

27 **410.5.2 Separation from each other.** Dressing rooms, scene docks, property rooms, workshops,
28 storerooms and compartments appurtenant to the stage shall be separated from each other by not
29 less than 1-hour fire barriers constructed in accordance with Section 707 or horizontal assemblies
30 constructed in accordance with Section ~~[712]~~ 711, or both.

31 **410.6 Means of egress.** Except as modified or as provided for in this section, the provisions of
32 Chapter 10 shall apply.

33 ~~[410.5.3 Stage exits. At least one approved means of egress shall be provided from each side of~~
34 ~~the stage; and from each side of the space under the stage. At least one means of escape shall be~~
35 ~~provided from each fly gallery and from the gridiron. A steel ladder, alternating tread device or~~
36 ~~spiral stairway is permitted to be provided from the gridiron to a scuttle in the stage roof.]~~ **410.6.1**
37 **Stage exits.** No fewer than one exit or exit access doorway shall be provided from each side of

1 the stage and from each side of the space under the stage. Technical production areas shall comply
2 with Section 410.6.3.

3 **410.6.2 Stairway and ramp enclosure.** Exit access stairways and ramps serving a stage or
4 platform are not required to be enclosed. Exit access stairways and ramps serving technical
5 production areas are not required to be enclosed.

6 **410.6.3 Technical production areas.** Technical production areas shall be provided with means
7 of egress and means of escape in accordance with Sections 410.6.3.1 through 410.6.3.5.

8 **410.6.3.1 Number of means of egress.** No fewer than one means of egress shall be provided
9 from technical production areas.

10 **410.6.3.2 Exit access travel distance.** The exit access travel distance shall be not greater than
11 300 feet (91 440 mm) for buildings without a sprinkler system and 400 feet (121 900 mm) for
12 buildings equipped throughout with an automatic sprinkler system in accordance with Section
13 903.3.1.1.

14 **410.6.3.3 Two means of egress.** Where two means of egress are required, the common path
15 of travel shall be not greater than 100 feet (30 480 mm).

16 **Exception:** A means of escape to a roof in place of a second means of egress is permitted.

17 **410.6.3.4 Path of egress travel.** The following exit access components are permitted where
18 serving technical production areas:

19 1. Stairways.

20 2. Ramps.

21 3. Spiral stairways.

22 4. Catwalks.

23 5. Alternating tread devices.

24 6. Permanent ladders.

25 **410.6.3.5 Width.** The path of egress travel within and from technical support areas shall be
26 not less than 22 inches (559 mm) in width.

27 ~~[410.6] **410.7 Automatic sprinkler system.** [Stages shall be equipped with an automatic fire-~~
28 ~~extinguishing system in accordance with Chapter 9. Sprinklers shall be installed under the roof and~~
29 ~~gridiron, and under all catwalks and galleries over the stage. Sprinklers shall be installed in dressing~~
30 ~~rooms, performer lounges, workshops and storerooms accessory to such stages:]~~

31 ~~[1. Automatic sprinklers shall be placed above all rigging lofts; and above all stage areas, other~~
32 ~~than those portions of stage areas specifically designated on approved plans as performing~~
33 ~~areas that do not have rigging lofts above and that are not at any time used for storage~~

1 purposes. Sprinklers above rigging lofts shall be located so that no gridiron or other
2 obstruction intervenes between the sprinkler heads and the scenery or scenic elements.]

3 [~~2. When openings are provided in the stage floor for stage lifts, trap doors or stairs, sprinklers
4 spaced 5 feet (1524 mm) on centers shall be provided around the opening at the ceiling below
5 the stage, and baffles at least 12 inches (305 mm) in depth shall be installed around the
6 perimeter of the opening.]~~

7 [~~3. All valves controlling sprinkler supplies shall be provided with tamper switches wired to an
8 annunciator panel located at the voice/alarm communication system required by Section
9 410.8.]~~

10 [~~4. The operation of any section of the sprinkler system and the deluge system shall activate the
11 emergency ventilating equipment required in Section 410.3.7 and shall be provided with
12 central station supervision in addition to the required local alarm.]~~

13 [~~5. The water flow alarm, tamper switches and deluge system equipment shall be provided with
14 central station supervision in addition to the required local alarm.]~~

15 An automatic sprinkler system in accordance with Section 903.3.1.1 shall be provided in the following
16 areas when located within a place of assembly:

17 1. Stages including those with stage height greater than 40 feet (12 192 mm);

18 2. Technical production areas over the stage including under the roof, above and below the
19 gridiron, catwalks and galleries;

20 3. Dressing rooms, performer lounges, shops and storerooms accessory to stages or platforms,
21 with live entertainment;

22 4. Platforms with live entertainment;

23 5. Cabarets; or

24 6. When openings are provided in the stage floor for stage lifts, trap doors or stairs, sprinklers
25 spaced 5 feet (1524 mm) on centers shall be provided around the opening at the ceiling below
26 the stage, and baffles at least 12 inches (305 mm) in depth shall be installed around the
27 perimeter of the opening.

28 **Exceptions:**

29 1. Sprinklers are not required under [~~stage areas~~] stages or platforms less than 4 feet (1219
30 mm) in clear height [~~utilized~~] that are utilized exclusively for storage of tables and chairs,
31 provided the concealed space is separated from the adjacent spaces by [~~not less than 5/8-~~
32 ~~inch (15.9 mm)]~~ Type X gypsum board not less than ⁵/₈ inch (15.9 mm) in thickness.

33 2. Sprinklers are not required within portable orchestra enclosures on stages.

34 [~~410.7~~] **410.8 Standpipes.** Standpipe systems shall be provided in accordance with Section 905.

1 ~~[410.8]~~ **410.9 Voice/alarm communication system.** Stages shall be provided with a voice/alarm
2 communication system in accordance with Section 907.2.1.1.

3 ~~[410.9]~~ **410.10 Construction in seating areas.** Construction in seating areas shall be in accordance
4 with Sections 410.10.1 and 410.10.2.

5 ~~[410.9.1]~~ **410.10.1 Scenery and scenic elements in seating areas.** Scenery or scenic elements
6 may be placed in seating sections if such elements:

- 7 1. Are noncombustible, or of materials that have been rendered flameproof in accordance
8 with the rules of the ~~[fire commissioner]~~ Fire Commissioner, or have a flame spread
9 rating of 25 or less.
- 10 2. Are adequately braced or secured.
- 11 3. Do not obstruct the required visibility of, or paths of travel to, exit openings.

12 ~~[410.9.2]~~ **410.10.2 Platforms or runways in seating areas.** Platforms or runways for
13 performances, to accommodate the operation of cameras, electronic equipment, or motion picture
14 projection machines not using carbon-arc or other light source that emits a gaseous discharge
15 may be constructed in seating sections, provided such platforms or runways comply with the
16 requirements of Section 410.4, except Item 1, and Section ~~[410.8]~~ 410.9.

17 ~~[410.10]~~ **410.11 Stage lighting.** Stage lights shall be placed such that they will not develop
18 temperatures on the surface of any material that will cause that material to ignite, or smoke, or cause
19 its flameproofing to deteriorate.

20 **SECTION BC 411**
21 **SPECIAL AMUSEMENT BUILDINGS**

22 **411.1 General.** Special amusement buildings having an occupant load of 75 or more shall comply
23 with the requirements for the appropriate Group A occupancy and Sections 411.1 through 411.8.
24 ~~[Amusement]~~ Special amusement buildings having an occupant load of less than 75 shall comply
25 with the requirements for a Group B occupancy and Sections 411.1 through 411.8.

26 **Exception:** ~~[Amusement]~~ Special amusement buildings or portions thereof that are without walls
27 or a roof and constructed to prevent the accumulation of smoke. All decorative material shall be
28 noncombustible or composed of flame-retardant fabric.

29 **411.2 [Definition] Definitions.** The following ~~[word and]~~ term ~~[shall, for the purpose of this section~~
30 ~~and as used elsewhere]~~ is defined in ~~[this code, have the meaning shown herein.]~~ Chapter 2:

31 **SPECIAL AMUSEMENT BUILDING.** ~~[A special amusement building is any temporary or~~
32 ~~permanent building or portion thereof that is occupied for amusement, entertainment or educational~~
33 ~~purposes and that contains a device or system that conveys passengers or provides a walkway along,~~
34 ~~around or over a course in any direction so arranged that the means of egress path is not readily~~
35 ~~apparent due to visual or audio distractions or is intentionally confounded or is not readily available~~
36 ~~because of the nature of the attraction or mode of conveyance through the building or structure.]~~

1 **411.3 Automatic fire detection.** Special amusement buildings shall be equipped with an automatic
2 fire detection system[~~]~~ in accordance with Section 907.

3 **411.4 Automatic sprinkler system.** Special amusement buildings shall be equipped throughout with
4 an automatic sprinkler system in accordance with Section 903.3.1.1. Where the special amusement
5 building is temporary, the sprinkler water supply shall be of an approved temporary means.

6 **Exception:** Automatic [~~fire~~] sprinklers are not required where the total floor area of a temporary
7 special amusement building is less than 1,000 square feet (93 m²) and the exit access travel
8 distance from any point to an exit is less than 50 feet (15 240 mm).

9 **411.5 Alarm.** Actuation of a single smoke detector, the automatic sprinkler system or other automatic
10 fire detection device shall [~~immediately sound an alarm at the building~~] initiate a pre-signal system
11 in accordance with NFPA 72 as modified by Appendix Q of this code at a constantly attended location
12 from which [~~emergency action can be~~] the Fire Department shall be notified and live voice evacuation
13 instructions shall be initiated [including the capability of manual initiation of requirements] using an
14 emergency voice/alarm communications system in accordance with Section [~~907.2.12.2~~] 907.5.2.2.

15 **411.6 Emergency voice/alarm communications system.** An emergency voice/alarm
16 communications system shall be provided in accordance with Sections [~~907.2.12.3~~] 907.2.12 and
17 907.5.2.2, which is also permitted to serve as a public address system and shall be audible throughout
18 the entire special amusement building.

19 **411.7 Exit marking.** Exit signs shall be installed at the required exit or exit access doorways of
20 amusement buildings in accordance with this section and Section [~~1011~~] 1013 of this code. Approved
21 directional exit markings listed in accordance with UL 1994, shall also be provided. Where mirrors,
22 mazes or other designs are utilized that disguise the path of egress travel such that they are not
23 apparent, approved low-level exit signs that comply with Section [~~1011.4~~] 1013.5 of this code, and
24 directional path markings shall be provided and located not more than 8 inches (203 mm) above the
25 walking surface and on or near the path of egress travel. Such markings shall become visible in an
26 emergency. The directional exit marking shall be activated by the automatic fire detection system and
27 the automatic sprinkler system in accordance with Section 907.2.12.2.

28 **411.8 Interior finish.** The interior finish shall be Class A in accordance with Section 803.1.

29 **SECTION BC 412**
30 **AIRCRAFT-RELATED OCCUPANCIES**

31 **412.1 General.** Aircraft-related occupancies shall comply with [~~Sections 412.1 through 412.7 and~~]
32 the New York City Fire Code and Sections 412.1 through 412.8 of this code.

33 **412.2 Definitions.** The following [~~words and~~] terms [~~shall, for the purposes of this chapter and as~~
34 ~~used elsewhere in this code, have the meanings shown herein.~~] are defined in Chapter 2:

35 **FIXED BASE OPERATOR (FBO).** [~~A commercial business granted the right by the airport sponsor~~
36 ~~to operate on an airport and provide aeronautical services, such as fueling, hangaring, tie-down and~~
37 ~~parking, aircraft rental, aircraft maintenance and flight instruction.]~~

1 **HELIPORT.** [~~An area of land or water or a structural surface that is used, or intended for the use,~~
2 ~~for the landing and taking off of helicopters, and any appurtenant areas that are used, or intended for~~
3 ~~use, for heliport buildings or other heliport facilities.]~~

4 **HELISTOP.** [~~The same as “heliport,” except that no fueling, defueling, maintenance, repairs or~~
5 ~~storage of helicopters is permitted.]~~

6 **RESIDENTIAL AIRCRAFT HANGAR.** [~~An accessory building less than 2,000 square feet (186~~
7 ~~m²) and 20 feet (6096 mm) in building height constructed on a one or two family property where~~
8 ~~aircraft are stored. Such use will be considered as a residential accessory use incidental to the~~
9 ~~dwelling.]~~

10 **TRANSIENT AIRCRAFT.** [~~Aircraft based at another location and that is at the transient location~~
11 ~~for not more than 90 days.]~~

12 **412.3 Airport traffic control towers.**

13 [~~412.3.1 General.~~] The provisions of Sections 412.3.1 through [~~412.3.6]~~ 412.3.9 shall apply to airport
14 traffic control towers [~~not exceeding 1,500 square feet (140 m²) per floor]~~ occupied only for the
15 following uses:

- 16 1. Airport traffic control cab.
- 17 2. Electrical and mechanical equipment rooms.
- 18 3. Airport terminal radar and electronics rooms.
- 19 4. Office spaces incidental to the tower operation.
- 20 5. Lounges for employees, including sanitary facilities.

21 [~~412.3.2]~~ **412.3.1 Type of construction.** Airport traffic control towers shall be constructed to
22 comply with the height [~~and area]~~ limitations of Table [~~412.3.2]~~ 412.3.1.

23 **TABLE [~~412.3.2]~~ 412.3.1**
24 **HEIGHT [~~AND AREA]~~ LIMITATIONS FOR**
25 **AIRPORT TRAFFIC CONTROL TOWERS**

TYPE OF CONSTRUCTION	HEIGHT ^a (feet)	[MAXIMUM AREA (square feet)]
IA	Unlimited	[1,500]
IB	240	[1,500]
IIA	100	[1,500]
IIB	85	[1,500]
IIIA	65	[1,500]

26
27 For SI: 1 foot = 304.8 mm, 1 square foot = 0.0929 m².
28 a. Height to be measured from grade plane to cab floor.

1
2 ~~[412.3.3 Egress. A minimum of one exit stairway shall be permitted for airport traffic control~~
3 ~~towers of any height provided that the occupant load per floor does not exceed 15. The stairway~~
4 ~~shall conform to the requirements of Section 1009. The stairway shall be separated from elevators~~
5 ~~by a minimum distance of one-half of the diagonal of the area served measured in a straight line.~~
6 ~~The exit stairway and elevator hoistway are permitted to be located in the same shaft enclosure,~~
7 ~~provided they are separated from each other by a 4-hour fire barrier having no openings. Such~~
8 ~~stairway shall be pressurized to a minimum of 0.15 inch of water column (43 Pa) and a maximum~~
9 ~~of 0.35 inch of water column (101 Pa) in the shaft relative to the building with stairway doors~~
10 ~~closed. Stairways need not extend to the roof as specified in Section 1009.13. The provisions of~~
11 ~~Section 403 do not apply.]~~

12 ~~[Exception: Smokeproof enclosures as set forth in Section 1022.9 are not required where~~
13 ~~required stairways are pressurized.]~~

14 412.3.2 Stairways. Stairways in airport traffic control towers shall be in accordance with Section
15 1011. Stairways in airport traffic control towers are not required to comply with Section 1011.12.
16 Stairways shall be smokeproof enclosures complying with one of the alternatives provided in
17 Section 909.20. The stairway shall be separated from elevators by a minimum distance of one-
18 half of the diagonal of the area served measured in a straight line.

19 Exception: The stairway and elevator hoistway are permitted to be located in the same shaft
20 enclosure without the minimum separation distance, provided they are separated from each
21 other by a 4-hour fire barrier having no openings. Such stairway shall be pressurized to a
22 minimum of 0.15 inch of water column (43 Pa) and a maximum of 0.35 inch of water column
23 (101 Pa) in the shaft relative to the building with stairway doors closed.

24 412.3.3 Exit access. From observation levels, airport traffic control towers shall be permitted to
25 have a single means of exit access for a distance of travel not greater than 100 feet (30 480 mm).
26 Exit access stairways from the observation level need not be enclosed.

27 412.3.4 Number of exits. Not less than one exit stairway shall be permitted for airport traffic
28 control towers of any height provided that the occupant load per floor is not greater than 15 and
29 the area per floor does not exceed 1,500 square feet (140 m²).

30 412.3.4.1 Interior finish. Where an airport traffic control tower is provided with only one
31 exit stairway, interior wall and ceiling finishes shall be either Class A or Class B.

32 ~~[412.3.4]~~ 412.3.5 Automatic fire detection systems. Airport traffic control towers shall be
33 provided with an automatic fire detection system installed in accordance with Section 907.2.

34 ~~[412.3.5 Standby power.~~ A standby power system that conforms to Chapter 27 shall be provided
35 in airport traffic control towers more than 65 feet (19 812 mm) in height. Power shall be provided
36 to the following equipment:

- 37 1. ~~Pressurization equipment, mechanical equipment and lighting.~~
38 2. ~~Elevator operating equipment.~~

1 3. ~~Fire alarm and smoke detection systems.]~~

2 **412.3.6 Automatic sprinkler system.** Where an occupied floor is located more than 35 feet (10
3 668 mm) above the lowest level of fire department vehicle access, airport traffic control towers
4 shall be equipped with an automatic sprinkler system in accordance with Section 903.3.1.1.

5 **412.3.7 Elevator protection.** Wires or cables that provide normal or standby power, control
6 signals, communication with the car, lighting, heating, air conditioning, ventilation and fire
7 detecting systems to elevators shall be protected by construction having a fire-resistance rating of
8 not less than 1 hour, or shall be circuit integrity cable having a fire-resistance rating of not less
9 than 1 hour.

10 **412.3.7.1 Elevators for occupant evacuation.** Where provided in addition to an exit
11 stairway, occupant evacuation elevators shall be in accordance with Section 3008.

12 ~~[412.3.6]~~ **412.3.8 Accessibility.** Airport traffic control towers need not be accessible as specified
13 in the provisions of Chapter 11.

14 **412.3.9 Standby power and emergency power.** A standby power system and an emergency
15 power system that conform to Chapter 27 shall be provided in airport traffic control towers more
16 than 65 feet (19 812 mm) in height. Standby power shall be provided to the following equipment:

- 17 1. Pressurization equipment and mechanical equipment provided in accordance with Section
18 412.3.2.
- 19 2. Elevator operating equipment.
- 20 3. Fire alarm and smoke detection systems.

21 **412.3.9.1 Means of egress illumination.** Emergency power shall be provided for means of
22 egress illumination in accordance with Sections 1008.3.4 and 1008.3.5.

23 **412.4 Aircraft hangars.** Aircraft hangars shall be in accordance with Sections 412.4.1 through
24 412.4.6.

25 **412.4.1 Exterior walls.** Exterior walls located less than 30 feet (9144 mm) from lot lines or a
26 public way shall have a fire-resistance rating not less than 2 hours.

27 **412.4.2 Basements.** Where hangars have basements, floors over basements shall be of Type IA
28 construction and shall be made tight against seepage of water, oil or vapors. There shall be no
29 opening or communication between basements and the hangar. Access to basements shall be from
30 outside only.

31 **412.4.3 Floor surface.** Floors shall be graded and drained to prevent water or fuel from remaining
32 on the floor. Floor drains shall discharge through an oil separator to the sewer or to an outside
33 vented sump.

Exception: Aircraft hangars with individual lease spaces not exceeding 2,000 square feet (186 m²) each in which servicing, repairing or washing is not conducted and fuel is not dispensed shall have floors that are graded toward the door, but shall not require a separator.

412.4.4 Heating equipment. Heating equipment shall be placed in another room separated by 2-hour fire barriers constructed in accordance with Section 707 or horizontal assemblies constructed in accordance with Section ~~712~~ 711, or both. Entrance shall be from the outside or by means of a vestibule providing a two-doorway separation.

Exceptions:

1. Unit heaters and vented infrared radiant heating equipment suspended [~~at least~~] not less than 10 feet (3048 mm) above the upper surface of wings or engine enclosures of the highest aircraft that are permitted to be housed in the hangar [~~and at least~~] need not be located in a separate room provided they are mounted not less than 8 feet (2438 mm) above the floor in shops, offices and other sections of the hangar communicating with storage or service areas.
2. [~~A~~] Entrance to the separated room shall be permitted by a single interior door [shall be allowed,] provided the sources of ignition in the appliances are [~~at least~~] not less than 18 inches (457 mm) above the floor.

412.4.5 Finishing. The process of “doping,” involving use of a volatile flammable solvent, or of painting, shall be carried on in a separate detached building equipped with automatic fire-extinguishing equipment in accordance with Section 903.

412.4.6 Fire suppression. Aircraft hangars shall be provided with a fire suppression system designed in accordance with NFPA 409, based upon the classification for the hangar given in Table 412.4.6 of this code.

Exception: [~~When~~] Where a fixed base operator has separate repair facilities on site, Group II hangars operated by a fixed base operator used for storage of transient aircraft only shall have a fire suppression system, but the system is exempt from foam requirements.

**TABLE 412.4.6
HANGAR FIRE SUPPRESSION REQUIREMENTS^{A,B,C}**

MAXIMUM SINGLE FIRE AREA [(SQ. FT.)] (square feet)	TYPE OF CONSTRUCTION								
	IA	IB	IIA	IIB	IIIA	IIIB	IV	VA ^d	VB ^d
[>] ≥ 40,001	Group I	Group I	Group I	Group I	Group I	Group I	Group I	Group I	Group I
40,000	Group II	Group II	Group II	Group II	Group II	Group II	Group II	Group II	Group II
30,000	Group III	Group II	Group II	Group II	Group II	Group II	Group II	Group II	Group II
20,000	Group III	Group III	Group II	Group II	Group II	Group II	Group II	Group II	Group II

MAXIMUM SINGLE FIRE AREA [(SQ. FT.)] (square feet)	TYPE OF CONSTRUCTION								
	IA	IB	IIA	IIB	IIIA	IIIB	IV	VA ^d	VB ^d
15,000	Group III	Group III	Group III	Group II	Group III	Group II	Group III	Group II	Group II
12,000	Group III	Group III	Group III	Group III	Group III	Group III	Group III	Group II	Group II
8,000	Group III	Group III	Group III	Group III	Group III	Group III	Group III	Group III	Group II
5,000	Group III	Group III	Group III	Group III	Group III	Group III	Group III	Group II	Group II

For SI: 1 foot = 304.8 mm, 1 square foot = 0.0929m².

- a. Aircraft hangars with a door height greater than 28 feet shall be provided with fire suppression for a Group I hangar regardless of maximum fire area.
- b. Groups shall be as classified in accordance with NFPA 409.
- c. Membrane structures complying with Section 3102 shall be classified as a Group IV hangar.
- d. Construction Types VA and VB are not permitted in Fire Districts. See [BC Table 503] Tables 504.3, 504.4 and 506.2.

412.4.6.1 Hazardous operations. Any Group III aircraft hangar according to Table 412.4.6 that contains hazardous operations including, but not limited to, the following shall be provided with a Group I or II fire suppression system in accordance with NFPA 409 as applicable:

1. Doping.
2. Hot work including, but not limited to, welding, torch cutting and torch soldering.
3. Fuel transfer.
4. Fuel tank repair or maintenance not including defueled tanks in accordance with NFPA 409, inerted tanks or tanks that have never been fueled.
5. Spray finishing operations.
6. Total fuel capacity of all aircraft within the unsprinklered single fire area in excess of 1,600 gallons (6057 L).
7. Total fuel capacity of all aircraft within the maximum single fire area in excess of 7,500 gallons (28 390 L) for a hangar with an automatic sprinkler system in accordance with Section 903.3.1.1.

412.4.6.2 Separation of maximum single fire areas. Maximum single fire areas established in accordance with hangar classification and construction type in Table 412.4.6 shall be separated by 2-hour fire walls constructed in accordance with Section 706. In determining the maximum single fire area as set forth in Table 412.4.6, ancillary uses that are separated from aircraft servicing areas by a fire barrier of not less than 1 hour, constructed in accordance with Section 707, shall not be included in the area.

412.5 Residential aircraft hangars. Residential aircraft hangars [as defined in Section 412.2] shall comply with Sections 412.5.1 through [412.5.2] 412.5.5.

1 **412.5.1 Fire separation.** A hangar shall not be attached to a dwelling unless separated by a fire
2 barrier having a fire-resistance rating of not less than 1 hour. Such separation shall be continuous
3 from the foundation to the underside of the roof and unpierced except for doors leading to the
4 dwelling unit. Doors into the dwelling unit ~~[must]~~ shall be equipped with self-closing devices
5 and conform to the requirements of Section ~~[715]~~ 716 with ~~[at least a 4 inch (102 mm)]~~ a
6 noncombustible raised sill not less than 4 inches (102 mm) in height. Openings from a ~~[hanger]~~
7 hangar directly into a room used for sleeping purposes shall not be permitted.

8 **412.5.2 Egress.** A hangar shall provide two means of egress. One of the doors into the dwelling
9 shall be considered as meeting only one of the two means of egress.

10 **412.5.3 Smoke alarms.** Smoke alarms shall be provided within the hangar in accordance with
11 Section ~~[907.2.11]~~ 907.2.11.

12 **412.5.4 Independent systems.** Electrical, mechanical and plumbing drain, waste and vent (DWV)
13 systems installed within the hangar shall be independent of the systems installed within the
14 dwelling. Building sewer lines shall be permitted to be connected outside the structures.

15 **Exception:** Smoke detector wiring and feed for electrical subpanels in the hangar.

16 **412.5.5 Height and area limits.** Residential aircraft hangars shall be not ~~[exceed]~~ greater than
17 2,000 square feet (186 m²) in area and 20 feet (6096 mm) in building height.

18 **412.6 Aircraft paint hangars.** Aircraft painting operations where flammable liquids are used in
19 excess of the maximum allowable quantities per control area listed in Table ~~[307.7(1)]~~ 307.1(1) shall
20 be conducted in an aircraft paint hangar that complies with the provisions of Sections 412.6.1 through
21 412.6.6.

22 **412.6.1 Occupancy group.** Aircraft paint hangars shall be classified as Group H-2. Aircraft paint
23 hangars shall comply with the applicable requirements of ~~[this code and]~~ the *New York City Fire*
24 *Code* and this code for such occupancy.

25 **412.6.2 Construction.** The aircraft paint hangar shall be of Type I or II construction.

26 **412.6.3 Operations.** Only those flammable liquids necessary for painting operations shall be
27 permitted in quantities less than the maximum allowable quantities per control area in Table
28 307.1(1). Spray equipment cleaning operations shall be conducted in a liquid use, dispensing and
29 mixing room.

30 **412.6.4 Storage.** Storage of flammable liquids shall be in a liquid storage room.

31 **412.6.5 Fire suppression.** Aircraft paint hangars shall be provided with fire suppression as
32 required by NFPA 409.

33 **412.6.6 Ventilation.** Aircraft paint hangars shall be provided with ventilation as required in the
34 *New York City Mechanical Code*.

1 **412.7 Aircraft manufacturing facilities.** In buildings used for the manufacturing of aircraft, exit
 2 access travel distances indicated in Section 1017.1 shall be increased in accordance with the
 3 following:

- 4 1. The building shall be of Type I or II construction.
- 5 2. Exit access travel distance shall not exceed the distances given in Table 412.7.

6 **TABLE 412.7**
 7 **AIRCRAFT MANUFACTURING EXIT ACCESS TRAVEL DISTANCE**

HEIGHT (feet)^b	MANUFACTURING AREA (sq. ft.)^a					
	≥ 150,000	≥ 200,000	≥ 250,000	≥ 500,000	≥ 750,000	≥ 1,000,000
≥ 25	400	450	500	500	500	500
≥ 50	400	500	600	700	700	700
≥ 75	400	500	700	850	1,000	1,000
≥ 100	400	500	750	1,000	1,250	1,500

8 For SI: 1 foot = 304.8 mm.

- 9 a. Contiguous floor area of the aircraft manufacturing facility having the indicated height.
- 10 b. Minimum height from finished floor to bottom of ceiling or roof slab or deck.

11
 12
 13 **412.7.1 Ancillary areas.** Rooms, areas and spaces ancillary to the primary manufacturing area
 14 shall be permitted to egress through such area having a minimum height as indicated in Table
 15 412.7. Exit access travel distance within the ancillary room, area or space shall not exceed that
 16 indicated in Table 1017.2 based on the occupancy classification of that ancillary area. Total exit
 17 access travel distance shall not exceed that indicated in Table 412.7.

18 **412.8 Heliports and helistops.** Heliports and helistops ~~may~~ shall be permitted to be erected on
 19 buildings or other locations where they are constructed in accordance with Sections [412.7.4] 412.8.1
 20 through [412.7.4] 412.8.5.

21 ~~[412.7.1]~~ **412.8.1 Size.** The ~~touchdown or~~ landing area for helicopters ~~of~~ less than 3,500
 22 pounds (1588 kg) shall be ~~a minimum of~~ not less than 20 feet (6096 mm) in length and width.
 23 The ~~touchdown~~ landing area shall be surrounded on all sides by a clear area having a minimum
 24 average width at roof level of 15 feet (4572 mm) but with no width less than 5 feet (1524 mm).

25 ~~[412.7.2]~~ **412.8.2 Design.** Helicopter landing areas and the supports thereof on the roof of a
 26 building shall be noncombustible construction. Landing areas shall be designed to confine any
 27 flammable liquid spillage to the landing area itself and provisions shall be made to drain such
 28 spillage away from any exit or stairway serving the helicopter landing area or from a structure
 29 housing such exit or stairway. For structural design requirements, see Section ~~[4605.4]~~ 1607.6.

30 ~~[412.7.3]~~ **412.8.3 Means of egress.** The means of egress from heliports and helistops shall comply
 31 with the provisions of Chapter 10. Landing areas located on buildings or structures shall have two
 32 or more means of egress. For landing ~~platforms or roof~~ areas less than 60 feet (18 288 mm) in
 33 length~~;~~ or less than 2,000 square feet (186 m²) in area, the second means of egress is permitted
 34 to be a fire escape, alternating tread device~~;~~ or ladder leading to the floor below.

1 **[412.7.4] 412.8.4 Rooftop heliports and helistops.** Rooftop heliports and helistops shall comply
2 with NFPA 418 and the *New York City Fire Code*.

3 **412.8.5 Standpipe system.** In buildings equipped with a standpipe system, the standpipe shall
4 extend to the roof level in accordance with Section 905.3.6.

5 **SECTION BC 413**
6 **COMBUSTIBLE STORAGE**

7 **413.1 General.** Storage of combustible materials in attics, under-floor spaces, concealed spaces, and
8 below-grade storage rooms shall comply with this section.

9 **413.2 Attic, under-floor and concealed spaces.** Attic, under-floor and concealed spaces used for
10 storage of combustible materials shall be protected on the storage side as required for 1-hour [~~fire-~~
11 ~~resistant~~] fire-resistance-rated construction. Openings shall be protected by assemblies that are self-
12 closing and are of noncombustible construction or solid wood core not less than 1³/₄ inch (45 mm) in
13 thickness.

14 **[Exceptions] Exception:** Neither fire-resistance-rated construction nor opening protectives are
15 required in any of the following locations:

- 16 1. Areas protected by approved automatic sprinkler systems.
- 17 2. Group R-3 and U occupancies.

18 **413.3 High-piled stock or rack storage.** High-piled stock or rack storage in any occupancy group
19 shall comply with the *New York City Fire Code*, including the requirement for permit approval.

20 **SECTION BC 414**
21 **HAZARDOUS MATERIALS**

22 **414.1 General.** The provisions of Sections 414.1 through [414.7] 414.6 shall apply to buildings and
23 structures occupied for the manufacturing, processing, dispensing, use or storage of hazardous
24 materials.

25 **414.1.1 Other provisions.** Buildings and structures with an occupancy in Group H shall [~~also~~]
26 comply with this section and the applicable provisions of the *New York City Fire Code* and
27 Section 415 of this code, including, but not limited to, location, installation and mechanical
28 provisions.

29 **414.1.2 Materials.** The safe design of hazardous material occupancies is material dependent.
30 Individual material requirements are also found in the *New York City Mechanical Code*, the *New*
31 *York City Fire Code*, and Sections 307 and 415 of this code.

32 **414.1.2.1 Aerosols.** Level 2 and 3 aerosol products shall be stored and displayed in accordance
33 with the *New York City Fire Code*. See the *New York City Fire Code* and Section 311.2 of this
34 code for occupancy group requirements.

1 **414.1.3 Information required.** A report shall be submitted to the [~~department~~] Fire Department
2 identifying the maximum expected quantities of hazardous materials to be stored, used in a closed
3 system and used in an open system, and subdivided to separately address hazardous material
4 classification categories based on Tables 307.1(1) and 307.1(2). The methods of protection from
5 such hazards, including but not limited to control areas, fire protection systems and Group H
6 occupancies shall be indicated in the report and on the construction documents. The opinion and
7 report shall be prepared by a qualified person, firm or corporation approved by the [~~commissioner~~]
8 Fire Commissioner and [~~shall be~~] provided without charge to the [~~department~~] Fire Department.

9 For buildings and structures with an occupancy in Group H, separate floor plans shall be
10 submitted identifying the locations of anticipated contents and processes so as to reflect the nature
11 of each occupied portion of every building and structure.

12 **414.2 Control areas.** Control areas shall comply with the *New York City Fire Code* and Sections
13 414.2.1 through 414.2.5 of this code.

14 **414.2.1 Construction requirements.** Control areas shall be separated from each other by fire
15 barriers constructed in accordance with [~~Sections~~] Section 707 or horizontal assemblies
16 constructed in accordance with Section [~~712~~] 711, or both.

17 **414.2.2 Percentage of maximum allowable quantities.** The percentage of maximum allowable
18 quantities of hazardous materials per control area permitted at each floor level within a building
19 shall be in accordance with Table 414.2.2.

20

**TABLE 414.2.2
DESIGN AND NUMBER OF CONTROL AREAS**

FLOOR LEVEL		PERCENTAGE OF THE MAXIMUM ALLOWABLE QUANTITY PER CONTROL AREA ^a	NUMBER OF CONTROL AREAS PER FLOOR ^b	FIRE-RESISTANCE RATING FOR FIRE BARRIERS IN HOURS ^b
Above grade	Higher than 9	5	1	2
	7-9	5	2	2
	6	12.5	2	2
	5	12.5	2	2
	4	12.5	2	2
	3	50	2	1
	2	75	3	1
	1	100	4	1
Below grade	1	75	3	1
	2	50	2	1
	Lower than 2	Not Allowed	Not Allowed	Not Allowed

- a. Percentages shall be of the maximum allowable quantity per control area shown in Tables 307.1(1) and 307.1(2), with all increases allowed in the notes to those tables.
- b. ~~[Fire] Separation shall include fire barriers and [shall include walls and floors] horizontal assemblies~~ as necessary to provide separation from other portions of the building.

414.2.3 Number. The maximum number of control areas within a building shall be in accordance with Table 414.2.2.

414.2.4 Fire-resistance-rating requirements. The required fire-resistance rating for fire barriers shall be in accordance with Table 414.2.2. The floor assembly of the control area [;] and the construction supporting the floor of the control area [;] shall have a [~~minimum 2-hour~~] fire-resistance rating [~~and shall comply with the requirements of the New York City Fire Code~~] of not less than 2 hours.

Exception: The floor assembly of the control area and the construction supporting the floor of the control area are allowed to be 1-hour fire-resistance rated in buildings of Types IIA, IIIA and VA construction, provided that both of the following conditions exist:

1. The building is equipped throughout with an automatic sprinkler system in accordance with Section 903.3.1.1; and
2. The building is three or fewer stories above grade plane.

414.2.5 Hazardous material in Group M display and storage areas and in Group S storage areas. The aggregate quantity of nonflammable solid and nonflammable or noncombustible liquid hazardous materials permitted within a single control area of a Group M display and storage area, a Group S storage area or an outdoor control area is permitted to exceed the maximum allowable quantities per control area specified in Tables 307.1(1) and 307.1(2) without classifying the building or use as a Group H occupancy, provided that the materials are displayed and stored in accordance with the *New York City Fire Code* and quantities do not exceed the maximum allowable specified in Table 414.2.5(1) of this code.

In Group M occupancy wholesale and retail sales uses, indoor storage of flammable and combustible liquids shall not exceed the maximum allowable quantities per control area as indicated in Table 414.2.5(2) of this code, provided that the materials are displayed and stored in accordance with the *New York City Fire Code*.

1 The maximum quantity of aerosol products in Group M occupancy retail display areas, storage
 2 areas adjacent to retail display areas and retail storage areas shall be in accordance with the *New*
 3 *York City Fire Code*.

4 **414.2.5.1 Below-grade storage of flammable or combustible mixtures accessory to Group**
 5 **M establishments.** Class I liquids shall not be stored in below-grade locations. Storage of
 6 Class II and Class III liquids, accessory to retail stores, and partly or completely below grade
 7 shall be permitted, provided that such below-grade area is equipped throughout with an
 8 automatic sprinkler system in accordance with Section 903.3.1.1 and enclosed by fire barriers
 9 having a fire-resistance rating of at least 2 hours, constructed in accordance with the
 10 construction type of the building. Openings shall be protected by self-closing assemblies
 11 having a fire-resistance rating of at least 1½ hours.

12 **Exception:** Class IIIB liquids may be stored in below-grade locations that are not
 13 provided throughout with an automatic sprinkler system when such liquids are stored in
 14 a room that is separated, vertically and horizontally, from surrounding spaces by fire
 15 barriers of not less than 2-hour fire-resistance rating and such room is provided with an
 16 automatic sprinkler system.

17 **TABLE [414.2.5.(1)] 414.2.5(1)**
 18 **MAXIMUM ALLOWABLE QUANTITY PER INDOOR AND OUTDOOR CONTROL AREA IN GROUP M**
 19 **AND S OCCUPANCIES NONFLAMMABLE SOLIDS AND NONFLAMMABLE AND NONCOMBUSTIBLE**
 20 **LIQUIDS^{D,E,F}**

CONDITION		MAXIMUM ALLOWABLE QUANTITY PER CONTROL AREA	
Material ^a	Class	Solids pounds	Liquids gallons
A. Health-hazard materials—nonflammable and noncombustible solids and liquids			
1. Corrosives ^{b,c}	Not Applicable	9,750	975
2. Highly toxics	Not Applicable	20 ^{b,c}	2 ^{b,c}
3. Toxics ^{b,c}	Not Applicable	1,000	100
B. Physical-hazard materials—nonflammable and noncombustible solids and liquids			
1. Oxidizers ^{b,c}	4	Not Allowed	Not Allowed
	3	1,150 ^g	115
	2	2,250 ^h	225
	1	18,000 ^{i,j}	18,000 ^{i,j}
2. [Nondetonable unstable] <u>Unstable</u> (reactives) ^{b,c}	4	Not Allowed	Not Allowed
	3	550	55
	2	1,150	115
	1	Not Limited	Not Limited

CONDITION		MAXIMUM ALLOWABLE QUANTITY PER CONTROL AREA	
Material ^a	Class	Solids pounds	Liquids gallons
3. [Nondetonable water-] Water reactives	3 ^{b,c}	550	55
	2 ^{b,c}	1,150	115
	1	Not Limited	Not Limited

For SI: 1 pound = 0.454 kg, 1 gallon = 3.785 L.

- Hazard categories are as specified in the *New York City Fire Code*.
- Maximum allowable quantities shall be increased 100 percent in buildings that are sprinklered in accordance with Section 903.3.1.1. When Note c also applies, the increase for both notes shall be applied accumulatively.
- Maximum allowable quantities shall be increased 100 percent when stored in approved storage cabinets, in accordance with the *New York City Fire Code*. When Note b also applies, the increase for both notes shall be applied accumulatively.
- See Table 414.2.2 for design and number of control areas.
- Allowable quantities for other hazardous material categories shall be in accordance with Section 307.
- Maximum quantities shall be increased 100 percent in outdoor control areas.
- Maximum amounts [are permitted to] shall be increased to 2,250 pounds when individual packages are in the original sealed containers from the manufacturer or packager and do not exceed 10 pounds each.
- Maximum amounts [are permitted to] shall be increased to 4,500 pounds when individual packages are in the original sealed containers from the manufacturer or packager and do not exceed 10 pounds each.
- The permitted quantities shall not be limited in a building equipped throughout with an automatic sprinkler system in accordance with Section 903.3.1.1.
- Quantities are unlimited in an outdoor control area.

TABLE 414.2.5(2)
MAXIMUM ALLOWABLE QUANTITY OF FLAMMABLE AND
COMBUSTIBLE LIQUIDS IN WHOLESALE AND RETAIL SALES OCCUPANCIES PER
CONTROL AREA^A

TYPE OF LIQUID	MAXIMUM ALLOWABLE QUANTITY PER CONTROL AREA (gallons)		
	Sprinklered in accordance with note b densities and arrangements	Sprinklered in accordance with Tables 3404.3.6.3(4) through 3404.3.6.3(8) and Table 3404.3.7.5.1 of the <i>New York City Fire Code</i>	Nonsprinklered
Class IA	60	60	30
Class IB, IC, II and IIIA	7,500 ^c	15,000 ^c	1,600
Class IIIB	Unlimited	Unlimited	13,200

For SI: 1 foot = 304.8 mm, 1 square foot = 0.0929m², 1 gallon = 3.785 L, 1 gallon per minute per square foot = 40.75 L/min/m².

- Control areas shall be separated from each other by not less than a 1-hour fire barrier wall.
- To be considered as sprinklered, a building shall be equipped throughout with an approved automatic sprinkler system with a design providing minimum densities as follows:
 - For uncartoned commodities on shelves 6 feet or less in height where the ceiling height does not exceed 18 feet, quantities are those permitted with a minimum sprinkler design density of Ordinary Hazard Group 2.
 - For cartoned, palletized or racked commodities where storage is 4 feet 6 inches or less in height and where the ceiling height does not exceed 18 feet, quantities are those permitted with a minimum sprinkler design density of 0.21 gallon per minute per square foot over the most remote 1,500-square-foot area.
- Where wholesale and retail sales or storage areas exceed 50,000 square feet in area, the maximum allowable quantities are allowed to be increased by 2 percent for each 1,000 square feet of area in excess of 50,000 square feet, up to a maximum of 100 percent of the table amounts. A control area separation is not required. The cumulative amounts, including amounts attained by having an additional control area, shall not exceed 30,000 gallons.

414.3 Ventilation. Rooms, areas or spaces [of Group H] in which explosive, corrosive, combustible, flammable or highly toxic dusts, mists, fumes, vapors or gases are or may be emitted due to the processing, use, handling or storage of materials shall be mechanically ventilated [as] where required by the *New York City Fire Code* [and] or the *New York City Mechanical Code*. [Ducts conveying explosives or flammable vapors, fumes or dusts shall extend directly to the exterior of the building without entering other spaces. Exhaust ducts shall not extend into or through ducts and plenums.]

1 ~~[Exception: Ducts conveying vapor or fumes having flammable constituents less than 25 percent~~
2 ~~of their lower flammable limit (LFL) are permitted to pass through other spaces.]~~

3 Emissions generated at workstations shall be confined to the area in which they are generated as
4 specified in the *New York City Fire Code* and the *New York City Mechanical Code*.

5 ~~[The location of supply and exhaust openings shall be in accordance with the *New York City*~~
6 ~~*Mechanical Code*. Exhaust air contaminated by highly toxic material shall be treated in accordance~~
7 ~~with the *New York City Fire Code*.]~~

8 ~~[A manual shutoff control for ventilation equipment required by this section shall be provided~~
9 ~~outside the room adjacent to the principal access door to the room. The switch shall be of the break-~~
10 ~~glass type and shall be labeled: VENTILATION SYSTEM EMERGENCY SHUTOFF.]~~

11 **414.4 Hazardous material systems.** Systems involving hazardous materials shall be suitable for the
12 intended application. Controls shall be designed to prevent materials from entering or leaving process
13 or reaction systems at other than the intended time, rate or path. Automatic controls, where provided,
14 shall be designed to be fail safe.

15 **414.5 Inside storage, dispensing and use.** The inside storage, dispensing and use of hazardous
16 materials ~~[in excess of the maximum allowable quantities per control area of Tables 307.1(1) and~~
17 ~~307.1(2)]~~ shall be in accordance with the *New York City Fire Code* and Sections 414.5.1 through
18 ~~[414.5.5]~~ 414.5.4 of this code.

19 **414.5.1 Explosion control.** Explosion control shall be provided in accordance with the *New York*
20 *City Fire Code* as required by Table 414.5.1 where quantities of hazardous materials specified in
21 that table exceed the maximum allowable quantities in Table ~~[307.7(1)]~~ 307.1(1) or where a
22 structure, room or space is occupied for purposes involving explosion hazards as required by the
23 *New York City Fire Code* or Section 415 of this code.

1
2

**TABLE 414.5.1
EXPLOSION CONTROL REQUIREMENTS^{A,H}**

MATERIAL	CLASS	EXPLOSION CONTROL METHODS	
		Barricade construction	Explosion (deflagration) venting or explosion (deflagration) prevention systems ^b
HAZARD CATEGORY			
Combustible dusts ^c	—	Not Required	Required
Cryogenic flammables	—	Not Required	Required
Explosives	Division 1.1 Division 1.2 Division 1.3 Division 1.4 Division 1.5 Division 1.6	Required Required Not Required Not Required Required Required	Not Required Not Required Required Required Not Required Not Required
Flammable gas	Gaseous Liquefied	Not Required Not Required	Required Required
Flammable liquid	IA ^d IB ^e	Not Required Not Required	Required Required
Organic peroxides ^[g]	[Unclassified detonable] U I	Required Required	Not Permitted Not Permitted
Oxidizer liquids and solids	4	Required	Not Permitted
[Pyrophoric material^g]	[Detonable]	[Required]	[Required]
Pyrophoric gas ^[g]	[Nondetonable] —	Not Required	Required
Unstable (reactive)	4 3 Detonable 3 Nondetonable	Required Required Not Required	Not Permitted Not Permitted Required
Water-reactive liquids and solids ^[g]	3 [Detonable] [3 Nondetonable] [2 Detonable] 2 ^g [Nondetonable]	[Required] Not Required [Required] Not Required	[Not Permitted] Required [Not Permitted] Required
SPECIAL USES			
[Acetylene generator rooms]	[—]	[Not Required]	[Required]
Grain processing	—	Not Required	Required
[Liquefied petroleum gas- distribution facilities]	[—]	[Not Required]	[Required]
Where explosion hazards exist ^f	Detonation Deflagration	Required Not Required	Not Permitted Required

a. See Section 414.1.3.

3
4

- 1
2
3
4
5
6
7
8
9
10
11
12
- b. See the *New York City Fire Code*.
 - c. As generated during manufacturing or processing. [See definition of “Combustible dust” in Chapter 3.]
 - d. Storage or use.
 - e. In open use or dispensing.
 - f. Rooms containing dispensing and use of hazardous materials when an explosive environment can occur because of the characteristics or nature of the hazardous materials or as a result of the dispensing or use process.
 - g. A method of explosion control shall be provided when Class 2 water-reactive materials can form potentially explosive mixtures. [Considered as explosives for the purposes of storage.]
 - h. Explosion venting is not required for Group H-5 fabrication areas complying with the *New York City Fire Code* and Section 415.11.1 of this code.

13
14

~~[414.5.2 Monitor control equipment. Monitor control equipment shall be provided where required by the *New York City Fire Code*.]~~

15
16

~~[414.5.3 Automatic fire detection systems. Group H occupancies shall be provided with an automatic fire detection system in accordance with Section 907.2.]~~

17
18
19
20

~~[414.5.4] **414.5.2 Emergency or standby power.** Where required by the *New York City Fire Code* or this code, mechanical ventilation, treatment systems, temperature control, alarm, detection or other electrically operated systems [~~are required, such systems~~] shall be provided with [~~an~~] emergency or standby power [~~system~~] in accordance with [~~Chapter 27~~] Section 2702 of this code. For storage and use areas for highly toxic or toxic materials, see the *New York City Fire Code*.~~

21
22

414.5.2.1 Exempt applications. Emergency or standby power is not required for the mechanical ventilation systems provided for any of the following:

23

[Exceptions:]

- 24
25
26
27
28
29
1. [~~Mechanical ventilation for storage~~] Storage of Class IB and [~~Class~~] IC flammable and combustible liquids in closed containers not exceeding 6.5 gallons (25 L) capacity.
 2. Storage [~~areas for~~] of Class 1 and 2 oxidizers.
 3. Storage [~~areas for~~] of Class II, III, IV and V organic peroxides.
 4. [~~For storage, use and handling areas for highly toxic or toxic materials, see Chapter 37 of the *New York City Fire Code*~~] Storage of asphyxiant, irritant and radioactive gases.

30
31
32

~~[5.]~~ **414.5.2.2 Fail-safe engineered systems.** Standby power for mechanical ventilation, treatment systems and temperature control systems shall not be required where an approved fail-safe engineered system is installed.

33
34
35
36
37

~~[414.5.5] **414.5.3 Spill control, drainage and containment.** Rooms, buildings or areas occupied for the storage of solid and liquid hazardous materials shall be provided with a means to control spillage and to contain or drain off spillage and fire protection water discharged in the storage area where required in the *New York City Fire Code*. The methods of spill control shall be in accordance with the *New York City Fire Code*.~~

38
39
40

~~[414.5.6] **414.5.4 Storage of medical gases.** When required by the *New York City Fire Code*, a one-hour room shall be provided for the storage of medical gases inside of buildings, with the protected openings and ventilation provisions as required by the *New York City Fire Code*.~~

1 **414.6 Outdoor storage, dispensing and use.** The outdoor storage, dispensing and use of hazardous
2 materials shall be in accordance with the *New York City Fire Code*.

3 **414.6.1 Weather protection.** Where weather protection is provided for sheltering outdoor
4 hazardous material storage or use areas, such areas shall be considered outdoor storage or use
5 when the weather protection structure complies with Sections 414.6.1.1 through 414.6.1.3[?].

6 **414.6.1.1 Walls.** Walls shall not obstruct more than one side of the structure.

7 **Exception:** Walls shall be permitted to obstruct portions of multiple sides of the structure,
8 provided that the obstructed area [~~does~~] is not [~~exceed~~] greater than 25 percent of the
9 structure's perimeter.

10 **414.6.1.2 Separation distance.** The distance from the structure to buildings, lot lines, public
11 ways or means of egress to a public way shall be not [~~be~~] less than the distance required for
12 an outside hazardous material storage or use area without weather protection.

13 **414.6.1.3 Noncombustible construction.** The overhead structure shall be of approved
14 noncombustible construction with a maximum area of 1,500 square feet (140 m²).

15 **Exception:** The [~~increases~~] maximum area is permitted to be increased as provided by
16 Section 506[~~apply~~].

17 **SECTION BC 415**
18 **GROUPS H-1, H-2, H-3, H-4 AND H-5**

19 **415.1 Scope.** The provisions of Sections 415.1 through 415.11 shall apply to the storage and use of
20 hazardous materials in excess of the maximum allowable quantities per control area listed in Section
21 307.1. Buildings and structures with an occupancy in Group H shall also comply with the applicable
22 provisions of the *New York City Fire Code* and Section 414 of this code including, but not limited to,
23 location and installation provisions.

24 **415.2 Definitions.** The following terms are defined in Chapter 2:

25 **CONTINUOUS GAS DETECTION SYSTEM.**

26 **DETACHED BUILDING.**

27 **EMERGENCY CONTROL STATION.**

28 **EXHAUSTED ENCLOSURE.**

29 **FABRICATION AREA.**

30 **FLAMMABLE VAPORS OR FUMES.**

31 **GAS CABINET.**

32 **GAS ROOM.**

- 1 **HAZARDOUS PRODUCTION MATERIAL (HPM).**
- 2 **HPM FLAMMABLE LIQUID.**
- 3 **HPM ROOM.**
- 4 **IMMEDIATELY DANGEROUS TO LIFE AND HEALTH (IDLH).**
- 5 **LIQUID.**
- 6 **LIQUID STORAGE ROOM.**
- 7 **LIQUID USE, DISPENSING AND MIXING ROOM.**
- 8 **LOWER FLAMMABLE LIMIT (LFL).**
- 9 **NORMAL TEMPERATURE AND PRESSURE (NTP).**
- 10 **PHYSIOLOGICAL WARNING THRESHOLD LEVEL.**
- 11 **SERVICE CORRIDOR.**
- 12 **SOLID.**
- 13 **STORAGE, HAZARDOUS MATERIALS.**
- 14 **USE (MATERIAL).**
- 15 **WORKSTATION.**
- 16 **415.3 Automatic fire detection systems.** Group H occupancies shall be provided with an automatic
17 **fire detection system in accordance with Section 907.2.**
- 18 **415.4 Automatic sprinkler system.** Group H occupancies shall be equipped throughout with an
19 **automatic sprinkler system in accordance with Section 903.2.5.**
- 20 **[414.7] 415.5 Emergency alarms.** Emergency alarms for the detection and notification of an
21 emergency condition in Group H occupancies shall be provided as set forth herein.
- 22 **[414.7.1] 415.5.1 Storage.** An approved manual emergency alarm system shall be provided in
23 buildings, rooms or areas used for storage of hazardous materials. Emergency alarm-initiating
24 devices shall be installed outside of each interior exit or exit access door of storage buildings,
25 rooms or areas. Activation of an emergency alarm-initiating device shall sound a local alarm to
26 alert occupants of an emergency situation involving hazardous materials.
- 27 **[414.7.2] 415.5.2 Dispensing, use and handling.** Where hazardous materials having a hazard
28 ranking of 3 or 4 in accordance with NFPA 704 are transported through corridors [~~or exit~~
29 ~~enclosures~~], interior exit stairways or ramps, or exit passageways, there shall be an emergency
30 telephone system, a local manual alarm station or an approved alarm-initiating device at not more

1 than 150-foot (45 720 mm) intervals and at each exit and exit access doorway throughout the
2 transport route. The signal shall be relayed to an approved central, ~~[station,]~~ proprietary or remote
3 ~~[supervising]~~ station service or constantly attended on-site location and shall ~~[also]~~ initiate a local
4 audible alarm.

5 ~~[414.7.3]~~ **415.5.3 Supervision.** Emergency alarm systems shall be supervised by an approved
6 central, proprietary or remote station service or shall initiate an audible and visual signal at a
7 constantly attended on-site location.

8 **415.5.4 Emergency alarm systems.** Emergency alarm systems shall be provided with emergency
9 power in accordance with Section 2702.

10 **[SECTION BC 415]**
11 **[GROUPS H-1, H-2, H-3, H-4 AND H-5]**

12 ~~[415.1 Scope. The provisions of Sections 415.1 through 415.8 shall apply to the storage and use of~~
13 ~~hazardous materials in excess of the maximum allowable quantities per control area listed in Section~~
14 ~~307.1. Buildings and structures with an occupancy in Group H shall also comply with the applicable~~
15 ~~provisions of Section 414 and the *New York City Fire Code*, including, but not limited to, location~~
16 ~~and installation provisions.]~~

17 ~~[415.2 Definitions. The following words and terms shall, for the purposes of this chapter and as used~~
18 ~~elsewhere in the code, have the meanings shown herein.]~~

19 ~~[CONTINUOUS GAS DETECTION SYSTEM. A gas detection system where the analytical~~
20 ~~instrument is maintained in continuous operation and sampling is performed without interruption.~~
21 ~~Analysis is allowed to be performed on a cyclical basis at intervals not to exceed 30 minutes.]~~

22 ~~[DETACHED BUILDING. A separate single story building, without a basement or crawl space,~~
23 ~~used for the storage, handling or use of hazardous materials and located an approved distance from~~
24 ~~other buildings and structures.]~~

25 ~~[EMERGENCY CONTROL STATION. An approved location on the premises of a semiconductor~~
26 ~~fabrication facility staffed by trained personnel that monitor the operation of equipment and systems~~
27 ~~including alert and alarm signals.]~~

28 ~~[EXHAUSTED ENCLOSURE. A device, typically consisting of a hood equipped with a fan, that~~
29 ~~serves to capture and exhaust fumes, mist, vapors and gases generated at a workstation or other local~~
30 ~~environment. An exhausted enclosure does not include a room provided with general ventilation.]~~

31 ~~[FABRICATION AREA. An area within a semiconductor fabrication facility in which processes~~
32 ~~using hazardous production materials are conducted.]~~

33 ~~[FLAMMABLE VAPORS OR FUMES. The concentration of flammable constituents in air that~~
34 ~~exceed 25 percent of their lower flammable limit (LFL).]~~

35 ~~[GAS CABINET. A fully enclosed, noncombustible enclosure used to provide an isolated~~
36 ~~environment for compressed gas containers in storage or use, including any doors and access ports~~
37 ~~for exchanging containers and accessing pressure regulating controls.]~~

1 ~~[GAS ROOM. A separately ventilated, fully enclosed room in which only compressed gases and~~
2 ~~associated equipment and supplies are stored or used.]~~

3 ~~[HAZARDOUS PRODUCTION MATERIAL (HPM). A solid, liquid or gas associated with~~
4 ~~semiconductor manufacturing that has a degree of hazard rating in health, flammability or instability~~
5 ~~of Class 3 or 4 as defined in NFPA 704 and that is used directly in research, laboratory or production~~
6 ~~processes which have as their end product materials that are not hazardous.]~~

7 ~~[HPM FLAMMABLE LIQUID. An HPM liquid that is defined as either a Class I flammable liquid~~
8 ~~or a Class II or Class IIIA combustible liquid.]~~

9 ~~[HPM ROOM. A room used in conjunction with or serving a Group H 5 occupancy, where HPM is~~
10 ~~stored or used and that is classified as a Group H 2, H 3 or H 4 occupancy.]~~

11 ~~[IMMEDIATELY DANGEROUS TO LIFE AND HEALTH (IDLH). The concentration of air-~~
12 ~~borne contaminants that poses a threat of death, immediate or delayed permanent adverse health~~
13 ~~effects, or effects that could prevent escape from such an environment as established by the National~~
14 ~~Institute of Occupational Safety and Health (NIOSH) based on both toxicity and flammability. It~~
15 ~~generally is expressed in parts per million by volume (ppm v/v) or milligrams per cubic meter~~
16 ~~(mg/m³). If adequate data do not exist for precise establishment of IDLH concentrations, an~~
17 ~~independent certified industrial hygienist, industrial toxicologist, appropriate regulatory agency or~~
18 ~~other source approved by the Fire Commissioner shall make such determination.]~~

19 ~~[LIQUID. A material that has a melting point that is equal to or less than 68°F (20°C) and a boiling~~
20 ~~point that is greater than 68°F (20°C) at 14.7 pounds per square inch absolute (psia) (101 kPa). When~~
21 ~~not otherwise identified, the term “liquid” includes both flammable and combustible liquids.]~~

22 ~~[LIQUID STORAGE ROOM. A room classified as a Group H 3 occupancy used for the storage of~~
23 ~~flammable or combustible liquids in an unopened condition.]~~

24 ~~[LIQUID USE, DISPENSING AND MIXING ROOM. A room in which Class I, II and IIIA~~
25 ~~flammable or combustible liquids are used, dispensed or mixed in open containers.]~~

26 ~~[LOWER FLAMMABLE LIMIT (LFL). The minimum concentration of vapor in air at which~~
27 ~~propagation of flame will occur in the presence of an ignition source. The LFL is sometimes referred~~
28 ~~to as “LEL” or “lower explosive limit.”]~~

29 ~~[NORMAL TEMPERATURE AND PRESSURE (NTP). A temperature of 70°F (21°C) and a~~
30 ~~pressure of 1 atmosphere [14.7 psia (101 kPa)].]~~

31 ~~[PHYSIOLOGICAL WARNING THRESHOLD LEVEL. A concentration of air borne~~
32 ~~contaminants, normally expressed in parts per million (ppm) or milligrams per cubic meter (mg/m³),~~
33 ~~that represents the concentration at which persons can sense the presence of the contaminant due to~~
34 ~~odor, irritation or other quick acting physiological response. When used in conjunction with the~~
35 ~~permissible exposure limit (PEL) the physiological warning threshold levels are those consistent with~~
36 ~~the classification system used to establish the PEL. See the definition of “Permissible exposure limit~~
37 ~~(PEL)” in the *New York City Fire Code*.]~~

1 ~~[SERVICE CORRIDOR. A fully enclosed passage other than one designated as a required means~~
2 ~~of egress, through which HPM can be moved during handling.]~~

3 ~~[SOLID. A material that has a melting point, decomposes or sublimates at a temperature greater than~~
4 ~~68°F (20°C).]~~

5 ~~[WORKSTATION. A defined space within a fabrication area in which a specific function,~~
6 ~~laboratory procedure or research activity relating to semiconductor manufacture is conducted. A~~
7 ~~workstation may include equipment using HPM, hazardous materials storage cabinets, flammable~~
8 ~~liquid storage cabinets or gas cabinets, ventilation equipment, fire protection devices, detection~~
9 ~~devices, and electrical devices.]~~

10 ~~[415.3]~~ **415.6 Fire [Separation] separation distance.** Group H occupancies shall be located on
11 property in accordance with the other provisions of this chapter. In Groups H-2 and H-3, not less than
12 25 percent of the perimeter wall of the occupancy shall be an exterior wall.

13 **Exceptions:**

- 14 1. Liquid use, dispensing and mixing rooms having a floor area of not more than 500 square
15 feet [~~(47 m²)~~] (46.5 m²) need not be located on the outer perimeter of the building where
16 they are in accordance with the *New York City Fire Code* and NFPA 30.
- 17 2. Liquid storage rooms having a floor area of not more than 1,000 square feet (93 m²) need
18 not be located on the outer perimeter where they are in accordance with the *New York City*
19 *Fire Code* and NFPA 30.
- 20 3. Spray paint booths that comply with the *New York City Fire Code* need not be located on
21 the outer perimeter.

22 ~~[415.3.1]~~ **415.6.1 Group H occupancy minimum fire separation distance.** Regardless of any
23 other provisions, buildings containing Group H occupancies shall be set back to the minimum fire
24 separation distance as set forth in ~~[Items 1]~~ Sections 415.6.1.1 through ~~[4 below]~~ 415.6.1.4.
25 Distances shall be measured from the walls enclosing the occupancy to lot lines, including those
26 on a public way. Distances to assumed ~~[tax]~~ lot lines established for the ~~[purposes]~~ purpose of
27 determining exterior wall and opening protection~~[, in accordance with Section 705.3.]~~ are not to
28 be used to establish the minimum fire separation distance for buildings on sites where explosives
29 are manufactured or used when separation is provided in accordance with the quantity distance
30 tables specified for explosive materials in the *New York City Fire Code*.

31 ~~[1.—]~~ **415.6.1.1 Group H-1.**~~[Not]~~ Group H-1 occupancies shall be set back not less than
32 75 feet (22 860 mm) and not less than required by the *New York City Fire Code*.

Exceptions:

1. Fireworks manufacturing buildings separated in accordance with NFPA 1124.
2. Buildings containing the following materials when separated in accordance with Table [415.3.1] 415.6.1 of this code:
 - 2.1. Organic peroxides, unclassified detonable.
 - 2.2. Unstable reactive materials Class 4.
 - 2.3. Unstable reactive materials, Class 3 detonable.
 - 2.4. Detonable pyrophoric materials.

[2.—] **415.6.1.2 Group H-2.** [Not] Group H-2 occupancies shall be set back not less than 30 feet (9144 mm) where the area of the occupancy exceeds 1,000 square feet (93 m²), and it is not required to be located in a detached building.

[3.—] **415.6.1.3 Groups H-2 and H-3.** [Not] Group H-2 and H-3 occupancies shall be set back not less than 50 feet (15 240 mm) where a detached building is required (see Table [415.3.2] 415.6.2).

~~[4. Groups H-2 and H-3. Occupancies containing materials with explosive characteristics shall be separated as required by the *New York City Fire Code*. Where separations are not specified, the distances required shall not be less than the distances required by Table 415.3.1.]~~

415.6.1.4 Explosive materials. Group H-2 and H-3 occupancies containing materials with explosive characteristics shall be separated as required by the *New York City Fire Code*. Where separations are not specified, the distances required shall not be less than the distances required by Table 415.6.1.

**TABLE [415.3.1] 415.6.1
MINIMUM SEPARATION DISTANCES FOR BUILDINGS CONTAINING EXPLOSIVE
MATERIALS^F**

QUANTITY OF EXPLOSIVE MATERIAL ^{a,d}		MINIMUM DISTANCE (feet)		
		Lot lines ^b and inhabited buildings ^c		Separation of magazines ^e
Pounds over	Pounds not over	Barricaded	Unbarricaded	
0	5	70	140	12
5	10	90	180	16
10	20	110	220	20
20	30	125	250	22
30	40	140	280	24
40	50	150	300	28
50	75	170	340	30
75	100	190	380	32

QUANTITY OF EXPLOSIVE MATERIAL ^{a,d}		MINIMUM DISTANCE (feet)		
		Lot lines ^b and inhabited buildings ^c		Separation of magazines ^e
Pounds over	Pounds not over	Barricaded	Unbarricaded	
100	125	200	400	36
125	150	215	430	38
150	200	235	470	42
200	250	255	510	46
250	300	270	540	48
300	400	295	590	54
400	500	320	640	58
500	600	340	680	62
600	700	355	710	64
700	800	375	750	66
800	900	390	780	70
900	1,000	400	800	72

For SI: 1 pound = 0.454 kg, 1 foot = 304.8 mm.

- a. The number of pounds of explosives listed is the number of pounds of trinitrotoluene (TNT) or the equivalent pounds of other explosive.
- b. The distance listed is the distance to lot line, including lot lines at public ways.
- c. For the purpose of this table, an inhabited building is any building on the same tax lot that is regularly occupied by people. Where two or more buildings containing explosives or magazines are located on the tax lot, each building or magazine shall comply with the minimum [distance] distances specified from inhabited buildings and, in addition, they shall be separated from each other by not less than the distance shown for "Separation of magazines," except that the quantity of [explosives] explosive materials contained in detonator buildings or magazines shall govern in regard to the spacing of said detonator buildings or magazines from buildings or magazines containing other explosive materials. If any two or more buildings or magazines are separated from each other by less than the specified "Separation of magazines" distances, then such two or more buildings or magazines, as a group, shall be considered as one building or magazine, and the total quantity of [explosives] explosive materials stored in such group shall be treated as if the explosive were in a single building or magazine located on the site of any building or magazine of the group, and shall comply with the minimum distance specified from other magazines or inhabited buildings.
- d. Storage of explosives in a quantity exceeding 1,000 pounds in one magazine is prohibited.
- e. Magazine is a building or structure, other than an operating building, approved for storage of explosive materials. Portable or mobile magazines not exceeding 120 square feet (11 m²) in area need not comply with the requirements of this code, however, all magazines shall comply with the *New York City Fire Code*.
- f. This table shall not apply to the temporary storage incidental to transportation.

[415.3.2] 415.6.2 Detached buildings for Group H-1[and], H-2 or H-3 occupancy. The storage or use of hazardous materials in excess of those amounts listed in Table [415.3.2] 415.6.2 shall be in accordance with the applicable provisions of Sections [415.4] 415.7 and [415.5] 415.8.

**TABLE [415.3.2] 415.6.2
[REQUIRED] DETACHED [STORAGE] BUILDING REQUIRED**

<u>A DETACHED [STORAGE] BUILDING IS REQUIRED WHEN THE QUANTITY OF MATERIAL EXCEEDS THAT LISTED HEREIN</u>			
Material	Class	Solids and Liquids (tons) ^{a,b}	Gases (cubic feet) ^{a,b}
Explosives	Division 1.1	Maximum Allowable Quantity	Not Applicable
	Division 1.2	Maximum Allowable Quantity	
	Division 1.3	Maximum Allowable Quantity	
	Division 1.4	Maximum Allowable Quantity	
	Division 1.4 ^c	1	
	Division 1.5	Maximum Allowable Quantity	
	Division 1.6	Maximum Allowable Quantity	
Oxidizers	Class 4	Maximum Allowable Quantity	Maximum Allowable Quantity

A DETACHED [STORAGE] BUILDING IS REQUIRED WHEN THE QUANTITY OF MATERIAL EXCEEDS THAT LISTED HEREIN			
Material	Class	Solids and Liquids (tons)^{a,b}	Gases (cubic feet)^{a,b}
Unstable (reactives) detonable	Class 3 or 4	Maximum Allowable Quantity	Maximum Allowable Quantity
[Water reactives detonable]	[Class 2 or 3]	[Maximum Allowable Quantity]	[Not Applicable]
Oxidizer, liquids and solids	Class 3 Class 2	1,200 2,000	Not Applicable Not Applicable
Organic peroxides	[Unclassified] Detonable Class I Class II Class III	Maximum Allowable Quantity Maximum Allowable Quantity 25 50	Not Applicable Not Applicable Not Applicable Not Applicable
Unstable (reactives) nondetonable	Class 3 Class 2	1 25	2,000 10,000
Water reactives [nondetonable]	Class 3 Class 2	1 25	Not Applicable Not Applicable
[Pyrophoric materials detonable]	[Not Applicable]	[Maximum Allowable Quantity]	[Maximum Allowable Quantity]
Pyrophoric gases [and nondetonables]	Not Applicable	Not Applicable	2,000

For SI: 1 ton = ~~[2,000 pounds =]~~ 906 kg, 1 cubic foot = 0.02832m³, 1 pound = 0.454 kg.

- a. For materials that are detonable, the distance to other buildings or lot lines shall be as specified in Table ~~[415.3.4]~~ 415.6.1 based on trinitrotoluene (TNT) equivalence of the material. For materials classified as explosives, see the *New York City Fire Code*. Unclassified detonable organic peroxides, detonable pyrophoric materials, detonable unstable (reactive) materials and detonable water-reactive materials shall be considered as explosives for the purposes of storage.
- b. "Maximum Allowable Quantity" means the maximum allowable quantity per control area set forth in Table 307.1(1).
- c. Limited to Division 1.4 materials and articles, including articles packaged for shipment, that are not regulated as an explosive under Bureau of Alcohol, Tobacco ~~[and,]~~ Firearms ~~and Explosives~~ (BATF) regulations or unpackaged articles used in process operations that do not propagate a detonation or deflagration between articles, ~~[providing]~~ provided the net explosive weight of individual articles does not exceed 1 pound.

415.6.2.1 Wall and opening protection. Where a detached building is required by Table ~~[415.3.2]~~ 415.6.2, there are no requirements for wall and opening protection based on fire separation distance.

415.4 415.7 Special provisions for Group H-1 occupancies. Group H-1 occupancies shall be in detached buildings used for no other purpose, shall not exceed one story in height and be without basements, crawl spaces or other under-floor spaces. Roofs shall be of lightweight construction with

1 suitable thermal insulation to prevent sensitive material from reaching its decomposition temperature.
2 Group H-1 occupancies containing materials that are in themselves both physical and health hazards
3 in quantities exceeding the maximum allowable quantities per control area in Table [307.7(2)]
4 307.1(2) shall comply with requirements for both Group H-1 and H-4 occupancies.

5 **[415.4.1] 415.7.1 Floors in storage rooms.** Floors in storage areas for organic peroxides,
6 pyrophoric materials and unstable (reactive) materials shall be of liquid-tight, noncombustible
7 construction.

8 **[415.5] 415.8 Special provisions for [Groups] Group H-2 and H-3 occupancies.** Group H-2 and
9 H-3 occupancies containing quantities of hazardous materials in excess of those set forth in Table
10 [415.3.2] 415.6.2 shall be in detached buildings used for ~~[no other purpose, shall not exceed one~~
11 ~~story]~~ manufacturing, processing, dispensing, use or storage of hazardous materials. Materials listed
12 for Group H-1 occupancies in [height and shall] Section 307.3 are permitted to be [without
13 ~~basements, crawl spaces or other under floor spaces]~~ located within Group H-2 or H-3 detached
14 buildings provided the amount of materials per control area do not exceed the maximum allowed
15 quantity specified in Table 307.1(1).

16 **415.8.1 Multiple hazards.** Group H-2 or H-3 occupancies containing materials that are in
17 themselves both physical and health hazards in quantities exceeding the maximum allowable
18 quantities per control area in Table 307.1(2) shall comply with requirements for Group H-2, H-3
19 or H-4 occupancies as applicable.

20 **415.8.2 Separation of incompatible materials.** Hazardous materials other than those listed in
21 Table 415.6.2 shall be allowed in manufacturing, processing, dispensing, use or storage areas
22 when separated from incompatible materials in accordance with the provisions of the *New York*
23 *City Fire Code.*

24 **415.8.3 Water reactives.** Group H-2 and H-3 occupancies containing water-reactive materials
25 shall be resistant to water penetration. Piping for conveying liquids shall not be over or through
26 areas containing water reactives, unless isolated by approved liquid-tight construction.

27 **Exception:** Fire protection piping shall be permitted over or through areas containing water
28 reactives without isolating it with liquid-tight construction.

29 **[415.5.1] 415.8.4 Floors in storage rooms.** Floors in storage areas for organic peroxides,
30 oxidizers, pyrophoric materials, unstable (reactive) materials and water-reactive solids and liquids
31 shall be of liquid-tight, noncombustible construction.

32 **[415.5.2] 415.8.5 Waterproof room.** Rooms or areas used for the storage of water-reactive solids
33 and liquids shall be constructed in a manner that resists the penetration of water through the use
34 of waterproof materials. Piping carrying water for other than approved automatic [fire] sprinkler
35 systems shall not be within such rooms or areas.

36 **[415.6] 415.9 Group H-2.** Occupancies in Group H-2 shall be constructed in accordance with the
37 *New York City Fire Code* and Sections [415.6.1] 415.9.1 through [415.6.4] 415.9.3 of this code.

1 ~~[415.6.1 Combustible dusts, grain processing and storage. The provisions of Sections~~
2 ~~415.6.1.1 through 415.6.1.5 shall apply to buildings in which materials that produce combustible~~
3 ~~dusts are stored or handled. Buildings that store or handle combustible dusts shall comply with~~
4 ~~the applicable provisions of NFPA 61, NFPA 69, NFPA 120, NFPA 484, NFPA 651, NFPA 654,~~
5 ~~NFPA 655, NFPA 664 and NFPA 85, and the *New York City Fire Code*.]~~

6 ~~[415.6.1.1 Type of construction and height exceptions. Buildings shall be constructed in~~
7 ~~compliance with the height and area limitations of Table 503 for Group H 2; except that~~
8 ~~where erected of Type I or II construction, the heights and areas of grain elevators and~~
9 ~~similar structures shall be unlimited, and where of Type IV construction, the maximum~~
10 ~~height shall be 65 feet (19 812 mm) and except further that, in isolated areas, the maximum~~
11 ~~height of Type IV structures shall be increased to 85 feet (25 908 mm).]~~

12 ~~[415.6.1.2 Grinding rooms. Every room or space occupied for grinding or other operations~~
13 ~~that produce combustible dusts shall be enclosed with fire barriers constructed in~~
14 ~~accordance with Section 707 or horizontal assemblies constructed in accordance with~~
15 ~~Section 712, or both. The minimum fire resistance rating shall be 2 hours where the area is~~
16 ~~not more than 3,000 square feet (279 m²), and 4 hours where the area is greater than 3,000~~
17 ~~square feet (279 m²).]~~

18 ~~[415.6.1.3 Conveyors. Conveyors, chutes, piping and similar equipment passing through~~
19 ~~the enclosures of rooms or spaces shall be constructed dirt tight and vapor tight, and be of~~
20 ~~approved noncombustible materials complying with Chapter 30.]~~

21 ~~[415.6.1.4 Explosion control. Explosion control shall be provided as specified in the *New*~~
22 ~~*York City Fire Code*, or spaces shall be equipped with the equivalent mechanical ventilation~~
23 ~~complying with the *New York City Mechanical Code*.]~~

24 ~~[415.6.1.5 Grain elevators. Grain elevators, malt houses and buildings for similar~~
25 ~~occupancies shall not be located within 30 feet (9144 mm) of interior lot lines or structures~~
26 ~~on the same lot, except where erected along a railroad right-of-way.]~~

27 ~~[415.6.1.6 Coal pockets. Coal pockets located less than 30 feet (9144 mm) from interior lot~~
28 ~~lines or from structures on the same lot shall be constructed of not less than Type IB~~
29 ~~construction. Where more than 30 feet (9144 mm) from interior lot lines, or where erected~~
30 ~~along a railroad right-of-way, the minimum type of construction of such structures not more~~
31 ~~than 65 feet (19 812 mm) in building height shall be Type IV.]~~

32 ~~[415.6.2] 415.9.1 Flammable and combustible liquids. The storage, handling, processing and~~
33 ~~transporting of flammable and combustible liquids in [Groups] Group H-2 and H-3 occupancies~~
34 ~~shall be in accordance with the *New York City Mechanical Code*, the *New York City Fire Code*,~~
35 ~~and Sections [415.6.2.1] 415.9.1.1 through [415.6.2.10] 415.9.1.9 of this code.~~

36 ~~[415.6.2.1] 415.9.1.1 Mixed occupancies. Where the storage tank area is located in a~~
37 ~~building of two or more occupancies and the quantity of liquid exceeds the maximum~~
38 ~~allowable quantity for one control area, the use shall be completely separated from adjacent~~
39 ~~fire areas in accordance with the requirements of Section 508.4.~~

1 **[415.6.2.1.1] 415.9.1.1.1 Height exception.** Where storage tanks are located within a
2 building no more than one story above grade plane, the height limitation of Section [503]
3 504 shall not apply for Group H.

4 **[415.6.2.2] 415.9.1.2 Tank protection.** Storage tanks shall be noncombustible and protected
5 from physical damage. Fire barriers or horizontal assemblies or both around the storage
6 [~~tank(s)~~] tanks shall be permitted as the method of protection from physical damage.

7 **[415.6.2.3] 415.9.1.2.1 Tanks.** Storage tanks shall be approved tanks conforming to the
8 requirements of the *New York City Fire Code*.

9 **[415.6.2.4] 415.9.1.3 Suppression.** Group H shall be equipped throughout with an approved
10 automatic sprinkler system, installed in accordance with Section 903.

11 **[415.6.2.5] 415.9.1.4 Leakage containment.** A liquid-tight containment area compatible with
12 the stored liquid shall be provided. The method of spill control, drainage control and
13 secondary containment shall be in accordance with the *New York City Fire Code*.

14 **Exception:** Rooms where only double-wall storage tanks conforming to Section
15 [415.6.2.3] 415.9.1.3 are used to store Class I, II and IIIA flammable and combustible
16 liquids shall not be required to have a leakage containment area.

17 **[415.6.2.6] 415.9.1.5 Leakage alarm.** An approved automatic alarm shall be provided to
18 indicate a leak in a storage tank and room. The alarm shall sound an audible signal, 15 dBA
19 above the ambient sound level, at every point of entry into the room in which the leaking
20 storage tank is located. An approved sign shall be posted on every entry door to the tank
21 storage room indicating the potential hazard of the interior room environment, or the sign shall
22 state: WARNING, WHEN ALARM SOUNDS, THE ENVIRONMENT WITHIN THE
23 ROOM MAY BE HAZARDOUS. The leakage alarm shall also be supervised in accordance
24 with Chapter 9 to transmit a trouble signal.

25 **[415.6.2.7] 415.9.1.6 Tank vent.** Storage tank vents for Class I, II or IIIA liquids shall
26 terminate to the outdoor air in accordance with the *New York City Fire Code*.

27 **[415.6.2.8] 415.9.1.7 Room ventilation.** Storage tank areas storing Class I, II or IIIA liquids
28 shall be provided with mechanical ventilation. The mechanical ventilation system shall be in
29 accordance with the *New York City Mechanical Code* and the *New York City Fire Code*.

30 **[415.6.2.9] 415.9.1.8 Explosion venting.** Where Class I liquids are being stored, explosion
31 venting shall be provided in accordance with the *New York City Fire Code*.

32 **[415.6.2.10] 415.9.1.9 Tank openings other than vents.** Tank openings other than vents from
33 tanks inside buildings shall be designed to ensure that liquids or vapor concentrations are not
34 released inside the building.

35 **[415.6.3] 415.9.2 Liquefied petroleum gas-distribution facilities.** The construction and
36 installation of liquefied petroleum gas facilities shall be in accordance with the requirements of

1 this code, the *New York City Fire Code*, the *New York City Mechanical Code*, the *New York City*
2 *Fuel Gas Code* and NFPA 58.

3 **[415.6.4] 415.9.3 Dry cleaning plants.** The construction and installation of dry cleaning plants
4 shall be in accordance with the requirements of this code, the *New York City Mechanical Code*,
5 the *New York City Plumbing Code* and NFPA 32. Dry cleaning solvents and systems shall be
6 classified in accordance with the *New York City Fire Code*.

7 **[415.7] 415.10 Groups H-3 and H-4.** Groups H-3 and H-4 shall be constructed in accordance with
8 the applicable provisions of this code and the *New York City Fire Code*.

9 **[415.7.1] 415.10.1 Flammable and combustible liquids.** The storage, handling, processing and
10 transporting of flammable and combustible liquids in Group H-3 occupancies shall be in
11 accordance with Section [415.6.2] 415.9.1.

12 **[415.7.2] 415.10.2 Gas rooms.** [~~When~~ Where] gas rooms are provided, such rooms shall be
13 separated from other areas by not less than 1-hour fire barriers constructed in accordance with
14 Section 707 or horizontal assemblies constructed in accordance with Section [712] 711, or both.

15 **[415.7.3] 415.10.3 Floors in storage rooms.** Floors in storage areas for corrosive liquids and
16 highly toxic or toxic materials shall be of liquid-tight, noncombustible construction.

17 **[415.7.4] 415.10.4 Separation-highly toxic solids and liquids.** Highly toxic solids and liquids
18 not stored in approved hazardous materials storage cabinets shall be isolated from other hazardous
19 materials storage by not less than 1-hour fire-resistance rating.

20 **[415.8 Group H-5.]**

21 **[415.8.1 General.]**

22 **415.11 Group H-5.** In addition to the requirements set forth elsewhere in this code, Group H-5 shall
23 comply with the provisions of the *New York City Fire Code* and Section 415.9 of this code, including,
24 but not limited to, automatic sprinkler protection for workstations, gas cabinets, exhausted
25 enclosures, pass-throughs in exit access corridors and exhaust ducts.

26 **[415.8.2] 415.11.1 Fabrication areas.** Fabrication areas shall comply with Sections 415.11.1.1
27 through 415.11.1.8.

28 **[415.8.2.1] 415.11.1.1 Hazardous materials [~~in fabrication areas~~].** Hazardous materials
29 and hazardous production materials (HPM) shall comply with Sections 415.11.1.1.1 through
30 415.11.1.1.2.

31 **[415.8.2.1.1] 415.11.1.1.1 Aggregate quantities.** The aggregate quantities of hazardous
32 materials stored and used in a single fabrication area shall not exceed the quantities set
33 forth in Table [415.8.2.1.1] 415.11.1.1.1.

34 **Exception:** The quantity limitations for any hazard category in Table [415.8.2.1.1]
35 415.11.1.1.1 shall not apply where the fabrication area contains quantities of

hazardous materials not exceeding the maximum allowable quantities per control area established by Tables 307.1(1) and 307.1(2).

TABLE [415.8.2.1.1] 415.11.1.1
QUANTITY LIMITS FOR HAZARDOUS MATERIALS IN A SINGLE FABRICATION
AREA IN GROUP H-5^A

HAZARD CATEGORY		SOLIDS (pounds per square [feet] foot)	LIQUIDS (gallons per square [feet] foot)	GAS [SCF] (cubic feet @ NTP/square [feet] foot)
PHYSICAL-HAZARD MATERIALS				
Combustible dust		Note b	Not Applicable	Not Applicable
Combustible fiber	Loose Baled	Note b Notes b, c	Not Applicable	Not Applicable
Combustible liquid	II IIIA IIIB Combination Class I, II and IIIA	Not Applicable	0.01 0.02 Not Limited 0.04	Not Applicable
Cryogenic gas	Flammable Oxidizing	Not Applicable	Not Applicable	Note [e] d 1.25
Explosives		Note b	Note b	Note b
Flammable gas	Gaseous Liquefied	Not Applicable	Not Applicable	Note [e] d Note [e] d
Flammable liquid	IA IB IC Combination Class IA, IB and IC Combination Class I, II and IIIA	Not Applicable	0.0025 0.025 0.025 0.025 0.04	Not Applicable
Flammable solid		0.001	Not Applicable	Not Applicable
Organic peroxide	Unclassified detonable Class I Class II Class III Class IV Class V	Note b Note b 0.025 0.1 Not Limited Not Limited	Not Applicable	Not Applicable
Oxidizing gas	Gaseous Liquefied Combination of gaseous and liquefied	Not Applicable	Not Applicable	1.25 1.25 1.25
Oxidizer	Class 4 Class 3 Class 2 Class 1 Combination Class 1, 2, 3	Note b 0.003 0.003 0.003 0.003 0.003	Note b 0.03 0.03 0.03 0.03	Not Applicable
Pyrophoric materials		[Note b] 0.01	0.00125	Notes d and e
Unstable (reactive)	Class 4 Class 3 Class 2 Class 1	Note b 0.025 0.1 Not Limited	Note b 0.0025 0.01 Not Limited	Note b Note b Note b Not Limited
Water reactive	Class 3 Class 2 Class 1	Note b 0.25 Not Limited	0.00125 0.025 Not Limited	Not Applicable

HEALTH-HAZARD MATERIALS

Corrosives	Not Limited	Not Limited	Not Limited
Highly toxic	Not Limited	Not Limited	Note d
Toxics	Not Limited	Not Limited	Note d

For SI: 1 pound per square foot = 4.882 kg/m², 1 gallon per square foot = 40.7 L/m², 1 cubic foot @ NTP/square foot = 0.305 m³ @ NTP/m² 1 cubic foot = 0.02832 m³.

- a. Hazardous materials within piping shall not be included in the calculated quantities.
- b. Quantity of hazardous materials in a single fabrication shall not exceed the maximum allowable quantities per control area in Tables 307.1(1) and 307.1(2).
- c. Densely packed baled cotton that complies with the packing requirements of ISO 8115 shall not be included in this material class.
- d. The aggregate quantity of flammable, pyrophoric, toxic and highly toxic gases shall not exceed 9,000 ~~[SCF]~~ cubic feet at NTP.
- e. The aggregate quantity of pyrophoric gases in the building shall not exceed the amounts set forth in Table ~~[415.3.2]~~ 415.6.2.

[415.8.2.1.2] 415.11.1.1.2 Hazardous production materials. The maximum quantities of hazardous production materials (HPM) stored in a single fabrication area shall not exceed the maximum allowable quantities per control area established by Tables 307.1(1) and 307.1(2).

[415.8.2.2] 415.11.1.2 Separation. Fabrication areas, whose sizes are limited by the quantity of hazardous materials allowed by Table ~~[415.8.2.1.1]~~ 415.11.1.1.1, shall be separated from each other, from corridors~~[7]~~ and from other parts of the building by not less than 1-hour fire barriers constructed in accordance with Section 707 or horizontal assemblies constructed in accordance with Section ~~[712]~~ 711, or both.

Exceptions:

1. Doors within such fire barrier walls, including doors to corridors, shall be only self-closing fire door assemblies having a ~~[fire protection]~~ fire protection rating of not less than ³/₄ hour.
2. Windows between fabrication areas and exit access corridors are permitted to be fixed glazing listed and labeled for a fire protection rating of ~~[at least]~~ not less than ³/₄ hour in accordance with Section ~~[715]~~ 716.

[415.8.2.3] 415.11.1.3 Location of occupied levels. Occupied levels of fabrication areas shall be located at or above the first story above grade plane.

[415.8.2.4] 415.11.1.4 Floors. Except for surfacing, floors within fabrication areas shall be of noncombustible construction.

Openings through floors of fabrication areas are permitted to be unprotected where the interconnected levels are used solely for mechanical equipment directly related to such fabrication areas (see also Section ~~[415.8.2.5]~~ 415.11.1.5).~~[Floors forming a part of an occupancy separation shall be liquid tight.]~~

Floors forming a part of an occupancy separation shall be liquid tight.

[415.8.2.5] 415.11.1.5 Shafts and openings through floors. Elevator ~~[shafts]~~ hoistways, vent shafts and other openings through floors shall be enclosed ~~[when]~~ where required by ~~[Section 708]~~ Sections 712 and 713. Mechanical, duct and piping penetrations within a fabrication area shall not extend through more than two floors. The annular space around penetrations for cables, cable trays, tubing, piping, conduit or ducts shall be sealed at the floor level to restrict

1 the movement of air. The fabrication area, including the areas through which the ductwork
2 and piping extend, shall be considered a single conditioned environment.

3 **[415.8.2.6] 415.11.1.6 Ventilation.** Mechanical exhaust ventilation at the rate of not less than
4 1 cubic foot per minute per square foot [~~0.0051 m³/(s · m²)~~] (0.0051 m³/(s · m²)) of floor area
5 shall be provided throughout portions of the fabrication area where HPM are used or stored.
6 The exhaust air duct system of one fabrication area shall not connect to another duct system
7 outside that fabrication area within the building.

8 A ventilation system shall be provided to capture and exhaust fumes and vapors at
9 workstations.

10 Two or more operations at a workstation shall not be connected to the same exhaust system
11 where either one or the combination of the substances removed could constitute a fire,
12 explosion or hazardous chemical reaction within the exhaust duct system.

13 Exhaust ducts penetrating [~~occupancy separations~~] fire barriers constructed in accordance
14 with Section 707 or horizontal assemblies constructed in accordance with Section 711 shall
15 be contained in a shaft of equivalent fire-resistance-rated construction. Exhaust ducts shall
16 not penetrate [~~firewalls~~] fire walls.

17 Fire dampers shall not be installed in exhaust ducts.

18 **[415.8.2.7] 415.11.1.7 Transporting hazardous production materials to fabrication areas.**
19 [~~Hazardous production materials~~] HPM shall be transported to fabrication areas through enclosed
20 piping or tubing systems that comply with Section [~~415.8.6.1~~] 415.11.6, through service corridors
21 complying with Section [~~415.8.4~~] 415.11.3, or in exit access corridors as permitted in the
22 exception to Section [~~415.8.3~~] 415.11.2. The handling or transporting of [~~hazardous production~~
23 ~~materials~~] HPM within service corridors shall comply with the *New York City Fire Code*.

24 **[415.8.2.8] 415.11.1.8 Electrical.**

25 **[415.8.2.8.1 General.]** Electrical equipment and devices within the fabrication area shall
26 comply with the *New York City Electrical Code*. The requirements for hazardous locations
27 need not be applied where the average air change is at least four times that set forth in Section
28 [~~415.8.2.6~~] 415.11.1.6 and where the number of air changes at any location is not less than
29 three times that required by Section [~~415.8.2.6~~] 415.11.1.6. The use of recirculated air shall
30 be permitted.

31 **[415.8.2.8.2] 415.11.1.8.1 Workstations.** Workstations shall not be energized without
32 adequate exhaust ventilation. See Section [~~415.8.2.6~~] 415.11.1.6 for workstation exhaust
33 ventilation requirements.

34 **[415.8.3] 415.11.2 Corridors.** Corridors shall comply with Chapter 10 and shall be separated
35 from fabrication areas as specified in Section [~~415.8.2.2~~] 415.11.1.2. Corridors shall not contain
36 HPM [~~HPM~~] and shall not be used for transporting such materials[;] except through closed piping
37 systems as provided in Section [~~415.8.6.3~~] 415.11.6.

1 **Exception:** Where existing fabrication areas are altered or modified, HPM is allowed to be
2 transported in existing corridors, subject to the following conditions:

3 1. Nonproduction HPM is allowed to be transported in corridors if utilized for
4 maintenance, lab work and testing.

5 ~~[4.]~~ 2. Corridors. Corridors adjacent to the fabrication area where the alteration work
6 is to be done shall comply with Section ~~[4018]~~ 1020 for a length determined as
7 follows:

8 ~~[4.1.]~~ 2.1. The length of the common wall of the corridor and the fabrication area;
9 and

10 ~~[4.2.]~~ 2.2. For the distance along the corridor to the point of entry of HPM into
11 the corridor serving that fabrication area.

12 ~~[2.]~~ 3. Emergency alarm system. There shall be an emergency telephone system, a
13 local manual alarm station or other approved alarm-initiating device within corridors
14 at not more than 150-foot (45 720 mm) intervals and at each exit and doorway. The
15 signal shall be relayed to an approved central, proprietary or remote station service
16 or the emergency control station and shall also initiate a locale audible alarm.

17 ~~[3.]~~ 4. Pass-throughs. Self-closing doors having a fire-protection rating of not less
18 than 1 hour shall separate pass-throughs from existing corridors. Pass-throughs shall
19 be constructed as required for the corridors, and protected by an approved automatic
20 fire-extinguishing system.

21 **[415.8.4] 415.11.3 Service corridors.** Service corridors within a Group H-5 occupancy shall
22 comply with Sections 415.11.3.1 through 415.11.3.4.

23 ~~[415.8.4.1 Occupancy. Service corridors shall be classified as Group H-5.]~~

24 ~~[415.8.4.2] 415.11.3.1 Use conditions.~~ Service corridors shall be separated from exit access
25 corridors as required by Section ~~[415.8.2.2]~~ 415.11.1.2. Service corridors shall not be used as
26 a required exit access corridor.

27 ~~[415.8.4.3] 415.11.3.2 Mechanical ventilation.~~ Service corridors shall be mechanically
28 ventilated as required by Section ~~[415.8.2.6]~~ 415.11.1.6 or at not less than six air changes per
29 hour~~[, whichever is greater].~~

30 ~~[415.8.4.4] 415.11.3.3 Means of egress.~~ The ~~[maximum]~~ distance of travel from any point in
31 a service corridor to an exit, exit access corridor or door into a fabrication area shall be not
32 exceed greater than 75 feet (22 860 mm). Dead ends shall be not ~~[exceed]~~ greater than 4 feet
33 (1219 mm) in length. There shall be not less than two exits, and not more than one-half of the
34 required means of egress shall require travel into a fabrication area. Doors from service
35 corridors shall swing in the direction of egress travel and shall be self-closing.

1 **[415.8.4.5] 415.11.3.4 Minimum width.** The ~~[minimum]~~ clear width of a service corridor
2 shall be not less than 5 feet (1524 mm), or 33 inches (838 mm) wider than the widest cart or
3 truck used in the service corridor, whichever is greater.

4 **[415.8.4.6] 415.11.3.5 Emergency alarm system.** Emergency alarm systems shall be
5 provided in accordance with this section and Sections ~~[414.7.1]~~ 415.5.1 and ~~[414.7.2]~~ 415.5.2.
6 The maximum allowable quantity per control area provisions shall not apply to emergency
7 alarm systems required for HPM.

8 **[415.8.4.6.1] 415.11.3.5.1 Service corridors.** An emergency alarm system shall be
9 provided in service corridors, with ~~[at least]~~ no fewer than one alarm device in each
10 service corridor.

11 **[415.8.4.6.2] 415.11.3.5.2 Exit access corridors and exit enclosures.** Emergency alarms
12 for exit access corridors and exit enclosures shall comply with Section ~~[414.7.2]~~ 415.5.2.

13 **[415.8.4.6.3] 415.11.3.5.3 Liquid storage rooms, HPM rooms and gas rooms.**
14 Emergency alarms for liquid storage rooms, HPM rooms and gas rooms shall comply with
15 Section ~~[414.7.1]~~ 415.5.1.

16 **[415.8.4.6.4] 415.11.3.5.4 Alarm-initiating devices.** An approved emergency telephone
17 system, local alarm manual pull stations, or other approved alarm-initiating devices are
18 allowed to be used as emergency alarm-initiating devices.

19 **[415.8.4.6.5] 415.11.3.5.5 Alarm signals.** Activation of the emergency alarm system shall
20 sound a local alarm and transmit a signal to the emergency control station.

21 **[415.8.5] 415.11.4 Storage of hazardous production materials.**

22 ~~[415.8.5.1 General.]~~ Storage of HPM in fabrication areas shall be within approved or listed
23 storage cabinets or gas cabinets~~[-]~~ or within a workstation. The storage of ~~[hazardous production~~
24 ~~materials (HPM)]~~ HPM in quantities greater than those listed ~~[in Section 1804.2 of]~~ in the *New*
25 *York City Fire Code* shall be in liquid storage rooms, HPM rooms or gas rooms as appropriate for
26 the materials stored. The storage of other hazardous materials shall be in accordance with other
27 applicable provisions of this code and the *New York City Fire Code*.

28 **[415.8.5.2 Construction.]**

29 **[415.8.5.2.1] 415.11.5 HPM rooms [and], gas rooms, liquid storage room construction.** HPM
30 rooms ~~[and], gas rooms and liquid~~ shall be ~~[separated from other areas by fire barriers]~~
31 constructed in accordance with ~~[Section 707 or horizontal assemblies constructed in accordance~~
32 ~~with Section 712, or both.~~ The minimum fire resistance rating shall be 2 hours where the area
33 is 300 square feet (27.9 m²) or more and 1 hour where the area is less than 300 square feet (27.9
34 m²) Sections 415.11.5.1 through 415.11.5.9.

35 **415.11.5.1 HPM rooms and gas rooms.** HPM rooms and gas rooms shall be separated from
36 other areas by fire barriers constructed in accordance with Section 707 or horizontal
37 assemblies constructed in accordance with Section 711, or both. The fire-resistance rating

1 shall be not less than 2 hours where the area is 300 square feet (27.9 m²) or more and not less
2 than 1 hour where the area is less than 300 square feet (27.9 m²).

3 **[415.8.5.2.2] 415.11.5.2 Liquid storage rooms.** Liquid storage rooms shall be constructed in
4 accordance with the following requirements:

- 5 1. Rooms [~~in excess of~~] greater than 500 square feet (46.5 m²) in area, shall have [~~at least~~]
6 no fewer than one exterior door approved for Fire Department access.
- 7 2. Rooms shall be separated from other areas by fire barriers constructed in accordance with
8 Section 707 or horizontal assemblies constructed in accordance with Section [~~712~~] 711,
9 or both. The fire-resistance rating shall be [~~at least 1 hour~~] not less than 1 hour for rooms
10 up to 150 square feet (13.9 m²) in area and not less than 2 hours where the room is more
11 than 150 square feet (13.9 m²) in area.
- 12 3. Shelving, racks and [~~wainscoting~~] wainscoting in such areas shall be of noncombustible
13 construction or wood of not less than 1-inch (25 mm) nominal thickness or fire-retardant-
14 treated wood complying with Section 2303.2.
- 15 4. Rooms used for the storage of Class I flammable liquids shall not be located in a basement.

16 **[415.8.5.2.3] 415.11.5.3 Floors.** Except for surfacing, floors of HPM rooms and liquid storage
17 rooms shall be of noncombustible liquid-tight construction. Raised grating over floors shall
18 be of noncombustible materials.

19 **[415.8.5.3] 415.11.5.4 Location.** Where HPM rooms, liquid storage rooms and gas rooms
20 are provided, they shall have [~~at least~~] no fewer than one exterior wall and such wall shall be
21 not less than 30 feet (9144 mm) from tax-lot lines, including tax-lot lines adjacent to public
22 ways.

23 **[415.8.5.4] 415.11.5.5 Explosion control.** Explosion control shall be provided where required
24 by Section 414.5.1.

25 **[415.8.5.5] 415.11.5.6 Exits.** Where two exits are required from HPM rooms, liquid storage
26 rooms and gas rooms, one shall be directly to the outside of the building.

27 **[415.8.5.6] 415.11.5.7 Doors.** Doors in a fire barrier wall, including doors to corridors, shall
28 be self-closing fire door assemblies having a fire-protection rating of not less than ³/₄ hour.

29 **[415.8.5.7] 415.11.5.8 Ventilation.** Mechanical exhaust ventilation shall be provided in liquid
30 storage rooms, HPM rooms and gas rooms at the rate of not less than 1 cubic foot per minute
31 per square foot [~~(0.044 L/S/m²)~~] (0.044 L/s/m²) of floor area or six air changes per hour[
32 ~~whichever is greater, for categories of material~~].

33 Exhaust ventilation for gas rooms shall be designed to operate at a negative pressure in
34 relation to the surrounding areas and direct the exhaust ventilation to an exhaust system.

35 **[415.8.5.8] 415.11.5.9 Emergency alarm system.** An approved emergency alarm system
36 shall be provided for HPM rooms, liquid storage rooms and gas rooms.

1 Emergency alarm-initiating devices shall be installed outside of each interior exit door of
2 such rooms.

3 Activation of an emergency alarm-initiating device shall sound a local alarm and transmit
4 a signal to the emergency control station.

5 An approved emergency telephone system, local alarm manual pull stations or other
6 approved alarm-initiating devices are allowed to be used as emergency alarm-initiating
7 devices.

8 **[415.8.6] 415.11.6 Piping and tubing.**

9 **[415.8.6.1 General.]** Hazardous production materials piping and tubing shall comply with
10 ~~[Sections 416.8.6.1 through 416.8.6.4]~~ this section and ASME B31.3.

11 **[415.8.6.2 Supply piping and tubing.]**

12 **[415.8.6.2.1] 415.11.6.1 HPM having a health-hazard ranking of 3 or 4.** Systems supplying
13 HPM liquids or gases having a health-hazard ranking of 3 or 4 shall be welded throughout,
14 except for connections, to the systems that are within a ventilated enclosure if the material is
15 a gas, or an approved method of drainage or containment is provided for the connections if
16 the material is a liquid.

17 **[415.8.6.2.2] 415.11.6.2 Location in service corridors.** Hazardous production materials
18 supply piping or tubing in service corridors shall be exposed to view.

19 **[415.8.6.2.3] 415.11.6.3 Excess flow control.** Where HPM gases or liquids are carried in
20 pressurized piping above 15 pounds per square inch gauge (psig) (103.4 kPa), excess flow
21 control shall be provided. Where the piping originates from within a liquid storage room,
22 HPM room or gas room, the excess flow control shall be located within the liquid storage
23 room, HPM room or gas room. Where the piping originates from a bulk source, the excess
24 flow control shall be located as close to the bulk source as practical.

25 **[415.8.6.3] 415.11.6.4 Installations in corridors and above other occupancies.** The
26 installation of HPM piping and tubing within the space defined by the walls of exit access
27 corridors and the floor or roof above, or in concealed spaces above other occupancies, shall
28 be in accordance with ~~[Section 415.8.6.2]~~ Sections 415.11.6.1 through 415.11.6.3 and the
29 following conditions:

- 30 1. Automatic sprinklers shall be installed within the space unless the space is less than 6
31 inches (152 mm) in the least dimension.
- 32 2. Ventilation not less than six air changes per hour shall be provided. The space shall
33 not be used to convey air from any other area.
- 34 3. Where the piping or tubing is used to transport HPM liquids, a receptor shall be
35 installed below such piping or tubing. The receptor shall be designed to collect any
36 discharge or leakage and drain it to an approved location. The 1-hour enclosure shall
37 not be used as part of the receptor.

1 4. HPM supply piping and tubing and nonmetallic waste lines shall be separated from
2 the corridor and from occupancies other than Group H-5 by fire barriers or by an
3 approved method or assembly that ~~[have]~~ has a fire-resistance rating of not less than 1
4 hour. ~~[Where gypsum wallboard is used, joints on the piping side of the enclosure are~~
5 ~~not required to be taped, provided the joints occur over framing members.]~~ Access
6 openings into the enclosure shall be protected by approved fire-resistance-rated
7 assemblies.

8 5. Readily accessible manual or automatic remotely activated fail-safe emergency
9 shutoff valves shall be installed on piping and tubing other than waste lines at the
10 following locations:

11 5.1. At branch connections into the fabrication area.

12 5.2. At entries into exit access corridors.

13 **Exception:** Transverse crossings of the corridors by supply piping that is enclosed within
14 a ferrous pipe or tube for the width of the corridor need not comply with Items 1 through
15 5.

16 **[415.8.6.4] 415.11.6.5 Identification.** Piping, tubing and HPM waste lines shall be identified
17 in accordance with ANSI A13.1 to indicate the material being transported.

18 **[415.8.7] 415.11.7 Continuous ~~[gas-detection]~~ gas detection systems.** A continuous ~~[gas-~~
19 ~~detection]~~ gas detection system shall be provided for HPM gases ~~[when]~~ where the physiological
20 warning threshold level of the gas is at a higher level than the accepted permissible exposure limit
21 (PEL) for the gas and for flammable gases in accordance with ~~[this section]~~ Sections 415.11.7.1
22 and 415.11.7.2.

23 **[415.8.7.1] 415.11.7.1 Where required.** A continuous ~~[gas-detection]~~ gas detection system
24 shall be provided in the areas identified in Sections ~~[415.8.7.1.1]~~ 415.11.7.1.1 through
25 ~~[415.8.7.1.4]~~ 415.11.7.1.4.

26 **[415.8.7.1.1] 415.11.7.1.1 Fabrication areas.** A continuous ~~[gas-detection]~~ gas detection
27 system shall be provided in fabrication areas ~~[when]~~ where gas is used in the fabrication
28 area.

29 **[415.8.7.1.2] 415.11.7.1.2 HPM rooms.** A continuous ~~[gas-detection]~~ gas detection
30 system shall be provided in HPM rooms ~~[when]~~ where gas is used in the room.

31 **[415.8.7.1.3] 415.11.7.1.3 Gas cabinets, exhausted enclosures and gas rooms.** A
32 continuous ~~[gas-detection]~~ gas detection system shall be provided in gas cabinets and
33 exhausted enclosures. A continuous ~~[gas-detection]~~ gas detection system shall be provided
34 in gas rooms ~~[when]~~ where gases are not located in gas cabinets or exhausted enclosures.

35 **[415.8.7.1.4] 415.11.7.1.4 Corridors.** ~~[When]~~ Where gases are transported in piping
36 placed within the space defined by the walls of a corridor~~;~~ and the floor or roof above

1 the corridor, a continuous [~~gas-detection~~] gas detection system shall be provided where
2 piping is located and in the corridor.

3 **Exception:** A continuous [~~gas-detection~~] gas detection system is not required for
4 occasional transverse crossings of the corridors by supply piping that is enclosed in a
5 ferrous pipe or tube for the width of the corridor.

6 **[415.8.7.2] 415.11.7.2 [~~Gas-detection~~] Gas detection system operation.** The continuous
7 [~~gas-detection~~] gas detection system shall be capable of monitoring the room, area or
8 equipment in which the gas is located at or below all the following gas concentrations:

- 9 1. Immediately dangerous to life and health (IDLH) values [~~when~~] where the monitoring
10 point is within an exhausted enclosure, ventilated enclosure or gas cabinet.
- 11 2. Permissible exposure limit (PEL) levels [~~when~~] where the monitoring point is in an
12 area outside an exhausted enclosure, ventilated enclosure or gas cabinet.
- 13 3. For flammable gases, the monitoring detection threshold level shall be vapor
14 concentrations in excess of 25 percent of the lower flammable limit (LFL) [~~when~~]
15 where the monitoring is within or outside an exhausted enclosure, ventilated enclosure
16 or gas cabinet.
- 17 4. Except as noted in this section, monitoring for highly toxic and toxic gases shall also
18 comply with [~~Chapter 37 of~~] the *New York City Fire Code*.

19 **[415.8.7.2.1] 415.11.7.2.1 Alarms.** The gas detection system shall initiate a local alarm
20 and transmit a signal to the emergency control station when a short-term hazard condition
21 is detected. The alarm shall be both visual and audible and shall provide warning both
22 inside and outside the area where the gas is detected. The audible alarm shall be distinct
23 from all other alarms.

24 **[415.8.7.2.2] 415.11.7.2.2 Shutoff of gas supply.** The gas detection system shall
25 automatically close the shutoff valve at the source on gas supply piping and tubing related
26 to the system being monitored for which gas is detected when a short-term hazard
27 condition is detected. Automatic closure of shutoff valves shall comply with the following:

- 28 1. Where the gas detection sampling point initiating the gas detection system alarm
29 is within a gas cabinet or exhausted enclosure, the shutoff valve in the gas cabinet
30 or exhausted enclosure for the specific gas detected shall automatically close.
- 31 2. Where the gas detection sampling point initiating the gas detection system alarm
32 is within a room and compressed gas containers are not in gas cabinets or an
33 exhausted enclosure, the shutoff valves on all gas lines for the specific gas detected
34 shall automatically close.
- 35 3. Where the gas detection sampling point initiating the gas detection system alarm
36 is within a piping distribution manifold enclosure, the shutoff valve supplying the

1 manifold for the compressed gas container of the specific gas detected shall
2 automatically close.

3 **Exception:** Where the [~~gas detection~~] gas detection sampling point initiating the gas
4 detection system alarm is at the use location or within a gas valve enclosure of a branch
5 line downstream of a piping distribution manifold, the shutoff valve for the branch line
6 located in the piping distribution manifold enclosure shall automatically close.

7 **[415.8.8] 415.11.8 Manual fire alarm system.** An approved manual fire alarm system shall be
8 provided throughout buildings containing Group H-5. Activation of the alarm system shall initiate
9 a local alarm and transmit a signal to the emergency control station. The fire alarm system shall
10 be designed and installed in accordance with Section 907.

11 **[415.8.9] 415.11.9 Emergency control station.** An emergency control station shall be provided
12 in accordance with Sections [~~415.8.9.1~~] 415.11.9.1 through [~~415.8.9.3~~] 415.11.9.3.

13 **[415.8.9.1] 415.11.9.1 Location.** The emergency control station shall be located on the
14 premises at an approved location outside the fabrication area.

15 **[415.8.9.2] 415.11.9.2 Staffing.** Trained personnel shall continuously staff the emergency
16 control station.

17 **[415.8.9.3] 415.11.9.3 Signals.** The emergency control station shall monitor signals from
18 emergency equipment and alarm and detection systems. Such emergency equipment and
19 alarm and detection systems shall include the following systems, whether required by this
20 code or the *New York City Construction Codes* or voluntarily installed:

- 21 1. Automatic sprinkler system alarm and monitoring systems.
- 22 2. Manual fire alarm systems.
- 23 3. Emergency alarm systems.
- 24 4. Continuous gas detection systems.
- 25 5. Smoke detection systems.
- 26 6. Emergency power system.
- 27 7. Automatic detection and alarm systems for pyrophoric liquids and Class 3 water-
28 reactive liquids required in [~~Section 1803 of~~] the *New York City Fire Code*.
- 29 8. Exhaust ventilation flow alarm devices for pyrophoric liquids and Class 3 water-
30 reactive liquids cabinet exhaust ventilation systems required in [~~Section 1803 of~~] the
31 *New York City Fire Code*.

32 **[415.8.10] 415.11.10 Emergency power system.** An emergency power system shall be provided
33 in Group H-5 occupancies [~~where required~~] in accordance with Section [~~415.8.10.1~~] 2702. The
34 emergency power system shall [~~be designed to~~] supply power automatically to [~~required~~] the

1 electrical systems specified in Section 415.11.10.1 when the normal electrical supply system is
2 interrupted.

3 ~~[415.8.10.1]~~ **415.11.10.1 Required electrical systems.** Emergency power shall be provided
4 for electrically operated equipment and connected control circuits for the following systems:

- 5 1. HPM exhaust ventilation systems.
- 6 2. HPM gas cabinet ventilation systems.
- 7 3. HPM exhausted enclosure ventilation systems.
- 8 4. HPM gas room ventilation systems.
- 9 5. HPM gas detection systems.
- 10 6. Emergency alarm systems.
- 11 7. Manual and automatic fire alarm systems.
- 12 8. Automatic sprinkler system monitoring and alarm systems.
- 13 9. Automatic alarm and detection systems for pyrophoric liquids and Class 3 water-
14 reactive liquids required in [~~Section 1803 of~~] the *New York City Fire Code*.
- 15 10. Flow alarm switches for pyrophoric liquids and Class 3 water-reactive liquids cabinet
16 exhaust ventilation systems required in [~~Section 1803 of~~] the *New York City Fire*
17 *Code*.
- 18 11. Electrically operated systems required elsewhere in this code applicable to the use,
19 storage or handling of HPM.

20 ~~[415.8.10.2]~~ **415.11.10.2 Exhaust ventilation systems.** Exhaust ventilation systems are
21 allowed to be designed to operate at not less than one-half the normal fan speed on the
22 emergency power system where it is demonstrated that the level of exhaust will maintain a
23 safe atmosphere.

24 ~~[415.8.11]~~ **415.11.11 Automatic sprinkler system protection in exhaust ducts for HPM.**

25 ~~[415.8.11.1 Exhaust ducts for HPM.]~~ An approved automatic fire sprinkler system shall be
26 provided in exhaust ducts conveying vapors, fumes, mists or dusts generated from HPM in
27 accordance with [~~this section and~~] the *New York City Mechanical Code* and Sections 415.11.11.1
28 through 415.11.11.3 of this code.

29 ~~[415.11.2]~~ **415.11.11.1 Metallic and noncombustible[;] nonmetallic exhaust ducts.** An
30 approved automatic sprinkler system shall be provided in metallic and noncombustible
31 nonmetallic exhaust ducts [~~when~~] where all of the following conditions apply:

1. Where the largest cross-sectional diameter is equal to or greater than 10 inches (254 mm).
2. The ducts are within the building.
3. The ducts are conveying flammable gases, vapors or fumes.

[415.8.11.3] 415.11.11.2 Combustible nonmetallic exhaust ducts. Automatic fire sprinkler system protection shall be provided in combustible nonmetallic exhaust ducts where the largest cross-sectional diameter of the duct is equal to or greater than 10 inches (254 mm).

[Exceptions:] Exception: Ducts need not be provided with automatic sprinkler protection as follows:

1. Ducts listed or approved for applications without automatic ~~[fire]~~ sprinkler system protection.
2. Ducts not more than 12 feet (3658 mm) in length installed below ceiling level.

[415.8.11.4] 415.11.11.3 Automatic sprinkler locations. Sprinkler systems shall be installed at 12-foot (3658 mm) intervals in horizontal ducts and at changes in direction. In vertical ducts, sprinklers shall be installed at the top and at alternate floor levels.

SECTION BC 416 APPLICATION OF FLAMMABLE FINISHES

416.1 General. The provisions of this section shall apply to the construction, installation and use of buildings and structures, or parts thereof, for the ~~[spraying]~~ application of flammable paints, varnishes and lacquers or other flammable materials or mixtures or compounds used for painting, varnishing, staining or similar purposes. Such construction and equipment shall comply with the *New York City Fire Code*.

416.2 Spray rooms. Spray rooms shall be enclosed with not less than 2-hour fire barriers constructed in accordance with Section 707~~[7]~~ or horizontal assemblies constructed in accordance with Section ~~[712]~~ 711, or both. ~~[The enclosure shall be at least 2-hour fire resistance rated.]~~ Floors shall be waterproofed and drained in an approved manner.

416.2.1 Surfaces. The interior surfaces of spray rooms shall be smooth and shall be so constructed to permit the free passage of exhaust air from all parts of the interior and to facilitate washing and cleaning, and shall be so designed to confine residues within the room. Aluminum shall not be used.

416.2.2 Ventilation. Mechanical ventilation and interlocks with the spraying operation shall be in accordance with the *New York City Mechanical Code*.

416.3 Spraying spaces. Spraying spaces shall be ventilated with an exhaust system capable of at least six air changes per hour to prevent the accumulation of flammable mist or vapors in accordance with the *New York City Mechanical Code*. Where such spaces are not separately enclosed, noncombustible spray curtains shall be provided to restrict the spread of flammable vapors.

1 **416.3.1 Surfaces.** The interior surfaces of spraying spaces shall be smooth and continuous without
2 edges~~[, and]~~; shall be so constructed to permit the free passage of exhaust air from all parts of the
3 interior and to facilitate washing and cleaning; and shall be so designed to confine residues within
4 the spraying space. Aluminum shall not be used.

5 **416.4 Spray booths.** Spray booths shall be designed, constructed and operated in accordance with
6 the *New York City Fire Code*.

7 **416.5 Fire protection.** An automatic sprinkler system or fire-extinguishing system shall be provided
8 in all spray, dip and immersing spaces and storage rooms~~[,]~~ and shall be installed in accordance with
9 Chapter 9.

10 **SECTION BC 417**
11 **DRYING ROOMS**

12 **417.1 General.** A drying room or dry kiln installed within a building shall be constructed entirely of
13 approved noncombustible materials or assemblies of such materials regulated by the approved rules
14 or as required in the general and specific sections of ~~[Chapter 4]~~ this chapter for special occupancies,
15 where applicable to the general requirements of Chapter 28 of this code, and in accordance with the
16 *New York City Fire Code*.

17 **417.2 Piping clearance.** Overhead heating pipes shall have a clearance of not less than 2 inches (51
18 mm) from combustible contents in the dryer.

19 **417.3 Insulation.** Where the operating temperature of the dryer is 175°F (79°C) or more, metal
20 enclosures shall be insulated from adjacent combustible materials by not less than 12 inches (305
21 mm) of airspace, or the metal walls shall be lined with 1/4-inch (6.4 mm) insulating mill board or other
22 approved equivalent insulation.

23 **417.4 Fire protection.** Drying rooms designed for high-hazard materials and processes, including
24 special occupancies as provided for in ~~[Chapter 4]~~ this chapter, shall be protected by an approved
25 automatic ~~[sprinkler or]~~ fire-extinguishing system ~~[conforming to]~~ complying with the provisions of
26 Chapter 9.

27 **SECTION BC 418**
28 **ORGANIC COATINGS**

29 **418.1 Building features.** Manufacturing of organic coatings shall be done only in buildings that do
30 not have pits or basements and shall comply with the *New York City Fire Code*. Such buildings shall
31 be protected by an approved automatic sprinkler system in accordance with Chapter 9 of this code.

32 **418.2 Location.** Organic coating manufacturing operations and operations incidental to or connected
33 therewith shall not be located in buildings having other occupancies.

34 **418.3 Process mills.** Mills operating with close clearances and that process flammable and heat-
35 sensitive materials, such as nitrocellulose, shall be classified as Group H-1 occupancy.

36 **418.4 Tank storage.** Storage areas for flammable and combustible liquid tanks inside of structures
37 shall be located at or above grade and shall be separated from the processing area by not less than 2-

1 hour fire-resistance-rated fire barriers constructed in accordance with Section 707 or horizontal
2 assemblies constructed in accordance with Section ~~[712]~~ 711, or both.

3 **418.5 Nitrocellulose storage.** Nitrocellulose storage shall be located on a detached pad or in a
4 separate structure or a room enclosed with no less than 2-hour fire-resistance-rated fire barriers.

5 **418.6 Finished products.** Storage rooms for finished products that are flammable or combustible
6 liquids shall be separated from the processing area by fire barriers constructed in accordance with
7 Section 707 or horizontal assemblies constructed in accordance with Section ~~[712]~~ 711, or both
8 having a fire-resistance rating of at least 2 hours, and openings in the walls shall be protected with
9 approved opening protectives.

10 **SECTION 419**
11 **RESERVED**

12 **SECTION BC 420**
13 **GROUPS I-1, R-1, R-2, R-3**

14 **420.1 General.** Occupancies in Groups I-1, R-1, R-2 and R-3 shall comply with the provisions of
15 ~~[this section]~~ Sections 420.1 through 420.6 and other applicable provisions of this code.

16 **420.2 Separation walls.** Walls separating dwelling units in the same building, walls separating
17 sleeping units in the same building and walls separating dwelling or sleeping units from other
18 occupancies contiguous to them in the same building shall be constructed as fire barriers constructed
19 in accordance with Section 707 and shall be at least 1-hour fire-resistance-rated.

20 **420.3 Horizontal separation.** Floor assemblies separating dwelling units in the same buildings, floor
21 assemblies separating sleeping units in the same building and floor assemblies separating dwelling or
22 sleeping units from other occupancies contiguous to them in the same building shall be constructed
23 as horizontal assemblies in accordance with Section ~~[712]~~ 711.

24 **420.4 Reserved.**

25 **420.5 Automatic sprinkler system.** Group R occupancies shall be equipped throughout with an
26 automatic sprinkler system in accordance with Section 903.2.8. Group I-1 occupancies shall be
27 equipped throughout with an automatic sprinkler system in accordance with Section 903.2.6. Quick
28 response or residential automatic sprinklers shall be installed in accordance with Section 903.3.2.

29 **420.6 Fire alarm systems and smoke alarms.** Fire alarm systems and smoke alarms shall be
30 provided in Group I-1, R-1, and R-2 occupancies in accordance with Sections 907.2.6, 907.2.8 and
31 907.2.9, respectively. Single or multiple station smoke alarms shall be provided in Groups I-1, R-2,
32 and R-3 in accordance with Section 907.2.11.

33 **SECTION BC 421**
34 **~~[RESERVED]~~**
35 **HYDROGEN FUEL GAS ROOMS**

36 **421.1 General.** Where required by the *New York City Fire Code*, hydrogen fuel gas rooms shall be
37 designed and constructed in accordance with Sections 421.1 through 421.7 of this code.

1 **421.1.1 Scope.** Hydrogen fuel gas rooms shall be separately ventilated, fully enclosed, and shall
2 contain all equipment and piping for the immediate on-premises use of hydrogen in indoor fuel
3 cells or other energy production process, and incidental indoor storage of gaseous hydrogen in
4 accordance with the *New York City Fire Code*. A hydrogen fuel gas room shall not be used to
5 house production or dispensing of hydrogen motor fuel.

6 **421.1.2 Storage.** Hydrogen fuel gas rooms shall not be used for storage of gaseous hydrogen in
7 quantities exceeding the maximum allowable quantity per control area set forth in Table 307.1(1).
8 Where approved by the Fire Department, such hydrogen fuel gas rooms permitted to store greater
9 quantities shall be classified as Occupancy Group H.

10 **421.1.3 Definitions.** The following term is defined in Chapter 2:

11 **HYDROGEN FUEL GAS ROOM.**

12 **421.2 Location.** Hydrogen fuel gas rooms shall not be located below grade.

13 **421.3 Design and construction.** Hydrogen fuel gas rooms not classified as Occupancy Group H shall
14 be separated from other areas of the building in accordance with Section 509.1. Such separation shall
15 have a fire-resistance rating of not less than 2 hours for all occupancy groups.

16 **421.3.1 Pressure control.** Hydrogen fuel gas rooms shall be provided with a ventilation system
17 designed to maintain the room at a negative pressure in relation to surrounding area.

18 **421.3.2 Windows.** Operable windows in interior walls shall not be permitted. Fixed windows
19 shall be permitted where in accordance with Section 716.

20 **421.4 Exhaust ventilation.** Hydrogen fuel gas rooms shall be separately ventilated and provided with
21 mechanical exhaust ventilation in accordance with the applicable provisions of NFPA 2.

22 **421.5 Gas detection system.** Hydrogen fuel gas rooms shall be provided with a gas detection system
23 that complies with Sections 421.5.1, 421.5.2, and 918.

24 **421.5.1 System activation.** Activation of a gas detection alarm shall initiate the following
25 notification and action:

- 26 1. Initiation of distinct audible and visible alarm signals both inside and outside of the
27 hydrogen fuel gas room.
- 28 2. Automatic activation of the mechanical exhaust ventilation system.

29 **421.5.2 Failure of the gas detection system.** Failure of the gas detection system shall
30 automatically discontinue hydrogen generation, activate the mechanical exhaust ventilation
31 system and transmit a supervisory signal to the control panel and a central station.

32 **421.6 Explosion control.** Explosion control shall be provided where required by Section 414.5.1.

33 **421.7 Emergency power.** Mechanical exhaust ventilation and gas detection systems shall be
34 provided with an emergency power system in accordance with Section 2702.

1 SECTION BC 422
2 AMBULATORY ~~[HEALTH]~~ CARE FACILITIES

3 **422.1 General.** ~~[Occupancies classified as Group B ambulatory]~~ Ambulatory ~~[health]~~ care facilities
4 shall comply with the provisions of Sections 422.1 through ~~[422.6]~~ 422.5 and other applicable
5 provisions of this code.

6 **422.2 Separation.** Ambulatory care facilities, where there is the potential for four or more care
7 recipients who will be incapable of self-preservation at any time, whether rendered incapable by staff
8 or staff accepted responsibility for a care recipient already incapable, shall be separated from adjacent
9 spaces, corridors or tenants with a fire partition installed in accordance with Section 708.

10 **422.3 Smoke ~~[barriers]~~ compartments.** ~~[Smoke barriers shall be provided to subdivide every]~~
11 Where the aggregate area of one or more ambulatory care ~~[facility]~~ facilities is greater than 10,000
12 square feet (929 m²) on one story, the story shall be provided with a smoke barrier to subdivide the
13 story into ~~[a minimum of]~~ no fewer than two smoke compartments ~~[per story]~~. The ~~[travel]~~ area of
14 any one such smoke compartment shall be not greater than 22,500 square feet (2092 m²). The
15 distance of travel from any point in a smoke compartment to a smoke barrier door shall be not
16 ~~[exceed]~~ greater than 200 feet (60 960 mm). The smoke barrier shall be installed in accordance with
17 Section ~~[710]~~ 709 with the exception that smoke barriers shall be continuous from outside wall to
18 an outside wall, a floor to a floor, or from a smoke barrier to a smoke barrier or a combination
19 thereof.

20 **422.3.1 Means of egress.** Where ambulatory care facilities require smoke compartmentation in
21 accordance with Section 422.3 of this code, the fire protection and emergency preparedness plans
22 shall comply with the applicable provisions of the *New York City Fire Code* and shall be in
23 accordance with Section 1001.4 of this code.

24 ~~[422.3]~~ **422.3.2 Refuge area.** ~~[At least]~~ Not less than 30 net square feet (2.8 m²) ~~[per]~~ for each
25 nonambulatory ~~[patient]~~ care recipient shall be provided within the aggregate area of corridors,
26 ~~[patient]~~ care recipient rooms, treatment rooms, lounge or dining areas and other low-hazard areas
27 ~~[on each side of each smoke barrier]~~ within each smoke compartment. Each occupant of an
28 ambulatory care facility shall be provided with access to a refuge area without passing through or
29 utilizing adjacent tenant spaces.

30 ~~[422.4]~~ **422.3.3 Independent egress.** A means of egress shall be provided from each smoke
31 compartment created by smoke barriers without having to return through the smoke compartment
32 from which means of egress originated.

33 ~~[422.5]~~ **422.4 Automatic sprinkler systems.** Automatic sprinkler systems shall be provided for
34 ambulatory care facilities in accordance with Section 903.2.2.

35 ~~[422.6]~~ **422.5 Fire alarm systems.** A fire alarm system shall be provided for ambulatory care
36 facilities in accordance with Section ~~[907.2.2.1]~~ 907.2.2.

**SECTION BC 423
STORM SHELTERS**

423.1 General. In addition to other applicable requirements in this code, storm shelters shall be constructed in accordance with ~~[ICC-500]~~ ICC 500.

423.1.1 Scope. This section applies to the construction of storm shelters constructed as separate detached buildings or constructed as safe rooms within buildings for the purpose of providing safe refuge from storms that produce high winds, such as tornados and hurricanes. Such structures shall be designated to be hurricane shelters, tornado shelters, or combined hurricane and tornado shelters.

423.2 Definitions specific to this section. The following ~~[words and]~~ terms shall, for the purposes of this ~~[chapter and as used elsewhere in this code]~~ section, have the meanings shown herein[-]:

STORM SHELTER. A building, structure or portion(s) thereof, constructed in accordance with ICC 500 and designated for use during a severe wind storm event, such as a hurricane or tornado.

~~[COMMUNITY STORM SHELTER]~~ **Community storm shelter.** A storm shelter not defined as a "Residential ~~[Storm Shelter]~~ storm shelter."

~~[RESIDENTIAL STORM SHELTER]~~ **Residential storm shelter.** A storm shelter serving occupants of dwelling units and having an occupant load not exceeding 16 persons.

:

**SECTION 424
CHILDREN'S PLAY STRUCTURES**

424.1 Children's play structures. Children's play structures installed inside all occupancies covered by this code that exceed 10 feet (3048 mm) in height and 150 square feet (14 m²) in area shall comply with Sections 424.2 through 424.5.

424.2 Materials. Children's play structures shall be constructed of noncombustible materials or of combustible materials that comply with the following:

1. Fire-retardant-treated wood complying with Section 2303.2 of this code.
2. Light-transmitting plastics complying with Section 2606 of this code.
3. Foam plastics (including the pipe foam used in soft-contained play equipment structures) having a maximum heat-release rate not greater than 100 kilowatts when tested in accordance with UL 1975 or when tested in accordance with NFPA 289, using the 20 kW ignition source.
4. Aluminum composite material (ACM) meeting the requirements of Class A interior finish in accordance with Chapter 8 of this code when tested as an assembly in the maximum thickness intended for use.

- 1 5. Textiles and films complying with the fire propagation performance criteria contained in Test
2 Method 1 or Test Method 2, as appropriate, of NFPA 701.
- 3 6. Plastic materials used to construct rigid components of soft-contained play equipment
4 structures (such as tubes, windows, panels, junction boxes, pipes, slides and decks) exhibiting
5 a peak rate of heat release not exceeding 400 kW/m² when tested in accordance with ASTM
6 E 1354 at an incident heat flux of 50 kW/m² in the horizontal orientation at a thickness of 6
7 mm.
- 8 7. Ball pool balls, used in soft-contained play equipment structures, having a maximum heat-
9 release rate not greater than 100 kilowatts when tested in accordance with UL 1975 or when
10 tested in accordance with NFPA 289, using the 20 kW ignition source. The minimum
11 specimen test size shall be 36 inches by 36 inches (914 mm by 914 mm) by an average of 21
12 inches (533 mm) deep, and the balls shall be held in a box constructed of galvanized steel
13 poultry netting wire mesh.
- 14 8. Foam plastics shall be covered by a fabric, coating or film meeting the fire propagation
15 performance criteria contained in Test Method 1 or Test Method 2, as appropriate, of NFPA
16 701.
- 17 9. The floor covering placed under the children's play structure shall exhibit a Class I interior
18 floor finish classification, as described in Section 804, when tested in accordance with NFPA
19 253.

20 **424.3 Fire protection.** Children's play structures shall be provided with the same level of approved
21 fire protection system required for other structures in the same occupancy.

22 **424.4 Separation.** Children's play structures shall have a horizontal separation from building walls,
23 partitions and from elements of the means of egress of not less than 5 feet (1524 mm). Children's
24 playground structures shall have a horizontal separation from other children's play structures of not
25 less than 20 feet (6090 mm).

26 **424.5 Area limits.** Children's play structures shall be not greater than 300 square feet (28 m²) in area.

27 **SECTION BC 425**
28 **HYPERBARIC FACILITIES**

29 **425.1 Hyperbaric facilities.** Hyperbaric facilities shall meet the requirements contained in Chapter
30 14 of NFPA 99.

31 **SECTION 426**
32 **COMBUSTIBLE DUSTS, GRAIN PROCESSING AND STORAGE**

33 **426.1 Combustible dusts, grain processing and storage.** The provisions of Sections 426.1.1
34 through 426.1.7 shall apply to buildings in which materials that produce combustible dusts are stored
35 or handled. Buildings that store or handle combustible dusts shall comply with the applicable
36 provisions of NFPA 61, NFPA 69, NFPA 85, NFPA 120, NFPA 484, NFPA 654, NFPA 655 and
37 NFPA 664 and the *New York City Fire Code*.

1 **426.1.1 Type of construction and height exceptions.** Buildings shall be constructed in
2 compliance with the height, number of stories and area limitations specified in Sections 504 and
3 506; except that where erected of Type I or II construction, the heights and areas of grain elevators
4 and similar structures shall be unlimited, and where of Type IV construction, the maximum
5 building height shall be 65 feet (19 812 mm) and except further that, in isolated areas, the
6 maximum building height of Type IV structures shall be increased to 85 feet (25 908 mm).

7 **426.1.2 Grinding rooms.** Every room or space occupied for grinding or other operations that
8 produce combustible dusts in such a manner that the room or space is classified as a Group H-2
9 occupancy shall be enclosed with fire barriers constructed in accordance with Section 707 or
10 horizontal assemblies constructed in accordance with Section 711, or both. The fire-resistance
11 rating of the enclosure shall be not less than 2 hours where the area is not more than 3,000 square
12 feet (279 m²), and not less than 4 hours where the area is greater than 3,000 square feet (279 m²).

13 **426.1.3 Conveyors.** Conveyors, chutes, piping and similar equipment passing through the
14 enclosures of rooms or spaces shall be constructed dirt tight and vapor tight, and be of approved
15 noncombustible materials complying with Chapter 30.

16 **426.1.4 Explosion control.** Explosion control shall be provided as specified in the *New York City*
17 *Fire Code*, or spaces shall be equipped with the equivalent mechanical ventilation complying with
18 the *New York City Mechanical Code*.

19 **426.1.5 Grain elevators.** Grain elevators, malt houses and buildings for similar occupancies shall
20 not be located within 30 feet (9144 mm) of interior lot lines or structures on the same lot, except
21 where erected along a railroad right-of-way.

22 **426.1.6 Coal pockets.** Coal pockets located less than 30 feet (9144 mm) from interior lot lines or
23 from structures on the same lot shall be constructed of not less than Type IB construction. Where
24 more than 30 feet (9144 mm) from interior lot lines, or where erected along a railroad right-of-
25 way, the minimum type of construction of such structures not more than 65 feet (19 812 mm) in
26 building height shall be Type IV.

27 **426.1.7 Tire rebuilding.** Buffing operations shall be located in a room separated from the
28 remainder of the building housing the tire rebuilding or tire recapping operation by a 1-hour fire
29 barrier.

30 **Exception:** Buffing operations are not required to be separated where all of the following
31 conditions are met:

- 32 1. Buffing operations are equipped with an approved continuous automatic water-spray
33 system directed at the point of cutting action;
- 34 2. Buffing machines are connected to particle-collecting systems providing a minimum
35 air movement of 1,500 cubic feet per minute (cfm) (0.71 m³/5) in volume and 4,500
36 feet per minute (fpm) (23 m/s) in-line velocity; and

1 separate laboratory work areas, and accessory storage rooms or spaces within or contiguous with
2 the laboratory unit, such as offices and lavatories.

3 **STORAGE CABINET.** A cabinet designed and constructed in accordance with UL 1275, and
4 used for the storage of not more than 60 gallons (227 L) of flammable and combustible liquids.

5 **STORAGE ROOM.** A room where laboratory chemicals or gases are stored and not otherwise
6 used or synthesized.

7 **[424.5] 427.5 Classification.** Buildings or portions thereof occupied as a nonproduction laboratory
8 may be classified as a Group B occupancy provided they comply with the provisions of Section
9 [424] 427. Nonproduction laboratories not in compliance with the provisions of Section [424.7]
10 427.7 for laboratory chemical quantity limitations shall be classified as Group H occupancy.

11 **[424.5.1] 427.5.1 Accessory use nonproduction laboratories.** Accessory use nonproduction
12 laboratories occupying an area not more than 10 percent of the area of the story in which such
13 laboratories are located and not exceeding the tabular values in [~~Table 503~~] Sections 504 and
14 506, for the allowable height or area for such use shall be classified according to the main
15 occupancy. Such accessory nonproduction laboratories shall comply with the provisions of
16 Section [424] 427.

17 **[424.6] 427.6 Fire protection.** Fire protection systems in nonproduction laboratories shall be
18 provided in accordance with Section 427.6.1 through 427.6.3.

19 **[424.6.1] 427.6.1 Sprinkler system.** Laboratory units shall be provided throughout with an
20 automatic sprinkler system in accordance with Section 903.3.1.1. The entire building shall be
21 provided throughout with an automatic sprinkler system when the aggregate floor area of all
22 laboratory units within any building exceeds 20,000 square feet (1858 m²).

23 **[424.6.2] 427.6.2 Standpipe and hose system.** In all nonproduction laboratory buildings that are
24 two or more stories above or below the grade level (level of exit discharge), standpipes shall be
25 installed in accordance with Section 905.2.

26 **[424.6.3] 427.6.3 Fire alarm system.** A manual fire alarm system shall be installed in accordance
27 with Section 907.2.2, 907.2.3, or 907.2.6, as applicable.

28 **[424.7] 427.7 Quantity limitations.** Quantity limitations in nonproduction laboratories shall be
29 provided in accordance with Section 427.7.1 through 427.7.10.

30 **[424.7.1] 427.7.1 Flammable and combustible liquids.** The density and total quantity of
31 flammable and combustible liquids allowed within a laboratory unit, outside of storage rooms,
32 shall comply with Table [~~40.4.1~~] 9.1.1(A) of NFPA 45, as modified by the *New York City Fire*
33 *Code*, for laboratory unit fire hazard Class D.

34 **Exceptions:** The following exceptions apply to other than educational or instructional
35 laboratories:

- 36 1. The density of flammable and combustible liquids allowed within a laboratory unit
37 may be increased to those set forth in Table [~~40.4.1~~] 9.1.1(A) of NFPA 45 as modified

1 by the *New York City Fire Code*, for laboratory unit fire hazard Class B provided the
2 total quantity of flammable and combustible liquid, including any in storage cabinets
3 or safety cans, does not exceed 25 gallons (95 L).

4 2. The density of flammable and combustible liquids allowed within a laboratory unit
5 may be increased to those set forth in Table ~~[40.4.4]~~ 9.1.1(A) of NFPA 45 as modified
6 by the *New York City Fire Code*, for laboratory unit fire hazard Class B provided the
7 total quantity of flammable and combustible liquid, including any in storage cabinets
8 or safety cans, does not exceed 30 gallons (114 L) and the walls, floors and ceilings
9 of the laboratory unit are separated from all adjoining areas by 2-hour fire-rated
10 construction.

11 3. Based on a density of 1 gallon per 100 square feet (3.785 L per 9.3 m²) of area, the
12 quantity of flammable and combustible liquid allowed within a laboratory unit,
13 excluding quantities in storage cabinets or safety cans, may be increased to 100
14 gallons (379 L), and the total quantities of flammable and combustible liquids,
15 including quantities in storage cabinets or safety cans, may be increased to 200
16 gallons ~~[(775 L)]~~ (757 L) provided the walls, floors and ceilings of the laboratory unit
17 are separated from all adjoining areas by 2-hour fire-rated construction.

18 **[424.7.2] 427.7.2 Flammable solids.** The total quantity of flammable solids allowed within a
19 laboratory unit, excluding any quantities in a storage room, shall not exceed 10 pounds (4.5 kg).

20 **Exception:** The total quantity of flammable solids allowed within a laboratory unit that is
21 provided with walls, floors and ceilings that separate the laboratory unit from all adjoining
22 areas by 2-hour fire-rated construction shall not exceed 15 pounds (6.8 kg).

23 **[424.7.3] 427.7.3 Oxidizers and organic peroxides.** The total quantity of solid and liquid
24 oxidizers and organic peroxides combined allowed within a laboratory unit, excluding any
25 quantities in a storage room, shall not exceed 40 pounds (18 kg), provided not more than 2 pounds
26 (0.908 kg) of which are Class 3 oxidizers and 1 pound (0.454 kg) of which is Class I organic
27 peroxides.

28 **Exception:** The total quantity of solid and liquid oxidizers and organic peroxides combined
29 allowed within a laboratory unit that is provided with walls, floors and ceilings that separate
30 the laboratory unit from all adjoining areas by 2-hour fire rated construction shall not exceed
31 50 pounds (23 kg), provided not more than 2 pounds (0.908 kg) of which is Class 3 oxidizers
32 and 1 pound (0.454 kg) of which are Class I organic peroxides.

33 **[424.7.4] 427.7.4 Unstable (reactive).** The total quantity of unstable (reactive) material allowed
34 within a laboratory unit, excluding any quantities in a storage room, shall not exceed 6 pounds
35 (2.7 kg), provided not more than 1 pound (0.454 kg) of which is Class 3 unstable (reactive).

36 **Exception:** The total quantity of unstable (reactive) material allowed within a laboratory unit
37 that is provided with walls, floors and ceilings that separate the laboratory unit from all
38 adjoining areas by 2-hour fire-rated construction shall not exceed 12 pounds (5.4 kg), pro-
39 vided not more than 1 pound (0.454 kg) of which is Class 3 unstable (reactive).

1 **[424.7.5] 427.7.5 Water reactive material.** The total quantity of water reactive material allowed
2 within a laboratory unit, excluding any quantities in a storage room, shall not exceed 2.5 pounds
3 (1.1 kg).

4 **Exception:** The total quantity of water-reactive material allowed within a laboratory unit that
5 is provided with walls, floors and ceilings that separate the laboratory unit from all adjoining
6 areas by 2-hour fire-rated construction shall not exceed 5 pounds (2.3 kg).

7 **[424.7.6] 427.7.6 Pyrophoric material.** The total quantity of solid or liquid pyrophoric material
8 allowed within a laboratory unit, excluding any quantities in a storage room, shall not exceed 0.5
9 pounds (0.227 kg).

10 **Exception:** The total quantity of pyrophoric material allowed within a laboratory unit that is
11 provided with walls, floors and ceilings that separate the laboratory unit from all adjoining
12 areas by 2-hour fire rated construction shall not exceed 1 pound (0.454 kg).

13 **[424.7.7] 427.7.7 Highly toxic material.** The total quantity of solid or liquid highly toxic
14 material allowed within a laboratory unit, excluding any quantities in a storage room, shall not
15 exceed 5 pounds [~~(0.227 kg)~~] (2.27 kg).

16 **[424.7.8] 427.7.8 Toxic material.** The total quantity of solid or liquid toxic material allowed
17 within a laboratory unit, excluding any quantities in a storage room, shall not exceed 250 pounds
18 [~~(946 L)~~] (113.4 kg).

19 **[424.7.9] 427.7.9 Corrosive material.** The total quantity of solid or liquid corrosive material
20 allowed within a laboratory unit, excluding any quantity in a storage room, shall not exceed 250
21 gallons (946 L).

22 **[424.7.10] 427.7.10 [~~Highly toxic and toxic~~] Hazardous gases.** [~~In educational and instructional~~
23 ~~laboratories, the total quantity]~~ The storage, handling and use of hazardous gases, including highly
24 toxic, toxic, corrosive, and [~~toxic~~] asphyxiant gases [~~combined allowed~~], within a laboratory unit
25 [~~, excluding any~~] shall be in accordance the New York City Fire Code, including quantities [~~in a~~
26 storage room, shall not exceed 20 standard cubic feet (0.56 standard cubic m)] permitted and
27 oxygen sensors.

28 **[424.8] 427.8 Storage room classification.** Storage rooms for laboratory chemicals accessory to a
29 laboratory unit shall be classified as Occupancy Group S-1 provided they comply with the provisions
30 of Section [~~424.9~~] 427.9. Storage rooms not in compliance with the provisions of Section [~~424.9~~]
31 427.9 for laboratory chemical quantity limitations shall be classified as a Group H occupancy.

32 **[424.9] 427.9 Storage rooms.** In addition to the quantities allowed within a laboratory unit by
33 Section 427.7, laboratory chemicals that are accessory to a laboratory unit may be stored, whether
34 outside of or entirely within a laboratory unit, in dedicated storage rooms complying with all of the
35 following:

- 36 1. Storage room capacity shall be limited to a maximum of 300 gallons (1136 L) of laboratory
37 chemicals, not to exceed 5 gallons per square foot (0.125 L/m²) of floor area.

- 1 2. Flammable gas storage rooms shall be limited to 2,500 standard cubic feet (71 standard cubic
2 m) of flammable gas.
- 3 3. Storage rooms shall be enclosed by a minimum of 2-hour rated fire barriers.
- 4 4. Storage rooms shall be equipped with a continuously operated ventilation system that
5 provides at least 6 changes of air per hour and vents to the outdoors.
- 6 5. Each entrance to the storage room shall be provided with a minimum 1¹/₂-hour rated self-
7 closing fire door.
- 8 6. Each entrance to the storage room shall be provided with a sill at the doorway, except that no
9 sill shall be required in storage rooms containing only flammable gases.
- 10 7. Storage rooms shall be equipped with an automatic sprinkler system providing at least one
11 sprinkler for each 90 square feet (8.4 m²) or portion thereof.
- 12 8. Laboratory chemicals that are incompatible with each other shall not be stored in the same
13 storage room unless in compliance with the *New York City Fire Code* for separation of
14 incompatible materials.
- 15 9. Storage rooms shall not open directly to an exit or any enclosed exit access component.
- 16 10. The floor of any storage room storing flammable gases shall be located at or above grade.

17 **[424.10] 427.10 Ventilation.** Nonproduction laboratories shall be ventilated in accordance with
18 Section [407] 408 of the *New York City Mechanical Code*.

19 **SECTION BC [425] 428**
20 **USES AND OCCUPANCIES INVOLVING RADIOACTIVE MATERIALS AND**
21 **RADIATION-PRODUCING EQUIPMENT**

22 **[425.1] 428.1 Scope.** This section shall apply to the construction, alteration, and use of buildings or
23 spaces for radioactive materials and radiation-producing equipment.

24 **[425.2] 428.2 City, state and federal regulations.** In addition to the requirements of this section,
25 occupancies involving radioactive materials and radiation-producing equipment shall also comply
26 with applicable requirements of the [city health code] *New York City Health Code*, and applicable
27 state and federal regulations.

28 **[425.3] 428.3 Laboratories.** All laboratories utilizing radioactive materials or radiation-producing
29 equipment required to register under the requirements of the *New York City Health Code* shall
30 comply with the requirements of Sections [425.3.1] 428.3.1 through [425.3.7] 428.3.7.

31 **[425.3.1] 428.3.1 Construction.** All buildings in which such laboratories occur shall be of
32 [Group] Type I or Type II construction.

33 **[425.3.2] 428.3.2 Floors.** All floors shall comply with the fire resistance requirements for the
34 class of construction, and provide the degree of radioactive resistance required by applicable

1 city, state, and federal regulations. A finished material shall be applied to provide a continuous
2 nonporous surface, which may be readily removed.

3 **[425.3.3] 428.3.3 Interior finish.** All insulation of acoustical treatments and interior partitions
4 shall be of noncombustible material. Walls and ceilings shall have nonporous finishes of Class
5 A rating.

6 **[425.3.4] 428.3.4 Sprinkler protection.** Automatic sprinkler protection complying with the
7 construction provisions of Chapter 9 of the *New York City Building Code* shall be provided, and
8 such protection shall be designed for the type of combustible materials wherever such material
9 is used, and for the radioactive material that may be expected to melt, vaporize, or oxidize under
10 fire conditions. Laboratory equipment susceptible to damage from water or other materials used
11 in the sprinkler system may be shielded by hoods except when the equipment provides a source
12 of combustion. Where sprinkler protection uses water, or small water-spray installations are used
13 to fight small isolated fires, floors shall be provided with drainage so that water may be carried
14 to retention tanks for later disposal as required by the *New York City Health Code* when
15 contamination of the water is to be anticipated.

16 **[425.3.5] 428.3.5 Electrical controls.** Electrical controls and equipment shall be installed in
17 accordance with the requirements of the *New York City Electrical Code*.

18 **[425.3.6] 428.3.6 Ventilation.** Exhaust air from areas in which radioactive materials are used or
19 stored shall be exhausted to the outdoors in such manner as not to create a health hazard, and
20 shall not be recirculated to other areas of the building. Air pressure in rooms in which radioactive
21 materials are used or stored shall be maintained below the air pressure of adjoining rooms, so
22 that there is no flow of radioactive gases or dusts into adjoining rooms.

23 **[425.3.6.1] 428.3.6.1 Ducts.** Ducts shall be of sheet steel of not less than No. 16
24 manufacturers' standard gauge or of other equivalent noncombustible material having a
25 melting point above 1800°F (982°C). Exhaust ducts within the building, on the discharge
26 side of the fan, shall be welded airtight. Exhaust ducts within the building, on the suction
27 side of the fan, shall have laps in the direction of airflow with smoke-tight joints, and shall
28 be subjected to a smoke test in accordance with the requirements for chimneys in the *New*
29 *York City Mechanical Code*. Access hatches with tight-closing covers shall be provided for
30 cleaning and for fire-fighting in the exhaust system ducts.

31 **[425.3.6.2] 428.3.6.2 Fume hoods.** Fume hoods shall be exhausted to the outdoors. Controls
32 for hood fans shall be interlocked so that contaminated air cannot be drawn into any space
33 from a hood where the exhaust fan is not in operation.

34 **[425.3.6.3] 428.3.6.3 Fans.** Fan equipment other than the impeller and impeller housing shall
35 be located outside the exhaust stream.

36 **[425.3.6.4] 428.3.6.4 Exhaust.** When the degree of contamination of the exhaust stream
37 exceeds the concentration limits permitted by the health code, the duct system shall be
38 equipped with devices to decontaminate the air to a safe level before discharging to the
39 outdoor air.

1 [425.3.7] **428.3.7 Plumbing.** Drainage lines from sinks used for radioactive wastes shall be
2 without traps, and shall lead to retention tanks when required by the provisions of the *New York*
3 *City Health Code*.

4 [425.4] **428.4 Radiation machines.** Radiation machines or particle accelerators, linear accelerators,
5 cyclotrons, synchrotrons, betatrons, or bevatrons shall be located only in buildings of [Group] Type
6 I or II construction; however, this requirement shall not apply to conventional medical, dental,
7 research, or industrial x-ray machines of less than one million-volt capacity.

8 [425.5] **428.5 Storage.** Radioactive materials shall be stored in sealed containers. When required by
9 the commissioner to avoid too concentrated an exposure within any one space, radioactive materials
10 shall be stored in vaults designed in accordance with the radiation shielding or other requirements
11 for the materials to be stored, and with the requirements of Sections [425.5.1] **428.5.1** through
12 [425.5.3] **428.5.3**.

13 [425.5.1] **428.5.1 Fire protection.** When any materials are subject to melting, vaporization, or
14 oxidation under fire conditions, the storage vaults shall be constructed of walls having a fire-
15 resistance rating of at least 4 hours, and the vaults shall be equipped with automatic sprinklers
16 complying with the construction requirements of Chapter 9 and shall be vented through devices
17 to decontaminate the air to a safe level.

18 [425.5.2] **428.5.2 Doors.** Doors opening into storage vaults shall meet shielding requirements
19 and have a fire-protection rating of not less than 3 hours.

20 [425.5.3] **428.5.3 Bins, shelving, partitions and pallets.** All bins, shelving, partitions, and
21 pallets in storage vaults shall be of noncombustible materials. Other methods of storage permitted
22 by the health department or applicable state and federal regulations, such as storage under water,
23 may be used.

24 § 6. Chapter 5 of the New York city building code, as added by local law number
25 33 for the year 2007, table 503 as amended by local law number 8 for the year 2008, sections
26 501, 502, 503, 504, 505, 506, 507 and 510, as amended by, and sections 508 and 509, as added
27 by, local law number 141 for the year 2013, is amended to read as follows:

28 **CHAPTER 5**
29 **GENERAL BUILDING HEIGHTS AND AREAS;**
30 **SEPARATION OF OCCUPANCIES**

31 **SECTION BC 501**
32 **GENERAL**

33 **501.1 Scope.** The provisions of this chapter control the height and area of structures hereafter erected
34 and additions to existing structures, including separation of occupancies.

1 **501.2 Address identification.** Buildings shall be provided with address numbers or letters in
2 accordance with Section 3-505 of the *Administrative Code* and the rules issued thereunder by the
3 borough president of the borough in which the property is located. Except as otherwise provided by
4 the rules of the borough president in which the property is located, characters shall be a minimum 4
5 inches (102 mm) high and a minimum of 0.5 inch (12.7 mm) wide. They shall be installed on a
6 contrasting background and be plainly visible from the street or road fronting the property. Where
7 access is by means of a private road and the building address cannot be viewed from the public way,
8 an appropriately placed monument, pole or sign or any other means authorized by the borough
9 president of the borough in which the property is located shall be used to identify the structure.

10 **501.3 Fire Department access.** Access shall be provided to the Fire Department in accordance with
11 Sections 501.3.1 and 501.3.2.

12 **501.3.1 Frontage.** Every building, exclusive of accessory buildings, shall have at least 8 percent
13 of the total perimeter of the building adjoining a street or frontage space. For the purposes of this
14 section, building perimeter shall be measured at that story having the maximum enclosed floor
15 area; and buildings provided with a front yard or front setback no deeper than 30 feet (9144 mm)
16 in compliance with the *New York City Zoning Resolution* shall be considered as adjoining the
17 street or frontage space.

18 **501.3.2 Building access.** Provisions shall be made for access by the Fire Department to every
19 building in accordance with [~~Section 903.2.11.1 of this code and Chapter 5 of~~] the *New York City*
20 *Fire Code* and Section 903.2.11.1 of this code. In addition, multiple dwellings shall comply with
21 Section 54 of the *New York State Multiple Dwelling Law*, as applicable.

22 **SECTION BC 502**
23 **DEFINITIONS**

24 **502.1 Definitions.** The following [~~words and~~] terms [~~shall, for the purposes of this chapter and as~~
25 ~~used elsewhere in this code, have the meanings shown herein.~~] are defined in Chapter 2:

26 **AREA, BUILDING.** [~~The area included within surrounding exterior walls (or exterior walls and~~
27 ~~firewalls) exclusive of vent shafts and courts. Areas of the building not provided with surrounding~~
28 ~~walls shall be included in the building area if such areas are included within the horizontal projection~~
29 ~~of the roof or floor above.]~~

30 **BASEMENT.** [~~A story partly below the grade plane and having less than one-half its clear height~~
31 ~~(measured from finished floor to finished ceiling) below the grade plane (see “Story” in Section 202~~
32 ~~and “Story above grade plane” in this section). A basement shall be considered a story above grade~~
33 ~~plane.]~~

34 **CELLAR.** [~~That portion of a building that is partly or wholly underground, and having one-half or~~
35 ~~more of its clear height (measured from finished floor to finished ceiling) below the grade plane.~~
36 ~~Cellars shall not be counted as stories in measuring the height of the buildings.]~~

37 **COMBINED HEAT AND POWER SYSTEMS.** [~~Equipment that simultaneously produces~~
38 ~~electricity and heat from a single fuel source.]~~

1 **EQUIPMENT PLATFORM.** [~~An unoccupied, elevated platform used exclusively for mechanical~~
2 ~~systems or industrial process equipment, including the associated elevated walkways, stairs,~~
3 ~~alternating tread devices and ladders necessary to access the platform (see Section 505.5).]~~

4 **FIRE LANE.**

5 **FRONTAGE SPACE.** [~~A street or an open space adjoining a building not less than 30 feet (9144~~
6 ~~mm) in any dimension. Such open space shall be accessible from a street by a driveway, lane, private~~
7 ~~road or alley at least 20 feet (6096 mm) in width. Such open space including accessways shall be~~
8 ~~permanently maintained free of all obstructions that might interfere with its use by the Fire~~
9 ~~Department.]~~

10 **GRADE PLANE.** [~~A reference plane representing the level of the curb as established by the city~~
11 ~~engineer in the Borough President's office, measured at the center of the front of a building. Where~~
12 ~~a building faces on more than one street, the grade plane shall be the average of the levels of the~~
13 ~~curbs at the center of each front.]~~

14 [~~**Exception:** The grade plane shall not be referenced to the level of the curb, but shall be~~
15 ~~considered the average elevation of the final grade adjoining all exterior walls of a building,~~
16 ~~calculated from final grade elevations taken at intervals of 10 feet (3048 mm) around the~~
17 ~~perimeter of the building where:]~~

18 [~~1. No curb elevation has been legally established on the city map; or]~~

19 [~~2. Every part of the building is setback more than 25 feet (7620 mm) from a street line.]~~

20 **HEIGHT, BUILDING.** [~~The vertical distance from the grade plane to the average height of the~~
21 ~~highest roof surfaces.]~~

22 **MEZZANINE.** [~~An intermediate level or levels between the floor and ceiling of any story in~~
23 ~~accordance with Section 505.]~~

24 **STORY.**

25 **STORY ABOVE GRADE PLANE.** [~~Any story having its finished floor surface entirely above~~
26 ~~grade plane, except that a basement shall also be considered a story above grade plane (also see~~
27 ~~definitions of "Story" in Section BC 202 and "Basement" in this section).]~~

28 **SECTION BC 503**
29 **GENERAL BUILDING HEIGHT AND**
30 **AREA LIMITATIONS**

31 **503.1 General.** [~~The building height and] Unless otherwise specifically modified in Chapter 4,~~
32 ~~building height, number of stories and building area shall not exceed the limits specified in [Table~~
33 ~~503] Sections 504 and 506, based on the type of construction as determined by Section 602, and the~~
34 ~~occupancies as determined by Section 302, except as modified hereafter in this chapter. Building~~
35 ~~height, number of stories and building area provisions shall be applied independently. Each portion~~
36 ~~of a building separated by one or more fire walls complying with Section 706 shall be considered to~~
37 ~~be a separate building.~~

[TABLE 503

ALLOWABLE BUILDING HEIGHTS AND AREAS^a

Building height limitations shown in feet above grade plane. Story limitations shown as stories above grade plane.
 Building area limitations shown in square feet, as determined by the definition of "Area, building," per story.

GROUP	HEIGHT (feet) HEIGHT (S)	TYPE OF CONSTRUCTION								
		TYPE I		TYPE II		TYPE III		TYPE IV	TYPE V	
		A	B	A	B	A	B	HT	A	B
		UL	160°	65	55	65	55	65	50	40
A-1	S	UL	UL	6	3	6	3	6	3	2
	A	UL	UL	17,500	10,500	14,700	5,600	15,000	8,400	5,500
A-2	S	UL	UL	6	3	6	3	6	3	2
	A	UL	UL	17,500	9,500	14,000	5,600	15,000	8,400	5,500
A-3	S	UL	UL	6	3	6	3	6	3	2
	A	UL	UL	17,500	9,500	14,000	5,600	15,000	8,400	5,500
A-4	S	UL	UL	6	3	6	3	6	3	2
	A	UL	UL	17,500	9,500	14,000	5,600	15,000	8,400	5,500
A-5	S	UL	UL	UL	UL	UL	UL	6	UL	UL
	A	UL	UL	UL	UL	UL	UL	UL	UL	UL
B	S	UL	UL	6	3	6	3	6	3	2
	A	UL	UL	37,500	10,500	28,500	5,600	36,000	8,400	5,500
E	S	UL	UL	4	3	4	3	6	3	2
	A	UL	UL	26,000	10,500	23,500	5,600	25,500	8,400	5,500
F-1	S	UL	6	5	3	5	2	5	3	2
	A	UL	UL	12,500	7,500	7,500	3,000	10,000	3,000	1,000
F-2	S	UL	UL	6	3	6	3	6	3	2
	A	UL	UL	37,500	10,500	28,500	5,600	30,000	8,400	5,500
H-1	S	1	1	1	1	1	1	1	1	NP
	A	21,000	16,500	11,000	7,500	9,500	7,000	10,500	7,500	NP
H-2 ^d	S	UL	3	2	1	2	1	2	1	1
	A	21,000	16,500	11,000	7,500	9,500	7,000	10,500	7,500	3,000
H-3 ^d	S	UL	6	4	2	4	2	4	2	1
	A	UL	60,000	26,500	14,000	17,500	13,000	25,000	10,000	5,000
H-4	S	UL	7	5	3	5	3	5	3	2
	A	UL	UL	37,500	17,500	28,500	17,500	36,000	18,000	6,500
H-5	S	3	3	3	3	3	3	3	3	2
	A	UL	UL	37,500	23,000	28,500	19,000	36,000	18,000	9,000
I-1	S	UL	UL	6	NP	4	3	4	NP	NP
	A	UL	UL	19,000	NP	16,500	5,600	18,000	NP	NP
I-2	S	UL	6	4	4	5	3	5	3	NP
	A	UL	UL	7,000	3,500	5,000	1,200	6,500	2,000	NP
I-3	S	UL	4	4	3	4	2	4	3	NP
	A	UL	UL	7,000	3,500	5,000	1,200	6,500	2,000	NP
I-4	S	UL	UL	3	3	3	3	3	2	2
	A	UL	UL	26,500	9,500	23,500	5,600	25,500	8,400	5,500
M	S	UL	UL	6	3	6	3	6	3	2
	A	UL	UL	21,500	7,500	18,500	5,600	14,000	8,400	5,500
R-1	S	UL	UL	6	NP	6	NP	6	NP	NP
	A	UL	UL	UL	NP	24,000	NP	20,500	NP	NP

**[TABLE 503
ALLOWABLE BUILDING HEIGHTS AND AREAS^a**

**Building height limitations shown in feet above grade plane. Story limitations shown as stories above grade plane.
Building area limitations shown in square feet, as determined by the definition of "Area, building," per story.**

GROUP	HEIGHT (feet) HEIGHT (S)	TYPE OF CONSTRUCTION								
		TYPE I		TYPE II		TYPE III		TYPE IV	TYPE V	
		A	B	A	B	A	B	HT	A	B
		UL	160 ^e	65	55	65	55	65	50	40
R-2	S	UL	UL	6	NP	6	3	6	NP	NP
	A	UL	UL	UL	NP	24,000	5,600	20,500	NP	NP
R-3	S	UL	UL	6	3	6	3	6	3	3
	A	UL	UL	17,500	10,500	14,700	5,600	30,000	8,400	5,500
S-1	S	UL	6	5	3	4	3	4	3	2
	A	UL	48,000	12,000	7,500	7,500	7,500	7,500	5,000	1,000
S-2 ^{h,e}	S	UL	UL	6	3	6	4	6	3	2
	A	UL	UL	15,000	10,000	10,000	8,500	10,000	8,400	5,500
U ^e	S	UL	5	4	2	3	2	4	2	1
	A	UL	35,000	19,000	8,500	14,000	8,500	18,000	9,000	5,500

Not permitted in Fire District.

Not permitted in Fire District without sprinklers.

- For SI: 1 foot = 304.8 mm, 1 square foot = 0.0929 m².
A = building area per story, S = stories above grade plane,
UL = Unlimited, NP = Not permitted.
- a. See the following sections for general exceptions to Table 503:
 1. Section 504.2, Allowable height increase due to automatic sprinkler system installation.
 2. Section 506.2, Allowable area increase due to frontage.
 3. Section 506.3, Allowable area increase due to automatic sprinkler system installation.
 4. Section 507, Unlimited area building.
 - b. For open parking structures, see Section 406.3.
 - c. For private garages, see Section 406.1.
 - d. See Section 415.5 for limitations.
 - e. Except for Occupancy Groups F-1, H-1 through H-5, I-2, I-3, S-1 and U, buildings equipped throughout with an approved automatic sprinkler system in accordance with Section 903.3.1.1 shall be unlimited in height.

1
2
3
4
5
6
7
8
9
10
11
12
13
14

503.1.1 Special industrial occupancies. Buildings and structures of Type I and II construction designed to house special industrial processes that require large areas and unusual building heights to accommodate craneways or special machinery and equipment, including, among others, rolling mills; structural metal fabrication shops and foundries; or the production and distribution of electric, gas or steam power, shall be exempt from the building height, number of stories and building area limitations [of Table 503.] specified in Sections 504 and 506. Mezzanines within such buildings or structures shall comply with Section 505.2. Documents and plans describing the special industrial processes shall be submitted to the commissioner for approval.

503.1.2 Buildings on the same tax lot. Two or more buildings on the same tax lot and under the same ownership and control shall be regulated as separate buildings, or, at the option of the owner, shall be considered as portions of one building [if] where the building height, number of stories of each building and the aggregate building area of the combined buildings are within the limitations [of Table 503 as modified by] specified in Sections 504 and 506. The provisions of this code applicable to the aggregate building shall be applicable to each building.

503.1.3 Type I construction. Buildings of Type I construction permitted to be of unlimited tabular building heights and areas [in accordance with Table 503] are not [required] subject to

1 [comply with] the special requirements that allow unlimited area buildings in Section 507 or
2 unlimited building height in Sections 503.1.1 and 504.3 or increased building heights and areas
3 for other types of construction.

4 ~~[503.2 Reserved.]~~

5 **SECTION BC 504**
6 **BUILDING HEIGHT [MODIFICATIONS] AND NUMBER OF STORIES**

7 **504.1 General.** ~~[The heights permitted by Table 503 shall only be increased in accordance with this~~
8 ~~section.]~~ The height, in feet, and the number of stories of a building shall be determined based on the
9 type of construction, occupancy classification and whether there is an automatic sprinkler system
10 installed throughout the building.

11 **Exception:** The building height of one-story aircraft hangars, aircraft paint hangars and buildings
12 used for the manufacturing of aircraft shall not be limited ~~[if]~~ where the building is provided with
13 an automatic sprinkler system or automatic fire-extinguishing system in accordance with Chapter
14 9 and is entirely surrounded by public ways or yards not less in width than one and one-half times
15 the building height.

16 ~~**504.2 Automatic sprinkler system increase.** Where a building is equipped throughout with an~~
17 ~~approved automatic sprinkler system in accordance with Section 903.3.1.1, the value specified in~~
18 ~~Table 503 for maximum building height is increased by 20 feet (6096 mm) and the maximum number~~
19 ~~of stories is increased by one story. These increases are permitted in addition to the building area~~
20 ~~increase in accordance with Sections 506.2 and 506.3. For Group R buildings equipped throughout~~
21 ~~with an approved automatic sprinkler system in accordance with Section 903.3.1.2, the value~~
22 ~~specified in Table 503 for maximum building height is increased by 20 feet (6096 mm) and the~~
23 ~~maximum number of stories is increased by one story, but shall not exceed 60 feet (18 288 mm) or~~
24 ~~six stories, respectively.]~~

25 **[Exceptions:]**

26 [1. ~~Buildings, or portions of buildings, classified as a Group I-2 occupancy of Type II-B, III,~~
27 ~~IV or V construction.]~~

28 [2. ~~Buildings, or portions of buildings, classified as a Group H-1, H-2, H-3 or H-5~~
29 ~~occupancy.]~~

30 [3. ~~Fire-resistance rating substitution in accordance with Table 601, Note d.]~~

31 **504.1.1 Unlimited area buildings.** The height of unlimited area buildings shall be designed in
32 accordance with Section 507.

33 **504.1.2 Special provisions.** The special provisions of Section 510 permit the use of special
34 conditions that are exempt from, or modify, the specific requirements of this chapter regarding
35 the allowable heights of buildings based on the occupancy classification and type of construction,
36 provided the special condition complies with the provisions specified in Section 510.

1 **504.2 Mixed occupancy.** In a building containing mixed occupancies in accordance with Section
2 508, no individual occupancy shall exceed the height and number of story limits specified in Section
3 504 for the applicable occupancies.

4 **504.3 [~~Rooftop structures.~~] Height in feet and number of stories.** The maximum height, in feet, of
5 a building shall not exceed the limits specified in Table 504.3. The maximum number of stories of a
6 building shall not exceed the limits specified in Table 504.4.

7 **Exceptions:**

8 1. Rooftop structures including but not limited to roof tanks and their supports, ventilating,
9 air conditioning, combined heat and power systems and similar building service
10 equipment, bulkheads, penthouses, greenhouses, chimneys, and parapet walls 4 feet
11 (1219 mm) or less in height shall not be included in the building height of the building or
12 considered an additional story unless the aggregate area of all such structures, exclusive
13 of any solar thermal and solar (photovoltaic) collectors and/or panels and their supporting
14 equipment, exceeds $33\frac{1}{3}$ percent of the area of the roof of the building upon which they
15 are erected. Rooftop structures shall be constructed in accordance with Section [~~4509~~]
16 1510.

17 2. [~~Exception:~~] Solar thermal and solar electric (photovoltaic) collectors and/or panels and
18 their supporting equipment that exceed $33\frac{1}{3}$ percent of the area of the roof of the building
19 upon which they are erected shall not be included in the height of a building or considered
20 an additional story.

21 3. Noncombustible steeples, minarets, spires, domes, cupolas and other similar architectural
22 elements, not used for occupancy or storage, shall not be included in the building height
23 of the building or considered an extra story, and may be unlimited in height.

24

TABLE 504.3^A
ALLOWABLE BUILDING HEIGHT IN FEET ABOVE GRADE PLANE

<u>OCCUPANCY CLASSIFICATION</u>	<u>TYPE OF CONSTRUCTION</u>									
	<u>SEE FOOTNOT ES</u>	<u>TYPE I</u>		<u>TYPE II</u>		<u>TYPE III</u>		<u>TYPE IV^j</u>	<u>TYPE V</u>	
		<u>A</u>	<u>Bⁱ</u>	<u>A</u>	<u>B</u>	<u>A</u>	<u>B</u>	<u>HT</u>	<u>A</u>	<u>B</u>
A-1	NS ^{b,c}	UL	160	65	55	65	55	65	50	40
	S	UL	420	85	75	85	75	85	70	60
A-2	NS ^{b,c}	UL	160	65	55	65	55	65	50	40
	S	UL	420	85	75	85	75	85	70	60
A-3	NS ^{b,c}	UL	160	65	55	65	55	65	50	40
	S	UL	420	85	75	85	75	85	70	60
A-4	NS ^{b,c}	UL	160	65	55	65	55	65	50	40
	S	UL	420	85	75	85	75	85	70	60
A-5	NS ^{b,c}	UL	160	65	55	65	55	65	50	40
	S	UL	420	85	75	85	75	85	70	60
B	NS ^{b,c}	UL	160	65	55	65	55	65	50	40
	S	UL	420	85	75	85	75	85	70	60
E	NS ^{b,c}	UL	160	65	55	65	55	65	50	40
	S	UL	420	85	75	85	75	85	70	60
F-1	NS ^{b,c}	UL	160	65	55	65	55	65	50	40
	S	UL	180	85	75	85	75	85	70	60
F-2	NS ^{b,c}	UL	160	65	55	65	55	65	50	40
	S	UL	420	85	75	85	75	85	70	60
H-1	S	UL	160	65	55	65	55	65	50	NP
H-2 ^f	S	UL	160	65	55	65	55	65	50	40
H-3 ^f	S	UL	160	65	55	65	55	65	50	40
H-4	S	UL	180	85	75	85	75	85	70	60
H-5	S	UL	160	65	55	65	55	65	50	40
I-1	S13D	60	60	60	NP	60	55	60	NP	NP
	S13R					85	75	85	NP	NP
	S					UL	420	85		
I-2	S	UL	180	85	55	65	55	65	50	NP
I-3	S	UL	180	85	75	85	75	85	70	NP
I-4	NS ^{b,c}	UL	160	65	55	65	55	65	50	40
	S	UL	420	85	75	85	75	85	70	60
M	NS ^{b,c}	UL	160	65	55	65	55	65	50	40
	S	UL	420	85	75	85	75	85	70	60
R-1	S13R	60	60	60	NP	60	NP	60	NP	NP
	S	UL	420	85		85		85		
R-2	S13R	60	60	60	NP	60	60	60	NP	NP
	S	UL	420	85		85	75	85		
R-3	NS ^{b,c}	UL	160	65	55	65	55	65	50 ^{g,h}	40 ^e
	S13D	60	60	60	60	60	55	60		

TABLE 504.3^A
ALLOWABLE BUILDING HEIGHT IN FEET ABOVE GRADE PLANE

OCCUPANCY CLASSIFICATION	TYPE OF CONSTRUCTION									
	SEE FOOTNOT ES	TYPE I		TYPE II		TYPE III		TYPE IV ^j	TYPE V	
		A	B ⁱ	A	B	A	B	HT	A	B
	S13R						60		60 ^{g,h}	60 ^g
	S	UL	420	85	75	85	75	85	70 ^{g,h}	
S-1	NS ^{b,c}	UL	160	65	55	65	55	65	50	40
	S	UL	180	85	75	85	75	85	70	60
S-2 ^{d,e}	NS ^{b,c}	UL	160	65	55	65	55	65	50	40
	S	UL	420	85	75	85	75	85	70	60
U ^e	NS ^{b,c}	UL	160	65	55	65	55	65	50	40
	S	UL	180	85	75	85	75	85	70	60



= Not permitted in Fire District



= Not permitted in Fire District without sprinklers

1
2
3

For SI: 1 foot = 304.8 mm.

- 4 **Note:** UL = Unlimited; NP = Not permitted; NS = Buildings not equipped throughout with an automatic sprinkler system; S =
5 Buildings equipped throughout with an automatic sprinkler system installed in accordance with Section 903.3.1.1; S13R =
6 Buildings equipped throughout with an automatic sprinkler system installed in accordance with Section 903.3.1.2; S13D =
7 Buildings equipped throughout with an automatic sprinkler system installed in accordance with Section 903.3.1.3.
- 8 a. See the following sections for general exceptions to Table 504.3:
9 1. See Chapters 4 and 5 for specific exceptions to the allowable height in this chapter.
10 2. Section 506.3, Allowable area increase due to frontage.
11 3. Section 507, Unlimited area building.
- 12 b. See Section 903.2 for the minimum thresholds for protection by an automatic sprinkler system for specific occupancies.
- 13 c. The NS value is only for use in buildings not required by this code to be equipped throughout with an automatic sprinkler
14 system.
- 15 d. For open parking structures, see Section 406.5.
- 16 e. For private garages, see Section 406.3.
- 17 f. See Section 415.8 for limitations.
- 18 g. See Exception 9 of Section D105.1 for allowances of Type VA and VB construction for R-3 occupancies.
- 19 h. See Exception 12 of Section D105.1 for allowances of Type VA construction and height limitations for R-3 occupancies in
20 Lower Density Growth Management Areas.
- 21 i. See Section 403.2.1 for additional requirements for high-rise buildings.
- 22 j. Type IV construction utilizing cross-laminated timber or structural composite lumber shall be sprinklered where required by
23 Section 903.2.13.
- 24
- 25 **504.4 Number of stories.** The maximum number of stories of a building shall not exceed the limits
26 specified in Table 504.4.

27

TABLE 504.4^{A,B}
ALLOWABLE NUMBER OF STORIES ABOVE GRADE PLANE

<u>OCCUPANCY CLASSIFICATION</u>	<u>TYPE OF CONSTRUCTION</u>									
	<u>SEE FOOTNOTES</u>	<u>TYPE I</u>		<u>TYPE II</u>		<u>TYPE III</u>		<u>TYPE IVⁱ</u>	<u>TYPE V</u>	
		<u>A</u>	<u>B</u>	<u>A</u>	<u>B</u>	<u>A</u>	<u>B</u>	<u>HT</u>	<u>A</u>	<u>B</u>
<u>A-1</u>	<u>NS^{b,c}</u>	<u>UL</u>	<u>UL</u>	<u>6</u>	<u>3</u>	<u>6</u>	<u>3</u>	<u>6</u>	<u>3</u>	<u>2</u>
	<u>S</u>	<u>UL</u>	<u>UL</u>	<u>7</u>	<u>4</u>	<u>7</u>	<u>4</u>	<u>7</u>	<u>4</u>	<u>3</u>
<u>A-2</u>	<u>NS^{b,c}</u>	<u>UL</u>	<u>UL</u>	<u>6</u>	<u>3</u>	<u>6</u>	<u>3</u>	<u>6</u>	<u>3</u>	<u>2</u>
	<u>S</u>	<u>UL</u>	<u>UL</u>	<u>7</u>	<u>4</u>	<u>7</u>	<u>4</u>	<u>7</u>	<u>4</u>	<u>3</u>
<u>A-3</u>	<u>NS^{b,c}</u>	<u>UL</u>	<u>UL</u>	<u>6</u>	<u>3</u>	<u>6</u>	<u>3</u>	<u>6</u>	<u>3</u>	<u>2</u>
	<u>S</u>	<u>UL</u>	<u>UL</u>	<u>7</u>	<u>4</u>	<u>7</u>	<u>4</u>	<u>7</u>	<u>4</u>	<u>3</u>
<u>A-4</u>	<u>NS^{b,c}</u>	<u>UL</u>	<u>UL</u>	<u>6</u>	<u>3</u>	<u>6</u>	<u>3</u>	<u>6</u>	<u>3</u>	<u>2</u>
	<u>S</u>	<u>UL</u>	<u>UL</u>	<u>7</u>	<u>4</u>	<u>7</u>	<u>4</u>	<u>7</u>	<u>4</u>	<u>3</u>
<u>A-5</u>	<u>NS^{b,c}</u>	<u>UL</u>	<u>UL</u>	<u>UL</u>	<u>UL</u>	<u>UL</u>	<u>UL</u>	<u>6</u>	<u>UL</u>	<u>UL</u>
	<u>S</u>	<u>UL</u>	<u>UL</u>	<u>UL</u>	<u>UL</u>	<u>UL</u>	<u>UL</u>	<u>7</u>	<u>UL</u>	<u>UL</u>
<u>B</u>	<u>NS^{b,c}</u>	<u>UL</u>	<u>UL</u>	<u>6</u>	<u>3</u>	<u>6</u>	<u>3</u>	<u>6</u>	<u>3</u>	<u>2</u>
	<u>S</u>	<u>UL</u>	<u>UL</u>	<u>7</u>	<u>4</u>	<u>7</u>	<u>4</u>	<u>7</u>	<u>4</u>	<u>3</u>
<u>E</u>	<u>NS^{b,c}</u>	<u>UL</u>	<u>UL</u>	<u>4</u>	<u>3</u>	<u>4</u>	<u>3</u>	<u>6</u>	<u>3</u>	<u>2</u>
	<u>S</u>	<u>UL</u>	<u>UL</u>	<u>5</u>	<u>4</u>	<u>5</u>	<u>4</u>	<u>7</u>	<u>4</u>	<u>3</u>
<u>F-1</u>	<u>NS^{b,c}</u>	<u>UL</u>	<u>6</u>	<u>5</u>	<u>3</u>	<u>5</u>	<u>2</u>	<u>5</u>	<u>3</u>	<u>2</u>
	<u>S</u>	<u>UL</u>	<u>7</u>	<u>6</u>	<u>4</u>	<u>6</u>	<u>3</u>	<u>6</u>	<u>4</u>	<u>3</u>
<u>F-2</u>	<u>NS^{b,c}</u>	<u>UL</u>	<u>UL</u>	<u>6</u>	<u>3</u>	<u>6</u>	<u>3</u>	<u>6</u>	<u>3</u>	<u>2</u>
	<u>S</u>	<u>UL</u>	<u>UL</u>	<u>7</u>	<u>4</u>	<u>7</u>	<u>4</u>	<u>7</u>	<u>4</u>	<u>3</u>
<u>H-1</u>	<u>S</u>	<u>1</u>	<u>1</u>	<u>1</u>	<u>1</u>	<u>1</u>	<u>1</u>	<u>1</u>	<u>1</u>	<u>NP</u>
<u>H-2^f</u>	<u>S</u>	<u>UL</u>	<u>3</u>	<u>2</u>	<u>1</u>	<u>2</u>	<u>1</u>	<u>2</u>	<u>1</u>	<u>1</u>
<u>H-3^f</u>	<u>S</u>	<u>UL</u>	<u>6</u>	<u>4</u>	<u>2</u>	<u>4</u>	<u>2</u>	<u>4</u>	<u>2</u>	<u>1</u>
<u>H-4</u>	<u>S</u>	<u>UL</u>	<u>8</u>	<u>6</u>	<u>4</u>	<u>6</u>	<u>4</u>	<u>6</u>	<u>4</u>	<u>3</u>
<u>H-5</u>	<u>S</u>	<u>3</u>	<u>3</u>	<u>3</u>	<u>3</u>	<u>3</u>	<u>3</u>	<u>3</u>	<u>3</u>	<u>2</u>
<u>I-1</u>	<u>S13D</u>	<u>6</u>	<u>6</u>	<u>6</u>	<u>NP</u>	<u>4</u>	<u>3</u>	<u>4</u>	<u>NP</u>	<u>NP</u>
	<u>S13R</u>	<u>UL</u>	<u>UL</u>			<u>5</u>	<u>4</u>	<u>5</u>		
	<u>S</u>	<u>UL</u>	<u>UL</u>	<u>7</u>	<u>NP</u>					
<u>I-2</u>	<u>S</u>	<u>UL</u>	<u>7</u>	<u>5</u>	<u>4</u>	<u>5</u>	<u>3</u>	<u>5</u>	<u>3</u>	<u>NP</u>
<u>I-3</u>	<u>S</u>	<u>UL</u>	<u>5</u>	<u>5</u>	<u>4</u>	<u>5</u>	<u>3</u>	<u>5</u>	<u>4</u>	<u>NP</u>
<u>I-4</u>	<u>NS^{b,c}</u>	<u>UL</u>	<u>UL</u>	<u>3</u>	<u>3</u>	<u>3</u>	<u>3</u>	<u>3</u>	<u>2</u>	<u>2</u>
	<u>S</u>	<u>UL</u>	<u>UL</u>	<u>4</u>	<u>4</u>	<u>4</u>	<u>4</u>	<u>4</u>	<u>3</u>	<u>3</u>
<u>M</u>	<u>NS^{b,c}</u>	<u>UL</u>	<u>UL</u>	<u>6</u>	<u>3</u>	<u>6</u>	<u>3</u>	<u>6</u>	<u>3</u>	<u>2</u>
	<u>S</u>	<u>UL</u>	<u>UL</u>	<u>7</u>	<u>4</u>	<u>7</u>	<u>4</u>	<u>7</u>	<u>4</u>	<u>3</u>
<u>R-1</u>	<u>S13R</u>	<u>6</u>	<u>6</u>	<u>6</u>	<u>NP</u>	<u>6</u>	<u>NP</u>	<u>6</u>	<u>NP</u>	<u>NP</u>
	<u>S</u>	<u>UL</u>	<u>UL</u>	<u>7</u>	<u>NP</u>	<u>7</u>	<u>NP</u>	<u>7</u>	<u>NP</u>	<u>NP</u>
<u>R-2</u>	<u>S13R</u>	<u>6</u>	<u>6</u>	<u>6</u>	<u>NP</u>	<u>6</u>	<u>4</u>	<u>6</u>	<u>NP</u>	<u>NP</u>
	<u>S</u>	<u>UL</u>	<u>UL</u>	<u>7</u>	<u>NP</u>	<u>7</u>		<u>7</u>	<u>NP</u>	<u>NP</u>
<u>R-3</u>	<u>NS^{b,c}</u>	 	 	 	 	 	 	 	<u>3^{g,h}</u>	<u>3^g</u>
	<u>S13D</u>	<u>6</u>	<u>6</u>	<u>6</u>	<u>3</u>	<u>6</u>	<u>3</u>	<u>6</u>		

TABLE 504.4^{A,B}
ALLOWABLE NUMBER OF STORIES ABOVE GRADE PLANE

OCCUPANCY CLASSIFICATION	TYPE OF CONSTRUCTION									
	SEE FOOTNOTES	TYPE I		TYPE II		TYPE III		TYPE IVⁱ	TYPE V	
		A	B	A	B	A	B	HT	A	B
	S13R									
	S	UL	UL	7	4	7	4	7	4 ^{g,h}	4 ^g
S-1	NS ^{b,c}	UL	6	5	3	4	3	4	3	2
	S	UL	7	6	4	5	4	5	4	3
S-2 ^{d,e}	NS ^{b,c}	UL	UL	6	3	6	4	6	3	2
	S	UL	UL	7	4	7	5	7	4	3
U ^e	NS ^{b,c}	UL	5	4	2	3	2	4	2	1
	S	UL	6	5	3	4	3	5	3	2



= Not permitted in Fire District



= Not permitted in Fire District without sprinklers



= Number of stories in nonsprinklered 1- & 2-family buildings shall be limited by Section 903.2.8

Note: UL = Unlimited; NP = Not Permitted; NS = Buildings not equipped throughout with an automatic sprinkler system; S = Buildings equipped throughout with an automatic sprinkler system installed in accordance with Section 903.3.1.1; S13R = Buildings equipped throughout with an automatic sprinkler system installed in accordance with Section 903.3.1.2; S13D = Buildings equipped throughout with an automatic sprinkler system installed in accordance with Section 903.3.1.3.

a. See the following sections for general exceptions to Table 504.4.

1. See Chapters 4 and 5 for specific exceptions to the allowable height in this chapter.
2. Section 506.3, Allowable area increase due to frontage.
3. Section 507, Unlimited area building.

b. See Section 903.2 for the minimum thresholds for protection by an automatic sprinkler system for specific occupancies.

c. The NS value is only for use in buildings not required by this code to be equipped throughout with an automatic sprinkler system.

d. For open parking structures, see Section 406.5.

e. For private garages, see Section 406.3.

f. See Section 415.8 for limitations.

g. See Exception 9 of Section D105.1 for allowances of Type VA and VB construction for R-3 occupancies.

h. See Exception 12 of Section D105.1 for allowances of Type VA construction and height limitations for R-3 occupancies in Lower Density Growth Management Areas.

i. Type IV construction utilizing cross-laminated timber or structural composite lumber shall be sprinklered where required by Section 903.2.13.

SECTION BC 505 MEZZANINES AND EQUIPMENT PLATFORMS

505.1 General. Mezzanines shall comply with Section 505.2. Equipment platforms shall comply with Section 505.3.

505.2 Mezzanines. A mezzanine or mezzanines in compliance with Section [505] 505.2 shall be considered a portion of the story [in which it is contained] below. Such mezzanines shall not contribute to either the building area or number of stories as regulated by Section 503.1. The area of the mezzanine shall be included in determining the fire area [defined in Section 902]. The clear height above and below the mezzanine floor construction shall be not [be] less than 7 feet (2134 mm).

1 **Exception:** The clear height of habitable spaces above or below mezzanines within dwelling
2 units shall be not [be] less than 8 feet (2438 mm).

3 ~~[505.2]~~ **505.2.1 Area limitation.** The aggregate area of a mezzanine or mezzanines within a room
4 or space shall be not [exceed] greater than one-third of the floor area of that room or space in
5 which they are located. The enclosed portions of a room or space shall not be included in
6 determining the permissible floor area of the mezzanine. In determining the allowable mezzanine
7 area, the area of the mezzanine shall not be included in the floor area of the room in which it is
8 contained.

9 Where a room contains both a mezzanine and an equipment platform, the aggregate area of
10 the two raised floor levels shall be not greater than two-thirds of the floor area of that room or
11 space in which they are located.

12 **Exceptions:**

- 13 1. The aggregate area of mezzanines in buildings and structures of Type I or II
14 construction for special industrial occupancies in accordance with Section 503.1.1
15 shall be not [exceed] greater than two-thirds of the area of the room in which the
16 mezzanines are located.
- 17 2. The aggregate area of a mezzanine or mezzanines within a dwelling unit shall not
18 exceed one-third of the net floor area of such dwelling unit, whether or not portions
19 of such dwelling unit are enclosed. The area of the mezzanine shall not contribute to
20 the determination of the floor area of the dwelling unit in which it is contained.

21 ~~[505.3 Egress]~~ **505.2.2 Means of egress.** Each occupant of a mezzanine shall have access to at
22 least two independent means of egress where the common path of egress travel exceeds the
23 limitations of Section ~~[1014.3]~~ 1006.2. Where a stairway provides a means of exit access from
24 a mezzanine, the maximum travel distance includes the distance traveled on the stairway
25 measured in the plane of the tread nosing. Accessible means of egress shall be provided in
26 accordance with Section ~~[1007]~~ 1009.

27 **Exception:** A single means of egress shall be permitted in accordance with Section ~~[1015.1]~~
28 1006.2.

29 ~~[505.4]~~ **505.2.3 Openness.** A mezzanine shall be open and unobstructed to the room in which
30 such mezzanine is located except for walls or railings not more than 42 inches (1067 mm) ~~[high]~~
31 in height, columns and posts.

32 **Exceptions:**

- 33 1. Mezzanines or portions thereof are not required to be open to the room in which the
34 mezzanines are located, provided that the occupant load of the aggregate area of the
35 enclosed space ~~[does]~~ is not [exceed] greater than 10.

2. A mezzanine having two or more means of egress is not required to be open to the room in which the mezzanine is located, if at least one of the means of egress provides direct access to an exit ~~[from]~~ located on the mezzanine level.
3. Mezzanines or portions thereof are not required to be open to the room in which the mezzanines are located, provided that the aggregate floor area of the enclosed space ~~[does]~~ Is not [exceed] greater than 10 percent of the mezzanine area.
4. In industrial facilities, mezzanines used for control equipment are permitted to be glazed on all sides.
5. A mezzanine having two or more means of egress shall not be required to be open to the room in which the mezzanine is located in occupancies, other than Groups H and I, that comply with ~~[items]~~ Items 5.1 through 5.4.
 - 5.1. Such occupancy is no more than two stories above grade plane,
 - 5.2. Such occupancy is equipped throughout with an automatic sprinkler system in accordance with Section 903.3.1.1,
 - 5.3. An approved fire alarm system is installed throughout the entire building or structure in which such occupancy is located, and
 - 5.4. Notification appliances are installed throughout the mezzanine in accordance with NFPA 72.

[505.5] 505.3 Equipment platforms. Equipment platforms in buildings shall not be considered as a portion of the floor below. Such equipment platforms shall not contribute to either the building area or the number of stories as regulated by Section 503.1. The area of the equipment platform shall not be included in determining the fire area in accordance with Section 903. Equipment platforms shall not be a part of any mezzanine~~;~~ and such platforms and the walkways, ~~[stairs]~~ stairways, alternating tread devices and ladders providing access to an equipment platform shall not serve as a part of the means of egress from the building.

[505.5.1] 505.3.1 Area ~~[limitations]~~ limitation. The aggregate area of all industrial equipment platforms within a room shall be not [exceed] greater than two-thirds of the area of the room in which they occur. Where an equipment platform is located in the same room as a mezzanine, the area of the mezzanine shall be determined by Section ~~[505.2]~~ 505.2.1 and the combined aggregate area of the equipment platforms and mezzanines shall be not [exceed] greater than two-thirds of the room in which they are located.

[505.5.2] 505.3.2 Fire suppression. Where located in a building that is required to be protected by an automatic sprinkler system, industrial equipment platforms shall be fully protected by sprinklers above and below the platform, where required by the standards referenced in Section 903.3.

[505.5.3] 505.3.3 Guards. Equipment platforms shall have guards where required by Section ~~[1013.1]~~ 1015.2.

1 SECTION BC 506
2 BUILDING AREA MODIFICATIONS

3 **506.1 General.** The floor area of a building [areas limited by Table 503] shall be [permitted to be
4 increased due to frontage (I_f) and] determined based on the type of construction, occupancy
5 classification, whether there is an automatic sprinkler system [protection (I_s) in accordance with]
6 installed throughout the [following:] building and the amount of building frontage on public way or
7 open space.

8
$$[A_a = [A_f + (A_f \times I_f) + (A_f \times I_s)]]$$

9 [(Equation 5-1)]

10 [where:]

11 [A_a = Allowable building area per story (square feet).]

12 [A_f = Tabular building area per story in accordance with Table 503 (square feet).]

13 [I_f = Area increase factor due to frontage as calculated in accordance with Section
14 506.2]

15 [I_s = Area increase factor due to sprinkler protection as calculated in accordance with
16 Section 506.3.]

17 **506.2 Frontage increase.** Where a building has more than 25 percent of its perimeter adjoining a
18 public way or open space having a minimum width of 20 feet (6096 mm), the frontage increase shall
19 be determined in accordance with the following:]

20
$$[I_f = (F/P - 0.25)W/30]$$

21 [(Equat

22 ion 5-2)]

23 [where:]

24 [I_f = Area increase factor due to frontage.]

25 [F = Building perimeter that fronts on a public way or open space having 20 feet (6096
26 mm) open minimum width (feet).]

27 [P = Perimeter of entire building (feet).]

28 [W = Width of public way or open space (feet) in accordance with Section 506.2.1.]

29 **506.1.1 Unlimited area buildings.** Unlimited area buildings shall be designed in accordance with
30 Section 507.

31 **506.1.2 Special provisions.** The special provisions of Section 510 permit the use of special
32 conditions that are exempt from, or modify, the specific requirements of this chapter regarding
33 the allowable areas of buildings based on the occupancy classification and type of construction,
34 provided the special condition complies with the provisions specified in Section 510.

35 **506.1.3 Basement and cellar.** A single basement or cellar need not be included in the total
36 allowable building area, provided such basement or cellar does not exceed the area permitted for
37 a building with no more than one story above grade plane.

- 1 **506.2 Allowable area determination.** The allowable area of a building shall be determined in
 2 accordance with the applicable provisions of Sections 506.2.1 through 506.2.4, and Section 506.3.

TABLE 506.2^a
ALLOWABLE AREA FACTOR (A_f = NS, S1, S13D, S13R, or SM, as applicable) IN SQUARE FEET

OCCUPANCY CLASSIFICATION	SEE FOOTNOTES	TYPE OF CONSTRUCTION								
		TYPE I		TYPE II		TYPE III		TYPE IV ¹	TYPE V	
		A	B	A	B	A	B	HT	A	B
A-1	NS ^{b,c}	UL	UL	17,500	10,500	14,700	5,600	15,000	8,400	5,500
	S1	UL	UL	52,500	31,500	44,100	16,800	45,000	25,200	16,500
	SM	UL	UL	35,000	21,000	29,400	11,200	30,000	16,800	11,000
A-2	NS ^{b,c}	UL	UL	17,500	9,500	14,000	5,600	15,000	8,400	5,500
	S1	UL	UL	52,500	28,500	42,000	16,800	45,000	25,200	16,500
	SM	UL	UL	35,000	19,000	28,000	11,200	30,000	16,800	11,000
A-3	NS ^{b,c}	UL	UL	17,500	9,500	14,000	5,600	15,000	8,400	5,500
	S1	UL	UL	52,500	28,500	42,000	16,800	45,000	25,200	16,500
	SM	UL	UL	35,000	19,000	28,000	11,200	30,000	16,800	11,000
A-4	NS ^{b,c}	UL	UL	17,500	9,500	14,000	5,600	15,000	8,400	5,500
	S1	UL	UL	52,500	28,500	42,000	16,800	45,000	25,200	16,500
	SM	UL	UL	35,000	19,000	28,000	11,200	30,000	16,800	11,000
A-5	NS ^{b,c}	UL	UL	UL	UL	UL	UL	UL	UL	UL
	S1	UL	UL	UL	UL	UL	UL	UL	UL	UL
	SM	UL	UL	UL	UL	UL	UL	UL	UL	UL
B	NS ^{b,c}	UL	UL	37,500	10,500	28,500	5,600	36,000	8,400	5,500
	S1	UL	UL	112,500	31,500	85,500	16,800	108,000	25,200	16,500
	SM	UL	UL	75,000	21,000	57,000	11,200	72,000	16,800	11,000
E	NS ^{b,c}	UL	UL	26,000	10,500	23,500	5,600	25,500	8,400	5,500
	S1	UL	UL	78,000	31,500	70,500	16,800	76,500	25,200	16,500
	SM	UL	UL	52,000	21,000	47,000	11,200	51,000	16,800	11,000
F-1	NS ^{b,c}	UL	UL	12,500	7,500	7,500	3,000	10,000	3,000	1,000
	S1	UL	UL	37,500	22,500	22,500	9,000	30,000	9,000	3,000
	SM	UL	UL	25,000	15,000	15,000	6,000	20,000	6,000	2,000
F-2	NS ^{b,c}	UL	UL	37,500	10,500	28,500	5,600	30,000	8,400	5,500
	S1	UL	UL	112,500	31,500	85,500	16,800	90,000	25,200	16,500
	SM	UL	UL	75,000	21,000	57,000	11,200	60,000	16,800	11,000
H-1	NS ^{b,c}	21,000	16,500	11,000	7,500	9,500	7,000	10,500	7,500	NP
	S1	21,000	16,500	11,000	7,500	9,500	7,000	10,500	7,500	3,000
H-2 ^f	NS ^{b,c}	21,000	16,500	11,000	7,500	9,500	7,000	10,500	7,500	3,000
	S1	21,000	16,500	11,000	7,500	9,500	7,000	10,500	7,500	3,000
	SM	21,000	16,500	11,000	7,500	9,500	7,000	10,500	7,500	3,000
H-3 ^f	NS ^{b,c}	UL	60,000	26,500	14,000	17,500	13,000	25,000	10,000	5,000
	S1	UL	60,000	26,500	14,000	17,500	13,000	25,000	10,000	5,000
	SM	UL	60,000	26,500	14,000	17,500	13,000	25,000	10,000	5,000
H-4	NS ^{b,c}	UL	UL	37,500	17,500	28,500	17,500	36,000	18,000	6,500
	S1	UL	UL	112,500	52,500	85,500	52,500	108,000	54,000	19,500
	SM	UL	UL	75,000	35,000	57,000	35,000	72,000	36,000	13,000
H-5	NS ^{b,c}	UL	UL	37,500	23,000	28,500	19,000	36,000	18,000	9,000
	S1	UL	UL	112,500	69,000	85,500	57,000	108,000	54,000	27,000
	SM	UL	UL	75,000	46,000	57,000	38,000	72,000	36,000	18,000
I-1	NS ^{b,c}	UL	UL	19,000	NP	16,500	5,600	18,000	NP	NP
	S13D	UL	UL	19,000	NP	16,500	5,600	18,000	NP	NP
	S1	UL	UL	57,000	NP	49,500	16,800	54,000	NP	NP
	SM	UL	UL	38,000	NP	33,000	11,200	36,000	NP	NP
I-2	NS ^{b,c}	UL	UL	7,000	3,500	5,000	1,200	6,500	2,000	NP
	S1	UL	UL	21,000	10,500	15,000	3,600	19,500	6,000	NP
	SM	UL	UL	14,000	7,000	10,000	2,400	13,000	4,000	NP
I-3	NS ^{b,c}	UL	UL	7,000	3,500	5,000	1,200	6,500	2,000	NP

TABLE 506.2^a
ALLOWABLE AREA FACTOR (A_r = NS, S1, S13D, S13R, or SM, as applicable) IN SQUARE FEET

OCCUPANCY CLASSIFICATION	SEE FOOTNOTES	TYPE OF CONSTRUCTION								
		TYPE I		TYPE II		TYPE III		TYPE IV ¹	TYPE V	
		A	B	A	B	A	B	HT	A	B
	S1	UL	UL	21,000	10,500	15,000	3,600	19,500	6,000	NP
	SM	UL	UL	14,000	7,000	10,000	2,400	13,000	4,000	NP
	NS ^{b,c}	UL	UL	26,500	9,500	23,500	5,600	25,500	8,400	5,500
I-4	S1	UL	UL	79,500	28,500	70,500	16,800	76,500	25,200	16,500
	SM	UL	UL	53,000	19,000	47,000	11,200	51,000	16,800	11,000
	NS ^{b,c}	UL	UL	21,500	7,500	18,500	5,600	14,000	8,400	5,500
M	S1	UL	UL	64,500	22,500	55,500	16,800	42,000	25,200	16,500
	SM	UL	UL	43,000	15,000	37,000	11,200	28,000	16,800	11,000
	NS ^{b,c}	UL	UL	UL	NP	24,000	NP	20,500	NP	NP
R-1	S13R	UL	UL	UL	NP	24,000	NP	20,500	NP	NP
	S1	UL	UL	UL	NP	72,000	NP	61,500	NP	NP
	SM	UL	UL	UL	NP	48,000	NP	41,000	NP	NP
R-2	NS ^{b,c}	UL	UL	UL	NP	24,000	5,600	20,500	NP	NP
	S13R	UL	UL	UL	NP	24,000	5,600	20,500	NP	NP
	S1	UL	UL	UL	NP	72,000	16,800	61,500	NP	NP
R-3	SM	UL	UL	UL	NP	48,000	11,200	41,000	NP	NP
	NS ^{b,c}	UL	UL	17,500	10,500	14,700	5,600	30,000	8,400 ^{g,h}	5,500 ^e
	S13D						5,600			
S13R	UL	UL	52,500	31,500	44,100	16,800	90,000	8,400 ^{g,h}	5,500 ^e	
S-1	SM	UL	UL	35,000	21,000	29,400	11,200	60,000		
	NS ^{b,c}	UL	48,000	12,000	7,500	7,500	7,500	7,500	5,000	1,000
	S1	UL	144,000	36,000	22,500	22,500	22,500	22,500	15,000	3,000
S-2 ^{d,e}	SM	UL	96,000	24,000	15,000	15,000	15,000	15,000	10,000	2,000
	NS ^{b,c}	UL	UL	15,000	10,000	10,000	8,500	10,000	8,400	5,500
	S1	UL	UL	45,000	30,000	30,000	25,500	30,000	25,200	16,500
U ^e	SM	UL	UL	30,000	20,000	20,000	17,000	20,000	16,800	11,000
	NS ^{b,c}	UL	35,000	19,000	8,500	14,000	8,500	18,000	9,000	5,500
	S1	UL	105,000	57,000	25,500	42,000	25,500	54,000	27,000	16,500
	SM	UL	70,000	38,000	17,000	28,000	17,000	36,000	18,000	11,000

 = Not permitted in Fire District

 = Not permitted in Fire District without sprinklers

- 1 **Note:** UL = Unlimited; NP = Not permitted;
2 For SI: 1 square foot = 0.0929 m².
3 NS = Buildings not equipped throughout with an automatic sprinkler system; S1 = Buildings a maximum of one story above grade
4 plane equipped throughout with an automatic sprinkler system installed in accordance with Section 903.3.1.1; SM = Buildings two or
5 more stories above grade plane equipped throughout with an automatic sprinkler system installed in accordance with Section
6 903.3.1.1; S13R = Buildings equipped throughout with an automatic sprinkler system installed in accordance with Section 903.3.1.2;
7 S13D = Buildings equipped throughout with an automatic sprinkler system installed in accordance with Section 903.3.1.3.
8 a. See the following sections for general exceptions to Table 506.2.
9 1. See Chapters 4 and 5 for specific exceptions to the allowable height in this chapter.
10 2. Section 506.3, Allowable area increase due to frontage.
11 3. Section 507, Unlimited area building.
12 b. See Section 903.2 for the minimum thresholds for protection by an automatic sprinkler system for specific occupancies.
13 c. The NS value is only for use in buildings not required by this code to be equipped throughout with an automatic sprinkler
14 system.
15 d. For open parking structures, see Section 406.5.
16 e. For private garages, see Section 406.3.
17 f. See Section 415.8 for limitations.
18 g. See Exception 9 of Section D105.1 for allowances of Type VA and VB construction for R-3 occupancies.
19 h. See Exception 12 of Section D105.1 for allowances of Type VA construction for R-3 occupancies in Lower Density
20 Growth Management Areas.

1 i. Type IV construction utilizing cross-laminated timber or structural composite lumber shall be sprinklered where required by
2 Section 903.2.13.

3 **506.2.1 Single-occupancy, one-story buildings.** The allowable area of a single-occupancy
4 building with no more than one story above grade plane shall be determined in accordance with
5 Equation 5-1:

$$6 \quad A_a = A_t + (NS \times I_f) \quad \textbf{(Equation 5-1)}$$

7 where:

8 A_a = Allowable area (square feet).

9 A_t = Tabular allowable area factor (NS, S1, S13D or S13R value, as applicable) in
10 accordance with Table 506.2.

11 NS = Tabular allowable area factor in accordance with Table 506.2 for nonsprinklered
12 building (regardless of whether the building is sprinklered).

13 I_f = Area increase factor due to frontage (percent) as calculated in accordance with
14 Section 506.3.

15 **506.2.2 Mixed-occupancy, one-story buildings.** The allowable area of a mixed-occupancy
16 building with no more than one story above grade plane shall be determined in accordance with
17 the applicable provisions of Section 508.1 based on Equation 5-1 for each applicable occupancy.

18 ~~[506.2.1 Width limits. The value of “W” shall be at least 20 feet (6096 mm). Where the value~~
19 ~~of W varies along the perimeter of the building, the calculation performed in accordance with~~
20 ~~Equation 5-2 shall be based on the weighted average of each portion of exterior wall and open~~
21 ~~space where the value of W is greater than or equal to 20 feet (6096 mm). Where W exceeds 30~~
22 ~~feet (9144 mm), a value of 30 feet (9144 mm) shall be used in calculating the weighted average,~~
23 ~~regardless of the actual width of the open space. Where two or more buildings are on the same~~
24 ~~tax lot, W shall be measured from the exterior face of a building to the exterior face of an~~
25 ~~opposing building, as applicable.]~~

26 ~~[Exception: The value of W divided by 30 shall be permitted to be a maximum of 2 when~~
27 ~~the building meets all requirements of Section 507 except for compliance with the 60-foot~~
28 ~~(18 288 mm) public way or yard requirement, as applicable.]~~

29 ~~[506.2.2 Open space limits. Such open space shall be either on the same zoning lot or dedicated~~
30 ~~for public use and shall be accessed from a street or approved fire lane.]~~

31 ~~[506.3 Automatic sprinkler system increase. Where a building is equipped throughout with an~~
32 ~~approved automatic sprinkler system in accordance with Section 903.3.1.1, the building area~~
33 ~~limitation in Table 503 is permitted to be increased by an additional 200 percent ($I_s = 2$) for buildings~~
34 ~~with more than one story above grade plane and an additional 300 percent ($I_s = 3$) for buildings with~~
35 ~~no more than one story above grade plane. These increases are permitted in addition to the height~~
36 ~~and story increases in accordance with Section 504.2.]~~

37 ~~[Exceptions: The building area limitation increases shall not be permitted for the following~~
38 ~~conditions:]~~

1 ~~[1. The automatic sprinkler system increase shall not apply to buildings with an occupancy in~~
2 ~~Group H-1.]~~

3 ~~[2. The automatic sprinkler system increase shall not apply to the building area of an~~
4 ~~occupancy in Group H-2 or H-3.]~~

5 **506.2.2.1 Group H-2 or H-3 mixed occupancies.** For [buildings] a building containing
6 [sueh] Group H-2 or H-3 occupancies, the allowable [building] area shall be determined in
7 accordance with Section 508.4.2, with the sprinkler system increase applicable only to the
8 portions of the building not classified as Group H-2 or H-3.

9 ~~[3. Fire resistance rating substitution in accordance with Table 601, Note d.]~~

10 ~~**[506.4 Single occupancy buildings with more than one story.** The total allowable building area of~~
11 ~~a single occupancy building with more than one story above grade plane shall be determined in~~
12 ~~accordance with this section. The actual aggregate building area at all stories in the building shall not~~
13 ~~exceed the total allowable building area.]~~

14 ~~**[Exception:** A single basement need not be included in the total allowable building area, provided~~
15 ~~such basement does not exceed the area permitted for a building with no more than one story~~
16 ~~above grade plane and the finished surface of the floor above the basement does not exceed 6 feet~~
17 ~~(1829 mm) above grade plane.]~~

18 ~~**[506.4.1 Area determination.** The total allowable building area with more than one story above~~
19 ~~grade plane shall be determined by multiplying the allowable area per story (A_s), as determined~~
20 ~~in Section 506.1, by the number of stories above grade plane as listed below:]~~

21 ~~[1. For buildings with two stories above grade plane, multiply by 2;]~~

22 ~~[2. For buildings with three or more stories above grade plane, multiply by 3; and]~~

23 ~~[3. No story shall exceed the allowable area per story (A_s), as determined in Section 506.1 for~~
24 ~~the occupancies on that story.]~~

25 ~~**[Exceptions:]**~~

26 ~~[1. Unlimited area buildings in accordance with Section 507.]~~

27 ~~[2. In Group R occupancies 6 stories or less in height, the maximum area of a building~~
28 ~~equipped throughout with an automatic sprinkler system in accordance with Section~~
29 ~~903.3.1.2 shall be determined by multiplying the allowable area per story (A_s), as~~
30 ~~determined in Section 506.1, by the number of stories above grade plane.]~~

31 ~~**[506.5 Mixed occupancy area determination.** The total allowable building area for buildings~~
32 ~~containing mixed occupancies shall be determined in accordance with the applicable provisions of~~
33 ~~this section.]~~

34 ~~**[Exception:** A single basement need not be included in the total allowable building area, provided~~
35 ~~such basement does not exceed the area permitted for a building with no more than one story~~

1 above grade plane and the finished surface of the floor above the basement does not exceed 6 feet
2 (1829 mm) above grade plane.]

3 ~~[506.5.1 No more than one story above grade plane. For buildings with no more than one story~~
4 ~~above grade plane and containing mixed occupancies, the total building area shall be determined~~
5 ~~in accordance with the applicable provisions of Section 508.1.]~~

6 **506.2.3 Single-occupancy, multistory buildings.** The allowable area of a single-occupancy
7 building with more than one story above grade plane shall be determined in accordance with
8 Equation 5-2:

$$9 \quad A_a = [A_t + (NS \times I_f)] \times S_a \quad \textbf{(Equation 5-2)}$$

10 where:

11 A_a = Allowable area (square feet).

12 A_t = Tabular allowable area factor (NS, S13D, S13R or SM value, as applicable) in
13 accordance with Table 506.2.

14 NS = Tabular allowable area factor in accordance with Table 506.2 for a nonsprinklered
15 building (regardless of whether the building is sprinklered).

16 I_f = Area factor increase due to frontage (percent) as calculated in accordance with
17 Section 506.3.

18 S_a = Actual number of building stories above grade plane, not to exceed three. For
19 buildings equipped throughout with an automatic sprinkler system installed in
20 accordance with Section 903.3.1.2, use the actual number of building stories above
21 grade plane, not to exceed four.

22 No individual story shall exceed the allowable area (A_a) as determined by Equation 5-2
23 using the value of $S_a = 1$.

24 ~~[506.5.2 No more than one story above grade plane. For buildings with no more than one story~~
25 ~~above grade plane and containing mixed occupancies, each story]~~ **506.2.4 Mixed-occupancy,**
26 **multistory buildings.** Each story of a mixed-occupancy building with more than one story above
27 grade plane shall individually comply with the applicable requirements of Section 508.1. For
28 buildings with more than three stories above grade plane, the total building area shall be such that
29 the aggregate sum of the ratios of the actual area of each story divided by the allowable area of
30 such stories, determined in accordance with Equation 5-3 based on the applicable provisions of
31 Section 508.1, shall not exceed [3] three.

$$32 \quad A_a = [A_t + (NS \times I_f)] \quad \textbf{(Equation 5-3)}$$

33 where:

34 A_a = Allowable area (square feet).

35 A_t = Tabular allowable area factor (NS, S13D, S13R or SM value, as applicable) in
36 accordance with Table 506.2.

1 NS = Tabular allowable area factor in accordance with Table 506.2 for a nonsprinklered
2 building (regardless of whether the building is sprinklered).

3 I_f = Area factor increase due to frontage (percent) as calculated in accordance with Section
4 506.3.

5 **Exception:** For buildings designed as separated occupancies under Section 508.4 and
6 equipped throughout with an automatic sprinkler system installed in accordance with Section
7 903.3.1.2, the total building area shall be such that the aggregate sum of the ratios of the actual
8 area of each story divided by the allowable area of such stories determined in accordance with
9 Equation 5-3 based on the applicable provisions of Section 508.1, shall not exceed four.

10 **506.2.4.1 Group H-2 or H-3 mixed occupancies.** For a building containing Group H-2 or H-
11 3 occupancies, the allowable area shall be determined in accordance with Section 508.4.2,
12 with the sprinkler system increase applicable only to the portions of the building not classified
13 as Group H-2 or H-3.

14 **506.3 Frontage increase.** Area factor increase shall be determined in accordance with Sections
15 506.3.1 through 506.3.3.

16 **506.3.1 Minimum percentage of perimeter.** To qualify for an area factor increase based on
17 frontage, a building shall have not less than 25 percent of its perimeter on a public way or open
18 space. Such open space shall be either on the same zoning lot or dedicated for public use and shall
19 be accessed from a street or approved fire lane.

20 **506.3.2 Minimum frontage distance.** To qualify for an area factor increase based on frontage,
21 the public way or open space adjacent to the building perimeter shall have a minimum distance
22 (W) of 20 feet (6096 mm) measured at right angles from the building face to any of the following:

- 23 1. The closest interior tax lot line.
- 24 2. The entire width of a street, alley or public way.
- 25 3. The exterior face of an adjacent building on the same tax lot.

26 Where the value of W is greater than 30 feet (9144 mm), a value of 30 feet (9144 mm) shall
27 be used in calculating the building area increase based on frontage, regardless of the actual width
28 of the public way or open space. Where the value of W varies along the perimeter of the building,
29 the calculation performed in accordance with Equation 5-5 shall be based on the weighted average
30 calculated in accordance with Equation 5-4.

31
$$W = (L_1 \times w_1 + L_2 \times w_2 + L_3 \times w_3 \dots) / F$$
 (Equation 5-4)

32 where:

33 W = (Width: weighted average) = Calculated width of public way or open space (feet).

34 L_n = Length of a portion of the exterior perimeter wall.

35 w_n = Width (≥ 20 feet) of a public way or open space associated with that portion of the
36 exterior perimeter wall.

1 $F =$ Building perimeter that fronts on a public way or open space having a width of 20
2 feet (6096 mm) or more.

3 **Exception:** Where a building meets the requirements of Section 507, as applicable, except for
4 compliance with the minimum 60-foot (18 288 mm) public way or yard requirement, and the
5 value of W is greater than 30 feet (9144 mm), the value of W shall not exceed 60 feet (18 288
6 mm).

7 **506.3.3 Amount of increase.** The area factor increase based on frontage shall be determined in
8 accordance with Equation 5-5:

9
$$I_f = (F/P - 0.25) W / 30$$
 (Equation 5-5)

10 where:

11 $I_f =$ Area increase factor due to frontage.

12 $F =$ Building perimeter that fronts on a public way or open space having minimum
13 distance of 20 feet (6096 mm).

14 $P =$ Perimeter of entire building (feet).

15 $W =$ Width of public way or open space (feet) in accordance with Section 506.3.2.

16
17 **SECTION BC 507**
18 **UNLIMITED AREA BUILDINGS**

19 **507.1 General.** The area of buildings of the occupancies and configurations specified in [~~Section~~]
20 Sections [507] 507.1 through 507.18 shall not be limited, except that only one cellar or one basement
21 shall be permissible.

22 **507.1.1 Accessory occupancies.** Accessory occupancies shall be permitted in unlimited area
23 buildings in accordance with the provisions of Section 508.2, otherwise the requirements of
24 Sections 507.3 through 507.18 shall be applied, where applicable.

25 **507.2 Measurement of open spaces.** Where Sections 507.3 through 507.18 require buildings to be
26 surrounded and adjoined by public ways and yards, those open spaces shall be determined as follows:

27 1. Yards shall be measured from the building perimeter in all directions to the closest interior lot
28 lines or to the exterior face of an opposing building located on the same tax lot, as applicable.

29 2. Where the building fronts on a public way, the entire width of the public way shall be used.

30 **507.2.1 Reduced open space.** The public ways or yards of 60 feet (18 288 mm) in width required
31 in Sections 507.3, 507.4, 507.5 and 507.6 shall be permitted to be reduced to not less than 40 feet
32 (12 192 mm) in width provided all of the following requirements are met:

33 1. The reduced width shall not be allowed for more than 75 percent of the perimeter of the
34 building.

35 2. The exterior walls facing the reduced width shall have a fire-resistance rating of not less
36 than 3 hours.

1 3. Openings in the exterior walls facing the reduced width shall have opening protectives
2 with a fire protection rating of not less than 3 hours.

3 ~~[507.2]~~ **507.3 Nonsprinklered, ~~[one-story]~~ one-story buildings.** The area of a Group F-2 or S-2
4 building no more than one story in height, of other than Type V construction, shall not be limited
5 when the building is surrounded and adjoined on all sides by public ways or yards not less than 60
6 feet (18 288 mm) in width.

7 ~~[507.3]~~ **507.4 Sprinklered, ~~[one-story]~~ one-story buildings.** The area of a Group ~~A-4~~ building no
8 more than one story in height above grade plane of other than Type V construction, or the area of a
9 ~~Group B, F, M or S building no more than one story~~ in height of any construction type, shall not be
10 ~~one story in height of other than Type V construction~~ in height of any construction type, shall not be
11 limited ~~[when]~~ where the building is provided with an automatic sprinkler system throughout in
12 accordance with Section 903.3.1.1~~;~~ and is surrounded and adjoined on all sides by public ways or
13 yards not less than 60 feet (18 288 mm) in width.

14 **Exceptions:**

15 1. In Group F-2 and S-2 occupancies, one-story rack storage facilities of Type II construction
16 that are not accessible to the public shall not be limited in height provided that such
17 buildings conform to the requirements of the New York City Fire Code, and Sections
18 ~~[507.3,]~~ 507.4 and 903.3.1.1 of this code ~~[and the New York City Fire Code].~~

19 2. The automatic sprinkler system shall not be required in areas occupied for indoor
20 participant sports, such as tennis, skating, swimming and equestrian activities, in
21 occupancies in Group A-4, provided that both of the following criteria are met:

22 2.1. Exit doors directly to the outside are provided for occupants of the participant sports
23 areas~~;~~ and.

24 2.2. The building is equipped with a fire alarm system with manual fire alarm boxes
25 installed in accordance with Section 907.

26 ~~[507.3.1]~~ **507.4.1 Mixed occupancy buildings with Groups A-1 and A-2.** Group A-1 and A-2
27 occupancies of other than Type V construction shall be permitted within mixed occupancy
28 buildings of unlimited area complying with Section ~~[507.3]~~ 507.4, provided all of the following
29 criteria are met:

30 1. Group A-1 and A-2 occupancies are separated from other occupancies as required for
31 separated occupancies in Section 508.4.4 with no reduction allowed in the fire-resistance
32 rating of the separation based upon the installation of an automatic sprinkler system~~;~~.

33 2. Each area of the portions of the building used for Group A-1 or A-2 occupancies shall not
34 exceed the maximum allowable area permitted for such occupancies in Section 503.1~~;~~
35 and.

36 3. ~~[All-exit]~~ Exit doors from Group A-1 and A-2 occupancies shall discharge directly to the
37 exterior of the building.

1 ~~[507.4]~~ **507.5 Sprinklered, [two-story] two-story buildings.** The area of a Group B, F, M or S
2 building no more than two stories in height shall not be limited when the building is provided with
3 an automatic sprinkler system in accordance with Section 903.3.1.1 throughout, and is surrounded
4 and adjoined on all sides by public ways or yards not less than 60 feet (18 288 mm) in width.

5 ~~[507.5 Reduced open space.~~ The public ways or yards of 60 feet (18 288 mm) required in Sections
6 507.2, 507.3, 507.4 and 507.6 shall be permitted to be reduced to not less than 40 feet (12 192 mm)
7 in width provided all of the following requirements are met:]

8 [1. ~~The reduced width shall not be allowed for more than 75 percent of the perimeter of the~~
9 ~~building.]~~

10 [2. ~~The exterior wall facing the reduced width shall have a minimum fire resistance rating of 3~~
11 ~~hours.]~~

12 [3. ~~Openings in the exterior wall, facing the reduced open space, shall have opening protectives~~
13 ~~with a minimum fire resistance rating of 3 hours.]~~

14 **507.6 Group A buildings.** The area of a Group A-1, A-2, A-3, or A-4 building of Type IIA, IIIA or
15 IV construction shall not be limited where the building is equipped throughout with an automatic
16 sprinkler system in accordance with Section 903.3.1.1. The area of a one-story, Group A-3 building
17 used as a house of worship, community hall, dance hall, exhibition hall, gymnasium, lecture hall,
18 indoor swimming pool or tennis court of Type IIB construction shall not be limited when all of the
19 following criteria are met:

- 20 1. The building shall not have a stage other than a platform.
- 21 2. The building shall be equipped throughout with an automatic sprinkler system in accordance
22 with Section 903.3.1.1.
- 23 3. The assembly floor shall be located at or within 21 inches (533 mm) of street or grade level
24 and all exits are provided with ramps complying with Section ~~[1010.4]~~ 1012.1 to the street
25 or grade level.
- 26 4. The building shall be surrounded and adjoined on all sides by public ways or yards not less
27 than 60 feet (18 288 mm) in width.

28 **507.7 Reserved.**

29 **507.8 Group H occupancies.** Group H-2, H-3 and H-4 fire occupancies shall be permitted in
30 unlimited area buildings containing ~~[Groups]~~ Group F ~~[and]~~ or S occupancies~~;~~ in accordance with
31 Sections ~~[507.3]~~ 507.4 and ~~[507.4]~~ 507.5 and the ~~[limitations of this section]~~ provisions of Sections
32 507.8.1 through 507.8.4.

33 **507.8.1 Allowable area.** The aggregate floor area of ~~[the]~~ Group H occupancies located ~~[at the~~
34 ~~perimeter of the]~~ in an unlimited area building shall not exceed 10 percent of the area of the
35 building~~[, nor]~~ and shall not exceed the area limitations for the Group H occupancies as specified
36 in [Table 503 as modified by Section 506.2,] Section 506 based [upon] on [the percentage of] the

1 perimeter of ~~[the]~~ each Group H floor area that fronts on a ~~[street]~~ public way or ~~[other~~
2 ~~unoccupied]~~ open space.

3 **507.8.1.1 Located within the building.** The aggregate floor area of Group H occupancies not
4 located at the perimeter of the building ~~[as allowed by Section 415.3]~~ shall not exceed 25
5 percent of the area limitations for the Group H occupancies as specified in ~~[Table 503]~~ Section
6 506.

7 **507.8.1.1.1 Liquid use, dispensing and mixing rooms.** Liquid use, dispensing and
8 mixing rooms having a floor area of not more than 500 square feet (46.5 m²) need not be
9 located on the outer perimeter of the building where they are in accordance with the *New*
10 *York City Fire Code* and NFPA 30.

11 **507.8.1.1.2 Liquid storage rooms.** Liquid storage rooms having a floor area of not more
12 than 1,000 square feet (93 m²) need not be located on the outer perimeter where they are
13 in accordance with the *New York City Fire Code* and NFPA 30.

14 **507.8.1.1.3 Spray paint booths.** Spray paint booths that comply with the *New York City*
15 *Fire Code* need not be located on the outer perimeter.

16 **507.8.2 Located on building perimeter.** Except as provided for in Section 507.8.1.1, Group
17 H occupancies shall be located on the perimeter of the building. In Group H-2 and H-3
18 occupancies, not less than 25 percent of the perimeter of such occupancies shall be an exterior
19 wall.

20 **507.8.3 Occupancy separations.** Group H occupancies shall be separated from the ~~[rest]~~
21 remainder of the unlimited area [buildings] building and from each other in accordance with
22 Table 508.4.

23 **507.8.4 Height limitations.** For two-story₂ unlimited area buildings, ~~[the]~~ Group H
24 occupancies shall not be located more than one story above grade plane unless permitted [by]
25 based on the allowable height [in] and number of stories and feet as set forth in [Table 503]
26 Section 504 based on the type of construction of the unlimited area building.

27 **507.9 Unlimited mixed occupancy buildings with Group H-5.** The area of a Group B, F, H-5, M
28 or S building no more than two stories above grade plane shall not be limited where the building is
29 equipped throughout with an automatic sprinkler system in accordance with Section 903.3.1.1, and is
30 surrounded and adjoined by public ways or yards not less than 60 feet (18 288 mm) in width, provided
31 all of the following criteria are met:

- 32 1. Buildings containing Group H-5 occupancy shall be of Type I or II construction.
- 33 2. Each area used for Group H-5 occupancy shall be separated from other occupancies as
34 required in Sections 415.11 and 508.4.
- 35 3. Each area used for Group H-5 occupancy shall not exceed the maximum allowable area
36 permitted for such occupancies in Section 503.1 including modifications of Section 506.

1 **Exception:** Where the Group H-5 occupancy exceeds the maximum allowable area, the
2 Group H-5 shall be subdivided into areas that are separated by 2-hour fire barriers.

3 ~~[507.9]~~ **507.10 Aircraft paint hangar.** The area of a Group H-2 aircraft paint hangar no more than
4 one story above grade plane shall not be limited where such aircraft paint hangar complies with the
5 provisions of Section 412.6 and is surrounded and adjoined by public ways or yards not less in width
6 than one and one-half times the building height.

7 ~~[507.10]~~ **507.11 Group E buildings.** The area of a Group E building of Type IIA, IIIA or IV
8 construction shall not be limited where the building is protected throughout with an approved
9 automatic sprinkler system in accordance with Section 903.3.1.1. The area of a one-story Group E
10 building of Type IIB construction shall not be limited when the following criteria are met:

- 11 1. Each classroom shall have not less than two means of egress, with one of the means of egress
12 being a direct exit to the outside of the building complying with Section ~~[402.0]~~ 1022.
- 13 2. The building is equipped throughout with an automatic sprinkler system in accordance with
14 Section 903.3.1.1.
- 15 3. The building is surrounded and adjoined on all sides by public ways or yards not less than 60
16 feet (18 288 mm) in width.

17 ~~[507.11]~~ **507.12 Motion picture theaters.** In buildings of Type II, IIIA and IV construction, the area
18 of a motion picture theater located on the first story above grade plane shall not be limited when the
19 building is provided with an automatic sprinkler system throughout in accordance with Section
20 903.3.1.1 and is surrounded and adjoined on all sides by public ways or yards not less than 60 feet
21 (18 288 mm) in width.

22 ~~[507.12]~~ **507.13 Covered and open mall buildings and anchor ~~[stores]~~ buildings.** The area of
23 covered and open mall buildings and anchor ~~[stores]~~ buildings not exceeding three stories in height
24 that comply with Section ~~[402.6]~~ 402 shall not be limited.

25 ~~[507.13]~~ **507.14 Group B buildings.** Notwithstanding the provisions of Sections ~~[507.2]~~ 507.3 and
26 ~~[507.3]~~ 507.4, the area of a Group B building of Type IIA, IIIA or IV construction shall not be
27 limited where the building is protected throughout with an approved automatic sprinkler system in
28 accordance with Section 903.3.1.1.

29 ~~[507.14]~~ **507.15 Group F-2 buildings.** Notwithstanding the provisions of Sections ~~[507.2]~~ 507.3
30 and ~~[507.3]~~ 507.4, the area of a Group F-2 building of Type IIA, IIIA or IV construction shall not
31 be limited where the building is protected throughout with an approved automatic sprinkler system
32 in accordance with Section 903.3.1.1.

33 ~~[507.15]~~ **507.16 Group M buildings.** Notwithstanding the provisions of Sections ~~[507.2]~~ 507.3 and
34 ~~[507.3]~~ 507.4, the area of a Group M building of Type IIA, IIIA or IV construction shall not be
35 limited where the building is protected throughout with an approved automatic sprinkler system in
36 accordance with Section 903.3.1.1.

1 ~~[507.16]~~ **507.17 Group R buildings.** The area of Group R-1 and R-2 buildings of Type IIA, IIIA or
2 IV construction shall not be limited where the building is protected throughout with an approved
3 automatic sprinkler system in accordance with Section 903.3.1.1 or 903.3.1.2, as applicable.

4 ~~[507.17]~~ **507.18 Group S-2 buildings.** Notwithstanding the provisions of Sections ~~[507.2]~~ 507.3 and
5 ~~[507.3]~~ 507.4, the area of a Group S-2 building of Type IB, IIA, IIIA or IV construction shall not be
6 limited where the building is protected throughout with an approved automatic sprinkler system in
7 accordance with Section 903.3.1.1.

8 **SECTION BC 508**
9 **MIXED USE AND OCCUPANCY**

10 **508.1 General.** Each portion of a building shall be individually classified in accordance with Section
11 302.1. Where a building contains more than one occupancy group, the building or portion thereof
12 shall comply with the applicable provisions of Section 508.2, 508.3 or 508.4, or a combination of
13 these sections.

14 **Exceptions:**

- 15 1. Occupancies separated in accordance with Section 510.
- 16 2. Where required by Table ~~[415.5.2]~~ 415.6.2, areas of Group H-1, H-2 and H-3
17 occupancies shall be located in a detached building or structure.
- 18 3. Where identified in Table 509, rooms or spaces shall be treated as incidental uses.
- 19 4. Where not identified in Table 509, mechanical and/or electrical equipment rooms shall be
20 permitted to be classified as the occupancy within which they are located, or at the option
21 of the applicant, classified as Group F-2 occupancy in accordance with Section 306.3.
- 22 5. Commercial kitchens classified as Group F-2 need not be separated by fire separations
23 from adjoining dining spaces, provided that the conditions of Items 5.1, 5.2, and 5.3 are
24 met:
 - 25 5.1. The cooking equipment is vented directly to the outdoors;
 - 26 5.2. A draft curtain of noncombustible material, at least 24 inches (609 mm) down from
27 the ceiling, is provided to separate the opening between the cooking facilities and
28 the dining spaces; and
 - 29 5.3. A fire protection system is installed and located as set forth in Item 5.3.1 or 5.3.2.
 - 30 5.3.1. A fire protection system in accordance with Sections 903 and 904 is installed
31 within the cooking facilities. Additionally, sprinkler heads protecting the
32 opening between the cooking facilities and the dining spaces shall be located
33 within 24 inches (609 mm) of the curtain on the cooking facilities side; or
 - 34 5.3.2. A fire protection system in accordance with Section 903 is located along any
35 opening between the cooking facilities and the dining space on the cooking

1 facilities side, with sprinkler heads located within 24 inches (609 mm) of the
2 opening and, if the opening is more than 60 inches (1524 mm) wide, the
3 sprinkler heads are spaced not more than 48 inches (1219 mm) on center.

4 Where the conditions of Items 5.1, 5.2, and 5.3 cannot be satisfied, such commercial
5 kitchen shall be separated from adjoining dining spaces in accordance with Table 508.4,
6 footnote f.

7 **508.2 Accessory occupancies.** Accessory occupancies are those occupancies that are ancillary to the
8 main occupancy of the building or portion thereof. Accessory occupancies shall comply with the
9 provisions of Sections 508.2.1 through 508.2.4.

10 ~~[508.2.1 Area limitations. Aggregate accessory occupancies shall not occupy more than 10~~
11 ~~percent of the building area of the story in which they are located and shall not exceed the tabular~~
12 ~~values in Table 503, without building area increases in accordance with Section 506 for such~~
13 ~~accessory occupancies.]~~

14 **[Exceptions:]**

15 [1. ~~The following accessory occupancies are permitted to occupy more than 10 percent of~~
16 ~~the floor area of the story in which they are located:]~~

17 [~~1.1. Accessory assembly areas having a floor area less than 750 square feet (69.7 m²).~~]

18 [~~1.2. Assembly areas that are accessory to Group E occupancies.]~~

19 [~~1.3. Accessory religious educational rooms and religious auditoriums with occupant~~
20 ~~loads of less than 100.]~~

21 [2. ~~Rooms or spaces within Group H-2, H-3, H-4 or H-5 occupancy shall not be~~
22 ~~considered accessory occupancies and shall be treated as separated occupancies.]~~

23 ~~[508.2.2] 508.2.1~~ **Occupancy classification.** Accessory occupancies shall be individually
24 classified in accordance with Section 302.1. The requirements of this code shall apply to each
25 portion of the building based on the occupancy classification of that space.

26 **508.2.2 Allowable building height.** The allowable height and number of stories of the building
27 containing accessory occupancies shall be in accordance with Section 504 for the main occupancy
28 of the building.

29 **508.2.3 Allowable building area [and height].** ~~[The allowable building area and height of the~~
30 ~~building shall be based on the allowable building area and height for the main occupancy in~~
31 ~~accordance with Section 503.1. The height of each accessory occupancy shall not exceed the~~
32 ~~tabular values in Table 503, without increases in accordance with Section 504 for such accessory~~
33 ~~occupancies. The building area of the accessory occupancies shall be in accordance with Section~~
34 ~~508.2.1.] The allowable area of the building shall be based on the applicable provisions of Section~~
35 ~~506 for the main occupancy of the building. Aggregate accessory occupancies shall not occupy~~
36 ~~more than 10 percent of the building area of the story in which they are located and shall not~~

1 exceed the tabular values for nonsprinklered buildings in Table 506.2 for each such accessory
2 occupancy.

3 **Exceptions:**

4 1. The following accessory occupancies are permitted to occupy more than 10 percent of
5 the floor area of the story in which they are located:

6 1.1. Accessory assembly areas having a floor area less than 750 square feet (69.7 m²).

7 1.2. Assembly areas that are accessory to Group E occupancies.

8 1.3. Accessory religious educational rooms and religious auditoriums with occupant
9 loads of less than 100.

10 2. Rooms or spaces within Group H-2, H-3, H-4 or H-5 occupancy shall not be
11 considered accessory occupancies and shall be treated as separated occupancies.

12 **508.2.4 Separation of occupancies.** No separation is required between accessory occupancies
13 and the main occupancy.

14 **Exceptions:**

15 1. Group H-2, H-3, H-4 and H-5 occupancies shall be separated from all other
16 occupancies in accordance with Section 508.4.

17 2. Separated tenancies in accordance with the requirements of Section 510.

18 **508.3 Nonseparated occupancies.** Buildings or portions of buildings that comply with the provisions
19 of this section shall be considered as nonseparated occupancies.

20 **508.3.1 Occupancy [~~Classification~~] classification.** Nonseparated occupancies shall be
21 individually classified in accordance with Section 302.1. The requirements of this code shall apply
22 to each portion of the building based on the occupancy classification of that space. In addition,
23 the most restrictive provisions of Chapter 9 [~~which~~] that apply to the nonseparated occupancies
24 shall apply to the total nonseparated occupancy area. Where nonseparated occupancies occur in a
25 high-rise building, the most restrictive requirements of Section 403 [~~which~~] that apply to the
26 nonseparated occupancies shall apply throughout the high-rise building.

27 **508.3.2 Allowable building area and height.** The allowable building area and height of the
28 building or portion thereof shall be based on the most restrictive allowances for the occupancy
29 groups under consideration for the type of construction of the building in accordance with Section
30 503.1.

31 **508.3.3 Separation.** No separation is required between nonseparated occupancies.

32 **Exceptions:**

1 1. Group H-2, H-3, H-4 and H-5 occupancies shall be separated from all other
2 occupancies in accordance with Section 508.4.

3 2. Separated tenancies in accordance with Section 510.10.

4 3. [~~Kitchens~~] Commercial kitchens shall be separated in accordance with Section
5 [~~508.4.4~~] 508.1, Exception 5.

6 **508.4 Separated occupancies.** Buildings or portions of buildings that comply with the provisions of
7 this section shall be considered as separated occupancies.

**TABLE 508.4
REQUIRED SEPARATION OF OCCUPANCIES (HOURS)**

OCCUPANCY	A, E		I-1 ^a , I-3, I-4		I-2		R ^a		F-2, S-2 ^b , U		B ^c		F-1		M		S-1		H-1		H-2		H-3, H-4		H-5	
	S	NS	S	NS	S	NS	S	NS	S	NS	S	NS	S	NS	S	NS	S	NS	S	NS	S	NS	S	NS	S	NS
A, E	N	N	1	2	2	NP	1	2	N ^f	1 ^f	1	2	1	2	1	2	1	2	NP	NP	3	4	2	3	2	NP
I-1 ^a , I-3, I-4	--	--	N	N	2	NP	1	NP	1	2	1	2	1	2	1	2	1	2	NP	NP	3	NP	2	NP	2	NP
I-2	--	--	--	--	N	N	2	NP	2	NP	2	NP	2	NP	2	NP	2	NP	NP	NP	3	NP	2	NP	2	NP
R ^a	--	--	--	--	--	--	N	N	1 ^c	2 ^c	1	2	1	2	1	2	1	2	NP	NP	3	NP	2	NP	2	NP
F-2, S-2 ^b , U	--	--	--	--	--	--	--	--	N	N	1	2	1	2	1	2	1	2	NP	NP	3	4	2	3	2	NP
B ^c	--	--	--	--	--	--	--	--	--	--	N	N	2	3	1	2	2	3	NP	NP	2	3	1	2	1	NP
F-1	--	--	--	--	--	--	--	--	--	--	--	--	N	N	2	3	2	3	NP	NP	2	3	1	2	1	NP
M	--	--	--	--	--	--	--	--	--	--	--	--	--	--	N	N	2	3	NP	NP	2	3	1	2	1	NP
S-1	--	--	--	--	--	--	--	--	--	--	--	--	--	--	--	--	N	N	NP	NP	2	3	1	2	1	NP
H-1	--	--	--	--	--	--	--	--	--	--	--	--	--	--	--	--	--	--	N	NP	NP	NP	NP	NP	NP	NP
H-2	--	--	--	--	--	--	--	--	--	--	--	--	--	--	--	--	--	--	--	--	N	NP	1	NP	1	NP
H-3, H-4	--	--	--	--	--	--	--	--	--	--	--	--	--	--	--	--	--	--	--	--	--	--	1 ^d	NP	1	NP
H-5	--	--	--	--	--	--	--	--	--	--	--	--	--	--	--	--	--	--	--	--	--	--	--	--	N	NP

S = Buildings equipped throughout with an automatic sprinkler system installed in accordance with Section 903.3.1.1.
 NS = Buildings not equipped throughout with an automatic sprinkler system installed in accordance with Section 903.3.1.1.
 N = No separation requirement.
 NP = Not permitted.
 a. See Section 420.

- b. The required separation from areas used only for private or pleasure vehicles shall be reduced by 1 hour but to not less than 1 hour.
- c. See Section ~~406.1.4~~ 406.3.4.
- d. Separation is not required between occupancies of the same classification.
- e. See Section 422.2 for ambulatory care facilities.
- f. A commercial kitchen in Group F-2 that does not comply with Section 508.1, Exception 5 shall be separated from adjoining dining spaces with 1-hour fire separation where the dining spaces are equipped throughout with an automatic sprinkler system installed in accordance with Section 903.3.1.1, and separated with 2-hour fire separation where the dining spaces is not equipped throughout with an automatic sprinkler system.

508.4.1 Occupancy classification. Separated occupancies shall be individually classified in accordance with Section 302.1. Each separated space shall comply with this code based on the occupancy classification of that portion of the building.

508.4.2 Allowable building area. In each story, the building area shall be such that the sum of the ratios of the actual building area of each separated occupancy divided by the allowable building area of each separated occupancy shall not exceed 1.

508.4.3 Allowable height. Each separated occupancy shall comply with the building height limitations based on the type of construction of the building in accordance with Section 503.1.

Exception: Special provisions [~~permitted by~~] of Section 510 shall permit occupancies at building heights other than provided in Section 503.1.

508.4.4 Separation. Individual occupancies shall be separated from adjacent occupancies in accordance with Table 508.4.

[Exceptions] Exception:

~~[1.] Fire separations of Group H and I-2 occupancies shall not be permitted any reductions in fire-resistance ratings.~~

~~[2. Nonresidential kitchens need not be separated by fire separations from adjoining dining spaces, provided that all of the following conditions are satisfied:]~~

~~[2.1. The cooking equipment is vented directly to the outdoors; and]~~

~~[2.2. A draft curtain of noncombustible material, at least 24 inches (609 mm) down from the ceiling, is provided to separate the cooking facilities from dining spaces; and]~~

~~[2.3. Fire protection systems in accordance with the provisions of Section 903 and 904 are provided on the cooking facilities side of the curtain, or any opening between the kitchen and dining space, located within 24 inches (609 mm) of the curtain or opening, and spaced not more than 48 inches (1219 mm) on center if the opening is more than 60 inches (1524 mm) wide.]~~

508.4.4.1 Construction. Required separations shall be fire barriers constructed in accordance with Section 707 or horizontal assemblies constructed in accordance with Section ~~[712]~~ 711, or both, so as to completely separate adjacent occupancies.

SECTION BC 509 INCIDENTAL USES

509.1 General. Incidental uses listed in Table 509 and located within single occupancy or mixed occupancy buildings shall comply with the provisions of this section. Incidental uses are ancillary functions associated with a given occupancy that generally pose a greater level of risk to that occupancy and are limited to those uses listed in Table 509.

Exception: Incidental uses within and serving a dwelling unit are not required to comply with this section.

**TABLE 509^c
INCIDENTAL USES**

ROOM OR AREA	SEPARATION AND/OR PROTECTION
Furnace room where any piece of equipment is over 350,000 Btu per hour input	2 hour; or 1 hour and provide automatic sprinkler system ^a
Furnace room where any piece of equipment is 350,000 Btu per hour input or less, except in R-3 occupancy	1 hour or provide automatic sprinkler system ^a
Rooms with a high pressure steam or water boiler that exceeds 350,000 Btu per hour input	2 hour; or 1 hour and provide automatic fire-extinguishing system ^a
Rooms with a high pressure steam or water boiler that is 350,000 Btu per hour input or less	1 hour or provide automatic sprinkler system ^a
Rooms that contain a low pressure steam or water boiler regardless of Btu per hour input	1 hour or provide automatic sprinkler system ^{a, b}
Refrigerant machinery room	1 hour or provide automatic sprinkler system
Hydrogen fuel gas rooms, not classified as Group H	<u>2 hours in all occupancies</u>
Incinerator rooms	2 hours and provide automatic sprinkler system
Paint shops, not classified a Group H, located in occupancies other than Group F	2 hours; or 1 hour and provide automatic sprinkler system
<u>In Group E occupancies, laboratories [Laboratories] and vocational shops[;] not classified as Group H[, located in a Group E or I-2 occupancy]</u>	1 hour or provide automatic sprinkler system
<u>In Group I-2 occupancies, laboratories not classified as Group H</u>	<u>1 hour and provide automatic sprinkler system</u>
<u>In ambulatory care facilities, laboratories not classified as Group H</u>	<u>1 hour or provide automatic sprinkler system</u>
Laundry rooms over 100 square feet	1 hour or provide automatic sprinkler system
<u>In Group I-2, laundry rooms over 100 square feet</u>	<u>1 hour</u>
Group I-3 cells and Group I-2 patient rooms equipped with padded surfaces	1 hour
<u>In Group I-2, physical plant maintenance shops</u>	<u>1 hour</u>
<u>In ambulatory care facilities or Group I-2 occupancies, waste [Waste] and linen collection rooms with containers that have an aggregate volume of 10 cubic feet or greater[located in either Group I-2 occupancies or ambulatory care facilities]</u>	1 hour
<u>In other than ambulatory care facilities and Group I-2 occupancies, waste [Waste] and linen collection rooms over 100 square feet</u>	1 hour or provide automatic sprinkler system
<u>In ambulatory care facilities or Group I-2 occupancies, storage rooms greater than 100 square feet</u>	<u>1 hour</u>
Stationary storage battery systems having [a liquid electrolyte capacity of more than 50 gallons for flooded lead acid, nickel cadmium or VRLA, or more than 1,000 pounds for lithium ion and lithium metal polymer used for facility standby power, emergency power or uninterruptable power supplies] an energy capacity greater than the threshold quantity specified in Table 608.9.1.1 of the <i>New York City Fire Code</i>	1 hour in group B, F, M, S and U occupancies; 2 hours in Group A, E, I and R occupancies
Rooms containing fire pumps in non-high-rise buildings	2 hours; or 1 hour and provide automatic sprinkler system throughout the building
Rooms containing fire pumps in high-rise buildings	2 hours

a. Boilers servicing more than one dwelling unit in multiple dwellings shall also comply with Section 65 of the *New York State Multiple Dwelling Law*.

b. Sealed combustion direct vent boilers shall comply with Section 303 of the *New York City Mechanical Code* and Section 303 of the *New York City Fuel Gas Code*, as applicable.

c. For mechanical and/or electrical equipment rooms not identified in this Table, see Section 508.1.

For SI: 1 square foot = 0.0929 m², 1 pound per square inch (psi) = 6.9 kPa, 1 British thermal unit (Btu) per hour = 0.293 watts, 1 horsepower = 746 watts, 1 gallon = 3.785 L, 1 cubic foot = 0.0283m³.

509.2 Occupancy classification. Incidental uses shall not be individually classified in accordance with Section 302.1. Incidental uses shall be included in the building occupancies within which they are located.

509.3 Area limitations. Incidental uses shall not occupy more than 10 percent of the building in which they are located.

509.4 Separation and protection. The incidental uses listed in Table 509 shall be separated from the remainder of the building or equipped with an automatic sprinkler system, or both, in accordance with the provisions of that table.

509.4.1 Separation. Where Table 509 specifies a fire-resistance-rated separation, the incidental uses shall be separated from the remainder of the building by a fire barrier constructed in accordance with Section 707 or a horizontal assembly constructed in accordance with Section ~~[712]~~ 711, or both. Construction supporting 1-hour fire barriers or horizontal assemblies used for incidental use separations in buildings of Type IIB, IIIB and VB construction is not required to be fire-resistance rated unless required by other sections of this code.

509.4.2 Protection. Where Table 509 permits an automatic sprinkler system without a fire barrier, the incidental uses shall be separated from the remainder of the building by construction capable of resisting the passage of smoke. The walls shall extend from the top of the foundation or floor assembly below to the underside of the ceiling that is a component of a fire-resistance-rated floor assembly or roof assembly above or to the underside of the floor or roof sheathing, ~~[deck]~~ deck or slab above. Doors shall be self- or automatic-closing upon detection of smoke in accordance with Section ~~[715.4.8.3]~~ 716.5.9.3. Doors shall not have air transfer openings and shall not be undercut in excess of the clearance permitted in accordance with NFPA 80. Walls surrounding the incidental use shall not have air transfer openings unless provided with smoke dampers in accordance with Section ~~[710.7]~~ 710.8.

509.4.2.1 Protection limitation. Except as specified in Table 509 for certain incidental uses, where an automatic sprinkler system is provided in accordance with Table 509, only the space occupied by the incidental use need be equipped with such a system.

§ 7. Chapter 6 of the New York city building code, as amended by local law number 141 for the year 2013, is amended to read as follows:

**CHAPTER 6
TYPES OF CONSTRUCTION**

**SECTION BC 601
GENERAL**

601.1 Scope. The provisions of this chapter shall control the classification of buildings as to type of construction.

**TABLE 601
FIRE-RESISTANCE RATING REQUIREMENTS FOR BUILDING ELEMENTS ([hours] HOURS)**

BUILDING ELEMENT	TYPE I		TYPE II		TYPE III		TYPE IV	TYPE V ^[i]	
	A	B	A ^[d]	B	A ^[d]	B	HT	A ^[d]	B
Primary structural frame ^[g-k] (see Section 202)	3 ^a	2 ^{a,j}	1 ⁱ	0	1	0	HT	1	0
Bearing walls	3	2	1	0	2	2	2	1	0
Exterior ^{e,f,g} ^[h]	3 ^a	2 ^a	1	0	1	0	1/HT	1	0
Interior									
Nonbearing walls and partitions	See Table 602								
Exterior	See Table 602								
Nonbearing walls and partitions	See Table 602								
Interior ^[e]	0	0	0	0	0	0	See Section 602.4.6	0	0
Floor construction ^[i-h] and associated secondary members (see Section 202)	2	2	1	0	1	0	HT	1	0
Roof construction [including supporting beams and joists] and associated secondary [member] members (see Section 202)	1½ ^{b,c}	1 ^{b,c}	1 ^{b,c}	0 ^{[b-]e}	1 ^{b,c}	0	HT	1 ^{b,c}	0

For SI: 1 foot = 304.8 mm.

- a. Roof supports: Fire-resistance ratings of primary structural frame and bearing walls are permitted to be reduced by 1 hour where supporting a roof only.
 - b. 1. Except in Group F-1, H, M and S-1 occupancies, fire protection of structural members in roof construction shall not be required, including protection of primary structural frame members within any portion of the roof, roof framing and decking where every part of the roof construction is 20 feet or more above any floor immediately below. Fire-retardant-treated wood members shall be allowed to be used for such unprotected members.
2. Except in Group F occupancies subject to regulation under Sections 264(1) and 264(2) of the New York State Labor Law, and in Group I-1, R-1, and R-2 occupancies, in Types I and II construction, fire-retardant-treated wood shall be allowed in buildings including girders and trusses as part of the roof construction when the building is:
 - i. Type II construction of any height; or
 - ii. Type I construction two stories or less; or when over two stories, the vertical distance from the upper floor to the roof is 20 feet or more.
 - c. Except in Group F occupancies subject to regulation under Sections 264(1) and 264(2) of the New York State Labor Law, and in Group I-1, R-1 and R-2 occupancies, heavy timber shall be allowed where a 1-hour or less fire-resistance rating is required.
 - d. [~~An approved automatic sprinkler system in accordance with Section 903.3.1.1 shall be allowed to be substituted for 1-hour fire-resistance-rated construction, provided such system is not otherwise required by other provisions of the code or used for an allowable area increase in accordance with Section 506.3 or an allowable height increase in accordance with Section 504.2. The 1-hour substitution for the fire-resistance of exterior walls shall not be permitted.~~]
- [e-] Not less than the fire-resistance rating required by other sections of this code.
 [f-]e. Not less than the fire-resistance rating based on fire separation distance (see Table 602).
 [g-]f. Not less than the fire-resistance rating as referenced in Section 704.10.
 [h-]g. See note g of Table 602.
 [i-]h. See Section 711.2.4 for additional requirements.
 [j-]i. Type V construction is not permitted inside fire districts except as provided for in Section D105.1 of Appendix D.
 [k-]j. See Section [BC] 403.2.1 for additional requirements for high-rise buildings and fire-resistance rating of columns in such buildings.

**TABLE 602
FIRE-RESISTANCE RATING REQUIREMENTS FOR EXTERIOR WALLS BASED ON FIRE SEPARATION DISTANCE^{a,e,g,h,i}**

FIRE SEPARATION DISTANCE = X (feet)	TYPE OF CONSTRUCTION	OCCUPANCY GROUP H ^f	OCCUPANCY GROUP F-1, M, S-1 ^{g,i}	OCCUPANCY GROUP A, B, E, F-2, I, R, S-2, U ^b
X < 5 ^c	All	3	2	1
5 ≤ X < 10	IA Others	3 2	2 1	1 1

TABLE 602
FIRE-RESISTANCE RATING REQUIREMENTS FOR EXTERIOR WALLS BASED ON FIRE SEPARATION
DISTANCE^{a,e,g,h,i}

FIRE SEPARATION DISTANCE = X (feet)	TYPE OF CONSTRUCTION	OCCUPANCY GROUP H ^f	OCCUPANCY GROUP F-1, M, S-1 ^{g,i}	OCCUPANCY GROUP A, B, E, F-2, I, R, S-2, U ^b
$10 \leq X < 30$	IA, IB IIB, VB Others	2 1 1	1 0 1	1 ^d 0 1 ^d
$X \geq 30$	All	0	0	0

For SI: 1 foot = 304.8 mm.

- a. Load-bearing exterior walls shall also comply with the fire-resistance rating requirements of Table 601.
- b. Group U when used as accessory to Group R-3 shall not be required to have a fire-resistance rating where the fire separation distance is 5 feet or more for free standing private garages in compliance with Section 406.1, and when the separation distance is 3 feet or more for other freestanding Group U buildings. For free standing private garages where the fire separation distance is less than 5 feet, refer to Section ~~[406.1]~~ 406.3.4 for required fire-resistance rating for exterior walls.
- c. See Section 706.1.1 for party walls.
- d. Open parking garages complying with Section 406 shall not be required to have a fire-resistance rating.
- e. The fire-resistance rating of an exterior wall is determined based upon the fire separation distance of the exterior wall and the story in which the wall is located.
- f. For special requirements for Group H occupancies, see Section ~~[415.3]~~ 415.6.
- g. Inside the fire district, exterior load-bearing walls of Type II buildings shall have a fire-resistance rating not less than prescribed below:

$X < 5$	2 hours
$5 \leq X < 10$	2 hours
$10 \leq X < 30$	1 hour
$X \geq 30$	As per table Table 602.
- h. Inside the fire district, exterior nonload-bearing walls of Type II buildings shall have a fire-resistance rating not less than prescribed below:

$X < 5$	As per Table 602
$5 \leq X < 10$	As per Table 602
$10 \leq X < 30$	1 hour
$X \geq 30$	As per Table 602.
- i. For special requirements for Group S aircraft hangars, see Section 412.4.1.
- j. Where Table 705.8 permits nonbearing exterior walls with unlimited area of unprotected openings, the required fire-resistance rating for the exterior walls is 0 hours.

602.1.1 Minimum requirements. A building or portion thereof shall not be required to conform to the details of a type of construction higher than that type which meets the minimum requirements based on occupancy even though certain features of such a building actually conform to a higher type of construction. Classification shall be that of the minimum requirement unless all of the requirements for the higher type of construction are met.

Exception: Portions of buildings that cantilever over an adjacent building or tax lot shall also comply with the fire-resistance ratings of Section 705.12.

602.2 Types I and II. Types I and II construction are those types of construction in which the building elements listed in Table 601 are of noncombustible materials, except as permitted in Section 603 and elsewhere in this code.

602.3 Type III. Type III construction is that type of construction in which the exterior walls are of noncombustible materials and the interior building elements are of any material permitted by this code. Fire-retardant-treated wood framing complying with Section 2303.2 shall be permitted within exterior wall assemblies of a 2-hour rating or less.

Exceptions:

1. In Group I-1, R-1, and R-2 occupancies, all exterior walls, fire walls, exit passageways, and shaft enclosures shall be noncombustible.
2. In Group F occupancies subject to Section 270(1) of the *New York State Labor Law*, all exterior wall assemblies and all structural elements shall meet the requirements for a “fireproof building” as such term is defined in Section 264 of such law.
3. Inside the fire district, exterior load-bearing walls shall be constructed of noncombustible material.
4. Inside the fire district, exterior nonload-bearing walls may be constructed with fire-retardant-treated wood complying with Section 2303.2 where the building is equipped throughout with an automatic sprinkler system in accordance with Sections 903.3.1.1 through 903.3.1.3, unless otherwise prohibited by Exception 1 or 2 above.

602.4 Type IV. Type IV construction [~~Heavy Timber, HT~~] is that type of construction in which the exterior walls are of noncombustible materials or other materials permitted by Section 602.4.1 or 602.4.2, and the interior building elements are of solid ~~or~~ wood, glue-laminated ~~wood~~ timber, heavy timber (HT), structural composite lumber (SCL), or cross-laminated timber (CLT) without concealed spaces. The minimum dimensions for permitted materials including solid timber, glued-laminated timber, SCL, and CLT and details of Type IV construction shall comply with the provisions of Section 2304.11 and this section. ~~[Fire retardant treated wood framing complying with Section 2303.2 shall be permitted within exterior wall assemblies with a 2-hour rating or less. Minimum solid sawn nominal dimensions are required for structures built using Type IV construction (HT). For glued laminated members the equivalent net finished width and depths corresponding to the minimum nominal width and depths of solid sawn lumber are required as specified in Table 602.4.]~~ Interior walls and partitions not less than 1-hour fire-resistance rating or heavy timber complying with Section 2304.11.2.2 shall be permitted. Buildings of Type IV construction utilizing SCL or CLT shall be equipped throughout with an automatic sprinkler system where required by Section 903.2.13. In buildings of Type IV construction utilizing SCL or CLT, a fire watch shall be maintained in accordance with Section 901.7.2 of the *New York City Fire Code* and Section 3303.3 of this code.

Exceptions:

1. In Group I-1, R-1, and R-2 occupancies, all exterior walls, fire walls, exit passageways, and shaft enclosures shall be noncombustible.
2. In Group F occupancies subject to Section 270(1) of the *New York State Labor Law*, all exterior wall assemblies and all structural elements shall meet the requirements for a "fireproof building" as defined in Section 264 of such law.
3. Inside the fire district, exterior load-bearing walls shall be constructed of noncombustible material.
4. Inside the fire district, exterior non-bearing walls may be constructed with fire-retardant-treated wood complying with Section 2303.2 of this code where the building is equipped

throughout with an automatic sprinkler system in accordance with Sections 903.3.1.1 through 903.3.1.3, unless otherwise prohibited by Exception 1 or 2 above.

5. Inside the fire district, exterior non-bearing walls are permitted to be constructed with cross-laminated timber (CLT) complying with Section 602.4.2 of this code, unless otherwise prohibited by Exception 1 or 2 above.

602.4.1 Fire-retardant-treated wood in exterior walls. Fire-retardant-treated wood framing and sheathing complying with Section 2303.2 shall be permitted within exterior wall assemblies not less than 6 inches ([152] 152.4 mm) in thickness with a 2-hour rating or less.

602.4.2 Cross-laminated timber in exterior walls. Cross-laminated timber (CLT) complying with Section 2303.1.4 shall be permitted within exterior wall assemblies not less than 6 inches (152.4 mm) in thickness with a 2-hour rating or less, provided the exterior surface of the cross-laminated timber (CLT) is protected by one of the following:

1. Fire-retardant-treated wood sheathing complying with Section 2303.2 and not less than $\frac{15}{32}$ inch (11.9 mm) thick;
2. Type X gypsum board not less than $\frac{5}{8}$ inch (15.9 mm) thick; or
3. A noncombustible material.

**[TABLE 602.4
WOOD MEMBER SIZE**

MINIMUM NOMINAL SOLID SAWN SIZE		MINIMUM GLUED- LAMINATED NET SIZE	
Width, inch	Depth, inch	Width, inch	Depth, inch
8	8	6 $\frac{3}{4}$	8 $\frac{1}{4}$
6	10	5	10 $\frac{1}{2}$
6	8	5	8 $\frac{1}{4}$
6	6	5	6
4	6	3	6 $\frac{7}{8}$

For SI: 1 inch = 25.4 mm.]

~~**602.4.1 Columns.** Wood columns shall be sawn or glued laminated and shall not be less than 8 inches (203 mm) nominal in any dimension where supporting floor loads and not less than 6 inches (152 mm) nominal in width and not less than 8 inches (203 mm) nominal in depth where supporting roof and ceiling loads only. Columns shall be continuous or superimposed and connected in an approved manner.]~~

~~[602.4.2 Floor framing. Wood beams and girders shall be of sawn or glued laminated timber and shall be not less than 6 inches (152 mm) nominal in width and not less than 10 inches (254 mm) nominal in depth. Framed sawn or glued laminated timber arches, which spring from the floor line and support floor loads, shall be not less than 8 inches (203 mm) nominal in any dimension. Framed timber trusses supporting floor loads shall have members of not less than 8 inches (203 mm) nominal in any dimension.]~~

~~[602.4.3 Roof framing. Wood frame or glued laminated arches for roof construction, which spring from the floor line or from grade and do not support floor loads, shall have members not less than 6 inches (152 mm) nominal in width and have less than 8 inches (203 mm) nominal in depth for the lower half of the height and not less than 6 inches (152 mm) nominal in depth for the upper half. Framed or glued laminated arches for roof construction that spring from the top of walls or wall abutments, framed timber trusses and other roof framing, which do not support floor loads, shall have members not less than 4 inches (102 mm) nominal in width and not less than 6 inches (152 mm) nominal in depth. Spaced members shall be permitted to be composed of two or more pieces not less than 3 inches (76 mm) nominal in thickness where blocked solidly throughout their intervening spaces or where spaces are tightly closed by a continuous wood cover plate of not less than 2 inches (51 mm) nominal in thickness secured to the underside of the members. Splice plates shall be not less than 3 inches (76 mm) nominal in thickness. Where protected by approved automatic sprinklers under the roof deck, framing members shall be not less than 3 inches (76 mm) nominal in width.]~~

~~[602.4.4 Floors. Floors shall be without concealed spaces. Wood floors shall be of sawn or glued laminated planks, splined or tongue and groove, of not less than 3 inches (76 mm) nominal in thickness covered with 1 inch (25 mm) nominal dimension tongue and groove flooring, laid crosswise or diagonally, or 0.5 inch (12.7 mm) particleboard or planks not less than 4 inches (102 mm) nominal in width set on edge close together and well spiked and covered with 1 inch (25 mm) nominal dimension flooring or ¹⁵/₃₂ inch (12 mm) wood structural panel or 0.5 inch (12.7 mm) particleboard. The lumber shall be laid so that no continuous line of joints will occur except at points of support. Floors shall not extend closer than 0.5 inch (12.7 mm) to walls. Such 0.5 inch (12.7 mm) space shall be covered by a molding fastened to the wall and so arranged that it will not obstruct the swelling or shrinkage movements of the floor. Corbeling of masonry walls under the floor shall be permitted to be used in place of molding.]~~

~~[602.4.5 Roofs. Roofs shall be without concealed spaces and wood roof decks shall be sawn or glued laminated, splined or tongue and groove plank, not less than 2 inches (51 mm) nominal in thickness, 1 1/8 inch thick (32 mm) wood structural panel (exterior glue), or of planks not less than 3 inches (76 mm) nominal in width, set on edge close together and laid as required for floors. Other types of decking shall be permitted to be used if providing equivalent fire resistance and structural properties.]~~

~~[602.4.6 Partitions. Partitions shall be of solid wood construction formed by not less than two layers of 1 inch (25 mm) matched boards or laminated construction 4 inches (102 mm) thick, or of 1-hour fire resistance-rated construction.]~~

~~[602.4.7] **602.4.3 Exterior structural members.** Where a horizontal separation of 20 feet (6096 mm) or more is provided, wood columns and arches conforming to heavy timber sizes in~~

accordance with Section 2304.11 shall be permitted to be used externally~~[-except as prohibited by Section 602.4 for Occupancy Groups F, I-1, R-1 and R-2].~~

Exception: Where prohibited by Exceptions 1, 2 or 3 of Section 602.4.

602.5 Type V. Type V construction is that type of construction in which the structural elements, exterior walls and interior walls are of any materials permitted by this code. Type V construction shall not be permitted inside the fire district unless otherwise permitted by Section D105.1.

Exception: In Group F occupancies subject to Section 270(1) of the *New York State Labor Law*, all exterior wall assemblies and all structural elements shall meet the requirements for a “fireproof building” as defined in Section 264 of such law.

SECTION BC 603 COMBUSTIBLE MATERIAL IN ~~[TYPE]~~ TYPES I AND II CONSTRUCTION

603.1 Allowable materials. Combustible materials shall be permitted in buildings of Type I or II construction in the following applications and in accordance with Sections 603.1.1 through 603.1.3~~[-]~~:

1. Fire-retardant-treated wood, complying with Section 2303.2, shall be permitted in:

1.1. Nonbearing interior partitions where the required fire-resistance rating is 1 hour or less.

Exception: Public corridors and exits shall be constructed of noncombustible materials.

1.2. Roof construction as permitted in Table 601, Note b.

2. Thermal and acoustical insulation, other than foam plastics, having a flame spread index of not more than 25.

Exceptions:

1. Insulation placed between two layers of noncombustible materials without an intervening airspace shall be allowed to have a flame spread index of not more than 100.

2. Insulation installed between a finished floor and solid decking without intervening airspace shall be allowed to have a flame spread index of not more than 200.

3. Foam plastics in accordance with Chapter 26.

4. Roof coverings that have an A or B classification as defined in Section 1505.

5. Interior floor finish and floor covering materials installed in accordance with Section 804.

6. Millwork such as doors, door frames, window sashes and frames ~~[Millwork such as doors, door frames, window sashes and frames as permitted by Chapter 8].~~

7. Interior wall and ceiling finishes installed in accordance with Sections 801 and 803.

8. Trim installed in accordance with Section 806.

9. Where not installed [~~over~~] greater than 15 feet (4572 mm) above grade, show windows, nailing or furring strips and wooden bulkheads below show windows, including their frames, aprons and show cases.
10. Finish flooring installed in accordance with Section 805.
11. Partitions dividing portions of stores, offices or similar places occupied by one tenant only and [~~which~~] that do not establish a corridor serving an occupant load of 30 or more shall be permitted to be constructed of fire-retardant-treated wood, 1-hour fire-resistance-rated construction or of wood panels or similar light construction up to 6 feet (~~[1829]~~ 1828.8 mm) in height.
12. Stages and platforms constructed in accordance with Sections 410.3 and 410.4, respectively.
13. Combustible exterior wall coverings, balconies and similar projections and bay or oriel windows in accordance with Chapter 14.
14. Blocking such as for handrails, millwork, cabinets and window and door frames.
15. Light-transmitting plastics as permitted by Chapter 26.
16. Mastics and caulking materials applied to provide flexible seals between components of exterior wall construction.
17. Exterior plastic veneer installed in accordance with Section 2605.2.
18. Nailing or furring strips as permitted by Section [~~803.4~~] 803.13.
19. Heavy timber as permitted by Note c to Table 601 and Section [~~602.4.7~~] 602.4.3.
20. Aggregates, component materials and admixtures as permitted by Section 703.2.2.
21. Sprayed fire-resistant materials and intumescent and mastic fire-resistant coatings, determined on the basis of [~~fire-resistance~~] fire resistance tests in accordance with Section 703.2 and installed in accordance with Sections [~~1704.11~~] 1705.14 and [~~1704.12~~] 1705.15, respectively.[-]
22. Materials used to protect penetrations in fire-resistance-rated assemblies in accordance with Section [~~713~~] 714.
23. Materials used to protect joints in fire-resistance-rated assemblies in accordance with Section [~~714~~] 715.
24. Materials allowed in the concealed spaces of buildings of Types I and II construction in accordance with Section [~~717.5~~] 718.5.
25. Materials exposed within plenums complying with Section 602 of the *New York City Mechanical Code*.

26. Bleachers, grandstands, and folding and telescopic seating within an assembly space in accordance with Section 1029.1.1 of this code.

603.1.1 Ducts. The use of nonmetallic ducts shall be permitted [~~when~~] where installed in accordance with the limitations of the *New York City Mechanical Code*.

603.1.2 Piping. The use of combustible piping materials shall be permitted [~~when~~] where installed in accordance with the limitations of the *New York City Mechanical Code* and the *New York City Plumbing Code*.

603.1.3 Electrical. The use of electrical wiring methods with combustible insulation, tubing, raceways and related components shall be permitted [~~when~~] where installed in accordance with the limitations of the *New York City Electrical Code*.

§ 8. Chapter 7 of the New York city building code, as amended by and section 704 as added by local law number 141 for the year 2013, section 708.7 as amended by and item 12 of section 715.4.8.3 as added by local law number 17 for the year 2014, and sections 704.11, 708.12.1.3.2 and 708.13.3 and item 1 of section 716.3.3.2 as amended by local law number 51 for the year 2014, is amended to read as follows:

CHAPTER 7 FIRE AND SMOKE PROTECTION FEATURES

SECTION BC 701 GENERAL

701.1 Scope. The provisions of this chapter shall govern the materials and assemblies used for structural fire resistance and fire-resistance-rated construction separation of adjacent spaces to safeguard against the spread of fire and smoke within a building and the spread of fire to or from buildings.

701.2 Multiple use fire assemblies. Fire assemblies that serve multiple purposes in a building shall comply with all of the requirements that are applicable for each of the individual fire assemblies.

SECTION BC 702 DEFINITIONS

702.1 Definitions. The following [~~words and~~] terms [~~shall, for the purposes of this chapter, and as used elsewhere in this code, have the meanings shown herein.~~] are defined in Chapter 2:

ANNULAR SPACE. [~~The opening around the penetrating item.~~]

BUILDING ELEMENT. [~~A fundamental component of building construction, listed in Table 601, which may or may not be of fire resistance rated construction and is constructed of materials based on the building type of construction.~~]

CEILING RADIATION DAMPER. [~~A listed device installed in a ceiling membrane of a fire resistance rated floor/ceiling or roof/ceiling assembly to limit automatically the radiative heat transfer through an air inlet/outlet opening.~~]

COMBINATION FIRE/SMOKE DAMPER. [~~A listed device installed in ducts and air transfer openings designed to close automatically upon the detection of heat and resist the passage of flame and smoke. The device is installed to operate automatically, controlled by a smoke detection system, and where required, is capable of being positioned from a fire command center.~~]

CONCEALED SPACES. [~~Enclosed spaces within partitions, walls, floors, roofs, stairs, furring, pipe chases and column enclosures and other similar spaces.~~]

DAMPERS, TYPES OF. [~~See “Ceiling radiation damper,” “Combination fire/smoke damper,” “Fire damper” and “Smoke damper.”~~]

~~[DRAFT STOP. A material, device or construction installed to restrict the movement of air within open spaces of concealed areas of building components such as crawl spaces, floor/ceiling assemblies, roof/ceiling assemblies and attics.]~~ **DRAFTSTOP.**

F RATING. [~~The time period that the through penetration firestop system limits the spread of fire through the penetration when tested in accordance with ASTM E 814.~~]

FIRE BARRIER. [~~A fire resistance rated wall assembly of materials complying with Section 707 designed to restrict the spread of fire in which continuity of the fire resistance rating is maintained.~~]

FIRE DAMPER. [~~A listed device, installed in ducts and air transfer openings designed to close automatically upon detection of heat and restrict the passage of flame. Fire dampers are classified for use in either static systems that will automatically shut down in the event of a fire, or in dynamic systems that continues to operate during a fire. A dynamic fire damper is tested and rated for closure under elevated temperature airflow.~~]

FIRE DOOR. [~~The door component of a fire door assembly.~~]

FIRE DOOR ASSEMBLY. [~~Any combination of a fire door, frame, hardware, and other accessories that together, as an opening protective, provide a specific degree of fire protection to the opening.~~]

FIRE PARTITION. [~~A vertical assembly of materials complying with Section 709, designed to restrict the spread of fire in which openings are protected.~~]

FIRE PROTECTION RATING. [~~The period of time that an opening protective assembly will maintain the ability to confine a fire as determined by tests prescribed in Section 715. Ratings are stated in hours or minutes.~~]

FIRE-RATED GLAZING.

FIRE RESISTANCE. [~~That property of materials or their assemblies that prevents or retards the passage of excessive heat, hot gases or flames under conditions of use.~~]

FIRE-RESISTANCE RATING. [~~The period of time a building element, component or assembly maintains the ability to withstand fire exposure, continues to perform a given structural function, or both, as determined by the tests, or the methods based on tests, prescribed in Section 703.~~]

FIRE-RESISTANT JOINT SYSTEM. [~~An assemblage of specific materials or products that are designed, tested, and fire resistance rated in accordance with either ASTM E 1966 or UL 2079 to resist for a prescribed period of time the passage of fire through joints made in or between fire-resistance rated assemblies.~~]

FIRE SEPARATION DISTANCE. [~~The distance measured from the building face to one of the following:~~]

[~~1. The closest interior tax lot line;~~]

[~~2. To the centerline of a street, an alley or public space; or~~]

[~~3. To an imaginary line between two buildings on the same tax lot.~~]

[~~The distance shall be measured at right angles from the face of the wall.~~]

FIRE WALL. [~~A fire resistance-rated smoke-tight wall having protected openings, which restricts the spread of fire and extends continuously from the foundation to or through the roof, with sufficient structural stability under fire conditions to allow collapse of construction on either side without collapse of the wall.~~]

FIRE WINDOW ASSEMBLY. [~~A window, as an opening protective, constructed and glazed to give protection against the passage of fire, smoke and hot gases.~~]

FIREBLOCKING. [~~A building material or materials approved for use as fireblocking to resist the free passage of flame or hot gases to other areas of the building through concealed spaces.~~]

FIRESTOPPING. [~~A through-penetration firestop or a membrane penetration firestop.~~]

FLOOR FIRE DOOR ASSEMBLY. [~~A combination of a fire door, a frame, hardware and other accessories installed, as an opening protective, in a horizontal plane, which together provide a specific degree of fire protection to a through opening in a fire-resistance-rated floor (see Section 712.8).~~]

HORIZONTAL ASSEMBLY. [~~A fire-resistance-rated floor or roof assembly of materials designed to restrict the spread of fire in which continuity of the fire-resistance rating is maintained.~~]

JOINT.

L RATING.

MEMBRANE PENETRATION. [~~An opening made through one side (wall, floor or ceiling membrane) of an assembly.~~]

MEMBRANE PENETRATION FIRESTOP. [~~A material, device, or assemblage of specific materials or products that is designed, tested and fire resistance rated to resist for a prescribed time period the passage of flame and heat through openings in a protective membrane in order to accommodate cables, cable trays, conduit, tubing, pipes or similar items.~~]

MEMBRANE-PENETRATION FIRESTOP SYSTEM.

MINERAL FIBER. [~~Insulation composed principally of fibers manufactured from rock, slag or glass, with or without binders.~~]

MINERAL WOOL. [~~Synthetic vitreous fiber insulation made by melting predominantly igneous rock or furnace slag, and other inorganic materials, and then physically forming the melt into fibers.~~]

PENETRATION FIRESTOP. [~~A through penetration firestop or a membrane penetration firestop.~~]

SELF-CLOSING. [~~As applied to a fire door or other opening, means equipped with an approved device that will ensure closing after having been opened.~~]

SHAFT. [~~An enclosed space extending through one or more stories of a building, connecting vertical openings in successive floors, or floors and roof.~~]

SHAFT ENCLOSURE. [~~The walls or construction forming the boundaries of a shaft.~~]

SMOKE BARRIER. [~~A continuous membrane, either vertical or horizontal, such as a wall, floor, or ceiling assembly, that is designed and constructed in accordance with Section 710 to restrict the movement of smoke.~~]

SMOKE COMPARTMENT. [~~A space within a building enclosed by smoke barriers on all sides, including the top and bottom.~~]

SMOKE DAMPER. [~~A listed device installed in ducts and air transfer openings that is designed to resist the passage of air and smoke. The device is installed to operate automatically, controlled by a smoke detection system, and where required, is capable of being positioned from a fire command center.~~]

SMOKE PARTITION. [~~A continuous vertical assembly that is designed and constructed to restrict the movement of smoke and is not generally required to have a fire resistance rating in accordance with Section 711.~~]

SPLICE.

T RATING. [~~The time period that the penetration firestop system, including the penetrating item, limits the maximum temperature rise to 325°F (163°C) above its initial temperature through the penetration on the nonfire side when tested in accordance with ASTM E 814.~~]

~~[THROUGH PENETRATION. An opening that passes through an entire assembly.]~~

THROUGH-PENETRATION.

~~**THROUGH-PENETRATION FIRESTOP SYSTEM.** [An assemblage of specific materials or products that are designed, tested and fire resistance rated to resist for a prescribed period of time the spread of fire through penetrations. The F and T rating criteria for penetration firestop systems shall be in accordance with ASTM E 814 or UL 1479. See definitions of “F rating” and “T rating.”]~~

SECTION BC 703 FIRE-RESISTANCE RATINGS AND FIRE TESTS

703.1 Scope. Materials prescribed herein for fire resistance shall conform to the requirements of this chapter.

703.2 Fire-resistance ratings. The fire-resistance rating of building elements, components or assemblies shall be determined in accordance with the test procedures set forth in ASTM E 119 or UL 263 or in accordance with Section 703.3. ~~[Where materials, systems or devices that have not been tested as part of a fire resistance rated assembly are incorporated into the building element component or assembly, sufficient data shall be made available to the commissioner to show that the required fire resistance rating is not reduced. Materials and methods of construction used to protect joints and penetrations in fire resistance rated building elements, components or assemblies shall not reduce the required fire resistance rating.]~~ The fire-resistance rating of penetrations and fire-resistant joint systems shall be determined in accordance with Sections 714 and 715, respectively.

~~**[Exception:** In determining the fire resistance rating of exterior bearing walls, compliance with the ASTM E 119 or UL 263 criteria for unexposed surface temperature rise and ignition of cotton waste due to passage of flame or gases is required only for a period of time corresponding to the required fire resistance rating of an exterior nonbearing wall with the same fire separation distance, and in a building of the same group. When the fire resistance rating determined in accordance with this exception exceeds the fire resistance rating determined in accordance with ASTM E 119 or UL 263, the fire exposure time period, water pressure, and application duration criteria for the hose stream test of ASTM E 119 or UL 263 shall be based upon the fire resistance rating determined in accordance with this exception.]~~

703.2.1 Nonsymmetrical wall construction. Interior walls and partitions of nonsymmetrical construction shall be tested with both faces exposed to the furnace, and the assigned fire-resistance rating shall be the shortest duration obtained from the two tests conducted in compliance with ASTM E 119 or UL 263. Where evidence is furnished to show that the wall was tested with the least fire-resistant side exposed to the furnace, subject to acceptance of the commissioner, the wall need not be subjected to tests from the opposite side (see Section 705.5 of this code for exterior walls).

703.2.2 Combustible components. Combustible aggregates may be integrated with other materials to form a noncombustible material provided that the entire mixture, in the form in which it is to be used in construction, meets the requirement of this code for noncombustible construction.

703.2.3 Restrained classification. Fire-resistance-rated assemblies tested under ASTM E 119 or UL 263 shall not be considered to be restrained unless evidence satisfactory to the commissioner is furnished by the registered design professional showing that the construction qualifies for a restrained classification in accordance with ASTM E 119 or UL 263. Restrained construction shall be identified on the ~~[plans]~~ construction documents.

703.2.4 Supplemental features. Where materials, systems or devices that have not been tested as part of a fire-resistance-rated assembly are incorporated into the building element component or assembly, sufficient data shall be made available to the commissioner to show that the required fire-resistance rating is not reduced. Materials and methods of construction used to protect joints and penetrations in fire-resistance-rated building elements, components or assemblies shall not reduce the required fire-resistance rating.

703.2.5 Exterior bearing walls. In determining the fire-resistance rating of exterior bearing walls, compliance with the ASTM E 119 or UL 263 criteria for unexposed surface temperature rise and ignition of cotton waste due to passage of flame or gases is required only for a period of time corresponding to the required fire-resistance rating of an exterior nonbearing wall with the same fire separation distance, and in a building of the same group. Where the fire-resistance rating, determined in accordance with this section, exceeds the fire-resistance rating determined in accordance with ASTM E 119 or UL 263, the fire exposure time period, water pressure and application duration criteria for the hose stream test of ASTM E 119 or UL 263 shall be based on the fire-resistance rating determined in accordance with this section.

703.3 ~~[Alternative methods]~~ Methods for determining fire resistance. The application of any of the ~~[alternative]~~ methods listed in this section shall be based on the fire exposure and acceptance criteria specified in ASTM E 119 or UL 263. The required fire resistance of a building element, component or assembly shall be permitted to be established by any of the following methods or procedures:

1. Fire-resistance designs documented in approved sources.
2. Prescriptive designs of fire-resistance-rated building elements, components or assemblies as prescribed in Section ~~[720]~~ 721 of this code.
3. Calculations in accordance with Section ~~[721]~~ 722 of this code.
4. Engineering analysis based on a comparison of building element, component or assemblies designs having fire-resistance ratings as determined by the test procedures set forth in ASTM E 119 or UL 263.
5. Alternative protection methods as allowed by rules of the department.

703.4 ~~[Noncombustibility tests.]~~ Automatic sprinklers. Under the prescriptive fire-resistance requirements of this code, the fire-resistance rating of a building element, component or assembly shall be established without the use of automatic sprinklers or any other fire suppression system being incorporated as part of the assembly tested in accordance with the fire exposure, procedures and acceptance criteria specified in ASTM E 119 or UL 263. However, this section shall not prohibit or

limit the duties and powers of the commissioner as allowed by Sections 28-103.1.3 and 28-103.3 of Administrative Code.

703.5 Noncombustibility tests. The tests indicated in Sections ~~[703.4.1 and 703.4.2]~~ 703.5.1 and 703.5.2 shall serve as criteria for acceptance of building materials as set forth in Sections 602.2, 602.3 and 602.4 in Type I, II, III and IV construction. The term “noncombustible” does not apply to the flame spread characteristics of interior finish or trim materials. A material shall not be classified as a noncombustible building construction material if it is subject to an increase in combustibility or flame spread beyond the limitations herein established through the effects of age, fabrication or erection techniques, moisture or other atmospheric conditions.

~~[703.4.1]~~ **703.5.1 Elementary materials.** Materials required to be noncombustible shall be tested in accordance with ASTM E 136.

~~[703.4.2]~~ **703.5.2 Composite materials.** Materials having a structural base of noncombustible material as determined in accordance with Section ~~[703.4.1]~~ 703.5.1 of this code with a surfacing not more than 0.125 inch (3.18 mm) thick that has a flame spread index not greater than 50 when tested in accordance with ASTM E 84 or UL 723 shall be acceptable as noncombustible materials.

~~[703.5]~~ **703.6 Fire-resistance-rated glazing.** Fire-resistance-rated glazing, when tested in accordance with ASTM E 119 or UL 263 and complying with the requirements of Section 707 of this code, shall be permitted. Fire-resistance-rated glazing shall bear a label ~~[or other identification showing the name of the manufacturer, the test standard and the identifier “W XXX,” where the “XXX” is the fire resistance rating in minutes. Such label or identification shall be]~~ marked in accordance with Table 716.3 of this code and issued by an approved agency [and] that shall be permanently [affixed to] identified on the glazing.

~~[703.6]~~ **703.7 Marking and identification.** ~~[Fire] Where there is a concealed floor, floor-ceiling or attic space, fire walls, fire barriers, fire partitions, smoke barriers and smoke partitions or any other wall required to have protected openings or penetrations shall be effectively and permanently identified with signs or stenciling in the concealed space. Such identification shall [be located in accessible concealed floor, floor-ceiling or attic spaces; and]:~~

1. Be ~~[repeated]~~ located within 15 feet (4572 mm) of the end of each wall and at intervals not exceeding 30 feet [(914 mm)] (9144 mm) measured horizontally along the wall or partition[; and].
2. Include lettering not less than ~~[0.5 inch (12.7 mm)]~~ 3 inches (76.2 mm) in height[;] with a minimum ³/₈-inch (9.5 mm) stroke in a contrasting color incorporating the suggested wording[;], “FIRE AND/OR SMOKE BARRIER—PROTECT ALL OPENINGS.”

~~[Exception: Walls in Group R-2 occupancies that do not have a removable decorative ceiling allowing access to the concealed space.]~~

SECTION BC 704
FIRE-RESISTANCE RATING OF
STRUCTURAL MEMBERS

704.1 Requirements. The fire-resistance ratings of structural members and assemblies shall comply with this section and the requirements for the type of construction as specified in Table 601. The fire-resistance ratings shall be not ~~[be]~~ less than the ratings required for the fire-resistance-rated assemblies supported by the structural members.

Exception: Fire barriers, fire partitions, smoke barriers and horizontal assemblies as provided in Sections 707.5, ~~[709.4, 710.4]~~ 708.4 and ~~[712.4]~~ 711.2, respectively.

704.2 Column protection. Where columns are required to ~~[be]~~ have protection to achieve a fire-resistance ~~[rated]~~ rating, the entire column shall be provided individual encasement protection by protecting it on all sides for the full column ~~[length]~~ height, including connections to other structural members, with materials having the required fire-resistance rating. Where the column extends through a ceiling, the encasement protection shall be continuous from the top of the foundation or floor/ceiling assembly below through the ceiling space to the top of the column.

704.3 Protection of the primary structural frame other than columns. Members of the primary structural frame other than columns that are required to have protection to achieve a fire-resistance rating and support more than one floor or one floor and roof, or support a load-bearing wall or a nonload-bearing wall more than one story high, shall be provided individual encasement protection by protecting them on all sides for ~~[their]~~ the full length, including connections to other structural members, with materials having the required fire-resistance rating.

Exception: Individual encasement protection may be omitted on those exposed sides where the extent of protection is in accordance with the required fire-resistance rating, as determined in Section 703.

704.4 Protection of secondary members. Secondary members that are required to have protection to achieve a fire-resistance rating shall be protected by individual encasement protection~~[, by the membrane or ceiling of a horizontal assembly in accordance with Section 712, or by a combination of both]~~.

704.4.1 Light-frame construction. ~~[King studs]~~ Studs and boundary elements that are integral elements in load-bearing walls of light-frame construction shall be permitted to have required fire-resistance ratings provided by the membrane protection provided for the load-bearing wall.

704.4.2 Horizontal assemblies. Horizontal assemblies are permitted to be protected with a membrane or ceiling where the membrane or ceiling provides the required fire-resistance rating and is installed in accordance with Section 711.

704.5 Truss protection. The required thickness and construction of fire-resistance-rated assemblies enclosing trusses shall be based on the results of full-scale tests or combinations of tests on truss components or on approved calculations based on such tests that satisfactorily demonstrate that the assembly has the required fire resistance.

704.6 Attachments to structural members. The edges of lugs, brackets, rivets and bolt heads attached to structural members shall be protected to the highest required fire-resistance rating of the members connected.

704.7 Reinforcing. Thickness of protection for concrete or masonry reinforcement shall be measured to the outside of the reinforcement, including stirrups, ties and spiral reinforcing ties.

704.8 Embedments and enclosures. Pipes, wires, conduits, ducts or other service facilities shall not be embedded in the required fire ~~[protection]~~ protective covering of a structural member that is required to be individually encased.

Exception: Pipes, wires, and conduits may be installed in the space between the required fire protection and the structural member protected, provided that where such facilities pierce the required fire protection:

1. ~~[the]~~ The area of the penetration does not exceed two percent of the area of the fire protection on any one face,
2. ~~[the]~~ The penetrations are closed off with close-fitting metal escutcheons or plates, and
3. ~~[the]~~ The concealed space is firestopped at each story.

704.9 Impact protection. Where the fire protective covering of a structural member is subject to impact damage from moving vehicles, the handling of merchandise or other activity, the fire protective covering shall be protected by corner guards or by a substantial jacket of metal or other noncombustible material to a height adequate to provide full protection, but not less than 5 feet (1524 mm) from the finished floor.

Exception: Corner protection is not required on concrete columns in open or enclosed parking garages.

704.10 Exterior structural members. Load-bearing structural members located within the exterior walls, or exposed to the outside of a building or structure shall be provided with the highest fire-resistance rating as determined in accordance with the following:

1. As required by Table 601 for the type of building element based on the type of construction of the building;
2. As required by Table 601 for exterior bearing walls based on the type of construction; and
3. As required by Table 602 for exterior walls based on the fire separation distance.

704.11 ~~[Lintel protection. Lintels over openings wider than 4 feet (1219 mm) in masonry walls, other than in walls of masonry veneer on wood frame structures, shall be fire protected as required by Section 704.3 when the full load over the opening is not relieved by a masonry arch of required strength.]~~

[Exceptions:]

~~[1. The members of an assembled metal lintel that support only outer face masonry that is securely bonded or anchored to backing need not be fire protected, provided that the inner members of the assembly support the full load imposed.]~~

~~[2. The use of stone lintels in spans exceeding 4 feet (1219 mm) shall not be permitted unless supplemented by fire-protected structural members or masonry arches of the required strength to support the superimposed loads.]~~

Bottom flange protection. Fire protection is not required at the bottom flange of lintels, shelf angles and plates spanning not more than 6 feet 4 inches (1930.4 mm), whether part of the primary structural frame or not, and from the bottom flange of lintels, shelf angles and plates not part of the structural frame, regardless of span.

704.12 Seismic isolation systems. Fire-resistance ratings for the isolation system shall meet the fire-resistance rating required for the columns, walls or other structural elements in which the isolation system is installed in accordance with Table 601 of this code. Isolation systems required to have a fire-resistance rating shall be protected with approved materials or construction assemblies designed to provide the same degree of fire resistance as the structural element in which ~~[it]~~ the system is installed when tested in accordance with ASTM E 119 or UL 263 (see Section 703.2 of this code).

Such isolation system protection applied to isolator units shall be capable of retarding the transfer of heat to the isolator unit in such a manner that the required gravity load-carrying capacity of the isolator unit will not be impaired after exposure to the standard time-temperature curve fire test prescribed in ASTM E 119 or UL 263 for a duration not less than that required for the fire-resistance rating of the structure element in which ~~[it]~~ the system is installed.

Such isolation system protection applied to isolator units shall be suitably designed and securely installed so as not to dislodge, loosen, sustain damage or otherwise impair its ability to accommodate the seismic movements for which the isolator unit is designed and to maintain its integrity for the purpose of providing the required fire-resistance protection.

704.13 Sprayed fire-resistant materials (SFRM). Sprayed fire-resistant materials (SFRM) shall comply with Sections 704.13.1 through 704.13.5.

704.13.1 Fire-resistance rating. The application of SFRM shall be consistent with the fire-resistance rating and the listing, including, but not limited to, minimum thickness and dry density of the applied SFRM, method of application, substrate surface conditions and the use of bonding adhesives, sealants, reinforcing or other materials.

704.13.2 Manufacturer's installation instructions. The application of SFRM shall be in accordance with the manufacturer's installation instructions. The instructions shall include, but are not limited to, substrate temperatures and surface conditions and SFRM handling, storage, mixing, conveyance, method of application, curing and ventilation.

704.13.3 Substrate condition. The SFRM shall be applied to a substrate in compliance with Sections 704.13.3.1 through 704.13.3.2.

704.13.3.1 Surface conditions. Substrates to receive SFRM shall be free of dirt, oil, grease, release agents, loose scale and any other condition that prevents adhesion. The substrates shall ~~[also]~~ be free of primers, paints and encapsulants other than those fire tested and listed by a nationally recognized testing agency. Primed, painted or encapsulated steel shall be allowed, provided that testing has demonstrated that required adhesion is maintained.

704.13.3.2 Primers, paints and encapsulants. Where the SFRM is to be applied over primers, paints or encapsulants other than those specified in the listing, the material shall be field tested in accordance with ASTM E 736. Where testing of the SFRM with primers, paints or encapsulants demonstrates that required adhesion is maintained, SFRM shall be permitted to be applied to primed, painted or encapsulated wide flange steel shapes subject to the following conditions:

1. The beam flange width of such shape may not exceed 12 inches (~~[305]~~ 304.8 mm);
2. The column flange width of such shape may not exceed 16 inches (~~[400]~~ 406.4 mm);
3. The beam or column web depth of such shape may not exceed 16 inches (~~[400]~~ 406.4 mm); and
4. The average and minimum bond strength values shall be determined based on a minimum of five bond tests conducted in accordance with ASTM E 736. Bond tests conducted in accordance with ASTM E 736 shall indicate ~~[a minimum]~~ an average bond strength of not less than 80 percent and ~~[a minimum]~~ an individual bond strength of not less than 50 percent, when compared to the bond strength of the SFRM as applied to clean uncoated ~~[1/8-inch-thick]~~ 1/8-inch (~~[3-mm]~~) (3.2 mm) thick steel plate.

704.13.4 Temperature. A minimum ambient and substrate temperature of 40°F (4.44°C) shall be maintained during and for ~~[a minimum of]~~ not fewer than 24 hours after the application of the SFRM, unless the manufacturer's ~~[installation]~~ instructions allow otherwise.

704.13.5 Finished condition. The finished condition of SFRM applied to structural members or assemblies shall not, upon complete drying or curing, exhibit cracks, voids, spalls, delamination or any exposure of the substrate. Surface irregularities of SFRM shall be deemed acceptable.

704.14 Fire retardant or intumescent coatings on mass timber. Fire retardant or intumescent coatings shall not be used to achieve the required fire-resistance rating on structural elements composed of heavy timber members including, but not limited to, glued-laminated members, cross laminated timber (CLT) or structural composite lumber (SCL).

SECTION BC 705 EXTERIOR WALLS

705.1 General. Exterior walls shall comply with this section. Exterior wall construction shall comply with the provisions of Chapter 14 and Appendix D where applicable.

705.2 Projections. Cornices, eave overhangs, exterior balconies and similar projections, including but not limited to, fascias, belt courses, pilasters, surrounds, gutters, leaders, half-timber work,

shutters, and trellises, ~~[which extend]~~ extending beyond the exterior wall shall conform to the requirements of this section and Section 1406, provided that any such projection, if removed, altered or destroyed, will not reduce the structural stability of the building enclosure, and that such projection is installed so as not to reduce the required fire-resistance rating of the building enclosure. Exterior egress balconies and exterior exit stairways and ramps shall comply with the requirements of this section and Sections ~~[4019]~~ 1021 and ~~[4026]~~ 1027, respectively. Projections shall not extend ~~[beyond the]~~ any closer to the line used to determine the fire separation distance ~~[determined by the following three methods, whichever results]~~ than shown in ~~[the lesser projection:]~~ Table 705.2. Exterior wall coverings and cladding at exterior balconies and similar projections shall comply with Section 1406.3.

- ~~[1. A point one third the distance from the exterior face of the wall to the tax lot line where protected openings or a combination of protected and unprotected openings are required in.]~~
- ~~[2. A point one half the distance from the exterior face of the wall to the tax lot line where all openings in the exterior wall are permitted to be unprotected or the building is equipped throughout with an automatic sprinkler system installed under the provisions of Section 705.8.2.]~~
- ~~[3. More than 12 inches (305 mm) into areas where openings are prohibited.]~~

Exception[-]: Buildings on the same tax lot and considered as portions of one building in accordance with Section 705.3 are not required to comply with this section.

**TABLE 705.2
MINIMUM SETBACK DISTANCE OF PROJECTION**

<u>FIRE SEPARATION DISTANCE (FSD)^a</u>	<u>MINIMUM DISTANCE FROM LINE USED TO DETERMINE FSD</u>
0 feet to 2 feet	Projections not permitted
Greater than 2 feet to less than or equal to 3 feet	24 inches
Greater than 3 feet to less than 30 feet	24 inches plus 8 inches for every foot of FSD beyond 3 feet or fraction thereof
30 feet or greater	20 feet

For SI: 1 foot = 304.8 mm; 1 inch = 25.4 mm.
a. Distance to be measured from the lot line, or lot line equivalent to the exterior wall.

705.2.1 Type I and II construction. Projections from walls, including balconies on the exterior of buildings of Type I or II construction shall be of noncombustible materials.

705.2.2 Type III, IV or V construction. Projections from walls of Type III, IV or V construction shall be of any approved material. Projections located where openings are not permitted or where protection of openings is required shall be constructed of the following:

~~**705.2.2 Combustible projections.** Combustible projections located where openings are not permitted or where protection of openings is required shall be of at least 1-hour fire-resistance-rated construction, Type IV construction, fire-retardant treated wood or as required by Section 1406.3-]~~

1. Noncombustible materials.

2. Combustible materials of not less than 1 hour fire-resistant-rated construction.
3. Heavy timber construction complying with Section 2304.11.
4. Fire-retardant treated wood.
5. As permitted by Section 705.2.2.1.

705.2.2.1 Exterior balconies and similar projections. Exterior balconies and similar projections shall be permitted to be constructed of combustible materials provided that the exterior balcony or similar projection affords the fire-resistance rating required by Table 601 for floor construction.

Exceptions: Balconies or similar projections serving as a required exit shall not be constructed of combustible materials.

705.3 Buildings on the same tax lot. For the purposes of determining the required wall and opening protection, projections and roof-covering requirements, buildings on the same tax lot shall be assumed to have an imaginary line between them.

[Exception:] Exceptions:

1. Two or more buildings on the same tax lot shall be either [be] regulated as separate buildings or shall be considered as portions of one building if the aggregate area of such buildings is within the limits specified in Chapter 5 for a single building. Where the buildings contain different occupancy groups or are of different types of construction, the area shall be that allowed for the most restrictive occupancy or construction.
2. Where an S-2 parking garage of Construction Type I or IIA is erected on the same lot as a Group R-2 building, and there is no fire separation distance between these buildings, then the adjoining exterior walls between the buildings are permitted to have occupant use openings in accordance with Section 706.8. However, opening protectives in such openings shall only be required in the exterior wall of the S-2 parking garage, not in the exterior wall openings in the R-2 building, and these opening protectives in the exterior wall of the S-2 parking garage shall be not less than 1¹/₂-hour fire protection rating.

705.4 Materials. Exterior walls shall be of materials permitted by the building type of construction.

705.5 Fire-resistance ratings. Exterior walls shall be fire-resistance-rated in accordance with Tables 601[;] and 602[;] and Appendix D where applicable. The required fire-resistance rating of exterior walls with a [~~fire separation~~] fire separation distance of greater than 10 feet (3048 mm) shall be rated for exposure to fire from the inside. The required fire-resistance rating of exterior walls with a fire separation distance of less than or equal to 10 feet (3048 mm) shall be rated for exposure to fire from both sides.

705.6 Structural stability. [~~The wall shall extend to the height required by Section 705.11 and shall have sufficient structural stability such that it will remain in place for the duration of time indicated by the required fire-resistance rating.~~] Exterior walls shall extend to the height required by Section 705.11. Interior structural elements that brace the exterior wall but that are not located within the

plane of the exterior wall shall have the minimum fire-resistance rating required in Table 601 for that structural element. Structural elements that brace the exterior wall but are located outside of the exterior wall or wholly or partly within the plane of the exterior wall shall have the minimum fire-resistance rating required in Tables 601 and 602 for the exterior wall.

705.7 Unexposed surface temperature. Where protected openings are not limited by Section 705.8, the limitation on the rise of temperature on the unexposed surface of exterior walls as required by ASTM E 119 or UL 263 shall not apply. Where protected openings are limited by Section 705.8 of this code, the limitation on the rise of temperature on the unexposed surface of exterior walls as required by ASTM E 119 or UL 263 shall not apply provided that a correction is made for radiation from the unexposed exterior wall surface in accordance with the following formula:

$$A_e = A + (A_f \times F_{eo}) \tag{Equation 7-1}$$

where:

A_e = Equivalent area of protected openings.

A = Actual area of protected openings.

A_f = Area of exterior wall surface in the story under consideration exclusive of openings, on which the temperature limitations of ASTM E 119 or UL 263 for walls are exceeded.

F_{eo} = An “equivalent opening factor” derived from Figure 705.7 based on the average temperature of the unexposed wall surface and the fire-resistance rating of the wall.

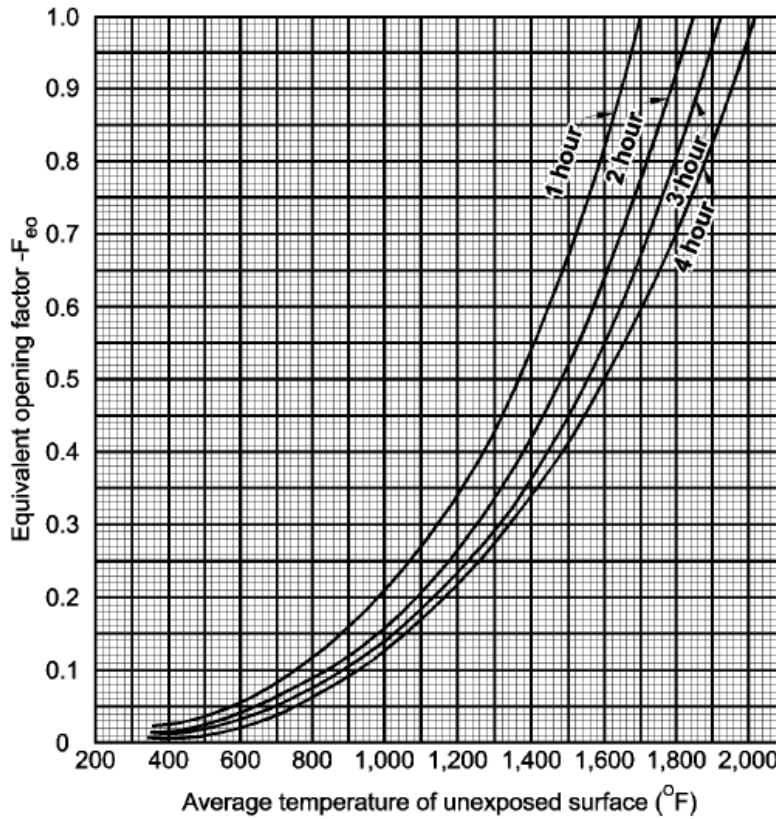

For SI: °C = ((°F) - 32) / 1.8.

FIGURE 705.7

EQUIVALENT OPENING FACTOR

705.8 Openings. Openings in exterior walls shall comply with Sections 705.8.1 through ~~705.8.7~~ 705.8.6.

**TABLE 705.8
MAXIMUM AREA OF EXTERIOR WALL OPENINGS BASED ON FIRE SEPARATION DISTANCE AND
DEGREE OF OPENING PROTECTION^m**

FIRE SEPARATION DISTANCE (feet)	DEGREE OF OPENING PROTECTION	ALLOWABLE AREA^a
0 to less than 3 ^{b,c}	Unprotected, Nonsprinklered (UP, NS)	Not Permitted
	Unprotected, Sprinklered (UP, S) ⁱ	Not Permitted
	Protected (P)	Not Permitted ^{j,k}
3 to less than 5 ^{d,e}	Unprotected, Nonsprinklered (UP, NS)	Not Permitted
	Unprotected, Sprinklered (UP, S) ⁱ	15%
	Protected (P)	15% ^l
5 to less than 10 ^{e,f,g}	Unprotected, Nonsprinklered (UP, NS)	10% ^h
	Unprotected, Sprinklered (UP, S) ⁱ	25%
	Protected (P)	25% ^l
10 to less than 15 ^{e,f,g,n}	Unprotected, Nonsprinklered (UP, NS)	15% ^h
	Unprotected, Sprinklered (UP, S) ⁱ	45%
	Protected (P)	45% ^l
15 to less than 20 ^{f,g,n}	Unprotected, Nonsprinklered (UP, NS)	25%
	Unprotected, Sprinklered (UP, S) ⁱ	75%
	Protected (P)	75% ^l
20 to less than 25 ^{f,g,n}	Unprotected, Nonsprinklered (UP, NS)	45%
	Unprotected, Sprinklered (UP, S) ⁱ	No Limit
	Protected (P)	No Limit ^l
25 to less than 30 ^{f,g,n}	Unprotected, Nonsprinklered (UP, NS)	70%
	Unprotected, Sprinklered (UP, S) ⁱ	No Limit
	Protected (P)	No Limit ^l
30 or greater	Unprotected, Nonsprinklered (UP, NS)	No Limit
	Unprotected, Sprinklered (UP, S) ⁱ	[Not Required] No Limit
	Protected (P)	[Not Required] No Limit

For SI: 1 foot = 304.8 mm.

UP, NS = Unprotected openings in buildings not equipped throughout with an automatic sprinkler system in accordance with Section 903.3.1.1.

UP, S = Unprotected openings in buildings equipped throughout with an automatic sprinkler system in accordance with Section 903.3.1.1.

P = Openings protected with an opening protective assembly in accordance with Section 705.8.2.

- a. Values indicated are the percentage of the area of the exterior wall, per story.
- b. For the requirements for fire walls of buildings with differing heights, see Section 706.6.
- c. For openings in a fire wall for buildings on the same tax lot, see Section 706.8.
- d. The maximum percentage of unprotected and protected openings shall be 25 percent for Group R-3 occupancies.

- e. Unprotected openings shall not be permitted for openings with a fire separation distance of less than 15 feet for Group H-2 and H-3 occupancies.
- f. The area of unprotected and protected openings for Group R-3 occupancies shall ~~not be limited for Group R-3 occupancies, as applicable in Section 101.2,~~ have no limit, if provided with a fire separation distance of 5 feet or ~~more~~ greater.
- g. The area of openings in an open parking structure, with a fire separation distance of 10 feet or greater, shall ~~not be limited~~ have no limit.
- h. Includes buildings accessory to Group R-3.
- i. Not applicable to Group H-1, H-2 and H-3 occupancies.
- j. Protected openings through a wall or walls between buildings shall comply with Section 705.8.
- k. Protected openings within a fire separation distance of 3 feet or less are permitted for Occupancy Groups R-2 and R-3 provided such openings do not exceed 10 percent of the area of the façade of the story in which they are located. These openings shall not be credited towards meeting any mandatory natural light or ventilation requirements unless they also comply with applicable provisions of Chapter 12 and the Zoning Resolution.
- l. In Group R-2 and R-3 occupancies with an exterior separation distance greater than 3 feet, openings shall be in accordance with percentages indicated as “Protected Classification of Opening” in Table 705.8. However, such openings shall not be required to be protected.
- m. Upon special application, the commissioner may permit exterior wall openings to be constructed in excess of the permitted area established by Table 705.8 provided that such openings are protected and provided that at the time of their construction they are located at least 60 feet in a direct line, measured at any angle, including vertically and horizontally, from any neighboring building, unless otherwise permitted by Section 705.3 for buildings on the same tax lot. The construction ~~class~~ type of the neighboring building shall not be factored into the measurement of the distance between the openings and adjoining building. If any neighboring building is later altered or constructed to come within the above distance limitation, the affected exterior openings shall immediately be closed with construction meeting the fire-resistance[-] rating requirements for exterior wall construction of the building in which they are located. Such additional openings shall not be credited toward meeting any of the mandatory natural light or ventilation requirements unless they also comply with applicable provisions of ~~Chapter 12 and~~ the *New York City Zoning Resolution and Chapter 12 of this code*.
- n. ~~The area of openings in a building containing only a Group U occupancy private garage or carport, with a fire separation distance of 5 feet (1524 mm) or greater, shall have no limit.~~

705.8.1 Allowable area of openings. The maximum area of unprotected and protected openings permitted in an exterior wall in any story of a building shall not exceed the percentages specified in Table 705.8.

Exceptions:

1. In other than Group H occupancies, unlimited unprotected openings are permitted in the first story above grade plane either:
 - 1.1. Where the wall faces a street and has a fire separation distance of more than 15 feet (4572 mm); or
 - 1.2. Where the wall faces an unoccupied space, the unoccupied space shall be on the same tax lot or dedicated for public use, shall be not ~~be~~ less than 30 feet (9144 mm) in width and shall have access from a street by a posted fire lane in accordance with the *New York City Fire Code*.
2. Buildings whose exterior bearing walls, exterior nonbearing walls and exterior primary structural frame are not required to be fire-resistance-rated shall be permitted to have unlimited unprotected openings.

705.8.2 Protected openings. Where openings are required to be protected, fire doors and fire shutters shall comply with Section ~~[715.4]~~ 716.5 and fire window assemblies shall comply with Section ~~[715.5]~~ 716.6.

Exception: Opening protectives are not required where the building is equipped throughout with an automatic sprinkler system in accordance with Section 903.3.1.1 and the exterior openings are protected by a water curtain using automatic sprinklers approved for that use. The sprinklers and the water curtain shall be installed in accordance with NFPA 13, as modified ~~by~~ Appendix Q of this code.

705.8.3 Unprotected openings. Where unprotected openings are permitted, windows and doors shall be constructed of any approved materials. Glazing shall conform to the requirements of Chapters 24 and 26.

705.8.4 Mixed openings. Where both unprotected and protected openings are located in the exterior wall in any story of a building, the total area of the openings shall be determined in accordance with the following formula:

$$\frac{[(A_p/a_p) + (A_u/a_u)]}{(A_p/a_p) + (A_u/a_u)} \leq 1 \quad \text{(Equation 7-2)}$$

where:

A_p = Actual area of protected openings, or the equivalent area of protected openings, A_e (see Section 705.7).

a_p = Allowable area of protected openings.

A_u = Actual area of unprotected openings.

a_u = Allowable area of unprotected openings.

705.8.5 Vertical separation of openings. Openings in exterior walls in adjacent stories shall be separated vertically to protect against fire spread on the exterior of the buildings where the openings are within 5 feet (1524 mm) of each other horizontally. Such openings shall be separated vertically [~~at least~~] not less than 3 feet ([914] 914.4 mm) by spandrel girders, exterior walls or other similar assemblies that have a fire-resistance rating of [~~at least~~] not less than 1 hour, rated for exposure to fire from both sides, or by flame barriers that extend horizontally [~~at least~~] not less than 30 inches (762 mm) beyond the exterior wall and that are at least as wide as the opening. Flame barriers shall [~~also~~] have a fire-resistance rating of [~~at least~~] not less than 1 hour. The unexposed surface temperature limitations specified in ASTM E 119 or UL 263 shall not apply to the flame barriers or vertical separation unless otherwise required by the provisions of this code. Where a curtain wall assembly is used on the exterior wall, the intersection between the floor assembly and curtain wall assembly shall be protected in accordance with Section 713.4 of this code.

Exceptions:

1. This section shall not apply to buildings that are three stories or less above grade plane.
2. This section shall not apply to buildings equipped throughout with an automatic sprinkler system in accordance with Section 903.3.1.1 or 903.3.1.2.
3. This section shall not apply to open parking garages.
4. This section shall not apply to Occupancy Group A, E, I or R.
5. This section shall not apply where the opening in the lower story is a protected opening with a fire protection rating of at least ¾ hour.

705.8.6 Vertical exposure. For buildings on the same tax lot, opening protectives shall be provided in every opening that is less than 15 feet (4572 mm) vertically above the roof of an adjacent building or structure based on assuming an imaginary line between them. The opening [~~protective~~] protectives are required where the fire separation distance between the imaginary line and the adjacent building or structure is less than 15 feet (4572 mm).

Exceptions:

1. Opening protectives are not required where the roof assembly of the adjacent building or structure has a fire-resistance rating of not less than 1 hour for a minimum distance of 10 feet (3048 mm) from the exterior wall facing the imaginary line and the entire length and span of the supporting elements for the fire-resistance-rated roof assembly has a fire-resistance rating of not less than 1 hour.
2. Buildings on the same tax lot and considered as portions of one building in accordance with Section 705.3 are not required to comply with Section 705.8.6.

705.9 Joints. Joints made in or between exterior walls required by this section to have a fire-resistance rating shall comply with Section ~~[714]~~ 715.

Exception: Joints in exterior walls that are permitted to have unprotected openings.

705.9.1 Voids. The void created at the intersection of a floor/ceiling assembly and an exterior curtain wall assembly shall be protected in accordance with Section ~~[714.4]~~ 715.4.

705.10 Ducts and air transfer openings. Penetrations by air ducts and air transfer openings in fire-resistance-rated exterior walls required to have protected openings shall comply with Section ~~[716]~~ 717.

Exception: Foundation vents installed in accordance with this code are permitted.

705.11 Parapets. Parapets shall be provided on exterior walls of buildings.

Exceptions: A parapet need not be provided on an exterior wall where any of the following conditions exist:

1. The wall is not required to be fire-resistance-rated in accordance with Table 602 because of fire separation distance.
2. The building has an area of not more than 1,000 square feet (~~[93]~~ 92.9 m²) on any floor.
3. Walls that terminate at roofs of not less than 2-hour fire-resistance-rated construction.
4. One-hour fire-resistance-rated exterior walls that terminate at the underside of the roof sheathing, deck or slab, provided that the entire building is covered with a Class A roof covering. Such roof shall not have openings located within 10 feet (3048 mm) of the 1-hour fire-resistance-rated exterior wall and not within 5 feet (1524 mm) for Groups R and U.
 - 4.1. Where the roof/ceiling framing elements are parallel to the walls, such framing and elements supporting such framing shall not be of less than 1-hour fire-resistance-rated construction for a width of 4 feet (~~(1219 mm)~~ measured from the interior side of the wall) (1220 mm) for Groups R and U and 10 feet (3048 mm) for other occupancies~~[708]~~, measured from the interior side of the wall.

- 4.2. Where roof/ceiling framing elements are not parallel to the wall, the entire span of such framing and elements supporting such framing shall not be of less than 1-hour fire-resistance-rated construction.
5. In occupancies of Groups R-2 and R-3, where both are provided with a Class A or B roof covering, the exterior wall shall be permitted to terminate at the underside of the roof sheathing or deck in Type III, IV and V construction, provided one or both of the following criteria is met:
 - 5.1. The roof sheathing or deck is constructed of approved noncombustible materials or of fire-retardant-treated wood^[7] for a distance of 4 feet [~~(1219 mm)~~]-(1220 mm) from the perimeter; or
 - 5.2. The roof is protected with 0.625-inch (~~[16]~~ 15.9 mm) Type X gypsum board directly beneath the underside of the roof sheathing or deck, supported by ~~[a minimum of]~~ not less than nominal 2-inch (~~[54]~~ 50.8 mm) ledgers attached to the sides of the roof framing members^[7] for a minimum distance of 4 feet [~~(1219 mm)~~] (1220 mm).
6. Where the wall is permitted to have ~~[at least]~~ not less than 25 percent of the exterior wall areas containing unprotected openings based on fire separation distance as determined in accordance with Section 705.8.

705.11.1 Parapet construction. Parapets shall have the same fire-resistance rating as that required for the supporting wall, and on any side adjacent to a roof surface, shall have noncombustible faces for the uppermost 18 inches (~~[457]~~ 457.2 mm), including counterflashing and coping materials. The height of the parapet shall be not ~~[be]~~ less than 30 inches (762 mm) above the point where the roof surface and the wall intersect. Where the roof slopes toward a parapet at a slope greater than two units vertical in 12 units horizontal (16.7-percent slope), the parapet shall extend to the same height as any portion of the roof within a fire separation distance where protection of wall openings is required, but in no case shall the height be less than 30 inches (762 mm).

705.12 Portions of a building cantilevered over existing buildings. Where a portion of a building is cantilevered over an adjacent building or tax lot by a horizontal distance greater than 1 foot (~~[305]~~ 304.8 mm), the cantilevered portions shall be protected with construction that conforms to a fire engineering analysis acceptable to the commissioner that conforms to Section 705.12.1. In no case shall the protection for structural elements and horizontal assemblies be less than that required ~~[for]~~ by the ~~[construction class of the]~~ building type of construction. In no case shall the fire-resistance rating of exterior walls or any other cantilevered exterior surfaces be less than that required by the building type of construction, and in no case shall the limitations for openings on such exterior surfaces be less than that required for a lot line condition pursuant to Table 705.8, including footnote "m."

705.12.1 Analysis. The analysis shall ~~[demonstrates]~~ demonstrate that all portions of the building that cantilever will withstand the anticipated effects of a design fire in accordance with generally accepted fire engineering principles with respect to at least all of the following building elements:

1. The structural supports and frame of the cantilevered portion of the building;

2. The underside projecting assemblies of the cantilevered portion of the building; and
3. The exterior walls and openings on all sides of the cantilevered portion of the building.

705.12.1.1 Criteria. With respect to the design fire within the existing building over which the proposed building is cantilevered, the analysis shall include a scenario to burn-out, where any active fire suppression systems do not operate, the fire department does not intervene, all interior vertical compartmentation, including at the entrances to the stairways, has been removed, and the fuel loading exceeds what is normally expected for the current occupancy by a factor of safety acceptable to the commissioner. Where there is no existing building below the cantilever, or where the existing building below the cantilever is significantly underbuilt, the commissioner may require additional data and analysis.

705.12.2 Fire Department access to buildings and roofs. The applicant shall submit to the department an approval from the Fire Department that the proposed cantilever complies with applicable provisions of the *New York City Fire Code* with respect to access to buildings and roofs.

705.12.3 Fire protection peer review. A fire protection peer review of the analysis required by Sections 705.12.1 and 705.12.1.1 shall be submitted to the department for each such analysis.

705.12.3.1. Fire protection peer reviewer. The fire protection peer review shall be performed by a qualified independent fire protection engineer who has been retained by or on behalf of the owner. A fire protection peer reviewer shall meet the requirements of the rules of the department.

705.12.3.2 Extent of fire protection peer review. The fire protection peer reviewer shall review the fire engineering analysis and construction documents relevant to the analysis for general compliance with the applicable provisions of this code.

705.12.3.3 Fire protection peer review report. The fire protection peer reviewer shall submit a report to the department stating that the fire engineering analysis conforms to the requirements of this code without exception.

705.12.3.4 Responsibility. The responsibility for the fire engineering analysis shall comply with Sections 705.12.3.4.1 and 705.12.3.4.2.

705.12.3.4.1 Applicant of record. The architect or engineer submitting the fire engineering analysis shall retain responsibility for the fire engineering analysis. The activities and reports of the fire protection peer reviewer shall not relieve the applicant of record of this responsibility.

705.12.3.4.2 Fire protection peer reviewer. The fire protection peer reviewer's report shall state his or her opinion regarding the fire engineering analysis by the applicant of record.

**SECTION BC 706
FIRE WALLS**

706.1 General. Each portion of a building separated by one or more fire walls that comply with the provisions of this section shall be considered a separate building. The extent and location of such fire walls shall provide a complete separation. Where a fire wall also separates occupancies that are required to be separated by a fire barrier wall, the most restrictive requirements of each separation shall apply. Concealed spaces in cornices and eaves shall comply with the provisions of Section 705.2.2.

706.1.1 Party walls. Any wall located on a property line between adjacent buildings, which is used or adapted for joint service between the two buildings, shall be constructed as a fire wall in accordance with Section 706, and shall create separate buildings.

Exception: Openings in a party wall separating an anchor building and a mall shall be in accordance with Section ~~[402.7.3]~~ 402.4.2.2.

706.1.2 Walls separating attached one- and two-family dwellings. Attached one- and two-family dwellings shall be separated by walls constructed in accordance with Section 706 or Appendix M.

706.2 Structural stability. Fire walls shall ~~[have sufficient structural stability under fire conditions]~~ be designed and constructed to allow collapse of [construction] the structure on either side without collapse of the wall [for the duration of time indicated by the required fire-resistance rating] under fire conditions. Fire walls designed and constructed in accordance with NFPA 221 shall be deemed to comply with this section.

706.3 Materials. Fire walls shall be constructed of any approved noncombustible materials.

706.4 Fire-resistance rating. Fire walls shall have a fire-resistance rating of not less than that required by Table 706.4.

**TABLE 706.4
FIRE WALL FIRE-RESISTANCE RATINGS**

GROUP	FIRE-RESISTANCE RATING (hours)
A, B, E, H-4, I, R-1, R-2, U	3 ^a
F-1, H-3 ^b , H-5, M, S-1	3
H-1, H-2	4 ^b
F-2, S-2, R-3	2

a. Walls shall be not less than 2-hour fire-resistance-rated where separating buildings of Type II or V construction
b. For Group H-1, H-2 or H-3 buildings, also see Sections ~~[415.4]~~ 415.7 and ~~[415.5]~~ 415.8.

706.5 Horizontal continuity. Fire walls shall be continuous from exterior wall to exterior wall and shall extend ~~[at least]~~ not less than 18 inches (~~[457]~~ 457.2 mm) beyond the exterior surface of exterior walls.

Exceptions:

1. Fire walls shall be permitted to terminate at the interior surface of combustible exterior sheathing or siding provided the exterior wall has a fire-resistance rating of [~~at least~~] not less than 1 hour for a horizontal distance of [~~at least~~] not less than 4 feet [~~(1219 mm)~~] (1220 mm) on both sides of the fire wall. Openings within such exterior walls shall be protected by opening protectives having a fire protection rating of not less than ³/₄ hour.
2. Fire walls shall be permitted to terminate at the interior surface of noncombustible exterior sheathing, exterior siding or other noncombustible exterior finishes provided the sheathing, siding[;] or other exterior noncombustible finish extends a horizontal distance of [~~at least~~] not less than 4 feet [~~(1219 mm)~~] (1220 mm) on both sides of the fire wall.
3. Fire walls shall be permitted to terminate at the interior surface of noncombustible exterior sheathing where the building on each side of the fire wall is protected by an automatic sprinkler system installed in accordance with Section 903.3.1.1 or 903.3.1.2.

706.5.1 Exterior walls. Where the fire wall intersects [~~the~~] exterior walls, the fire-resistance rating and opening protection of the exterior walls shall comply with one of the following:

1. The exterior walls on both sides of the fire wall shall have a 1-hour fire-resistance rating with [~~3/4~~] 3/4-hour protection where opening protection is required by Section 705.8[;]. The fire-resistance rating of the exterior wall shall extend [~~a minimum of~~] not less than 4 feet [~~(1219 mm)~~] (1220 mm) on each side of the intersection of the fire wall to exterior wall. Exterior wall intersections at fire walls that form an angle equal to or greater than 180 degrees (3.14 rad) do not need exterior wall protection.
2. Buildings or spaces on both sides of the intersecting fire wall shall assume to have an imaginary lot line at the fire wall and extending beyond the exterior of the fire wall. The location of the assumed line in relation to the exterior walls and the fire wall shall be such that the exterior wall and opening protection meet the requirements set forth in Sections 705.5 and 705.8. Such protection is not required for exterior walls terminating at fire walls that form an angle equal to or greater than 180 degrees (3.14 rad).

706.5.2 Horizontal projecting elements. Fire walls shall extend to the outer edge of horizontal projecting elements such as balconies, roof overhangs, canopies, marquees and [~~architectural~~] similar projections that are within 4 feet [~~(1219 mm)~~] (1220 mm) of the fire wall.

Exceptions:

1. Horizontal projecting elements without concealed spaces, provided the exterior wall behind and below the projecting element has not less than 1-hour fire-resistance-rated construction for a distance not less than the depth of the projecting element on both sides of the fire wall. Openings within such exterior walls shall be protected by opening protectives having a fire protection rating of not less than ³/₄ hour.
2. Noncombustible horizontal projecting elements with concealed spaces, provided a minimum 1-hour fire-resistance-rated wall extends through the concealed space. The projecting element shall be separated from the building by [~~a minimum of~~] not less than 1-hour fire-resistance-rated construction for a distance on each side of the fire

wall equal to the depth of the projecting element. The wall is not required to extend under the projecting element where the building exterior wall is not less than 1-hour fire-resistance-rated for a distance on each side of the fire wall equal to the depth of the projecting element. Openings within such exterior walls shall be protected by opening protectives having a fire protection rating of not less than $3/4$ hour.

3. For combustible horizontal projecting elements with concealed spaces, the fire wall need only extend through the concealed space to the outer edges of the projecting elements. The exterior wall behind and below the projecting element shall be of not less than 1-hour fire-resistance-rated construction for a distance not less than the depth of the projecting elements on both sides of the fire wall. Openings within such exterior walls shall be protected by opening protectives having a fire-protection rating of not less than $3/4$ hour.

706.6 Vertical continuity. Fire walls shall extend from the foundation through the roof, to form a parapet [~~at least~~] not less than 30 inches (762 mm) in height. [~~Such parapet shall in no event extend to a point less than 4 inches (102 mm) above the highest point of peaked or gabled roof.~~]

Exceptions:

1. Where a [~~two-hour~~] 2-hour fire wall is permitted in accordance with Table 706.4, such wall shall be permitted to terminate at the underside of the roof sheathing, deck or slab provided:
 - 1.1. The lower roof assembly within 4 feet [~~(1219 mm)~~] (1220 mm) of the wall has not less than a 1-hour fire-resistance rating and the entire length and span of supporting elements for the rated roof assembly has a fire-resistance rating of not less than 1 hour; and
 - 1.2. Openings in the roof shall not be located within 4 feet [~~(1219 mm)~~] (1220 mm) of the fire wall; and
 - 1.3. Each building shall be provided with not less than a Class A roof covering.
2. In buildings of Type I or II construction, fire walls shall be permitted to terminate at the underside of noncombustible roof sheathing, deck, or slabs where both buildings are provided with not less than a Class A roof covering. Openings in the roof shall not be located within 4 feet [~~(1219 mm)~~] (1220 mm) of the fire wall.
3. In buildings of Type III, IV and V construction, fire walls shall be permitted to terminate at the underside of noncombustible roof sheathing or decks provided:
 - 3.1. There are no openings in the roof within 4 feet [~~(1219 mm)~~] (1220 mm) of the fire wall; and
 - 3.2. The roof is covered with a minimum Class A roof covering.
4. [~~Buildings located above a parking garage~~] In buildings designed in accordance with Section 510.2[~~shall be permitted to have the~~], fire walls [~~for the buildings~~] located above

the [parking garage extend from the horizontal separation between the parking garage and the buildings] 3-hour horizontal assembly required by Section 510.2, Item 1 shall be permitted to extend from the top of this horizontal assembly.

5. Where a fire wall serves as an interior wall for a building, and the roof on one side or both sides of the fire wall slopes toward the fire wall at a slope greater than two units vertical in 12 units horizontal (2:12), the fire wall shall extend to a height equal to the height of the roof located 4 feet (1220 mm) from the fire wall plus 30 inches (762 mm). In no case shall the extension of the fire wall be less than 30 inches (762 mm).

706.6.1 Stepped buildings. Where a fire wall serves as an exterior wall for a building and separates buildings having different roof levels, such wall shall terminate at a point not less than 30 inches (762 mm) above the lower roof level, provided the exterior wall for a height of 60 feet (18 288 mm) above the lower roof is not less than 1-hour fire-resistance-rated construction from both sides with openings protected by fire assemblies having a fire protection rating of not less than ¾ hour.

Exception: Where the fire wall terminates at the underside of the roof sheathing, deck or slab of the lower roof, provided:

1. The lower roof assembly within 10 feet (3048 mm) of the wall has not less than a 1-hour fire-resistance rating and the entire length and span of supporting elements for the rated roof assembly has a fire-resistance rating of not less than 1 hour.
2. Openings in the lower roof shall not be located within 10 feet (3048 mm) of the fire wall.

706.7 Combustible framing in fire walls. Adjacent combustible members entering into a concrete or masonry fire wall from opposite sides shall not have less than a 4-inch ([402] 101.6 mm) distance between embedded ends. Where combustible members frame into hollow walls or walls of hollow units, hollow spaces shall be solidly filled for the full thickness of the wall and for a distance not less than 4 inches ([402] 101.6 mm) above, below and between the structural members, with noncombustible materials approved for fireblocking.

706.8 Openings. Each opening through a fire wall[;] ~~or a party wall[; or a through wall between two buildings]~~ shall be protected in accordance with Section [715.4] 716.5 and shall not exceed 156 square feet ([45] 14.5 m²)[; ~~with no dimension greater than 12 feet (3658 mm)].~~ The aggregate width of openings at any floor level shall not exceed 25 percent of the length of the wall.

Exception: Openings shall not be limited to 156 square feet ([45] 14.5 m²) where both buildings are equipped throughout with an automatic sprinkler system installed in accordance with Section 903.3.1.1. However, the aggregate width of all openings at any one floor level shall not exceed 25 percent of the length of the wall.

706.9 Penetrations. Penetrations ~~[through]~~ of fire walls shall comply with Section [713] 714.

706.10 Joints. Joints made in or between fire walls shall comply with Section [714] 715.

706.11 Ducts and air transfer openings. Ducts and air transfer openings shall not penetrate fire walls.

Exception: Penetrations by ducts and air transfer openings of fire walls that are not on a ~~tax~~ lot line shall be allowed provided the penetrations comply with Section ~~716~~ 717. The size and aggregate width of all openings shall not exceed the limitations of Section 706.8.

SECTION BC 707 FIRE BARRIERS

707.1 General. Fire barriers installed as required elsewhere in this code or the *New York City Fire Code*, shall comply with this section.

707.2 Materials. Fire barriers shall be of materials permitted by the building type of construction.

707.3 Fire-resistance rating. The fire-resistance rating of fire barriers shall comply with this section.

707.3.1 Shaft enclosures. The fire-resistance rating of the fire barrier separating building areas from a shaft shall comply with Section ~~708.4~~ 713.4.

707.3.2 ~~Exit enclosures~~ Interior exit stairway and ramp construction. The fire-resistance rating of the fire barrier separating building areas from an interior exit stairway or ramp shall comply with Section ~~1022.1~~ 1023.1.

707.3.3 Enclosures for exit access stairways. The fire-resistance rating of the fire barrier separating building areas from an exit access stairway or ramp shall comply with Section 713.4.

707.3.4 Exit passageway. The fire-resistance rating of the fire barrier separating building areas from an exit passageway shall comply with Section ~~1023.1~~ 1024.3.

~~707.3.4~~ **707.3.5 Horizontal exit.** The fire-resistance rating of the separation between building areas connected by a horizontal exit shall comply with Section ~~1025.1~~ 1026.1.

~~707.3.5~~ **707.3.6 Atriums.** The fire-resistance rating of the fire barrier separating atriums shall comply with Section 404.6.

~~707.3.6~~ **707.3.7 Incidental uses.** The fire barrier separating incidental uses from other spaces in the building shall have a fire-resistance rating of not less than that indicated in Table 509.

~~707.3.7~~ **707.3.8 Control areas.** Fire barriers separating control areas shall have a fire-resistance rating of not less than that required in Section 414.2.4.

~~707.3.8~~ **707.3.9 Separated occupancies.** Where the provisions of Section 508.4 are applicable, the fire barrier separating mixed occupancies shall have a fire-resistance rating of not less than that indicated in ~~Section~~ Table 508.4 based on the occupancies being separated.

~~707.3.9~~ **707.3.10 Fire areas.** The fire barriers or horizontal assemblies, or both, separating a single occupancy into different fire areas shall have a fire-resistance rating of not less than that indicated in Table ~~707.3.9~~ 707.3.10. The fire barriers or horizontal assemblies, or both,

separating fire areas of mixed occupancies shall have a fire-resistance rating of not less than the highest value indicated in Table [707.3.9] 707.3.10 for the occupancies under consideration.

Exception: For fire-resistance ratings of public corridors, see Section 707.3.11.

**TABLE [707.3.9] 707.3.10
FIRE-RESISTANCE RATING REQUIREMENTS FOR
FIRE BARRIER ASSEMBLIES OR HORIZONTAL
ASSEMBLIES BETWEEN FIRE AREAS**

OCCUPANCY GROUP	FIRE-RESISTANCE RATING (hours)
H-1, H-2	4
F-1, H-3, S-1	3
A, B, E, F-2, H-4, H-5, I, M, R, S-2	2
U	1

707.3.11 Public corridors. The fire-resistance rating of public corridor walls shall comply with Table 1020.1.2.

707.4 Exterior walls. Where exterior walls serve as a part of a required fire-resistance-rated shaft [~~or exit~~], stairway or ramp enclosure, or separation, such walls shall comply with the requirements of Section 705 for exterior walls[~~;~~] and the fire-resistance-rated enclosure or separation requirements shall not apply.

Exception: Exterior walls required to be fire-resistance-rated in accordance with Section [4019.2] 1021 for exterior egress balconies, Section [4022.6] 1023.7 for interior exit [enclosures] stairways and ramps and Section [4026.6] 1027.6 for exterior exit [~~ramps and~~] stairways and ramps.

707.5 Continuity. Fire barriers shall extend from the top of the floor/ceiling assembly below[~~;~~] to the underside of the floor or roof sheathing, slab or deck above and shall be securely attached thereto. Such fire barriers shall be continuous through concealed spaces, such as the space above a suspended ceiling. Joints and voids at intersections shall comply with Sections 707.8 and 707.9.

Exceptions:

1. Shaft enclosures shall be permitted to terminate at a top enclosure complying with Section 713.12.
2. Interior exit stairway and ramp enclosures required by Section 1023 and exit access stairway and ramp enclosures required by Section 1019 shall be permitted to terminate at a top enclosure complying with Section 713.12.

707.5.1 Supporting construction. The supporting construction for a fire barrier shall be protected to afford the required fire-resistance rating of the fire barrier supported. Hollow vertical spaces within a fire barrier shall be fireblocked in accordance with Section [717.2] 718.2 at every floor level.

Exceptions:

1. The maximum required fire-resistance rating for assemblies supporting fire barriers separating tank storage as provided for in Section ~~[415.6.2.1]~~ 415.9.1.2 shall be 2 hours, but not less than required by Table 601 for the building construction type.

~~[2. Shaft enclosures shall be permitted to terminate at a top enclosure complying with Section 708.12.]~~

- ~~[3.]~~ 2. Supporting construction for 1-hour fire barriers required by Table 509 in buildings of Type IIB, IIIB and VB construction is not required to be fire-resistance-rated unless required by other sections of this code.

707.6 Openings. Openings in a fire barrier shall be protected in accordance with Section ~~[715]~~ 716. Openings shall be limited to a maximum aggregate width of 25 percent of the length of the wall, and the maximum area of any single opening shall not exceed 156 square feet (~~[15]~~ 14.5 m²). Openings in ~~[vertical exit]~~ enclosures for exit access stairways and ramps, interior exit stairways and ramps and exit passageways shall also comply with Sections ~~[1022.3 and 1023.5]~~ 1019, 1023.4 and 1024.5, respectively.

Exceptions:

1. Openings shall not be limited to 156 square feet (~~[15]~~ 14.5 m²) where adjoining floor areas are equipped throughout with an automatic sprinkler system in accordance with Section 903.3.1.1.
2. Openings ~~[for fire doors serving an exit enclosure]~~ shall not be limited to 156 square feet (~~[15]~~ 14.5 m²) or an aggregate width of 25 percent of the length of the wall where the opening protective is a fire door serving enclosures for exit access stairways and ramps, and/or interior exit stairways and ramps.
3. Openings shall not be limited to 156 square feet (~~[15]~~ 14.5 m²) or an aggregate width of 25 percent of the length of the wall where the opening protective has been tested in accordance with ASTM E 119 or UL 263 and has a minimum fire-resistance rating not less than the fire-resistance rating of the wall.
4. Fire window assemblies permitted in atrium separation walls shall not be limited to a maximum aggregate width of 25 percent of the length of the wall.
5. Openings shall not be limited to 156 square feet (~~[15]~~ 14.5 m²) or an aggregate width of 25 percent of the length of the wall where the opening protective is a fire door assembly in a fire barrier separating an ~~[exit] enclosure~~ for exit access stairways and ramps, and/or interior exit stairways and ramps from an exit passageway in accordance with Section ~~[1022.2.1]~~ 1023.3.1.
6. Openings permitted in atrium enclosures shall comply with the provisions of Section 404.5.

707.7 Penetrations. Penetrations of fire barriers shall comply with Section ~~[713]~~ 714.

707.7.1 Prohibited penetrations. ~~[Penetrations into an exit enclosure or an exit passageway shall be allowed when permitted by Sections 1022.4 or 1023.6, respectively.]~~ Penetrations into enclosures for exit access stairways and ramps, interior exit stairways and ramps, and exit passageways shall be allowed only where permitted by Sections 1019, 1023.5 and 1024.6, respectively.

707.8 Joints. Joints made in or between fire barriers, and joints made at the intersection of fire barriers with underside of ~~the~~ a fire-resistance-rated floor or roof sheathing, slab or deck above, and the exterior vertical wall intersection shall comply with Section ~~[744]~~ 715.

707.9 Voids at intersections. The voids created at the intersection of a fire barrier and a nonfire-resistance-rated roof assembly or a nonfire-resistance-rated exterior wall assembly shall be filled. An approved material or system, or a material consistent with the construction requirements of the fire barrier, shall be used to fill the void, and shall be securely installed in or on the intersection for its entire length so as not to dislodge, loosen or otherwise impair its ability to accommodate expected building movements and to retard the passage of fire and hot gases.

707.10 Ducts and air transfer openings. Penetrations in a fire barrier by ducts and air transfer openings shall comply with Section ~~[716]~~ 717.

~~[707.9.1]~~ **707.10.1 Prohibited ducts and air transfer openings.** Penetrations by ducts and air transfer openings into an ~~[exit]~~ enclosure for exit access stairways and ramps shall only be allowed when permitted by Sections ~~[1022.4 and 1023.6]~~ 1023.4 and 1023.6.

**[SECTION BC 708
SHAFT ENCLOSURES]**

[708.1 General. ~~The provisions of this section shall apply to shafts required to protect openings and penetrations through floor/ceiling and roof/ceiling assemblies. Shaft enclosures shall be constructed as fire barriers in accordance with Section 707 or horizontal assemblies in accordance with Section 712, or both.]~~

[708.2 Shaft enclosure required. ~~Openings through a floor/ceiling assembly shall be protected by a shaft enclosure complying with this section.]~~

[Exceptions:]

[1. ~~A shaft enclosure is not required for openings totally within an individual residential dwelling unit and connecting four stories or less where such dwelling unit is fully sprinklered in accordance with Section 903.3.1.1, 903.3.1.2 or 903.3.1.3.]~~

[2. ~~A shaft enclosure is not required in a building equipped throughout with an automatic sprinkler system in accordance with Section 903.3.1.1 for an escalator opening or stairway which is not a portion of the means of egress protected according to Item 2.1 or 2.2:]~~

[2.1. ~~Where the area of the floor opening between stories does not exceed twice the horizontal projected area of the escalator or stairway and the opening is protected~~

by a draft curtain and closely spaced sprinklers in accordance with NFPA 13, as modified in Appendix Q. In other than Groups B and M, this application is limited to openings that do not connect more than four stories.]

~~[2.2. Where the opening is protected by approved power operated automatic shutters at every penetrated floor. The shutters shall be of noncombustible construction and have a fire resistance rating of not less than 1.5 hours. The shutter shall be so constructed as to close immediately upon the actuation of a smoke detector installed in accordance with Section 907.3 and shall completely shut off the well opening. Escalators shall cease operation when the shutter begins to close. The shutter shall operate at a speed of not more than 30 feet per minute (152.4 mm/s) and shall be equipped with a sensitive leading edge to arrest its progress where in contact with any obstacle, and to continue its progress on release therefrom.]~~

~~[3. A shaft enclosure is not required for penetrations by pipe, tube, conduit, wire, cable, and vents protected in accordance with Section 713.4.]~~

~~[4. A shaft enclosure is not required for penetrations by ducts protected in accordance with Section 716.6. Grease ducts shall be protected in accordance with the *New York City Mechanical Code*.]~~

~~[5. In other than Group H occupancies, a shaft enclosure is not required for floor openings complying with the provisions for atriums in Section 404.]~~

~~[6. A shaft enclosure is not required for approved masonry chimneys, where annular space is fireblocked at each floor level in accordance with Section 717.2.5.]~~

~~[7. In other than Groups I-2 and I-3, a shaft enclosure is not required for a floor opening or an air transfer opening that complies with all of the following:]~~

~~[7.1. Does not connect more than two stories.]~~

~~[7.2. Is not part of the required means of egress system.]~~

~~[7.3. Is not concealed within the building construction of a wall or floor/ceiling assembly.]~~

~~[7.4. Is not open to a corridor in Group I and R occupancies where such corridor is required to be fire resistance rated in accordance with Tables 1018.1.1 and 1018.1.2.]~~

~~[7.5. Is not open to a corridor on nonsprinklered floors in any occupancy where such corridor is required to be fire resistance rated in accordance with Tables 1018.1.1 and 1018.1.2.]~~

~~[7.6. Is separated from floor openings and air transfer openings serving other floors by construction conforming to required shaft enclosures.]~~

~~[7.7. Is limited to the same smoke compartment.]~~

- [8. ~~A shaft enclosure is not required for automobile ramps in open and enclosed parking garages constructed in accordance with Sections 406.3 and 406.4, respectively.]~~
- [9. ~~A shaft enclosure is not required for floor openings between a mezzanine and the floor below.]~~
- [10. ~~A shaft enclosure is not required for joints protected by a fire-resistant joint system in accordance with Section 714.]~~
- [11. ~~A shaft enclosure shall not be required for floor openings created by unenclosed stairs or ramps in accordance with Exception 3 or 4 in Section 1016.1.]~~
- [12. ~~Floor openings protected by floor fire doors in accordance with Section 712.8.]~~
- [13. ~~In Group I-3 occupancies, a shaft enclosure is not required for floor openings in accordance with Section 408.5.]~~
- [14. ~~A shaft enclosure is not required for elevator hoistways in open or enclosed parking garages that serve only the parking garage.]~~
- [15. ~~In open or enclosed parking garages, a shaft enclosure is not required to enclose mechanical exhaust or supply duct systems when such duct system is contained within and serves only the parking garage.]~~
- [16. ~~Where permitted by other sections of this code.]~~

~~**[708.3 Materials.** The shaft enclosure shall be of materials permitted by the building type of construction.]~~

~~**[Exception:** Noncombustible materials shall be used for shaft enclosures in Group I-1, R-1 and R-2 buildings irrespective of the building type of construction.]~~

~~**[708.4 Fire-resistance rating.** Shaft enclosures shall have a fire-resistance rating of not less than 2 hours where penetrating three stories or more and not less than 1 hour where penetrating fewer than three stories. The number of stories connected by the shaft enclosure shall include any basements or cellars, but not any mezzanines. Shaft enclosures shall have a fire-resistance rating not less than the floor assembly penetrated, but need not exceed 2 hours. Shaft enclosures shall meet the requirements of Section 703.2.]~~

~~**[708.5 Continuity.** Shaft enclosures shall be constructed as fire barriers in accordance with Section 707 or horizontal assemblies constructed in accordance with Section 712 or both. Where the roof construction is of combustible materials, shaft enclosure walls shall extend through the roof construction at least 30 inches (762 mm) above the roof. Where the roof construction is of noncombustible materials, shaft enclosure walls shall extend from the top of the floor/ceiling assembly below to the underside of the floor or roof slab or deck above and shall be securely attached thereto. These walls shall be continuous through concealed spaces such as the space above a suspended ceiling. The supporting construction shall be protected to afford the required fire-resistance rating of the element supported. Hollow vertical spaces within the shaft enclosure construction wall shall be firestopped at every floor level.]~~

~~[Exception: A shaft enclosure of a refuse or laundry chute shall extend through combustible or noncombustible roof construction at least 6 feet (1829 mm) above the roof.]~~

~~[708.6 Exterior walls. Where exterior walls serve as a part of a required shaft enclosure, such walls shall comply with the requirements of Section 705 for exterior walls and the fire resistance rated enclosure requirements of Section 707.4 shall not apply.]~~

~~[Exception: Exterior walls required to be fire resistance rated in accordance with Section 1019.2 for exterior egress balconies, Section 1022.6 for exit enclosures and Section 1026.6 for exterior exit ramps and stairways.]~~

~~[708.7 Openings. Openings in a shaft enclosure shall be protected in accordance with Section 715 as required for fire barriers. Doors shall be self-closing or automatic-closing by smoke detection in accordance with Section 715.4.8.3. Automatic-closing by smoke detection is not permitted for doors serving vertical exit enclosures.]~~

~~[Exception: For no more than one vertical exit enclosure in a building, doors serving such enclosure may be automatic-closing by smoke detection provided that the following conditions are satisfied:]~~

~~[1. The building contains no Group H space and:]~~

~~[1.1. Is not a high-rise building pursuant to Section 403.1 of this code, or for the purposes of prior code buildings, Section 27-232 of the *Administrative Code*, and is equipped with a fire alarm system; or]~~

~~[1.2. Is equipped with fire alarm systems and automatic-sprinkler systems throughout; or]~~

~~[1.3. Is a high-rise office building, as such term is defined in Section 27-232 of the *Administrative Code*, that is 100 feet (30 480 mm) or more in height, equipped with a fire alarm system and subdivided into compartments pursuant to subdivision c of Section 27-339 of the *Administrative Code*.]~~

~~[2. Such doors serve no more than three levels within such vertical exit enclosure, which must be consecutive levels.]~~

~~[3. All levels served by such doors are served by at least one other exit.]~~

~~[4. Such doors are connected to a fire alarm system and installed in accordance with Section 715.4.8.3 and NFPA 80.]~~

~~[5. The hold-open devices of such doors:]~~

~~[5.1. Are capable of manual release at the fire command center or, if a fire command center is not required, at a fire alarm control panel that is near the main building entrance; and]~~

~~[5.2. Are capable of manual release by pulling the doors to the closed position.]~~

~~[708.7.1 Prohibited openings. Openings other than those necessary for the purpose of the shaft shall not be permitted in shaft enclosures.]~~

~~[708.8 Penetrations. Penetrations in a shaft enclosure shall be protected in accordance with Section 713 as required for fire barriers.]~~

~~[708.8.1 Prohibited penetrations. Penetrations other than those necessary for the purpose of the shaft shall not be permitted in shaft enclosures.]~~

~~[708.9 Joints. Joints in a shaft enclosure shall comply with Section 714.]~~

~~[708.10 Ducts and air transfer openings. Penetrations of a shaft enclosure by ducts and air transfer openings shall comply with Section 716.]~~

~~[708.11 Enclosure at the bottom. Shafts that do not extend to the bottom of the building or structure shall comply with one of the following:]~~

- ~~[1. They shall be enclosed at the lowest level with construction of the same fire resistance rating as the lowest floor through which the shaft passes, but not less than the rating required for the shaft enclosure; or]~~
- ~~[2. They shall terminate in a room having a use related to the purpose of the shaft. The room shall be separated from the remainder of the building by fire barriers constructed in accordance with Section 707 or horizontal assemblies constructed in accordance with Section 712, or both. The fire resistance rating and opening protectives shall be at least equal to the protection required for the shaft enclosure.]~~

~~[Exceptions:]~~

- ~~[1. The fire resistance rated room separation is not required provided there are no openings in or penetrations of the shaft enclosure to the interior of the building except at the bottom. The bottom of the shaft shall be closed off around the penetrating items with materials permitted by Section 717.3.1 for draftstopping, or the room shall be provided with an approved automatic fire suppression system.]~~
- ~~[2. A shaft enclosure containing a refuse chute or laundry chute shall not be used for any other purpose and shall terminate in a room protected in accordance with Section 708.13.4.]~~
- ~~[3. The fire resistance rated room separation and the protection at the bottom of the shaft are not required provided there are no combustibles in the shaft and there are no openings or other penetrations through the shaft enclosure to the interior of the building.]~~

~~[708.12 Enclosure at the top. Shafts that do not extend to the top of the building or structure shall:]~~

- ~~[1. Be enclosed at the highest level with construction of the same fire resistance rating as the highest floor through which the shaft passes, but not less than the rating required for the shaft enclosure; or]~~

~~[2. Terminate in a room having a use related to the purpose of the shaft. The room shall be separated from the remainder of the building by construction having a fire resistance rating and opening protective at least equal to the protection required for the shaft enclosure.]~~

~~[708.12.1 Smoke venting of stair and other closed shafts. All closed shafts, including vertical exit enclosures, having a floor area exceeding 4 square feet (0.37 m²) shall be provided with a smoke vent in accordance with Sections 708.12.1.1 through 708.12.1.3.]~~

~~[Exception: Elevator and dumbwaiter shafts in accordance with Chapter 30.]~~

~~[708.12.1.1 Smoke vent construction. Smoke vents may be constructed as windows, louvers, skylights, vent ducts, or similar devices. Where a vent duct is installed, such vent ducts shall be enclosed by construction having the same fire resistance rating as required for the shaft enclosure.]~~

~~[708.12.1.2 Smoke vent dimensions. The effective venting area shall not be less than 3½ percent of the maximum shaft area at any floor, but in no event less than 72 square inches (0.05 m²).]~~

~~[708.12.1.3 Smoke vent location. Smoke vents shall be located in accordance with Section 708.12.1.3.1 or 708.12.1.3.2, as applicable.]~~

~~[708.12.1.3.1 Smoke vents located above the roof line. Where a closed shaft or smoke vent duct penetrates through the roof of the building, the vent shall be located as follows:]~~

~~[1. The vent shall be located at least 8 inches (203 mm) above a noncombustible roof assembly or at least 36 inches (914 mm) above a combustible roof assembly.]~~

~~[2. The vent shall be located at least 10 feet (3048 mm) from any window, door, exterior stairway, or interior lot line. The vent may be located no less than 5 feet (1524 mm) from any window or door provided that the vent is located at a point higher than the top of such window or door.]~~

~~[3. Where the vent is constructed as a window or louver, the sill of the window or louver shall be located at least 36 inches (914 mm) (above the roof assembly).]~~

~~[708.12.1.3.2 Smoke vents located in an exterior wall. Where the exterior wall serves as part of a shaft enclosure or where a smoke vent duct penetrates the exterior wall of the building, no openings shall be located in the wall within a distance of 30 feet (9144 mm) vertically above the vent opening, nor within 5 feet (1524 mm) on either side of the vent opening.]~~

~~[708.13 Refuse and laundry chutes. Refuse and laundry chutes, access and termination rooms and incinerator rooms shall meet the requirements of Sections 708.13.1 through 708.13.6.]~~

~~[Exception: Chutes serving and contained within a single dwelling unit.]~~

~~[708.13.1 Refuse and laundry chute enclosures. A shaft enclosure containing a refuse or laundry chute shall not be used for any other purpose and shall have a fire resistance rating of 2 hours.]~~

Openings into the shaft, including those from access rooms and termination rooms, shall be protected in accordance with this section and Section 715. Openings into chutes shall not be located in corridors. Doors shall be self-closing.]

~~[708.13.2 Materials. A shaft enclosure containing a refuse or laundry chute shall be constructed of noncombustible materials.]~~

~~[708.13.3 Refuse and laundry chute access rooms. Access openings for refuse and laundry chutes shall be located in dedicated rooms or compartments enclosed by not less than 2-hour fire barriers constructed in accordance with Section 707 or horizontal assemblies constructed in accordance with Section 712, or both. Openings into the access rooms shall be protected by opening protectives having a fire protection rating of not less than 1½-hour. Doors shall be self-closing except that where the storage of refuse, including recyclables, or laundry is not permitted in such access rooms doors may be automatic closing upon the detection of smoke in accordance with Section 715.4.8.3.]~~

~~[Exception: Access openings for refuse or laundry chutes located within a dwelling unit need not be located within a separate room or compartment.]~~

~~[708.13.4 Termination room. Refuse and laundry chutes shall discharge into an enclosed room separated from the remainder of the building by not less than 3-hour fire barriers constructed in accordance with Section 707 or horizontal assemblies constructed in accordance with Section 712, or both. Openings into the termination room shall be protected by opening protectives having a fire protection rating of not less than 1½-hours. Doors shall be self-closing.]~~

~~[Exception: Opening protectives shall not be required at a refuse or laundry chute opening to a termination room.]~~

~~[708.13.5 Incinerator room. Incinerator rooms shall comply with Table 509.]~~

~~[708.13.6 Automatic fire sprinkler system. An approved automatic fire sprinkler system shall be installed in accordance with Section 903.2.11.6.]~~

~~[708.14 Elevator, dumbwaiter and other hoistways. Elevator, dumbwaiter, and other hoistway enclosures shall be constructed in accordance with Section 708 and Chapter 30.]~~

~~[708.14.1 Elevator lobby. Except as provided by Sections 403.6.1 and 403.6.2, an enclosed elevator lobby shall be provided in high rise buildings at the following locations:]~~

~~[1. Elevators opening onto a fire-resistance-rated corridor, in all occupancy groups.]~~

~~[2. Elevators serving Group B occupancies. Elevators that serve four or more stories that contain space classified in occupancy Group B, inclusive of any lobby or entrance level, shall provide elevator lobbies at every level served by such elevator.]~~

~~[The lobby enclosure shall separate the elevator shaft enclosure doors from each floor by smoke partitions. In addition to the requirements in Section 709 for fire partitions, doors protecting openings in the elevator lobby enclosure walls shall also comply with Section 711.5.3 and penetrations of the elevator lobby enclosure by ducts and air transfer openings shall be~~

~~protected in accordance with Section 711.7. Elevator lobbies shall have at least one means of egress complying with Chapter 10 and other provisions within this code. Access to an exit on any story through an elevator lobby shall be permitted provided that access to at least one other required exit does not require passing through the elevator lobby.]~~

[Exceptions:]

- ~~[1. Enclosed elevator lobbies are not required at the street floor, provided the entire street floor is equipped with an automatic sprinkler system in accordance with Section 903.3.1.1.]~~
- ~~[2. Elevators not required to be located in a shaft in accordance with Section 708.2 are not required to have enclosed elevator lobbies.]~~
- ~~[3. Enclosed elevator lobbies are not required where zero-clearance doors are provided at the hoistway opening in accordance with Section 3002.6. Such doors shall be tested in accordance with UL 1784 without an artificial bottom seal.]~~
- ~~[4. Enclosed elevator lobbies are not required on floors with less than 2,500 square feet (232 m²), provided that the commissioner accepts an alternative design or construction method that accomplishes the purposes of this section, or provided that the commissioner determines that compliance with this section is impracticable in whole or in part, whereby the commissioner may authorize an exemption from the requirements of this section.]~~
- ~~[5. Enclosed elevator lobbies are not required on Group R-2 occupied floors.]~~
- ~~[6. Enclosed elevator lobbies are not required where the elevator hoistway is pressurized in accordance with Section 708.14.2.]~~
- ~~[7. Enclosed elevator lobbies are not required where the elevator serves only open parking garages in accordance with Section 406.3.]~~

~~**[708.14.1.1 Areas of rescue assistance.** Areas of rescue assistance shall be provided as required in Section 1007.6.]~~

~~**[708.14.2 Enclosed elevator lobby.** Where elevator hoistway pressurization is provided in lieu of required enclosed elevator lobbies, the pressurization system shall comply with this section except as provided by Sections 403.6.1 and 403.6.2.]~~

~~**[708.14.2.1 Pressurization requirements.** Elevator hoistways shall be pressurized to maintain a minimum positive pressure of 0.10 inches of water (25 Pa) and a maximum positive pressure of 0.25 inches of water (67 Pa) with respect to adjacent occupied space on all floors. This pressure shall be measured at the midpoint of each hoistway door, with all elevator cars at the floor of recall and all hoistway doors on the floor of recall open and all other hoistway doors closed. The opening and closing of hoistway doors at each level must be demonstrated during this test. The supply air intake shall be from an outside, uncontaminated source located a minimum distance of 20 feet (6096 mm) from any air exhaust system or outlet.]~~

~~[708.14.2.2 Rational analysis. A rational analysis complying with Section 909.4 shall be submitted with the construction documents.]~~

~~[708.14.2.3 Ducts for system. Any duct system that is part of the pressurization system shall be protected with the same fire resistance rating as required for the elevator shaft enclosure.]~~

~~[708.14.2.4 Fan system. The fan system provided for the pressurization system shall be as required by this section.]~~

~~[708.14.2.4.1 Fire resistance. When located within the building, the fan system that provides the pressurization shall be protected with the same fire resistance rating required for the elevator shaft enclosure.]~~

~~[708.14.2.4.2 Smoke detection. The fan system shall be equipped with a smoke detector that will automatically shut down the fan system when smoke is detected within the system.]~~

~~[708.14.2.4.3 Separate systems. A separate fan system shall be used for each elevator hoistway.]~~

~~[708.14.2.4.4 Fan capacity. The supply fan shall either be adjustable with a capacity of at least 1,000 cfm (0.4719 m³/s) per door, or that specified by a registered design professional to meet the requirements of a designed pressurization system.]~~

~~[708.14.2.5 Standby power. The pressurization system shall be provided with standby power from the same source as other required emergency systems for the building.]~~

~~[708.14.2.6 Activation of pressurization system. The elevator pressurization system shall be activated upon activation of the building fire alarm system or upon activation of the elevator lobby smoke detectors. Where both a building fire alarm system and elevator lobby smoke detectors are present, each shall be independently capable of activating the pressurization system.]~~

~~[708.14.2.7 Special inspection. Special inspection for performance shall be required in accordance with Section 909.18.8. System acceptance shall be in accordance with Section 909.19.]~~

~~[708.14.2.8 Marking and identification. Detection and control systems shall be marked in accordance with Section 909.14.]~~

~~[708.14.2.9 Control diagrams. Control diagrams shall be provided in accordance with Section 909.15.]~~

~~[708.14.2.10 Control panel. A control panel complying with Section 909.16 shall be provided.]~~

~~[708.14.2.11 System response time. Hoistway pressurization systems shall comply with the requirements for smoke control system response time in Section 909.17.]~~

SECTION BC ~~709~~ 708
FIRE PARTITIONS

~~[709.1]~~ **708.1 General.** The following wall assemblies shall comply with this section.

1. Separation walls as required by Section 420.2 for Groups I-1, R-1, R-2 and R-3.
2. Walls separating tenant spaces in covered and open mall buildings as required by Section ~~[402.7.2]~~ 402.4.2.1.
- ~~[2.]~~ 3. Corridor walls as required by Section ~~[4018.1]~~ 1020.1.
4. Egress balconies as required by Section 1021.2.

~~[709.2]~~ **708.2 Materials.** The walls shall be of materials permitted by the building type of construction.

~~[709.3]~~ **708.3 Fire-resistance rating.** Fire partitions shall have a fire-resistance rating of not less than 1 hour.

Exception: Interior corridor walls as permitted by Table ~~[4018.1.4]~~ 1020.1.

~~[709.4]~~ **708.4 Continuity.** Fire partitions shall extend from the top of the foundation or ~~[floor/ceiling]~~ floor/ceiling assembly below to the underside of the floor or roof sheathing, slab or deck above or to the fire-resistance-rated floor/ceiling or roof/ceiling assembly above, and shall be securely attached thereto. If the fire partitions are not continuous to the sheathing, deck~~]~~ or slab, the space between the ceiling and the sheathing, deck or slab above shall be fire blocked or draft stopped in accordance with Sections ~~[717.2.4]~~ 718.2 and ~~[717.3.4]~~ 718.3 at the partition line. The supporting construction shall be protected to afford the required fire-resistance rating of the wall supported.

Exceptions:

1. The fire ~~[partition]~~ partitions separating tenant spaces in a covered or open mall building, complying with Section ~~[402.7.2]~~ 402.4.2.1, ~~[is]~~ are not required to extend beyond the underside of a ceiling that is not part of a fire-resistance-rated assembly. A wall is not required in attic or ceiling spaces above tenant separation walls. However, fireblocking or draftstopping shall be provided in accordance with Section 718.
2. ~~[Fireblocking]~~ Attic fireblocking or draftstopping is not required at the partition line in Group R-2 buildings that do not exceed four stories above grade plane, provided the attic space is subdivided by draftstopping into areas not exceeding 3,000 square feet (~~[279]~~ 278.8 m²) or above every two dwelling units, whichever is smaller.
3. Fireblocking or draftstopping is not required at the partition line in buildings equipped with an automatic sprinkler system installed throughout in accordance with Section 903.3.1.1 or 903.3.1.2, provided that automatic sprinklers are installed in combustible floor/ceiling and roof/ceiling spaces.

[709.5] 708.5 Exterior walls. Where exterior walls serve as a part of a required fire-resistance-rated separation, such walls shall comply with the requirements of Section 705 for exterior walls, and the fire-resistance-rated separation requirements shall not apply.

Exception: Exterior walls required to be fire-resistance-rated in accordance with Section ~~[1019.2]~~ 1021.2 for exterior egress balconies, Section ~~[1022.6]~~ 1023.7 for ~~[exit enclosures]~~ interior exit stairways and ramps and Section ~~[1026.6]~~ 1027.6 for exterior exit ~~[ramps and]~~ stairways and ramps.

[709.6] 708.6 Openings. Openings in a fire partition shall be protected in accordance with Section ~~[715]~~ 716.

[709.7] 708.7 Penetrations. Penetrations through fire partitions shall comply with Section ~~[713]~~ 714.

[709.8] 708.8 Joints. Joints made in or between fire partitions shall comply with Section ~~[714]~~ 715.

[709.9] 708.9 Ducts and air transfer openings. Penetrations in a fire partition by ducts and air transfer openings shall comply with Section ~~[716]~~ 717.

SECTION BC ~~[710]~~ 709 SMOKE BARRIERS

[710.1] 709.1 General. ~~[Smoke]~~ Vertical and horizontal smoke barriers shall comply with this section.

[710.2] 709.2 Materials. Smoke barriers shall be of materials permitted by the building type of construction.

[710.3] 709.3 Fire-resistance rating. A 1-hour fire-resistance rating is required for smoke barriers.

Exception: Smoke barriers constructed of minimum 0.10-inch~~[-thick]~~ (2.5 mm) thick steel in Group I-3 buildings.

[710.4] 709.4 Continuity. Smoke barriers shall form an effective membrane continuous from ~~[outside wall to outside wall and from]~~ the top of the foundation or floor/ceiling assembly below to the underside of the floor or roof sheathing, deck~~[-]~~ or slab above, including continuity through concealed spaces, such as those found above suspended ceilings, and interstitial structural and mechanical spaces. The supporting construction shall be protected to afford the required fire-resistance rating of the wall or floor supported in buildings of other than Type IIB, IIIB or VB construction. Smoke barrier walls used to separate smoke compartments shall comply with Section 709.4.1. Smoke-barrier walls used to enclose areas of refuge in accordance with Section 1009.6.4 or to enclose elevator lobbies in accordance with Section 405.4.3, 3007.6.2, or 3008.7.2 shall also comply with Section 709.4.2.

Exception: Smoke barrier walls are not required in interstitial spaces where such spaces are designed and constructed with ceilings or exterior walls that provide resistance to the passage of fire and smoke equivalent to that provided by the smoke barrier walls.

709.4.1 Smoke-barrier walls separating smoke compartments. Smoke-barrier walls used to separate smoke compartments shall form an effective membrane continuous from outside wall to outside wall.

709.4.2 Smoke-barrier walls enclosing areas of refuge or elevator lobbies. Smoke-barrier walls used to enclose areas of refuge in accordance with Section 1009.6.4, or to enclose elevator lobbies in accordance with Sections 405.4.3, 3007.6.2, or 3008.7.2, shall form an effective membrane enclosure that terminates at a fire barrier wall, provided such fire barrier wall has a level of fire protection rating not less than 1 hour, or that terminates at another smoke barrier wall or an outside wall. A smoke and draft control door assembly as specified in Section 716.5.3.1 shall not be required at each elevator hoistway door opening or at each exit doorway between an area of refuge and the enclosure of interior exit stairways or ramps or exit passageways.

[710.5] 709.5 Openings. Openings in a smoke barrier shall be protected in accordance with Section ~~[715]~~ 716.

Exceptions:

1. In Group I-1, Group I-2 and Group B ambulatory care facilities, where ~~[doors are installed across corridors,]~~ a pair of opposite-swinging doors ~~[without a center mullion shall be installed having vision panels with fire protection rated glazing materials in approved fire resistance rated frames, the area of which shall not exceed that tested]~~ are installed across a corridor in accordance with Section 709.5.1, the doors shall not be required to be protected in accordance with Section 716. The doors shall be close fitting within operational tolerances, and shall not have a center mullion or undercuts in excess of $\frac{3}{4}$ -inch (19.1 mm), louvers or grilles. The doors shall have head and jamb stops, and astragals or rabbets at meeting edges ~~[and shall be automatic closing by smoke detection in accordance with Section 715.4.8.3]~~. Where permitted by the door manufacturer's listing, ~~[positive latching]~~ positive-latching devices are not required.
2. In Group I-1, Group I-2 and Group B and ambulatory care facilities, horizontal sliding doors installed in accordance with Section ~~[1008.1.4.3]~~ 1010.1.4.3 and protected in accordance with Section ~~[715]~~ 716.

709.5.1 Group I-2 and ambulatory care facilities. In Group I-2 and Group B ambulatory care facilities, where doors are installed across a corridor, the doors shall be automatic-closing by smoke detection in accordance with Section 716.5.9.3 and shall have a vision panel with fire-protection-rated glazing materials in fire-protection-rated frames, the area of which shall not exceed that tested.

[710.6] 709.6 Penetrations. Penetrations through smoke barriers shall comply with Section ~~[713]~~ 714.

[710.7] 709.7 Joints. Joints made in or between smoke barriers shall comply with Section ~~[714]~~ 715.

[710.8] 709.8 Duct and air transfer openings. Penetrations by duct and air transfer openings shall comply with Section ~~[716]~~ 717.

SECTION BC ~~[711]~~ 710 SMOKE PARTITIONS

~~[711.1]~~ **710.1 General.** Smoke partitions installed as required elsewhere in the code shall comply with this section.

~~[711.2]~~ **710.2 Materials.** Smoke partitions shall be constructed of noncombustible materials. Glazing may be used provided it is heat-strengthened or tempered glazing complying and shall otherwise comply with Chapter 24, and shall be protected by sprinkler heads installed in a maximum of 6 feet (~~[1829]~~ 1828.8 mm) on center on each side of the smoke partition.

~~[711.3]~~ **710.3 Fire-resistance rating.** Unless required elsewhere in the code, smoke partitions are not required to have a fire-resistance rating.

~~[711.4]~~ **710.4 Continuity.** Smoke partitions shall extend from the top of the foundation or floor below to the underside of the floor or roof sheathing, deck~~[,]~~ or slab above or to the underside of the ceiling above where the ceiling membrane is constructed to limit the transfer of smoke.

~~[711.5]~~ **710.5 Openings.** ~~[Windows shall be sealed to resist the free passage of smoke or be automatic-closing upon detection of smoke. Doors in smoke partitions shall comply with this section.]~~ Openings in smoke partitions shall comply with Sections 710.5.1 and 710.5.2.

710.5.1 Windows. Windows in smoke partitions shall be sealed to resist the free passage of smoke or be automatic-closing upon detection of smoke.

710.5.2 Doors. Doors in smoke partitions shall comply with Sections 710.5.2.1 through 710.5.2.3.

~~[711.5.1]~~ **710.5.2.1 Louvers.** Doors in smoke partitions shall not include louvers.

~~[711.5.2]~~ **710.5.2.2 Smoke and draft-control doors.** Where required elsewhere in the code, doors in smoke partitions shall meet the requirements for a smoke and draft control door assembly tested in accordance with UL 1784. The air leakage rate of the door assembly shall not exceed 3.0 cubic feet per minute per square foot (0.015424 m³/s m²) of door opening at 0.10 inch (24.9 Pa) of water for both the ambient temperature test and the elevated temperature exposure test. Installation of smoke doors shall be in accordance with NFPA 105.

710.5.2.2.1 Smoke and draft control door labeling. Smoke and draft control doors complying only with UL 1784 shall be permitted to show the letter “S” on the manufacturer’s labeling.

~~[711.5.3]~~ **710.5.2.3 Self-closing or automatic-closing doors.** Where required elsewhere in the code, doors in smoke partitions shall be ~~[self-closing]~~ self- or automatic-closing by smoke detection in accordance with Section ~~[715.4.8.3]~~ 716.5.9.3.

~~[711.6]~~ **710.6 Penetrations ~~[and joints]~~.** The space around penetrating items ~~[and in joints]~~ shall be filled with an approved material to limit the free passage of smoke.

710.7 Joints. Joints shall be filled with an approved material to limit the free passage of smoke.

~~[711.7]~~ **710.8 Ducts and air transfer openings.** The space around a duct penetrating a smoke partition shall be filled with an approved material to limit the free passage of smoke. Air transfer openings in smoke partitions shall be provided with a smoke damper complying with Section ~~[716.3.2]~~ 717.3.2.2.

Exception: Where the installation of a smoke damper will interfere with the operation of a required smoke control system in accordance with Section 909, approved alternative protection shall be utilized.

SECTION BC ~~[712]~~ 711 HORIZONTAL ASSEMBLIES

~~[712.1 General. Floor and roof assemblies required to have a fire resistance rating shall comply with this section.]~~ **711.1 General.** Horizontal assemblies shall comply with Section 711.2. Nonfire-resistance-rated floor and roof assemblies shall comply with Section 711.3.

711.2 Horizontal assemblies. Horizontal assemblies shall comply with Sections 711.2.1 through 711.2.6.

~~[712.2]~~ **711.2.1 Materials.** ~~[The floor and roof assemblies]~~ Horizontal assemblies shall be of materials permitted by the building type of construction.

[Exception:]

711.2.1.1 Noncombustible materials. Horizontal floor or roof assemblies shall be of noncombustible materials when such assemblies serve as [a] horizontal ~~[offset]~~ offsets to [a] fire ~~[wall]~~ walls or fire ~~[barrier that is]~~ barriers required to be noncombustible.

~~[712.3 Fire resistance rating. The fire resistance rating of floor and roof assemblies shall not be less than that required by the building type of construction. Where the floor assembly separates mixed occupancies, the assembly shall have a fire resistance rating of not less than that required by Section 508.4 based on the occupancies being separated. Where the floor assembly separates a single occupancy into different fire areas, the assembly shall have a fire resistance rating of not less than that required by Section 707.3.9. Horizontal assemblies separating dwelling units in Group I-1 or R occupancies shall be a minimum of 1-hour fire resistance-rated construction.]~~

~~[712.3.1 Ceiling panels. Where the weight of lay-in ceiling panels, used as part of fire resistance-rated floor/ceiling or roof/ceiling assemblies, is not adequate to resist an upward force of 1 pound per square foot (48 Pa), wire or other approved devices shall be installed above the panels to prevent vertical displacement under such upward force.]~~

~~[712.3.2 Access doors. Access doors shall be permitted in ceilings of fire resistance-rated floor/ceiling and roof/ceiling assemblies provided such doors are tested in accordance with ASTM E 119 or UL 263 as horizontal assemblies and labeled by an approved agency for such purpose.]~~

~~[712.3.3 Unusable space. In 1-hour fire resistance-rated floor assemblies, the ceiling membrane is not required to be installed over unusable crawl spaces not intended for occupancy or storage.]~~

less than 24 inches (610 mm) in height. In 1-hour fire-resistance-rated roof assemblies, the floor membrane is not required to be installed where the unusable attic space above is not intended for occupancy or storage.]

~~[712.4 Continuity. Assemblies shall be continuous without openings, penetrations or joints except as permitted by this section and Sections 708.2, 713.4, 714, and 1022.1. Skylights and other penetrations through a fire-resistance-rated roof deck or slab are permitted to be unprotected, provided that the structural integrity of the fire-resistance-rated roof assemblies is maintained. Unprotected skylights shall not be permitted in roof construction required to be fire-resistance-rated in accordance with Section 705.8.6. The supporting construction shall be protected to afford the required fire-resistance rating of the horizontal assembly supported.]~~

~~[Exception: In buildings of Type IIB, IIIB, or VB construction, the construction supporting the horizontal assembly is not required to be fire-resistance-rated at the following:]~~

- ~~[1. Horizontal assemblies at the separations of incidental uses as specified by Table 509, provided the required fire-resistance rating does not exceed 1 hour.]~~
- ~~[2. Horizontal assemblies at the separations of dwelling units and sleeping units as required by Section 420.3.]~~
- ~~[3. Horizontal assemblies at smoke barriers constructed in accordance with Section 710.]~~

~~[712.5 Penetrations. Penetrations of horizontal assemblies shall comply with Section 713.]~~

~~[712.6 Joints. Joints made in or between fire-resistance-rated horizontal assemblies shall comply with Section 714. The void created at the intersection of a floor/ceiling assembly and an exterior curtain wall assembly shall be protected in accordance with Section 714.4.]~~

~~[712.7 Ducts and air transfer openings. Penetrations in horizontal assemblies by ducts and air transfer openings shall comply with Section 716.]~~

~~[712.8 Floor fire door assemblies. Floor fire door assemblies used to protect openings in fire-resistance-rated floors shall be tested in accordance with NFPA 288, and shall achieve a fire-resistance rating not less than the assembly being penetrated. Floor fire door assemblies shall be labeled by an approved agency. The label shall be permanently affixed and shall specify the manufacturer, the test standard and the fire-resistance rating.]~~

~~[712.9 Smoke barrier. Where horizontal assemblies are required to resist the movement of smoke by other sections of this code in accordance with the definition of smoke barrier, penetrations and joints in such horizontal assemblies shall be protected as required for smoke barriers in accordance with Sections 713.5 and 714.6. Openings through horizontal assemblies shall be protected by shaft enclosures complying with Section 708. Horizontal assemblies shall not be allowed to have unprotected vertical openings.]~~

711.2.2 Continuity. Assemblies shall be continuous without vertical openings, except as permitted by this section and Section 712.

711.2.3 Supporting construction. The supporting construction shall be protected to afford the required fire-resistance rating of the horizontal assembly supported.

Exception: In buildings of Type IIB, IIIB or VB construction, the construction supporting the horizontal assembly is not required to be fire-resistance-rated at the following:

1. Horizontal assemblies at the separations of incidental uses as specified by Table 509 provided the required fire-resistance rating does not exceed 1 hour.
2. Horizontal assemblies at the separations of dwelling units and sleeping units as required by Section 420.3.
3. Horizontal assemblies at smoke barriers constructed in accordance with Section 709.

711.2.4 Fire-resistance rating. The fire-resistance rating of horizontal assemblies shall comply with Sections 711.2.4.1 through 711.2.4.6 but shall be not less than that required by the building type of construction.

711.2.4.1 Separating mixed occupancies. Where the horizontal assembly separates mixed occupancies, the assembly shall have a fire-resistance rating of not less than that required by Section 508.4 based on the occupancies being separated.

711.2.4.2 Separating fire areas. Where the horizontal assembly separates a single occupancy into different fire areas, the assembly shall have a fire-resistance rating of not less than that required by Section 707.3.10.

711.2.4.3 Dwelling units and sleeping units. Horizontal assemblies serving as dwelling or sleeping unit separations in accordance with Section 420.3, located in Group I-1 and R occupancies, shall be not less than 1-hour fire-resistance-rated construction.

711.2.4.4 Separating smoke compartments. Where the horizontal assembly is required to be a smoke barrier, the assembly shall comply with Section 709.

711.2.4.5 Separating incidental uses. Where the horizontal assembly separates incidental uses from the remainder of the building, the assembly shall have a fire-resistance rating of not less than that required by Section 509.

711.2.4.6 Other separations. Where a horizontal assembly is required by other sections of this code, the most restrictive fire-resistance rating shall govern.

711.2.5 Ceiling panels. Where the weight of lay-in ceiling panels, used as part of fire-resistance-rated floor/ceiling or roof/ceiling assemblies, is not adequate to resist an upward force of 1 pound per square foot (47.8 Pa), wire or other approved devices shall be installed above the panels to prevent vertical displacement under such upward force.

711.2.6 Crawl spaces. In 1-hour fire-resistance-rated floor/ceiling assemblies, the ceiling membrane is not required to be installed over crawl spaces that are not intended for occupancy or storage and that are less than 24 inches (609.6 mm) in height. Where the ceiling membrane is not provided, occupancy or storage is not permitted in the crawl space.

711.2.7 Attic spaces. In 1-hour fire-resistance-rated roof assemblies, the floor membrane is not required to be installed where the attic space above the floor membrane is not intended for occupancy or storage. Where the floor membrane is not provided, occupancy or storage is not permitted in the attic space.

711.3 Nonfire-resistance-rated floor and roof assemblies. Nonfire-resistance-rated floor, floor/ceiling, roof and roof/ceiling assemblies shall comply with Sections 711.3.1 and 711.3.2.

711.3.1 Materials. Assemblies shall be of materials permitted by the building type of construction.

711.3.2 Continuity. Assemblies shall be continuous without vertical openings, except as permitted by Section 712.

SECTION BC 712 **VERTICAL OPENINGS**

712.1 General. Each vertical opening shall comply in accordance with one of the protection methods in Sections 712.1.1 through 712.1.16.

712.1.1 Shaft enclosures. Vertical openings contained entirely within a shaft enclosure complying with Section 713 shall be permitted.

712.1.2 Individual dwelling unit. Unconcealed vertical openings totally within an individual residential dwelling unit and connecting four stories or less, where such dwelling unit is fully sprinklered in accordance with Sections 903.3.1.1, 903.3.1.2 or 903.3.1.3, shall be permitted.

712.1.3 Escalator openings. Where a building is equipped throughout with an automatic sprinkler system in accordance with Section 903.3.1.1, vertical openings for escalators shall be permitted where protected in accordance with Section 712.1.3.1 or 712.1.3.2.

712.1.3.1 Opening size. Protection by a draft curtain and closely spaced sprinklers in accordance with NFPA 13, as modified by Appendix Q of this code, shall be permitted where the area of the vertical opening between stories does not exceed twice the horizontal projected area of the escalator or stairway. In other than Groups B and M, this application is limited to openings that do not connect more than four stories.

712.1.3.2 Automatic shutters. Protection of the vertical opening by approved shutters at every penetrated floor shall be permitted in accordance with this section. The shutters shall be of noncombustible construction and have a fire-resistance rating of not less than 1.5 hours. The shutter shall be so constructed as to close immediately upon the actuation of a smoke detector installed in accordance with Section 907.3.1 and shall completely shut off the well opening. Escalators shall cease operation when the shutter begins to close. The shutter shall operate at a speed of not more than 30 feet per minute (152.4 mm/s) and shall be equipped with a sensitive leading edge to arrest its progress where in contact with any obstacle, and to continue its progress on release there from.

712.1.4 Penetrations. Penetrations, concealed and unconcealed, shall be permitted where protected in accordance with Section 714.

712.1.5 Joints. Joints shall be permitted where complying with Section 712.1.5.1 or 712.1.5.2, as applicable.

712.1.5.1 Joints in or between horizontal assemblies. Joints made in or between horizontal assemblies shall comply with Section 715. The void created at the intersection of a floor/ceiling assembly and an exterior curtain wall assembly shall be permitted where protected in accordance with Section 715.4.

712.1.5.2 Joints in or between nonfire-resistance-rated floor assemblies. Joints in or between floor assemblies without a required fire-resistance rating shall be permitted where they comply with one of the following:

1. The joint shall be concealed within the cavity of a wall.
2. The joint shall be located above a ceiling.
3. The joint shall be sealed, treated or covered with an approved material or system to resist the free passage of flame and the products of combustion.

Exception: Joints meeting one of the exceptions listed in Section 715.1.

712.1.6 Ducts and air transfer openings. Penetrations by ducts and air transfer openings shall be protected in accordance with Section 717. Grease ducts shall be protected in accordance with the *New York City Mechanical Code*.

712.1.7 Atriums. In other than Group H occupancies, atriums complying with Section 404 shall be permitted.

712.1.8 Masonry chimney. Approved vertical openings for masonry chimneys shall be permitted where the annular space is fireblocked at each floor level in accordance with Section 718.2.5.

712.1.9 Two-story openings. In other than Groups I-2 and I-3, a vertical opening that is not used as one of the applications listed in this section shall be permitted if the opening complies with all of the items below:

1. Does not connect more than two stories.
2. Does not penetrate a horizontal assembly that separates fire areas or smoke barriers that separate smoke compartments.
3. Is not concealed within the construction of a wall or a floor/ceiling assembly.
4. Is not open to a corridor in Group I and R occupancies, where such corridor is required to be fire-resistance-rated in accordance with Table 1020.1.

5. Is not open to a corridor on nonsprinklered floors, where such corridor is required to be fire-resistance-rated in accordance with Table 1020.1.
6. Is separated from floor openings and air transfer openings serving other floors by construction conforming to required shaft enclosures.

712.1.10 Parking garages. Vertical openings in parking garages for automobile ramps, elevators and duct systems shall comply with Section 712.1.10.1, 712.1.10.2 or 712.1.10.3, as applicable.

712.1.10.1 Automobile ramps. Vertical openings for automobile ramps in open and enclosed parking garages shall be permitted where constructed in accordance with Sections 406.5 and 406.6, respectively.

712.1.10.2 Elevators. Vertical openings for elevator hoistways in open and enclosed parking garages that serve only the parking garage, and complying with Sections 406.5 and 406.6, respectively, shall be permitted.

712.1.10.3 Duct systems. Vertical openings for mechanical exhaust or supply duct systems in open or enclosed parking garages complying with Sections 406.5 and 406.6, respectively, shall be permitted to be unenclosed where such duct system is contained within and serves only the parking garage.

712.1.11 Mezzanine. Vertical openings between a mezzanine complying with Section 505 and the floor below shall be permitted.

712.1.12 Exit access stairways and ramps. Vertical openings containing exit access stairways or ramps in accordance with Section 1019 shall be permitted.

712.1.13 Openings. Vertical openings for floor fire doors and access doors shall be permitted where protected by Section 712.1.13.1 or 712.1.13.2.

712.1.13.1 Horizontal fire door assemblies. Horizontal fire door assemblies used to protect openings in fire-resistance-rated horizontal assemblies shall be tested in accordance with NFPA 288, and shall achieve a fire-resistance rating not less than the assembly being penetrated. Horizontal fire door assemblies shall be labeled by an approved agency. The label shall be permanently affixed and shall specify the manufacturer, the test standard and the fire-resistance rating.

712.1.13.2 Access doors. Access doors shall be permitted in ceilings of fire-resistance-rated floor/ceiling and roof/ceiling assemblies, provided such doors are tested in accordance with ASTM E 119 or UL 263 as horizontal assemblies and labeled by an approved agency for such purpose.

712.1.14 Group I-3. In Group I-3 occupancies, vertical openings shall be permitted in accordance with Section 408.5.

712.1.15 Skylights. Skylights and other penetrations through a fire-resistance-rated roof deck or slab are permitted to be unprotected, provided that the structural integrity of the fire-resistance-rated roof assembly is maintained. Unprotected skylights shall not be permitted in roof assemblies

required to be fire-resistance-rated in accordance with Section 705.8.6. The supporting construction shall be protected to afford the required fire-resistance rating of the horizontal assembly supported.

712.1.16 Openings otherwise permitted. Vertical openings shall be permitted where allowed by other sections of this code.

SECTION BC 713 **SHAFT ENCLOSURES**

713.1 General. The provisions of this section shall apply to shafts required to protect openings and penetrations through floor/ceiling and roof/ceiling assemblies. Interior exit stairways and ramps shall be enclosed in accordance with Section 1023.

713.2 Construction. Shaft enclosures shall be constructed as fire barriers in accordance with Section 707 or horizontal assemblies in accordance with Section 711, or both.

713.3 Materials. The shaft enclosure shall be of materials permitted by the building type of construction.

Exception: Noncombustible materials shall be used for shaft enclosures in Group I-1, R-1 and R-2 buildings irrespective of the building type of construction.

713.4 Fire-resistance rating. Shaft enclosures shall have a fire-resistance rating of not less than 2 hours where penetrating three stories or more, and not less than 1 hour where penetrating fewer than three stories. The number of stories connected by the shaft enclosure shall include any basements or cellars, but not any mezzanines. Shaft enclosures shall have a fire-resistance rating not less than the floor assembly penetrated, but need not exceed 2 hours. Shaft enclosures shall meet the requirements of Section 703.2.1.

713.5 Continuity. Shaft enclosures shall be constructed as fire barriers in accordance with Section 707 or horizontal assemblies constructed in accordance with Section 711, or both. Where the roof construction is of combustible materials, shaft enclosure walls shall extend through the roof construction not less than 30 inches (762 mm) above the roof. Where the roof construction is of noncombustible materials, shaft enclosure walls shall extend from the top of the floor/ceiling assembly below to the underside of the floor or roof slab or deck above and shall be securely attached thereto. These walls shall be continuous through concealed spaces such as the space above a suspended ceiling. The supporting construction shall be protected to afford the required fire-resistance rating of the element supported. Hollow vertical spaces within the shaft enclosure construction wall shall be firestopped at every floor level.

Exception: A shaft enclosure of a refuse or laundry chute shall extend through combustible or noncombustible roof construction not less than 6 feet (1828.9 mm) above the roof.

713.6 Exterior walls. Where exterior walls serve as a part of a required shaft enclosure, such walls shall comply with the requirements of Section 705 for exterior walls and the fire-resistance-rated enclosure requirements of Section 713.4 shall not apply.

Exception: Exterior walls required to be fire-resistance-rated in accordance with Section 1021.2 for exterior egress balconies, Section 1023.7 for interior exit stairways and ramps and Section 1027.6 for exterior exit stairways and ramps.

713.7 Openings. Openings in a shaft enclosure shall be protected in accordance with Section 716 as required for fire barriers. Doors shall be self- or automatic-closing by smoke detection in accordance with Section 716.5.9.3. Automatic-closing by smoke detection is not permitted for doors serving interior exit stairways or ramps.

Exception: For no more than one interior exit stairway or ramp in a building, doors serving such enclosure may be automatic-closing by smoke detection provided that all the following conditions are satisfied:

1. The building contains no Group H space and:
 - 1.1. Is not a high-rise building pursuant to Section 403.1 of this code, or for the purposes of prior code buildings, Section 27-232 of the *Administrative Code*, and is equipped with a fire alarm system; or
 - 1.2. Is equipped with fire alarm systems and automatic sprinkler systems throughout;
or
 - 1.3. Is a high-rise office building, as such term is defined in Section 27-232 of the *Administrative Code*, that is 100 feet (30 480 mm) or more in height, equipped with a fire alarm system and subdivided into compartments pursuant to subdivision c of Section 27-339 of the *Administrative Code*.
2. Such doors serve no more than three levels within such vertical exit enclosure, which must be consecutive levels.
3. All levels served by such doors are served by not less than one other exit.
4. Such doors are connected to a fire alarm system and installed in accordance with NFPA 80 and Section 716.5.9.3 of this code.
5. The hold-open devices of such doors:
 - 5.1. Are capable of manual release at the fire command center, or if a fire command center is not required, at a fire alarm control panel that is near the main building entrance; and
 - 5.2. Are capable of manual release by pulling the doors to the closed position.

713.7.1 Prohibited openings. Openings other than those necessary for the purpose of the shaft shall not be permitted in shaft enclosures.

713.8 Penetrations. Penetrations in a shaft enclosure shall be protected in accordance with Section 714 as required for fire barriers. Structural elements, such as beams or joists, where protected in accordance with Section 714 shall be permitted to penetrate a shaft enclosure.

713.8.1 Prohibited penetrations. Penetrations other than those necessary for the purpose of the shaft shall not be permitted in shaft enclosures.

713.9 Joints. Joints in a shaft enclosure shall comply with Section 715.

713.10 Duct and air transfer openings. Penetrations of a shaft enclosure by ducts and air transfer openings shall comply with Section 717.

713.11 Enclosure at the bottom. Shafts that do not extend to the bottom of the building or structure shall comply with one of the following:

1. They shall be enclosed at the lowest level with construction of the same fire-resistance rating as the lowest floor through which the shaft passes, but not less than the rating required for the shaft enclosure.
2. They shall terminate in a room having a use related to the purpose of the shaft. The room shall be separated from the remainder of the building by fire barriers constructed in accordance with Section 707 or horizontal assemblies constructed in accordance with Section 711, or both. The fire-resistance rating and opening protectives shall be not less than the protection required for the shaft enclosure.

Exceptions:

1. The fire-resistance-rated room separation is not required, provided there are no openings in or penetrations of the shaft enclosure to the interior of the building except at the bottom. The bottom of the shaft shall be closed off around the penetrating items with materials permitted by Section 718.3.1 for draftstopping, or the room shall be provided with an approved automatic sprinkler system.
2. A shaft enclosure containing a waste or linen chute shall not be used for any other purpose and shall discharge into a room protected in accordance with Section 713.13.4.
3. The fire-resistance-rated room separation and the protection at the bottom of the shaft are not required provided there are no combustibles in the shaft and there are no openings or other penetrations through the shaft enclosure to the interior of the building.

713.12 Enclosure at the top. Shafts that do not extend to the top of the building or structure shall comply with one of the following:

1. They shall be enclosed at the highest level with construction of the same fire-resistance rating as the highest floor through which the shaft passes, but not less than the rating required for the shaft enclosure.
2. They shall terminate in a room having a use related to the purpose of the shaft. The room shall be separated from the remainder of the building by construction having a fire-resistance rating and opening protective not less than the protection required for the shaft enclosure.

713.12.1 Smoke venting of stair and other closed shafts. All closed shafts, including vertical exit enclosures, having a floor area exceeding 4 square feet (0.37 m²) shall be provided with a smoke vent in accordance with Sections 713.12.1.1 through 713.12.1.3. Interior vertical exit shaft enclosures shall also comply with Chapter 10.

Exceptions:

1. Elevator and dumbwaiter shafts in accordance with Chapter 30.
2. Interior exit stairways and ramps constructed as smokeproof enclosures in accordance with Section 1023.11.

713.12.1.1 Smoke vent construction. Smoke vents may be constructed as windows, louvers, skylights, vent ducts, or similar devices, and shall be approved for such use. Where a vent duct is installed, such vent duct shall be enclosed by construction having the same fire-resistance rating as required for the shaft enclosure.

713.12.1.2 Smoke vent dimensions. The effective venting area shall be not less than 3½ percent of the maximum shaft area at any floor, but in no event less than 72 square inches (46 451.5 mm²).

713.12.1.3 Smoke vent location. Smoke vents shall be located in accordance with Section 713.12.1.3.1 or 713.12.1.3.2, as applicable.

713.12.1.3.1 Smoke vents located above the roof line. Where a closed shaft or smoke vent duct penetrates through the roof of the building, the vent shall be approved for such use and located as follows:

1. The vent shall be located not less than 8 inches (203.2 mm) above a noncombustible roof assembly or not less than 36 inches (914.4 mm) above a combustible roof assembly.
2. The vent shall be located not less than 10 feet (3048 mm) from any window, door, exterior stairway, or interior lot line. The vent may be located not less than 5 feet (1524 mm) from any window or door provided that the vent is located at a point higher than the top of such window or door.
3. Where the vent is constructed as a window or louver, the sill of the window or louver shall be located not less than 36 inches (914.4 mm) above the roof assembly.

713.12.1.3.2 Smoke vents located in an exterior wall. Where a smoke vent is located in an exterior wall, openings in the wall are prohibited within an area 30 feet (9144 mm) vertically above the vent opening and 5 feet (1524 mm) horizontally on either side of the vent opening.

713.13 Waste and linen chutes, including discharge rooms, and incinerator rooms. Waste and linen chutes, and discharge rooms for such chutes, shall comply with the provisions of NFPA 82,

Chapter 6 of this code and shall meet the requirements of Sections 713.13.1 through 713.13.6 of this code. Incinerator rooms shall meet the provisions of Sections 713.13.4 through 713.13.5 of this code.

Exception: Chutes serving and contained within a single dwelling unit.

713.13.1 Waste and linen. A shaft enclosure containing a recycling, or waste or linen chute, and any associated discharge room, shall not be used for any other purpose and shall have a fire-resistance rating of 2 hours. Openings into the shaft, including those from access rooms and discharge rooms, shall be protected in accordance with this section and Section 716. Openings into chutes shall not be located in corridors. Doors into chutes shall be self-closing. Discharge doors shall be self- or automatic-closing upon the actuation of a smoke detector in accordance with Section 716.5.9.3, except that heat-activated closing devices shall be permitted between the shaft and the discharge room.

713.13.2 Materials. A shaft enclosure containing a waste, recycling, or linen chute shall be constructed of noncombustible materials.

713.13.3 Waste and linen chute access rooms. Access openings for waste and linen chutes shall be located in dedicated rooms or compartments enclosed by not less than 2-hour fire barriers constructed in accordance with Section 707 or horizontal assemblies constructed in accordance with Section 711 or both. Openings into the access rooms shall be protected by opening protectives having a fire protection rating of not less than 1½ hours. Doors to access rooms shall be self-closing, except where the storage of waste, including recyclables, or linen and other laundry, is not permitted in such access room, doors may be automatic-closing upon the detection of smoke in accordance with Section 716.5.9.3.

Exception: Access openings for waste or linen chutes located within a dwelling unit need not be located within a separate room or compartment.

713.13.4 Chute discharge room. Waste or linen chutes shall discharge into an enclosed room separated by not less than 3-hour fire barriers constructed in accordance with Section 707 or by horizontal assemblies constructed in accordance with Section 711, or both. Openings into the discharge room from the remainder of the building shall be protected by opening protectives having a fire protection rating equal to the protection required for the shaft enclosure. Doors shall be self- or automatic-closing upon the detection of smoke in accordance with Section 716.5.9.3. Waste chutes shall not terminate in an incinerator room. Waste and linen rooms that are not provided with chutes need only comply with Table 509.

Exception: Opening protectives shall not be required at a waste or linen chute opening to a discharge room.

713.13.5 Incinerator room. Incinerator rooms shall comply with Table 509.

713.13.6 Automatic sprinkler system. An approved automatic sprinkler system shall be installed in accordance with Section 903.2.11.6.

713.14 Elevator, dumbwaiter and other hoistways. Elevator, dumbwaiter and other hoistway enclosures shall be constructed in accordance with Chapter 30 and this section.

SECTION BC ~~713~~ 714 PENETRATIONS

~~[713.1]~~ 714.1 **Scope.** The provisions of this section shall govern the materials and methods of construction used to protect ~~[through penetrations]~~ through-penetrations and ~~[membrane penetrations]~~ membrane-penetrations of horizontal assemblies and fire-resistance-rated wall assemblies.

~~[713.1.1]~~ 714.1.1 **Ducts and air transfer openings.** Penetrations of fire-resistance-rated walls by ducts that are not protected with dampers shall comply with Sections ~~[713.2]~~ 714.2 through ~~[713.3.3]~~ 714.3.3. Penetrations of horizontal assemblies not protected with a shaft as permitted by ~~[Exception 4 of]~~ Section ~~[708.2]~~ 717.6, and not required to be protected with fire dampers by other sections of this code, shall comply with Sections ~~[713.4]~~ 714.4 through ~~[713.4.2.2]~~ 714.5.2. Ducts and air transfer openings that are protected with dampers shall comply with Section ~~[716]~~ 717.

~~[713.1.2]~~ 714.1.2 **Special inspection.** All through-penetration and membrane-penetration firestop systems shall comply with the special inspection requirements of Chapter 17.

~~[713.2]~~ 714.2 **Installation details.** Where sleeves are used, they shall be securely fastened to the assembly penetrated. The space between the item contained in the sleeve and the sleeve itself and any space between the sleeve and the assembly penetrated shall be protected in accordance with this section. Insulation and coverings on or in the penetrating item shall not penetrate the assembly unless the specific material used has been tested as part of the assembly in accordance with this section.

~~[713.3]~~ 714.3 **Fire-resistance-rated walls.** Penetrations into or through fire walls, fire barriers, smoke barrier walls~~;~~ and fire partitions shall comply with Sections ~~[713.3.1]~~ 714.3.1 through ~~[713.3.3]~~ 714.3.3. Penetrations in smoke barrier walls shall also comply with Section ~~[713.5]~~ 714.4.3.

~~[713.3.1 Through penetrations. Through penetrations]~~ 714.3.1 Through-penetrations. Through-penetrations of fire-resistance-rated walls shall comply with Section ~~[713.3.1.1]~~ 714.3.1.1 or ~~[713.3.1.2]~~ 714.3.1.2.

Exception: Where the penetrating items are steel, ferrous or copper pipes, tubes or conduits, the annular space between the penetrating item and the fire-resistance-rated wall is permitted to be protected ~~[as follows:]~~ by either of the following measures:

1. In concrete or masonry walls where the penetrating item is a maximum 6-inch (~~[152]~~ 152.4 mm) nominal diameter and the area of the opening through the wall does not exceed 144 square inches (~~[(0.0929 m²)]~~ (92 903 mm²)), concrete, grout or mortar is permitted where installed the full thickness of the wall or the thickness required to maintain the fire-resistance rating~~[-or]~~.
2. The material used to fill the annular space shall prevent the passage of flame and hot gases sufficient to ignite cotton waste where subjected to ASTM E 119 or UL 263 time-temperature fire conditions under a minimum positive pressure differential of 0.01 inch (2.49 Pa) of water at the location of the penetration for the time period equivalent to the fire-resistance rating of the construction penetrated.

[713.3.1.1] 714.3.1.1 Fire-resistance-rated assemblies. Penetrations shall be installed as tested in an approved fire-resistance-rated assembly.

[713.3.1.2] 714.3.1.2 Through-penetration firestop system. [~~Through-penetrations~~] Through-penetrations shall be protected by an approved penetration [~~fire-stop~~] firestop system installed as tested in accordance with ASTM E 814 or UL 1479, with a minimum positive pressure differential of 0.01 inch (2.49 Pa) of water and shall have an F rating of not less than the required fire-resistance rating of the wall penetrated.

[713.3.2] 714.3.2 Membrane penetrations. Membrane penetrations shall be protected by a membrane penetration firestop installed in accordance with Section [~~713.3.1~~] 714.3.1. Where walls or partitions are required to have a fire-resistance rating, recessed fixtures shall be installed such that the required fire resistance will not be reduced.

Exceptions:

1. Membrane penetrations of maximum 2-hour fire-resistance-rated walls and partitions by steel electrical boxes that do not exceed 16 square inches (0.0103 m²) in area, provided the aggregate area of the openings does not exceed 100 square inches (0.0645 m²) for any 100 square feet (9.29 m²) [~~in~~] of wall area. The annular space between the wall membrane and the box shall not exceed 1/8 inch [~~(3.1 mm)]~~ (3.2 mm). Such boxes on opposite sides of the wall or [~~partitions~~] partition shall be separated by one of the following:
 - 1.1. By a horizontal distance of not less than 24 inches (~~[610]~~ 609.6 mm) where the wall or partition is constructed with individual noncommunicating stud cavities;
 - 1.2. By a horizontal distance of not less than the depth of the wall cavity where the wall cavity is filled with cellulose loose-fill, rock wool or slag mineral wool insulation;
 - 1.3. By solid fireblocking in accordance with Section [~~717.2.1~~] 718.2.1;
 - 1.4. By protecting both outlet boxes with listed putty pads; or
 - 1.5. By other listed materials and methods.
2. Membrane penetrations by listed electrical boxes of any material, provided such boxes have been tested for use in fire-resistance-rated assemblies and are installed in accordance with the instructions included in the listing. The annular space between the wall membrane and the box shall not exceed 1/8 inch [~~(3.1 mm)]~~ (3.2 mm) unless listed otherwise. Such boxes on opposite sides of the wall or partition shall be separated by one of the following:
 - 2.1. By the horizontal distance specified in the listing of the electrical boxes;
 - 2.2. By solid fireblocking in accordance with Section [~~717.2.1~~] 718.2.1;
 - 2.3. By protecting both boxes with listed putty pads; or

- 2.4. By other listed materials and methods.
3. Membrane penetrations by electrical boxes of any size or type~~[, which]~~ that have been listed as part of a wall opening protective material system for use in fire-resistance-rated assemblies and are installed in accordance with the instructions included in the listing.
4. Membrane penetrations by boxes other than electrical boxes, provided such penetrating items and the annular space between the wall membrane and the box, are protected by an approved ~~[membrane penetration]~~ membrane-penetration firestop system installed as tested in accordance with ASTM E 814 or UL 1479, with a minimum positive pressure differential of 0.01 inch (2.49 Pa) of water, and shall have an F and T rating of not less than the required fire-resistance rating of the wall penetrated and be installed in accordance with their listing.
5. The annular space created by the penetration of an automatic sprinkler, provided it is covered by a metal escutcheon plate.
6. Membrane penetrations of maximum 2-hour fire resistance-rated walls and partitions by steel electrical boxes that exceed 16 square inches (0.0103 m²) in area, or steel electrical boxes of any size having an aggregate area through the membrane exceeding 100 square inches (0.0645 m²) in any 100 square feet (9.29 m²) of wall area, provided such penetrating items are protected by listed putty pads or other listed materials and methods, and installed in accordance with the listing.

[713.3.3] 714.3.3 Dissimilar materials. Noncombustible penetrating items shall not connect to combustible items beyond the point of fire stopping unless it can be demonstrated to the commissioner that the fire-resistance integrity of the wall is maintained.

[713.4] 714.4 Horizontal assemblies. Penetrations of a fire-resistance-rated floor, floor/ceiling assembly or the ceiling membrane of a roof/ceiling assembly not required to be enclosed in a shaft by Section ~~[708.2]~~ 711.1 shall be protected in accordance with Sections ~~[713.4.1]~~ 714.4.1 through ~~[713.4.2.2]~~ 714.4.2.2.

~~[713.4.1 Fire-resistance-rated assemblies. Penetrations of the fire-resistance-rated floor, floor/ceiling assembly or the ceiling membrane of a roof/ceiling assembly shall comply with Sections 713.4.1.1 through 713.4.1.4. Penetrations in horizontal smoke barriers shall also comply with Section 713.5.]~~

~~[713.4.1.1 Through penetrations. Through penetrations]~~ **714.4.1 Through-penetrations.** Through-penetrations of ~~[fire-resistance-rated]~~ horizontal assemblies shall comply with Section ~~[713.4.1.1.1]~~ 714.4.1.1 or ~~[713.4.1.1.2]~~ 714.4.1.2.

Exceptions:

1. Penetrations by steel, ferrous or copper conduits, pipes, tubes or vents or concrete~~;~~ or masonry items through a single fire-resistance-rated floor assembly where the annular space is protected with materials that prevent the passage of flame and hot

gases sufficient to ignite cotton waste where subjected to ASTM E 119 or UL 263 time-temperature fire conditions under a minimum positive pressure differential of 0.01 inch (2.49 Pa) of water at the location of the penetration for the time period equivalent to the fire-resistance rating of the construction penetrated. Penetrating items with a maximum 6-inch (~~[152]~~ 152.4 mm) nominal diameter shall not be limited to the penetration of a single fire-resistance-rated floor assembly, provided the aggregate area of the ~~[penetration]~~ penetrations does not exceed 144 square inches (~~[92-900]~~ 92 903 mm²) in any 100 square feet (9.3 m²) of floor area.

2. Penetrations in a single concrete floor by steel, ferrous or copper conduits, pipes, tubes or vents with a maximum 6-inch (~~[152]~~ 152.4 mm) nominal diameter, provided that the concrete, grout or mortar is installed the full thickness of the floor or the thickness required to maintain the fire-resistance rating. The penetrating items shall not be limited to the penetration of a single concrete floor, provided ~~[that]~~ the area of the opening through each floor does not exceed 144 square inches (~~[92-900]~~ 92 903 mm²).
3. Penetrations by listed electrical boxes of any material, provided that such boxes have been tested for use in fire-resistance-rated assemblies and installed in accordance with the instructions included in the listing.

~~[713.4.1.1.1]~~ **714.4.1.1 Installation.** ~~[Through-penetrations]~~ Through-penetrations shall be installed as tested in the approved fire-resistance-rated assembly.

~~[713.4.1.1.2]~~ **714.4.1.2 Through-penetration firestop system.** ~~[Through-penetrations]~~ Through-penetrations shall be protected by an approved through-penetration ~~[fire-stop]~~ firestop system installed and tested in accordance with ASTM E 814 or UL 1479, with a minimum positive pressure differential of 0.01 inch (2.49 Pa) of water. The system shall have both, an F rating (flame) and a T rating (temperature) of not less than 1 hour but not less than the required rating of the floor penetrated.

~~[Exception:]~~ Exceptions:

1. Floor penetrations contained and located within the cavity of a wall do not require a T rating.
2. Floor penetrations by floor drains, tub drains or shower drains contained and located within the concealed space of a horizontal assembly do not require a T rating.
3. Floor penetrations of maximum 4-inch (101.6 mm) nominal diameter penetrating directly into metal-enclosed electrical power switchgear do not require a T rating.

~~[713.4.1.2]~~ **714.4.2 Membrane penetrations.** Penetrations of membranes that are part of a ~~[fire-resistance-rated]~~ horizontal assembly shall comply with Section ~~[713.4.1.1.1 or 713.4.1.1]~~ 714.4.1.1 or 714.4.1.2. Where floor/ceiling assemblies are required to have a fire-resistance rating, recessed fixtures shall be installed such that the required fire resistance will not be reduced.

Exceptions:

1. Membrane penetrations by steel, ferrous or copper conduits, pipes, tubes or vents, or concrete~~[-]~~ or masonry items where the annular space is protected either in accordance with Section ~~[713.4.1.1]~~ 714.4.1 or to prevent the free passage of flame and the products of combustion. The aggregate area of the openings through the membrane shall not exceed 100 square inches (64 500 mm²) in any 100 square feet (9.3 m²) of ceiling area in assemblies tested without penetrations.
2. Ceiling membrane penetrations of maximum 2-hour horizontal assemblies by steel electrical boxes that do not exceed 16 square inches (10 323 mm²) in area, provided the aggregate area of such penetrations does not exceed 100 square inches [~~(44-500 mm²)~~] (64 516 mm²) in any 100 square feet [~~(9.29 m²)~~] (9.3 m²) of ceiling area, and the annular space between the ceiling membrane and the box does not exceed 1/8 inch (3.2 mm).
3. Membrane penetrations by electrical boxes of any size or type [~~-which~~] that have been listed as part of an opening protective material system for use in horizontal assemblies and are installed in accordance with the instructions included in the listing.
4. Membrane penetrations by listed electrical boxes of any material, provided such boxes have been tested for use in fire-resistance-rated assemblies and are installed in accordance with the instructions included in the listing. The annular space between the ceiling membrane and the box shall not exceed 1/8 inch (3.2 mm) unless listed otherwise.
5. The annular space created by the penetration of a fire sprinkler, provided it is covered by a metal escutcheon plate.
6. Noncombustible items that are cast into concrete building elements and that do not penetrate both top and bottom surfaces of the element, provided such items are installed such that the required fire resistance will not be reduced.
7. The ceiling membrane of 1- and 2-hour fire-resistance-rated horizontal assemblies is permitted to be interrupted with the double wood top plate of a wall assembly that is sheathed with Type X gypsum wallboard, provided that all penetrating items through the double top plates are protected in accordance with Section 714.4.1.1 or 714.4.1.2 and the ceiling membrane is tight to the top plates.

~~[713.4.1.3 Ducts and air transfer openings. Penetrations of horizontal assemblies by ducts and air transfer openings shall comply with Section 716.]~~

714.4.3 Penetrations in smoke barriers. Penetrations in smoke barriers shall be protected by an approved through-penetration firestop system installed and tested in accordance with the requirements of UL 1479 for air leakage. The L rating of the system measured at 0.30 inch (7.47 Pa) of water in both the ambient temperature and elevated temperature tests shall not exceed:

1. 5.0 cfm per square foot (0.025 m³/ s · m²) of penetration opening for each through-penetration firestop system; or

2. A total cumulative leakage of 50 cfm (0.024 m³/s) for any 100 square feet (9.3 m²) of wall area, or floor area.

~~[713.4.2]~~ **714.5 Nonfire-resistance-rated assemblies.** Penetrations of nonfire-resistance-rated floor or floor/ceiling assemblies or the ceiling membrane of a nonfire-resistance-rated roof/ceiling assembly shall meet the requirements of Section [708] 713 or shall comply with [~~Sections 713.4.2.1 through 713.4.2]~~ Section 714.5.1 or 714.5.2.

~~[713.4.2.1]~~ **714.5.1 Noncombustible penetrating items.** Noncombustible penetrating items that connect not more than three stories are permitted, provided that the annular space is filled with an approved noncombustible material or with a fill, void or cavity material that is tested and classified for use in through-penetration firestop systems.

~~[713.4.2.2]~~ **714.5.2 Penetrating items.** Penetrating items that connect not more than two stories are permitted, provided that the annular space is filled with an approved material to resist the free passage of flame and the products of combustion.

~~[713.5 Penetrations in smoke barriers.~~ Penetrations in smoke barriers shall be tested in accordance with the requirements of UL 1479 for air leakage. The air leakage rate of the penetration assemblies measured at 0.30 inch (7.47 Pa) of water in both the ambient temperature and elevated temperature tests, shall not exceed:]

- ~~[1. 5.0 cfm per square foot (0.025 m³/s m²) of penetration opening for each through penetration firestop system; or]~~
- ~~[2. A total cumulative leakage of 50 cfm (0.024 m³/s) for any 100 square feet (9.3 m²) of wall area, or floor area.]~~

SECTION BC ~~[714]~~ 715 FIRE-RESISTANT JOINT SYSTEMS

~~[714.1]~~ **715.1 General.** Joints installed in or between fire-resistance-rated walls, floor or floor/ceiling assemblies and roofs or roof/ceiling assemblies shall be protected by an approved fire-resistant joint system designed to resist the passage of fire for a time period not less than the required fire-resistance rating of the wall, floor or roof in or between which ~~[it]~~ the system is installed. Fire-resistant joint systems shall be tested in accordance with Section [714.3] 715.3. [~~The void created at the intersection of a floor/ceiling assembly and an exterior curtain wall assembly shall be protected in accordance with Section 714.4.~~]

Exception: Fire-resistant joint systems shall not be required for joints in all of the following locations:

1. Floors within a single dwelling unit.
2. Floors where the joint is protected by a shaft enclosure in accordance with Section [708] 713.
3. Floors within atriums where the space adjacent to the atrium is included in the volume of the atrium for smoke control purposes.

4. ~~[Floors within malls where a tenant space is separated from the mall.]~~ Joints between floors within malls and non-rated assemblies.
5. Floors and ramps within open and enclosed parking garages or structures constructed in accordance with Sections ~~[406.3]~~ 406.5 and ~~[406.4]~~ 406.6, respectively.
6. Mezzanine floors.
7. Walls that are permitted to have unprotected openings.
8. Roofs where openings are permitted.
9. Control joints not exceeding a maximum width of 0.625 inch (15.9 mm) and tested in accordance with ASTM E 119 or UL 263.

715.1.1 Curtain wall assembly. The void created at the intersection of a floor/ceiling assembly and an exterior curtain wall assembly shall be protected in accordance with Section 715.4.

~~[714.2]~~ **715.2 Installation.** ~~[Fire-resistant joint systems]~~ A fire-resistant joint system shall be securely installed in accordance with the listing criteria in or on the joint for its entire length so as not to dislodge, loosen or otherwise impair [its] the joint system's ability to accommodate expected building movements and to resist the passage of fire and hot gases.

~~[714.3]~~ **715.3 Fire test criteria.** Fire-resistant joint systems shall be tested in accordance with the requirements of either ASTM E 1966 or UL 2079. Nonsymmetrical wall joint systems shall be tested with both faces exposed to the furnace, and the assigned fire-resistance rating shall be the shortest duration obtained from the two tests. ~~[When]~~ Where evidence is furnished to show that the wall was tested with the least fire-resistant side exposed to the furnace, subject to acceptance of the commissioner, the wall need not be subjected to tests from the opposite side.

Exception: For exterior walls with a horizontal fire separation distance greater than 5 feet (1524 mm), the joint system shall be required to be tested for interior fire exposure only.

~~[714.4]~~ **715.4 Exterior curtain wall/floor intersection.** Where fire resistance-rated floor or floor/ceiling assemblies are required, voids created at the intersection of the exterior curtain wall assemblies and such floor assemblies shall be sealed with an approved system to prevent the interior spread of fire. Such systems shall be securely installed and tested in accordance with ASTM E 2307 to ~~[prevent the passage of flame]~~ provide an F rating for [the] a time period [at least equal to] not less than the fire-resistance rating of the floor assembly [and prevent the passage of heat and hot gases sufficient to ignite cotton waste]. Height and fire-resistance requirements for curtain wall spandrels shall comply with Section 705.8.5.

Exception: Voids created at the intersection of the exterior curtain wall assemblies and such floor assemblies where the vision glass extends to the finished floor level shall be permitted to be sealed with an approved material to prevent the interior spread of fire. Such material shall be securely installed and capable of preventing the passage of flame and hot gases sufficient to ignite cotton waste where subjected to ASTM E 119 time-temperature fire conditions under a minimum

positive pressure differential of 0.01 inch (0.254 mm) of water column (2.5 Pa) for the time period not less than the fire-resistance rating of the floor assembly.

715.4.1 Exterior curtain wall/nonfire-resistance-rated floor assembly intersections. Voids created at the intersection of exterior curtain wall assemblies and nonfire-resistance-rated floor or floor/ceiling assemblies shall be sealed with an approved material or system to retard the interior spread of fire and hot gases between stories.

715.4.2 Exterior curtain wall/vertical fire barrier intersections. Voids created at the intersection of nonfire-resistance-rated exterior curtain wall assemblies and fire barriers shall be filled. An approved material or system shall be used to fill the void and shall be securely installed in or on the intersection for its entire length so as not to dislodge, loosen or otherwise impair its ability to accommodate expected building movements and to retard the passage of fire and hot gases.

[714.5] 715.5 Spandrel wall. Height and fire-resistance requirements for curtain wall spandrels shall comply with Section 705.8.5. Where Section 705.8.5 does not require a fire-resistance-rated spandrel wall, the requirements of Section [714.4] 715.4 shall still apply to the intersection between the spandrel wall and the floor.

[714.6] 715.6 Fire-resistant joint systems in smoke barriers. Fire-resistant joint systems in smoke barriers, and joints at the intersection of a horizontal smoke barrier and an exterior curtain wall, shall be tested in accordance with the requirements of UL 2079 for air leakage. The [~~air leakage rate~~] L rating of the joint system shall not exceed 5 cfm per [~~linear~~] linear foot (0.00775 m³/s m) of joint at 0.30 inch (7.47 Pa) of water for both the ambient temperature and elevated temperature tests.

SECTION BC [715] 716 OPENING PROTECTIVES

[715.1] 716.1 General. Opening protectives required by other sections of this code shall comply with the provisions of this section.

[715.2] 716.2 Fire-resistance-rated glazing. Fire-resistance-rated glazing tested as part of a fire-resistance-rated wall or floor/ceiling assembly in accordance with ASTM E 119 or UL 263 and labeled in accordance with Section [703.5] 703.6 shall not otherwise be required to comply with this section where used as part of a wall or floor/ceiling assembly. Fire-resistance-rated glazing shall be permitted in fire [~~doors~~] door and fire window assemblies where tested and installed in accordance with their listings and [~~shall not otherwise be required to comply with~~] where in compliance with the requirements of this section.

716.3 Marking fire-rated glazing assemblies. Fire-rated glazing assemblies shall be marked in accordance with Tables 716.3, 716.5 and 716.6.

**TABLE 716.3
MARKING FIRE-RATED GLAZING ASSEMBLIES**

<u>FIRE TEST STANDARD</u>	<u>MARKING</u>	<u>DEFINITION OF MARKING</u>
<u>ASTM E 119 or UL 263</u>	<u>W</u>	<u>Meets wall assembly criteria.</u>
<u>NFPA 257 or UL 9</u>	<u>OH</u>	<u>Meets fire window assembly criteria including the hose stream test.</u>
<u>NFPA 252 or UL 10B or UL 10C</u>	<u>D</u> <u>H</u> <u>T</u>	<u>Meets fire door assembly criteria.</u> <u>Meets fire door assembly hose stream test.</u> <u>Meets 450°F temperature rise criteria for 30 minutes.</u>
	<u>XXX</u>	<u>The time in minutes of the fire resistance or fire protection rating of the glazing assembly.</u>

For SI: °C = (°F) – 32)/1.8.

716.3.1 Fire-rated glazing identification. For fire-rated glazing, the label shall bear the identification required in Tables 716.3 and 716.5. “D” indicates that the glazing is permitted to be used in fire door assemblies and that the glazing meets the fire protection requirements of NFPA 252. “H” shall indicate that the glazing meets the hose stream requirements of NFPA 252. “T” shall indicate that the glazing meets the temperature requirements of Section 716.5.5.1. The placeholder “XXX” represents the fire-rating period, in minutes.

716.3.2 Fire-protection-rated glazing identification. For fire-protection-rated glazing, the label shall bear the following identification required in Tables 716.3 and 716.6: “OH – XXX.” “OH” indicates that the glazing meets both the fire protection and the hose-stream requirements of NFPA 257 or UL 9 and is permitted to be used in fire window openings. The placeholder “XXX” represents the fire-rating period, in minutes.

716.3.3 Fire-rated glazing that exceeds the code requirements. Fire-rated glazing assemblies marked as complying with hose stream requirements (H) shall be permitted in applications that do not require compliance with hose stream requirements. Fire-rated glazing assemblies marked as complying with temperature rise requirements (T) shall be permitted in applications that do not require compliance with temperature rise requirements. Fire-rated glazing assemblies marked with ratings (XXX) that exceed the ratings required by this code shall be permitted.

[715.3] 716.4 Alternative methods for determining fire protection ratings. The application of any of the alternative methods listed in this section shall be based on the fire exposure and acceptance criteria specified in NFPA 252, NFPA 257 or UL 9. The required fire resistance of an opening protective shall be permitted to be established by any of the following methods or procedures:

1. Designs documented in approved sources.
2. Calculations performed in an approved manner.
3. Engineering analysis based on a comparison of opening protective designs having fire protection ratings as determined by the test procedures set forth in NFPA 252, NFPA 257 or UL 9.

4. Alternative protection methods as allowed by Section 28-113.2 of the *Administrative Code*.

[715.4] 716.5 Fire door and shutter assemblies. Approved fire door and fire shutter assemblies shall be constructed of any material or assembly of component materials that conforms to the test requirements of Section [715.4.1] 716.5.1, [715.4.2] 716.5.2 or [715.4.3] 716.5.3 and the fire protection rating indicated in Table [715.4] 716.5. Fire door frames with transom lights, sidelights or both shall be permitted in accordance with Section [715.4.5] 716.5.6. Fire door assemblies and shutters shall be installed in accordance with the provisions of this section and NFPA 80.

Exceptions:

1. Labeled protective assemblies that conform to the requirements of this section or UL 10A, UL 14B and UL 14C for tin-clad fire door assemblies.
2. Floor fire door assemblies in accordance with Section [712.8] 712.1.13.1.

**[TABLE 715.4
FIRE DOOR AND FIRE SHUTTER FIRE PROTECTION RATINGS]**

[TYPE OF ASSEMBLY]	[REQUIRED ASSEMBLY RATING (hours)]	[MINIMUM FIRE DOOR AND FIRE SHUTTER ASSEMBLY RATING (hours)]
[Fire walls and fire barriers having a required fire-resistance rating greater than 1 hour]	[4] [3] [2] [1½]	[3] [3 ^a] [1½] [1½]
[Fire barriers having a required fire resistance rating of 1 hour:]		
[Shaft, exit enclosure and exit passageway walls]	[1]	[1]
[Other fire barriers]	[1]	[¾]
[Fire partitions:]		
[Corridor walls]	[1]	[¾]
[Other partitions]	[1]	[¾]
[Exterior walls]	[3] [2] [1]	[1½] [1½] [¾]
[Smoke barriers]	[1]	[⅓]

[a.— Two doors, each with a fire protection rating of 1½ hours, installed on opposite sides of the same opening in a fire wall, shall be deemed equivalent in fire protection rating to one 3-hour fire door.]

[b.— For testing requirements, see Section 715.4.3.]

**TABLE 716.5
OPENING FIRE PROTECTION ASSEMBLIES, RATINGS AND MARKINGS**

<u>TYPE OF ASSEMBLY</u>	<u>REQUIRED WALL ASSEMBLY RATING (hours)</u>	<u>MINIMUM FIRE DOOR AND FIRE SHUTTER ASSEMBLY RATING (hours)</u>	<u>DOOR VISION PANEL SIZE^b</u>	<u>FIRE-RATED GLAZING MARKING DOOR VISION PANEL^d</u>	<u>MINIMUM SIDELIGHT/TRANSOM ASSEMBLY RATING (hours)</u>		<u>FIRE-RATED GLAZING MARKING SIDELIGHT/TRANSOM PANEL</u>	
					<u>Fire protection</u>	<u>Fire resistance</u>	<u>Fire protection</u>	<u>Fire resistance</u>
Fire walls, public corridor walls and fire barriers having a required fire-resistance rating greater than 1 hour	4	3	See Note b	D-H-W-240	Not Permitted	4	Not Permitted	W-240
	3	3 ^a	See Note b	D-H-W-180	Not Permitted	3	Not Permitted	W-180
	2	1½	100 sq. in.	≤ 100 sq. in. = D-H-90 > 100 sq. in. = D-H-W-90	Not Permitted	2	Not Permitted	W-120
	1½	1½	100 sq. in.	≤ 100 sq. in. = D-H-90 > 100 sq. in. = D-H-W-90	Not Permitted	1½	Not Permitted	W-90
Enclosures for shafts, interior exit stairways and interior exit ramps	2	1½	100 sq. in.	≤ 100 sq. in. = D-H-90 > 100 sq. in. = D-H-T-W-90	Not Permitted	2	Not Permitted	W-120
Horizontal exits in fire walls ^c	4	3	100 sq. in.	≤ 100 sq. in. = D-H-180 > 100 sq. in. = D-H-W-240	Not Permitted	4	Not Permitted	W-240
	3	3 ^a	100 sq. in.	≤ 100 sq. in. = D-H-180 > 100 sq. in. = D-H-W-180	Not Permitted	3	Not Permitted	W-180
Fire barriers having a required fire-resistance rating of 1 hour: Enclosures for shafts, exit access stairways, exit access ramps, interior exit stairways and interior exit ramps; and exit passageway walls	1	1	100 sq. in. ^c	≤ 100 sq. in. = D-H-60 > 100 sq. in. = D-H-T-W-60	Not Permitted	1	Not Permitted	W-60
					<u>Fire protection</u>			
Other fire barriers; and public corridor walls	1	¾	Maximum size tested	D-H	¾	¾	D-H	
Fire partitions: Interior corridor walls	1	¾	Maximum size tested	D-20	¾ ^b	¾ ^b	D-H-OH-45	
Other fire partitions	1	¾	Maximum size tested	D-H-45	¾	¾	D-H-45	

**TABLE 716.5
OPENING FIRE PROTECTION ASSEMBLIES, RATINGS AND MARKINGS**

<u>TYPE OF ASSEMBLY</u>	<u>REQUIRED WALL ASSEMBLY RATING (hours)</u>	<u>MINIMUM FIRE DOOR AND FIRE SHUTTER ASSEMBLY RATING (hours)</u>	<u>DOOR VISION PANEL SIZE^b</u>	<u>FIRE-RATED GLAZING MARKING DOOR VISION PANEL^d</u>	<u>MINIMUM SIDELIGHT/TRANSOM ASSEMBLY RATING (hours)</u>		<u>FIRE-RATED GLAZING MARKING SIDELIGHT/TRANSOM PANEL</u>	
					<u>Fire protection</u>	<u>Fire resistance</u>	<u>Fire protection</u>	<u>Fire resistance</u>
<u>Exterior walls</u>	<u>3</u>	<u>1½</u>	<u>100 sq. in.^b</u>	≤ 100 sq. in. = <u>D-H-90</u> ≥ 100 sq. in. = <u>D-H-W-90</u>	<u>Not Permitted</u>	<u>3</u>	<u>Not Permitted</u>	<u>W-180</u>
	<u>2</u>	<u>1½</u>	<u>100 sq. in.^b</u>	≤ 100 sq. in. = <u>D-H-90</u> ≥ 100 sq. in. = <u>D-H-W-90</u>	<u>Not Permitted</u>	<u>2</u>	<u>Not Permitted</u>	<u>W-120</u>
	<u>1</u>	<u>¾</u>	<u>Maximum size tested</u>	<u>D-H-45</u>	<u>Fire protection</u>	<u>¾</u>	<u>D-H-45</u>	
<u>Smoke barriers</u>	<u>1</u>	<u>1/3</u>	<u>Maximum size tested</u>	<u>D-20</u>	<u>Fire protection</u>	<u>¾</u>	<u>D-H-OH-45</u>	

For SI: 1 square inch = 645.2 mm.

- a. Two doors, each with a fire protection rating of 1½ hours, installed on opposite sides of the same opening in a fire wall, shall be deemed equivalent in fire protection rating to one 3-hour fire door.
- b. Fire-resistance-rated glazing tested to ASTM E 119 in accordance with Section 716.2 shall be permitted, in the maximum size tested.
- c. Except where the building is equipped throughout with an automatic sprinkler and the fire-rated glazing meets the criteria established in Section 716.5.5.
- d. Under the column heading "Fire-rated glazing marking door vision panel," W refers to the fire-resistance rating of the glazing, not the frame.
- e. See Section 716.5.8.1.2.1.

[715.4.1] 716.5.1 Side-hinged or pivoted swinging doors. Fire door assemblies with side-hinged and pivoted swinging doors shall be tested in accordance with NFPA 252 or UL 10C. After 5 minutes into the NFPA 252 test, the neutral pressure level in the furnace shall be established at 40 inches (1016 mm) or less above the sill.

[715.4.2] 716.5.2 Other types of assemblies. Fire door assemblies with other types of doors, including swinging elevator doors, horizontal sliding fire door assemblies, and fire shutter assemblies, bottom and side-hinged chute intake doors, and top-hinged chute discharge doors, shall be tested in accordance with NFPA 252 or UL 10B. The pressure in the furnace shall be maintained as nearly equal to the atmospheric pressure as possible. Once established, the pressure shall be maintained during the entire test period.

[715.4.3] 716.5.3 Door assemblies in corridors and smoke barriers. Fire door assemblies located in corridor walls or smoke barrier walls having a fire-resistance rating in accordance with Table [715.4] 716.5 shall be tested in accordance with NFPA 252 or UL 10C.

Exceptions:

1. Viewports that require a hole not larger than 1 inch ([25] 25.4 mm) in diameter through the door, have [at least an] not less than a 0.25-inch[-thick] (6.4 mm) thick glass disc

and the holder is of metal that will not melt out where subject to temperatures of 1,700°F ([927] 926.7°C).

2. Corridor door assemblies in occupancies of Group I-2 shall be in accordance with Section 407.3.1.
3. Horizontal sliding doors in smoke barriers that comply with Sections [408.3] 408.6 and 408.8.4 in occupancies in Group I-3.

[715.4.3.1] 716.5.3.1 Smoke and draft control. Fire door assemblies shall [also] meet the requirements for a smoke and draft control door assembly tested in accordance with UL 1784. The air leakage rate of the door assembly shall not exceed 3.0 cubic feet per minute per square foot (0.01524 m³/s • m²) of door opening at 0.10 inch (24.9 Pa) of water for both the ambient temperature and elevated temperature tests. Louvers shall be prohibited. Installation of smoke doors shall be in accordance with NFPA 105.

[715.4.3.2] 716.5.3.2 Glazing in door assemblies. Glazing material in any other part of the door assembly, including transom lights and sidelights, shall be tested in accordance with NFPA 257 or UL 9, including the hose stream test, in accordance with Section [715.5] 716.6 of this code.

716.5.4 Reserved.

[715.4.4] 716.5.5 Doors in interior exit [enclosures] stairways and ramps and exit passageways. Fire door assemblies in interior exit [enclosures] stairways and ramps and exit passageways shall have a maximum transmitted temperature [end point] rise of not more than 450°F ([232] 232.2°C) above ambient at the end of 30 minutes of standard fire test exposure.

Exception: The maximum transmitted temperature is not required in buildings equipped throughout with an automatic sprinkler system installed in accordance with Section 903.3.1.1 or 903.3.1.2.

[715.4.4.1] 716.5.5.1 Glazing in doors. Fire-protection-rated glazing in excess of 100 square inches (0.065 m²) [shall be permitted in fire door assemblies when tested as components of the door assemblies and not as glass lights, and shall have a maximum transmitted temperature rise of 450F (232C) in accordance with Section 715.4.4.] is not permitted. Fire-resistance-rated glazing in excess of 100 square inches (64 516 mm²) shall be permitted in fire doors. Listed fire-resistance-rated glazing in a fire door shall have a maximum transmitted temperature rise in accordance with Section 716.5.5 of this code when the fire door is tested in accordance with NFPA 252, UL 10B or UL 10C.

~~**Exception:** The maximum transmitted temperature rise is not required in buildings equipped throughout with an automatic sprinkler system installed in accordance with Section 903.3.1.1 or 903.3.1.2.~~

[715.4.5] 716.5.6 Fire door frames with transom lights and sidelights. Door frames with transom lights, sidelights[,] or both, shall be permitted where a ³/₄-hour fire protection rating or less is required in accordance with Table [715.4] 716.5. [Where a fire protection rating exceeding

~~3/4 hour is required in accordance with Table 715.4, fire door]~~ Fire door frames with transom lights, sidelights, or both, [shall be permitted where] installed with fire-resistance-rated glazing tested as an assembly in accordance with ASTM E 119 or UL 263 shall be permitted where a fire protection rating exceeding 3/4 hour is required in accordance with Table 716.5 of this code.

[715.4.6] 716.5.7 Labeled protective assemblies. Fire door assemblies shall be labeled by an approved agency. The labels shall comply with NFPA 80, and shall be permanently affixed to the door or frame.

[715.4.6.1] 716.5.7.1 Fire door labeling requirements. Fire doors shall be labeled showing the name of the manufacturer or other identification readily traceable back to the manufacturer, the name or trademark of the third-party inspection agency, the fire protection rating and, where required for fire doors in interior exit [enclosures] stairways and ramps and exit passageways by Section ~~[715.4.4] 716.5.5~~, the maximum transmitted temperature end point. Smoke and draft control doors complying with UL 1784 shall be labeled as such and shall ~~[also]~~ comply with Section ~~[715.4.6] 716.5.7~~. Labels shall be approved and permanently affixed. The label shall be applied at the factory or location where fabrication and assembly are performed.

716.5.7.1.1 Vision light kits, louvers and components. Listed vision light kits and louvers and their required preparations shall be considered as part of the labeled door where such installations are listed and where quality assurance testing is done under the listing program of the third-party testing agency. Fire doors and door assemblies shall be permitted to consist of components, including glazing, vision light kits and hardware that are listed or classified and labeled for such use by different third-party agencies.

[715.4.6.2] 716.5.7.2 Oversized doors. Oversized fire doors shall bear an oversized fire door label by an approved agency or shall be provided with a certificate of inspection furnished by an approved testing agency. ~~[When]~~ Where a certificate of inspection is furnished by an approved testing agency, the certificate shall state that the door conforms to the requirements of design, materials and construction, but has not been subjected to the fire test.

[715.4.6.3] 716.5.7.3 Smoke and draft control door labeling requirements. Smoke and draft control doors complying with UL 1784 shall be labeled in accordance with Section ~~[715.4.6.1] 716.5.7.1~~ and shall show the letter “S” on the fire rating label of the door. This marking shall indicate that the door and frame assembly are in compliance ~~[when]~~ where listed or labeled gasketing is ~~[also]~~ installed.

[715.4.6.4] 716.5.7.4 Fire door frame labeling requirements. Fire door frames shall be labeled showing the names of the manufacturer and the third-party inspection agency.

716.5.7.5 Fire door operator labeling requirements. Fire door operators for horizontal sliding doors shall be labeled and listed for use with the assembly.

[715.4.7] 716.5.8 Glazing material. ~~[Fire-protection-rated]~~ Fire-rated glazing and fire-resistance-rated glazing conforming to the opening protection requirements in Section ~~[715.4] 716.5~~ shall be permitted in fire door assemblies.

~~[715.4.7.1 Size limitations. Fire protection-rated glazing used in fire doors shall comply with the size limitations of NFPA 80.]~~

[Exceptions:]

- ~~[1. Fire protection-rated glazing in fire doors located in fire walls shall be prohibited except that where serving in a fire door in a horizontal exit, a self-closing swinging door shall be permitted to have a vision panel of not more than 100 square inches (0.065 m²) without a dimension exceeding 10 inches (254 mm).]~~
- ~~[2. Fire protection-rated glazing shall not be installed in fire doors having a 1½-hour fire protection rating intended for installation in fire barriers, unless the glazing is not more than 100 square inches (0.065 m²) in area.]~~

716.5.8.1 Size limitations. Fire-resistance-rated glazing shall comply with the size limitations in Section 716.5.8.1.1. Fire-protection-rated glazing shall comply with the size limitations of NFPA 80, and as provided in Section 716.5.8.1.2.

716.5.8.1.1 Fire-rated glazing in door assemblies in fire walls and fire barriers rated greater than 1 hour. Fire-rated glazing tested to ASTM E 119 or UL 263 and NFPA 252, UL 10B or UL 10C shall be permitted in fire door assemblies located in fire walls and in fire barriers in accordance with Table 716.5 of this code to the maximum size tested and in accordance with their listings.

716.5.8.1.2 Fire-protection-rated glazing in door assemblies in fire walls and fire barriers rated greater than 1 hour. Fire-rated glazing shall be prohibited in fire walls and fire barriers except as provided in Sections 716.5.8.1.2.1 and 716.5.8.1.2.2.

716.5.8.1.2.1 Horizontal exits. Fire-protection-rated glazing shall be permitted as vision panels in self-closing swinging fire door assemblies serving as horizontal exits in fire walls where limited to 100 square inches (64 516 mm²) with no dimension exceeding 10 inches (254 mm).

716.5.8.1.2.2 Fire barriers. Fire-rated glazing shall be permitted in fire doors having a 1½-hour fire protection rating intended for installation in fire barriers, where limited to 100 square inches (64 516 mm²).

~~[715.4.7.2 Exit]~~ **716.5.8.2 Elevator, stairway and [elevator] ramp protectives.** Approved ~~[fire protection-rated]~~ fire-rated glazing used in fire door assemblies in elevator, stairway and ~~[exit]~~ ramp enclosures shall be so located as to furnish clear vision of the passageway or approach to the elevator, ~~[ramp or]~~ stairway or ramp.

~~[715.4.7.3]~~ **716.5.8.3 Labeling.** ~~[Fire protection-rated]~~ Fire-rated glazing shall bear a label or other identification showing the name of the manufacturer, the test standard and information required in ~~[Section 715.5.9.1]~~ Table 716.3 that shall be issued by an approved agency and shall be permanently ~~[affixed to]~~ identified on the glazing.

~~[715.4.7.3.1 Identification. For fire protection-rated glazing, the label shall bear the following four part identification: “D, H or NH, T or NT, XXX.” “D” indicates that the glazing shall “NH” shall indicate that the glazing does not meet the hose stream requirements of the test. “T” shall indicate that the glazing meets the temperature requirements of Section 715.4.4.1. “NT” shall indicate that the glazing does not meet the temperature requirements of Section 715.4.4.1. The placeholder “XXX” shall specify the fire protection rating period, in minutes.]~~

~~[715.4.7.4]~~ **716.5.8.4 Safety glazing.** ~~[Fire protection-rated]~~ Fire-rated glazing installed in fire [doors in areas subject to human impact in hazardous locations] door assemblies shall comply with the safety glazing requirements of Chapter 24 where applicable.

~~[715.4.8]~~ **716.5.9 Door closing.** Fire doors shall be latching and self-closing or automatic-closing in accordance with this section.

Exceptions:

1. Fire doors located in common walls separating sleeping units in Group R-1 shall be permitted without ~~[automatic-]~~ or self-closing or automatic-closing devices.
2. The elevator car doors and the associated hoistway enclosure doors at the floor level designated for recall in accordance with Section 3003.2 shall be permitted to remain open during Phase I emergency recall operation.

~~[715.4.8.1]~~ **716.5.9.1 Latch required.** Unless otherwise specifically permitted, single fire doors and both leaves of pairs of side-hinged swinging fire doors shall be provided with an active latch bolt that will secure the door when it is closed.

716.5.9.1.1 Chute intake door latching. Chute intake doors shall be positive latching, remaining latched and closed in the event of latch spring failure during a fire emergency.

~~[715.4.8.2]~~ **716.5.9.2 Automatic-closing fire door assemblies.** Automatic-closing fire door assemblies shall be self-closing in accordance with NFPA 80.

~~[715.4.8.3]~~ **716.5.9.3 Smoke-activated doors.** Automatic-closing fire doors installed in the following locations shall be automatic-closing by the actuation of smoke detectors installed in accordance with Section 907.3 or by loss of power to the smoke detector where such detector is powered by the building’s normal electrical service or by loss of power to the hold-open device. Doors that are automatic-closing by smoke detection shall not have more than a 10-second delay before the door starts to close after the smoke detector is actuated.

1. Doors installed across a corridor.
2. Doors installed in the enclosures of exit access stairways and ramps in accordance with Sections 1019 and 1023, respectively.
- ~~[2.]~~ 3. Doors that protect openings in exits or corridors required to be of fire-resistance-rated construction.

- [3-] 4. Doors that protect openings in walls that are capable of resisting the passage of smoke in accordance with Section 509.4.
- [4-] 5. Doors installed in smoke barriers in accordance with Section [710.5] 709.5.
- [5-] 6. Doors installed in fire partitions in accordance with Section [709.6] 708.6.
- [6-] 7. Doors installed in a fire wall in accordance with Section 706.8.
- [7-] 8. Doors installed in shaft enclosures in accordance with Section [708.7] 713.7.
- [8-] 9. Doors installed in [~~refuse~~] waste and [~~laundry~~] linen chutes, discharge openings and access and [~~termination~~] discharge rooms in accordance with Section [708.13] 713.13. Loading doors installed in waste and linen chutes shall meet the requirements of Sections 716.5.9 and 716.5.9.1.1.
- [9-] 10. Doors installed in the walls for compartmentation of underground buildings in accordance with Section 405.4.2.
- [10-] 11. Doors installed in the elevator lobby walls of underground buildings in accordance with Section 405.4.3.
- [11-] 12. Doors installed in smoke partitions in accordance with Section [711.5.3] 710.5.2.3.
- [12-] 13. Doors serving [~~vertical~~]-interior exit [~~enclosures~~] stairways or ramps in accordance with the exception to Section [708.7] 713.7.

[715.4.8.4] 716.5.9.4 Doors in pedestrian ways. Vertical sliding or vertical rolling steel fire doors in openings through which pedestrian's travel shall be heat activated or activated by smoke detectors with alarm verification.

[715.4.9] 716.5.10 Swinging fire shutters. Where fire shutters of the swinging type are installed in exterior openings, not less than one row in every three vertical rows shall be arranged to be readily opened from the outside, and shall be identified by distinguishing marks or letters not less than 6 inches ([152] 152.4 mm) high.

[715.4.10] 716.5.11 Rolling fire shutters. Where fire shutters of the rolling type are installed, such shutters shall include approved automatic-closing devices.

[715.5] 716.6 [Fire-protection-rated] Fire-protection-rated glazing. Glazing in fire window assemblies shall be fire protection rated in accordance with this section and Table [715.5] 716.6. Glazing in fire door assemblies shall comply with Section [715.4.7] 716.5.8. Fire-protection-rated glazing in fire window assemblies shall be tested in accordance with and shall meet the acceptance criteria of NFPA 257 or UL 9. Fire-protection-rated glazing shall [~~also~~]-comply with NFPA 80. Openings in nonfire-resistance-rated exterior wall assemblies that require protection in accordance with Section 705.3, 705.8, 705.8.5 or 705.8.6 shall have a fire protection rating of not less than ¾ hour.

[**Exception:** Wired glass in accordance with Section 715.5.4.]

**[TABLE 715.5
FIRE WINDOW ASSEMBLY FIRE PROTECTION RATINGS]**

[TYPE OF ASSEMBLY]		[REQUIRED ASSEMBLY RATING (hours)]	[MINIMUM FIRE WINDOW ASSEMBLY RATING (hours)]
[Interior walls:]	[Fire walls]	[AH]	[NP ^a]
	[Fire barriers]	[>1] [1]	[NP ^a] [3/4]
	[Smoke barriers]	[1]	[3/4]
	[Fire partitions]	[1]	[3/4]
[Exterior walls]		[>1] [1]	[1 1/2] [3/4]
[Party walls]		[AH]	[NP ^a]

[a. Not permitted except as specified in Section 715.2.]

**TABLE 716.6
FIRE WINDOW ASSEMBLY FIRE PROTECTION RATINGS**

<u>TYPE OF WALL ASSEMBLY</u>	<u>REQUIRED WALL ASSEMBLY RATING (hours)</u>	<u>MINIMUM FIRE WINDOW ASSEMBLY RATING (hours)</u>	<u>FIRE-RATED GLAZING MARKING</u>
<u>Interior walls:</u>			
<u>Fire walls</u>	<u>All</u>	<u>NP^a</u>	<u>W-XXX^b</u>
<u>Fire barriers</u>	<u>≥1</u> <u>1</u>	<u>NP^a</u> <u>NP^a</u>	<u>W-XXX^b</u> <u>W-XXX^b</u>
<u>Incidental use areas (Section 707.3.7), Mixed occupancy separations (Section 707.3.9)</u>	<u>1</u>	<u>3/4</u>	<u>OH-45 or W-60</u>
<u>Fire partitions</u>	<u>1</u>	<u>3/4</u>	<u>OH-45 or W-60</u>
<u>Smoke barriers</u>	<u>1</u>	<u>3/4</u>	<u>OH-45 or W-60</u>
<u>Exterior walls</u>	<u>≥1</u> <u>1</u>	<u>1 1/2</u> <u>3/4</u>	<u>OH-90 or W-XXX^b</u> <u>OH-45 or W-60</u>
<u>Party wall</u>	<u>All</u>	<u>NP</u>	<u>Not Applicable</u>

NP = Not Permitted.

a. Not permitted except fire-resistance-rated glazing assemblies tested to ASTM E 119 or UL 263, as specified in Section 716.2.

b. XXX = The fire rating duration period in minutes, which shall be equal to the fire-resistance rating required for the wall assembly.

[715.5.1] 716.6.1 Testing under positive pressure. NFPA 257 or UL 9 shall evaluate fire-protection-rated glazing under positive pressure. Within the first 10 minutes of a test, the pressure in the furnace shall be adjusted so [at least] not less than two-thirds of the test specimen is above

the neutral pressure plane, and the neutral pressure plane shall be maintained at that height for the balance of the test.

[715.5.2] 716.6.2 Nonsymmetrical glazing systems. Nonsymmetrical fire-protection-rated glazing systems in fire partitions, fire barriers or in exterior walls with a fire separation distance of 5 feet (1524 mm) or less pursuant to Section [704] 705 shall be tested with both faces exposed to the furnace, and the assigned fire protection rating shall be the shortest duration obtained from the two tests conducted in compliance with NFPA 257 or UL 9.

[715.5.3] 716.6.3 Safety glazing. Fire-protection-rated glazing and fire-resistance-rated glazing installed in fire window assemblies [~~in areas subject to human impact in hazardous locations~~] shall comply with the safety glazing requirements of Chapter 24 where applicable.

~~**[715.5.4 Wired glass.** Steel window frame assemblies of 0.125 inch (3.2 mm) minimum solid section or of not less than nominal 0.048 inch thick (1.2 mm) formed sheet steel members fabricated by pressing, mitering, riveting, interlocking or welding and having provision for glazing with ⁺1/4 inch (6.4 mm) wired glass where securely installed in the building construction and glazed with ⁺1/4 inch (6.4 mm) labeled wired glass shall be deemed to meet the requirements for a ³/₄ hour fire window assembly. Wired glass panels shall conform to the size limitations set forth in Table 715.5.4.]~~

**[TABLE 715.5.4
FIRE DOOR AND FIRE SHUTTER FIRE
PROTECTION RATINGS]**

[OPENING FIRE PROTECTION RATING]	[MAXIMUM AREA (square inches)]	[MAXIMUM HEIGHT (inches)]	[MAXIMUM WIDTH (inches)]
[3 hours]	[0]	[0]	[0]
[1 ¹ / ₂ hour doors in exterior walls]	[0]	[0]	[0]
[1 and 1 ¹ / ₂ hours]	[100]	[33]	[40]
[³ / ₄ hour]	[1,296]	[54]	[54]
[Fire window assemblies]	[1,296]	[54]	[54]

[For SI: 1 inch = 25.4 mm, 1 square inch = 645.2 mm².]

~~**[715.5.5 Nonwired glass.] 716.6.4 Glass and glazing.** Glazing [~~other than wired glass~~] in fire window assemblies shall be fire-protection-rated glazing installed in accordance with and complying with the size limitations set forth in NFPA 80.~~

[715.5.6] 716.6.5 Installation. Fire-protection-rated glazing shall be in the fixed position or be automatic-closing and shall be installed in approved frames.

[715.5.7] 716.6.6 Window mullions. Metal mullions that exceed a nominal height of 12 feet (3658 mm) shall be protected with materials to afford the same fire-resistance rating as required for the wall construction in which the protective is located.

[715.5.8] 716.6.7 Interior fire window assemblies. Fire-protection-rated glazing used in fire window assemblies located in fire partitions and fire barriers shall be limited to use in assemblies with a maximum fire-resistance rating of 1 hour in accordance with this section.

[715.5.8.1] 716.6.7.1 Where ³/₄-hour fire protection window assemblies permitted. Fire-protection-rated glazing requiring 45-minute opening protection in accordance with Table [715.5] 716.6 shall be limited to fire partitions designed in accordance with Section [709] 708 and fire barriers utilized in the applications set forth in Sections 707.3.6, 707.3.7 and [707.3.8] 707.3.9 where the fire-resistance rating does not exceed 1 hour. Fire-resistance-rated glazing assemblies tested in accordance with ASTM E 119 or UL 263 shall not be subject to the limitations of this section.

[715.5.8.2] 716.6.7.2 [Size] Area limitations. The total area of [windows] the glazing in fire-protection-rated window assemblies shall not exceed 25 percent of the area of a common wall with any room.

[715.5.9] 716.6.8 Labeling requirements. Fire-protection-rated glazing shall bear a label or other identification showing the name of the manufacturer, the test standard[,], and information required in Section [715.5.9.1] 716.3.2 and Table 716.6 that shall be issued by an approved agency and [shall be] permanently [affixed to the glazing] identified on the glazing.

[715.5.9.1 Identification. For fire protection rated glazing, the label shall bear the following two part identification: “OH — XXX.” “OH” indicates that the glazing meets both the fire protection and the hose stream requirements of NFPA 257 or UL 9 and is permitted to be used in openings. “XXX” represents the fire protection rating period, in minutes, that was tested.]

SECTION [716] 717 DUCTS AND AIR TRANSFER OPENINGS

[716.1] 717.1 General. The provisions of this section shall govern the protection of duct penetrations and air transfer openings in assemblies required to be protected and duct penetrations in nonfire-resistance-rated floor assemblies.

717.1.1 Ducts and air transfer openings. Ducts transitioning horizontally between shafts shall not require a shaft enclosure provided that the duct penetration into each associated shaft is protected with dampers complying with this section.

[716.1.1] 717.1.2 Ducts that penetrate fire-resistance-rated assemblies without dampers. Ducts that penetrate fire-resistance-rated assemblies and are not required by this section to have dampers shall comply with the requirements of Sections [713.2] 714.2 through [713.3.3] 714.3.3. Ducts that penetrate horizontal assemblies not required to be contained within a shaft and not required by this section to have dampers shall comply with the requirements of [Section 713.4] Sections 714.4 through [713.4.2.2] 714.5.2.

[716.1.1.1] 717.1.2.1 Ducts that penetrate nonfire-resistance-rated assemblies. The space around a duct penetrating a nonfire-resistance-rated floor assembly shall comply with Section [716.6.3] 717.6.3.

[716.2] 717.2 Installation. Fire dampers, smoke dampers, combination fire/smoke dampers and ceiling radiation dampers located within air distribution and smoke control systems shall be installed in accordance with the requirements of this section, the *New York City Mechanical Code*, the manufacturer's ~~installation~~ instructions and damper's listing.

[716.2.1] 717.2.1 Smoke control system. Where the installation of a fire damper will interfere with the operation of a required smoke control system in accordance with Section 909, approved alternative protection shall be utilized. Where mechanical systems including ducts and dampers utilized for normal building ventilation serve as part of the smoke control system, the expected performance of these systems in smoke control mode shall be addressed in the rational analysis required by Section 909.4.

[716.2.1.1] 717.2.1.1 Remote control. Provisions for operation by remote control of combination fire/smoke dampers shall be in accordance with Section 607.2.1.1 of the *New York City Mechanical Code*.

[716.2.2] 717.2.2 Hazardous exhaust ducts. Fire dampers for hazardous exhaust duct systems shall comply with the *New York City Mechanical Code*.

[716.2.3] 717.2.3 Supply air systems. Smoke dampers in supply airhandling systems having a capacity equal to or greater than 15,000 cfm (7.1 m³/s) shall be installed in accordance with Section 607.2.3 of the *New York City Mechanical Code*.

[716.3] 717.3 Damper testing, ratings and actuation. Damper testing, ratings and actuation shall be in accordance with Sections ~~[716.3.1]~~ 717.3.1 through ~~[716.3.3]~~ 717.3.3.

[716.3.1] 717.3.1 Damper testing. Dampers shall be listed and ~~[bear the label of an approved testing agency indicating compliance with]~~ labeled in accordance with the standards in this section.

1. Fire dampers shall comply with the requirements of UL 555. Only fire dampers and ceiling radiation dampers labeled for use in dynamic systems shall be installed in heating, ventilation and air-conditioning systems designed to operate with fans on during a fire.~~[Smoke dampers shall comply with the requirements of UL 555S. Combination fire/smoke dampers shall comply with the requirements of both UL 555 and UL 555S. Ceiling radiation dampers shall comply with the requirements of UL 555C.]~~
2. Smoke dampers shall comply with the requirements of UL 555S.
3. Combination fire/smoke dampers shall comply with the requirements of both UL 555 and UL 555S.
4. Ceiling radiation dampers shall comply with the requirements of UL 555C or shall be tested as part of a fire-resistance-rated floor/ceiling or roof/ceiling assembly in accordance with ASTM E119 or UL 263.

[716.3.2] 717.3.2 Damper rating. Damper ratings shall be in accordance with Sections ~~[716.3.2.1]~~ 717.3.2.1 through ~~[716.3.2.3]~~ 717.3.2.3.

[716.3.2.1] 717.3.2.1 Fire damper ratings. Fire dampers shall have the minimum fire protection rating specified in Table [716.3.2.1] 717.3.2.1 for the type of penetration.

**TABLE [716.3.2.1] 717.3.2.1
FIRE DAMPER RATING**

TYPE OF PENETRATION	MINIMUM DAMPER RATING (hours)
Less than 3-hour fire-resistance-rated assemblies	1.5
3-hour or greater fire-resistance-rated assemblies	3

[716.3.2.2] 717.3.2.2 Smoke damper ratings. Smoke damper leakage ratings shall ~~not~~ be ~~less than~~ Class I or II. Elevated temperature ratings shall be not ~~be~~ less than 250°F (~~121~~ 121.1°C).

[716.3.2.3] 717.3.2.3 Combination fire/smoke damper ratings. Combination fire/smoke dampers shall have the minimum fire protection rating specified for fire dampers in Table [716.3.2.1] 717.3.2.1 for the type of penetration and shall ~~also~~ have a minimum ~~[Class II leakage rating and a minimum elevated temperature rating of 250°F (121°C)]~~ smoke damper rating as specified in Section 717.3.2.2.

[716.3.3] 717.3.3 Damper actuation. Damper actuation shall be in accordance with Sections [716.3.3.1] 717.3.3.1 through [716.3.3.4] 717.3.3.4 as applicable.

[716.3.3.1] 717.3.3.1 Fire damper actuation device. The fire damper actuation device shall meet one of the following requirements:

1. The operating temperature shall be approximately 50°F (10°C) above the normal temperature within the duct system, but not less than 160°F (~~71~~ 71.1°C).
2. The operating temperature shall be not more than ~~[286°F (141°C)]~~ 350°F (176.7°C) where located in a smoke control system complying with Section 909.

[716.3.3.2] 717.3.3.2 Smoke damper actuation. The smoke damper shall close upon actuation of a listed smoke detector or detectors installed in accordance with Section 907.3 and one of the following methods, as applicable:

1. Where a smoke damper is installed within a duct, a smoke detector shall be installed ~~in~~ inside the duct or outside the duct with sampling tubes protruding into the duct. The detector or tubes within the duct shall be within 5 feet (1524 mm) of the damper ~~[with no air].~~ Air outlets ~~or~~ and inlets shall not be located between the detector or tubes and the damper. The detector shall be listed for the air velocity, temperature and humidity anticipated at the point where it is installed. Other than in mechanical smoke control systems, dampers shall be closed upon fan shutdown where local smoke detectors require a minimum velocity to operate.

Exceptions:

1. Duct smoke detectors will not be required at each fire smoke damper provided the supply fan shall shut down and all the fire smoke dampers associated with the supply system automatically close upon actuation of any automatic alarm initiating device on the floor(s).
 2. Duct smoke detectors will be required within 5 feet (1.5 m) downstream of any electric duct reheat coil.
 3. Non-ducted return air systems shall have a smoke detector located within 5 feet (1.5 m) upstream of each return air protected opening in a 2-hour fire-rated barrier.
 4. Ducted return air systems shall have a duct smoke detector located within 5 feet (1.5 m) of a smoke damper; additional smoke detectors will not be required at fire smoke dampers located downstream where there are no additional return air inlets.
2. Where a smoke damper is installed above smoke barrier doors in a smoke barrier, a spot-type detector [~~listed for releasing service~~] shall be installed on either side of the smoke barrier door opening. The detector shall be listed for releasing service if used for direct interface with the damper.
 3. Where a smoke damper is installed within an unducted opening in a wall, a spot-type detector [~~listed for releasing service~~] shall be installed within 5 feet (1524 mm) horizontally of the damper. The detector shall be listed for releasing service if used for direct interface with the damper.
 4. Where a smoke damper is installed in a corridor wall or ceiling, the damper shall be permitted to be controlled by a smoke detection system installed in the corridor.
 5. Where a [~~total coverage~~] smoke detection system is [~~provided within~~] installed in all areas served by [a heating, ventilation and air conditioning (HVAC) system,] duct in which the damper will be located, the smoke dampers shall be permitted to be controlled by the smoke detection system.
 6. Smoke dampers that are part of an engineered smoke control system shall be controlled in accordance with Section 607.3.3.2 of the *New York City Mechanical Code*.

[716.3.3.3] 717.3.3.3 Combination fire/smoke damper actuation. Combination fire/smoke damper actuation shall be in accordance with Sections [~~716.3.3.1~~] 717.3.3.1 and [~~716.3.3.2~~] 717.3.3.2. Combination fire/smoke dampers installed in smoke control system shaft penetrations shall not be activated by local area smoke detection unless it is secondary to the smoke management system controls.

[716.3.3.4] 717.3.3.4 Ceiling radiation damper actuation. The operating temperature of a ceiling radiation damper actuation device shall be 50°F [~~(27.8°C)~~] (10°C) above the normal temperature within the duct system, but not less than 160°F (~~[71]~~ 71.1°C).

[716.4] 717.4 Access and identification. Fire and smoke dampers shall be provided with an approved means of access~~[, which]~~ that is large enough to permit inspection and maintenance of the damper and its operating parts. The access shall not affect the integrity of fire-resistance-rated assemblies. The access openings shall not reduce the fire-resistance rating of the assembly. Access points shall be permanently identified on the exterior by a label having letters not less than 1/2 inch (12.7 mm) in height reading: FIRE/SMOKE DAMPER, SMOKE DAMPER or FIRE DAMPER followed by an identification marking that is individual and unique to the damper accessed.

[716.5] 717.5 Where required. Fire dampers, smoke dampers, ~~[and]~~ combination fire/smoke dampers, and ceiling radiation dampers shall be provided as specified in ~~[this section]~~ Sections 717.5.1 through 717.5.7 and 717.6. Where an assembly is required to have both fire dampers and smoke dampers, combination fire/smoke dampers or a fire damper and a smoke damper shall be ~~[required]~~ provided.

Exception: Ducts 20 square inches [~~(129 cm²)~~] (12 903.2 mm²) or less passing through fire-resistance-rated assemblies shall not require fire dampers or fire smoke dampers.

[716.5.1] 717.5.1 Fire walls. Ducts and air transfer openings permitted in fire walls in accordance with Section 706.11 shall be protected with listed fire dampers and smoke dampers installed in accordance with their listing.

Exception: Smoke dampers shall not be required in ducts where the air continues to move and the air-handling system installed is arranged to prevent recirculation of exhaust or return air under fire emergency conditions. The air-handling system shall be continuously monitored to ensure continuous airflow at a constantly attended location and be inspected and maintained in accordance with the system manufacturer's instructions.

[716.5.1.1] 717.5.1.1 Horizontal exits. A listed smoke damper designed to resist the passage of smoke shall be provided at each point that a duct or air transfer opening penetrates a fire wall that serves as a horizontal exit.

~~[Exception: Smoke dampers shall not be required in ducts where the air continues to move and the air handling system installed is arranged to prevent recirculation of exhaust or return air under fire emergency conditions.]~~

[716.5.2] 717.5.2 Fire barriers. Ducts and air transfer openings that penetrate fire barriers (horizontal and wall assemblies) shall be protected with listed fire dampers installed in accordance with their listing. Ducts and air transfer openings shall not penetrate ~~[exit]~~ enclosures for interior exit stairways and ramps and exit passageways, except as permitted by Sections ~~[4022.4 and 4023.6]~~ 1023.5 and 1024.6, respectively. In addition, smoke dampers shall be installed in penetrations of public corridor and horizontal exit walls in accordance with Sections ~~[716.5.2.1]~~ 717.5.2.1 and ~~[716.5.2.2]~~ 717.5.2.2.

Exception: Fire dampers are not required at penetrations of fire barriers where any of the following apply:

1. Penetrations are tested in accordance with ASTM E 119 or UL 263 as part of the fire-resistance-rated assembly.

2. Ducts are used as part of an engineered smoke control system in accordance with ~~[Section]~~ Sections [716.2.4] 717.2.1 and ~~[Section]~~ 909 of this code where the use of a fire damper would interfere with the operation of a smoke control system.
3. Such walls are penetrated by ducted HVAC systems, have a required fire-resistance rating of 1 hour or less, are in areas of other than Group H and are in buildings equipped throughout with an automatic sprinkler system in accordance with Section 903.3.1.1 or Section 903.3.1.2 of this code. For the purposes of this exception, a ducted HVAC system shall be a duct system for conveying supply, return or exhaust air as part of the structure's HVAC system. Such a duct system shall be constructed of sheet steel not less than No. 26 gage thickness and shall be continuous from the air-handling appliance or equipment to the air outlet and inlet terminals.

~~[716.5.2.1] 717.5.2.1~~ Horizontal exits. A listed smoke damper designed to resist the passage of smoke shall be provided at each point a duct or air transfer opening penetrates a fire barrier that serves as a horizontal exit.

~~**[Exception:** Smoke dampers shall not be required in ducts where the air continues to move and the air-handling system installed is arranged to prevent recirculation of exhaust or return air under fire emergency conditions.]~~

~~[716.5.2.2] 717.5.2.2~~ Public corridors. A listed smoke damper designed to resist the passage of smoke shall be provided at each point a duct or air transfer opening penetrates a public corridor wall or floor constructed as a fire barrier.

Exceptions:

1. Smoke dampers are not required where the building is equipped throughout with an engineered smoke control system in accordance with Section 909, and smoke dampers are not necessary for the operation and control of the system.
2. Smoke dampers are not required in corridor penetrations where the duct is constructed of steel not less than 0.019-inch (0.48 mm) in thickness and there are no openings serving the corridor.
3. Smoke dampers are not required in corridor penetrations in Group R-2 buildings and Public Corridors serving R-2 spaces in mixed use buildings.
4. Smoke dampers shall not be required in ducts where the air continues to move and the air-handling system installed is arranged to prevent recirculation of exhaust or return air under fire emergency conditions. The air-handling system shall be continuously monitored to ensure continuous airflow at a constantly attended location and be inspected and maintained in accordance with the system manufacturer's instructions.

~~[716.5.3] 717.5.3~~ Shaft enclosures. Ducts and air transfer openings shall not penetrate a shaft serving as an exit enclosure except as permitted by Section ~~[4022.4]~~ 1023.5. Shaft enclosures

that are permitted to be penetrated by ducts and air transfer openings shall be protected with approved fire and smoke dampers installed in accordance with their listing.

Exceptions:

1. Fire dampers are not required at penetrations of shafts where any of the following criteria are met:
 - 1.1. ~~[Steel]~~ In buildings equipped throughout with an automatic sprinkler system in accordance with Chapter 9, steel exhaust subducts [are extended at least] having minimum thickness of 0.0187 inch (0.4712 mm) (No. 26 gage) extend not less than 22 inches ([559] 558.8 mm) vertically in exhaust shafts provided that there is a continuous airflow upward to the [outside;] outdoors whenever the building is occupied.
 - 1.2. Penetrations are tested in accordance with ASTM E 119 or UL 263 as part of the fire-resistance-rated assembly[;].
 - 1.3. Ducts are used as part of an approved smoke control system designed and installed in accordance with Section 909[;] and where the fire damper will interfere with the operation of the smoke control system[; or].
 - 1.4. The penetrations are in parking garage exhaust or supply shafts that are separated from other building shafts by not less than 2-hour fire-resistance-rated construction.
2. ~~[In Group B and R occupancies equipped throughout with an automatic sprinkler system in accordance with Section 903.3.1.1, smoke dampers are not required at penetrations of shafts where kitchen, bathroom and toilet room exhaust openings with steel exhaust subducts, having a minimum thickness of 0.0187 inch (0.4712 mm) (No. 36 gage), extend at least 22 inches (559 mm) vertically and where the exhaust fan at the upper terminus is powered continuously and maintains airflow upward to the outdoors.]~~ Smoke dampers are not required in exhaust ducts or shafts where the exhaust fan is maintained in operation whenever the building is occupied, in bathrooms and toilet room exhausts.
3. Smoke dampers are not required at [~~penetration~~] penetrations of exhaust or supply shafts in parking garages that are separated from other building shafts by not less than 2-hour fire-resistance-rated construction.
4. Smoke dampers are not required at penetrations of shafts where ducts are used as part of an engineered mechanical smoke control system designed in accordance with Section 909 and where the smoke damper will interfere with the operation of the smoke control system.
5. Fire dampers and/or smoke dampers are not required at a shaft where the shaft is acting as an extension of the mechanical equipment room that it serves and the shaft and mechanical equipment room maintain fire and smoke separation required by the

greater of the two spaces from the occupied portions of the building and meet the requirements of Sections ~~[708.11]~~ 713.11 and ~~[708.12]~~ 713.12.

6. Smoke dampers are not required to be located within a prescribed distance of a fire-rated enclosure within which the air handling equipment is located and where isolation smoke dampers are used in air-handling equipment in accordance with Section 607.2.3 of the *New York City Mechanical Code*.

7. Smoke dampers are not required in ducts where the air continues to move and the air-handling system installed is arranged to prevent recirculation of exhaust or return air during a fire emergency condition. Such fans shall be provided with standby power in accordance with Chapter 27.

~~[8. Smoke dampers are not required in exhaust ducts or shafts where the exhaust fan is maintained in operation during occupancy, such as in bathroom and toilet room exhausts.]~~

[~~716.5.3.1~~ 717.5.3.1 Limitations. Shafts that constitute air ducts shall be limited in accordance with Section 607.5.5.2 of the *New York City Mechanical Code*.

[~~716.5.4~~ 717.5.4 Fire partitions. Ducts and air transfer openings that penetrate fire partitions shall be protected with listed fire dampers installed in accordance with their listing.

Exceptions: In occupancies other than Group H, fire dampers are not required where any of the following apply:

1. The fire partitions are for tenant separation ~~[and]~~ or interior corridor walls in buildings equipped throughout with an automatic sprinkler system in accordance with Section 903.3.1.1 or 903.3.1.2 and the duct is protected as a ~~[through penetration]~~ through-penetration in accordance with Section ~~[713]~~ 714.

2. The fire partitions are for tenant partitions in covered mall buildings where the walls are not required by provisions elsewhere in the code to extend to the underside of the floor or roof sheathing, slab or deck above.

3. The duct system is constructed of approved materials in accordance with the *New York City Mechanical Code* and the duct penetrating the wall complies with all of the following requirements:

3.1. The duct shall not exceed 100 square inches ~~[(0.06 m²)]~~ (64 516 mm²).

3.2. The duct shall be constructed of steel ~~[a minimum of]~~ not less than 0.0217 inch (0.55 mm) in thickness.

3.3. The duct shall not have openings that communicate the corridor with adjacent spaces or rooms.

3.4. The duct shall be installed above a ceiling.

- 3.5. The duct shall not terminate at a wall register in the fire-resistance-rated wall.
- 3.6. A minimum 12-inch-long (~~[305]~~ 304.8 mm) by 0.060-inch [~~thick~~] (1.52 mm) thick steel sleeve shall be centered in each duct opening. The sleeve shall be secured to both sides of the wall and all four sides of the sleeve with minimum 1½-inch by 1½-inch by 0.060-inch (~~[38]~~ 38.1 mm by ~~[38]~~ 38.1 mm by 1.52 mm) steel retaining angles. The retaining angles shall be secured to the sleeve and the wall with No. 10 (M5) screws. The annular space between the steel sleeve and the wall opening shall be filled with mineral wool batting or approved equivalent on all sides.

4. Such walls are penetrated by ducted HVAC systems, have a required fire-resistance rating of 1 hour or less, and are in buildings equipped throughout with an automatic sprinkler system in accordance with Section 903.3.1.1 or 903.3.1.2. For the purposes of this exception, a ducted HVAC system shall be a duct system for conveying supply, return or exhaust air as part of the structure's HVAC system. Such a duct system shall be constructed of sheet steel not less than No. 26 gage thickness and shall be continuous from the air-handling appliance or equipment to the air outlet and inlet terminals.

~~[716.5.5]~~ **717.5.5 Smoke barriers.** A listed smoke damper designed to resist the passage of smoke shall be provided at each point a duct or air transfer opening penetrates a smoke barrier. Smoke dampers and smoke damper actuation methods shall comply with Section ~~[716.3.3.2]~~ 717.3.3.2.

Exceptions:

1. Smoke dampers are not required where the openings in ducts are limited to a single smoke compartment and the ducts are constructed of steel.
2. Smoke dampers are not required in ducts where the air continues to move and the air-handling system installed is arranged to prevent recirculation of exhaust or return air under fire emergency conditions.
3. Smoke dampers are not required in smoke barriers required by Section 407.5 for Group I-2, Condition 2 where the HVAC system is fully ducted in accordance with Section 603 of the *New York City Mechanical Code* and where buildings are equipped throughout with an automatic sprinkler system in accordance with Section 903.3.1.1 and equipped with quick-response sprinklers in accordance with Section 903.3.2.

~~[716.5.6]~~ **717.5.6 Exterior walls.** Ducts and air transfer openings in fire-resistance-rated exterior walls required to have protected openings in accordance with Section 705.10 shall be protected with listed fire dampers installed in accordance with their listing.

~~[716.5.7]~~ **717.5.7 Smoke partitions.** A listed smoke damper designed to resist the passage of smoke shall be provided at each point that an air transfer opening penetrates a smoke partition. Smoke dampers and smoke damper actuation methods shall comply with Section ~~[716.3.3.2]~~ 717.3.3.2.

[Exceptions: 1.] Exception:

Where the installation of a smoke damper will interfere with the operation of a required smoke control system in accordance with Section 909, approved alternative protection shall be utilized.

~~[2. Smoke dampers shall not be required in ducts where the air continues to move and the air handling system installed is arranged to prevent recirculation of exhaust or return air under fire emergency conditions.]~~

[716.6] 717.6 Horizontal assemblies. Penetrations by ducts and air transfer openings of a floor, floor/ceiling assembly or the ceiling membrane of a roof/ceiling assembly shall be protected by a shaft enclosure that complies with Section ~~[708]~~ 713 or shall comply with Sections ~~[716.6.1]~~ 717.6.1 through ~~[716.6.3]~~ 717.6.3.

~~[716.6.1 Through penetrations.]~~ **717.6.1 Through-penetrations.** In occupancies other than Groups I-2 and I-3, a duct and air transfer opening system constructed of approved materials in accordance with the *New York City Mechanical Code* that penetrates a fire-resistance-rated floor/ceiling assembly that connects not more than two stories is permitted without shaft enclosure protection, provided a listed fire damper is installed at the floor line ~~[and the penetration is fireblocked in accordance with Section 717.2.5]~~ or the duct is protected in accordance with Section ~~[713.4]~~ 714.4. For air transfer openings, see ~~[Exception 7 to]~~ Section ~~[708.2]~~ 712.1.9.

Exception: A duct serving a dwelling unit is permitted to penetrate three floors or less without a fire damper at each floor, provided such duct meets all of the following requirements:

1. The duct shall be contained and located within the cavity of a wall and shall be constructed of steel having a minimum wall thickness of ~~[0.187 inches (0.4712 mm)]~~ 0.0187 inches (0.4749 mm) (No. 26 gage).
2. The duct shall open into only one dwelling or sleeping unit and the duct system shall be continuous from the unit to the exterior of the building.
3. The duct shall not exceed 5-inch (127 mm) nominal diameter and the total area of such ducts shall not exceed 100 square inches (0.065 m²) in any 100 square feet (9.3 m²) of floor area.
4. The annular space around the duct is protected with materials that prevent the passage of flame and hot gases sufficient to ignite cotton waste where subjected to ASTM E 119 or UL 263 time-temperature conditions under a minimum positive pressure differential of 0.01 inch (2.49 Pa) of water at the location of the penetration for the time period equivalent to the fire-resistance rating of the construction penetrated.
5. Grille openings located in a ceiling of a fire-resistance-rated floor/ceiling or roof/ceiling assembly shall be protected with a listed ceiling radiation damper installed in accordance with Section ~~[716.6.2]~~ 717.6.2.1 of this code.

[716.6.2] 717.6.2 Membrane penetrations. Ducts and air transfer openings constructed of approved materials in accordance with the *New York City Mechanical Code* that penetrate the ceiling membrane of a fire-resistance-rated floor/ceiling assembly or roof/ceiling assembly shall be protected with one of the following:

1. A shaft enclosure in accordance with Section [708] 713.
2. A listed ceiling radiation damper and firestopping is installed at the ceiling line where a duct penetrates the ceiling of a fire-resistance-rated floor/ceiling assembly or roof/ceiling assembly.
3. A listed ceiling radiation damper and firestopping is installed at the ceiling line where a diffuser with no duct attached penetrates the ceiling of a fire-resistance-rated floor/ceiling assembly or roof/ceiling assembly.

[716.6.2.1] 717.6.2.1 Ceiling radiation dampers. Ceiling radiation dampers shall be tested [~~as part of a fire-resistance-rated floor/ceiling or roof/ceiling assembly~~] in accordance with [~~ASTM E 119 or UL 263~~] Section 717.3.1. Ceiling radiation dampers shall be installed in accordance with the details listed in [~~a~~] the fire-resistance-rated assembly and the manufacturer's [~~installation~~] instructions and the listing. Ceiling radiation dampers are not required where [~~either~~] one of the following applies:

1. Tests in accordance with ASTM E 119 or UL 263 have shown that ceiling radiation dampers are not necessary in order to maintain the fire-resistance rating of the assembly.
2. Where exhaust duct penetrations are protected in accordance with Section [713.4.1.2] 714.4.2 of this code, are located within the cavity of a wall and do not pass through another dwelling unit or tenant space.
3. Where duct and air transfer openings are protected with a duct outlet protection system tested as part of a fire-resistance-rated assembly in accordance with ASTM E 119 or UL 263.

[716.6.3] 717.6.3 Nonfire-resistance-rated floor assemblies. Duct systems constructed of approved materials in accordance with the *New York City Mechanical Code* that penetrate nonfire-resistance-rated floor assemblies shall be protected by any of the following methods:

1. A shaft enclosure in accordance with Section [708] 713.
2. The duct connects not more than two stories, and the annular space around the penetrating duct is protected with [~~an approved~~] a listed noncombustible material that resists the free passage of flame and the products of combustion.
3. [~~The~~] In floor assemblies composed of noncombustible materials, a shaft shall not be required where the duct connects not more than three stories [~~and~~], the annular space around the penetrating duct is protected with an approved noncombustible material that resists the free passage of flame and the products of combustion[;] and a fire damper is installed at each floor line.

Exception: Fire dampers are not required in ducts within individual residential dwelling units.

[716.7] 717.7 Flexible ducts and air connectors. Flexible ducts and air connectors shall not pass through any fire-resistance-rated assembly. Flexible air connectors shall not pass through any wall, floor or ceiling.

SECTION BC ~~[717]~~ 718 CONCEALED SPACES

[717.1] 718.1 General. Fireblocking and draftstopping shall be installed in combustible and noncombustible concealed locations in accordance with this section. Fireblocking shall comply with Section ~~[717.2]~~ 718.2. Draftstopping in floor/ceiling spaces and attic spaces shall comply with Sections ~~[717.3]~~ 718.3 and ~~[717.4]~~ 718.4, respectively. The permitted use of combustible materials in concealed spaces of buildings of Type I or II construction shall be limited to the applications indicated in Section ~~[717.5]~~ 718.5. Installations of fireblocking and draftstopping shall comply with the special inspection requirements of Chapter 17.

Exception: Concealed spaces that are sprinklered in accordance with Chapter 9 or are constructed as a shaft.

[717.2] 718.2 Fireblocking. In combustible and noncombustible construction, fireblocking shall be installed to cut off concealed draft openings (both vertical and horizontal) and shall form an effective barrier between floors, between a top story and a roof or attic space. Fireblocking shall be installed in the locations specified in Sections ~~[717.2.2]~~ 718.2.2 through ~~[717.2.7]~~ 718.2.7.

[717.2.1] 718.2.1 Fireblocking materials. Fireblocking shall consist of the following materials:

1. Two-inch (~~[51]~~ 50.8 mm) nominal lumber.
2. Two thicknesses of 1-inch (~~[25]~~ 25.4 mm) nominal lumber with broken lap joints.
3. One thickness of 0.719-inch (18.3 mm) wood structural panels with joints backed by 0.719-inch (18.3 mm) wood structural panels.
4. One thickness of 0.75-inch (~~[19 mm]~~) (19.1 mm) particleboard with joints backed by 0.75-inch (~~[19 mm]~~) (19.1 mm) particleboard.
5. One-half-inch (12.7 mm) gypsum board.
6. One-fourth-inch (6.4 mm) cement[-]-based millboard.
7. Batts or blankets of mineral wool[;] and mineral fiber [~~or other approved materials~~] installed in such a manner as to be securely retained in place.
8. Other materials approved by the commissioner.

[717.2.1.1] 718.2.1.1 Batts or blankets of mineral wool or mineral fiber. Batts or blankets of mineral or glass fiber or other [~~approved~~] listed nonrigid materials shall be permitted for

compliance with the 10-foot (3048 mm) horizontal fireblocking in walls constructed using parallel rows of studs or staggered studs.

[717.2.1.2] 718.2.1.2 Unfaced fiberglass. Unfaced fiberglass batt insulation used as fireblocking shall fill the entire cross section of the wall cavity to a minimum height of 16 inches (~~[406]~~ 406.4 mm) measured vertically. ~~[When]~~ Where piping, conduit or similar obstructions are encountered, the insulation shall be packed tightly around the obstruction.

[717.2.1.3] 718.2.1.3 Loose-fill insulation material. Loose-fill insulation material, insulating foam sealants and caulk materials shall not be used as a ~~[fire-block]~~ fireblock unless specifically tested in the form and manner intended for use to demonstrate its ability to remain in place and to retard the spread of fire and hot gases.

[717.2.1.4] 718.2.1.4 Fireblocking integrity. The integrity of ~~[fire-blocks]~~ fireblocks shall be maintained.

[717.2.1.5] 718.2.1.5 Double stud walls. Batts or blankets of mineral or glass fiber or other approved nonrigid materials shall be allowed as fireblocking in walls constructed using parallel rows of studs or staggered studs.

[717.2.2] 718.2.2 Concealed wall spaces. Fireblocking shall be provided in concealed spaces of stud walls and partitions, including furred spaces, and parallel rows of studs or staggered studs, as follows:

1. Vertically at the ceiling and floor levels.
2. Horizontally at intervals not exceeding 10 feet (3048 mm).

[717.2.3] 718.2.3 Connections between horizontal and vertical spaces. Fireblocking shall be provided at interconnections between concealed vertical stud wall or partition spaces and concealed horizontal spaces created by an assembly of floor joists or trusses, and between concealed vertical and horizontal spaces such as occur at soffits, drop ceilings, cove ceilings and similar locations.

[717.2.4] 718.2.4 Stairways. Fireblocking shall be provided in concealed spaces between stair stringers at the top and bottom of the run. Enclosed spaces under ~~[stairs]~~ stairways shall also comply with Section ~~[1009.6.3]~~ 1011.7.3.

[717.2.5] 718.2.5 Ceiling and floor openings. Where required by ~~[Exception 6 of]~~ Section ~~[708.2]~~ 712.1.8, Exception 1 of Section ~~[713.4.1.2,]~~ 714.4.2 or Section ~~[713.4.2]~~ 714.5, fireblocking of the annular space around vents, pipes, ducts, chimneys and fireplaces at ceilings and floor levels shall be installed with a material specifically tested in the form and manner intended for use to demonstrate its ability to remain in place and resist the free passage of flame and the products of combustion.

[717.2.5.1] 718.2.5.1 Factory-built chimneys and fireplaces. Factory-built chimneys and fireplaces shall be ~~[fire-blocked]~~ fireblocked in accordance with UL 103 and UL 127.

[717.2.6] 718.2.6 Architectural trim. Fireblocking shall be installed within concealed spaces of exterior wall ~~[finish]~~ coverings and other exterior architectural elements where permitted to be of combustible construction as specified in Section 1406 or where erected with combustible frames, at maximum intervals of 20 feet (6096 mm) so that there will be no open space exceeding 100 square feet (9.3 m²). Where wood furring strips are used, they shall be of approved wood of natural decay resistance or preservative-treated wood. If non-continuous, such elements shall have closed ends, with at least 4 inches (~~[102]~~ 101.6 mm) of separation between sections. For the purposes of this section, fenestration products, and flashing of fenestration products and water-resistive barrier flashing and accessories at other locations, including through wall flashings and attachment accessories, shall not be considered combustible construction.

Exceptions:

1. Fireblocking of cornices is not required in single-family dwellings. Fireblocking of cornices of a two-family dwelling is required only at the line of dwelling unit separation.
2. Fireblocking shall not be required where the exterior wall covering does not contain plastic or foam plastic insulation, is installed on noncombustible framing and the ~~[face of the exposed to the concealed space is covered by]~~ exterior wall covering is one of the following materials:
 - 2.1. Aluminum siding having a minimum thickness of 0.019 inch (0.5 mm).
 - 2.2. Corrosion-resistant steel ~~[having a base metal thickness]~~ siding not less than 0.016 inch (0.4 mm) at any point.
 - ~~[2.3. Other approved noncombustible materials.]~~
 - 2.3 Walls in which the water-resistive barrier is the only combustible component and the exterior wall has a wall covering of brick, concrete, stone, terra cotta, stucco or steel with minimum thicknesses in accordance with Table 1405.2.
3. Exterior wall coverings containing plastics, metal composite materials (MCM) or high-pressure decorative exterior-grade compact laminates (HPL) panels shall comply with Section 718.2.6.1.

718.2.6.1 Exterior wall coverings containing plastics, metal composite materials (MCM) or high-pressure decorative exterior-grade compact laminates (HPL) panels. Exterior wall coverings containing plastics complying with Chapter 26, metal composite materials (MCM) or high-pressure decorative exterior-grade compact laminates (HPL), shall be fireblocked.

718.2.6.1.1 Locations. Noncombustible fireblocking materials shall be required at all of the following locations to cut off concealed spaces within the exterior wall covering:

1. Around wall openings.

2. In alignment with the slab edge, for a height of not less than 8 inches (203.2 mm), and at maximum intervals of 20 feet (6096 mm) vertically.
3. Between different occupancy groups, horizontally or vertically, as applicable.

718.2.6.1.2 Foam plastic insulation. Foam plastic insulation in the exterior wall covering shall be interrupted with noncombustible materials approved for fireblocking at locations specified in Section 718.2.6.1.1.

Exceptions:

1. One-story buildings complying with Section 2603.4.1.4.
2. Fireblocking shall not be required at each floor level and interrupt the foam plastic insulation provided the foam plastic insulation has a flame spread index of not more than 25 as determined in accordance with ASTM E 84 or UL 723 and comply with the following conditions:
 - 2.1. **Concrete and masonry veneer.** Fireblocking material shall not be required at each floor level for concrete or masonry veneer installed less than 75 feet (22 860 mm) above grade as part of an exterior wall covering containing foam plastic insulation, with or without air space, and installed on masonry or concrete backup walls.
 - 2.2. **Exterior insulation and finish systems (EIFS).** Fireblocking material shall not be required at each floor level for EIFS containing foam plastic insulation installed less than 75 feet (22 860 mm) above grade, and installed on masonry or concrete backup walls.
3. **Detached one- and two-family dwellings.** Fireblocking of foam plastic insulation shall not be required at each floor level in detached one- and two-family dwellings of Type V construction that do not exceed three stories or 40 feet (12 192 mm) in height above grade plane.

~~[717.2.7]~~ **718.2.7 Concealed sleeper spaces.** Where wood sleepers are used for laying wood flooring on masonry or concrete fire-resistance-rated floors, the space between the floor slab and the underside of the wood flooring shall be filled with an approved material to resist the free passage of flame and products of combustion or ~~[fire blocked]~~ fireblocked in such a manner that there will be no open spaces under the flooring that will exceed 20 square feet (1.86 m²) in area and such space shall be filled solidly under permanent partitions so that there is no communication under the flooring between adjoining rooms.

Exceptions:

1. Fireblocking is not required for slab-on-grade floors in gymnasiums.
2. Fireblocking is required only at the juncture of each alternate lane and at the ends of each lane in a bowling facility.

[717.3] 718.3 Draftstopping in floors. In combustible and noncombustible construction, draftstopping shall be installed to subdivide floor/ceiling assemblies in the locations prescribed in Sections ~~[717.3.2]~~ 718.3.2 through ~~[717.3.3]~~ 718.3.3.

~~[717.3.1]~~ 718.3.1 Draftstopping materials. In noncombustible construction, draftstopping shall be of noncombustible materials. In combustible construction, draftstopping materials shall be not ~~[be]~~ less than $\frac{1}{2}$ -inch (12.7 mm) gypsum board, $\frac{3}{8}$ -inch (9.5 mm) wood structural panel, $\frac{3}{8}$ -inch (9.5 mm) particleboard, 1-inch (25 mm) nominal lumber, cement fiberboard, batts or blankets of mineral wool or glass fiber, or other approved materials adequately supported. The integrity of ~~[draft-stops]~~ draftstops shall be maintained.

~~[717.3.2]~~ 718.3.2 Group R. Draftstopping shall be provided in floor/ceiling spaces in Group R buildings. Draftstopping shall be located above and in line with the dwelling unit separations.

Exceptions:

1. Draftstopping is not required in buildings equipped throughout with an automatic sprinkler system in accordance with Section 903.3.1.1.
2. Draftstopping is not required in buildings equipped throughout with an automatic sprinkler system in accordance with Section 903.3.1.2, provided that automatic sprinklers are ~~[also]~~ installed in the combustible concealed spaces where the draftstopping is being omitted.
3. Where laminated wood I-joint assemblies are used, the space between the ceiling and the floor or roof above shall be divided into approximately equal areas not greater than 500 square feet (46.5 m²).
4. Draftstopping shall not be required where the structural members within the concealed ceiling space are individually protected on all sides for their full length with materials having the required fire-resistance rating.

~~[717.3.3]~~ 718.3.3 Other groups. In occupancies other than Group R, ~~[draft-stopping]~~ draftstopping shall be installed so that horizontal floor areas do not exceed 3,000 square feet (~~[279]~~ 278.7 m²).

Exceptions:

1. Draftstopping is not required in buildings equipped throughout with an automatic sprinkler system in accordance with Section 903.3.1.1.
2. Draftstopping shall not be required where the structural members within the concealed ceiling space are individually protected on all sides for their full length with materials having the required fire-resistance rating.

~~[717.4]~~ 718.4 Draftstopping in attics. In combustible and noncombustible construction, draftstopping shall be installed to subdivide attic spaces and concealed roof spaces in the locations prescribed in Sections ~~[717.4.2]~~ 718.4.2 and ~~[717.4.3]~~ 718.4.3. Ventilation of concealed roof spaces shall be maintained in accordance with Section 1203.2.

[717.4.1] 718.4.1 Draftstopping materials. Materials utilized for draftstopping of attic spaces shall comply with Section ~~[717.3.1]~~ 718.3.1.

[717.4.1.1] 718.4.1.1 Openings. Openings in draftstop partitions provided in accordance with Section 1209.2 shall be protected by self-closing doors with automatic latches constructed as required for the partitions.

[717.4.2] 718.4.2 Groups R-1 and R-2. Draftstopping shall be provided in attics, mansards, overhangs or other concealed roof spaces of Group R-2 buildings with three or more dwelling units and in all Group R-1 buildings. Draftstopping shall be installed above, and in line with dwelling unit separation walls that do not extend to the underside of the roof sheathing above.

Exceptions:

1. Draftstopping shall not be required where the structural members within the concealed attic space are individually protected on all sides for their full length with materials having the required fire-resistance rating.
2. Draftstopping is not required in buildings equipped throughout with an automatic sprinkler system in accordance with Section 903.3.1.1.
3. In occupancies in Group R-2 that do not exceed four stories above grade plane, the attic space shall be subdivided by ~~[draft-stops]~~ draftstops into areas not exceeding 3,000 square feet (~~[279]~~ 278.7 m²) or above every two dwelling units, whichever is smaller.
4. Draftstopping is not required in buildings equipped throughout with an automatic sprinkler system in accordance with Section 903.3.1.2, provided that automatic sprinklers are ~~[also]~~ installed in the combustible concealed ~~[spaces]~~ space where the draftstopping is being omitted.
5. Where laminated wood I-joint assemblies are used, the space between the ceiling and the floor or roof above shall be divided into approximately equal areas not greater than 500 square feet (46.5 m²).

[717.4.3] 718.4.3 Other groups. Draftstopping shall be installed in attics and concealed roof spaces, such that any horizontal area does not exceed 3,000 square feet (~~[279]~~ 278.7 m²).

Exceptions:

1. Draftstopping is not required in buildings equipped throughout with an automatic sprinkler system in accordance with Section 903.3.1.1.
2. Draftstopping shall not be required where the structural members within the concealed attic space are individually protected on all sides for their full length with materials having the required fire-resistance rating.

3. Where laminated wood I-joint assemblies are used, the space between the ceiling and the floor or roof above shall be divided into approximately equal areas not greater than 500 square feet (46.5 m²).

[717.5] 718.5 Combustible materials in concealed spaces in Type I or II construction. Combustible materials shall not be permitted in concealed spaces of buildings of Type I or II construction.

Exceptions:

1. Combustible materials in accordance with Section 603 of this code.
2. Combustible materials exposed [~~with~~] within plenums complying with Section 602 of the *New York City Mechanical Code*.
3. Class A interior finish materials classified in accordance with Section 803 of this code.
4. Combustible piping within partitions or shaft enclosures installed in accordance with the provisions of this code.
5. Combustible piping within concealed ceiling spaces installed in accordance with the *New York City Mechanical Code* and the *New York City Plumbing Code*.
6. Combustible insulation and covering on pipe and tubing, installed in concealed spaces other than plenums, complying with Section [~~719.7~~] 720.7 of this code.

**SECTION BC [~~718~~] 719
FIRE-RESISTANCE REQUIREMENTS FOR PLASTER**

[718.1] 719.1 Thickness of plaster. The minimum thickness of gypsum plaster or portland cement plaster used in a fire-resistance-rated system shall be determined by the prescribed fire tests. The plaster thickness shall be measured from the face of the lath where applied to gypsum lath or metal lath.

[718.2] 719.2 Plaster equivalents. For fire-resistance purposes, 1/2 inch (12.7 mm) of unsanded gypsum plaster shall be deemed equivalent to 3/4 inch (19.1 mm) of one-to-three gypsum sand plaster or 1 inch ([~~25~~] 25.4 mm) of portland cement sand plaster.

[718.3] 719.3 Noncombustible furring. In buildings of Type I and II construction, plaster shall be applied directly on concrete or masonry or on approved noncombustible plastering base and furring.

[718.4] 719.4 Double reinforcement. Plaster protection more than 1 inch ([~~25~~] 25.4 mm) in thickness shall be reinforced with an additional layer of approved lath embedded [~~at least~~] not less than 3/4 inch (19.1 mm) from the outer surface and fixed securely in place.

Exception: Solid plaster partitions or where otherwise determined by fire tests.

[718.5] 719.5 Plaster alternatives for concrete. In reinforced concrete construction, gypsum plaster or portland cement plaster is permitted to be substituted for $\frac{1}{2}$ inch (12.7 mm) of the required poured concrete protection, except that a minimum thickness of $\frac{3}{8}$ inch (9.5 mm) of poured concrete shall be provided in reinforced concrete floors and 1 inch (~~25~~ 25.4 mm) in reinforced concrete columns in addition to the plaster finish. The concrete base shall be prepared in accordance with Section 2510.7.

SECTION BC ~~719~~ 720 **THERMAL- AND SOUND-INSULATING MATERIALS**

[719.1] 720.1 General. Insulating materials, including facings such as vapor retarders and vapor-permeable membranes, similar coverings, and all layers of single and multilayer reflective foil insulations, shall comply with the requirements of this section. Where a flame spread index or a smoke-development index is specified in this section, such index shall be determined in accordance with ASTM E 84 or UL 723. Any material that is subject to an increase in flame spread index or smoke-development index beyond the limits herein established through the effects of age, moisture[,] or other atmospheric conditions shall not be permitted.

Exceptions:

1. Fiberboard insulation shall comply with Chapter 23 of this code.
2. Foam plastic insulation shall comply with Chapter 26 of this code.
3. Duct and pipe insulation and duct and pipe coverings and linings in plenums shall comply with the *New York City Mechanical Code*.
4. EIFS shall comply with Chapters 14 and 26 of this code.

[719.1.1] 720.1.1 Noncombustible construction. Insulating materials used in noncombustible construction must either:

1. Satisfactorily pass a test for determining noncombustibility of elementary materials, based on the test procedures of ASTM E 136; or
2. Have a flame spread index not greater than 25, a smoke-development index not greater than 50, and be without evidence of continued progressive combustion when tested in accordance with ASTM E 84.

[719.1.2] 720.1.2 Combustible construction. Insulating materials used in combustible construction shall have a flame spread index not greater than 25, a smoke-development index not greater than 450, and be without evidence of continuous progressive combustion when tested in accordance with ASTM E 84.

[719.2] 720.2 Concealed installation. Insulating materials, where concealed as installed in buildings of any type construction, shall comply with Sections ~~[719.1.1]~~ 720.1.1, ~~[719.1]~~ 720.1 and ~~[719.1.2]~~ 720.1.2. Concealed insulation shall be separated from the building interior by a thermal barrier consisting of at least 1/2-inch~~[-thick]~~ (12.7 mm) thick gypsum wallboard or approved equivalent.

Exception: ~~[Cellulose]~~ Cellulosic fiber loose-fill insulation ~~[that is not spray applied,]~~ complying with the requirements of Section ~~[719.6,]~~ 720.6 shall only be required to meet ~~[the]~~ a smoke-development index of not more than 450, when tested in accordance with CAN/ULC S102.2, provided such insulation has a smoke-development index that complies with the requirements of Section 720.2 or 720.3, as applicable, and Section 720.6 of this code.

~~[719.2.1]~~ 720.2.1 Facings. Where such materials are installed in concealed spaces in buildings of Type III, IV or V construction, the flame spread and smoke-development limits do not apply to facings, coverings, and layers of reflective foil insulation that are installed behind and in substantial contact with the unexposed surface of the ceiling, wall or floor finish.

Exception: All layers of single and multilayer reflective plastic core insulation shall comply with Section ~~[2613]~~ 2614.

~~[719.3]~~ 720.3 Exposed installation. Insulation materials, where exposed as installed in buildings of any type of construction, shall have a flame spread index of not more than 25 and a smoke-development index of not more than 50.

Exception: ~~[Cellulose]~~ Cellulosic fiber loose-fill insulation ~~[that is not spray applied]~~ complying with the requirements of Section ~~[719.6]~~ 720.6 shall ~~[only]~~ not be required to meet ~~[the]~~ a flame spread index requirement but shall be required to meet a smoke-development index of not more than 50 when tested in accordance with CAN/ULC S102.2.

~~[719.3.1]~~ 720.3.1 Attic floors. Exposed insulation materials installed on attic floors shall have a critical radiant flux of not less than 0.12 watt per square centimeter when tested in accordance with ASTM E 970.

~~[719.3.2]~~ Toxicity. ~~Upon exposure to fire, insulating materials used in building interiors, including facings, such as vapor retarders and vapor permeable membranes, similar coverings, and all layers of single and multilayer reflective foil insulation, shall not produce products of decomposition or combustion that are more toxic in point of concentration than those given off by wood or paper when decomposing or burning under comparable conditions in accordance with test standards approved by the department.]~~

~~[719.4]~~ 720.4 Loose-fill insulation. Loose-fill insulation materials that cannot be mounted in the ASTM E 84 apparatus without a screen or artificial supports shall comply with the flame spread and smoke-developed limits of Sections ~~[719.2]~~ 720.2 and ~~[719.3]~~ 720.3 when tested in accordance with CAN/ULC S102.2.

Exception: ~~[Cellulose]~~ Cellulosic fiber loose-fill insulation shall not be required to ~~[be]~~ meet a flame spread index requirement when tested in accordance with CAN/ULC S102.2, provided such insulation has a smoke-development index that complies with the requirements of Section ~~[719.2]~~ 720.2 or ~~[719.3]~~ 720.3, as applicable, and Section ~~[719.6]~~ 720.6.

[719.5] 720.5 Roof insulation. The use of combustible roof insulation not complying with Sections [719.2] 720.2 and [719.3] 720.3 shall be permitted in any type of construction provided it is applied on top of roof decking or slab and that such insulation is covered with approved roof coverings directly applied thereto.

[719.6 Cellulose] 720.6 Cellulosic fiber loose-fill insulation and self-supported spray-applied cellulosic insulation. ~~[Cellulose]~~ Cellulosic fiber loose-fill insulation and self-supported spray-applied cellulosic insulation shall comply with CPSC 16 CFR[, Part] Parts 1209 and [CPSC 16 CFR, Part] 1404. Each package of such insulating material shall be clearly labeled in accordance with CPSC 16 CFR[, Part] Parts 1209 and [CPSC 16 CFR, Part] 1404.

[719.7] 720.7 Insulation and covering on pipe and tubing. Insulation and covering on pipe and tubing shall comply with the requirements of the *New York City Mechanical Code*, the *New York City Plumbing Code*, and the *New York City Energy Conservation Code*.

**SECTION BC [720] 721
PRESCRIPTIVE FIRE RESISTANCE**

[720.1] 721.1 General. The provisions of this section contain prescriptive details of fire-resistance-rated building elements, components or assemblies. The materials of construction listed in Tables [720.1(1)] 721.1(1), [720.1(2)] 721.1(2), and [720.1(3)] 721.1(3) shall be assumed to have the fire-resistance ratings prescribed therein. Where materials that change the capacity for heat dissipation are incorporated into a fire-resistance-rated assembly, fire test results or other substantiating data shall be made available to the commissioner to show that the required fire-resistance[-] rating time period is not reduced.

**TABLE [720.1(1)] 721.1(1)
MINIMUM PROTECTION OF STRUCTURAL PARTS BASED ON TIME PERIODS
FOR VARIOUS NONCOMBUSTIBLE INSULATING MATERIALS^m**

STRUCTURAL PARTS TO BE PROTECTED	ITEM NUMBER	INSULATING MATERIAL USED	MINIMUM THICKNESS OF INSULATING MATERIAL FOR THE FOLLOWING FIRE-RESISTANCE PERIODS (inches)			
			4 [hour] hours	3 [hour] hours	2 [hour] hours	1 hour
1. Steel columns and all of primary trusses	1-1.1	Carbonate, lightweight and sand-lightweight aggregate concrete, members 6" × 6" or greater (not including sandstone, granite and siliceous gravel). ^a	2½	2	1½	1
	1-1.2	Carbonate, lightweight and sand-lightweight aggregate concrete, members 8" × 8" or greater (not including sandstone, granite and siliceous gravel). ^a	2	1½	1	1
	1-1.3	Carbonate, lightweight and sand-lightweight aggregate concrete, members 12" × 12" or greater (not including sandstone, granite and siliceous gravel). ^a	1½	1	1	1
	1-1.4	Siliceous aggregate concrete and concrete excluded in Item 1-1.1, members 6" × 6" or greater. ^a	3	2	1½	1
	1-1.5	Siliceous aggregate concrete and concrete excluded in Item 1-1.1, members 8" × 8" or greater. ^a	2½	2	1	1
	1-1.6	Siliceous aggregate concrete and concrete excluded in Item 1-1.1, members 12" × 12" or greater. ^a	2	1	1	1

TABLE [720.1(1)] 721.1(1)
MINIMUM PROTECTION OF STRUCTURAL PARTS BASED ON TIME PERIODS
FOR VARIOUS NONCOMBUSTIBLE INSULATING MATERIALS^m

STRUCTURAL PARTS TO BE PROTECTED	ITEM NUMBER	INSULATING MATERIAL USED	MINIMUM THICKNESS OF INSULATING MATERIAL FOR THE FOLLOWING FIRE-RESISTANCE PERIODS (inches)			
			4 [hour] hours	3 [hour] hours	2 [hour] hours	1 hour
1. Steel columns and all of primary trusses	1-2.1	Clay or shale brick with brick and mortar fill. ^a	3 ³ / ₄	—	—	2 ¹ / ₄
1. Steel columns and all of primary trusses	1-3.1	4" hollow clay tile in two 2" layers; 1/2" mortar between tile and column; 3/8" metal mesh 0.046" wire diameter in horizontal joints; tile fill. ^a	4	—	—	—
	1-3.2	2" hollow clay tile; 3/4" mortar between tile and column; 3/8" metal mesh 0.046" wire diameter in horizontal joints; limestone concrete fill; ^a plastered with 3/4" gypsum plaster.	3	—	—	—
	1-3.3	2" hollow clay tile with outside wire ties 0.08" diameter at each course of tile or 3/8" metal mesh 0.046" diameter wire in horizontal joints; limestone or trap-rock concrete fill ^a extending 1" outside column on all sides.	—	—	3	—
	1-3.4	2" hollow clay tile with outside wire ties 0.08" diameter at each course of tile with or without concrete fill; 3/4" mortar between tile and column.	—	—	—	2
1. Steel columns and all of primary trusses	1-4.1	Cement plaster over metal lath wire tied to 3/4" cold-rolled vertical channels with 0.049" (No. 18 B.W. gage) wire ties spaced 3" to 6" on center. Plaster mixed 1:2 1/2 by volume, cement to sand.	—	—	2 ¹ / ₂ ^b	7/8
1. Steel columns and all of primary trusses	1-5.1	Vermiculite concrete, 1:4 mix by volume over paperbacked wire fabric lath wrapped directly around column with additional 2" x 2" 0.065"/0.065" (No. 16/16 B.W. gage) wire fabric placed 3/4" from outer concrete surface. Wire fabric tied with 0.049" (No. 18 B.W. gage) wire spaced 6" on center for inner layer and 2" on center for outer layer.	2	—	—	—
1. Steel columns and all of primary trusses	1-6.1	Perlite or vermiculite gypsum plaster over metal lath wrapped around column and furred 1 1/4" from column flanges. Sheets lapped at ends and tied at 6" intervals with 0.049" (No. 18 B.W. gage) tie wire. Plaster pushed through to flanges.	1 1/2	1	—	—
	1-6.2	Perlite or vermiculite gypsum plaster over self-furring metal lath wrapped directly around column, lapped 1" and tied at 6" intervals with 0.049" (No. 18 B.W. gage) wire.	1 3/4	1 3/8	1	—
	1-6.3	Perlite or vermiculite gypsum plaster on metal lath applied to 3/4" cold-rolled channels spaced 24" apart vertically and wrapped flatwise around column.	1 1/2	—	—	—

TABLE [720.1(1)] 721.1(1)
MINIMUM PROTECTION OF STRUCTURAL PARTS BASED ON TIME PERIODS
FOR VARIOUS NONCOMBUSTIBLE INSULATING MATERIALS^m

STRUCTURAL PARTS TO BE PROTECTED	ITEM NUMBER	INSULATING MATERIAL USED	MINIMUM THICKNESS OF INSULATING MATERIAL FOR THE FOLLOWING FIRE-RESISTANCE PERIODS (inches)			
			4 [hour] hours	3 [hour] hours	2 [hour] hours	1 hour
	1-6.4	Perlite or vermiculite gypsum plaster over two layers of 1/2" plain full-length gypsum lath applied tight to column flanges. Lath wrapped with 1" hexagonal mesh of No. 20 gage wire and tied with doubled 0.035" diameter (No. 18 B.W. gage) wire ties spaced 23" on center. For three-coat work, the plaster mix for the second coat shall not exceed 100 pounds of gypsum to 2 1/2 cubic feet of aggregate for the 3-hour system.	2 1/2	2	—	—
	1-6.5	Perlite or vermiculite vermiculite gypsum plaster over one layer of 1/2" plain full-length gypsum lath applied tight to column flanges. Lath tied with doubled 0.049" (No. 18 B.W. gage) wire ties spaced 23" on center and scratch coat wrapped with 1" hexagonal mesh 0.035" (No. 20 B.W. gage) wire fabric. For three-coat work, the plaster mix for the second coat shall not exceed 100 pounds of gypsum to 2 1/2 cubic feet of aggregate.	—	2	—	—
1. Steel columns and all of primary trusses	1-7.1	Multiple layers of 1/2" gypsum wallboard ^c adhesively ^d secured to column flanges and successive layers. Wallboard applied without horizontal joints. Corner edges of each layer staggered. Wallboard layer below outer layer secured to column with doubled 0.049" (No. 18 B.W. gage) steel wire ties spaced 15" on center. Exposed corners taped and treated.	—	—	2	1
	1-7.2	Three layers of 5/8" Type X gypsum wallboard. ^c First and second layer held in place by 1/8" diameter by 1 3/8" long ring shank nails with 5/16" diameter heads spaced 24" on center at corners. Middle layer also secured with metal straps at mid-height and 18" from each end, and by metal corner bead at each corner held by the metal straps. Third layer attached to corner bead with 1" long gypsum wallboard screws spaced 12" on center.	—	—	1 7/8	—
	1-7.3	Three layers of 5/8" Type X gypsum wallboard, ^c each layer screw attached to 1 5/8" steel studs 0.018" thick (No. 25 carbon sheet steel gage) at each corner of column. Middle layer also secured with 0.049" (No. 18 B.W. gage) double-strand steel wire ties, 24" on center. Screws are No. 6 by 1" spaced 24" on center for inner layer, No. 6 by 1 5/8" spaced 12" on center for middle layer and No. 8 by 2 1/4" spaced 12" on center for outer layer.	—	1 7/8	—	—
1. Steel columns and all of primary trusses	1-8.1	Wood-fibered gypsum plaster mixed 1:1 by weight gypsum-to-sand aggregate applied over metal lath. Lath lapped 1" and tied 6" on center at all end, edges and spacers with 0.049" (No. 18 B.W. gage) steel tie wires. Lath applied over 1/2" spacers made of 3/4" furring channel with 2" legs bent around each corner. Spacers located 1" from top and bottom of member and a maximum of 40" on center and wire tied with a single strand of 0.049" (No. 18 B.W. gage) steel tie wires. Corner bead tied to the lath at 6" on center along each corner to provide plaster thickness.	—	—	1 5/8	—

TABLE [720.1(1)] 721.1(1)
MINIMUM PROTECTION OF STRUCTURAL PARTS BASED ON TIME PERIODS
FOR VARIOUS NONCOMBUSTIBLE INSULATING MATERIALS^m

STRUCTURAL PARTS TO BE PROTECTED	ITEM NUMBER	INSULATING MATERIAL USED	MINIMUM THICKNESS OF INSULATING MATERIAL FOR THE FOLLOWING FIRE-RESISTANCE PERIODS (inches)			
			4 [hour] hours	3 [hour] hours	2 [hour] hours	1 hour
1. Steel columns and all of primary trusses	1-9.1	Minimum W 8×35 wide flange steel column (w/d ≥ 0.75) with each web cavity filled even with the flange tip with normal weight carbonate or siliceous aggregate concrete (3,000 psi minimum compressive strength with 145 pcf ± 3 pcf unit weight). Reinforce the concrete in each web cavity with a minimum No. 4 deformed reinforcing bar installed vertically and centered in the cavity, and secured to the column web with a minimum No. 2 horizontal deformed reinforcing bar welded to the web every 18" on center vertically. As an alternative to the No. 4 rebar, ¾" diameter by 3" long headed studs, spaced at 12" on center vertically, shall be welded on each side of the web midway between the column flanges.	—	—	—	See Note n
2. Webs or flanges of steel beams and girders	2-1.1	Carbonate, lightweight and sand-lightweight aggregate concrete (not including sandstone, granite and siliceous gravel) with 3" or finer metal mesh placed 1" from the finished surface anchored to the top flange and providing not less than 0.025 square inch of steel area per foot in each direction.	2	1½	1	1
2. Webs or flanges of steel beams and girders	2-1.2	Siliceous aggregate concrete and concrete excluded in Item 2-1.1 with 3" or finer metal mesh placed 1" from the finished surface anchored to the top flange and providing not less than 0.025 square inch of steel area per foot in each direction.	2½	2	1½	1
2. Webs or flanges of steel beams and girders	2-2.1	Cement plaster on metal lath attached to ¾" cold-rolled channels with [0.049] 0.04" (No. 18 B.W. gage) wire ties spaced 3" to 6" on center. Plaster mixed 1:2½ by volume, cement to sand.	—	—	2½ ^b	7/8
2. Webs or flanges of steel beams and girders	2-3.1	Vermiculite gypsum plaster on a metal lath cage, wire tied to 0.165" diameter (No. 8 B.W. gage) steel wire hangers wrapped around beam and spaced 16" on center. Metal lath ties spaced approximately 5" on center at cage sides and bottom.	—	7/8	—	—

TABLE [720.1(1)] 721.1(1)
MINIMUM PROTECTION OF STRUCTURAL PARTS BASED ON TIME PERIODS
FOR VARIOUS NONCOMBUSTIBLE INSULATING MATERIALS^m

STRUCTURAL PARTS TO BE PROTECTED	ITEM NUMBER	INSULATING MATERIAL USED	MINIMUM THICKNESS OF INSULATING MATERIAL FOR THE FOLLOWING FIRE-RESISTANCE PERIODS (inches)			
			4 [hour] hours	3 [hour] hours	2 [hour] hours	1 hour
2. Webs or flanges of steel beams and girders	2-4.1	Two layers of ⁵ / ₈ " Type X gypsum wallboard ^c are attached to U-shaped brackets spaced 24" on center. 0.018" thick (No. 25 carbon sheet steel gage) ¹ / ₈ " deep by 1" galvanized steel runner channels are first installed parallel to and on each side of the top beam flange to provide a ¹ / ₂ " clearance to the flange. The channel runners are attached to steel deck or concrete floor construction with approved fasteners spaced 12" on center. U-shaped brackets are formed from members identical to the channel runners. At the bent portion of the U-shaped bracket, the flanges of the channel are cut out so that ¹ / ₈ " deep corner channels can be inserted without attachment parallel to each side of the lower flange. As an [alternate] <u>alternative</u> , 0.021" thick (No. 24 carbon sheet steel gage) 1" × 2" runner and corner angles [may] shall be used in lieu of channels, and the web cutouts in the U-shaped brackets [may] shall not be [omitted] <u>required</u> . Each angle is attached to the bracket with ¹ / ₂ "-long No. 8 self-drilling screws. The vertical legs of the U-shaped bracket are attached to the runners with one ¹ / ₂ " long No. 8 self-drilling screw. The completed steel framing provides a ² / ₈ " and ¹ / ₂ " space between the inner layer of wallboard and the sides and bottom of the steel beam, respectively. The inner layer of wallboard is attached to the top runners and bottom corner channels or corner angles with ¹ / ₄ "-long No. 6 self-drilling screws spaced 16" on center. The outer layer of wallboard is applied with ³ / ₄ "-long No. 6 self-drilling screws spaced 8" on center. The bottom corners are reinforced with metal corner beads.	—	—	1/4	—
2. Webs or flanges of steel beams and girders	2-4.2	Three layers of ⁵ / ₈ " Type X gypsum wallboard ^c attached to a steel suspension system as described immediately above utilizing the 0.018" thick (No. 25 carbon sheet steel gage) 1" × 2" lower corner angles. The framing is located so that a ² / ₈ " and 2" space is provided between the inner layer of wallboard and the sides and bottom of the beam, respectively. The first two layers of wallboard are attached as described immediately above. A layer of 0.035" thick (No. 20 B.W. gage) 1" hexagonal galvanized wire mesh is applied under the soffit of the middle layer and up the sides approximately 2". The mesh is held in position with the No. 6 ¹ / ₈ "-long screws installed in the vertical leg of the bottom corner angles. The outer layer of wallboard is attached with No. 6 ² / ₄ "-long screws spaced 8" on center. One screw is also installed at the mid-depth of the bracket in each layer. Bottom corners are finished as described above.	—	1 ⁷ / ₈	—	—
3. Bonded pretensioned reinforcement in prestressed concrete ^e	3-1.1	Carbonate, lightweight, sand-lightweight and siliceous ^f aggregate concrete Beams or girders Solid slabs ^h	4 ^g	3 ^g	2 ¹ / ₂	1 ¹ / ₂
				2	1 ¹ / ₂	1

TABLE [720.4(4)] 721.1(1)
MINIMUM PROTECTION OF STRUCTURAL PARTS BASED ON TIME PERIODS
FOR VARIOUS NONCOMBUSTIBLE INSULATING MATERIALS^m

STRUCTURAL PARTS TO BE PROTECTED	ITEM NUMBER	INSULATING MATERIAL USED	MINIMUM THICKNESS OF INSULATING MATERIAL FOR THE FOLLOWING FIRE-RESISTANCE PERIODS (inches)			
			4 [hour] hours	3 [hour] hours	2 [hour] hours	1 hour
4. Bonded or unbonded post-tensioned tendons in prestressed concrete ^{e,i}	4-1.1	Carbonate, lightweight, sand-lightweight and siliceous ^f aggregate concrete Unrestrained members:				
		Solid slabs ^h	—	2	1½	—
		Beams and girders ^j 8" wide greater than 12" wide	3	4½ 2½	2½ 2	1¾ 1½
4. Bonded or unbonded post-tensioned tendons in prestressed concrete ^{e,i}	4-1.2	Carbonate, lightweight, sand-lightweight and siliceous aggregate Restrained members: ^k				
		Solid slabs ^h	1¼	1	¾	
		Beams and girders ^j 8" wide greater than 12" wide	2½ 2	2 1¾	1¾ 1½	—
5. Reinforcing steel in reinforced concrete columns, beams girders and trusses	5-1.1	Carbonate, lightweight and sand-lightweight aggregate concrete, members 12" or larger, square or round. (Size limit does not apply to beams and girders monolithic with floors.)	1½	1½	1½	1½
		Siliceous aggregate concrete, members 12" or larger, square or round. (Size limit does not apply to beams and girders monolithic with floors.)	2	1½	1½	1½
6. Reinforcing steel in reinforced concrete joists ^l	6-1.1	Carbonate, lightweight and sand-lightweight aggregate concrete.	1¼	1¼	1	¾
	6-1.2	Siliceous aggregate concrete.	1¾	1½	1	¾
7. Reinforcing and tie rods in floor and roof slabs ^l	7-1.1	Carbonate, lightweight and sand-lightweight aggregate concrete.	1	1	¾	¾
	7-1.2	Siliceous aggregate concrete.	1¼	1	1	¾

For SI: 1 inch = 25.4 mm, 1 square inch = 645.2 mm², 1 cubic foot = 0.0283 m³.

- a. Reentrant parts of protected members to be filled solidly.
- b. Two layers of equal thickness with a ¾-inch airspace between.
- c. For all of the construction with gypsum wallboard described in Table [720.4(4)] 721.1(1), gypsum base for veneer plaster of the same size, thickness and core type shall be permitted to be substituted for gypsum wallboard, provided attachment is identical to that specified for the wallboard and the joints on the face layer are reinforced, and the entire surface is covered with ~~a minimum of~~ not less than 1/16-inch gypsum veneer plaster.
- d. An approved adhesive qualified under ASTM E 119 or UL 263.
- e. Where lightweight or sand-lightweight concrete having an oven-dry weight of 110 pounds per cubic foot or less is used, the tabulated minimum cover shall be permitted to be reduced 25 percent, except that in no case shall the cover be less than ¾ inch in slabs or 1½ inches in beams or girders.
- f. For solid slabs of siliceous aggregate concrete, increase tendon cover 20 percent.
- g. Adequate provisions against spalling shall be provided by U-shaped or hooped stirrups spaced not to exceed the depth of the member with a clear cover of 1 inch.
- h. Prestressed slabs shall have a thickness not less than that required in Table [720.4(3)] 721.1(3) for the respective fire resistance time period.
- i. Fire coverage and end anchorages shall be as follows: Cover to the prestressing steel at the anchor shall be ½ inch greater than that required away from the anchor. Minimum cover to steel-bearing plate shall be 1 inch in beams and ¾ inch in slabs.
- j. For beam widths between 8 inches and 12 inches, cover thickness shall be permitted to be determined by interpolation.

- k. Interior spans of continuous slabs, beams and girders shall be permitted to be considered restrained.
- l. For use with concrete slabs having a comparable fire endurance where members are framed into the structure in such a manner as to provide equivalent performance to that of monolithic concrete construction.
- m. Generic fire-resistance ratings (those not designated as PROPRIETARY* in the listing) in GA 600 shall be accepted as if herein listed.
- n. No additional insulating material is required on an-exposed outside face of the column flange to achieve a 1-hour fire-resistance rating.

TABLE [720.1(2)] 721.1(2)
RATED FIRE-RESISTANCE PERIODS FOR VARIOUS WALLS AND PARTITIONS^{A,O,P}

MATERIAL	ITEM NUMBER	CONSTRUCTION	MINIMUM FINISHED THICKNESS FACE-TO-FACE ^b (inches)			
			hour hours	hour hours	hour hours	1 hour
1. Brick of clay or shale	1-1.1	Solid brick of clay or shale ^c .	6	4.9	3.8	2.7
	1-1.2	Hollow brick, not filled.	5.0	4.3	3.4	2.3
	1-1.3	Hollow brick unit wall, grout or filled with perlite vermiculite or expanded shale aggregate.	6.6	5.5	4.4	3.0
	1-2.1	4" nominal thick units [at least] <u>not less than</u> 75 percent solid backed with a hat-shaped metal furring channel ³ / ₄ " thick formed from 0.021" sheet metal attached to the brick wall on 24" centers with approved fasteners, and ¹ / ₂ " Type X gypsum wallboard attached to the metal furring strips with 1"-long Type S screws spaced 8" on center.	—	—	5 ^d	—
2. Combination of clay brick and load-bearing hollow clay tile	2-1.1	4" solid brick and 4" tile (at least] <u>not less than</u> 40 percent solid).	—	8	—	—
	2-1.2	4" solid brick and 8" tile [at least] <u>not less than</u> 40 percent solid).	12	—	—	—
3. Concrete masonry units	3-1.1 ^{f,g}	Expanded slag or pumice.	4.7	4.0	3.2	2.1
	3-1.2 ^{f,g}	Expanded clay, shale or slate.	5.1	4.4	3.6	2.6
	3-1.3 ^f	Limestone, cinders or air-cooled slag.	5.9	5.0	4.0	2.7
	3-1.4 ^{f,g}	Calcareous or siliceous gravel.	6.2	5.3	4.2	2.8
4. Solid concrete ^{h,i}	4-1.1	Siliceous aggregate concrete.	7.0	6.2	5.0	3.5
		Carbonate aggregate concrete.	6.6	5.7	4.6	3.2
		Sand-lightweight concrete.	5.4	4.6	3.8	2.7
		Lightweight concrete.	5.1	4.4	3.6	2.5
5. Glazed or unglazed facing tile, nonload-bearing	5-1.1	One 2" unit cored 15 percent maximum and one 4" unit cored 25 percent maximum with ³ / ₄ " mortar-filled collar joint. Unit positions reversed in alternate courses.	—	6 ³ / ₈	—	—
5. Glazed or unglazed facing tile, nonload-bearing	5-1.2	One 2" unit cored 15 percent maximum and one 4" unit cored 40 percent maximum with ³ / ₄ " mortar-filled collar joint. Unit positions side with ³ / ₄ " gypsum plaster. Two wythes tied together every fourth course with No. 22 gage corrugated metal ties.	—	[6 ³ / ₈] 6 ³ / ₄	—	—

**TABLE [720.1(2)] 721.1(2)
RATED FIRE-RESISTANCE PERIODS FOR VARIOUS WALLS AND PARTITIONS^{A,O,P}**

MATERIAL	ITEM NUMBER	CONSTRUCTION	MINIMUM FINISHED THICKNESS FACE-TO-FACE ^b (inches)			
			4 [hour] hours	3 [hour] hours	2 [hour] hours	1 hour
5. Glazed or unglazed facing tile, nonload-bearing	5-1.3	One unit with three cells in wall thickness, cored 29 percent maximum.	—	—	6	—
5. Glazed or unglazed facing tile, nonload-bearing	5-1.4	One 2" unit cored 22 percent maximum and one 4" unit cored 41 percent maximum with 1/4" mortar-filled collar joint. Two wythes tied together every third course with 0.030" (No. 22 galvanized sheet steel gage) corrugated metal ties.	—	—	6	—
5. Glazed or unglazed facing tile, nonload-bearing	5-1.5	One 4" unit cored 25 percent maximum with 3/4" gypsum plaster on one side.	—	—	4 ^{3/4}	—
5. Glazed or unglazed facing tile, nonload-bearing	5-1.6	One 4" unit with two cells in wall thickness, cored 22 percent maximum.	—	—	—	4
5. Glazed or unglazed facing tile, nonload-bearing	5-1.7	One 4" unit cored 30 percent maximum with 3/4" vermiculite gypsum plaster on one side.	—	—	4 ^{1/2}	—
5. Glazed or unglazed facing tile, nonload-bearing	5-1.8	One 4" unit cored 39 percent maximum with 3/4" gypsum plaster on one side.	—	—	—	4 ^{1/2}
6. Solid gypsum plaster	6-1.1	3/4" by 0.055" (No. 16 carbon sheet steel gage) vertical cold-rolled channels, 16" on center with 2.6-pound flat metal lath applied to one face and tied with 0.049" (No. 18 B.W. [Gage] gage) wire at 6" spacing. Gypsum plaster each side mixed 1:2 by weight, gypsum to sand aggregate.	—	—	—	2 ^d
6. Solid gypsum plaster	6-1.2	3/4" by 0.055" (No. 16 carbon sheet steel gage) cold-rolled channels 16" on center with metal lath applied to one face and tied with 0.049" (No. 18 B.W. gage) wire at 6" spacing. Perlite or vermiculite gypsum plaster each side. For three-coat work, the plaster mix for the second coat shall not exceed 100 pounds of gypsum to 2 ^{1/2} cubic feet of aggregate for the 1-hour system.	—	—	2 ^{1/2} ^d	2 ^d
6. Solid gypsum plaster	6-1.3	3/4" by 0.055" (No. 16 carbon sheet steel gage) vertical cold-rolled channels, 16" on center with 3/8" gypsum lath applied to one face and attached with sheet metal clips. Gypsum plaster each side mixed 1:2 by weight, gypsum to sand aggregate.	—	—	—	2 ^d

TABLE [720.1(2)] 721.1(2)
RATED FIRE-RESISTANCE PERIODS FOR VARIOUS WALLS AND PARTITIONS^{A,O,P}

MATERIAL	ITEM NUMBER	CONSTRUCTION	MINIMUM FINISHED THICKNESS FACE-TO-FACE ^b (inches)			
			4 hours	3 hours	2 hours	1 hour
6. Solid gypsum plaster	6-2.1	Studless with 1/2" full-length plain gypsum lath and gypsum plaster each side. Plaster mixed 1:1 for scratch coat and 1:2 for brown coat, by weight, gypsum to sand aggregate.	—	—	—	2 ^d
6. Solid gypsum plaster	6-2.2	Studless with 1/2" full-length plain gypsum lath and perlite or vermiculite gypsum plaster each side.	—	—	2 1/2 ^d	2 ^d
6. Solid gypsum plaster	6-2.3	Studless partition with 3/8" rib metal lath installed vertically adjacent edges tied 6" on center with No. 18 gage wire ties, gypsum plaster each side mixed 1:2 by weight, gypsum to sand aggregate.	—	—	—	2 ^d
7. Solid perlite and portland cement	7-1.1	Perlite mixed in the ratio of 3 cubic feet to 100 pounds of portland cement and machine applied to stud side of 1 1/2" mesh by 0.058-inch (No. 17 B.W. gage) paper-backed woven wire fabric lath wired to 4"-deep steel trussed wire ^j studs 16" on center. Wire ties of 0.049" (No. 18 B.W. gage) galvanized steel wire 6" on center vertically.	—	—	3 1/8 ^d	—
8. Solid neat wood fibered gypsum plaster	8-1.1	3/4" by 0.055-inch (No. 16 carbon sheet steel gage) cold-rolled channels, 12" on center with 2.5-pound flat metal lath applied to one face and tied with 0.049" (No. 18 B.W. gage) wire at 6" spacing. Neat gypsum plaster applied each side.	—	—	2 ^d	—
9. Solid wallboard partition	9-1.1	One full-length layer 1/2" Type X gypsum wallboard ^e laminated to each side of 1" full-length V-edge gypsum coreboard with approved laminating compound. Vertical joints of face layer and coreboard staggered [at least] <u>not less than 3"</u> .	—	—	2 ^d	—
10. Hollow (studless) gypsum wallboard partition	10-1.1	One full-length layer of 5/8" Type X gypsum wallboard ^e attached to both sides of wood or metal top and bottom runners laminated to each side of 1" x 6" full-length gypsum coreboard ribs spaced 24" on center with approved laminating compound. Ribs centered at vertical joints of face plies and joints staggered 24" in opposing faces. Ribs may be recessed 6" from the top and bottom.	—	—	—	2 1/4 ^d

TABLE [720.1(2)] 721.1(2)
RATED FIRE-RESISTANCE PERIODS FOR VARIOUS WALLS AND PARTITIONS^{A,O,P}

MATERIAL	ITEM NUMBER	CONSTRUCTION	MINIMUM FINISHED THICKNESS FACE-TO-FACE ^b (inches)			
			hour 4 hours	hour 3 hours	hour 2 hours	1 hour
	10-1.2	1" regular gypsum V-edge full-length backing board attached to both sides of wood or metal top and bottom runners with nails or 1 ⁵ / ₈ " drywall screws at 24" on center. Minimum width of runners 1 ⁵ / ₈ ". Face layer of 1/2" regular full-length gypsum wallboard laminated to outer faces of backing board with approved laminating compound.	—	—	4 ⁵ / ₈ ^d	—
11. Noncombustible studs—interior partition with plaster each side	11-1.1	3 ¹ / ₄ " × 0.044" (No. 18 carbon sheet steel gage) steel studs spaced 24" on center. ⁵ / ₈ " gypsum plaster on metal lath each side mixed 1:2 by weight, gypsum to sand aggregate.	—	—	—	4 ³ / ₄ ^d
11. Noncombustible studs—interior partition with plaster each side	11-1.2	3 ³ / ₈ " × 0.055" (No. 16 carbon sheet steel gage) approved nailable ^k studs spaced 24" on center. ⁵ / ₈ " neat gypsum wood-fibered plaster each side over ³ / ₈ " rib metal lath nailed to studs with 6d common nails, 8" on center. Nails driven 1 ¹ / ₄ " and bent over.	—	—	5 ⁵ / ₈	—
11. Noncombustible studs—interior partition with plaster each side	11-1.3	4" × 0.044" (No. 18 carbon sheet steel gage) channel-shaped steel studs at 16" on center. On each side approved resilient clips pressed onto stud flange at 16" vertical spacing, 1/4" pencil rods snapped into or wire tied onto outer loop of clips, metal lath wire-tied to pencil rods at 6" intervals, 1" perlite gypsum plaster, each side.	—	7 ⁵ / ₈ ^d	—	—
11. Noncombustible studs—interior partition with plaster each side	11-1.4	2 ¹ / ₂ " × 0.044" (No. 18 carbon sheet steel gage) steel studs spaced 16" on center. Wood fibered gypsum plaster mixed 1:1 by weight gypsum to sand aggregate applied on ³ / ₄ -pound metal lath wire tied to studs, each side. ³ / ₄ " plaster applied over each face, including finish coat.	—	—	4 ¹ / ₄ ^d	—
12. Wood studs interior partition with plaster each side	12-1.1 ^{lm}	2" × 4" wood studs 16" on center with ⁵ / ₈ " gypsum plaster on metal lath. Lath attached by 4d common nails bent over or No. 14 gage by 1 ¹ / ₄ " by ³ / ₄ " crown width staples spaced 6" on center. Plaster mixed 1:1 ¹ / ₂ for scratch coat and 1:3 for brown coat, by weight, gypsum to sand aggregate.	—	—	—	5 ¹ / ₈
12. Wood studs interior partition with plaster each side	12-1.2 ^l	2" × 4" wood studs 16" on center with metal lath and ⁷ / ₈ " neat wood-fibered gypsum plaster each side. Lath attached by 6d common nails, 7" on center. Nails driven 1 ¹ / ₄ " and bent over.	—	—	5 ¹ / ₂ ^d	—

TABLE [720.1(2)] 721.1(2)
RATED FIRE-RESISTANCE PERIODS FOR VARIOUS WALLS AND PARTITIONS^{A,O,P}

MATERIAL	ITEM NUMBER	CONSTRUCTION	MINIMUM FINISHED THICKNESS FACE-TO-FACE ^b (inches)			
			4 hours	3 hours	2 hours	1 hour
12. Wood studs interior partition with plaster each side	12-1.3 ¹	2" × 4" wood studs 16" on center with ³ / ₈ " perforated or plain gypsum lath and 1/2" gypsum plaster each side. Lath nailed with 1 ¹ / ₈ " by No. 13 gage by ¹⁹ / ₆₄ " head plasterboard blued nails, 4" on center. Plaster mixed 1:2 by weight, gypsum to sand aggregate.	—	—	—	5 ¹ / ₄
12. Wood studs interior partition with plaster each side	12-1.4 ¹	2" × 4" wood studs 16" on center with ³ / ₈ " Type X gypsum lath and 1/2" gypsum plaster each side. Lath nailed with 1 ¹ / ₈ " by No. 13 gage by ¹⁹ / ₆₄ " head plasterboard blued nails, 5" on center. Plaster mixed 1:2 by weight, gypsum to sand aggregate.	—	—	—	5 ¹ / ₄
13. Noncombustible <u>Noncombustible</u> studs—interior partition with gypsum wallboard each side	13-1.1	0.018" (No. 25 carbon sheet steel gage) channel-shaped studs 24" on center with one full-length layer of ⁵ / ₈ " Type X gypsum wallboard ^c applied vertically attached with 1" long No. 6 drywall screws to each stud. Screws are 8" on center around the perimeter and 12" on center on the intermediate stud. [The wallboard may be <u>Where applied horizontally [when], the Type X gypsum wallboard shall be</u> attached to ³ / ₈ " studs and the horizontal joints [are <u>shall be</u> staggered with those on the opposite side. Screws for the horizontal application shall be 8" on center at vertical edges and 12" on center at intermediate studs.	—	—	—	2 ⁷ / ₈ ^d
13. Noncombustible <u>Noncombustible</u> studs—interior partition with gypsum wallboard each side	13-1.2	0.018" (No. 25 carbon sheet steel gage) channel-shaped studs 25" on center with two full-length layers of 1/2" Type X gypsum wallboard ^c applied vertically each side. First layer attached with 1"-long, No. 6 drywall screws, 8" on center around the perimeter and 12" on center on the intermediate stud. Second layer applied with vertical joints offset one stud space from first layer using 1 ⁵ / ₈ " long, No. 6 drywall screws spaced 9" on center along vertical joints, 12" on center at intermediate studs and 24" on center along top and bottom runners.	—	—	3 ⁵ / ₈ ^d	—
13. Noncombustible <u>Noncombustible</u> studs—interior partition with gypsum wallboard each side	13-1.3	0.055" (No. 16 carbon sheet steel gage) approved nailable metal studs ^c 24" on center with full-length ⁵ / ₈ " Type X gypsum wallboard ^c applied vertically and nailed 7" on center with 6d cement-coated common nails. Approved metal fastener grips used with nails at vertical butt joints along studs.	—	—	—	4 ⁷ / ₈

TABLE [720.1(2)] 721.1(2)
RATED FIRE-RESISTANCE PERIODS FOR VARIOUS WALLS AND PARTITIONS^{A,O,P}

MATERIAL	ITEM NUMBER	CONSTRUCTION	MINIMUM FINISHED THICKNESS FACE-TO-FACE ^b (inches)			
			4 [hour] hours	3 [hour] hours	2 [hour] hours	1 hour
14.Wood studs— interior partition with gypsum wallboard each side	14-1.1 ^{h,m}	2" × 4" wood studs 16" on center with two layers of 3/8" regular gypsum wallboard ^c each side, 4d cooler ⁿ or wallboard ⁿ nails at 8" on center first layer, 5d cooler ⁿ or wallboard ⁿ nails at 8" on center second layer with laminating compound between layers, joints staggered. First layer applied full length vertically, second layer applied horizontally or vertically.	—	—	—	5
14.Wood studs— interior partition with gypsum wallboard each side	14-1.2 ^{l,m}	2" × 4" wood studs 16" on center with two layers 1/2" regular gypsum wallboard ^c applied vertically or horizontally each side ^k , joints staggered. Nail base layer with 5d cooler ⁿ or wallboard ⁿ nails at 8" on center face layer with 8d cooler ⁿ or wallboard ⁿ nails at 8" on center.	—	—	—	5 ^{1/2}
14.Wood studs— interior partition with gypsum wallboard each side	14-1.3 ^{l,m}	2" × 4" wood studs 24" on center with 5/8" Type X gypsum wallboard ^c applied vertically or horizontally nailed with 6d cooler ⁿ or wallboard ⁿ nails at 7" on center with end joints on nailing members. Stagger joints each side.	—	—	—	4 ^{3/4}
14.Wood studs— interior partition with gypsum wallboard each side	14-1.4 ^l	2" × 4" fire-retardant-treated wood studs spaced 24" on center with one layer of 5/8" Type X gypsum wallboard ^c applied with face paper grain (long dimension) parallel to studs. Wallboard attached with 6d cooler ⁿ or wallboard ⁿ nails at 7" on center.	—	—	—	4 ^{3/4} ^d
14.Wood studs— interior partition with gypsum wallboard each side	14-1.5 ^{l,m}	2" × 4" wood studs 16" on center with two layers 5/8" Type X gypsum wallboard ^c each side. Base layers applied vertically and nailed with 6d cooler ⁿ or wallboard ⁿ nails at 9" on center. Face layer applied vertically or horizontally and nailed with 8d cooler ⁿ or wallboard ⁿ nails at 7" on center. For nail-adhesive application, base layers are nailed 6" on center. Face layers applied with coating of approved wallboard adhesive and nailed 12" on center.	—	—	6	—
14.Wood studs— interior partition with gypsum wallboard each side	14-1.6 ^l	2" × 3" fire-retardant-treated wood studs spaced 24" on center with one layer of 5/8" Type X gypsum wallboard ^c applied with face paper grain (long dimension) at right angles to studs. Wallboard attached with 6d cement-coated box nails spaced 7" on center.	—	—	—	3 ^{5/8} ^d

TABLE [720.1(2)] 721.1(2)
RATED FIRE-RESISTANCE PERIODS FOR VARIOUS WALLS AND PARTITIONS^{A,O,P}

MATERIAL	ITEM NUMBER	CONSTRUCTION	MINIMUM FINISHED THICKNESS FACE-TO-FACE ^b (inches)			
			4 [hour] hours	3 [hour] hours	2 [hour] hours	1 hour
15. Exterior or interior walls	15-1.1 ^{1,m}	Exterior surface with 3/4" drop siding over 1/2" gypsum sheathing on 2" x 4" wood studs at 16" on center, interior surface treatment as required for 1-hour-rated exterior or interior 2" x 4" wood stud partitions. Gypsum sheathing nailed with 1 3/4" by No. 11 gage by 7/16" head galvanized nails at 8" on center. Siding nailed with 7d galvanized smooth box nails.	—	—	—	Varies
15. Exterior or interior walls	15-1.2 ^{1,m}	2" x 4" wood studs 16" on center with metal lath and 3/4" cement plaster on each side. Lath attached with 6d common nails 7" on center driven to 1" minimum penetration and bent over. Plaster mix 1:4 for scratch coat and 1:5 for brown coat, by volume, cement to sand.	—	—	—	5 3/8
15. Exterior or interior walls	15-1.3 ^{1,m}	2" x 4" wood studs 16" on center with 7/8" cement plaster (measured from the face of studs) on the exterior surface with interior surface treatment as required for interior wood stud partitions in this table. Plaster mix 1:4 for scratch coat and 1:5 for brown coat, by volume, cement to sand.	—	—	—	Varies
15. Exterior or interior walls	15-1.4	3 5/8" No. 16 gage noncombustible studs 16" on center with 7/8" cement plaster (measured from the face of the studs) on the exterior surface with interior surface treatment as required for interior, nonbearing, noncombustible stud partitions in this table. Plaster mix 1:4 for scratch coat and 1:5 for brown coat, by volume, cement to sand.	—	—	—	Varies ^d

TABLE [720.1(2)] 721.1(2)
RATED FIRE-RESISTANCE PERIODS FOR VARIOUS WALLS AND PARTITIONS^{A,O,P}

MATERIAL	ITEM NUMBER	CONSTRUCTION	MINIMUM FINISHED THICKNESS FACE-TO-FACE ^b (inches)			
			4 [hour] hours	3 [hour] hours	2 [hour] hours	1 hour
15. Exterior or interior walls	15-1.5 ^m	[2⁵/₈] 2 ¹ / ₄ " × 3 ³ / ₄ " clay face brick with cored holes over 1/2" gypsum sheathing on exterior surface of 2" × 4" wood studs at 16" on center and two layers 5/8" Type X gypsum wallboard ^c on interior surface. Sheathing placed horizontally or vertically with vertical joints over studs nailed 6" on center with 1 ³ / ₄ " × No. 11 gage by 7/16" head galvanized nails. Inner layer of wallboard placed horizontally or vertically and nailed 8" on center with 6d cooler ⁿ or wallboard ⁿ nails. Outer layer of wallboard placed horizontally or vertically and nailed 8" on center with 8d cooler ⁿ or wallboard ⁿ nails. [All joints] Joints staggered with vertical joints over studs. Outer layer joints taped and finished with compound. Nail heads covered with joint compound. 0.035 inch (No. 20 galvanized sheet gage) corrugated galvanized steel wall ties 3/4" by 6 ⁵ / ₈ " attached to each stud with two 8d cooler ⁿ or wallboard ⁿ nails every sixth course of bricks.	—	—	10	—
15. Exterior or interior walls	15-1.6 ^m	2" × 6" fire-retardant-treated wood studs 16" on center. Interior face has two layers of 5/8" Type X gypsum with the base layer placed vertically and attached with 6d box nails 12" on center. The face layer is placed horizontally and attached with 8d box nails 8" on center at joints and 12" on center elsewhere. The exterior face has a base layer of 5/8" Type X gypsum sheathing placed vertically with 6d box nails 8" on center at joints and 12" on center elsewhere. An approved building paper is next applied, followed by self-furred exterior lath attached with 2 ¹ / ₂ ", No. 12 gage galvanized roofing nails with a 3/8" diameter head and spaced 6" on center along each stud. Cement plaster consisting of a 1/2" brown coat is then applied. The scratch coat is mixed in the proportion of 1:3 by weight, cement to sand with 10 pounds of hydrated lime and 3 pounds of approved additives or admixtures per sack of cement. The brown coat is mixed in the proportion of 1:4 by weight, cement to sand with the same amounts of hydrated lime and approved additives or admixtures used in the scratch coat.	—	—	8 ¹ / ₄	—

TABLE [720.1(2)] 721.1(2)
RATED FIRE-RESISTANCE PERIODS FOR VARIOUS WALLS AND PARTITIONS^{A,O,P}

MATERIAL	ITEM NUMBER	CONSTRUCTION	MINIMUM FINISHED THICKNESS FACE-TO-FACE ^b (inches)			
			4 [hour] hours	3 [hour] hours	2 [hour] hours	1 hour
15. Exterior or interior walls	15-1.7 ^{l, m}	2" × 6" wood studs 16" on center. The exterior face has a layer of 5/8" Type X gypsum sheathing placed vertically with 6d box nails 8" on center at joints and 12" on center elsewhere. An approved building paper is next applied, followed by 1" by No. 18 gage self-furred exterior lath attached with 8d by 2 1/2" long galvanized roofing nails spaced 6" on center along each stud. Cement plaster consisting of a 1/2" scratch coat, a bonding agent and a 1/2" brown coat and a finish coat is then applied. The scratch coat is mixed in the proportion of 1:3 by weight, cement to sand with 10 pounds of hydrated lime and 3 pounds of approved additives or admixtures per sack of cement. The brown coat is mixed in the proportion of 1:4 by weight, cement to sand with the same amounts of hydrated lime and approved additives or admixtures used in the scratch coat. The interior is covered with 3/8" gypsum lath with 1" hexagonal mesh of 0.035 inch (No. 20 B.W. gage) woven wire lath furred out 5/16" and 1" perlite or vermiculite gypsum plaster. Lath nailed with 1 1/8" by No. 13 gage by 19/64" head plasterboard glued nails spaced 5" on center. Mesh attached by 1 3/4" by No. 12 gage by 3/8" head nails with 3/8" furrings, spaced 8" on center. The plaster mix shall not exceed 100 pounds of gypsum to 2 1/2 cubic feet of aggregate.	—	—	8 3/8	—

TABLE [720.1(2)] 721.1(2)
RATED FIRE-RESISTANCE PERIODS FOR VARIOUS WALLS AND PARTITIONS^{A,O,P}

MATERIAL	ITEM NUMBER	CONSTRUCTION	MINIMUM FINISHED THICKNESS FACE-TO-FACE ^b (inches)			
			4 [hour] hours	3 [hour] hours	2 [hour] hours	1 hour
15. Exterior or interior walls	15-1.8 ^{l,m}	2" × 6" wood studs 16" on center. The exterior face has a layer of 5/8" Type X gypsum sheathing placed vertically with 6d box nails 8" on center at joints and 12" on center elsewhere. An approved building paper is next applied, followed by 1 1/2" by No. 17 gage self-furred exterior lath attached with 8d by 2 1/2" long galvanized roofing nails spaced 6" on center along each stud. Cement plaster consisting of a 1/2" scratch coat, and a 1/2" brown coat is then applied. The plaster may be placed by machine. The scratch coat is mixed in the proportion of 1:4 by weight, plastic cement to sand. The brown coat is mixed in the proportion of 1:5 by weight, plastic cement to sand. The interior is covered with 3/8" gypsum lath with 1" hexagonal mesh of No. 20 gage woven wire lath furred out 5/16" and 1" perlite or vermiculite gypsum plaster. Lath nailed with 1 1/8" by No. 13 gage by 19/64" head plasterboard glued nails spaced 5" on center. Mesh attached by 1 3/4" by No. 12 gage by 3/8" head nails with 3/8" furrings, spaced 8" on center. The plaster mix shall not exceed 100 pounds of gypsum to 2 1/2 cubic feet of aggregate.	—	—	8 3/8	—
15. Exterior or interior walls	15-1.9	4" No. 18 gage, nonload-bearing metal studs, 16" on center, with 1" portland cement lime plaster (measured from the back side of the 3/4-pound expanded metal lath) on the exterior surface. Interior surface to be covered with 1" of gypsum plaster on 3/4-pound expanded metal lath proportioned by weight—1:2 for scratch coat, 1:3 for brown, gypsum to sand. Lath on one side of the partition fastened to 1/4" diameter pencil rods supported by No. 20 gage metal clips, located [46 ²] 16" on center vertically, on each stud. 3" thick mineral fiber insulating batts friction fitted between the studs.	—	—	6 1/2 ^d	—

TABLE [720.1(2)] 721.1(2)
RATED FIRE-RESISTANCE PERIODS FOR VARIOUS WALLS AND PARTITIONS^{A,O,P}

MATERIAL	ITEM NUMBER	CONSTRUCTION	MINIMUM FINISHED THICKNESS FACE-TO-FACE ^b (inches)			
			hour 4 hours	hour 3 hours	hour 2 hours	1 hour
15. Exterior or interior walls	15-1.10	Steel studs 0.060 0.060" thick, 4" deep or 6' at 16" or 24" centers, with 1/2" Glass Fiber Reinforced Concrete (GFRC) on the exterior surface. GFRC is attached with flex anchors at 24" on center, with 5" leg welded to studs with two 1/2"-long flare-bevel welds, and 4" foot attached to the GFRC skin with 5/8" thick GFRC bonding pads that extend 2 1/2" beyond the flex anchor foot on both sides. Interior surface to have two layers of 1/2" Type X gypsum wallboard. ^c The first layer of wallboard to be attached with 1"-long Type S buglehead screws spaced 24" on center and the second layer is attached with 1 5/8"-long Type S screws spaced at 12" on center. Cavity is to be filled with 5" of 4 pcf (nominal) mineral fiber batts. GFRC has 1 1/2" returns packed with mineral fiber and caulked on the exterior.	—	—	6 1/2	—
15. Exterior or interior walls	15-1.11	Steel studs 0.060" thick, 4" deep or 6" at 16" or 24" centers, respectively, with 1/2" Glass Fiber Reinforced Concrete (GFRC) on the exterior surface. GFRC is attached with flex anchors at 24" on center, with 5" leg welded to studs with two 1/2"-long flare-bevel welds, and 4" foot attached to the GFRC skin with 5/8"-thick GFRC bonding pads that extend 2 1/2" beyond the flex anchor foot on both sides. Interior surface to have one layer of 5/8" Type X gypsum wallboard ^c , attached with 1 1/4"-long Type S buglehead screws spaced 12" on center. Cavity is to be filled with 5" of 4 pcf (nominal) mineral fiber batts. GFRC has 1 1/2" returns packed with mineral fiber and caulked on the exterior.	—	—	—	6 1/8
15. Exterior or interior walls	15-1.12 ^a	2" x 6" wood studs at 16" with double top plates, single bottom plate; interior and exterior sides covered with 5/8" Type X gypsum wallboard, 4' wide, applied horizontally or vertically with vertical joints over studs, and fastened with 2 1/4" Type S drywall screws, spaced 12" on center. Cavity to be filled with 5 1/2" mineral wool insulation.	—	—	—	6 3/4

TABLE [720.1(2)] 721.1(2)
RATED FIRE-RESISTANCE PERIODS FOR VARIOUS WALLS AND PARTITIONS^{A,O,P}

MATERIAL	ITEM NUMBER	CONSTRUCTION	MINIMUM FINISHED THICKNESS FACE-TO-FACE ^b (inches)			
			hour hours	hour hours	hour hours	hour
15. Exterior or interior walls	15-1.13 ^q	2" x 6" wood studs at 16" with double top plates, single bottom plate; interior and exterior sides covered with 5/8" Type X gypsum wallboard, 4' wide, applied vertically with all joints over framing or blocking, and fastened with 2 1/4" Type S drywall screws, spaced 12" on center. R-19 fiberglass <u>mineral fiber</u> insulation installed in stud cavity.	—	—	—	6 ³ / ₄
15. Exterior or interior walls	15-1.14 ^q	2" x 6" wood studs at 16" with double top plates, single bottom plate; interior and exterior sides covered with 5/8" Type X gypsum wallboard, 4' wide, applied horizontally or vertically with vertical joints over studs, and fastened with 2 1/4" Type S drywall screws, spaced 7" on center.	—	—	—	6 ³ / ₄
15. Exterior or interior walls	15-1.15 ^q	2" x 4" wood studs at 16" with double top plates, single bottom plate; interior and exterior sides covered with 5/8" Type X gypsum wallboard and sheathing, respectively, 4' wide, applied horizontally or vertically with vertical joints over studs, and fastened with 2 1/4" Type S drywall screws, spaced 12" on center. Cavity to be filled with 3 1/2" mineral wool insulation.	—	—	—	4 ³ / ₄
15. Exterior or interior walls	15-1.16 ^q	2" x 6" wood studs at 24" centers with double top plates, single bottom plate; interior and exterior side covered with two layers of 5/8" Type X gypsum wallboard, 4' wide, applied horizontally with vertical joints over studs. Base layer fastened with 2 1/4" Type S drywall screws, spaced 24" on center, and face layer fastened with Type S drywall screws, spaced 8" on center, wallboard joints covered with paper tape and joint compound, fastened <u>fastener</u> heads covered with joint compound. Cavity to be filled with 5 1/2" mineral wool insulation.	—	—	7 ³ / ₄	—

TABLE [720.1(2)] 721.1(2)
RATED FIRE-RESISTANCE PERIODS FOR VARIOUS WALLS AND PARTITIONS^{A,O,P}

MATERIAL	ITEM NUMBER	CONSTRUCTION	MINIMUM FINISHED THICKNESS FACE-TO-FACE ^b (inches)			
			hour hours	hour hours	hour hours	1 hour
15. Exterior or interior walls	15-2.1 ^d	3 ⁵ / ₈ " No. 16 gage steel studs at 24" on center or 2" x 4" wood studs at 24" on center. Metal lath attached to the exterior side of studs with minimum 1" long No. 6 drywall screws at 6" on center and covered with minimum 3/4" thick portland cement plaster. Thin veneer brick units of clay or shale complying with ASTM C 1088, Grade TBS or better, installed in running bond in accordance with Section 1405.10. Combined total thickness of the portland cement plaster, mortar and thin veneer brick units shall be not less than 1 3/4". Interior side covered with one layer of 5/8" thick Type X gypsum wallboard attached to studs with 1" long No. 6 drywall screws at 12" on center.	—	—	—	6
15. Exterior or interior walls	15-2.2 ^d	3 ⁵ / ₈ " No. 16 gage steel studs at 24" on center or 2" x 4" wood studs at 24" on center. Metal lath attached to the exterior side of studs with minimum 1" long No. 6 drywall screws at 6" on center and covered with minimum 3/4" thick portland cement plaster. Thin veneer brick units of clay or shale complying with ASTM C 1088, Grade TBS or better, installed in running bond in accordance with Section 1405.10. Combined total thickness of the portland cement plaster, mortar and thin veneer brick units shall be not less than 2". Interior side covered with two layers of 5/8" thick Type X gypsum wallboard. Bottom layer attached to studs with 1" long No. 6 drywall screws at 24" on center. Top layer attached to studs with 1 5/8" long No. 6 drywall screws at 12" on center.	—	—	6 ⁷ / ₈	—
15. Exterior or interior walls	15-2.3 ^d	3 ⁵ / ₈ " No. 16 gage steel studs at 16" on center or 2" x 4" wood studs at 16" on center. Where metal lath is used, attached <u>attach</u> to the exterior side of studs with minimum 1" long No. 6 drywall screws at 6" on center. Brick units of clay or shale not less than 2 5/8" thick complying with ASTM C 216 installed in accordance with Section 1405.6 with a minimum 1" air-space <u>airspace</u> . Interior side covered with one layer of 5/8" thick Type X gypsum wallboard attached to studs with 1" long No. 6 drywall screws at 12" on center.	—	—	—	7 ⁷ / ₈

TABLE [720.1(2)] 721.1(2)
RATED FIRE-RESISTANCE PERIODS FOR VARIOUS WALLS AND PARTITIONS^{A,O,P}

MATERIAL	ITEM NUMBER	CONSTRUCTION	MINIMUM FINISHED THICKNESS FACE-TO-FACE ^b (inches)			
			4 [hour] hours	3 [hour] hours	2 [hour] hours	1 hour
15. Exterior or interior walls	15-2.4 ^d	3 ⁵ / ₈ " No. 16 gage steel studs at 16" on center or 2" x 4" wood studs at 16" on center. Where metal lath is used, [attached] <u>attach</u> to the exterior side of studs with minimum 1" long No. 6 drywall screws at 6" on center. Brick units of clay or shale not less than 2 ⁵ / ₈ " thick complying with ASTM C 216 installed in accordance with Section 1405.6 with a minimum 1" [air space] <u>airspace</u> . Interior side covered with two layers of ⁵ / ₈ " thick Type X gypsum wallboard. Bottom layer attached to studs with 1" long No. 6 drywall screws at 24" on center. Top layer attached to studs with 1 ⁵ / ₈ " long No. 6 drywall screws at 12" on center.	—	—	8 ¹ / ₂	—
16. Exterior walls rated for fire resistance from the inside only in accordance with Section [704.5] <u>705.5</u> .	16-1.1 ^q	2" x 4" wood studs at 16" centers with double top plates, single bottom plate; interior side covered with ⁵ / ₈ " Type X gypsum wallboard, 4' wide, applied horizontally unblocked, and fastened with 2 ¹ / ₄ " Type S drywall screws, spaced 12" on center, wallboard joints covered with paper tape and joint compound, fastener heads covered with joint compound. Exterior covered with ³ / ₈ " wood structural panels [(oriented strand board)] , applied vertically, horizontal joints blocked and fastened with 6d common nails (bright) — 12" on center in the field, and 6" on center panel edges. Cavity to be filled with 3 ¹ / ₂ " mineral wool insulation. Rating established for exposure from interior side only.	—	—	—	4 ¹ / ₂
16. Exterior walls rated for fire resistance from the inside only in accordance with Section [704.5] <u>705.5</u> .	16-1.2 ^q	2" x 6" [(51 mm x 152 mm)] wood studs at 16" centers with double top plates, single bottom plate; interior side covered with ⁵ / ₈ " Type X gypsum wallboard, 4' wide, applied horizontally or vertically with vertical joints over studs and fastened with 2 ¹ / ₄ " Type S drywall screws, spaced 12" on center, wallboard joints covered with paper tape and joint compound, fastener heads covered with joint compound, exterior side covered with ⁷ / ₁₆ " wood structural panels [(oriented strand board)] fastened with 6d common nails (bright) spaced 12" on center in the field and 6" on center along the panel edges. Cavity to be filled with 5 ¹ / ₂ " mineral wool insulation. Rating established from the gypsum-covered side only.	—	—	—	6 ⁹ / ₁₆

TABLE [720.1(2)] 721.1(2)
RATED FIRE-RESISTANCE PERIODS FOR VARIOUS WALLS AND PARTITIONS^{A,O,P}

MATERIAL	ITEM NUMBER	CONSTRUCTION	MINIMUM FINISHED THICKNESS FACE-TO-FACE ^b (inches)			
			[hour] <u>hours</u>	[hour] <u>hours</u>	[hour] <u>hours</u>	<u>hour</u>
16. Exterior walls rated for fire resistance from the inside only in accordance with Section [704.5] 705.5.	16-1.3 ^a	2" × 6" wood studs at 16" centers with double top plates, single bottom plates; interior side covered with 5/8" Type X gypsum wallboard, 4' wide, applied vertically with all joints over framing or blocking and fastened with 2 1/4" Type S drywall screws spaced 7" on center. Joints to be covered with tape and joint compound. Exterior covered with 3/8" wood structural panels, applied vertically with edges over framing or blocking and fastened with 6d common nails (bright) at 12" on center in the field and 6" on center on panel edges. R-19 mineral fiber insulation installed in stud cavity. Rating established [from] <u>from</u> the gypsum-covered side only.	—	—	—	6 1/2

For SI: 1 inch = 25.4 mm, 1 square inch = 645.2 mm², 1 cubic foot = 0.0283 m³.

- a. Staples with equivalent holding power and penetration shall be permitted to be used as alternate fasteners to nails for attachment to wood framing.
- b. ~~[Thickness]~~ Thicknesses shown for brick and clay tile are nominal thicknesses unless plastered, in which case thicknesses are net. Thickness shown for concrete masonry and clay masonry is equivalent thickness defined in Section [721.3.1] 722.3.1 for concrete masonry and Section [721.4.1] 722.4.1.1 for clay masonry. Where all cells are solid grouted or filled with silicone-treated perlite loose-fill insulation; vermiculite loose-fill insulation; or expanded clay, shale or slate lightweight aggregate, the equivalent thickness shall be the thickness of the block or brick using specified dimensions as defined in Chapter 21. Equivalent thickness ~~[may]~~ shall also include the thickness of applied plaster and lath or gypsum wallboard, where specified.
- c. For units in which the net cross-sectional area of cored brick in any plane parallel to the surface containing the cores is ~~[at least]~~ not less than 75 percent of the gross cross-sectional area measured in the same plane.
- d. Shall be used for nonbearing purposes only.
- e. For all of the construction with gypsum wallboard described in this table, gypsum base for veneer plaster of the same size, thickness and core type shall be permitted to be substituted for gypsum wallboard, provided attachment is identical to that specified for the wallboard, and the joints on the face layer are reinforced and the entire surface is covered with a ~~[minimum]~~ not less than of 1/16-inch gypsum veneer plaster.
- f. The fire-resistance time period for concrete masonry units meeting the equivalent thicknesses required for a 2-hour fire-resistance rating in Item 3, and having a thickness of not less than 7 7/8 inches is 4 hours ~~[when]~~ where cores ~~[which]~~ that are not grouted are filled with silicone-treated perlite loose-fill insulation; vermiculite loose-fill insulation; or expanded clay, shale or slate lightweight aggregate, sand or slag having a maximum particle size of 3/8 inch.
- g. The fire-resistance rating of concrete masonry units composed of a combination of aggregate types or where plaster is applied directly to the concrete masonry shall be determined in accordance with ACI 216.1/TMS 216. Lightweight aggregates shall have a maximum combined density of 65 pounds per cubic foot.
- h. See also Note b. The equivalent thickness shall be permitted to include the thickness of cement plaster or 1.5 times the thickness of gypsum plaster applied in accordance with the requirements of Chapter 25.
- i. Concrete walls shall be reinforced with horizontal and vertical temperature reinforcement as required by Chapter 19.
- j. Studs are welded truss wire studs with 0.18 inch (No. 7 B.W. gage) flange wire and 0.18 inch (No. 7 B.W. gage) truss wires.
- k. Nailable metal studs consist of two channel studs spot welded back to back with a crimped web forming a nailing groove.
- l. Wood structural panels shall be permitted to be installed between the fire protection and the wood studs on either the interior or exterior side of the wood frame assemblies in this table, provided the length of the fasteners used to attach the fire protection is increased by an amount ~~[at least equal to]~~ not less than the thickness of the wood structural panel.
- m. ~~[The]~~ For studs with a slenderness ratio, l_e/d, greater than 33, the design stress [of studs] shall be reduced to 78 percent of allowable F'_c. For studs with [the maximum] a slenderness ratio, l_e/d, not [greater than 78 percent of] exceeding 33, the design stress shall be reduced to 78 percent of the adjusted stress F'_c calculated [stress with] for studs having a slenderness ratio l_e/d of 33.
- n. For properties of cooler or wallboard nails, see ASTM C 514, ASTM C 547 or ASTM F 1667.
- o. Generic fire-resistance ratings (those not designated as PROPRIETARY* in the listing) in the GA 600 shall be accepted as if herein listed.
- p. NCMA TEK 5-8, shall be permitted for the design of fire walls.
- q. The design stress of studs shall be equal to a maximum of 100 percent of the allowable F'_c calculated in accordance with Section 2306.

TABLE [720.1(3)] 721.1(3)
MINIMUM PROTECTION FOR FLOOR AND ROOF SYSTEMS^{A,Q}

FLOOR OR ROOF CONSTRUCTION	ITEM NUMBER	CEILING CONSTRUCTION	THICKNESS OF FLOOR OR ROOF SLAB (inches)				MINIMUM THICKNESS OF CEILING (inches)			
			4 [hour] hours	3 [hour] hours	2 [hour] hours	1 hour	4 [hour] hours	3 [hour] hours	2 [hour] hours	1 hour
1. Siliceous aggregate concrete	1-1.1	Slab (no ceiling required). Minimum cover over nonprestressed reinforcement shall be not less than ³ / ₄ inch. ^b	7.0	6.2	5.0	3.5	—	—	—	—
2. Carbonate aggregate concrete	2-1.1		6.6	5.7	4.6	3.2	—	—	—	—
3. Sand-lightweight concrete	3-1.1		5.4	4.6	3.8	2.7	—	—	—	—
4. Lightweight concrete	4-1.1		5.1	4.4	3.6	2.5	—	—	—	—
5. Reinforced concrete	5-1.1	Slab with suspended ceiling of vermiculite gypsum plaster over metal lath attached to ³ / ₄ " cold-rolled channels spaced 12" on center. Ceiling located 6" minimum below joists.	3	2	—	—	1	³ / ₄	—	—

TABLE [720.1(3)] 721.1(3)
MINIMUM PROTECTION FOR FLOOR AND ROOF SYSTEMS^{A,Q}

FLOOR OR ROOF CONSTRUCTION	ITEM NUMBER	CEILING CONSTRUCTION	THICKNESS OF FLOOR OR ROOF SLAB (inches)				MINIMUM THICKNESS OF CEILING (inches)			
			4 [hour] hours	3 [hour] hours	2 [hour] hours	1 hour	4 [hour] hours	3 [hour] hours	2 [hour] hours	1 hour
5. Reinforced concrete	5-2.1	<p>³/₈" Type X gypsum wallboard^c attached to 0.018 inch (No. 25 carbon sheet steel gage) by ⁷/₈" deep by 2⁵/₈" hat-shaped galvanized steel channels with 1"-long No. 6 screws. The channels are spaced 24" on center, span 35" and are supported along their length at 35" intervals by 0.033-inch (No. 21 galvanized sheet gage) galvanized steel flat strap hangers having formed edges that engage the lips of the channel. The strap hangers are attached to the side of the concrete joists with ⁵/₃₂" by 1¹/₄" long power-driven fasteners. The wallboard is installed with the long dimension perpendicular to the channels. All end End joints occur on channels and supplementary channels are installed parallel to the main channels, 12" each side, at end joint occurrences. The finished ceiling is located approximately 12" below the soffit of the floor slab.</p>	—	—	2 ¹ / ₂	—	—	—	⁵ / ₈	—
6. Steel joists constructed with a poured reinforced concrete slab on metal lath forms or steel form units ^{d,e}	6-1.1	<p>Gypsum plaster on metal lath attached to the bottom cord with single No. 16 gage or doubled No. 18 gage wire ties spaced 6" on center. Plaster mixed 1:2 for scratch coat, 1:3 for brown coat, by weight, gypsum-to-sand aggregate for 2-hour system. For 3-hour system plaster is neat.</p>	—	—	2 ¹ / ₂	2 ¹ / ₄	—	—	³ / ₄	⁵ / ₈

TABLE [720.1(3)] 721.1(3)
MINIMUM PROTECTION FOR FLOOR AND ROOF SYSTEMS^{A,Q}

FLOOR OR ROOF CONSTRUCTION	ITEM NUMBER	CEILING CONSTRUCTION	THICKNESS OF FLOOR OR ROOF SLAB (inches)				MINIMUM THICKNESS OF CEILING (inches)			
			4 [hour] hours	3 [hour] hours	2 [hour] hours	1 hour	4 [hour] hours	3 [hour] hours	2 [hour] hours	1 hour
6. Steel joists constructed with a poured reinforced concrete slab on metal lath forms or steel form units ^{d,e}	6-2.1	Vermiculite gypsum plaster on metal lath attached to the bottom chord with single No. 16 gage or doubled 0.049-inch (No. 18 B.W. gage) wire ties 6" on center.	—	2	—	—	—	5/8	—	—
6. Steel joists constructed with a poured reinforced concrete slab on metal lath forms or steel form units ^{d,e}	6-3.1	Cement plaster over metal lath attached to the bottom chord of joists with single No. 16 gage or doubled 0.049-inch (No. 18 B.W. gage) wire ties spaced 6" on center. Plaster mixed 1:2 for scratch coat, 1:3 for brown coat for 1-hour system and 1:1 for scratch coat, 1:1 1/2 for brown coat for 2-hour system, by weight, cement to sand.	—	—	—	2	—	—	—	5/8 ^f
6. Steel joists constructed with a poured reinforced concrete slab on metal lath forms or steel form units ^{d,e}	6-4.1	Ceiling of 5/8" Type X wallboard ^c attached to 7/8" deep by 2 5/8" by 0.021 inch (No. 25 carbon sheet steel gage) hat-shaped furring channels 12" on center with 1" long No. 6 wallboard screws at 8" on center. Channels wire tied to bottom chord of joists with doubled 0.049 inch (No. 18 B.W. gage) wire or suspended below joists on wire hangers. ^g	—	—	2 1/2	—	—	—	5/8	—
6. Steel joists constructed with a poured reinforced concrete slab on metal lath forms or steel form units ^{d,e}	6-5.1	Wood-fibered gypsum plaster mixed 1:1 by weight gypsum to sand aggregate applied over metal lath. Lath tied 6" on center to 3/4" channels spaced 13 1/2" on center. Channels secured to joists at each intersection with two strands of 0.049 inch (No. 18 B.W. gage) galvanized wire.	—	—	2 1/2	—	—	—	3/4	—

TABLE [720.1(3)] 721.1(3)
MINIMUM PROTECTION FOR FLOOR AND ROOF SYSTEMS^{A,Q}

FLOOR OR ROOF CONSTRUCTION	ITEM NUMBER	CEILING CONSTRUCTION	THICKNESS OF FLOOR OR ROOF SLAB (inches)				MINIMUM THICKNESS OF CEILING (inches)			
			4 [hour] hours	3 [hour] hours	2 [hour] hours	1 hour	4 [hour] hours	3 [hour] hours	2 [hour] hours	1 hour
7. Reinforced concrete slabs and joists with hollow clay tile fillers laid end to end in rows 2 1/2" or more apart; reinforcement placed between rows and concrete cast around and over tile.	7-1.1	5/8" gypsum plaster on bottom of floor or roof construction.	—	—	8 ^h	—	—	—	5/8	—
7. Reinforced concrete slabs and joists with hollow clay tile fillers laid end to end in rows 2 1/2" or more apart; reinforcement placed between rows and concrete cast around and over tile.	7-1.2	None	—	—	—	5 1/2 ⁱ	—	—	—	—
8. Steel joists constructed with a reinforced concrete slab on top poured on a 1/2" deep steel deck. ^e	8-1.1	Vermiculite gypsum plaster on metal lath attached to 3/4" cold-rolled channels with 0.049" (No. 18 B.W. gage) wire ties spaced 6" on center.	2 1/2 ⁱ	—	—	—	3/4	—	—	—
9. 3" deep cellular steel deck with concrete slab on top. Slab thickness measured to top.	9-1.1	Suspended ceiling of vermiculite gypsum plaster base coat and vermiculite acoustical plaster on metal lath attached at 6" intervals to 3/4" cold-rolled channels spaced 12" on center and secured to 1 1/2" cold-rolled channels spaced 36" on center with 0.065" (No. 16 B.W. gage) wire. 1 1/2" channels supported by No. 8 gage wire hangers at 36" on center. Beams within envelope and with a 2 1/2" airspace between beam soffit and lath have a 4-hour rating.	2 1/2	—	—	—	1 1/8 ^k	—	—	—

TABLE [720.1(3)] 721.1(3)
MINIMUM PROTECTION FOR FLOOR AND ROOF SYSTEMS^{A,Q}

FLOOR OR ROOF CONSTRUCTION	ITEM NUMBER	CEILING CONSTRUCTION	THICKNESS OF FLOOR OR ROOF SLAB (inches)				MINIMUM THICKNESS OF CEILING (inches)			
			4 [hour] hours	3 [hour] hours	2 [hour] hours	1 hour	4 [hour] hours	3 [hour] hours	2 [hour] hours	1 hour
10. 1 1/2" deep steel roof deck on steel framing. Insulation board, 30 pcf density, composed of wood fibers with cement binders of thickness shown bonded to deck with unified asphalt adhesive. Covered with a Class A or B roof covering.	10-1.1	Ceiling of gypsum plaster on metal lath. Lath attached to 3/4" furring channels with 0.049" (No. 18 B.W. gage) wire ties spaced 6" on center. 3/4" channel saddle tied to 2" channels with doubled 0.065" (No. 16 B.W. gage) wire ties. 2" channels spaced 36" on center suspended 2" below steel framing and saddle tied with 0.165" (No. 8 B.W. gage) wire. Plaster mixed 1:2 by weight, gypsum-to-sand aggregate.	—	—	1 7/8	1	—	—	3/4 ¹	3/4 ¹
11. 1 1/2"-deep steel roof deck on steel-framing wood fiber insulation board, 17.5 pcf density on top applied over a 15-lb asphalt- saturated felt. Class A or B roof covering.	11-1.1	Ceiling of gypsum plaster on metal lath. Lath attached to 3/4" furring channels with 0.049" (No. 18 B.W. gage) wire ties spaced 6" on center. 3/4" channels saddle tied to 2" channels with doubled 0.065" (No. 16 B.W. gage) wire ties. 2" channels spaced 36" on center suspended 2" below steel framing and saddle tied with 0.165" (No. 8 B.W. gage) wire. Plaster mixed 1:2 for scratch coat and 1:3 for brown coat, by weight, gypsum-to-sand aggregate for 1-hour system. For 2-hour system, plaster mix is 1:2 by weight, gypsum-to-sand aggregate.	—	—	1 1/2	1	—	—	7/8 ^g	3/4 ¹

TABLE [720.1(3)] 721.1(3)
MINIMUM PROTECTION FOR FLOOR AND ROOF SYSTEMS^{A,Q}

FLOOR OR ROOF CONSTRUCTION	ITEM NUMBER	CEILING CONSTRUCTION	THICKNESS OF FLOOR OR ROOF SLAB (inches)				MINIMUM THICKNESS OF CEILING (inches)			
			4 [hour] hours	3 [hour] hours	2 [hour] hours	1 hour	4 [hour] hours	3 [hour] hours	2 [hour] hours	1 hour
12. 1 1/2" deep steel roof deck on steel-framing insulation of rigid board consisting of expanded perlite and fibers impregnated with integral asphalt waterproofing; density 9 to 12 pcf secured to metal roof deck by 1/2" wide ribbons of waterproof, cold-process liquid adhesive spaced 6" apart. Steel joist or light steel construction with metal roof deck, insulation, and Class A or B built-up roof covering. ^e	12-1.1	Gypsum-vermiculite plaster on metal lath wire tied at 6" intervals to 3/4" furring channels spaced 12" on center and wire tied to 2" runner channels spaced 32" on center. Runners wire tied to bottom chord of steel joists.	—	—	1	—	—	—	7/8	—
13. Double wood floor over wood joists spaced 16" on center. ^{m,n}	13-1.1	Gypsum plaster over 3/8" Type X gypsum lath. Lath initially applied with not less than four 1 1/8" by No. 13 gage by 19/64" head plasterboard blue nails per bearing. Continuous stripping over lath along all joist lines. Stripping consists of 3" wide strips of metal lath attached by 1 1/2" by No. 11 gage by 1/2" head roofing nails spaced 6" on center. Alternate stripping consists of 3" wide 0.049-diameter wire stripping weighing 1 pound per square yard and attached by No. 16 gage by 1 1/2" by 3/4" crown width staples, spaced 4" on center. Where alternate stripping is used, the lath nailing may shall consist of two nails at each end and one nail at each intermediate bearing. Plaster mixed 1:2 by weight, gypsum-to-sand aggregate.	—	—	—	—	—	—	—	7/8

TABLE [720.1(3)] 721.1(3)
MINIMUM PROTECTION FOR FLOOR AND ROOF SYSTEMS^{A,Q}

FLOOR OR ROOF CONSTRUCTION	ITEM NUMBER	CEILING CONSTRUCTION	THICKNESS OF FLOOR OR ROOF SLAB (inches)				MINIMUM THICKNESS OF CEILING (inches)			
			4 [hour] hours	3 [hour] hours	2 [hour] hours	1 hour	4 [hour] hours	3 [hour] hours	2 [hour] hours	1 hour
13. Double wood floor over wood joists spaced 16" on center. ^{m,n}	13-1.2	Cement or gypsum plaster on metal lath. Lath fastened with 1 1/2" by No. 11 gage by 7/16" head barbed shank roofing nails spaced 5" on center. Plaster mixed 1:2 for scratch coat and 1:3 for brown coat, by weight, cement to sand aggregate.	—	—	—	—	—	—	—	5/8
13. Double wood floor over wood joists spaced 16" on center. ^{m,n}	13-1.3	Perlite or vermiculite gypsum plaster on metal lath secured to joists with 1 1/2" by No. 11 gage by 7/16" head barbed shank roofing nails spaced 5" on center.	—	—	—	—	—	—	—	5/8
13. Double wood floor over wood joists spaced 16" on center. ^{m,n}	13-1.4	1/2" Type X gypsum wallboard ^c nailed to joists with 5d cooler ^o or wallboard ^o nails at 6" on center. End joints of wallboard centered on joists.	—	—	—	—	—	—	—	1/2
14. Plywood stressed skin panels consisting of 5/8"-thick interior C-D (exterior glue) top stressed skin on 2" x 6" nominal (minimum) stringers. Adjacent panel edges joined with 8d common wire nails spaced 6" on center. Stringers spaced 12" maximum on center.	14-1.1	1/2"-thick wood fiberboard weighing 15 to 18 pounds per cubic foot installed with long dimension parallel to stringers or 3/8" C-D (exterior glue) plywood glued and/or nailed to stringers. Nailing to be with 5d cooler ^o or wallboard ^o nails at 12" on center. Second layer of 1/2" Type X gypsum wallboard ^c applied with long dimension perpendicular to joists and attached with 8d cooler ^o or wallboard ^o nails at 6" on center at end joints and 8" on center elsewhere. Wallboard joints staggered with respect to fiberboard joints.	—	—	—	—	—	—	—	1

TABLE [720.1(3)] 721.1(3)
MINIMUM PROTECTION FOR FLOOR AND ROOF SYSTEMS^{A,Q}

FLOOR OR ROOF CONSTRUCTION	ITEM NUMBER	CEILING CONSTRUCTION	THICKNESS OF FLOOR OR ROOF SLAB (inches)				MINIMUM THICKNESS OF CEILING (inches)			
			4 [hour] hours	3 [hour] hours	2 [hour] hours	1 hour	4 [hour] hours	3 [hour] hours	2 [hour] hours	1 hour
15. Vermiculite concrete slab proportioned 1:4 (portland cement to vermiculite aggregate) on a 1 1/2"-deep steel deck supported on individually protected steel framing. Maximum span of deck 6'-10" where deck is less than 0.019 inch (No. 26 carbon steel sheet gage) or greater. Slab reinforced with 4" x 8" 0.109/0.083" (No. 12/14 B.W. gage) welded wire mesh.	15-1.1	None.	—	—	—	3 ^j	—	—	—	—
16. Perlite concrete slab proportioned 1:6 (portland cement to perlite aggregate) on a 1 1/4"-deep steel deck supported on individually protected steel framing. Slab reinforced with 4" x 8" 0.109/0.083" (No. 12/14 B.W. gage)	16-1.1	None.	—	—	—	3 1/2 ^j	—	—	—	—
17. Perlite concrete slab proportioned 1:6 (portland cement to perlite aggregate) on a 9/16"-deep steel deck supported by steel joists 4' on center. Class A or B roof covering on top.	17-1.1	Perlite gypsum plaster on metal lath wire tied to 3/4" furring channels attached with 0.065-inch (No. 16 B.W. gage) wire ties to lower chord of joists.	—	2 ^p	2 ^p	—	—	7/8	3/4	—

TABLE [720.1(3)] 721.1(3)
MINIMUM PROTECTION FOR FLOOR AND ROOF SYSTEMS^{A,Q}

FLOOR OR ROOF CONSTRUCTION	ITEM NUMBER	CEILING CONSTRUCTION	THICKNESS OF FLOOR OR ROOF SLAB (inches)				MINIMUM THICKNESS OF CEILING (inches)			
			4 [hour] hours	3 [hour] hours	2 [hour] hours	1 hour	4 [hour] hours	3 [hour] hours	2 [hour] hours	1 hour
18. Perlite concrete slab proportioned 1:6 (portland cement to perlite aggregate) on 1 ¹ / ₄ "-deep steel deck supported on individually protected steel framing. Maximum span of deck 6'-10" where deck is less than 0.019" (No. 26 carbon sheet steel gage) and 8'-0" where deck is 0.019" (No. 26 carbon sheet steel gage) or greater. Slab reinforced with 0.042" (No. 19 B.W. gage) hexagonal wire mesh. Class A or B roof covering on top.	18-1.1	None.	—	2 ¹ / ₄ ^P	2 ¹ / ₄ ^P	—	—	—	—	—
19. Floor and beam construction consisting of 3"-deep cellular steel floor unit mounted on steel members with 1:4 (proportion of portland cement to perlite aggregate) perlite-concrete floor slab on top.	19-1.1	Suspended envelope ceiling of perlite gypsum plaster on metal lath attached to ³ / ₄ " cold-rolled channels, secured to 1 ¹ / ₂ " cold-rolled channels spaced 42" on center supported by 0.203 inch (No. 6 B.W. gage) wire 36" on center. Beams in envelope with 3" minimum airspace between beam soffit and lath have a 4-hour rating.	2 ^P	—	—	—	1 ¹	—	—	—

TABLE [720.1(3)] 721.1(3)
MINIMUM PROTECTION FOR FLOOR AND ROOF SYSTEMS^{A,Q}

FLOOR OR ROOF CONSTRUCTION	ITEM NUMBER	CEILING CONSTRUCTION	THICKNESS OF FLOOR OR ROOF SLAB (inches)				MINIMUM THICKNESS OF CEILING (inches)			
			4 [hour] hours	3 [hour] hours	2 [hour] hours	1 hour	4 [hour] hours	3 [hour] hours	2 [hour] hours	1 hour
20. Perlite concrete proportioned 1:6 (portland cement to perlite aggregate) poured to 1/8-inch thickness above top of corrugations of 1 5/16"-deep galvanized steel deck maximum span 8'-0" for 0.024-inch (No. 24 galvanized sheet gage) or 6' 0" for 0.019-inch (No. 26 galvanized sheet gage) with deck supported by individually protected steel framing. Approved polystyrene foam plastic insulation board having a flame spread not exceeding 75 (1" to 4" thickness) with vent holes that approximate 3 percent of the board surface area placed on top of perlite	20-1.1	None.	—	—	Varies	—	—	—	—	—

TABLE [720.1(3)] 721.1(3)
MINIMUM PROTECTION FOR FLOOR AND ROOF SYSTEMS^{A,Q}

FLOOR OR ROOF CONSTRUCTION	ITEM NUMBER	CEILING CONSTRUCTION	THICKNESS OF FLOOR OR ROOF SLAB (inches)				MINIMUM THICKNESS OF CEILING (inches)			
			4 [hour] hours	3 [hour] hours	2 [hour] hours	1 hour	4 [hour] hours	3 [hour] hours	2 [hour] hours	1 hour
<p>20. Continued - A 2' by 4' insulation board contains six 2³/₄" diameter holes. Board covered with 2¹/₄" minimum perlite concrete slab. Slab reinforced with mesh consisting of 0.042 inch (No. 19 B.W. gage) galvanized steel wire twisted together to form 2" hexagons with straight 0.065 inch (No. 16 B.W. gage) galvanized steel wire woven into mesh and spaced 3". Alternate slab reinforcement shall be permitted to consist of 4" x 8", 0.109/0.238-inch (No. 12/4 B.W. gage), or 2" x 2", 0.083/ 0.083-inch (No. 14/14 B.W. gage) welded wire fabric. Class A or B roof covering on top.</p>	20-1.1	None.	—	—	Varies	—	—	—	—	—
<p>21. Wood joists, wood I-joists, floor trusses and flat or pitched roof trusses spaced a maximum 24" o.c. with 1/2" wood structural panels with exterior glue applied at right angles to top of joist or top chord of trusses with 8d nails. The wood structural panel thickness shall be not [be] less than nominal 1/2" nor less than required by Chapter 23.</p>	21-1.1	<p>Base layer 5/8" Type X gypsum wallboard applied at right angles to joist or truss 24" o.c. with 1 1/4" Type S or Type W drywall screws 24" o.c. Face layer 5/8" Type X gypsum wallboard or veneer base applied at right angles to joist or truss through base layer with 1 7/8" Type S or Type W drywall screws 12" o.c. at joints and intermediate joist or truss. Face layer Type G drywall screws placed 2" back on either side of face layer end joints, 12" o.c.</p>	—	—	—	Varies	—	—	—	1/4

TABLE [720.1(3)] 721.1(3)
MINIMUM PROTECTION FOR FLOOR AND ROOF SYSTEMS^{A,Q}

FLOOR OR ROOF CONSTRUCTION	ITEM NUMBER	CEILING CONSTRUCTION	THICKNESS OF FLOOR OR ROOF SLAB (inches)				MINIMUM THICKNESS OF CEILING (inches)			
			4 [hour] hours	3 [hour] hours	2 [hour] hours	1 hour	4 [hour] hours	3 [hour] hours	2 [hour] hours	1 hour
22. Steel joists, floor trusses and flat or pitched roof trusses spaced a maximum 24" o.c. with 1/2" wood structural panels with exterior glue applied at right angles to top of joist or top chord of trusses with No. 8 screws. The wood structural panel thickness shall be not [be] less than nominal 1/2" nor less than required by Chapter 23.	22-1.1	Base layer 5/8" Type X gypsum board applied at right angles to steel framing 24" on center with 1" Type S drywall screws spaced 24" on center. Face layer 5/8" Type X gypsum board applied at right angles to steel framing attached through base layer with 1 5/8" Type S drywall screws 12" on center at end joints and intermediate joints and 1 1/2" Type G drywall screws 12 inches on center placed 2" back on either side of face layer end joints. Joints of the face layer are offset 24" from the joints of the base layer.	—	—	—	Varies	—	—	—	1/4
23. Wood I-joist (minimum joist depth 9 1/4" with a minimum flange depth of 1 5/16" and a minimum flange cross-sectional area of [2.3] 2.25 square inches) at 24" o.c. spacing with [4 inch] a minimum 1" x 4" [inch (nominal) wood furring] (3/4" x 3.5" actual) ledger strip [spacer] applied parallel to and covering the bottom of the bottom flange of each member, tacked in place. 2" mineral [fiber] wool insulation, 3.5 pcf (nominal) installed adjacent to the bottom flange of the I-joist and supported by the 1" x 4" [furring] ledger strip [spacer].	23-1.1	1/2" deep single leg resilient channel 16" on center (channels doubled at wallboard end joints), placed perpendicular to the furring strip and joist and attached to each joist by 1 7/8" Type S drywall screws. 5/8" Type C gypsum wallboard applied perpendicular to the channel with end joints staggered [at least] not less than 4' and fastened with 1 1/8" Type S drywall screws spaced 7" on center. Wallboard joints to be taped and covered with joint compound.	—	—	—	Varies	—	—	—	5/8

TABLE [720.1(3)] 721.1(3)
MINIMUM PROTECTION FOR FLOOR AND ROOF SYSTEMS^{A,Q}

FLOOR OR ROOF CONSTRUCTION	ITEM NUMBER	CEILING CONSTRUCTION	THICKNESS OF FLOOR OR ROOF SLAB (inches)				MINIMUM THICKNESS OF CEILING (inches)			
			4 [hour] hours	3 [hour] hours	2 [hour] hours	1 hour	4 [hour] hours	3 [hour] hours	2 [hour] hours	1 hour
24. Wood I-joist (minimum I-joist depth 9¼" with a minimum flange depth of 1½" and a minimum flange cross-sectional area of 5.25 square inches; minimum web thickness of 3/8") @ 24" o.c., 1½" mineral wool insulation (2.5 pcf – nominal) resting on hat-shaped furring channels.	24-1.1	Minimum 0.026" thick hat-shaped channel 16" o.c. (channels doubled at wallboard end joints), placed perpendicular to the joist and attached to each joist by [4 ^{5/8"}] 1¼" Type S drywall screws. 5/8" Type C gypsum wallboard applied perpendicular to the channel with end joints staggered and fastened with 1½" Type S drywall screws spaced 12" o.c. in the field and 8" o.c. at the wallboard ends. Wallboard joints to be taped and covered with joint compound.	—	—	—	Varies	—	—	—	5/8
25. Wood I-joist (minimum I-joist depth 9¼" with a minimum flange depth of 1½" and a minimum flange cross-sectional area of 5.25 square inches; minimum web thickness of 7/16") @ 24" o.c., 1½" mineral wool insulation (2.5 pcf – nominal) resting on resilient channels.	25-1.1	Minimum 0.019" thick resilient channel 16" o.c. (channels doubled at wallboard end joints), placed perpendicular to the joist and attached to each joist by 1 ^{5/8"} Type S drywall screws. 5/8" Type C gypsum wallboard applied perpendicular to the channel with end joints staggered and fastened with 1" Type S drywall screws spaced 12" o.c. in the field and 8" o.c. at the wallboard ends. Wallboard joints to be taped and covered with joint compound.	—	—	—	Varies	—	—	—	5/8

TABLE [720.1(3)] 721.1(3)
MINIMUM PROTECTION FOR FLOOR AND ROOF SYSTEMS^{A,Q}

FLOOR OR ROOF CONSTRUCTION	ITEM NUMBER	CEILING CONSTRUCTION	THICKNESS OF FLOOR OR ROOF SLAB (inches)				MINIMUM THICKNESS OF CEILING (inches)			
			4 [hour] hours	3 [hour] hours	2 [hour] hours	1 hour	4 [hour] hours	3 [hour] hours	2 [hour] hours	1 hour
26. Wood I-joint (minimum I-joint depth 9¼" with a minimum flange thickness of 1½" and a minimum flange cross-sectional area of 2.25 square inches; minimum web thickness of 3/8") @ 24" o.c.	26-1.1	Two layers of ½" Type X gypsum wallboard applied with the long dimension perpendicular to the I-joists with end joints staggered. The base layer is fastened with 1⅝" Type S drywall screws spaced 12" o.c. and the face layer is fastened with 2" Type S drywall screws spaced 12" o.c. in the field and 8" o.c. on the edges. Face layer end joints shall not occur on the same I-joint as base layer end joints and edge joints shall be offset 24" from base layer joints. Face layer to also be attached to base layer with 1½" Type G drywall screws spaced 8" o.c. placed 6" from face layer end joints. Face layer wallboard joints to be taped and covered with joint compound.	—	—	—	Varies	—	—	—	1

TABLE [720.1(3)] 721.1(3)
MINIMUM PROTECTION FOR FLOOR AND ROOF SYSTEMS^{A,Q}

FLOOR OR ROOF CONSTRUCTION	ITEM NUMBER	CEILING CONSTRUCTION	THICKNESS OF FLOOR OR ROOF SLAB (inches)				MINIMUM THICKNESS OF CEILING (inches)			
			4 [hour] hours	3 [hour] hours	2 [hour] hours	1 hour	4 [hour] hours	3 [hour] hours	2 [hour] hours	1 hour
27. Wood I-joist (minimum I-joist depth 9½" with a minimum flange depth of 1 ¹⁵ / ₁₆ " and a minimum flange cross-sectional area of 1.95 square inches; minimum web thickness of 3/8") @ 24" o.c.	27-1.1	Minimum 0.019" thick resilient channel 16" o.c. (channels doubled at wallboard end joints), placed perpendicular to the joist and attached to each joist by 1⅝" Type S drywall screws. Two layers of ½" Type X gypsum wallboard applied with the long dimension perpendicular to the I-joists with end joints staggered. The base layer is fastened with 1¼" Type S drywall screws spaced 12" o.c. and the face layer is fastened with 1⅝" Type S drywall screws spaced 12" o.c. Face layer end joints shall not occur on the same I-joist as base layer end joints and edge joints shall be offset 24" from base layer joints. Face layer to also be attached to base layer with 1½" Type G drywall screws spaced 8" o.c. placed 6" from face layer end joints. Face layer wallboard joints to be taped and covered with joint compound.	—	—	—	Varies	—	—	—	1

TABLE [720.1(3)] 721.1(3)
MINIMUM PROTECTION FOR FLOOR AND ROOF SYSTEMS^{A,Q}

FLOOR OR ROOF CONSTRUCTION	ITEM NUMBER	CEILING CONSTRUCTION	THICKNESS OF FLOOR OR ROOF SLAB (inches)				MINIMUM THICKNESS OF CEILING (inches)			
			4 [hour] hours	3 [hour] hours	2 [hour] hours	1 hour	4 [hour] hours	3 [hour] hours	2 [hour] hours	1 hour
28. Wood I-joist (minimum I-joist depth 9¼" with a minimum flange depth of 1½" and a minimum flange cross-sectional area of 2.25 square inches; minimum web thickness of 3⁄8") @ 24" o.c. Unfaced fiberglass insulation or <u>mineral wool insulation</u> is installed between the I-joists supported on the upper surface of the flange by stay wires spaced 12" o.c.	28-1.1	Base layer of 5⁄8" Type C gypsum wallboard attached directly to I-joists with 1½" Type S drywall screws spaced 12" o.c. with ends staggered. Minimum 0.0179" thick hat-shaped 7⁄8-inch furring channel 16" o.c. (channels doubled at wallboard end joints), placed perpendicular to the joist and attached to each joist by 1½" Type S drywall screws after the base layer of gypsum wallboard has been applied. The middle and face layers of 5⁄8" Type C gypsum wallboard applied perpendicular to the channel with end joints staggered. The middle layer is fastened with 1" Type S drywall screws spaced 12" o.c. The face layer is applied parallel to the middle layer but with the edge joints offset 24" from those of the middle layer and fastened with 1½" Type S drywall screws 8" o.c. The joints shall be taped and covered with joint compound.	—	—	—	Varies	—	—	2¾	—

TABLE [720.1(3)] 721.1(3)
MINIMUM PROTECTION FOR FLOOR AND ROOF SYSTEMS^{A,Q}

FLOOR OR ROOF CONSTRUCTION	ITEM NUMBER	CEILING CONSTRUCTION	THICKNESS OF FLOOR OR ROOF SLAB (inches)				MINIMUM THICKNESS OF CEILING (inches)			
			4 [hour] hours	3 [hour] hours	2 [hour] hours	1 hour	4 [hour] hours	3 [hour] hours	2 [hour] hours	1 hour
29. Channel-shaped 18 gage steel joists (minimum depth 8") spaced a maximum 24" o.c. supporting tongue-and-groove wood structural panels (nominal minimum 3/4" thick) applied perpendicular to framing members. Structural panels attached with 1 5/8" Type S-12 screws spaced 12" o.c.	29-1.1	Base layer 5/8" Type X gypsum board applied perpendicular to bottom of framing members with 1 1/8" Type S-12 screws spaced 12" o.c. Second layer 5/8" Type X gypsum board attached perpendicular to framing members with 1 5/8" Type S-12 screws spaced 12" o.c. Second layer joints offset 24" from base layer. Third layer 5/8" Type X gypsum board attached perpendicular to framing members with 2 3/8" Type S-12 screws spaced 12" o.c. Third layer joints offset 12" from second layer joints. Hat-shaped 7/8-inch rigid furring channels applied at right angles to framing members over third layer with two 2 3/8" Type S-12 screws at each framing member. Face layer 5/8" Type X gypsum board applied at right angles to furring channels with 1 1/8" Type S screws spaced 12" o.c.	—	—	Varies	—	—	—	3 3/8	—

TABLE [720.1(3)] 721.1(3)
MINIMUM PROTECTION FOR FLOOR AND ROOF SYSTEMS^{A,Q}

FLOOR OR ROOF CONSTRUCTION	ITEM NUMBER	CEILING CONSTRUCTION	THICKNESS OF FLOOR OR ROOF SLAB (inches)				MINIMUM THICKNESS OF CEILING (inches)			
			4 [hour] hours	3 [hour] hours	2 [hour] hours	1 hour	4 [hour] hours	3 [hour] hours	2 [hour] hours	1 hour
30. Wood I-joint (minimum I-joint depth 9½" with a minimum flange depth of 1½" and a minimum flange cross-sectional area of 2.25 square inches, minimum web thickness of 3⁄8") @ 24" o.c. Fiberglass insulation placed between I-joists supported by the resilient channels.	30-1.1	Minimum 0.019" thick resilient channel 16" o.c. (channels doubled at wallboard end joints), placed perpendicular to the joists and attached to each joist by 1¼" Type S drywall screws. Two layers of ½" Type X gypsum wallboard applied with the long dimension perpendicular to the I-joists with end joints staggered. The base layer is fastened with 1¼" Type S drywall screws spaced 12" o.c. and the face layer is fastened with 1⅝" Type S drywall screws spaced 12" o.c. Face layer end joints shall not occur on the same I-joint as base layer end joints and edge joints shall be offset 24" from base layer joints. Face layer to be attached to base layer with 1½" Type G drywall screws spaced 8" o.c. placed 6" from face layer end joints. Face layer wallboard joints to be taped and covered with joint compound.	—	—	Varies	—	—	—	—	1

[Table 720.1(3) Notes:]

For SI: 1 inch = 25.4 mm, 1 foot = 304.8 mm, 1 pound = 0.454 kg, 1 cubic foot = 0.0283m³, 1 pound per square inch = 6.895 kPa = 1 pound per lineal foot = 1.4882 kg/m.

- a. Staples with equivalent holding power and penetration shall be permitted to be used as alternate fasteners to nails for attachment to wood framing.
- b. ~~When~~ Where the slab is in an unrestrained condition, minimum reinforcement cover shall be not ~~be~~ less than 1⅝ inches for 4~~[-hour] hours~~ (siliceous aggregate only); 1¼ inches for 4~~[-] and 3[-hour] hours~~; 1 inch for 2~~[-hour] hours~~ (siliceous aggregate only); and ¾ inch for all other restrained and unrestrained conditions.
- c. For all of the construction with gypsum wallboard described in this table, gypsum base for veneer plaster of the same size, thickness and core type shall be permitted to be substituted for gypsum wallboard, provided attachment is identical to that specified for the wallboard, and the joints on the face layer are reinforced and the entire surface is covered with ~~a minimum of~~ not less than 1⁄16-inch gypsum veneer plaster.
- d. Slab thickness over steel joists measured at the joists for metal lath form and at the top of the form for steel form units.
- e. (a) The maximum allowable stress level for H-Series joists shall not exceed 22,000 psi.
 (b) The allowable stress for K-Series joists shall not exceed 26,000 psi, the nominal depth of such joist shall be not ~~be~~ less than 10 inches and the nominal joist weight shall be not ~~be~~ less than 5 pounds per ~~linear~~ linear foot.
- f. Cement plaster with 15 pounds of hydrated lime and 3 pounds of approved additives or admixtures per bag of cement.
- g. Gypsum wallboard ceilings attached to steel framing shall be permitted to be suspended with 1½-inch cold-formed carrying channels spaced 48 inches on center~~;~~ which ~~that~~ are suspended with No.8 SWG galvanized wire hangers spaced 48 inches on center. Cross-furring channels are tied to the carrying channels with No.18 SWG galvanized wire hangers spaced 48 inches on center. Cross-furring channels are tied to the carrying channels with No. 18 SWG galvanized wire (double strand) and spaced as required for direct attachment to the framing. This alternative is ~~also~~ applicable to those steel framing assemblies recognized under Note q.
- h. Six-inch hollow clay tile with 2-inch concrete slab above.
- i. Four-inch hollow clay tile with 1½-inch concrete slab above.
- j. Thickness measured to bottom of steel form units.
- k. Five-eighths inch of vermiculite gypsum plaster plus 1/2 inch of approved vermiculite acoustical plastic.
- l. Furring channels spaced 12 inches on center.
- m. Double wood floor shall be permitted to be either of the following:

- (a) Subfloor of 1-inch nominal boarding, a layer of asbestos paper weighing not less than 14 pounds per 100 square feet and a layer of 1-inch nominal tongue-and-groove finished flooring; or
- (b) Subfloor of 1-inch nominal tongue-and-groove boarding or 15/32-inch wood structural panels with exterior glue and a layer of 1-inch nominal tongue-and-groove finished flooring or 19/32-inch wood structural panel finish flooring or a layer of Type I GradeM-1 particleboard not less than 5/8-inch thick.
- n. The ceiling shall be permitted to be omitted over unusable space, and flooring shall be permitted to be omitted where unusable space occurs above.
- o. For properties of cooler or wallboard nails, see ASTM C 514, ASTM C 547 or ASTM F 1667.
- p. Thickness measured on top of steel deck unit.
- q. Generic fire-resistance ratings (those not designated as PROPRIETARY* in the listing) in the GA 600 shall be accepted as if herein listed.

[720.1.1] 721.1.1 Thickness of protective coverings. The thickness of fire-resistant materials required for protection of structural members shall be not less than set forth in Table [720.1(1)] 721.1(1), except as modified in this section. The figures shown shall be the net thickness of the protecting materials and shall not include any hollow space in back of the protection.

[720.1.2] 721.1.2 Unit masonry protection. Where required, metal ties shall be embedded in bed joints of unit masonry for protection of steel columns. Such ties shall be as set forth in Table [720.1(1)] 721.1(1) or be equivalent thereto.

[720.1.3] 721.1.3 Reinforcement for cast-in-place concrete column protection. Cast-in-place concrete protection for steel columns shall be reinforced at the edges of such members with wire ties of not less than 0.18 inch (4.6 mm) in diameter wound spirally around the columns on a pitch of not more than 8 inches ([203] 203.2 mm) or by equivalent reinforcement.

[720.1.4] 721.1.4 Plaster application. The finish coat is not required for plaster protective coatings where [they] such coatings comply with the design mix and thickness requirements of Tables [720.1(1)] 721.1(1), [720.1(2)] 721.1(2), and [720.1(3)] 721.1(3).

[720.1.5] 721.1.5 Bonded prestressed concrete tendons. For members having a single tendon or more than one tendon installed with equal concrete cover measured from the nearest surface, the cover shall be not [be] less than that set forth in Table [720.1(1)] 721.1(1). For members having multiple tendons installed with variable concrete cover, the average tendon cover shall be not [be] less than that set forth in Table [720.1(1)] 721.1(1), provided:

1. The clearance from each tendon to the nearest exposed surface is used to determine the average cover.
2. In no case can the clear cover for individual tendons be less than one-half of that set forth in Table [720.1(1)] 721.1(1). A minimum cover of $3/4$ inch (19.1 mm) for slabs and 1 inch ([25] 25.4 mm) for beams is required for any aggregate concrete.
3. For the purpose of establishing a fire-resistance rating, tendons having a clear covering less than that set forth in Table [720.1(1)] 721.1(1) shall not contribute more than 50 percent of the required ultimate moment capacity for members less than 350 square inches (0.226 m²) in cross-sectional area and 65 percent for larger members. For structural design purposes, however, tendons having a reduced cover are assumed to be fully effective.

SECTION BC [721] 722 CALCULATED FIRE RESISTANCE

[721.1] 722.1 General. The provisions of this section contain procedures by which the fire resistance of specific materials or combinations of materials is established by calculations. These procedures apply only to the information contained in this section and shall not be otherwise used. The calculated

fire resistance of concrete, concrete masonry^[7] and clay masonry assemblies shall be permitted in accordance with ACI 216.1/TMS ~~[0216.1]~~ 216. The calculated fire resistance of steel assemblies shall be permitted in accordance with Chapter 5 of ~~[ASCE/SEI 29]~~ ASCE 29. The calculated fire resistance of exposed wood members and wood decking shall be permitted in accordance with Chapter 16 of ~~[ANSI/AP&PA]~~ ANSI/AWC National Design Specification for Wood Construction (NDS).

~~[721.1.1]~~ **722.1.1 Definitions.** The following ~~[words and]~~ terms ~~[shall, for the purposes of this chapter and as used elsewhere]~~ are defined in ~~[this code, have the meanings shown herein.]~~ Chapter 2 of this code:

CERAMIC FIBER BLANKET. ~~[A mineral wool insulation material made of alumina-silica fibers and weighing 4 to 10 pounds per cubic foot (pcf) (64 to 160 kg/m³).]~~

CONCRETE, CARBONATE AGGREGATE. ~~[Concrete made with aggregates consisting mainly of calcium or magnesium carbonate, such as limestone or dolomite, and containing 40 percent or less quartz, chert, or flint.]~~

CONCRETE, CELLULAR. ~~[A lightweight insulating concrete made by mixing a preformed foam with portland cement slurry and having a dry unit weight of approximately 30 pcf (480 kg/m³).]~~

CONCRETE, LIGHTWEIGHT AGGREGATE. ~~[Concrete made with aggregates of expanded clay, shale, slag or slate or sintered fly ash or any natural lightweight aggregate meeting ASTM C 330 and possessing equivalent fire resistance properties and weighing 85 to 115 pcf (1360 to 1840 kg/m³).]~~

CONCRETE, PERLITE. ~~[A lightweight insulating concrete having a dry unit weight of approximately 30 pcf (480 kg/m³) made with perlite concrete aggregate. Perlite aggregate is produced from a volcanic rock which, when heated, expands to form a glass-like material of cellular structure.]~~

CONCRETE, SAND-LIGHTWEIGHT. ~~[Concrete made with a combination of expanded clay, shale, slag, slate, sintered fly ash, or any natural lightweight aggregate meeting ASTM C 330 and possessing equivalent fire resistance properties and natural sand. Its unit weight is generally between 105 and 120 pcf (1680 and 1920 kg/m³).]~~

CONCRETE, SILICEOUS AGGREGATE. ~~[Concrete made with normal weight aggregates consisting mainly of silica or compounds other than calcium or magnesium carbonate, which contains more than 40 percent quartz, chert, or flint.]~~

CONCRETE, VERMICULITE. ~~[A lightweight insulating concrete made with vermiculite concrete aggregate which is laminated micaceous material produced by expanding the ore at high temperatures. When added to a portland cement slurry the resulting concrete has a dry unit weight of approximately 30 pcf (480 kg/m³).]~~

GLASS FIBERBOARD. ~~[Fibrous glass roof insulation consisting of inorganic glass fibers formed into rigid boards using a binder. The board has a top surface faced with asphalt and kraft reinforced with glass fiber.]~~

MINERAL BOARD. [~~A rigid felted thermal insulation board consisting of either felted mineral fiber or cellular beads of expanded aggregate formed into flat rectangular units.~~]

[721.2] 722.2 Concrete assemblies. The provisions of this section contain procedures by which the fire-resistance ratings of concrete assemblies are established by calculations.

[721.2.1] 722.2.1 Concrete walls. Cast-in-place and precast concrete walls shall comply with Section ~~[721.2.1.1] 722.2.1.1~~. Multiwythe concrete walls shall comply with Section ~~[721.2.1.2] 722.2.1.2~~. Joints between precast panels shall comply with Section ~~[721.2.1.3] 722.2.1.3~~. Concrete walls with gypsum wallboard or plaster finish shall comply with Section ~~[721.2.1.4] 722.2.1.4~~.

[721.2.1.1] 722.2.1.1 Cast-in-place or precast walls. The minimum equivalent ~~[thickness]~~ thicknesses of cast-in-place or precast concrete walls for fire-resistance ratings of 1 hour to 4 hours are shown in Table ~~[721.2.1.1] 722.2.1.1~~. For solid walls with flat vertical surfaces, the equivalent thickness is the same as the actual thickness. The values in Table ~~[721.2.1.1] 722.2.1.1~~ apply to plain, reinforced or prestressed concrete walls.

**TABLE ~~[721.1.1] 722.2.1.1~~
MINIMUM EQUIVALENT THICKNESS OF CAST-IN-PLACE OR PRECAST
CONCRETE WALLS, LOAD BEARING OR NONLOAD-BEARING**

CONCRETE TYPE	MINIMUM SLAB THICKNESS (inches) FOR FIRE-RESISTANCE RATING OF				
	[1-hour] 1 hour	1½[-hour] hours	2[-hour] hours	3[-hour] hours	4[-hour] hours
Siliceous	3.5	4.3	5.0	6.2	7.0
Carbonate	3.2	4.0	4.6	5.7	6.6
Sand- [Lightweight] lightweight	2.7	3.3	3.8	4.6	5.4
Lightweight	2.5	3.1	3.6	4.4	5.1

For SI: 1 inch = 25.4 mm.

[721.2.1.1.1] 722.2.1.1.1 Hollow-core precast wall panels. For hollow-core precast concrete wall panels in which the cores are of constant cross section throughout the length, calculation of the equivalent thickness by dividing the net cross-sectional area (the gross cross section minus the area of the cores) of the panel by its width shall be permitted.

[721.2.1.1.2] 722.2.1.1.2 Core spaces filled. Where all of the core spaces of hollow-core wall panels are filled with loose-fill material, such as expanded shale, clay~~[-]~~ or slag, or vermiculite or perlite, the fire-resistance rating of the wall is the same as that of a solid wall of the same concrete type and of the same overall thickness.

[721.2.1.1.3] 722.2.1.1.3 Tapered cross sections. The thickness of panels with tapered cross sections shall be that determined at a distance 2t or 6 inches (~~[152] 152.4~~ mm), whichever is less, from the point of minimum thickness, where t is the minimum thickness.

[721.2.1.1.4] 722.2.1.1.4 Ribbed or undulating surfaces. The equivalent thickness of panels with ribbed or undulating surfaces shall be determined by one of the following expressions:

For $s \geq 4t$, the thickness to be used shall be t
 For $s \leq 2t$, the thickness to be used shall be t_e
 For $4t > s > 2t$, the thickness to be used shall be

$$t + \left(\frac{4t}{s} - 1\right)(t_e - t) \quad \text{(Equation 7-3)}$$

where:

s = Spacing of ribs or undulations.

t = Minimum thickness.

t_e = Equivalent thickness of the panel calculated as the net cross-sectional area of the panel divided by the width, in which the maximum thickness used in the calculation shall not exceed $2t$.

[721.2.1.2] 722.2.1.2 Multi-wythe walls. For walls that consist of two wythes of different types of concrete, the fire-resistance ratings shall be permitted to be determined from Figure [721.2.1.2] 722.2.1.2.

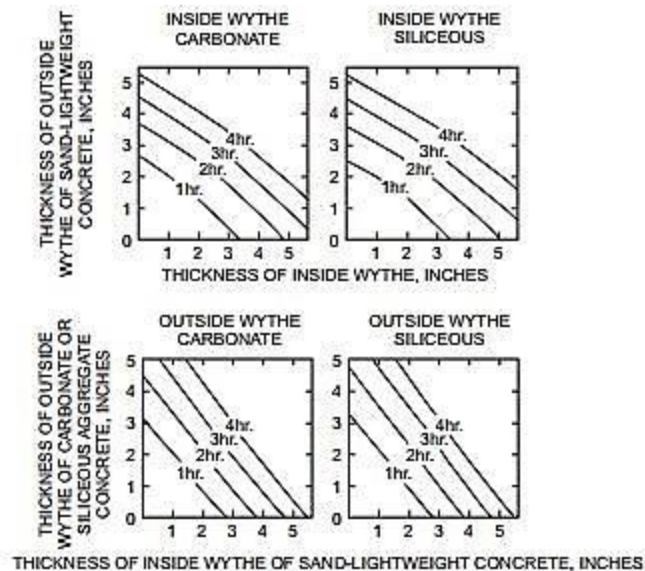

For SI: 1 inch = 25.4 mm.

**FIGURE [721.2.1.2] 722.2.1.2
 FIRE-RESISTANCE RATINGS OF
 TWO-WYTHE CONCRETE WALLS**

[721.2.1.2.1] 722.2.1.2.1 Two or more wythes. The fire-resistance rating for wall panels consisting of two or more wythes shall be permitted to be determined by the formula:

$$R = (R_1^{0.59} + R_2^{0.59} + \dots + R_n^{0.59})1.7 \quad \text{(Equation 7-4)}$$

where:

R = The fire endurance of the assembly, minutes.

R_1 , R_2 , and R_n = The fire endurance of the individual wythes, minutes. Values of $R_n^{0.59}$ for use in Equation 7-4 are given in Table [721.2.1.2(1)] 722.2.1.2(1). Calculated fire-resistance ratings are shown in Table [721.2.1.2(2)] 722.2.1.2(2).

**TABLE [721.2.1.2(1)] 722.2.1.2(1)
VALUES OF $R_n^{0.59}$ FOR USE IN EQUATION 7-4**

TYPE OF MATERIAL	THICKNESS OF MATERIAL (inches)											
	1½	2	2½	3	3½	4	4½	5	5½	6	6½	7
Siliceous aggregate concrete	5.3	6.5	8.1	9.5	11.3	13.0	14.9	16.9	18.8	20.7	22.8	25.1
Carbonate aggregate concrete	5.5	7.1	8.9	10.4	12.0	14.0	16.2	18.1	20.3	21.9	24.7	27.2 ^c
Sand-lightweight concrete	6.5	8.2	10.5	12.8	15.5	18.1	20.7	23.3	26.0 ^c	Note c	Note c	Note c
Lightweight concrete	6.6	8.8	11.2	13.7	16.5	19.1	21.9	24.7	27.8 ^c	Note c	Note c	Note c
Insulating concrete ^a	9.3	13.3	16.6	18.3	23.1	26.5 ^c	Note c	Note c	Note c	Note c	Note c	Note c
Airspace ^b	—	—	—	—	—	—	—	—	—	—	—	—

For SI: 1 inch = 25.4 mm, 1 pound per cubic foot = 16.02 kg/m³.

- Dry unit weight of 35 pcf or less and consisting of cellular, perlite or vermiculite concrete.
- The $R_n^{0.59}$ value for one ½" to 3½" airspace is 3.3. The $R_n^{0.59}$ value for two ½" to 3½" airspaces is 6.7.
- The fire-resistance rating for this thickness exceeds 4 hours.

**TABLE [721.2.1.2(2)] 722.2.1.2(2)
FIRE-RESISTANCE RATINGS BASED ON $R^{0.59}$**

R^* , MINUTES	$R^{0.59}$
60	11.20
120	16.85
180	21.41
240	25.37

a. Based on Equation 7-4.

[721.2.1.2.2] 722.2.1.2.2 Foam plastic insulation. The fire-resistance ratings of precast concrete wall panels consisting of a layer of foam plastic insulation sandwiched between two wythes of concrete shall be permitted to be determined by use of Equation 7-4. Foam plastic insulation with a total thickness of less than 1 inch (~~25~~ 25.4 mm) shall be disregarded. The R_n value for thickness of foam plastic insulation of 1 inch (~~25~~ 25.4 mm) or greater, for use in the calculation, is 5 minutes; therefore $R_n^{0.59} = 2.5$.

[721.2.1.3] 722.2.1.3 Joints between precast wall panels. Joints between precast concrete wall panels ~~which~~ that are not insulated as required by this section shall be considered as openings in walls. Uninsulated joints shall be included in determining the percentage of openings permitted by Table [704.8] 705.8. Where openings are not permitted or are required by this code to be protected, the provisions of this section shall be used to determine the amount of joint insulation required. Insulated joints shall not be considered openings for purposes of determining compliance with the allowable percentage of openings in Table [704.8] 705.8.

[721.2.1.3.1] 722.2.1.3.1 Ceramic fiber joint protection. Figure [721.2.1.3.1] 722.2.1.3.1 shows thicknesses of ceramic fiber blankets to be used to insulate joints between precast concrete wall panels for various panel thicknesses and for joint widths of $\frac{3}{8}$ inch (9.5 mm) and 1 inch ([25] 25.4 mm) for fire-resistance ratings of 1 hour to 4 hours. For joint widths between $\frac{3}{8}$ inch (9.5 mm) and 1 inch ([25] 25.4 mm), the thickness of ceramic fiber blanket is allowed to be determined by direct interpolation. Other tested and labeled materials are acceptable in place of ceramic fiber blankets.

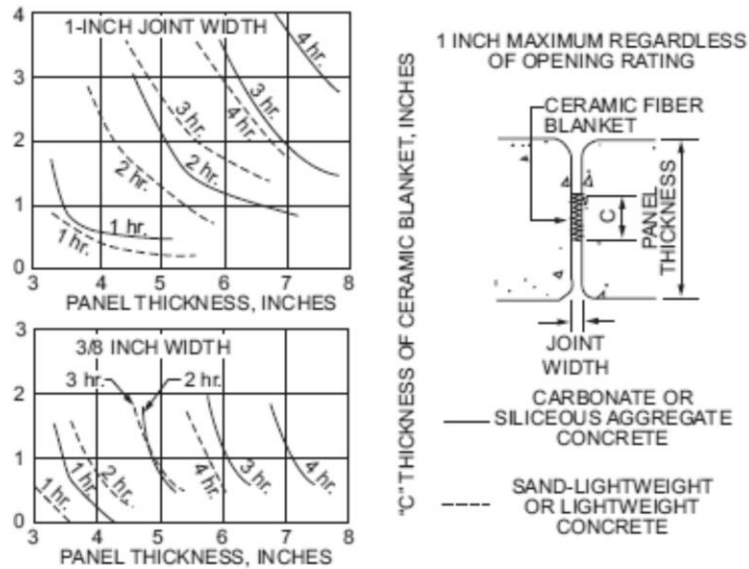

For SI: 1 inch = 25.4 mm.

FIGURE [721.2.1.3.1] 722.2.1.3.1 CERAMIC FIBER JOINT PROTECTION

[721.2.1.4] 722.2.1.4 Walls with gypsum wallboard or plaster finishes. The fire-resistance rating of cast-in-place or precast concrete walls with finishes of gypsum wallboard or plaster applied to one or both sides shall be permitted to be calculated in accordance with the provisions of this section.

[721.2.1.4.1] 722.2.1.4.1 Nonfire-exposed side. Where the finish of gypsum wallboard or plaster is applied to the side of the wall not exposed to fire, the contribution of the finish to the total fire-resistance rating shall be determined as follows: The thickness of the finish shall first be corrected by multiplying the actual thickness of the finish by the applicable factor determined from Table [721.2.1.4(1)] 722.2.1.4(1) based on the type of aggregate in the concrete. The corrected thickness of finish shall then be added to the actual or equivalent thickness of concrete and fire-resistance rating of the concrete and finish determined from [Table 721.2.1.1, Figure 721.2.1.2 or Table 721.2.1.2(1)] Tables 722.2.1.1 and 722.2.1.2(1), and Figure 722.2.1.2.

TABLE [721.2.1.4(1)] 722.2.1.4(1)
MULTIPLYING FACTOR FOR FINISHES ON NONFIRE-EXPOSED SIDE OF WALL

TYPE OF FINISH APPLIED TO CONCRETE OR CONCRETE MASONRY WALL	TYPE OF AGGREGATE USED IN CONCRETE OR CONCRETE MASONRY			
	Concrete: siliceous or carbonate Concrete Masonry: siliceous or carbonate; solid clay brick	Concrete: sand-lightweight Concrete Masonry: clay tile; hollow clay brick; concrete masonry units of expanded shale and < 20% sand	Concrete: lightweight Concrete Masonry: concrete masonry units of expanded shale, expanded clay, expanded slag, or pumice < 20% sand	Concrete Masonry: concrete masonry units of expanded slag, expanded clay, or pumice
Portland cement-sand plaster	1.00	0.75 ^a	0.75 ^a	0.50 ^a
Gypsum-sand plaster	1.25	1.00	1.00	1.00
Gypsum-vermiculite or perlite plaster	1.75	1.50	1.25	1.25
Gypsum wallboard	3.00	2.25	2.25	2.25

For SI: 1 inch = 25.4 mm.

- a. For portland cement-[sandplaster] sand plaster ⁵/₈ inch or less in thickness and applied directly to the masonry on the nonfire-exposed side of the wall, the multiplying factor shall be 1.00.

TABLE [721.2.1.4(2)] 722.2.1.4(2)
TIME ASSIGNED TO FINISH MATERIALS ON FIRE-EXPOSED SIDE OF WALL

FINISH DESCRIPTION	TIME (minute)
Gypsum wallboard	
³ / ₈ inch	10
¹ / ₂ inch	15
⁵ / ₈ inch	20
2 layers of ³ / ₈ inch	25
1 layer of ³ / ₈ inch, 1 layer of ¹ / ₂ inch	35
2 layers of ¹ / ₂ inch	40
Type X gypsum wallboard	
¹ / ₂ inch	25
⁵ / ₈ inch	40
Portland cement-sand plaster applied directly to concrete masonry	See Note a
Portland cement-sand plaster on metal lath	
³ / ₄ inch	20
⁷ / ₈ inch	25
1 inch	30
Gypsum sand plaster on ³ / ₈ -inch gypsum lath	
¹ / ₂ inch	35
⁵ / ₈ inch	40
³ / ₄ inch	50
Gypsum sand plaster on metal lath	
³ / ₄ inch	50
⁷ / ₈ inch	60
1 inch	80

For SI: 1 inch = 25.4 mm.

- a. The actual thickness of portland cement-sand plaster, provided it is $\frac{5}{8}$ inch or less in thickness, shall be permitted to be included in determining the equivalent thickness of the masonry for use in Table [721.3.2] 722.3.2.

[721.2.1.4.2] 722.2.1.4.2 Fire-exposed side. Where gypsum wallboard or plaster is applied to the fire-exposed side of the wall, the contribution of the finish to the total fire-resistance rating shall be determined as follows: The time assigned to the finish as established by Table [721.2.1.4(2)] 722.2.1.4(2) shall be added to the fire-resistance rating determined from [Table 721.2.1.1 or Figure 721.2.1.2, or Table 721.2.1.2(1)] Tables 722.2.1.1 and 722.2.1.2(1) and Figure 722.2.1.2 for the concrete alone, or to the rating determined in Section [721.2.1.4.1] 722.2.1.4.1 for the concrete and finish on the nonfire-exposed side.

[721.2.1.4.3] 722.2.1.4.3 Nonsymmetrical assemblies. For a wall having no finish on one side or different types or thicknesses of finish on each side, the calculation procedures of Sections [721.2.1.4.1] 722.2.1.4.1 and [721.2.1.4.2] 722.2.1.4.2 shall be performed twice, assuming either side of the wall to be the fire-exposed side. The fire-resistance rating of the wall shall not exceed the lower of the two values.

Exception: For an exterior wall with a fire separation distance greater than 5 feet (1524 mm), the fire shall be assumed to occur on the interior side only.

[721.2.1.4.4] 722.2.1.4.4 Minimum concrete fire-resistance rating. Where finishes applied to one or both sides of a concrete wall contribute to the fire-resistance rating, the concrete alone shall provide not less than one-half of the total required fire-resistance rating. Additionally, the contribution to the fire resistance of the finish on the nonfire-exposed side of a load-bearing wall shall not exceed one-half the contribution of the concrete alone.

[721.2.1.4.5] 722.2.1.4.5 Concrete finishes. Finishes on concrete walls that are assumed to contribute to the total fire-resistance rating of the wall shall comply with the installation requirements of Section [721.3.2.5] 722.3.2.5.

[721.2.2] 722.2.2 Concrete floor and roof slabs. Reinforced and prestressed floors and roofs shall comply with Section [721.2.2.1] 722.2.2.1. Multicourse floors and roofs shall comply with Sections [721.2.2.2] 722.2.2.2 and [721.2.2.3] 722.2.2.3, respectively.

[721.2.2.1] 722.2.2.1 Reinforced and prestressed floors and roofs. The minimum thicknesses of reinforced and prestressed concrete floor or roof slabs for fire-resistance ratings of 1 hour to 4 hours are shown in Table [721.2.2.1] 722.2.2.1.

Exception: Minimum thickness shall not be required for floors and ramps within open and enclosed parking garages constructed in accordance with Section 406.

**TABLE [721.2.2.1] 722.2.2.1
MINIMUM SLAB THICKNESS (inches)**

CONCRETE TYPE	FIRE-RESISTANCE RATING ((hour) hours)				
	1	1½	2	3	4
Siliceous	3.5	4.3	[5.0] 5	6.2	[7.0] 7
Carbonate	3.2	[4.0] 4	4.6	5.7	6.6
Sand-lightweight	2.7	3.3	3.8	4.6	5.4
Lightweight	2.5	3.1	3.6	4.4	5.1

For SI: 1 inch = 25.4 mm.

[721.2.2.1.1] 722.2.2.1.1 Hollow-core prestressed slabs. For hollow-core prestressed concrete slabs in which the cores are of constant cross section throughout the length, the equivalent thickness shall be permitted to be obtained by dividing the net cross-sectional area of the slab including grout in the joints, by its width.

[721.2.2.1.2] 722.2.2.1.2 Slabs with sloping soffits. The thickness of slabs with sloping soffits (see Figure [721.2.2.1.2] 722.2.2.1.2) shall be determined at a distance $2t$ or 6 inches ([152] 152.4 mm), whichever is less, from the point of minimum thickness, where t is the minimum thickness.

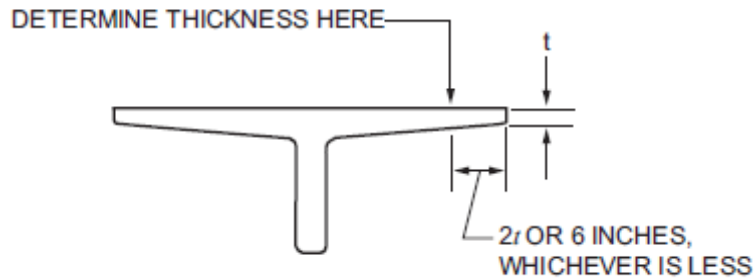

For SI: 1 inch = 25.4 mm

**FIGURE [721.2.2.1.2] 722.2.2.1.2
DETERMINATION OF SLAB THICKNESS
FOR SLOPING SOFFITS**

[721.2.2.1.3] 722.2.2.1.3 Slabs with ribbed soffits. The thickness of slabs with ribbed or undulating soffits (see Figure [721.2.2.1.3] 722.2.2.1.3) shall be determined by one of the following expressions, whichever is applicable:

For $s \geq 4t$, the thickness to be used shall be t

For $s \leq 2t$, the thickness to be used shall be t_e

For $4t > s > 2t$, the thickness to be used shall be

$$t + \left(\frac{4t}{s} - 1\right)(t_e + t) \quad \text{(Equation 7-5)}$$

where:

s = Spacing of ribs or undulations.

t = Minimum thickness.

t_e = Equivalent thickness of the slab calculated as the net area of the slab divided by the width, in which the maximum thickness used in the calculation shall not exceed $2t$.

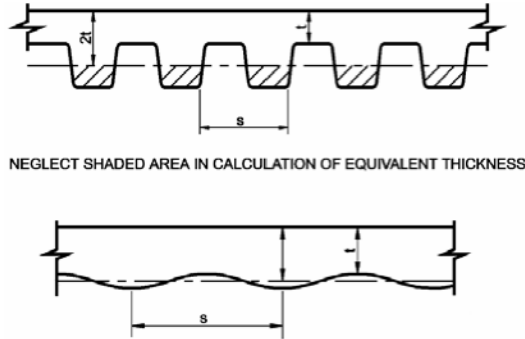

For SI: 1 inch = 25.4 mm.

FIGURE [721.2.2.1.3] 722.2.2.1.3
SLABS WITH RIBBED OR UNDULATING SOFFITS

[721.2.2.2] 722.2.2.2 Multicourse floors. The fire-resistance ratings of floors that consist of a base slab of concrete with a topping (overlay) of a different type of concrete shall comply with Figure [721.2.2.2] 722.2.2.2.

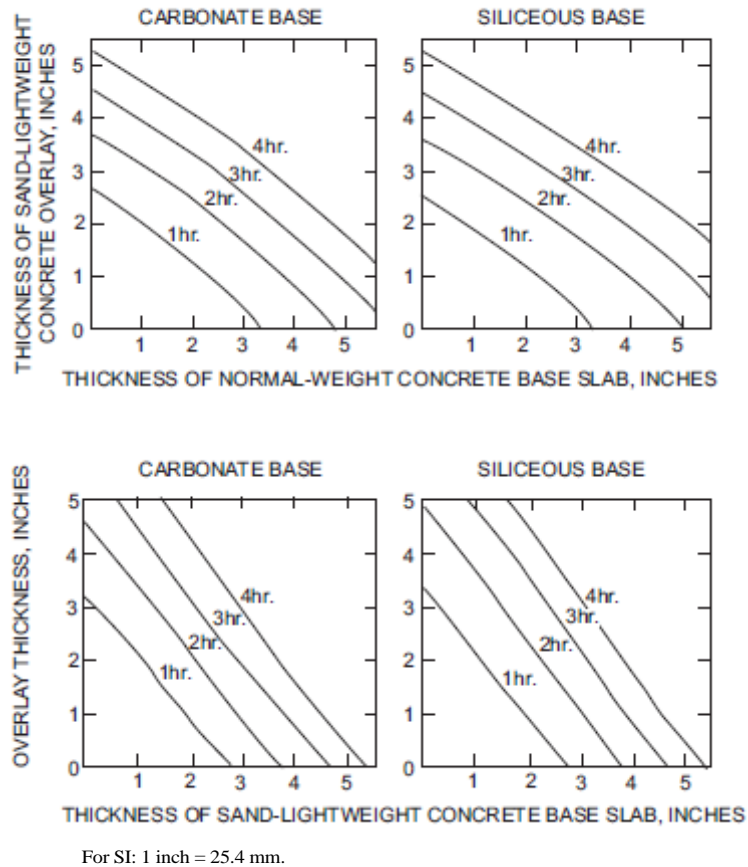

**FIGURE [721.2.2.2] 722.2.2.2
FIRE-RESISTANCE RATINGS FOR TWO-COURSE CONCRETE FLOORS**

[721.2.2.3] 722.2.2.3 **Multicourse roofs.** The fire-resistance ratings of roofs [which] that consist of a base slab of concrete with a topping (overlay) of an insulating concrete or with an insulating board and built-up roofing shall comply with Figures [721.2.2.3(1)] 722.2.2.3(1) and [721.2.2.3(2)] 722.2.2.3(2).

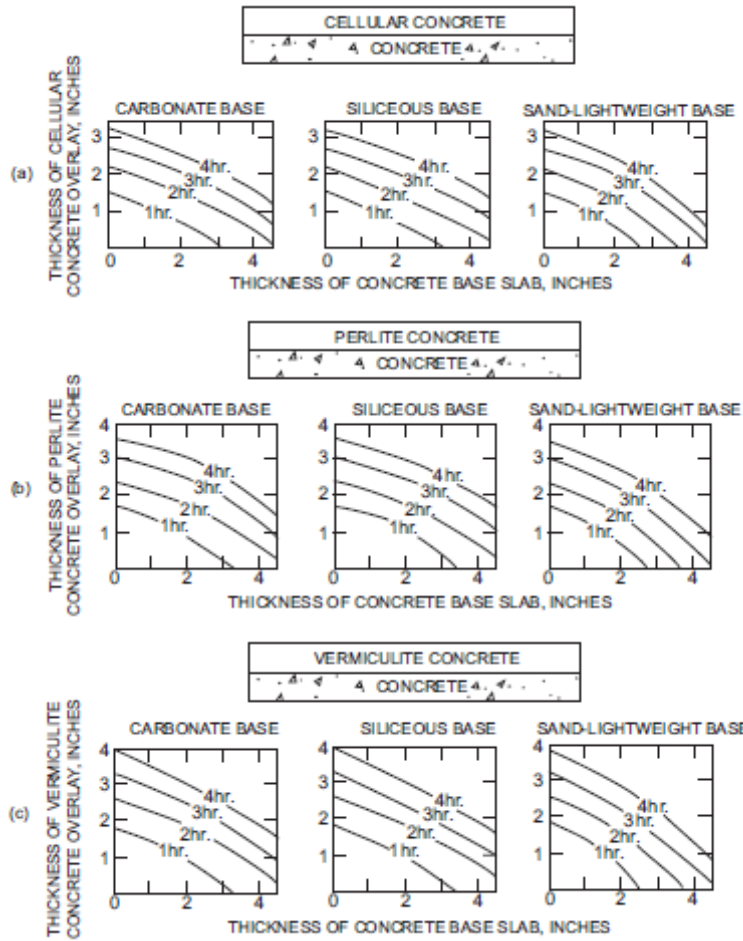

For SI: 1 inch = 25.4 mm.

FIGURE [721.2.2.3(1)] 722.2.2.3(1)
FIRE-RESISTANCE RATINGS FOR CONCRETE
ROOF ASSEMBLIES

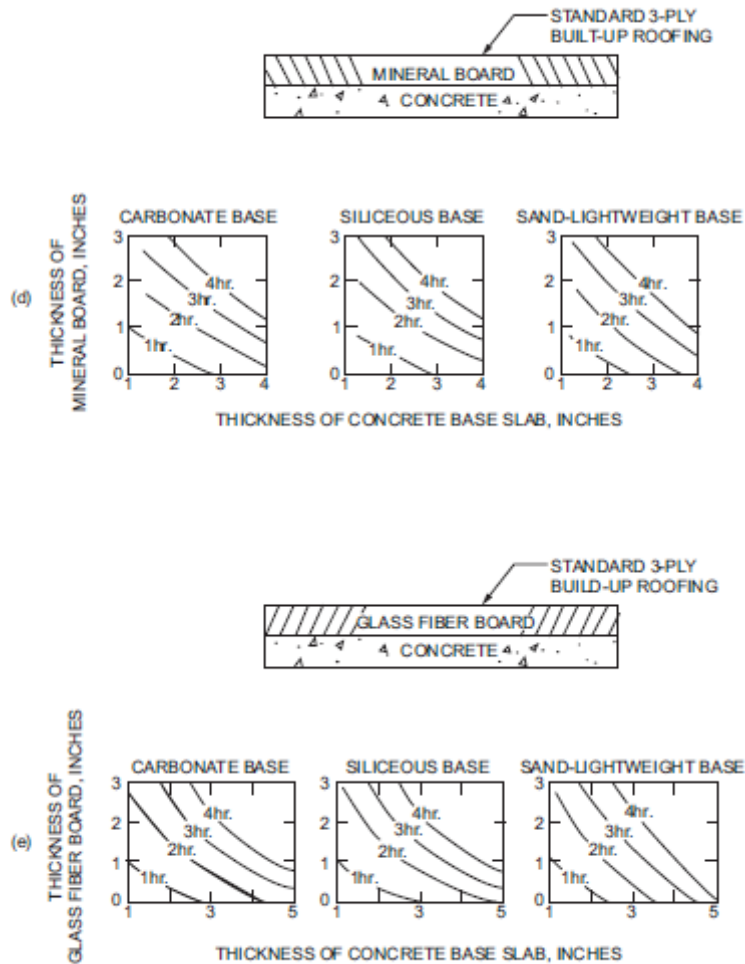

For SI: 1 inch = 25.4 mm.

FIGURE [721.2.2.3(2)] 722.2.2.3(2)
FIRE-RESISTANCE RATINGS FOR CONCRETE
ROOF ASSEMBLIES

[721.2.2.3.1] 722.2.2.3.1 Heat transfer. For the transfer of heat, three-ply built-up roofing contributes 10 minutes to the fire-resistance rating. The fire-resistance rating for concrete assemblies such as those shown in Figure [721.2.2.3(1)] 722.2.2.3(1) shall be increased by 10 minutes. This increase is not applicable to those shown in Figure [721.2.2.3(2)] 722.2.2.3(2).

[721.2.2.4] 722.2.2.4 Joints in precast slabs. Joints between adjacent precast concrete slabs need not be considered in calculating the slab thickness provided that a concrete topping [at least] not less than 1 inch ([25] 25.4 mm) thick is used. Where no concrete topping is used, joints must be grouted to a depth of [at least] not less than one-third the slab thickness at the joint, but not less than 1 inch ([25] 25.4 mm), or the joints must be made fire resistant by other approved methods.

[721.2.3] 722.2.3 Concrete cover over reinforcement. The minimum thickness of concrete cover over reinforcement in concrete slabs, reinforced beams and prestressed beams shall comply with this section.

**TABLE [721.2.3(1)] 722.2.3(1)
COVER THICKNESS FOR REINFORCED CONCRETE FLOOR OR ROOF SLABS (inches)**

CONCRETE AGGREGATE TYPE	FIRE-RESISTANCE RATING (hours)									
	Restrained					Unrestrained				
	1	1½	2	3	4	1	1½	2	3	4
Siliceous	¾	¾	¾	¾	¾	¾	¾	1	1¼	1⅝
Carbonate	¾	¾	¾	¾	¾	¾	¾	¾	1¼	1¼
Sand-lightweight or lightweight	¾	¾	¾	¾	¾	¾	¾	¾	1¼	1¼

For SI: 1 inch = 25.4 mm.

**TABLE [721.2.3(2)] 722.2.3(2)
COVER THICKNESS FOR PRESTRESSED CONCRETE FLOOR OR ROOF SLABS (inches)**

CONCRETE AGGREGATE TYPE	FIRE-RESISTANCE RATING (hours)									
	Restrained					Unrestrained				
	1	1½	2	3	4	1	1½	2	3	4
Siliceous	¾	¾	¾	¾	¾	1⅛	1½	1¾	2⅜	2¾
Carbonate	¾	¾	¾	¾	¾	1	1⅜	1⅝	2⅛	2¼
Sand-lightweight or lightweight	¾	¾	¾	¾	¾	1	1⅜	1½	2	2¼

For SI: 1 inch = 25.4 mm.

**TABLE [721.2.3(3)] 722.2.3(3)
MINIMUM COVER FOR MAIN REINFORCING BARS OF REINFORCED CONCRETE BEAMS^c (APPLICABLE TO ALL TYPES OF STRUCTURAL CONCRETE)**

RESTRAINED OR UNRESTRAINED ^a	BEAM WIDTH ^b (inches)	FIRE-RESISTANCE RATING (hours)				
		1	1½	2	3	4
Restrained	5	¾	¾	¾	1 ^a	1¼ ^a
	7	¾	¾	¾	¾	¾
	≥10	¾	¾	¾	¾	¾
Unrestrained	5	¾	1	1¼	—	—
	7	¾	¾	¾	1¾	3
	≥10	¾	¾	¾	1	1¾

For SI: 1 inch = 25.4 mm, 1 foot = 304.8 mm.

- Tabulated values for restrained assemblies apply to beams spaced more than 4 feet on center. For restrained beams spaced 4 feet or less on center, minimum cover of ¾ inch is adequate for ratings of 4 hours or less.
- For beam widths between the tabulated values, the minimum cover thickness can be determined by direct interpolation.
- The cover for an individual reinforcing bar is the minimum thickness of concrete between the surface of the bar and the fire-exposed surface of the beam. For beams in which several bars are used, the cover for corner bars used in the calculation shall be reduced to one-half of the actual value. The cover for an individual bar must be not less than one-half of the value given in Table [721.2.3(3)] 722.2.3(3) nor less than ¾ inch.

TABLE [721.2.3(4)] 722.2.3(4)
MINIMUM COVER FOR PRESTRESSED CONCRETE BEAMS
8 INCHES OR GREATER IN WIDTH^b

RESTRAINED OR UNRESTRAINED ^a	CONCRETE AGGREGATE TYPE	BEAM WIDTH ^b (inches)	FIRE-RESISTANCE RATING (hours)				
			1	1½	2	3	4
Restrained	Carbonate or siliceous	8	1½	1½	1½	1¾ ^a	2½ ^a
	Carbonate or siliceous	≥ 12	1½	1½	1½	1½	1⅞ ^a
	[Sand lightweight] Sand-lightweight	8	1½	1½	1½	1½	2a
	[Sand lightweight] Sand-lightweight	≥ 12	1½	1½	1½	1½	1⅝ ^a
Unrestrained	Carbonate or siliceous	8	1½	1¾	2½	5 ^c	—
	Carbonate or siliceous	≥ 12	1½	1½	1⅞ ^a	2½	3
	[Sand lightweight] Sand-lightweight	8	1½	1½	2	3¼	—
	[Sand lightweight] Sand-lightweight	≥ 12	1½	1½	1⅝	2	2½

For SI: 1 inch = 25.4 mm, 1 foot = 304.8 mm.

- Tabulated values for restrained assemblies apply to beams spaced more than 4 feet on center. For restrained beams spaced 4 feet or less on center, minimum cover of ¾ inch is adequate for 4-hour ratings or less.
- For beam widths between 8 inches and 12 inches, minimum cover thickness can be determined by direct interpolation.
- Not practical for 8-inch-wide beam but shown for purposes of interpolation.

TABLE [721.2.3(5)] 722.2.3(5)
MINIMUM COVER FOR PRESTRESSED CONCRETE BEAMS OF ALL WIDTHS

RESTRAINED OR UNRESTRAINED ^a	CONCRETE AGGREGATE TYPE	BEAM AREA ^b A (square inches)	FIRE-RESISTANCE RATING (hours)				
			1	1½	2	3	4
Restrained	All	40 ≤ A ≤ 150	1½	1½	2	2½	—
	Carbonate or siliceous	150 < A ≤ 300	1½	1½	1½	1¾	2½
		300 < A	1½	1½	1½	1½	2
	[Sand lightweight] Sand-lightweight	150 < A	1½	1½	1½	1½	2
Unrestrained	All	40 ≤ A ≤ 150	2	2½	—	—	—
	Carbonate or siliceous	150 < A ≤ 300	1½	1¾	2½	—	—
		300 < A	1½	1½	2	3c	4c
	[Sand lightweight] Sand-lightweight	150 < A	1½	1½	2	3c	4c

For SI: 1 inch = 25.4 mm, 1 foot = 304.8 mm.

- Tabulated values for restrained assemblies apply to beams spaced more than 4 feet on center. For restrained beams spaced 4 feet or less on center, minimum cover of ¾ inch is adequate for 4-hour ratings or less.
- The cross-sectional area of a stem is permitted to include a portion of the area in the flange, provided the width of the flange used in the calculation does not exceed three times the average width of the stem.
- U-shaped or hooped stirrups spaced not to exceed the depth of the member and having a minimum cover of 1 inch shall be provided.

[721.2.3.1] 722.2.3.1 Slab cover. The minimum thickness of concrete cover to the positive moment reinforcement shall comply with Table [721.2.3(1)] 722.2.3(1) for reinforced concrete and Table [721.2.3(2)] 722.2.3(2) for prestressed concrete. These tables are applicable for solid or hollow-core one-way or two-way slabs with flat undersurfaces. These

tables are applicable to slabs that are either cast in place or precast. For precast prestressed concrete not covered elsewhere, the procedures contained in PCI MNL 124 shall be acceptable.

[721.2.3.2] 722.2.3.2 Reinforced beam cover. The minimum thickness of concrete cover to the positive moment reinforcement (bottom steel) for reinforced concrete beams is shown in Table [721.2.3(3)] 722.2.3(3) for fire-resistance ratings of 1 hour to 4 hours.

[721.2.3.3] 722.2.3.3 Prestressed beam cover. The minimum thickness of concrete cover to the positive moment prestressing tendons (bottom steel) for restrained and unrestrained prestressed concrete beams and stemmed units shall comply with the values shown in Tables [721.2.3(4)] 722.2.3(4) and [721.2.3(5)] 722.2.3(5) for fire-resistance ratings of 1 hour to 4 hours. Values in Table [721.2.3(4)] 722.2.3(4) apply to beams 8 inches ([203] 203.2 mm) or greater in width. Values in Table [721.2.3(5)] 722.2.3(5) apply to beams or stems of any width, provided the cross-section area is not less than 40 square inches ([25-806] 25 806.4 mm²). In case of differences between the values determined from Table [721.2.3(4)] 722.2.3(4) or [721.2.3(5)] 722.2.3(5), it is permitted to use the smaller value. The concrete cover shall be calculated in accordance with Section [721.2.3.3.1] 722.2.3.3.1. The minimum concrete cover for nonprestressed reinforcement in prestressed concrete beams shall comply with Section [721.2.3.2] 722.2.3.2.

[721.2.3.3.1] 722.2.3.3.1 Calculating concrete cover. The concrete cover for an individual tendon is the minimum thickness of concrete between the surface of the tendon and the fire-exposed surface of the beam, except that for [ungrouped] ungrouped ducts, the assumed cover thickness is the minimum thickness of concrete between the surface of the duct and the fire-exposed surface of the beam. For beams in which two or more tendons are used, the cover is assumed to be the average of the minimum cover of the individual tendons. For corner tendons (tendons equal distance from the bottom and side), the minimum cover used in the calculation shall be one-half the actual value. For stemmed members with two or more prestressing tendons located along the vertical centerline of the stem, the average cover shall be the distance from the bottom of the member to the centroid of the tendons. The actual cover for any individual tendon shall be not [be] less than one-half the smaller value shown in Tables [721.2.3(4)] 722.2.3(4) and [721.2.3(5)] 722.2.3(5), or 1 inch ([25] 25.4 mm), whichever is greater.

[721.2.4] 722.2.4 Concrete columns. Concrete columns shall comply with this section.

**TABLE [721.2.4] 722.2.4
MINIMUM DIMENSION OF CONCRETE
COLUMNS (inches)**

TYPES OF CONCRETE	FIRE-RESISTANCE RATING (hours)				
	1	1½	2 ^a	3 ^a	4 ^b
Siliceous	8	9	10	12	14
Carbonate	8	9	10	11	12
Sand-lightweight	8	8½	9	10½	12

For SI: 1 inch = 25 mm.

a. The minimum dimension is permitted to be reduced to 8 inches for rectangular columns with

- two parallel sides at least 36 inches in length.
- b. The minimum dimension is permitted to be reduced to 10 inches for rectangular columns with two parallel sides at least 36 inches in length.

[721.2.4.1] 722.2.4.1 Minimum size. The minimum overall dimensions of reinforced concrete columns for fire-resistance ratings of 1 hour to 4 hours for exposure to fire on all sides shall comply with this section.

[721.2.4.1.1] 722.2.4.1.1 Concrete strength less than or equal to 12,000 psi. For columns made with concrete having a specified compressive strength, f'_c , of less than or equal to 12,000 psi (82.7 MPa), the minimum dimension shall comply with Table ~~[721.2.4]~~ 722.2.4.

[721.2.4.1.2] 722.2.4.1.2 Concrete strength greater than 12,000 psi. For columns made with concrete having a specified compressive strength, f'_c , greater than 12,000 psi (82.7 MPa), for fire-resistance ratings of 1 hour to 4 hours the minimum dimension shall be 24 inches (~~[640]~~ 609.6 mm).

[721.2.4.2] 722.2.4.2 Minimum cover for R/C columns. The minimum thickness of concrete cover to the main longitudinal reinforcement in columns, regardless of the type of aggregate used in the concrete ~~[,]~~ and the specified compressive strength of concrete, f'_c , shall be not ~~[be]~~ less than 1 inch (~~[25]~~ 25.4 mm) times the number of hours of required fire resistance or 2 inches (~~[54]~~ 50.8 mm), whichever is less.

[721.2.4.3] 722.2.4.3 Tie and spiral reinforcement. For concrete columns made with concrete having a specified compressive strength, f'_c , greater than 12,000 psi (82.7 MPa), tie and spiral reinforcement shall comply with the following:

1. The free ends of rectangular ties shall terminate with a 135-degree (2.4 rad) standard tie hook.
2. The free ends of circular ties shall terminate with a 90-degree (1.6 rad) standard tie hook.
3. The free ends of spirals, including at lap splices, shall terminate with a 90-degree (1.6 rad) standard tie hook.

The hook extension at the free end of ties and spirals shall be the larger of six bar diameters and the extension required by Section 7.1.3 of ACI 318. Hooks shall project into the core of the column.

[721.2.4.4] 722.2.4.4 Columns built into walls. The minimum dimensions of Table ~~[721.2.4]~~ 722.2.4 do not apply to a reinforced concrete column that is built into a concrete or masonry wall provided all of the following are met:

1. The fire-resistance rating for the wall is equal to or greater than the required rating of the column;
2. The main longitudinal reinforcing in the column has cover not less than that required by Section ~~[721.2.4.2]~~ 722.2.4.2; and

3. Openings in the wall are protected in accordance with Table [715.4] 716.5.

Where openings in the wall are not protected as required by Section [715.4] 716.5, the minimum dimension of columns required to have a fire-resistance rating of 3 hours or less shall be 8 inches ([203] 203.2 mm), and 10 inches (254 mm) for columns required to have a fire-resistance rating of 4 hours, regardless of the type of aggregate used in the concrete.

[721.2.4.5] **722.2.4.5 Precast cover units for steel columns.** See Section [721.5.1.4] 722.5.1.4.

[721.3] **722.3 Concrete masonry.** The provisions of this section contain procedures by which the fire-resistance ratings of concrete masonry are established by calculations.

[721.3.1] **722.3.1 Equivalent thickness.** The equivalent thickness of concrete masonry construction shall be determined in accordance with the provisions of this section.

[721.3.1.1] **722.3.1.1 Concrete masonry unit plus finishes.** The equivalent thickness of concrete masonry assemblies, T_{ea} , shall be computed as the sum of the equivalent thickness of the concrete masonry unit, T_e , as determined by Section [721.3.1.2] 722.3.1.2, [721.3.1.3] 722.3.1.3 or [721.3.1.4] 722.3.1.4, plus the equivalent thickness of finishes, T_{ef} , determined in accordance with Section [721.3.2] 722.3.2:

$$T_{ea} = T_e + T_{ef} \quad \text{(Equation 7-6)}$$

[721.3.1.2] **722.3.1.2 UngROUTED or partially grouted construction.** T_e shall be the value obtained for the concrete masonry unit determined in accordance with ASTM C 140.

[721.3.1.3] **722.3.1.3 Solid grouted construction.** The equivalent thickness, T_e , of solid grouted concrete masonry units is the actual thickness of the unit.

[721.3.1.4] **722.3.1.4 Airspaces and cells filled with loose-fill material.** The equivalent thickness of completely filled hollow concrete masonry is the actual thickness of the unit [when] where loose-fill materials are: sand, pea gravel, crushed stone, or slag that meet ASTM C 33 requirements; pumice, scoria, expanded shale, expanded clay, expanded slate, expanded slag, expanded fly ash, or cinders that comply with ASTM C 331; or perlite or vermiculite meeting the requirements of ASTM C 549 and ASTM C 516, respectively.

[721.3.2] **722.3.2 Concrete masonry walls.** The fire-resistance rating of walls and partitions constructed of concrete masonry units shall be determined from Table [721.3.2] 722.3.2. The rating shall be based on the equivalent thickness of the masonry and type of aggregate used.

**TABLE [721.3.2] 722.3.2
MINIMUM EQUIVALENT THICKNESS (inches) OF BEARING OR NONBEARING
CONCRETE MASONRY WALLS^{a,b,c,d}**

TYPE OF AGGREGATE	FIRE-RESISTANCE RATING (hours)														
	1/2	3/4	1	1 1/4	1 1/2	1 3/4	2	2 1/4	2 1/2	2 3/4	3	3 1/4	3 1/2	3 3/4	4
Pumice or expanded slag	1.5	1.9	2.1	2.5	2.7	3.0	3.2	3.4	3.6	3.8	4.0	4.2	4.4	4.5	4.7

TABLE [721.3.2] 722.3.2
MINIMUM EQUIVALENT THICKNESS (inches) OF BEARING OR NONBEARING
CONCRETE MASONRY WALLS^{a,b,c,d}

TYPE OF AGGREGATE	FIRE-RESISTANCE RATING (hours)														
	1/2	3/4	1	1 1/4	1 1/2	1 3/4	2	2 1/4	2 1/2	2 3/4	3	3 1/4	3 1/2	3 3/4	4
Expanded shale, clay or slate	1.8	2.2	2.6	2.9	3.3	3.4	3.6	3.8	4.0	4.2	4.4	4.6	4.8	4.9	5.1
Limestone, cinders or unexpanded slag	1.9	2.3	2.7	3.1	3.4	3.7	4.0	4.3	4.5	4.8	5.0	5.2	5.5	5.7	5.9
Calcareous or siliceous gravel	2.0	2.4	2.8	3.2	3.6	3.9	4.2	4.5	4.8	5.0	5.3	5.5	5.8	6.0	6.2

For SI: 1 inch = 25.4 mm.

- a. Values between those shown in the table can be determined by direct interpolation.
- b. Where combustible members are framed into the wall, the thickness of solid material between the end of each member and the opposite face of the wall, or between members set in from opposite sides, shall be not [be] less than 93 percent of the thickness shown in the table.
- c. Requirements of ASTM C 55, ASTM C 73, ASTM C 90 or ASTM C 744 shall apply.
- d. Minimum required equivalent thickness corresponding to the hourly fire-resistance rating for units with a combination of aggregate shall be determined by linear interpolation based on the percent by volume of each aggregate used in manufacture.

[721.3.2.1] 722.3.2.1 Finish on nonfire-exposed side. Where plaster or gypsum wallboard is applied to the side of the wall not exposed to fire, the contribution of the finish to the total fire-resistance rating shall be determined as follows: The thickness of gypsum wallboard or plaster shall be corrected by multiplying the actual thickness of the finish by applicable factor determined from Table [721.2.1.4(1)] 722.2.1.4(1). This corrected thickness of finish shall be added to the equivalent thickness of masonry and the fire-resistance rating of the masonry and finish determined from Table [721.3.2] 722.3.2.

[721.3.2.2] 722.3.2.2 Finish on fire-exposed side. Where plaster or gypsum wallboard is applied to the fire-exposed side of the wall, the contribution of the finish to the total fire-resistance rating shall be determined as follows: The time assigned to the finish as established by Table [721.2.1.4(2)] 722.2.1.4(2) shall be added to the fire-resistance rating determined in Section [721.3.2] 722.3.2 for the masonry alone, or in Section [721.3.2.1] 722.3.2.1 for the masonry and finish on the nonfire-exposed side.

[721.3.2.3] 722.3.2.3 Nonsymmetrical assemblies. For a wall having no finish on one side or having different types or thicknesses of finish on each side, the calculation procedures of this section shall be performed twice, assuming either side of the wall to be the fire-exposed side. The fire-resistance rating of the wall shall not exceed the lower of the two values calculated.

Exception: For exterior walls with a fire separation distance greater than 5 feet (1524 mm), the fire shall be assumed to occur on the interior side only.

[721.3.2.4] 722.3.2.4 Minimum concrete masonry fire-resistance rating. Where the finish applied to a concrete masonry wall contributes to its fire-resistance rating, the masonry alone shall provide not less than one-half the total required fire-resistance rating.

[721.3.2.5] 722.3.2.5 Attachment of finishes. Installation of finishes shall be as follows:

1. Gypsum wallboard and gypsum lath applied to concrete masonry or concrete walls shall be secured to wood or steel furring members spaced not more than 16 inches ([406] 406.4 mm) on center (o.c.).

2. Gypsum wallboard shall be installed with the long dimension parallel to the furring members and shall have all joints finished.
3. Other aspects of the installation of finishes shall comply with the applicable provisions of Chapters 7 and 25.

[721.3.3] 722.3.3 Multi-wythe masonry walls. The fire-resistance rating of wall assemblies constructed of multiple wythes of masonry materials shall be permitted to be based on the fire-resistance rating period of each wythe and the continuous airspace between each wythe in accordance with the following formula:

$$R_A = (R_1^{0.59} + R_s^{0.59} + \dots + R_n^{0.59} + A_1 + A_2 + \dots + A_n)^{1.7} \quad \text{(Equation 7-7)}$$

where:

R_A = Fire ~~[endurance]~~-resistance rating of the assembly (hours).

R_1, R_2, \dots, R_n = Fire ~~[endurance]~~-resistance rating of wythes for 1, 2, n (hours), respectively.

A_1, A_2, \dots, A_n = 0.30, factor for each continuous airspace for 1, 2, ...n, respectively, having a depth of 1/2 inch (12.7 mm) or more between wythes.

[721.3.4] 722.3.4 Concrete masonry lintels. Fire-resistance ratings for concrete masonry lintels shall be determined based upon the nominal thickness of the lintel and the minimum thickness of concrete masonry or concrete, or any combination thereof, covering the main reinforcing bars, as determined ~~[according to]~~ in accordance with Table [721.3.4] 722.3.4, or by approved alternate methods.

**TABLE [721.3.4] 722.3.4
MINIMUM COVER OF LONGITUDINAL
REINFORCEMENT IN FIRE-RESISTANCE-RATED
REINFORCED CONCRETE MASONRY LINTELS (inches)**

NOMINAL WIDTH OF LINTEL (inches)	FIRE-RESISTANCE RATING (hours)			
	1	2	3	4
6	1½	2	—	—
8	1½	1½	1¾	3
10 or greater	1½	1½	1½	1¾

For SI: 1 inch = 25.4 mm.

[721.3.5] 722.3.5 Concrete masonry columns. The fire-resistance rating of concrete masonry columns shall be determined based upon the least plan dimension of the column in accordance with Table [721.3.5] 722.3.5 or by approved alternate methods.

**TABLE [721.3.5] 722.3.5
MINIMUM DIMENSION OF
CONCRETE MASONRY COLUMNS (inches)**

FIRE-RESISTANCE RATING (hours)			
1	2	3	4
8 inches	10 inches	12 inches	14 inches

For SI: 1 inch = 25.4 mm.

[721.4] 722.4 Clay brick and tile masonry. The provisions of this section contain procedures by which the fire-resistance ratings of clay brick and tile masonry are established by calculations.

[721.4.1] 722.4.1 Masonry walls. The fire-resistance rating of masonry walls shall be based upon the equivalent thickness as calculated in accordance with this section. The calculation shall take into account finishes applied to the wall and airspaces between wythes in multiwythe construction.

**TABLE [721.4.1(1)] 722.4.1(1)
FIRE-RESISTANCE PERIODS OF CLAY MASONRY WALLS**

MATERIAL TYPE	MINIMUM REQUIRED EQUIVALENT THICKNESS FOR FIRE RESISTANCE ^{a,b,c} (inches)			
	1 hour	2 [hour] hours	3 [hour] hours	4 [hour] hours
Solid brick of clay or shale ^d	2.7	3.8	4.9	6.0
Hollow brick or tile of clay or shale, unfilled	2.3	3.4	4.3	5.0
Hollow brick or tile of clay or shale, grouted or filled with materials specified in Section [721.4.1.1.3] 722.4.1.1.3	3.0	4.4	5.5	6.6

For SI: 1 inch = 25.4 mm.

- a. Equivalent thickness as determined from Section [721.4.1.1] 722.4.1.1.
- b. Calculated fire resistance between the hourly increments listed shall be determined by linear interpolation.
- c. Where combustible members are framed in the wall, the thickness of solid material between the end of each member and the opposite face of the wall, or between members set in from opposite sides, shall be not [be] less than 93 percent of the thickness shown.
- d. For units in which the net cross-sectional area of cored brick in any plane parallel to the surface containing the cores is at least 75 percent of the gross cross-sectional area measured in the same plane.

**TABLE [721.4.1(2)] 722.4.1(2)
FIRE-RESISTANCE RATINGS FOR BEARING STEEL FRAME
BRICK VENEER WALLS OR PARTITIONS**

WALL OR PARTITION ASSEMBLY	PLASTER SIDE EXPOSED (hours)	BRICK FACED SIDE EXPOSED (hours)
Outside facing of steel studs: $\frac{1}{2}$ " wood fiberboard sheathing next to studs, $\frac{3}{4}$ " airspace formed with $\frac{3}{4}$ " \times $1\frac{5}{8}$ " wood strips placed over the fiberboard and secured to the studs; metal or wire lath nailed to such strips, $3\frac{3}{4}$ " brick veneer held in place by filling $\frac{3}{4}$ " airspace between the brick and lath with mortar. Inside facing of studs: $\frac{3}{4}$ " unsanded gypsum plaster on metal or wire lath attached to $\frac{5}{16}$ " wood strips secured to edges of the studs.	1.5	4
Outside facing of steel studs: 1" insulation board sheathing attached to studs, 1" airspace, and $3\frac{3}{4}$ " brick veneer attached to steel frame with metal ties every 5th course. Inside facing of studs: $\frac{7}{8}$ " sanded gypsum plaster (1:2 mix) applied on metal or wire lath attached directly to the studs.	1.5	4
Same as above except use $\frac{7}{8}$ " vermiculite—gypsum plaster or 1" sanded gypsum plaster (1:2 mix) applied to metal or wire.	2	4
Outside facing of steel studs: $\frac{1}{2}$ " gypsum sheathing board, attached to studs, and $3\frac{3}{4}$ " brick veneer attached to steel frame with metal ties every 5th course. Inside facing of studs: $\frac{1}{2}$ " sanded gypsum plaster (1:2 mix) applied to $\frac{1}{2}$ " perforated gypsum lath securely attached to studs and having strips of metal lath 3 inches wide applied to all horizontal joints of gypsum lath.	2	4

For SI: 1 inch = 25.4 mm.

**TABLE [721.4.1(3)] 722.4.1(3)
VALUES OF $R_n^{0.59}$**

$R_n^{0.59}$	R (hours)
1	1.0
2	1.50

TABLE [721.4.1(3)] 722.4.1(3)
VALUES OF $R_n^{0.59}$

$R_n^{0.59}$	R (hours)
3	1.91
4	2.27

TABLE [721.4.1(4)] 722.4.1(4)
COEFFICIENTS FOR PLASTER, pl^a

THICKNESS OF PLASTER (inch)	ONE SIDE	TWO SIDE SIDES
1/2	0.3	0.6
5/8	0.37	0.75
3/4	0.45	0.90

For SI: 1 inch = 25.4 mm.

a. Values listed in the table are for 1:3 sanded gypsum plaster.

TABLE [721.4.1(5)] 722.4.1(5)
REINFORCED MASONRY LINTELS

NOMINAL LINTEL WIDTH (inches)	MINIMUM LONGITUDINAL REINFORCEMENT COVER FOR FIRE RESISTANCE ((inch) inches)			
	1 hour	2 hour hours	3 hour hours	4 hour hours
6	1 1/2	2	NP	NP
8	1 1/2	1 1/2	1 3/4	3
10 or more	1 1/2	1 1/2	1 1/2	1 3/4

For SI: 1 inch = 25.4 mm.

NP = Not permitted.

TABLE [721.4.1(6)] 722.4.1(6)
REINFORCED CLAY MASONRY

COLUMN SIZE	FIRE-RESISTANCE RATING ((hour) hours)			
	1	2	3	4
Minimum column dimension (inches)	8	10	12	14

For SI: 1 inch = 25.4 mm.

[721.4.1.1] 722.4.1.1 Equivalent thickness. The fire-resistance ratings of walls or partitions constructed of solid or hollow clay masonry units shall be determined from Table [721.4.1(1)] 722.4.1(1) or [721.4.1(2)] 722.4.1(2). The equivalent thickness of the clay masonry unit shall be determined by Equation 7-8 ~~when~~ where using Table [721.4.1(1)] 722.4.1(1). The fire-resistance rating determined from Table [721.4.1(1)] 722.4.1(1) shall be permitted to be used in the calculated fire-resistance rating procedure in Section [721.4.2] 722.4.2.

$$T_e = V_n/LH \quad \text{(Equation 7-8)}$$

where:

T_e = The equivalent thickness of the clay masonry unit (inches).

- V_n = The net volume of the clay masonry unit (inch³).
- L = The specified length of the clay masonry unit (inches).
- H = The specified height of the clay masonry unit (inches).

[721.4.1.1.1] 722.4.1.1.1 Hollow clay units. The equivalent thickness, T_e , shall be the value obtained for hollow clay units as determined in accordance with Equation 7-8. The net volume, V_n , of the units shall be determined using the gross volume and percentage of void area determined in accordance with ASTM C 67.

[721.4.1.1.2] 722.4.1.1.2 Solid grouted clay units. The equivalent thickness of solid grouted clay masonry units shall be taken as the actual thickness of the units.

[721.4.1.1.3] 722.4.1.1.3 Units with filled cores. The equivalent thickness of the hollow clay masonry units is the actual thickness of the unit ~~when~~ where completely filled with loose-fill materials of: sand, pea gravel, crushed stone, or slag that meet ASTM C 33 requirements; pumice, scoria, expanded shale, expanded clay, expanded slate, expanded slag, expanded fly ash, or cinders in compliance with ASTM C 331; or perlite or vermiculite meeting the requirements of ASTM C 549 and ASTM C 516, respectively.

[721.4.1.2] 722.4.1.2 Plaster finishes. Where plaster is applied to the wall, the total fire-resistance rating shall be determined by the formula:

$$R = (R_n^{0.59} + pl)^{1.7} \quad \text{(Equation 7-9)}$$

where:

R = The fire~~-endurance~~-resistance of the assembly (hours).

R_n = The fire~~-endurance~~-resistance of the individual wall (hours).

pl = Coefficient for thickness of plaster.

Values for $R_n^{0.59}$ for use in Equation 7-9 are given in Table ~~[721.4.1(3)]~~ 722.4.1(3). Coefficients for thickness of plaster shall be selected from Table ~~[721.4.1(4)]~~ 722.4.1(4) based on the actual thickness of plaster applied to the wall or partition and whether one or two sides of the wall are plastered.

[721.4.1.3] 722.4.1.3 Multi-wythe walls with airspace. Where a continuous airspace separates multiple wythes of the wall or partition, the total fire-resistance rating shall be determined by the formula:

$$R = (R_1^{0.59} + R_2^{0.59} + \dots + R_n^{0.59} + as)^{1.7} \quad \text{(Equation 7-10)}$$

where:

R = The fire~~-endurance~~-resistance of the assembly (hours).

R_1, R_2 and R_n = The fire~~-endurance~~-resistance of the individual wythes (hours).

as = Coefficient for continuous airspace.

Values for $R_n^{0.59}$ for use in Equation 7-10 are given in Table [721.4.1(3)] 722.4.1(3). The coefficient for each continuous airspace of 1/2 inch to 3 1/2 inches (12.7 to 89 mm) separating two individual wythes shall be 0.3.

[721.4.1.4] **722.4.1.4 Nonsymmetrical assemblies.** For a wall having no finish on one side or having different types or thicknesses of finish on each side, the calculation procedures of this section shall be performed twice, assuming either side to be the fire-exposed side of the wall. The fire resistance of the wall shall not exceed the lower of the two values determined.

Exception: For exterior walls with a fire separation distance greater than 5 feet (1524 mm), the fire shall be assumed to occur on the interior side only.

[721.4.2] **722.4.2 Multi-wythe walls.** The fire-resistance rating for walls or partitions consisting of two or more dissimilar wythes shall be permitted to be determined by the formula:

$$R = (R_1^{0.59} + R_2^{0.59} + \dots + R_n^{0.59})^{1.7} \quad \text{(Equation 7-11)}$$

where:

$R =$ The fire[~~endurance~~]-resistance of the assembly (hours).

R_1, R_2 and $R_n =$ The fire[~~endurance~~]-resistance of the individual wythes (hours).

Values for $R_n^{0.59}$ for use in Equation 7-11 are given in Table [721.4.1(3)] 722.4.1(3).

[721.4.2.1] **722.4.2.1 Multi-wythe walls of different material.** For walls that consist of two or more wythes of different materials (concrete or concrete masonry units) in combination with clay masonry units, the fire-resistance rating of the different materials shall be permitted to be determined from Table [721.2.1.1] 722.2.1.1 for concrete; Table [721.3.2] 722.3.2 for concrete masonry units or Table [721.4.1(1)] 722.4.1(1) or [721.4.1(2)] 722.4.1(2) for clay and tile masonry units.

[721.4.3] **722.4.3 Reinforced clay masonry lintels.** Fire-resistance ratings for clay masonry lintels shall be determined based on the nominal width of the lintel and the minimum covering for the longitudinal reinforcement in accordance with Table [721.4.1(5)] 722.4.1(5).

[721.4.4] **722.4.4 Reinforced clay masonry columns.** The fire-resistance ratings shall be determined based on the last plan dimension of the column in accordance with Table [721.4.1(6)] 722.4.1(6). The minimum cover for longitudinal reinforcement shall be 2 inches ([54] 50.8 mm).

[721.5] **722.5 Steel assemblies.** The provisions of this section contain procedures by which the fire-resistance ratings of steel assemblies are established by calculations.

[721.5.1] **722.5.1 Structural steel columns.** The fire-resistance ratings of structural steel columns shall be based on the size of the element and the type of protection provided in accordance with this section.

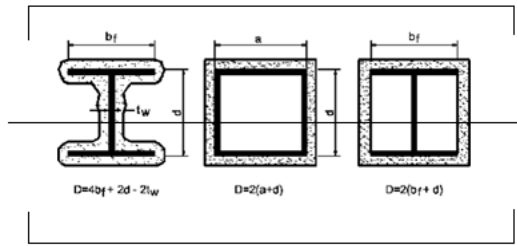

FIGURE 721.5.1(1)
DETERMINATION OF THE HEATED PERIMETER
OF STRUCTURAL STEEL COLUMNS

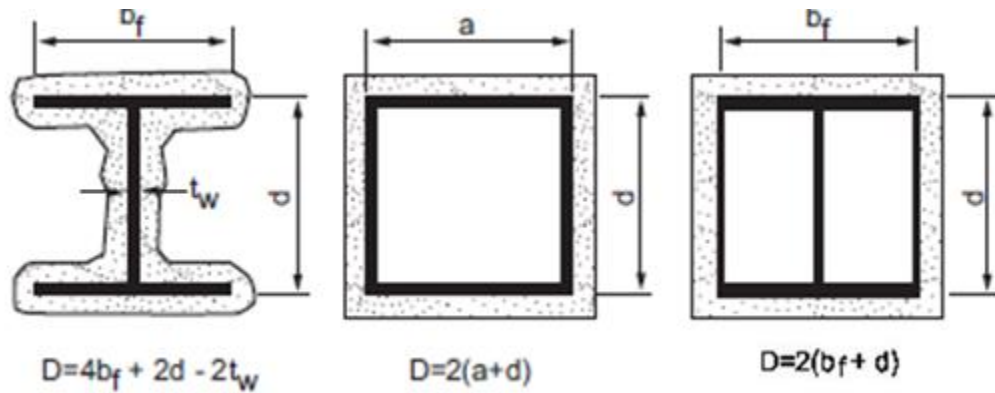

FIGURE 722.5.1(1)
DETERMINATION OF THE HEATED PERIMETER
OF STRUCTURAL STEEL COLUMNS

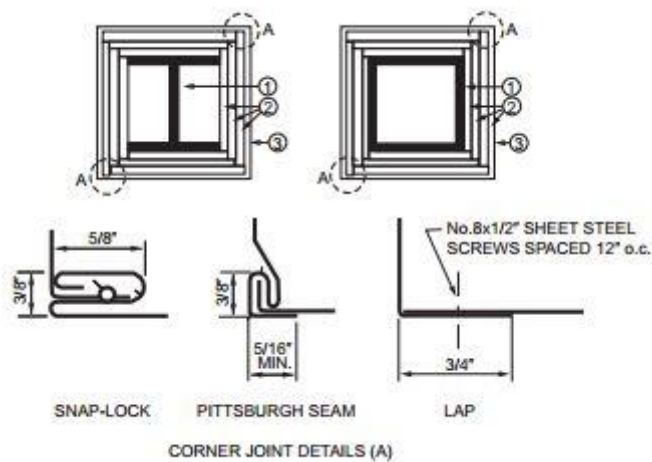

FIGURE [721.5.1(2)] 722.5.1(2)
[GYPSUM WALLBOARD PROTECTED] GYPSUM-PROTECTED STRUCTURAL
STEEL
COLUMNS WITH SHEET STEEL COLUMN COVERS

For SI: 1 inch = 25.4 mm, 1 foot = 305 mm.

1. Structural steel column, either wide flange or tubular shapes.
2. Type X gypsum [wallboard] board or gypsum panel products in accordance with ASTM C [36. For single-layer applications, the wallboard] 1177, C 1178, C 1278, C 1396 or C 1658. The total thickness of gypsum board or gypsum panel products calculated as h in Section 722.5.1.2 shall be applied vertically to an individual column using one of the following methods:
 1. As a single layer with no horizontal joints.
 2. [For] As multiple [-layer applications,] layers with no horizontal joints [are] permitted [at a minimum spacing of 8 feet, provided that the] in any layer.
 3. As multiple layers with horizontal joints [in successive layers] are staggered [at least] not less than 12 inches[-] vertically between layers and not less than 8 feet vertically in any single layer. The total required thickness of [wallboard] gypsum board or gypsum panel products shall be determined on the basis of the specified fire-resistance rating and the weight-to-heated-perimeter ratio (W/D) of the column. For fire-resistance ratings of 2 hours or less, one of the required layers of gypsum [wallboard] board or gypsum panel product may be applied to the exterior of the sheet steel column covers with 1-inch long Type S screws spaced 1 inch from the wallboard edge and 8 inches on center. For such installations, 0.0149-inch minimum thickness galvanized steel corner beads with 1 1/2-inch legs shall be attached to the wallboard with Type S screws spaced 12 inches on center.
3. For fire-resistance ratings of 3 hours or less, the column covers shall be fabricated from 0.0239-inch minimum thickness galvanized or stainless steel. For 4-hour fire-resistance ratings, the column covers shall be fabricated from 0.0239-inch minimum thickness stainless steel. The column covers shall be erected with the Snap Lock or Pittsburgh joint details.

For fire-resistance ratings of 2 hours or less, column covers fabricated from 0.0269-inch minimum thickness galvanized or stainless steel shall be permitted to be erected with lap joints. The lap joints shall be permitted to be located anywhere around the perimeter of the column cover. The lap joints shall be secured with 1/2-inch-long No.8 sheet metal screws spaced 12 inches on center.

The column covers shall be provided with a minimum expansion clearance of 1/8 inch per linear foot between the ends of the cover and any restraining construction.

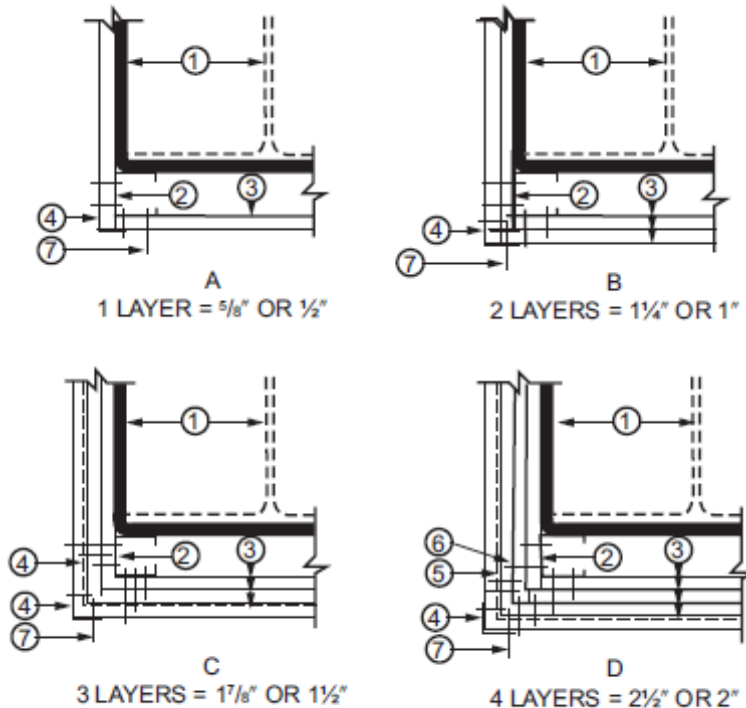

FIGURE [721.5.1(3)] 722.5.1(3)
[GYPSUM WALLBOARD PROTECTED] GYPSUM-PROTECTED STRUCTURAL STEEL
COLUMNS WITH STEEL STUD/SCREW ATTACHMENT SYSTEM

For SI: 1 inch = 25.4 mm, 1 foot = 305 mm.

1. Structural steel column, either wide flange or tubular shapes.
2. 1⁵/₈-inch deep studs fabricated from 0.0179-inch minimum thickness galvanized steel with 1⁵/₁₆ or 1⁷/₁₆-inch legs. The length of the steel studs shall be 1/2 inch less than the height of the assembly.
3. Type X gypsum [wallboard] board or gypsum panel products in accordance with ASTM [C 36. For single layer applications, the wallboard] C 177, C 1178, C 1278, C 1396 or C 1658. The total thickness of gypsum board or gypsum panel products calculated as h in Section 722.5.1.2 shall be applied vertically to an individual column using one of the following methods:
 1. As a single layer with no horizontal joints.
 2. [For] As multiple [-layer applications:] layer with no horizontal joints [are] permitted [at a minimum spacing of 8 feet, provided that the] in any layer.
 3. As multiple layers with horizontal joints [in successive layers are] staggered [at least] not less than 12 inches vertically between layers and not less than 8 feet vertically in any single layer. The total required thickness of [wallboard] gypsum board or gypsum panel products shall be determined on the basis of the specified fire-resistance rating and the weight-to-heated-perimeter ratio (W/D) of the column.
4. Galvanized 0.0149-inch minimum thickness steel corner beads with 1¹/₂-inch legs attached to the [wallboard] gypsum board or gypsum panel products with 1-inch-long Type S screws spaced 12 inches on center.
5. No. 18 SWG steel tie wires spaced 24 inches on center.
6. Sheet metal angles with 2-inch legs fabricated from 0.0221-inch minimum thickness galvanized steel.
7. Type S screws, 1 inch long, shall be used for attaching the first layer of [wallboard] gypsum board or gypsum panel product to the steel studs and the third layer to the sheet metal angles at 24 inches on center. Type S screws 1³/₄-inch long shall be used for attaching the second layer of [wallboard] gypsum board or gypsum panel product to the steel studs and the fourth layer to the sheet metal angles at 12 inches on center. Type S screws 2¹/₄ inches long shall be used for attaching the third layer of [wallboard] gypsum board or gypsum panel product to the steel studs at 12 inches on center.

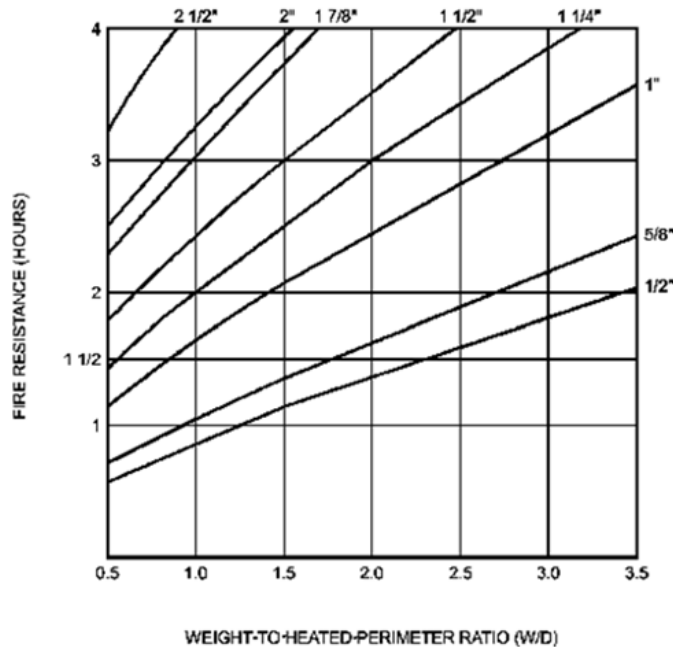

FIGURE [721.5.1(4)] 722.5.1(4)
FIRE RESISTANCE OF STRUCTURAL STEEL COLUMNS
PROTECTED WITH VARIOUS THICKNESSES OF
TYPE X GYPSUM WALLBOARD^a

For SI: 1 inch = 25.4 mm, 1 pound per linear foot/inch = 0.059 kg/m/mm.

- a. The W/D ratios for typical wide flange columns are listed in Table [721.5.1(4)] 722.5.1(1). For other column shapes, the W/D ratios shall be determined in accordance with Section [720.5.1.1] 722.5.1.1.

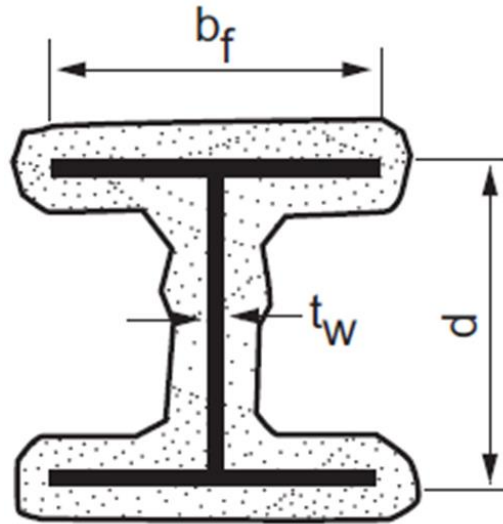

FIGURE [721.5.1(5)] 722.5.1(5)
WIDE FLANGE STRUCTURAL STEEL COLUMNS WITH
SPRAY-APPLIED FIRE-RESISTANT MATERIALS

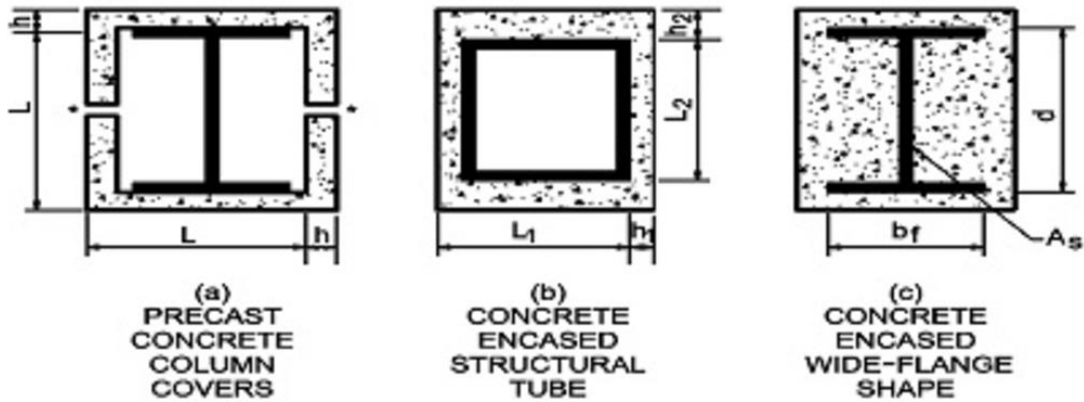
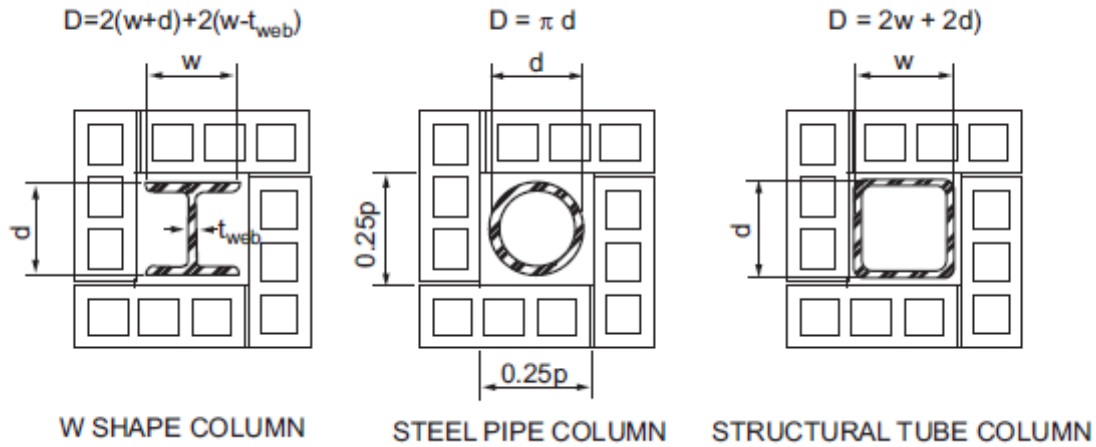

FIGURE [721.5.1(6)] 722.5.1(6)
CONCRETE PROTECTED STRUCTURAL STEEL COLUMNS^{a,b}

- a. When the inside perimeter of the concrete protection is not square, L shall be taken as the average of L₁ and L₂. When the thickness of concrete cover is not constant, h shall be taken as the average of h₁ and h₂.
- b. Joints shall be protected with a minimum 1 inch thickness of ceramic fiber blanket but in no case less than one-half the thickness of the column cover (see Section [721.2.1.3] 722.2.1.3).



For SI: 1 inch = 25.4 mm.

FIGURE [721.5.1(7)] 722.5.1(7)
CONCRETE OR CLAY MASONRY PROTECTED STRUCTURAL STEEL COLUMNS

d = Depth of a wide flange column, outside diameter of pipe column, or outside dimension of structural tubing column (inches).

t_{web} = Thickness of web of wide flange column (inches).

w = Width of flange of wide flange column (inches).

TABLE [721.5.1(4)] 722.5.1(1)
W/D RATIOS FOR STEEL COLUMNS

STRUCTURAL SHAPE	CONTOUR PROFILE	BOX PROFILE	STRUCTURAL SHAPE	CONTOUR PROFILE	BOX PROFILE
W14 × 233	[2.49] 2.55	3.65	W10 × 112	[1.78] 1.81	2.57
× 211	[2.28] 2.32	3.35	× 100	[1.61] 1.64	2.33
× 193	[2.10] 2.14	3.09	× 88	[1.43] 1.45	2.08
× 176	[1.93] 1.96	2.85	× 77	[1.26] 1.28	1.85
× 159	[1.75] 1.78	2.60	× 68	[1.13] 1.15	1.66
× 145	[1.61] 1.64	2.39	× 60	[1.00] 1.01	1.48
× 132	[1.52] 1.56	2.25	× 54	[0.91] 0.922	1.34
× 120	[1.39] 1.42	2.06	× 49	[0.83] 0.84	1.23
× 109	[1.27] 1.29	1.88	× 45	[0.87] 0.888	1.24
× 99	[1.16] 1.18	1.72	× 39	[0.76] 0.78	1.09
× 90	[1.06] 1.08	1.58	× 33	[0.65] 0.661	0.93
× 82	[1.20] 1.23	1.68			
× 74	[1.09] 1.12	1.53	W8 × 67	[1.34] 1.37	1.94

TABLE [721.5.1(1)] 722.5.1(1)
W/D RATIOS FOR STEEL COLUMNS

STRUCTURAL SHAPE	CONTOUR PROFILE	BOX PROFILE	STRUCTURAL SHAPE	CONTOUR PROFILE	BOX PROFILE
× 68	[1.04] <u>1.04</u>	1.41	× 58	[1.18] <u>1.20</u>	1.71
× 61	[0.91] <u>0.928</u>	1.28	× 48	[0.99] <u>1.00</u>	1.44
× 53	[0.89] <u>0.915</u>	1.21	× 40	[0.83] <u>0.849</u>	1.23
× 48	[0.81] <u>0.835</u>	1.10	× 35	[0.73] <u>0.749</u>	1.08
× 43	[0.73] <u>0.752</u>	0.99	× 31	[0.65] <u>0.665</u>	0.97
			× 28	[0.67] <u>0.688</u>	0.96
W12 × 190	[2.46] <u>2.50</u>	3.51	× 24	[0.58] <u>0.591</u>	0.83
× 170	[2.22] <u>2.26</u>	3.20	× 21	[0.57] <u>0.577</u>	0.77
× 152	[2.01] <u>2.04</u>	2.90	× 18	[0.49] <u>0.499</u>	0.67
× 136	[1.82] <u>1.86</u>	2.63			
× 120	[1.62] <u>1.65</u>	2.36	W6 × 25	[0.69] <u>0.696</u>	1.00
× 106	[1.44] <u>1.47</u>	2.11	× 20	[0.56] <u>0.563</u>	0.82
× 96	[1.32] <u>1.34</u>	1.93	× 16	[0.57] <u>0.583</u>	0.78
× 87	[1.20] <u>1.22</u>	1.76	× 15	[0.42] <u>0.431</u>	0.63
× 79	[1.10] <u>1.11</u>	1.61	× 12	[0.43] <u>0.448</u>	0.60
× 72	[1.00] <u>1.02</u>	1.48	× 9	[0.33] <u>0.338</u>	0.46
× 65	[0.91] <u>0.925</u>	1.35			
× 58	[0.91] <u>0.925</u>	1.31	W5 × 19	[0.64] <u>0.644</u>	0.93
× 53	[0.84] <u>0.855</u>	1.20	× 16	[0.54] <u>0.55</u>	0.80
× 50	[0.89] <u>0.909</u>	1.23			
× 45	[0.81] <u>0.829</u>	1.12	W4 × 13	[0.54] <u>0.556</u>	0.79
× 40	[0.72] <u>0.734</u>	1.00			

For SI: 1 pound per linear foot per inch = 0.059 kg/m/mm.

TABLE [721.5.1(2)] 722.5.1(2)
PROPERTIES OF CONCRETE

PROPERTY	NORMAL WEIGHT CONCRETE	STRUCTURAL LIGHTWEIGHT CONCRETE
Thermal conductivity (k_c)	0.95 Btu/hr \cdot ft \cdot °F	0.35 Btu/hr \cdot ft \cdot °F
Specific heat (c_c)	0.20 Btu/lb °F	0.20 Btu/lb °F
Density (P_c)	145 lb/ft ³	110 lb/ft ³
Equilibrium (free) moisture content (m) by volume	4 %	5 %

For SI: 1 inch = 25.4 mm, 1 foot = 304.8 mm, 1 lb/ft³ = 16.0185 kg/m³, Btu/hr \cdot ft \cdot °F = 1.731 W/(m \cdot K)

TABLE [721.5.1(3)] 722.5.1(3)
THERMAL CONDUCTIVITY OF CONCRETE OR CLAY MASONRY UNITS

DENSITY (d _m) OF UNITS (lb/ft ³)	THERMAL CONDUCTIVITY (K) OF UNITS (Btu/hr • ft • °F)
Concrete Masonry Units	
80	0.207
85	0.228
90	0.252
95	0.278
100	0.308
105	0.340
110	0.376
115	0.416
120	0.459
125	0.508
130	0.561
135	0.620
140	0.685
145	0.758
150	0.837
Clay Masonry Units	
120	1.25
130	2.25

For SI: 1 pound per cubic foot = 16.0185 kg/m³, Btu [~~per hour foot~~]/hr • ft • °F = 1.731 W/(m • K).

TABLE [721.5.1(4)] 722.5.1(4)
WEIGHT-TO-HEATED-PERIMETER RATIOS (W/D) FOR TYPICAL WIDE FLANGE BEAM AND GIRDER SHAPES

STRUCTURAL SHAPE	CONTOUR PROFILE	BOX PROFILE	STRUCTURAL SHAPE	CONTOUR PROFILE	BOX PROFILE
W36 × 300	[2.47] 2.50	3.33	W24 × 68	[0.92] 0.942	1.21
× 280	[2.34] 2.35	3.12	× 62	[0.92] 0.934	1.14
× 260	[2.16] 2.18	2.92	× 55	[0.82] 0.828	1.02
× 245	[2.04] 2.08	2.76			
× 230	[1.92] 1.95	2.61	W21 × 147	[1.83] 1.87	2.60
× 210	[1.94] 1.96	2.45	× 132	[1.66] 1.68	2.35
× 194	[1.80] 1.81	2.28	× 122	[1.54] 1.57	2.19
× 182	[1.69] 1.72	2.15	× 111	[1.44] 1.43	2.01
× 170	[1.59] 1.60	2.01	× 101	[1.29] 1.30	1.84
× 160	[1.50] 1.51	1.90	× 93	[1.38] 1.40	1.80
× 150	[1.44] 1.43	1.79	× 83	[1.24] 1.26	1.62
× 135	[1.28] 1.29	1.63	× 73	[1.10] 1.11	1.44
			× 68	[1.03] 1.04	1.35
W33 × 241	[2.11] 2.13	2.86	W21 × 62	[0.94] 0.952	1.23
× 221	[1.94] 1.97	2.64	× 57	[0.93] 0.952	1.17
× 201	[1.78] 1.79	2.42	× 50	[0.83] 0.838	1.04
× 152	[1.54] 1.53	1.94	× 44	[0.73] 0.746	0.92

TABLE [721.5.1(4)] 722.5.1(4)
WEIGHT-TO-HEATED-PERIMETER RATIOS (W/D) FOR TYPICAL WIDE FLANGE BEAM AND GIRDER SHAPES

STRUCTURAL SHAPE	CONTOUR PROFILE	BOX PROFILE	STRUCTURAL SHAPE	CONTOUR PROFILE	BOX PROFILE
× 141	[1.41] <u>1.43</u>	1.80			
× 130	[1.31] <u>1.32</u>	1.67	W18 × 119	[1.69] <u>1.72</u>	2.42
× 118	[1.19] <u>1.21</u>	1.53	× 106	[1.52] <u>1.55</u>	2.18
			× 97	[1.39] <u>1.42</u>	2.01
W30 × 211	[2.00] <u>2.01</u>	2.74	× 86	[1.24] <u>1.27</u>	1.80
× 191	[1.82] <u>1.85</u>	2.50	× 76	[1.11] <u>1.13</u>	1.60
× 173	1.66	2.28	× 71	[1.21] <u>1.22</u>	1.59
× 132	[1.45] <u>1.47</u>	1.85	× 65	[1.11] <u>1.13</u>	1.47
× 124	[1.37] <u>1.39</u>	1.75	× 60	[1.03] <u>1.04</u>	1.36
× 116	[1.28] <u>1.30</u>	1.65	× 55	[0.95] <u>0.963</u>	1.26
× 108	[1.20] <u>1.21</u>	1.54	× 50	[0.87] <u>0.88</u>	1.15
× 99	[1.10] <u>1.12</u>	1.42	× 46	[0.86] <u>0.878</u>	1.09
			× 40	[0.75] <u>0.768</u>	0.96
W27 × 178	[1.85] <u>1.87</u>	2.55	× 35	[0.66] <u>0.672</u>	0.85
× 161	[1.68] <u>1.70</u>	2.33			
× 146	[1.53] <u>1.55</u>	2.12	W16 × 100	[1.56] <u>1.59</u>	2.25
× 114	[1.36] <u>1.39</u>	1.76	× 89	[1.40] <u>1.43</u>	2.03
× 102	[1.23] <u>1.24</u>	1.59	× 77	[1.22] <u>1.25</u>	1.78
× 94	[1.13] <u>1.15</u>	1.47	× 67	[1.07] <u>1.09</u>	1.56
× 84	[1.02] <u>1.03</u>	1.33	× 57	[1.07] <u>1.09</u>	1.43
			× 50	[0.94] <u>0.962</u>	1.26
			× 45	[0.85] <u>0.870</u>	1.15
W24 × 162	[1.85] <u>1.88</u>	2.57	× 40	[0.76] <u>0.780</u>	1.03
× 146	[1.68] <u>1.70</u>	2.34	× 36	[0.69] <u>0.702</u>	0.93
× 131	[1.52] <u>1.54</u>	2.12	× 31	[0.65] <u>0.661</u>	0.83
× 117	[1.36] <u>1.38</u>	1.91	× 26	[0.55] <u>0.558</u>	0.70
× 104	[1.22] <u>1.24</u>	1.71			
× 94	[1.26] <u>1.28</u>	1.63	W14 × 132	[1.83] <u>1.89</u>	3.00
× 84	[1.13] <u>1.15</u>	1.47	× 120	[1.67] <u>1.71</u>	2.75
× 76	[1.03] <u>1.05</u>	1.34	× 109	[1.53] <u>1.57</u>	2.52
W14 × 99	[1.39] <u>1.43</u>	2.31	W10 × 30	[0.79] <u>0.806</u>	1.12
× 90	[1.27] <u>1.31</u>	2.11	× 26	[0.69] <u>1.708</u>	0.98
× 82	[1.41] <u>1.45</u>	2.12	× 22	[0.59] <u>0.606</u>	0.84
× 74	[1.28] <u>1.32</u>	1.93	× 19	[0.59] <u>0.607</u>	0.78
× 68	[1.19] <u>1.22</u>	1.78	× 17	[0.54] <u>0.543</u>	0.70
× 61	[1.07] <u>1.10</u>	1.61	× 15	[0.48] <u>0.484</u>	0.63
× 53	[1.03] <u>1.06</u>	1.48	× 12	[0.38] <u>0.392</u>	0.51
× 48	[0.94] <u>0.970</u>	1.35			
W14 × 43	[0.85] <u>0.874</u>	1.22	W8 × 67	[1.61] <u>1.65</u>	2.55
× 38	[0.79] <u>0.809</u>	1.09	× 58	[1.41] <u>1.44</u>	2.26
× 34	[0.71] <u>0.725</u>	0.98	× 48	[1.18] <u>1.21</u>	1.91
× 30	[0.63] <u>0.644</u>	0.87	× 40	[1.00] <u>1.03</u>	1.63
× 26	[0.61] <u>0.628</u>	0.79	× 35	[0.88] <u>0.907</u>	1.44
× 22	[0.52] <u>0.534</u>	0.68	× 31	[0.79] <u>0.803</u>	1.29
			× 28	[0.80] <u>0.819</u>	1.24

TABLE [721.5.1(4)] 722.5.1(4)
WEIGHT-TO-HEATED-PERIMETER RATIOS (W/D) FOR TYPICAL WIDE FLANGE BEAM AND GIRDER SHAPES

STRUCTURAL SHAPE	CONTOUR PROFILE	BOX PROFILE	STRUCTURAL SHAPE	CONTOUR PROFILE	BOX PROFILE
W12 × 87	[1.44] <u>1.47</u>	2.34	× 24	[0.69] <u>0.704</u>	1.07
× 79	[1.32] <u>1.34</u>	2.14	× 21	[0.66] <u>0.675</u>	0.96
× 72	[1.20] <u>1.23</u>	1.97	× 18	[0.57] <u>0.583</u>	0.84
× 65	[1.09] <u>1.11</u>	1.79	× 15	[0.54] <u>0.551</u>	0.74
× 58	[1.08] <u>1.10</u>	1.69	× 13	[0.47] <u>0.483</u>	0.65
× 53	[0.99] <u>1.02</u>	1.55	× 10	[0.37] <u>0.375</u>	0.51
× 50	[1.04] <u>1.06</u>	1.54			
× 45	[0.95] <u>0.974</u>	1.40	W6 × 25	[0.82] <u>0.839</u>	1.33
× 40	[0.85] <u>0.860</u>	1.25	× 20	[0.67] <u>0.678</u>	1.09
× 35	[0.79] <u>0.810</u>	1.11	× 16	[0.66] <u>0.684</u>	0.96
× 30	[0.69] <u>0.699</u>	0.96	× 15	[0.54] <u>0.521</u>	0.83
× 26	[0.60] <u>0.612</u>	0.84	× 12	[0.54] <u>0.526</u>	0.75
× 22	[0.64] <u>0.623</u>	0.77	× 9	[0.39] <u>0.398</u>	0.57
× 19	[0.53] <u>0.540</u>	0.67			
× 16	[0.45] <u>0.457</u>	0.57	W5 × 19	[0.76] <u>0.776</u>	1.24
× 14	[0.40] <u>0.405</u>	0.50	× 16	[0.65] <u>0.664</u>	1.07
W10 × 112	[2.14] <u>2.17</u>	3.38	W4 × 13	[0.65] <u>0.670</u>	1.05
× 100	[1.93] <u>1.97</u>	3.07			
× 88	[1.70] <u>1.74</u>	2.75			
× 77	[1.52] <u>1.54</u>	2.45			
× 68	[1.35] <u>1.38</u>	2.20			
× 60	[1.20] <u>1.22</u>	1.97			
× 54	[1.09] <u>1.11</u>	1.79			
× 49	[0.99] <u>1.01</u>	1.64			
× 45	[1.03] <u>1.06</u>	1.59			
× 39	0.94	1.40			
× 33	0.77	1.20			

For SI: Pounds per linear foot per inch = 0.059 kg/m/mm.

TABLE [721.5.1(5)] 722.5.1(5)
FIRE RESISTANCE OF CONCRETE MASONRY PROTECTED STEEL COLUMNS

COLUMN SIZE	CONCRETE MASONRY DENSITY POUNDS PER CUBIC FOOT	MINIMUM REQUIRED EQUIVALENT THICKNESS FOR FIRE-RESISTANCE RATING OF CONCRETE MASONRY PROTECTION ASSEMBLY ₁ T _c (inches)				COLUMN SIZE	CONCRETE MASONRY DENSITY POUNDS PER CUBIC FOOT	MINIMUM REQUIRED EQUIVALENT THICKNESS FOR FIRE-RESISTANCE RATING OF CONCRETE MASONRY PROTECTION ASSEMBLY ₂ T _c (inches)			
		1[-] hour	2[-hour] hours	3[-hour] hours	4[-hour] hours			1[-] hour	2[-hour] hours	3[-hour] hours	4[-hour] hours
W14 × 82	80	0.74	1.61	2.36	3.04	W10 × 68	80	0.72	1.58	2.33	3.01
	100	0.89	1.85	2.67	3.40		100	0.87	1.83	2.65	3.38
	110	0.96	1.97	2.81	3.57		110	0.94	1.95	2.79	3.55
	120	1.03	2.08	2.95	3.73		120	1.01	2.06	2.94	3.72
W14 × 68	80	0.83	1.70	2.45	3.13	W10 × 54	80	0.88	1.76	2.53	3.21
	100	0.99	1.95	2.76	3.49		100	1.04	2.01	2.83	3.57
	110	1.06	2.06	2.91	3.66		110	1.11	2.12	2.98	3.73
	120	1.14	2.18	3.05	3.82		120	1.19	2.24	3.12	3.90
W14 × 53	80	0.91	1.81	2.58	3.27	W10 × 45	80	0.92	1.83	2.60	3.30
	100	1.07	2.05	2.88	3.62		100	1.08	2.07	2.90	3.64
	110	1.15	2.17	3.02	3.78		110	1.16	2.18	3.04	3.80
	120	1.22	2.28	3.16	3.94		120	1.23	2.29	3.18	3.96
W14 × 43	80	1.01	1.93	2.71	3.41	W10 × 33	80	1.06	2.00	2.79	3.49
	100	1.17	2.17	3.00	3.74		100	1.22	2.23	3.07	3.81
	110	1.25	2.28	3.14	3.90		110	1.30	2.34	3.20	3.96
	120	1.32	2.38	3.27	4.05		120	1.37	2.44	3.33	4.12
W12 × 72	80	0.81	1.66	2.41	3.09	W8 × 40	80	0.94	1.85	2.63	3.33
	100	0.91	1.88	2.70	3.43		100	1.10	2.10	2.93	3.67
	110	0.99	1.99	2.84	3.60		110	1.18	2.21	3.07	3.83
	120	1.06	2.10	2.98	3.76		120	1.25	2.32	3.20	3.99
W12 × 58	80	0.88	1.76	2.52	3.21	W8 × 31	80	1.06	2.00	2.78	3.49
	100	1.04	2.01	2.83	3.56		100	1.22	2.23	3.07	3.81
	110	1.11	2.12	2.97	3.73		110	1.29	2.33	3.20	3.97
	120	1.19	2.23	3.11	3.89		120	1.36	2.44	3.33	4.12
W12 × 50	80	0.91	1.81	2.58	3.27	W8 × 24	80	1.14	2.09	2.89	3.59
	100	1.07	2.05	2.88	3.62		100	1.29	2.31	3.16	3.90
	110	1.15	2.17	3.02	3.78		110	1.36	2.42	3.28	4.05
	120	1.22	2.28	3.16	3.94		120	1.43	2.52	3.41	4.20
W12 × 40	80	1.01	1.94	2.72	3.41	W8 × 18	80	1.22	2.20	3.01	3.72
	100	1.17	2.17	3.01	3.75		100	1.36	2.40	3.25	4.01
	110	1.25	2.28	3.14	3.90		110	1.42	2.50	3.37	4.14
	120	1.32	2.39	3.27	4.06		120	1.48	2.59	3.49	4.28
	80	0.93	1.90	2.71	3.43		80	0.80	1.75	2.56	3.28

TABLE [721.5.1(5)] 722.5.1(5)
FIRE RESISTANCE OF CONCRETE MASONRY PROTECTED STEEL COLUMNS

COLUMN SIZE	CONCRETE MASONRY DENSITY POUNDS PER CUBIC FOOT	MINIMUM REQUIRED EQUIVALENT THICKNESS FOR FIRE-RESISTANCE RATING OF CONCRETE MASONRY PROTECTION ASSEMBLY ₁ T _c (inches)				COLUMN SIZE	CONCRETE MASONRY DENSITY POUNDS PER CUBIC FOOT	MINIMUM REQUIRED EQUIVALENT THICKNESS FOR FIRE-RESISTANCE RATING OF CONCRETE MASONRY PROTECTION ASSEMBLY ₂ T _c (inches)			
		1[-] hour	2[-hour] hours	3[-hour] hours	4[-hour] hours			1[-] hour	2[-hour] hours	3[-hour] hours	4[-hour] hours
4 × 4 × 1/2 wall thickness	100	1.08	2.13	2.99	3.76	4 double extra strong 0.674 wall thickness	100	0.95	1.99	2.85	3.62
	110	1.16	2.24	3.13	3.91		110	1.02	2.10	2.99	3.78
	120	1.22	2.34	3.26	4.06		120	1.09	2.20	3.12	3.93
4 × 4 × 3/8 wall thickness	80	1.05	2.03	2.84	3.57	4 extra strong 0.337 wall thickness	80	1.12	2.11	2.93	3.65
	100	1.20	2.25	3.11	3.88		100	1.26	2.32	3.19	3.95
	110	1.27	2.35	3.24	4.02		110	1.33	2.42	3.31	4.09
	120	1.34	2.45	3.37	4.17		120	1.40	2.52	3.43	4.23
4 × 4 × 1/4 wall thickness	80	1.21	2.20	3.01	3.73	4 standard 0.237 wall thickness	80	1.26	2.25	3.07	3.79
	100	1.35	2.40	3.26	4.02		100	1.40	2.45	3.31	4.07
	110	1.41	2.50	3.38	4.16		110	1.46	2.55	3.43	4.21
	120	1.48	2.59	3.50	4.30		120	1.53	2.64	3.54	4.34
6 × 6 × 1/2 wall thickness	80	0.82	1.75	2.54	3.25	5 double extra strong 0.750 wall thickness	80	0.70	1.61	2.40	3.12
	100	0.98	1.99	2.84	3.59		100	0.85	1.86	2.71	3.47
	110	1.05	2.10	2.98	3.75		110	0.91	1.97	2.85	3.63
	120	1.12	2.21	3.11	3.91		120	0.98	2.02	2.99	3.79
6 × 6 × 3/8 wall thickness	80	0.96	1.91	2.71	3.42	5 extra strong 0.375 wall thickness	80	1.04	2.01	2.83	3.54
	100	1.12	2.14	3.00	3.75		100	1.19	2.23	3.09	3.85
	110	1.19	2.25	3.13	3.90		110	1.26	2.34	3.22	4.00
	120	1.26	2.35	3.26	4.05		120	1.32	2.44	3.34	4.14
6 × 6 × 1/4 wall thickness	80	1.14	2.11	2.92	3.63	5 standard 0.258 wall thickness	80	1.20	2.19	3.00	3.72
	100	1.29	2.32	3.18	3.93		100	1.34	2.39	3.25	4.00
	110	1.36	2.43	3.30	4.08		110	1.41	2.49	3.37	4.14
	120	1.42	2.52	3.43	4.22		120	1.47	2.58	3.49	4.28
8 × 8 × 1/2 wall thickness	80	0.77	1.66	2.44	3.13	6 double extra strong 0.864 wall thickness	80	0.59	1.46	2.23	2.92
	100	0.92	1.91	2.75	3.49		100	0.73	1.71	2.54	3.29
	110	1.00	2.02	2.89	3.66		110	0.80	1.82	2.69	3.47
	120	1.07	2.14	3.03	3.82		120	0.86	1.93	2.83	3.63
8 × 8 × 3/8 wall thickness	80	0.91	1.84	2.63	3.33	6 extra strong 0.432 wall thickness	80	0.94	1.90	2.70	3.42
	100	1.07	2.08	2.92	3.67		100	1.10	2.13	2.98	3.74
	110	1.14	2.19	3.06	3.83		110	1.17	2.23	3.11	3.89
	120	1.21	2.29	3.19	3.98		120	1.24	2.34	3.24	4.04
	80	1.10	2.06	2.86	3.57		80	1.14	2.12	2.93	3.64

TABLE [721.5.1(5)] 722.5.1(5)
FIRE RESISTANCE OF CONCRETE MASONRY PROTECTED STEEL COLUMNS

COLUMN SIZE	CONCRETE MASONRY DENSITY POUNDS PER CUBIC FOOT	MINIMUM REQUIRED EQUIVALENT THICKNESS FOR FIRE-RESISTANCE RATING OF CONCRETE MASONRY PROTECTION ASSEMBLY, T _c (inches)				COLUMN SIZE	CONCRETE MASONRY DENSITY POUNDS PER CUBIC FOOT	MINIMUM REQUIRED EQUIVALENT THICKNESS FOR FIRE-RESISTANCE RATING OF CONCRETE MASONRY PROTECTION ASSEMBLY, T _c (inches)			
		1[-] hour	2[-hour] hours	3[-hour] hours	4[-hour] hours			1[-] hour	2[-hour] hours	3[-hour] hours	4[-hour] hours
8 × 8 × 1/4 wall thickness	100	1.25	2.28	3.13	3.87	6 standard 0.280 wall thickness	100	1.29	2.33	3.19	3.94
	110	1.32	2.38	3.25	4.02		110	1.36	2.43	3.31	4.08
	120	1.39	2.48	3.38	4.17		120	1.42	2.53	3.43	4.22

For SI: 1 inch = 25.4 mm, 1 pound per cubic feet = 16.02 kg/m³.
 Note: Tabulated values assume 1-inch air gap between masonry and steel section.

TABLE [721.5.1(6)] 722.5.1(6)
FIRE RESISTANCE OF CLAY MASONRY PROTECTED STEEL COLUMNS

COLUMN SIZE	CLAY MASONRY DENSITY, POUNDS PER CUBIC FOOT	MINIMUM REQUIRED EQUIVALENT THICKNESS FOR FIRE-RESISTANCE RATING OF CLAY MASONRY PROTECTION ASSEMBLY, T _c (inches)				COLUMN SIZE	CLAY MASONRY DENSITY, POUNDS PER CUBIC FOOT	MINIMUM REQUIRED EQUIVALENT THICKNESS FOR FIRE-RESISTANCE RATING OF CLAY MASONRY PROTECTION ASSEMBLY, T _c (inches)			
		1[-] hour	2[-hour] hours	3[-hour] hours	4[-hour] hours			1[-] hour	2[-hour] hours	3[-hour] hours	4[-hour] hours
W14 × 82	120	1.23	2.42	3.41	4.29	W10 × 68	120	1.27	2.46	3.26	4.35
	130	1.40	2.70	3.78	4.74		130	1.44	2.75	3.83	4.80
W14 × 68	120	1.34	2.54	3.54	4.43	W10 × 54	120	1.40	2.61	3.62	4.51
	130	1.51	2.82	3.91	4.87		130	1.58	2.89	3.98	4.95
W14 × 53	120	1.43	2.65	3.65	4.54	W10 × 45	120	1.44	2.66	3.67	4.57
	130	1.61	2.93	4.02	4.98		130	1.62	2.95	4.04	5.01
W14 × 43	120	1.54	2.76	3.77	4.66	W10 × 33	120	1.59	2.82	3.84	4.73
	130	1.72	3.04	4.13	5.09		130	1.77	3.10	4.20	5.13
W12 × 72	120	1.32	2.52	3.51	4.40	W8 × 40	120	1.47	2.70	3.71	4.61
	130	1.50	2.80	3.88	4.84		130	1.65	2.98	4.08	5.04
W12 × 58	120	1.40	2.61	3.61	4.50	W8 × 31	120	1.59	2.82	3.84	4.73
	130	1.57	2.89	3.98	4.94		130	1.77	3.10	4.20	5.17
W12 × 50	120	1.43	2.65	3.66	4.55	W8 × 24	120	1.66	2.90	3.92	4.82
	130	1.61	2.93	4.02	4.99		130	1.84	3.18	4.28	5.25
W12 × 40	120	1.54	2.77	3.78	4.67	W8 × 18	120	1.75	3.00	4.01	4.91
	130	1.72	3.05	4.14	5.10		130	1.93	3.27	4.37	5.34
Steel tubing						Steel pipe					
Nominal tube size (inches)	Clay masonry density, pounds per cubic foot	Minimum required equivalent thickness for fire-resistance rating of clay. Masonry protection assembly T _c , (inches)				Nominal pipe size (inches)	Clay masonry density, pounds per cubic foot	Minimum required equivalent thickness for fire-resistance rating of clay. Masonry protection assembly T _c , (inches)			
		1-hour	2-hour	3-hour	4-hour			1-hour	2-hour	3-hour	4-hour
4 × 4 × 1/2 wall thickness	120	1.44	2.72	3.76	4.68	4 double extra strong 0.674 wall thickness	120	1.26	2.55	3.60	4.52
	130	1.62	3.00	4.12	5.11		130	1.42	2.82	3.96	4.95
	120	1.56	2.84	3.88	4.78	4 extra strong 0.337	120	1.60	2.89	3.92	4.83

TABLE [721.5.1(6)] 722.5.1(6)
FIRE RESISTANCE OF CLAY MASONRY PROTECTED STEEL COLUMNS

COLUMN SIZE	CLAY MASONRY DENSITY, POUNDS PER CUBIC FOOT	MINIMUM REQUIRED EQUIVALENT THICKNESS FOR FIRE-RESISTANCE RATING OF CLAY MASONRY PROTECTION ASSEMBLY, T _c (inches)				COLUMN SIZE wall thickness	CLAY MASONRY DENSITY, POUNDS PER CUBIC FOOT	MINIMUM REQUIRED EQUIVALENT THICKNESS FOR FIRE-RESISTANCE RATING OF CLAY MASONRY PROTECTION ASSEMBLY, T _c (inches)			
		1[-] hour	2[-hour] hours	3[-hour] hours	4[-hour] hours			1[-] hour	2[-hour] hours	3[-hour] hours	4[-hour] hours
4 × 4 × 3/8 wall	130	1.74	3.12	4.23	5.21	4 standard wall thickness	130	1.77	3.16	4.28	5.25
4 × 4 × 1/4 wall thickness	120	1.72	2.99	4.02	4.92	4 standard 0.237 wall thickness	120	1.74	3.02	4.05	4.95
	130	1.89	3.26	4.37	5.34		130	1.92	3.29	4.40	5.37
6 × 6 × 1/2 wall thickness	120	1.33	2.58	3.62	4.52	5 double extra strong 0.750 wall thickness	120	1.17	2.44	3.48	4.40
	130	1.50	2.86	3.98	4.96		130	1.33	2.72	3.84	4.83
6 × 6 × 3/8 wall thickness	120	1.48	2.74	3.76	4.67	5 extra strong 0.375 wall thickness	120	1.55	2.82	3.85	4.76
	130	1.65	3.01	4.13	5.10		130	1.72	3.09	4.21	5.18
6 × 6 × 1/4 wall thickness	120	1.66	2.91	3.94	4.84	5 standard 0.258 wall thickness	120	1.71	2.97	4.00	4.90
	130	1.83	3.19	4.30	5.27		130	1.88	3.24	4.35	5.32
8 × 8 × 1/2 wall thickness	120	1.27	2.50	3.52	4.42	6 double extra strong 0.864 wall thickness	120	1.04	2.28	3.32	4.23
	130	1.44	2.78	3.89	4.86		130	1.19	2.60	3.68	4.67
8 × 8 × 3/8 wall thickness	120	1.43	2.67	3.69	4.59	6 extra strong 0.432 wall thickness	120	1.45	2.71	3.75	4.65
	130	1.60	2.95	4.05	5.02		130	1.62	2.99	4.10	5.08
8 × 8 × 1/4 wall thickness	120	1.62	2.87	3.89	4.78	6 standard 0.280 wall thickness	120	1.65	2.91	3.94	4.84
	130	1.79	3.14	4.24	5.21		130	1.82	3.19	4.30	5.27

For SI: 1 inch = 25.4 mm, 1 pound per cubic foot = 16.02 kg/m³.

TABLE [721.5.1(7)] 722.5.1(7)
MINIMUM COVER (inch) FOR STEEL COLUMNS
ENCASED IN NORMAL-WEIGHT CONCRETE^a
[FIGURE [721.5.1(6)(e)] 722.5.1(6)(c)]

STRUCTURAL SHAPE	FIRE-RESISTANCE RATING (hours)								
	1	1½	2	3	4				
W14 × 233	1	1	1	[¹ / ₂] 1½	2				
× 176				1½	2	2½			
× 132			2½				3		
× 90		1½			2½				
× 61			2			3			
× 48				1			2		
× 43		1			2				
W12 × 152	1		1			1		2	2½
× 96			1½	1½		2½	3		
× 65		1			2			3	
× 50			1½	2½		3			
× 40							1		2
W10 × 88	1	1½	1½	2	3				
× 49				2½		3½			
× 45			2		3½				
× 39		1		1½		2½	3		
× 33			1		1½			2½	3
W8 × 67	1	1		1½		2½	3		
× 58		1½	2	3	3½				
× 48						2	3	4	
× 31		1½	2	3	3½				
× 21						1	1½	2½	3
× 18		1	1½	2½	3				
W6 × 25	1					1½	2	3	3½
× 20		2	2½	3½	4				
× 16						1½	2	2½	3
× 15		2	2½	3½	4				
× 9									

For SI: 1 inch = 25.4 mm.

a. The tabulated thicknesses are based upon the assumed properties of normal-weight concrete given in Table [721.5.1(2)] 722.5.1(2).

TABLE [721.5.1(8)] 722.5.1(8)
MINIMUM COVER (inch) FOR STEEL
COLUMNS ENCASED IN STRUCTURAL
LIGHTWEIGHT CONCRETE^a
[FIGURE 721.5.1(6)(c)] FIGURE 722.5.1(6)(c)

STRUCTURAL SHAPE	FIRE-RESISTANCE RATING (HOURS)				
	1	1½	2	3	4
W14 × 233	1	1	1	1	1½
× 193				1½	
× 74					2½
× 61			2		
× 43				1½	2
W12 × 65	1	1	1	1½	2
× 53			1½	2	2½
× 40				2	
W10 × 112	1	1	1	1½	2
× 88				2	2½
× 60			1½		
× 33				2	
W8 × 35	1	1	1½	2	2½
× 28				2½	3
× 24		1½			
× 18				1½	

For SI: 1 inch = 25.4 mm.

a. The tabulated thicknesses are based upon the assumed properties of structural lightweight concrete given in Table [721.5.1(2)] 722.5.1(2).

TABLE [721.5.1(9)] 722.5.1(9)
MINIMUM COVER (inch) FOR STEEL COLUMNS IN
NORMAL-WEIGHT PRECAST COVERS^a
[FIGURE 721.5.1(6)(a)] 722.5.1(6)(a)

STRUCTURAL SHAPE	FIRE-RESISTANCE RATING (hours)				
	1	1½	2	3	4
W14 × 233	1½	1½	1½	2½	3
× 211			2		3½
× 176				2	
× 145		3	4½		
× 109					3½
× 99		2	2½	4	
× 61				2	2
× 43		2	2		
W12 × 190	1½	1½	1½	2½	3½
× 152			2		

TABLE [721.5.1(9)] 722.5.1(9)
MINIMUM COVER (inch) FOR STEEL COLUMNS IN
NORMAL-WEIGHT PRECAST COVERS^a
[FIGURE [721.5.1(6)(a)] 722.5.1(6)(a)]

STRUCTURAL SHAPE	FIRE-RESISTANCE RATING (hours)						
	1	1½	2	3	4		
× 120				3	4		
× 96							
× 87				2	2½	3½	4½
× 58							
× 40							
W10 × 112	1½	1½	2	3	3½		
× 88		2	2½	3	4		
× 77							
× 54				3½	4½		
× 33							
W8 × 67	1½	1½	2	3	4		
× 58		2	2½	3½			
× 48							
× 28							
× 21		2½	3	4	4½		
× 18							
W6 × 25	1½	2	2½	3½	4½		
× 20		2½	3	4			
× 16							
× 12	2			4	5		
× 9							

For SI: 1 inch = 25.4 mm.

a. The tabulated thicknesses are based upon the assumed properties of normal-weight concrete given in Table [721.5.1(2)] 722.5.1(2).

TABLE [721.5.1(10)] 722.5.1(10)
MINIMUM COVER (inch) FOR STEEL COLUMNS IN
STRUCTURAL LIGHTWEIGHT PRECAST COVERS^a
[FIGURE 721.5.1(6)(a)] FIGURE 722.5.1(6)(a)

STRUCTURAL SHAPE	FIRE-RESISTANCE RATING (hours)				
	1	1½	2	3	4
W14 × 233	1½	1½	1½	2	2½
× 176				2½	3
× 145					
× 132					
× 109			2		3½
× 99					
× 68			3		
× 43					
W12 × 190	1½	1½	1½	2	2½
× 152				2½	3
× 136					
× 106					
× 96			2		3½
× 87					
× 65			3		
× 40					
W10 × 112	1½	1½	1½	2	3
× 100				2½	
× 88					
× 77			2		3½
× 60					
× 39					
× 33		3			
W8 × 67	1½	1½	1½	2½	3
× 48			2	3	3½
× 35					
× 28		2			
× 18			2½		
W6 × 25	1½	2	2	3	3½
× 15			2½		4
× 9				3½	

For SI: 1 inch = 25.4 mm.

- a. The tabulated thicknesses are based upon the assumed properties of structural lightweight concrete given in Table [721.5.1(2)] 722.5.1(2).

[721.5.1.1] 722.5.1.1 General. These procedures establish a basis for determining the fire resistance of column assemblies as a function of the thickness of fire-resistant material and, the weight, W , and heated perimeter, D , of structural steel columns. As used in these sections, W is the average weight of a structural steel column in pounds per linear foot. The heated perimeter, D , is the inside perimeter of the fire-resistant material in inches as illustrated in Figure [721.5.1(4)] 722.5.1(1).

[721.5.1.1.1] 722.5.1.1.1 Nonload-bearing protection. The application of these procedures shall be limited to column assemblies in which the fire-resistant material is not designed to carry any of the load acting on the column.

[721.5.1.1.2] 722.5.1.1.2 Embedments. In the absence of substantiating fire-endurance test results, ducts, conduit, piping, and similar mechanical, electrical, and plumbing installations shall not be embedded in any required fire-resistant materials.

[721.5.1.1.3] 722.5.1.1.3 Weight-to-perimeter ratio. Table [721.5.1(4)] 722.5.1(1) contains weight-to-heated-perimeter ratios (W/D) for both contour and box fire-resistant profiles, for the wide flange shapes most often used as columns. For different fire-resistant protection profiles or column cross sections, the weight-to-heated-perimeter ratios (W/D) shall be determined in accordance with the definitions given in this section.

[721.5.1.2] 722.5.1.2 Gypsum wallboard protection. The fire resistance of structural steel columns with ~~[weight to heated perimeter]~~ weight-to-heated-perimeter ratios (W/D) less than or equal to 3.65 and ~~[which]~~ that are protected with Type X gypsum wallboard shall be permitted to be determined from the following expression:

$$R = 130 \left[\frac{h(W/D)}{2} \right]^{0.75} \quad \text{(Equation 7-12)}$$

where:

R = Fire resistance (minutes).

h = Total thickness of gypsum wallboard (inches).

D = Heated perimeter of the structural steel column (inches).

W' = Total weight of the structural steel column and gypsum wallboard protection (pounds per linear foot).

$W' = W + 50hD/144.$

[721.5.1.2.1] 722.5.1.2.1 Attachment. The gypsum ~~[wallboard]~~ board or gypsum panel products shall be supported as illustrated in either Figure [721.5.1(2)] 722.5.1(2) for fire-resistance ratings of 4 hours or less, or Figure [721.5.1(3)] 722.5.1(3) for fire-resistance ratings of 3 hours or less.

[721.5.1.2.2] 722.5.1.2.2 Gypsum wallboard equivalent to concrete. The determination of the fire resistance of structural steel columns from Figure [721.5.1(4)] 722.5.1(4) is permitted for various thicknesses of gypsum wallboard as a function of the weight-to-heated-perimeter ratio (W/D) of the column. For structural steel columns with weight-to-heated-perimeter ratios (W/D) greater than 3.65, the thickness of gypsum wallboard

required for specified fire-resistance ratings shall be the same as the thickness determined for a W14 x 233 wide flange shape.

[721.5.1.3] 722.5.1.3 Spray-applied fire-resistant materials. The fire resistance of wide-flange structural steel columns protected with spray-applied fire-resistant materials, as illustrated in Figure [721.5.1(5)] 722.5.1(5), shall be permitted to be determined from the following expression:

$$R = [C_1 (W/D) + C_2]h \quad \text{(Equation 7-13)}$$

where:

R = Fire resistance (minutes).

h = Thickness of spray-applied fire-resistant material (inches).

D = Heated perimeter of the structural steel column (inches).

C₁ and C₂ = Material-dependent constants.

W = Weight of structural steel column (pounds per linear foot).

Exception: The fire resistance of structural steel columns protected with intumescent or mastic fire-resistant coatings shall be determined on the basis of fire resistance tests in accordance with Section 703.2.

[721.5.1.3.1] 722.5.1.3.1 Material-dependent constants. The material-dependent constants, C₁ and C₂, shall be determined for specific fire-resistant materials on the basis of standard [fire endurance] fire-resistance tests in accordance with Section 703.2. Unless evidence is submitted to the commissioner substantiating a broader application, this expression shall be limited to determining the fire resistance of structural steel columns with weight-to-heated-perimeter ratios (W/D) between the largest and smallest columns for which standard [fire endurance] fire-resistance test results are available.

[721.5.1.3.2] 722.5.1.3.2 Identification. Spray-applied fire-resistant materials shall be identified by density and thickness required for a given fire-resistance rating.

[721.5.1.4] 722.5.1.4 Concrete-protected columns. The fire resistance of structural steel columns protected with concrete, as illustrated in Figure [721.5.1(6)] 722.5.1(6)(a) and (b), shall be permitted to be determined from the following expression:

$$R = R_0(1 + 0.03m) \quad \text{(Equation 7-14)}$$

where:

$$R_0 = 10(W/D)^{0.7} + 17(h^{1.6}/k_c^{0.2}) \times (1 + 26 (h/p_c c_c h(L + h))^{0.8})$$

As used in these expressions:

R = Fire endurance at equilibrium moisture conditions (minutes).

R₀ = Fire endurance at zero moisture content (minutes).

m = Equilibrium moisture content of the concrete by volume (percent).

- W = Average weight of the steel column (pounds per linear foot).
- D = Heated perimeter of the steel column (inches).
- h = Thickness of the concrete cover (inches).
- k_c = Ambient temperature thermal conductivity of the concrete (Btu/hr ft °F).
- H = Ambient temperature thermal capacity of the steel column = 0.11W (Btu/hr °F).
- p_c = Concrete density (pounds per cubic foot).
- c_c = Ambient temperature specific heat of concrete (Btu/lb °F).
- L = Interior dimension of one side of a square concrete box protection (inches).

[721.5.1.4.1] 722.5.1.4.1 Reentrant space filled. For wide-flange structural steel columns completely encased in concrete with all reentrant spaces filled (Figure [721.5.1(6)(e)] 722.5.1(6)(c)), the thermal capacity of the concrete within the reentrant spaces shall be permitted to be added to the thermal capacity of the steel column, as follows:

$$H = 0.11W + (p_c c_c / 144)(b_f d - A_s) \quad \text{(Equation 7-15)}$$

where:

- b_f = Flange width of the steel column (inches).
- d = Depth of the steel column (inches).
- A_s = Cross-sectional area of the steel column (square inches).

[721.5.1.4.2] 722.5.1.4.2 Concrete properties unknown. If specific data on the properties of concrete are not available, the values given in Table [721.5.1(2)] 722.5.1(2) are permitted.

[721.5.1.4.3] 722.5.1.4.3 Minimum concrete cover. For structural steel column encased in concrete with all reentrant spaces filled, Figure [721.5.1(6)(e)] 722.5.1(6)(c) and Tables [721.5.1(7)] 722.5.1(7) and [721.5.1(8)] 722.5.1(8) indicate the thickness of concrete cover required for various fire-resistance ratings for typical wide-flange sections. The thicknesses of concrete indicated in these tables [also] apply to structural steel columns larger than those listed.

[721.5.1.4.4] 722.5.1.4.4 Minimum precast concrete cover. For structural steel columns protected with precast concrete column covers as shown in Figure [721.5.1(6)(a)] 722.5.1(6)(a), Tables [721.5.1(9)] 722.5.1(9) and [721.5.1(10)] 722.5.1(10) indicate the thickness of the column covers required for various fire-resistance ratings for typical wide-flange shapes. The thicknesses of concrete given in these tables [also] apply to structural steel columns larger than those listed.

[721.5.1.4.5] 722.5.1.4.5 Masonry protection. The fire resistance of structural steel columns protected with concrete masonry units or clay masonry units as illustrated in Figure [721.5.1(7)] 722.5.1(7), shall be permitted to be determined from the following expression:

$$R = 0.17(W/D)^{0.7} + [0.285(T_e^{1.6}/K^{0.2})][1.0 + 42.7\{(A_s/d_m T_e)/(0.25p + T_e)\}^{0.8}] \quad \text{(Equation 7-16)}$$

where:

R = Fire-resistance rating of column assembly (hours).

W = Average weight of steel column (pounds per foot).

D = Heated perimeter of steel column (inches) [see Figure [721.5.1(7)] 722.5.1(7)].

T_e = Equivalent thickness of concrete or clay masonry unit (inches) (see Table [721.3.2] 722.3.2 Note a or Section [721.4.1] 722.4.1).

K = Thermal conductivity of concrete or clay masonry unit (Btu/hr ft °F) [see Table [721.5.1(3)] 722.5.1(3)].

A_s = Cross-sectional area of steel column (square inches).

d_m = Density of the concrete or clay masonry unit (pounds per cubic foot).

p = Inner perimeter of concrete or clay masonry protection (inches) [see Figure [721.5.1(7)] 722.5.1(7)].

[721.5.1.4.6] 722.5.1.4.6 Equivalent concrete masonry thickness. For structural steel columns protected with concrete masonry, Table [721.5.1(5)] 722.5.1(5) gives the equivalent thickness of concrete masonry required for various fire-resistance ratings for typical column shapes. For structural steel columns protected with clay masonry, Table [721.5.1(6)] 722.5.1(6) gives the equivalent thickness of concrete masonry required for various fire-resistance ratings for typical column shapes.

[721.5.2] 722.5.2 Structural steel beams and girders. The fire-resistance ratings of structural steel beams and girders shall be based upon the size of the element and the type of protection provided in accordance with this section.

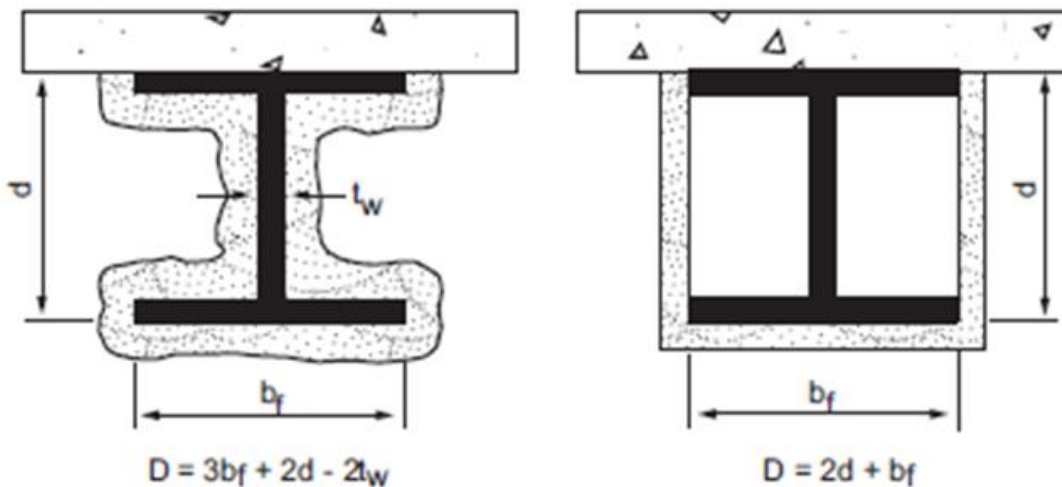

FIGURE 722.5.2
DETERMINATION OF THE HEATED PERIMETER OF
STRUCTURAL STEEL BEAMS AND GIRDERS

[721.5.2.1] 722.5.2.1 Determination of fire resistance. These procedures establish a basis for determining resistance of structural steel beams and girders ~~[which]~~ that differ in size from that specified in approved fire-resistance-rated assemblies as a function of the thickness of fire-resistant material and the weight (W) and heated perimeter (D) of the beam or girder. As used in these sections, W is the average weight of a structural steel ~~[member]~~ element in pounds per linear foot (plf). The heated perimeter, D , is the inside perimeter of the fire-resistant material in inches as illustrated in Figure ~~[721.5.2]~~ 722.5.2.

[721.5.2.1.1] 722.5.2.1.1 Weight-to-heated perimeter. The weight-to-heated-perimeter ratios (W/D), for both contour and box fire-resistant protection profiles, for the wide flange shapes most often used as beams or girders are given in Table ~~[721.5.1(4)]~~ 722.5.1(4). For different shapes, the weight-to-heated-perimeter ratios (W/D) shall be determined in accordance with the definitions given in this section.

[721.5.2.1.2] 722.5.2.1.2 Beam and girder substitutions. Except as provided for in Section ~~[721.5.2.2]~~ 722.5.2.2, structural steel beams in approved ~~[fire-resistant]~~ fire-resistance-rated assemblies shall be considered the minimum permissible size. Other beam or girder shapes shall be permitted to be substituted provided that the weight-to-heated-perimeter ratio (W/D) of the substitute beam is equal to or greater than that of the beam specified in the approved assembly.

[721.5.2.2] 722.5.2.2 Spray-applied fire-resistant materials. The provisions in this section apply to structural steel beams and girders protected with spray-applied fire-resistant materials. Larger or smaller beam and girder shapes shall be permitted to be substituted for beams specified in approved unrestrained or restrained fire-resistance-rated assemblies, provided that the thickness of the fire-resistant material is adjusted in accordance with the following expression:

$$h_2 = \left[\frac{(W_1/D_1) + 0.60}{(W_2/D_2) + 0.60} \right] h_1 \quad \text{(Equation 7-17)}$$

where:

h = Thickness of spray-applied fire-resistant material in inches.

W = Weight of the structural steel beam or girder in pounds per linear foot.

D = Heated perimeter of the structural steel beam or girder in inches.

Subscript 1 refers to the beam and fire-resistant material thickness in the approved assembly.

Subscript 2 refers to the substitute beam or girder and the required thickness of fire-resistant material.

Exception: The ~~[fire-resistance]~~ fire-resistance of structural steel beams and girders protected with intumescent or mastic fire-resistant coatings shall be determined on the basis of fire-resistance tests in accordance with Section 703.2.

[721.5.2.2.1] 722.5.2.2.1 Minimum thickness. The use of Equation 7-17 is subject to the following conditions:

1. The weight-to-heated-perimeter ratio for the substitute beam or girder (W_2/D_2) shall be not ~~[be]~~ less than 0.37.

2. The thickness of fire protection materials for the substitute beam or girder (T_i) shall be not [~~be~~] less than $3/8$ inch (9.5 mm).
3. The unrestrained or restrained beam rating shall be not [~~be~~] less than 1 hour.
4. [~~When~~] Where used to adjust the material thickness for a restrained beam, the use of this procedure is limited to structural steel sections classified as compact in accordance with AISC 360.

[721.5.2.3] 722.5.2.3 Structural steel trusses. The fire resistance of structural steel trusses protected with fire-resistant materials spray applied to each of the individual truss elements shall be permitted to be determined in accordance with this section. The thickness of the fire-resistant material shall be determined in accordance with Section [~~721.5.1.3~~] 722.5.1.3. The weight-to-heated-perimeter ratio (W/D) of truss elements which can be simultaneously exposed to fire on all sides shall be determined on the same basis as columns, as specified in Section [~~721.5.1.1~~] 722.5.1.1. The weight-to-heated-perimeter ratio (W/D) of truss elements which directly support floor or roof assembly shall be determined on the same basis as beams and girders, as specified in Section [~~721.5.2.1~~] 722.5.2.1.

Exception: The fire resistance of structural steel trusses protected with intumescent or mastic fire-resistant coatings shall be determined on the basis of fire-resistance tests in accordance with Section 703.2.

[721.6] 722.6 Wood assemblies. The provisions of this section contain procedures by which the fire-resistance ratings of wood assemblies are established by calculations.

[721.6.1] 722.6.1 General. This section contains procedures for calculating the fire-resistance ratings of walls, floor/ceiling and roof/ceiling assemblies based in part on the standard method of testing referenced in Section 703.2.

[721.6.1.1] 722.6.1.1 Maximum fire-resistance rating. Fire-resistance ratings calculated for assemblies using the methods in Section [~~721.6~~] 722.6 shall be limited to a maximum of 1 hour.

[721.6.1.2] 722.6.1.2 Dissimilar membranes. Where dissimilar membranes are used on a wall assembly that requires consideration of fire exposure from both sides, the calculation shall be made from the least fire-resistant (weaker) side.

[721.6.2] 722.6.2 Walls, floors and roofs. These procedures apply to both load-bearing and nonload-bearing assemblies.

TABLE [721.6.2(1)] 722.6.2(1)
TIME ASSIGNED TO WALLBOARD
MEMBRANES^{a,b,c,d}

DESCRIPTION OF FINISH	TIME ^e (minutes)
³ / ₈ -inch wood structural panel bonded with exterior glue	5
¹⁵ / ₃₂ -inch wood structural panel bonded with exterior glue	10
¹⁹ / ₃₂ -inch wood structural panel bonded with exterior glue	15
³ / ₈ -inch gypsum wallboard	10
¹ / ₂ -inch gypsum wallboard	15
⁵ / ₈ -inch gypsum wallboard	30
¹ / ₂ -inch Type X gypsum wallboard	25
⁵ / ₈ -inch Type X gypsum wallboard	40
Double ³ / ₈ -inch gypsum wallboard	25
¹ / ₂ - + ³ / ₈ -inch gypsum wallboard	35
Double ¹ / ₂ -inch gypsum wallboard	40

For SI: 1 inch = 25.4 mm.

- These values apply only ~~when~~ where membranes are installed on framing members ~~which~~ that are spaced 16 inches o.c. or less.
- Gypsum ~~wallboard~~ wallboard installed over framing or furring shall be installed so that all edges are supported, except ⁵/₈-inch Type X gypsum wallboard shall be permitted to be installed horizontally with the horizontal joints staggered 24 inches each side and unsupported but finished.
- On wood frame floor/ceiling or roof/ceiling assemblies, gypsum board shall be installed with the long dimension perpendicular to framing members and shall have all joints finished.
- The membrane on the unexposed side shall not be included in determining the fire resistance of the assembly. ~~When~~ Where dissimilar membranes are used on a wall assembly, the calculation shall be made from the least fire-resistant (weaker) side.
- The time assigned is not a finished rating.

TABLE [721.6.2(2)] 722.6.2(2)
TIME ASSIGNED FOR CONTRIBUTION OF WOOD FRAME^{a,b,c}

DESCRIPTION	TIME ASSIGNED TO FRAME (minutes)
Wood studs 16 inches o.c.	20
Wood floor and roof joists 16 inches o.c.	10

For SI: 1 inch = 25.4 mm.

- This table does not apply to studs or joists spaced more than 16 inches o.c.
- All studs shall be nominal 2 × 4 and all joists shall have a nominal thickness of ~~at least~~ not less than 2 inches.
- Allowable spans for joists shall be determined in accordance with Sections ~~[2308.8, 2308.10.2 and 2308.10.3]~~ 2308.4.2.1, 2308.7.1 and 2308.7.2.

TABLE [721.6.2(3)] 722.6.2(3)
MEMBRANE^a ON EXTERIOR FACE OF WOOD STUD WALLS

SHEATHING	PAPER	EXTERIOR FINISH
⁵ / ₈ -inch T & G lumber ⁵ / ₁₆ -inch exterior glue plywood ¹ / ₂ -inch gypsum wallboard ⁵ / ₈ -inch gypsum wallboard ¹ / ₂ -inch fiberboard	Sheathing paper	Lumber siding Wood shingles and shakes ¹ / ₄ -inch fiber-cement lap, panel or shingle siding ¹ / ₄ -inch wood structural panels—exterior type ¹ / ₄ -inch hardboard Metal siding Stucco on metal lath Masonry veneer
None	—	³ / ₈ -inch exterior-grade wood structural panels

For SI: 1 inch = 25.4 mm.

- a. Any combination of sheathing, paper, and exterior finish is permitted.

TABLE [721.6.2(4)] 722.6.2(4)
FLOORING OR ROOFING OVER WOOD FRAMING^a

ASSEMBLY	STRUCTURAL MEMBERS	SUBFLOOR OR ROOF DECK	FINISHED FLOORING OR ROOFING
Floor	Wood	¹⁵ / ₃₂ -inch wood structural panels or ¹¹ / ₁₆ inch T & G softwood	Hardwood or softwood flooring on building paper resilient flooring, parquet floor felted-synthetic fiber floor coverings, carpeting, or ceramic tile on <u>¹/₄-inch-thick fiber-cement underlayment or ³/₈-inch-thick panel-type underlay</u> Ceramic tile on ¹ / ₄ -inch mortar bed
Roof	Wood	¹⁵ / ₃₂ -inch wood structural panels or ¹¹ / ₁₆ inch T & G softwood	Finished roofing material with or without insulation

For SI: 1 inch = 25.4 mm.

- a. This table applies only to wood joist construction. It is not applicable to wood truss construction.

TABLE [721.6.2(5)] 722.6.2(5)
TIME ASSIGNED FOR ADDITIONAL PROTECTION

DESCRIPTION OF ADDITIONAL PROTECTION	FIRE RESISTANCE (minutes)
Add to the fire-resistance rating of wood stud walls if the spaces between the studs are completely filled with glass fiber mineral wool batts weighing not less than 2 pounds per cubic foot (0.6 pound per square foot of wall surface) or rockwool or slag material wool batts weighing not less than 3.3 pounds per cubic foot (1 pound per square foot of wall surface), or cellulose insulation having a nominal density not less than 2.6 pounds per cubic foot.	15

For SI: 1 pound/cubic foot = 16.0185 kg/m³.

[721.6.2.1] 722.6.2.1 Fire-resistance rating of wood frame assemblies. The fire-resistance rating of a wood frame assembly is equal to the sum of the time assigned to the membrane on the fire-exposed side, the time assigned to the framing members and the time assigned for additional contribution by other protective measures such as insulation. The membrane on the unexposed side shall not be included in determining the fire resistance of the assembly.

[721.6.2.2] 722.6.2.2 Time assigned to membranes. Table [721.6.2(1)] 722.6.2(1) indicates the time assigned to membranes on the fire-exposed side.

[721.6.2.3] 722.6.2.3 Exterior walls. For an exterior wall with a fire separation distance greater than 5 feet (1524 mm), the wall is assigned a rating dependent on the interior membrane and the framing as described in Tables [721.6.2(1)] 722.6.2(1) and [721.6.2(2)] 722.6.2(2). The membrane on the outside of the nonfire-exposed side of exterior walls with a fire separation distance greater than 5 feet (1524 mm) ~~may~~ shall consist of sheathing, sheathing paper[;] and siding as described in Table [721.6.2(3)] 722.6.2(3).

[721.6.2.4] 722.6.2.4 Floors and roofs. In the case of a floor or roof, the standard test provides only for testing for fire exposure from below. Except as noted in Section 703.3, Item 5, floor or roof assemblies of wood framing shall have an upper membrane consisting of a subfloor and finished floor conforming to Table [721.6.2(4)] 722.6.2(4) or any other membrane that has a contribution to fire resistance of ~~at least~~ not less than 15 minutes in Table [721.6.2(1)] 722.6.2(1).

[721.6.2.5] 722.6.2.5 Additional protection. Table [721.6.2(5)] 722.6.2(5) indicates the time increments to be added to the fire resistance where glass fiber, rock wool, slag mineral wool[;] or cellulose insulation is incorporated in the assembly.

[721.6.2.6] 722.6.2.6 Fastening. Fastening of wood frame assemblies and the fastening of membranes to the wood framing members shall be done in accordance with Chapter 23.

~~**[721.6.3 Design of fire-resistant exposed wood members.** The fire resistance rating, in minutes, of timber beams and columns with a minimum nominal dimension of 6 inches (152 mm) is equal to:]~~

~~[Beams: $2.54Zb(4 - 2(b/d))$ for beams which may be exposed to fire on four sides.~~

~~(Equation 7-18)]~~

~~[$2.54Zb(4 - 2(b/d))$ for beams which may be exposed to fire on three sides.~~

~~(Equation 7-19)]~~

~~[Columns: $2.54Zd(3 - (d/b))$ for columns which may be exposed to fire on four sides.~~

~~(Equation 7-20)]~~

~~[$2.54Zd(3 - (d/2b))$ for columns which may be exposed to fire on three sides.~~

~~(Equation 7-21)]~~

~~[where:]~~

~~[b = The breadth (width) of a beam or larger side of a column before exposure to fire (inches).]~~

~~[d = The depth of a beam or smaller side of a column before exposure to fire (inches).]~~

~~[Z = Load factor, based on Figure 721.6.3(1).]~~

[721.6.3.1 Equation 7-21. Equation 7-21 applies only where the unexposed face represents the smaller side of the column. If a column is recessed into a wall, its full dimension shall be used for the purpose of these calculations.]

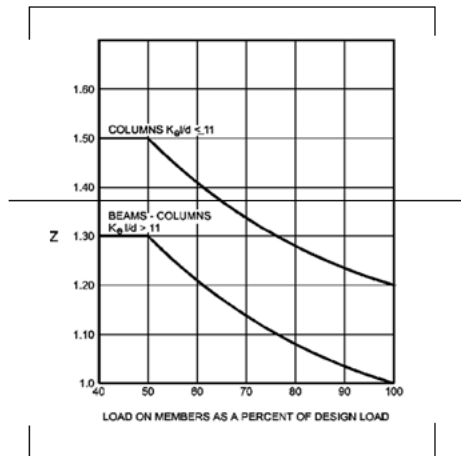

[FIGURE 721.6.3(1)]
[LOAD FIGURE]

[K_e = The effective length factor as noted in Figure 721.6.3(2).]
[l = The unsupported length of columns (inches).]

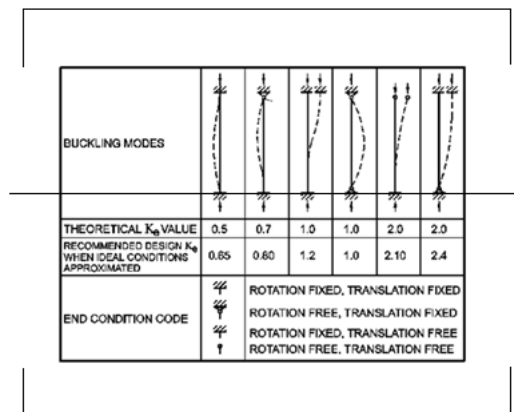

[FIGURE 721.6.3(2)]
[EFFECTIVE LENGTH FACTORS]

[721.6.3.2 Allowable loads. Allowable loads on beams and columns are determined using design values given in AF&PA NDS.]

[721.6.3.3 Fastener protection. Where minimum 1-hour fire resistance is required, connectors and fasteners shall be protected from fire exposure by 1½ inches (38 mm) of wood, or other approved covering or coating for a 1-hour rating. Typical details for commonly used fasteners and connectors are shown in AITC Technical Note 7.]

~~[721.6.3.4 Minimum size. Wood members are limited to dimensions of 6 inches (152 mm) nominal or greater. Glued laminated timber beams utilize standard laminating combinations except that a core lamination is removed. The tension zone is moved inward and the equivalent of an extra nominal 2-inch-thick (51 mm) outer tension lamination is added.]~~

~~[721.7 Other reference documents. Refer to Section 703.3, Item 1, and NBS BMS 71 and NBS TRBM 44 for fire-resistance ratings of materials and assemblies.]~~

§ 9. Chapter 8 of the New York city building code, as amended by local law number 141 for the year 2013, is amended to read as follows:

CHAPTER 8 INTERIOR FINISHES

SECTION BC 801 GENERAL

801.1 Scope. ~~[Provisions]~~ The provisions of this chapter shall govern the use of materials used as interior finishes, trim and decorative materials.

801.2 Interior wall and ceiling finish. The provisions of Section 803 shall limit the allowable fire performance and smoke development of interior wall and ceiling finish materials based on occupancy classification.

801.3 Interior floor finish. The provisions of Section 804 shall limit the allowable fire performance of interior floor finish materials based on occupancy classification.

801.4 Decorative materials and trim. Decorative materials and trim shall be restricted by combustibility ~~[and the]~~, fire performance or flame propagation performance criteria ~~[of NFPA 701,]~~ in accordance with Section 806.

801.5 Applicability in flood hazard areas. For buildings in flood hazard areas as established in Appendix G, interior finishes, trim and decorative materials below the design flood elevation shall be flood-damage-resistant materials.

801.6 Application. Combustible materials complying with the requirements of this chapter shall be permitted to be used as finish for walls, ceilings, floors and other interior surfaces of buildings.

801.7 Windows. Show windows in the exterior walls of the first story above grade plane shall be permitted to be of wood or of unprotected metal framing.

801.8 Foam plastics. Foam plastics shall not be used as interior finish except as provided in Section 803.4. Foam plastics shall not be used as interior trim except as provided in Section ~~[806.3]~~ 806.5 or 2604.2. This section shall apply both to exposed foam plastics and to foam plastics used in conjunction with a textile or vinyl facing or cover.

SECTION BC 802 DEFINITIONS

802.1 [General] Definitions. The following [~~words and~~] terms [~~shall, for the purposes of this chapter and as used elsewhere in this code, have the meanings shown herein.~~] are defined in Chapter 2:

EXPANDED VINYL WALL COVERING. [~~Wall covering consisting of a woven textile backing, an expanded vinyl base coat layer and a non-expanded vinyl skin coat. The expanded base coat layer is a homogeneous vinyl layer that contains a blowing agent. During processing, the blowing agent decomposes, causing this layer to expand by forming closed cells. The total thickness of the wall covering is approximately 0.055 inch to 0.070 inch (1.4 mm to 1.8 mm).~~]

FLAME SPREAD. [~~The propagation of flame over a surface.~~]

FLAME SPREAD INDEX. [~~A comparative measure, expressed as a dimensionless number, derived from visual measurements of the spread of flame versus time for a material tested in accordance with ASTM E 84.~~]

INTERIOR FINISH. [~~Interior finish includes interior wall and ceiling finish and interior floor finish.~~]

INTERIOR FLOOR FINISH. [~~The exposed floor surfaces of buildings including coverings applied over a finished floor or stair, including risers.~~]

INTERIOR FLOOR-WALL BASE. [~~Interior floor finish trim used to provide a functional and/or decorative border at the intersection of walls and floors.~~]

INTERIOR WALL AND CEILING FINISH. [~~The exposed interior surfaces of buildings including, but not limited to: fixed or movable walls and partitions; toilet room privacy partitions; columns; ceilings; and interior wainscoting, paneling or other finish applied structurally or for decoration, acoustical correction, surface insulation, structural fire resistance or similar purposes, but not including trim.~~]

SITE-FABRICATED STRETCH SYSTEM. [~~A system, fabricated on site and intended for acoustical, tackable or aesthetic purposes, that is comprised of three elements: (a) a frame (constructed of plastic, wood, metal or other material) used to hold fabric in place, (b) a core material (infill, with the correct properties for the application), and (c) an outside layer, comprised of a textile, fabric or vinyl, that is stretched taut and held in place by tension or mechanical fasteners via the frame.~~]

SMOKE-DEVELOPED INDEX. [~~A comparative measure, expressed as a dimensionless number, derived from measurements of smoke obscuration versus time for a material tested in accordance with ASTM E 84.~~]

TRIM. [~~Picture molds, chair rails, baseboards, handrails, door and window frames and similar decorative or protective materials used in fixed applications.~~]

SECTION BC 803 WALL AND CEILING FINISHES

803.1 General. Interior wall and ceiling finish materials shall be accepted as compliant for fire performance and smoke development in accordance with Section 803.1.1 or Section 803.1.2, and installed in accordance with the criteria therein. [~~Materials tested in accordance with Section 803.1.2 shall not be required to be tested in accordance with Section 803.1.1.~~]

[Exceptions:]

803.1.1 Interior wall and ceiling finish materials. Interior wall and ceiling finish materials shall be tested and classified in accordance with ASTM E 84 or UL 723. Such interior finish materials shall be grouped in the following classes in accordance with their flame spread and smoke-developed indexes.

Class A = Flame spread index 0-25; smoke developed index 0-450.

Class B = Flame spread index 26-75; smoke developed index 0-450.

Class C = Flame spread index 76-200; smoke developed index 0-450.

Exception: Materials tested in accordance with Section 803.1.2 need not be classified in accordance with Section 803.1.1.

803.1.2 Room corner test for interior wall or ceiling finish materials. As an alternative to Section 803.1.1, interior wall or ceiling finish materials shall be permitted to be tested in accordance with NFPA 286. Interior wall or ceiling finish materials tested in accordance with NFPA 286 shall comply with Section 803.1.2.1 of this code.

803.1.2.1 Acceptance criteria for NFPA 286. The interior finish shall comply with the following:

1. During the 40 kW exposure, flames shall not spread to the ceiling.
2. The flame shall not spread to the outer extremity of the sample on any wall or ceiling.
3. Flashover, as defined in NFPA 286, shall not occur.
4. The peak heat release rate throughout the test shall not exceed 800 kW.
5. The total smoke released throughout the test shall not exceed 10,764 square feet (1000 m²).

803.1.3 Room corner test for textile wall coverings and expanded vinyl wall coverings. Textile wall coverings and expanded vinyl wall coverings shall meet the criteria of Section 803.1.3.1 of this code when tested in the manner intended for use in accordance with the Method B protocol of NFPA 265 using the product-mounting system, including adhesive.

803.1.3.1 Acceptance criteria for NFPA 265. The interior finish shall comply with the following:

1. During the 40 kW exposure, flames shall not spread to the ceiling.
2. The flame shall not spread to the outer extremities of the samples on the 8-foot by 12-foot (2438.4 mm by 3657.6 mm) walls.
3. Flashover, as defined in NFPA 265, shall not occur.
4. The total smoke released throughout the test shall not exceed 10,764 square feet (1000 m²).

803.1.4 Flame-spread and smoke-developed tests for textile wall or ceiling coverings. Specimens shall be tested and indexed per ASTM E 84 or UL 723, and classified for flame spread per Section 803.1.4.1 of this code.

803.1.4.1 Acceptance criteria for textile and expanded vinyl wall or ceiling coverings tested to ASTM E 84 or UL 723. Textile wall and ceiling coverings and expanded vinyl wall and ceiling coverings shall have a Class A flame spread index per Section 803.1.1 of this code; shall meet the smoke developed index requirements of Section 803.1.1; and shall be protected by an automatic sprinkler system installed in accordance with Section 903.3.1.1 or 903.3.1.2 of this code. Test specimen preparation and mounting shall be in accordance with ASTM E 2404.

[1-] 803.2 Thickness exemption. Materials having a thickness less than 0.036 inch (0.9 mm) applied directly to the surface of walls or ceilings shall not be required to be tested.

[2-] 803.3 Heavy timber exemption. Exposed portions of [~~structural members~~] building elements complying with the requirements for buildings of Type IV construction in Section 602.4 shall not be subject to interior finish requirements.

803.4 Foam plastics. Foam plastics shall not be used as interior finish except as provided in Section 2603.9. This section shall apply both to exposed foam plastics and to foam plastics used in conjunction with a textile or vinyl facing or cover.

[3-] 803.5 Textile wall coverings. Where used as interior wall finish materials, textile wall coverings, including materials having woven or nonwoven, napped, tufted, looped or similar surface and carpet and similar textile materials, shall be tested in the manner intended for use, using the product mounting system, including adhesive, and shall comply with the requirements of Section 803.1.2, 803.1.3 or 803.1.4.1.

[4-] 803.6 Textile ceiling coverings. Where used as interior ceiling finish materials, textile ceiling coverings, including materials having woven or nonwoven, napped, tufted, looped or similar surface and carpet and similar textile materials, shall be tested in the manner intended for use, using the product mounting system, including adhesive, and shall comply with the requirements of Section 803.1.2 or 803.1.4.1.

[5-] 803.7 Expanded vinyl wall coverings. Where used as interior wall finish materials, expanded vinyl wall coverings shall be tested in the manner intended for use, using the product mounting

system, including adhesive, and shall comply with the requirements of Section 803.1.2, 803.1.3 or 803.1.4.1.

[6.] **803.8 Expanded vinyl ceiling coverings.** Where used as interior ceiling finish materials, expanded vinyl ceiling coverings shall be tested in the manner intended for use, using the product mounting system, including adhesive, and shall comply with the requirements of Section 803.1.2 or 803.1.4.1.

[7.] **803.9 High-density polyethylene (HDPE) and polypropylene (PP).** Where high-density polyethylene or polypropylene is used as an interior finish[;] it shall comply with [the requirements of] Section 803.1.2.

[8.] **803.10 Site-fabricated stretch systems.** Where used as interior wall or interior ceiling finish materials, site-fabricated stretch systems containing all three components described in the definition in Chapter 2 of this code shall be tested in the manner intended for use, and shall comply with the requirements of Section 803.1.1 or 803.1.2 of this code. If the materials are tested in accordance with ASTM E 84 or UL 723, specimen preparation and mounting shall be in accordance with ASTM E 2573.

**[TABLE 803.1
INTERIOR WALL AND CEILING FINISH REQUIREMENTS BY OCCUPANCY^k**

GROUP	SPRINKLERED ^l			NONSPRINKLERED		
	Exit enclosures and exit passageways ^{a,b}	Corridors	Rooms and enclosed spaces ^e	Exit enclosures and exit passageways ^{a,b}	Corridors	Rooms and enclosed spaces ^e
A-1 & A-2	B	B	C	A	A ^d	B ^e
A-3 ^f , A-4, A-5	B	B	C	A	A ^d	C
B, E, M, R-1	B	B	B	A	A	B
F	B	C	C	A	B	B
H	B	B	C ^g	A	A	B
I-1	B	C	C	A	B	B
I-2	B	B	B ^{h,i}	A	A	B
I-3	A	A ^j	C	A	A	B
I-4	B	B	B ^{h,i}	A	A	B
R-2	B	B	C	A	A	C
R-3	C	C	C	C	C	C

**[TABLE 803.1
INTERIOR WALL AND CEILING FINISH REQUIREMENTS BY OCCUPANCY^k**

GROUP	SPRINKLERED ^l			NONSPRINKLERED		
	Exit enclosures and exit passageways ^{a,b}	Corridors	Rooms and enclosed spaces ^e	Exit enclosures and exit passageways ^{a,b}	Corridors	Rooms and enclosed spaces ^e
S	B	C	C	A	B	C
U	No restrictions			No restrictions		

For SI: 1 inch = 25.4 mm, 1 square foot = 0.0929 m².

- a. Class C interior finish materials shall be permitted for wainscotting or paneling of not more than 1,000 square feet of applied surface area in the grade lobby where applied directly to a noncombustible base or over furring strips applied to a noncombustible base and fireblocked as required by Section 803.3.1.
- b. In exit enclosures of buildings less than three stories above grade plane of other than Group I-3, Class B interior finish for nonsprinklered buildings and Class C interior finish for sprinklered buildings shall be permitted.
- c. Requirements for rooms and enclosed spaces shall be based upon spaces enclosed by partitions. Where a fire-resistance rating is required for structural elements, the enclosing partitions shall extend from the floor to the ceiling. Partitions that do not comply with this shall be considered enclosing spaces and the rooms or spaces on both sides shall be considered one. In determining the applicable requirements for rooms and enclosed spaces, the specific occupancy thereof shall be the governing factor regardless of the group classification of the building or structure.
- d. Lobby areas in Group A-1, A-2 and A-3 occupancies shall not be less than Class B materials.
- e. Class C interior finish materials shall be permitted in places of assembly with an occupant load of 300 persons or less.
- f. For churches and places of worship, wood used for ornamental purposes, trusses, paneling or chancel furnishing shall be permitted.
- g. Class B material is required where the building exceeds two stories.
- h. Class C interior finish materials shall be permitted in administrative spaces.
- i. Class C interior finish materials shall be permitted in rooms with a capacity of four persons or less.
- j. Class B materials shall be permitted as wainscotting extending not more than 48 inches above the finished floor in exit access corridors.
- k. Finish materials as provided for in other sections of this code.
- l. Applies when the exit enclosures, exit passageways, corridors, or rooms and enclosed spaces are protected by a sprinkler system installed in accordance with Section 903.3.1.1 or 903.3.1.2.]

[803.1.1 Flame-spread and smoke-development tests. Interior wall and ceiling finish materials shall be tested and accorded indices for flame spread and smoke development in accordance with ASTM E 84 or UL 723.]

[803.1.1.1 Classification of flame spread indices. Such interior finish materials shall be grouped in the following flame spread classes in accordance with their flame spread index.]

[Class A: Flame spread 0-25.]

[Class B: Flame spread 26-75.]

[Class C: Flame spread 76-200.]

[803.1.1.2 Interior flame spread index requirements based on occupancy group. Interior wall and ceiling finish shall have a flame spread index not greater than that for the classification rating specified in Table 803.1 for the group and location designated.]

[803.1.1.3 Interior smoke developed index requirements based on occupancy group. Except where permitted for interior trim in Section 806.5, acceptable smoke developed indices shall range from 0-450 with the following restrictions:]

[Exits, corridors _____ 25 or less]

[Occupancy Group I _____ 50 or less]

[Rooms in which the net floor area]

[per occupant is 10 square feet or less] [100 or less]

~~[803.1.2 Room corner test for interior wall or ceiling finish materials (including textiles). As an alternative to Section 803.1.1, interior wall or ceiling finish materials shall be permitted to be tested in accordance with NFPA 286. Interior wall or ceiling finish materials tested in accordance with NFPA 286 shall comply with Section 803.1.2.1. Interior wall and ceiling finish materials tested in accordance with NFPA 286 and meeting the acceptance criteria of Section 803.1.2.1, shall be permitted to be used where a Class A classification in accordance with ASTM E 84 or UL 723 is required.]~~

~~[803.1.2.1 Acceptance criteria for NFPA 286. During the 40 kW exposure, the interior finish shall comply with Item 1. During the 160 kW exposure, the interior finish shall comply with Item 2. During the entire test, the interior finish shall comply with Items 3 and 4.]~~

~~[1. During the 40 kW exposure, flames shall not spread to the ceiling.]~~

~~[2. During the 160 kW exposure, the interior finish shall comply with the following:]~~

~~[2.1. Flame shall not spread to the outer extremity of the sample on any wall or ceiling.]~~

~~[2.2. Flashover, as defined in NFPA 286, shall not occur.]~~

~~[3. The peak rate of heat release throughout the NFPA 286 test shall not exceed 800 kW.]~~

~~[4. The total smoke released throughout the NFPA 286 test shall not exceed 10,764 square feet (1,000 m²).]~~

~~[803.1.3 Room corner test for textile wall coverings and expanded vinyl wall coverings. Textile wall coverings and expanded vinyl wall coverings shall meet the criteria of Section 803.1.3.1 when tested in the manner intended for use in accordance with the Method B protocol of NFPA 265 using the product mounting system, including adhesive.]~~

~~[803.1.3.1 Acceptance criteria for NFPA 265. During the 40 kW exposure the interior finish shall comply with Item 1. During the 150 kW exposure, the interior finish shall comply with Item 2. During the entire test, the interior finish shall comply with Item 3.]~~

~~[1. During the 40 kW exposure, flames shall not spread to the ceiling.]~~

~~[2. During the 150 kW exposure, the interior finish shall comply with the following:]~~

~~[2.1. Flame shall not spread to the outer extremities of the samples on the 8 foot by 12-foot (203 mm by 305 mm) walls.]~~

~~[2.2. Flashover, as described in NFPA 265, shall not occur.]~~

~~[3. The total smoke released throughout the NFPA 265 test shall not exceed 10,764 square feet (1,000 m²).]~~

~~[803.1.4 Flame-spread and smoke-development tests for textile wall or ceiling coverings. Specimens shall be tested and indexed per ASTM E 84 or UL 723, and classified for flame spread per Section 803.1.4.1.]~~

~~[803.1.4.1 Acceptance criteria for textile and expanded vinyl wall or ceiling coverings tested to ASTM E 84 or UL 723. Textile wall and ceiling coverings and expanded vinyl wall and ceiling coverings shall have a Class A flame spread index per Section 803.1.1.1; shall meet the smoke developed index requirements of Section 803.1.1.3; and shall be protected by an automatic sprinkler system installed in accordance with Section 903.3.1.1 or 903.3.1.2.]~~

803.11 Interior finish requirements based on group. Interior wall and ceiling finish shall have a flame spread index and smoke-developed index not greater than that specified in Table 803.11 of this code for the group and location designated. Interior wall and ceiling finish materials tested in accordance with NFPA 286 and meeting the acceptance criteria of Section 803.1.2.1 of this code, shall be permitted to be used where a Class A classification, in accordance with ASTM E 84 or UL 723, is required.

**TABLE 803.11
INTERIOR WALL AND CEILING FINISH REQUIREMENTS BY OCCUPANCY^k**

GROUP	SPRINKLERED ^l			NONSPRINKLERED		
	Interior exit stairways, interior exit ramps and exit passageways ^{a,b}	Corridors and enclosure for exit access stairways and exit access ramps	Rooms and enclosed spaces ^c	Interior exit stairways, interior exit ramps and exit passageways ^{a,b}	Corridors and enclosure for exit access stairways and exit access ramps	Rooms and enclosed spaces ^c
A-1 & A-2	B	B	C	A	A ^d	B ^e
A-3 ^f , A-4, A-5	B	B	C	A	A ^d	C
B, E, M, R-1	B	B	B	A	A	B
F	B	C	C	A	B	B
H	B	B	C ^g	A	A	B
I-1	B	C	C	A	B	B
I-2	B	B	B ^{h,i}	A	A	B
I-3	A	A ^j	C	A	A	B
I-4	B	B	B ^{h,i}	A	A	B
R-2	B	B	C	A	A	C
R-3	C	C	C	C	C	C
S	B	C	C	A	B	C

**TABLE 803.11
INTERIOR WALL AND CEILING FINISH REQUIREMENTS BY OCCUPANCY^k**

GROUP	<u>SPRINKLERED^l</u>			<u>NONSPRINKLERED</u>		
	<u>Interior exit stairways, interior exit ramps and exit passageways^{a,b}</u>	<u>Corridors and enclosure for exit access stairways and exit access ramps</u>	<u>Rooms and enclosed spaces^c</u>	<u>Interior exit stairways, interior exit ramps and exit passageways^{a,b}</u>	<u>Corridors and enclosure for exit access stairways and exit access ramps</u>	<u>Rooms and enclosed spaces^c</u>
U	No restrictions			No restrictions		

For SI: 1 inch = 25.4 mm, 1 square foot = 0.0929 m².

- a. Class C interior finish materials shall be permitted for wainscoting or paneling of not more than 1,000 square feet (92 m²) of applied surface area in the grade lobby where applied directly to a noncombustible base or over furring strips applied to a noncombustible base and fireblocked as required by Section 803.13.1.
- b. In other than Group I-3 occupancies in buildings less than three stories above grade plane, Class B interior finish for nonsprinklered buildings and Class C interior finish for sprinklered buildings shall be permitted in interior exit stairways and ramps.
- c. Requirements for rooms and enclosed spaces shall be based upon spaces enclosed by partitions. Where a fire-resistance rating is required for structural elements, the enclosing partitions shall extend from the floor to the ceiling. Partitions that do not comply with this shall be considered enclosing spaces and the rooms or spaces on both sides shall be considered one. In determining the applicable requirements for rooms and enclosed spaces, the specific occupancy thereof shall be the governing factor regardless of the group classification of the building or structure.
- d. Lobby areas in Group A-1, A-2 and A-3 occupancies shall not be less than Class B materials.
- e. Class C interior finish materials shall be permitted in places of assembly with an occupant load of 300 persons or less.
- f. For places of religious worship, wood used for ornamental purposes, trusses, paneling or chancel furnishing shall be permitted.
- g. Class B material is required where the building exceeds two stories.
- h. Class C interior finish materials shall be permitted in administrative spaces.
- i. Class C interior finish materials shall be permitted in rooms with a capacity of four persons or less.
- j. Class B materials shall be permitted as wainscoting extending not more than 48 inches above the finished floor in corridors and exit access stairways and ramps.
- k. Finish materials as provided for in other sections of this code.
- l. Applies when protected by an automatic sprinkler system installed in accordance with Section 903.3.1.1 or 903.3.1.2.

[803.2] 803.12 Stability. Interior finish materials regulated by this chapter shall be applied or otherwise fastened in such a manner that such materials will not readily become detached where subjected to room temperatures of 200°F ([93] 93.3°C) for not less than 30 minutes.

[803.3] 803.13 Application of interior finish materials to fire-resistance-rated [structural] or noncombustible building elements. Where interior finish materials are applied on walls, ceilings or structural elements required to have a fire-resistance rating or to be of noncombustible construction, [they] these finish materials shall comply with the provisions of this section.

[803.3.1] 803.13.1 Direct attachment and furred construction. Where walls and ceilings are required by any provision in this code to be of fire-resistance-rated or noncombustible construction, the interior finish material shall be applied directly against such construction or to furring strips not exceeding 1³/₄ inches ([44] 44.5 mm), applied directly against such surfaces. [The intervening spaces between such furring strips shall comply with one of the following:]

803.13.1.1 Furred construction. If the interior finish material is applied to furring strips, the intervening spaces between such furring strips shall comply with one of the following:

1. Be filled with material that is inorganic or noncombustible;
2. Be filled with material that meets the requirements of a Class A material in accordance with Section 803.1.1 or 803.1.2; or
3. Be [~~fire blocked~~] fireblocked at a maximum of 8 feet ([2438] 2438.4 mm) in [~~any~~]

every direction in accordance with Section ~~[BC 717]~~ 718.

~~[803.3.2]~~ **803.13.2 Set-out construction.** Where walls and ceilings are required to be of fire-resistance-rated or noncombustible construction and walls are set out or ceilings are dropped distances greater than specified in Section ~~[803.3.1]~~ 803.13.1, Class A finish materials, in accordance with Section 803.1.1 or 803.1.2, shall be used ~~[except where]~~.

Exceptions:

1. Where interior finish materials are protected on both sides by an automatic sprinkler system in accordance with Section 903.3.1.1 or 903.3.1.2 ~~[or attached to noncombustible backing or furring strips installed as specified in Section 803.3.1]~~.
2. Where interior finish materials are attached to noncombustible backing or furring strips installed as specified in Section 803.13.1.1.

803.13.2.1 Hangers and assembly members. The hangers and assembly members of such dropped ceilings that are below the ~~[main ceiling line]~~ horizontal-fire-resistance-rated floor or roof assemblies shall be of noncombustible materials~~[- except that in Types III and V construction, fire-retardant-treated wood shall be permitted]~~. The construction of each ~~[set-out]~~ set out wall and horizontal fire-resistance-rated floor or roof assembly shall be of fire-resistance-rated construction as required elsewhere in this code.

Exception: In Type III and V construction, fire-retardant-treated wood shall be permitted for use as hangers and assembly members of dropped ceilings.

~~[803.3.3 Attachment to heavy]~~ **803.13.3 Heavy timber construction.** Wall and ceiling finishes of all classes as permitted in this chapter that are installed directly against the wood decking or planking of Type IV construction or to wood furring strips applied directly to the wood decking or planking shall be fireblocked as specified in Section ~~[803.3.1]~~ 803.13.1.1.

~~[803.3.4]~~ **803.13.4 Materials.** An interior wall or ceiling finish material that is not more than ¼ inch (6.4 mm) thick shall be applied directly ~~[against a noncombustible backing]~~ onto the wall, ceiling or building element without the use of furring strips and shall not be suspended away from the building element to which that finish material is applied.

Exceptions:

1. Noncombustible interior finish materials.
2. Materials that meet the requirements of Class A materials in accordance with Section 803.1.1 or 803.1.2 where the qualifying tests were made with the material ~~[suspended or]~~ furred out from the noncombustible backing.
3. Materials that meet the requirements of Class A materials in accordance with Section 803.1.1 or 803.1.2 where the qualifying tests were made with the material suspended away from the noncombustible backing shall be permitted to be used suspended away from the building element.

~~[803.4 Foam plastics. Foam plastics shall not be used as interior finish except as provided in Section 2603.9. This section shall apply both to exposed foam plastics and to foam plastics used in conjunction with a textile or vinyl facing or cover.]~~

~~[803.5 Toxicity. Interior wall or ceiling finishes, other than textiles, upon exposure to fire, shall not produce products of decomposition or combustion that are more toxic in point of concentration than those given off by wood or paper when decomposing or burning under comparable conditions as tested in accordance with NFPA 269.]~~

SECTION BC 804 INTERIOR FLOOR FINISH

804.1 General. Interior floor finish and floor covering materials shall comply with this section.

804.2 Classification. Interior floor finish and floor covering materials required by Section 804.4.1 of this code to be of Class I or II materials shall be classified in accordance with NFPA 253 or ASTM E 648. The classification referred to herein corresponds to the classifications determined by NFPA 253 or ASTM E 648 as follows: Class I, 0.45 watts/cm² or greater; Class II, 0.22 watts/cm² or greater.

804.3 Testing and identification. Interior floor finish and floor covering materials shall be tested by an approved agency in accordance with NFPA 253 or ASTM E 648 and identified by a hang tag or other suitable method so as to identify the manufacturer or supplier and style, and shall indicate the interior floor finish or floor covering classification [~~according to~~] in accordance with Section 804.2 of this code. Carpet-type floor coverings shall be tested as proposed for use, including underlayment. Test reports confirming the information provided in the manufacturer's product identification shall be furnished to the department upon request.

804.4 Interior floor finish limitations. In buildings and spaces classified in Occupancy Group H and in all exits and exit passageways of any occupancy group, floor finishes shall be of noncombustible materials.

Exception: Interior floor finish may be of combustible materials in the following spaces. Carpet-type materials must be able to withstand a minimum critical radiant flux as specified in Section 804.4.1.

1. Buildings of Type VB Construction.
2. Interior stairs in buildings of Type III, IV and V construction in Occupancy Group B, F, M or S-2, when the buildings are two stories in height or less.
3. Interior stairs in buildings of Type III, IV and V construction in Occupancy Groups R-2 and R-3 when the buildings are three stories in height or less.
4. Interior stairs in buildings of Type III, IV and V construction in Occupancy Group R-2 when occupied by three families or less.

804.4.1 Minimum critical radiant flux. Interior floor finishes shall not be less than Class I in Occupancy Groups I-2 and I-3 and not less than Class II in Occupancy Groups A, B, E, H, I-4, M, R-1, R-2 and S. In all other occupancy groups, the interior floor finish shall comply with the DOC FF-1 “pill test” (CPSC 16 CFR, Part 1630).

804.5 Volatile organic compounds emissions in carpet and carpet cushion. [~~On and after July 1, 2013 carpet~~] Carpet and carpet cushion as defined in Section 17-1401 of the *Administrative Code* shall comply with the limits on volatile organic compound emissions set forth in Chapter 14 of Title 17 of such code.

SECTION BC 805 COMBUSTIBLE FLOORING MATERIALS IN TYPES I AND II CONSTRUCTION

805.1 Application. Combustible materials installed on or embedded in floors of buildings of Type I or II construction shall comply with Sections 805.1.1 through 805.1.4.

[Exception] Exceptions:

1. Stages and platforms constructed in accordance with Sections 410.3 and 410.4, respectively.
2. Bleachers, grandstands and folding and telescopic seating within assembly spaces constructed in accordance with Section 1029.1.1.

805.1.1 Subfloor construction. Floor sleepers, bucks and nailing blocks shall not be constructed of combustible materials, unless the space between the fire-resistance-rated floor assembly and the flooring is either solidly filled with noncombustible materials or fireblocked in accordance with Section ~~[717]~~ 718, and provided that such open spaces shall not extend under or through permanent partitions or walls.

805.1.2 Wood finish flooring. Wood finish flooring is permitted to be attached directly to the embedded or fireblocked wood sleepers and shall be permitted where cemented directly to the top surface of approved fire-resistance-rated floor assemblies or directly to a wood subfloor attached to sleepers as provided for in Section 805.1.1.

805.1.3 Insulating boards. Combustible insulating boards not more than ½-inch (12.7 mm) thick and covered with finish flooring are permitted where attached directly to a noncombustible floor assembly or to wood subflooring attached to sleepers as provided for in Section 805.1.1.

805.1.4 Carpet-type floor coverings. Carpet-type floor coverings are permitted where cemented directly to the top surface of approved fire-resistance-rated construction or directly to a wood subfloor attached to sleepers as provided for in Section 805.1.1.

SECTION BC 806 DECORATIVE MATERIALS AND TRIM

806.1 Decorations. All decorations shall comply with the requirements of the *New York City Fire Code*.

806.2 Reserved.

806.3 Reserved.

806.4 Reserved.

806.5 Foam plastic as trim. Foam plastic used as trim shall comply with Section 2604.2 and shall not be permitted in [~~Group R-3~~] occupancies other than Group R-3, within individual dwelling units of Group R-1 and R-2 occupancies, [~~and where~~] or unless approved in accordance with [~~the special provisions of~~] Section 2603.9. [~~Foam plastics used as trim in any occupancy shall comply with the requirements of Section 2604.2.~~]

[~~806.4~~] **806.6 Pyroxylin plastic.** Imitation leather or other material consisting of or coated with a pyroxylin or similarly hazardous base shall not be used in Group A occupancies.

[~~806.5~~] **806.7 Interior trim.** Material, other than foam plastic used as interior trim, shall have a minimum Class C flame spread index [~~as described in Section 803.1.1~~] and maximum smoke-developed index [~~of 450,~~] when tested in accordance with ASTM E 84 or UL 723 as described in Section 803.1.1. Combustible trim, excluding handrails and guardrails, shall not exceed 10 percent of the specific wall or ceiling area in which it is attached.

[~~806.6~~] **806.8 Interior floor-wall base.** Interior floor-wall base that is 6 inches ([~~152~~] 152.4 mm) or less in height shall be tested in accordance with Section 804.2 and shall be not [~~be~~] less than Class II. Where a Class I floor finish is required, the floor-wall base shall be Class I.

Exception: Interior trim materials that comply with Section [~~806.5~~] 806.7.

SECTION BC 807 INSULATION

807.1 Insulation. Thermal and acoustical insulation shall comply with Section [~~719~~] 720.

SECTION BC 808 ACOUSTICAL CEILING SYSTEMS

808.1 Acoustical ceiling systems. The quality, design, fabrication and erection of metal suspension systems for acoustical tile and lay-in panel ceilings in buildings or structures shall conform [~~with~~] to generally accepted engineering practice, the provisions of this chapter and other applicable requirements of this code.

808.1.1 Materials and installation. Acoustical materials complying with the interior finish requirements of Section 803 shall be installed in accordance with the manufacturer's recommendations and applicable provisions for applying interior finish.

808.1.1.1 Suspended acoustical ceilings. Acoustical ceilings that are to be suspended below floor or roof construction by means of a framing system shall consist of supporting hangers of minimum ¼-inch diameter (6.4 mm) steel rods, carrying channels of minimum 1½-inch deep ([~~38~~] 38.1 mm) cold-rolled steel weighing [~~0.457~~] 0.440 pounds per linear foot [~~0.707~~]

kg/m)] (0.681 kg/m), and a supporting grid complying with Appendix R. Use of wire hangers shall not be permitted. Direct hung suspension systems shall not be permitted.

Exception: Acoustical ceiling systems in [Group] Groups R-2 and R-3 occupancies shall be permitted to be installed in accordance with ASTM C 635 and ASTM C 636 without modifications.

808.1.1.2 Fire-resistance-rated construction. Acoustical ceiling systems that are part of fire-resistance-rated construction shall be installed in the same manner used in the assembly tested and shall comply with the provisions of Chapter 7.

§ 10. Chapter 9 of the New York city building code, as amended by local law number 141 for the year 2013, the definition of “Natural Gas Alarm” and sections 28-908.7.1.1.2 and 28-908.10 as added by local law number 157 for the year 2016, sections 28-903.1.1, 28-903.2.11.9, 28-903.3.1.1.1, 28-903.3.3, 28-904.2, 28-904.2.1, 28-907.1, 28-907.1.1, 28-907.1.1.1, 28-908.10, 28-908.11 and 28-917.1.1 as amended by local law number 195 for the year 2018, section 28-903.2.2 as amended by local law number 78 for the year 2015, section 28-907.2.2 as added by local law number 51 for the year 2014, section 28-907.2.11.5 as added by local law number 113 for the year 2018, section 28-907.3.5 and item 8 of section 28-911.1.5 as added by local law number 17 for the year 2014, section 28-908.7 as amended by, and section 28-908.7.4 as renumbered by, local law number 10 for the year 2014, and section 28-908.7.3 as amended by, and section 28-908.7.3.1 as added by, local law number 191 for the year 2018, is amended to read as follows:

CHAPTER 9 FIRE PROTECTION SYSTEMS

SECTION BC 901 GENERAL

901.1 Scope. The provisions of this chapter shall specify where fire protection systems are required and shall apply to the design, installation and operation of fire protection systems.

901.1.1 Referenced standards. Where this code makes reference to the nationally recognized standards NFPA 13, NFPA 13D, NFPA 13R, NFPA 14, NFPA 20, [ø] NFPA 72, or NFPA 92, such standard shall be as modified for New York City in accordance with Appendix Q of this code.

901.2 Fire protection systems. Fire protection systems shall be installed, repaired, operated and maintained in accordance with this code and the *New York City Fire Code*. Any fire protection system for which an exception or reduction to the provisions of this code has been granted shall be considered to be a required system.

Exception: Any fire protection system or portion thereof not required by this code shall be permitted to be installed provided that such system meets the requirements of this code.

901.2.1 Fire protection systems within a building. Fire protection systems shall be dedicated to one building only.

Exception: Upon review and approval by the commissioner and the Fire Department, multiple buildings may be served by one fire protection system.

901.3 Modifications. No person shall remove or modify any fire protection system installed or maintained under the provisions of this code or the *New York City Fire Code* without approval by the commissioner.

901.4 Threads. Threads provided for Fire Department connections to sprinkler systems, standpipes, yard hydrants or any other fire hose connection shall be compatible with the connections used by the Fire Department.

901.5 Acceptance tests. Fire protection systems shall be tested in accordance with the requirements of this code and the *New York City Fire Code*. When required[;] by this chapter, the tests shall be conducted in the presence of the department or an approved agency. Tests required by this code, the *New York City Fire Code* and the standards listed in this code shall be conducted at the expense of the owner or the owner's representative. It shall be unlawful to occupy portions of a structure until the required fire protection systems within that portion of the structure have been tested and approved.

901.6 Supervisory service. Where required, fire protection systems shall be monitored by a central supervising station in accordance with NFPA 72.

901.6.1 Automatic sprinkler systems. Automatic sprinkler systems shall be monitored by a central supervising station.

Exceptions:

1. A central supervising station is not required for automatic sprinkler systems protecting one- and two-family dwellings.
2. Limited area sprinkler systems serving [~~fewer~~] no more than [~~20~~] 6 sprinkler heads.

901.6.2 Fire alarm systems. Fire alarm systems required by the provisions of Section 907.2 of this code and the *New York City Fire Code* shall be monitored by a central supervising station in accordance with Section [~~907.14~~] 907.6.5.

Exceptions:

1. Single- and multiple-station smoke alarms and carbon monoxide alarms required by Section 907.2.11.
2. Smoke detectors in Group I-3 occupancies.
3. Supervisory service is not required for automatic sprinkler systems in one- and two-family dwellings.

901.6.3 Group H. Manual fire alarm, automatic fire-extinguishing and emergency alarm systems in Group H occupancies shall be monitored by an approved supervising station.

Exception: When approved by the Fire Department, on-site monitoring at a constantly attended location shall be permitted provided that notifications to the Fire Department will be equal to those provided by a central supervising station.

901.7 Fire areas. Where buildings, or portions thereof, are divided into fire areas so as not to exceed the limits established for requiring a fire protection system in accordance with this chapter, such fire areas shall be separated by fire barriers constructed in accordance with Section 707 or horizontal assemblies constructed in accordance with Section ~~[712]~~ 711, or both, having a fire-resistance rating of not less than that determined in accordance with Section ~~[707.3.9]~~ 707.3.10.

901.8 Construction documents. Construction documents shall comply with Chapter 1 of Title 28 of the *Administrative Code*, Section 107 and other applicable provisions of this code and its referenced standards.

901.9 Special provisions for prior code buildings. The provisions of this chapter shall apply to alterations and changes of use or occupancy to prior code buildings in accordance with Sections 901.9.1 through 901.9.6.

901.9.1 Additions, alterations or repairs. Additions, alterations, renovations or repairs to existing systems shall conform to that required for new systems without requiring the existing system to comply with all of the requirements of this code, except as otherwise required in Sections 901.9.2 through 901.9.6. Additions, alterations or repairs shall not cause an existing installation to become unsafe, hazardous or overloaded.

901.9.1.1 Minor additions, alterations, renovations and repairs. Minor additions, alterations, renovations and repairs to existing systems shall meet the provisions for new construction, unless such work is done in the same manner and arrangement as was in the existing system, is not hazardous and is approved.

901.9.2 Additional requirements based on change of occupancy or use. Fire protection systems governed by this chapter shall be provided:

1. To the entire building as if the building were hereafter erected, where a change is made in the main use or dominant occupancy of such building.
2. Throughout a space, where a change is made in the occupancy group classification or usage of the space.

901.9.3 Additional requirements for enlargements. Fire protection systems shall be provided in enlarged portions of a building and where this chapter would require such systems in new construction for a space or building.

Exception: Section 901.9.3 shall not require sprinklers to be installed in enlarged portions of unsprinklered buildings to be occupied exclusively as one- or two-family dwellings. This exception shall not apply where sprinklers are otherwise required by the provisions of Sections 901.9.2 or 901.9.4.

901.9.4 Additional requirements based on value of alterations. Fire protection systems shall be provided to buildings and spaces in accordance with the provisions of Sections 901.9.4.1 through 901.9.4.3.

901.9.4.1 Alterations requiring fire protection systems throughout a building. If the value of alterations to the building equals or exceeds 60 percent of the value of the existing building, or, in the case of a building containing 4 or more dwelling units, 50 percent of the value of the existing building, the entire building shall be made to comply with the fire protection requirements of this chapter as if it were hereafter erected.

901.9.4.2 Alterations requiring fire protection systems in the space being altered. If the value of alterations of a space is between 30 percent and 60 percent of the value of the existing building, or, in the case of a building containing 4 or more dwelling units, if the value of alterations of a space is between 30 percent and 50 percent of the value of the existing building, those portions of the building being altered shall be made to comply with the fire protection requirements of this chapter.

901.9.4.3 Additional requirements for buildings containing 4 or more dwelling units. For buildings containing 4 or more dwelling units, if the value of alterations to an existing space classified in [~~occupancy group~~] Occupancy Group R-1 or R-2 exceeds 50 percent of the value of the space, such space shall be made to comply with the fire protection requirements of this chapter.

901.9.5 Additional provisions. In buildings or spaces not otherwise required to provide fire protection systems in accordance with this chapter, fire protection systems shall be provided for the types of alterations described in Sections 901.9.5.1 through 901.9.5.4.

901.9.5.1 Additional requirements for providing smoke and carbon monoxide alarms in dwelling units during alterations involving removal of existing interior finishes. Smoke and/or carbon monoxide alarms complying with the location, interconnection and power source requirements of this chapter shall be provided throughout a dwelling unit when alteration work results in the removal of existing and/or installation of new interior wall or ceiling finishes permitting the installation of concealed wiring for all the required alarms throughout the dwelling unit.

901.9.5.2 Additional requirements for providing standpipes in newly constructed stair shafts. Where an alteration includes the addition or replacement of an entire exit stair shaft that is a required means of egress, the entire shaft shall be equipped with a standpipe in accordance with Section 905.

901.9.5.3 Additional requirements for enlargements of buildings with existing standpipe systems. Where the alteration involves the addition of stories to a building with an existing standpipe system, and one or more stair shafts are not currently equipped with standpipes, standpipes shall be provided to all stair shafts in accordance with this chapter.

Exception: Additional standpipes are not required where:

1. The alteration involves the addition of only one story;
2. Existing standpipes in existing stair shafts are extended in accordance with this chapter;
3. Standpipe hose connections are provided in compliance with Section 905.4, Item 6; and
4. The demand on the standpipe system, including any additional demand, with respect to flow and pressure does not exceed the capacity of the existing approved system.

901.9.5.4 Additional requirements for enlargements of buildings with no existing standpipe systems. Where the alteration involves the addition of stories to a building with no existing standpipe system, standpipes shall be provided to all stair shafts in accordance with this chapter.

Exception: Standpipes are not required where:

1. the alteration involves the addition of only one story;
2. the completed building does not exceed 7 stories; and
3. the completed building does not exceed 85 feet (25.9 m) in height.

901.9.6 Seismic supports. The determination as to whether seismic requirements apply to an alteration shall be made in accordance with the [~~1968 Building Code~~] *1968 Building Code* and interpretations by the department relating to such determinations. Any applicable seismic loads and requirements shall be permitted to be determined in accordance with Chapter 16 of this code or the *1968 Building Code* and Reference Standard RS 9-6 of such code.

SECTION BC 902 DEFINITIONS

902.1 Definitions. The following [~~words and~~] terms [~~shall, for the purposes of this chapter, and as used elsewhere in this code, have the meanings shown herein.~~] are defined in Chapter 2:

ALARM NOTIFICATION APPLIANCE. [~~A fire alarm system component such as a bell, horn, speaker, light or text display that provides audible, tactile or visible outputs, or any combination thereof.~~]

ALARM SIGNAL. [A signal indicating an emergency requiring immediate action, such as a signal indicative of fire.]

ALARM VERIFICATION FEATURE. [A feature of automatic fire detection and alarm systems to reduce unwanted alarms wherein smoke detectors report alarm conditions for a minimum period of time, or confirm alarm conditions within a given time period, after being automatically reset, in order to be accepted as a valid alarm initiation signal.]

ANIMAL SERVICE FACILITY.

ANNUNCIATOR. [A unit containing one or more indicator lamps, alphanumeric displays or other equivalent means in which each indication provides status information about a circuit, condition or location.]

AUDIBLE ALARM NOTIFICATION APPLIANCE. [A notification appliance that alerts by the sense of hearing.]

AUTOMATIC. [As applied to fire protection devices, a device or system providing an emergency function as a result of a predetermined temperature rise, rate of temperature rise or combustion products, without the necessity for human intervention.]

AUTOMATIC FIRE-EXTINGUISHING SYSTEM. [An approved system of devices and equipment that automatically detects a fire and discharges an approved fire extinguishing agent onto or in the area of a fire.]

AUTOMATIC SMOKE DETECTION SYSTEM. [A fire alarm system that has initiation devices that utilize smoke detectors for protection of an area such as a room or space with detectors to provide early warning of fire.]

AUTOMATIC SPRINKLER SYSTEM. [An automatic sprinkler system, for fire protection purposes, is an integrated system of underground and overhead piping designed in accordance with fire protection engineering standards. The system includes a suitable water supply. The portion of the system above the ground is a network of specially sized or hydraulically designed piping installed in a structure or area, generally overhead, and to which automatic sprinklers are connected in a systematic pattern. The system is usually activated by heat from a fire and discharges water over the fire area.]

AUTOMATIC WATER MIST SYSTEM.

AVERAGE AMBIENT SOUND LEVEL. [The root mean square, A-weighted sound pressure level measured over a 24-hour period, or the time any person is present, whichever time period is less.]

CARBON DIOXIDE EXTINGUISHING SYSTEMS. [A system supplying carbon dioxide (CO₂) from a pressurized vessel through fixed pipes and nozzles. The system includes a manual or automatic actuating mechanism.]

CARBON MONOXIDE ALARM. [A single or multiple station alarm responsive to carbon monoxide.]

CARBON MONOXIDE DETECTOR. [~~A listed device that senses carbon monoxide.~~]

CARBON ~~MONOXIDE PRODUCING~~ MONOXIDE-PRODUCING EQUIPMENT. [~~Any furnace, boiler, water heater, fireplace, cooking appliance, gas clothes dryer, apparatus, appliance or device that burns coal, kerosene, oil, wood, fuel gases and other petroleum products including, but not limited to, methane, natural gas, liquefied natural gas and manufactured fuel gases.~~]

CEILING LIMIT. [~~The maximum concentration of an air-borne contaminant to which one may be exposed, as published in DOL 29 CFR Part 1910.1000.~~]

CLEAN AGENT. [~~Electrically nonconducting, volatile or gaseous fire extinguishant that does not leave a residue upon evaporation.~~]

COMMERCIAL COOKING SYSTEM. [~~A system consisting of commercial cooking equipment, exhaust hood, filters, exhaust duct system, fire suppression system and other related appurtenances designed to capture grease-laden cooking vapors and exhaust them safely to the outdoors.~~]

COMMERCIAL MOTOR VEHICLE.

CONSTANTLY ATTENDED LOCATION. [~~A designated location at a facility staffed by trained personnel on a continuous basis where alarm or supervisory signals are monitored and facilities are provided for notification of the Fire Department or other emergency services.~~]

DELUGE SPRINKLER SYSTEM. [~~A sprinkler system employing open sprinklers attached to a piping system connected to a water supply through a valve that is opened by the operation of a detection system installed in the same areas as the sprinklers. When this valve opens, water flows into the piping system and discharges from all sprinklers attached thereto.~~]

DETECTOR, HEAT. [~~A fire detector that senses heat—either abnormally high temperature or rate of rise, or both.~~]

DRY-CHEMICAL EXTINGUISHING AGENT. [~~A powder composed of small particles, usually of sodium bicarbonate, potassium bicarbonate, urea potassium based bicarbonate, potassium chloride or monoammonium phosphate, with added particulate material supplemented by special treatment to provide resistance to packing, resistance to moisture absorption (caking) and the proper flow capabilities.~~]

ELECTRICAL CIRCUIT PROTECTIVE SYSTEM.

EMERGENCY ALARM SYSTEM. [~~A system to provide indication and warning of emergency situations involving hazardous materials.~~]

EMERGENCY VOICE/ALARM COMMUNICATIONS. [~~Dedicated manual or automatic facilities for originating and distributing voice instructions, as well as alert and evacuation signals pertaining to a fire emergency, to the occupants of a building.~~]

FIRE ALARM BOX, MANUAL. [~~See “Manual Fire Alarm Box.”~~]

FIRE ALARM CONTROL UNIT. [~~A system component that receives inputs from automatic and manual fire alarm devices and may be capable of supplying power to detection devices and transponder(s) or off premises transmitter(s). The control unit may be capable of providing a transfer of power to the notification appliances and transfer of condition to relays or devices.~~]

FIRE ALARM SIGNAL. [~~A signal initiated by a fire alarm initiating device such as a manual fire alarm box, automatic fire detector, water flow switch, or other device whose activation is indicative of the presence of a fire or fire signature.~~]

FIRE ALARM SYSTEM. [~~A system or portion of a combination system consisting of components and circuits arranged to monitor and annunciate the status of fire alarm or supervisory signal-initiating devices and to initiate the appropriate response to those signals.~~]

FIRE AREA. [~~The aggregate floor area enclosed and bounded by fire walls, fire barriers, exterior walls and/or horizontal assemblies of a building. Areas of the building not provided with surrounding walls shall be included in the fire area if such areas are included within the horizontal projection of the roof or floor next above.~~]

FIRE COMMAND CENTER. [~~The principal attended or unattended location where the status of detection, alarm communications and control systems is displayed, and from which the system(s) can be manually controlled.~~]

FIRE DETECTOR, AUTOMATIC. [~~A device designed to detect the presence of a fire signature and to initiate action.~~]

FIRE PROTECTION SYSTEM. [~~Approved devices, equipment and systems or combinations of systems used to detect a fire, activate an alarm, extinguish or control a fire, control or manage smoke and products of a fire or any combination thereof.~~]

FIRE PUMP. [~~A pump used exclusively for fire protection. A pump used only to fill a tank is not a fire pump.~~]

Fire pump, automatic standpipe. [~~A fire pump located at or below street level that supplies the lower 300 feet of a standpipe system or a combined standpipe and sprinkler system.~~]

Fire pump, foam. [~~A fire pump used to boost water supply pressures in a fire protection system where such system uses firefighting foam as an additive.~~]

Fire pump, limited service. [~~A fire pump with a motor rating not exceeding 30 hp and utilizing a limited service fire pump controller.~~]

Fire pump, special service. [~~A fire pump that is located above street level and that receives its water supply from a gravity tank or suction tank.~~]

Fire pump, sprinkler booster pump. [~~A fire pump that supplies sprinkler systems only.~~]

Fire pump, water mist system. [~~A fire pump used to boost water supply pressures in a fire protection system where such system utilizes water misting technology.~~]

FIRE SAFETY FUNCTIONS. [~~Building and fire control functions that are intended to increase the level of life safety for occupants or to control the spread of harmful effects of fire.~~]

FOAM-EXTINGUISHING SYSTEM. [~~A special system discharging foam made from concentrates, either mechanically or chemically, over the area to be protected.~~]

HALOGENATED EXTINGUISHING SYSTEM. [~~A fire extinguishing system using one or more atoms of an element from the halogen chemical series: fluorine, chlorine, bromine and iodine.~~]

INITIATING DEVICE. [~~A system component that originates transmission of a change of state condition, such as in a smoke detector, manual fire alarm box or supervisory switch.~~]

LIMITED AREA SPRINKLER SYSTEM. [~~An automatic sprinkler system serving fewer than 20 sprinkler heads on any single connection.~~]

LISTED. [See Chapter 1 of Title 28 of the *Administrative Code*.]

MANUAL FIRE ALARM BOX. [A manually operated device used to initiate an alarm signal.]

MULTIPLE-STATION ALARM DEVICE. [~~Two or more single station alarm devices that are capable of interconnection such that actuation of one causes all integral or separate audible alarms to operate. It also can consist of one single station alarm device having connections to other detectors or to a manual fire alarm box.~~]

MULTIPLE-STATION SMOKE ALARM. [~~Two or more single station alarm devices that are capable of interconnection such that actuation of one causes the appropriate alarm signal to operate in all interconnected alarms.~~]

NOTIFICATION ZONE.

POST-FIRE SMOKE PURGE SYSTEM. [~~A mechanical or natural ventilation system intended to move smoke from the smoke zone to the exterior of the building. Such systems are intended for the timely restoration of operations and overhaul activities once a fire is extinguished. Post fire smoke purge systems are not intended or designed to be life safety systems.~~]

PRESIGNAL SYSTEM. [~~A fire alarm system having a feature that allows initial fire alarm signals to sound in a constantly attended central location and for which a human action is subsequently required to achieve a general alarm, or a feature that allows the control equipment to delay the general alarm by more than 1 minute after the start of the alarm processing.~~]

RECORD DRAWINGS. [~~Drawings (“as built”) that document the location of all devices, appliances, wiring sequences, wiring methods and connections of the components of a fire alarm system as installed.~~]

SINGLE-STATION SMOKE ALARM. [~~An assembly incorporating the detector, the control equipment and the alarm sounding device in one unit, operated from a power supply either in the unit or obtained at the point of installation.~~]

SMOKE ALARM. [A single or multiple station alarm responsive to smoke.]

SMOKE DETECTOR. [~~A listed device that senses visible or invisible particles of combustion.~~]

SMOKEPROOF ENCLOSURE. [~~An exit stairway designed and constructed so that the movement of the products of combustion produced by a fire occurring in any part of the building into the enclosure is limited.~~]

STANDPIPE SYSTEM. [~~Piping installed in a building or structure that serves to transfer water from a water supply to hose connections at one or more locations in a building or structure for fire-fighting purposes.~~]

STANDPIPE, TYPES OF. [Standpipe types are as follows:]

Automatic dry. [~~A dry standpipe system, normally filled with pressurized air, that is arranged through the use of a device, such as dry pipe valve, to admit water into the system piping automatically upon the opening of a hose valve. The water supply for an automatic dry standpipe system shall be capable of supplying the system demand.~~]

Automatic wet. [~~A wet standpipe system that has a water supply that is capable of supplying the system demand automatically.~~]

Manual dry. [~~A dry standpipe system that does not have a permanent water supply attached to the system. Manual dry standpipe systems require water from a Fire Department pumper to be pumped into the system through the Fire Department connection in order to meet the system demand.~~]

Manual wet. [~~A wet standpipe system connected to a water supply for the purpose of maintaining water within the system but that does not have a water supply capable of delivering the system demand attached to the system. Manual wet standpipe systems require water from a Fire Department pumper to be pumped into the system in order to meet the system demand.~~]

Semiautomatic dry. [~~A dry standpipe system that is arranged through the use of a device, such as a deluge valve, to admit water into the system piping upon activation of a remote control device located at a hose connection. A remote control activation device shall be provided at each hose connection. The water supply for a semiautomatic dry standpipe system shall be capable of supplying the system demand.~~]

STANDPIPE SYSTEM, CLASSES OF. [Standpipe classes are as follows:]

Class I system. [~~A system providing 2½ inch (64 mm) hose connections to supply water for use by the Fire Department and those trained in handling heavy fire streams.~~]

Class II system. [~~A system providing 1½ inch (38 mm) hose stations to supply water for use primarily by the building occupants or by the Fire Department during initial response.~~]

Class III system. [~~A system providing 1½ inch (38 mm) hose stations to supply water for use by building occupants and 2½ inch (64 mm) hose connections to supply a larger volume of water for use by the Fire Department and those trained in handling heavy fire streams.~~]

SUPERVISING STATION. [~~A facility that receives signals from protected premises' fire alarm systems and at which personnel are in attendance at all times to respond to these signals.~~]

Supervising station, central. [~~A supervising station that is listed and approved by the Fire Department for central station service.~~]

Supervising station, proprietary. [~~A supervising station under the same ownership as the protected premises' fire alarm system(s) that it supervises (monitors) and to which alarm, supervisory, or trouble signals are received and where personnel are in attendance at all times to supervise operation and investigate signals.~~]

Supervising station, remote. [~~A supervising station to which alarm, supervisory, or trouble signals or any combination of those signals emanating from protected premises' fire alarm systems are received and where personnel are in attendance at all times to respond.~~]

SUPERVISORY SERVICE. [~~The service required to monitor performance of guard tours and the operative condition of fixed suppression systems or other systems for the protection of life and property.~~]

SUPERVISORY SIGNAL. [~~A signal indicating the need for action in connection with the supervision of guard tours, fire suppression systems or equipment, fire alarm systems, or the maintenance features of related systems.~~]

SUPERVISORY SIGNAL-INITIATING DEVICE. [~~An initiation device, such as a valve supervisory switch, water level indicator or low air pressure switch on a dry pipe sprinkler system, whose change of state signals an off-normal condition and its restoration to normal of a fire protection or life safety system, or a need for action in connection with the supervision of guard tours, fire suppression systems or equipment, fire alarm systems, or the maintenance features of related systems.~~]

TIRES, BULK STORAGE OF. [~~Storage of tires where the area available for storage exceeds 20,000 cubic feet (566 m³).~~]

TROUBLE SIGNAL. [~~A signal initiated by the fire alarm system or device indicative of a fault in a monitored circuit or component.~~]

VALUE (OF ALTERATIONS TO DETERMINE REQUIRED FIRE PROTECTION). [~~The value of alterations shall be determined by adding the estimated cost of the proposed alteration, excluding minor alterations and ordinary repairs, computed as of the time of submitting the application for construction document approval, to the actual cost of any and all alterations made in the preceding 12 month period. Where the proposed alteration includes an enlargement, the value of such alteration shall include the cost of the enlargement.~~]

VALUE (OF EXISTING BUILDING OR SPACE). [~~See Section 202.~~]

VISIBLE ALARM NOTIFICATION APPLIANCE. [~~A notification appliance that alerts by the sense of sight.~~]

~~[WET-CHEMICAL] WET CHEMICAL EXTINGUISHING [SYSTEM] AGENT.~~ [A solution of water and potassium carbonate based chemical, potassium acetate based chemical or a combination thereof, forming an extinguishing agent.]

~~WIRELESS PROTECTION SYSTEM.~~ [A system or a part of a system that can transmit and receive signals without the aid of wire.]

~~ZONE.~~ [A defined area within the protected premises. A zone can define an area from which a signal can be received, an area to which a signal can be sent or an area in which a form of control can be executed.]

~~ZONE, NOTIFICATION.~~ [An area within a building or facility covered by notification appliances which are activated simultaneously.]

SECTION BC 903 AUTOMATIC SPRINKLER SYSTEMS

903.1 General. Automatic sprinkler systems shall comply with this section. Installation of automatic sprinkler systems shall comply with the special inspection requirements of Chapter 17.

903.1.1 Alternative protection. Where permitted by the *New York City Fire Code*, the Fire Department may approve the installation of alternative automatic fire-extinguishing systems complying with this code and the *New York City Fire Code* in lieu of automatic sprinkler protection.

903.1.2 Construction documents. Construction documents for automatic sprinkler systems shall contain plans that include the following data and information:

1. The location and size of water supplies and the location, ~~[spacing,]~~ number, and type of sprinkler heads to be used, with approximate location and size of all feed mains, valves and other essential features of the system. For hydraulically calculated systems, hydraulic data substantiating pipe sizes shown shall be submitted and hydraulic reference points and areas must be indicated on the plan. If any other methods are utilized to size the sprinkler system and its components, as allowed by NFPA 13, supporting documentation shall be submitted to the department.
2. A diagram showing the proposed sprinkler system in relation to principal construction features of the building, such as its size, walls, columns, and partitions; and such other information as may be necessary for the evaluation of the system.
3. The location, number, and type of any electrical or automatic devices or alarms to be used in the system.
4. In buildings where a new separate fire sprinkler system is required, the available water pressure at the top and bottom floors of each zone shall be shown on the riser diagram.
5. For street pressure-fed systems and fire pumps, a statement from the New York City Department of Environmental Protection, giving the minimum water pressure in the main serving the building.

903.2 Where required. Approved automatic sprinkler systems in new buildings and structures shall be provided in the locations described in [~~this section~~] Sections 903.2.1 through 903.2.13.

Exceptions:

1. Sprinklers shall not be required in electrical equipment rooms where all of the following conditions are met:
 - 1.1 The room is dedicated to electrical equipment only.
 - 1.2 Only dry-type electrical equipment is used.
 - 1.3 Equipment is installed in a 2-hour fire-rated enclosure including protection for penetrations.
 - 1.4 No combustible storage is permitted to be stored in the room.
2. Sprinklers shall not be permitted in elevator machine rooms and elevator machinery spaces.
3. Sprinklers shall not be required in rooms and spaces protected by an alternative fire suppression system in accordance with the *New York City Fire Code* and Section 904 of this code.

903.2.1 Group A. An automatic sprinkler system shall be provided throughout buildings and portions thereof used as Group A occupancies as provided in this section. For Group A-1, A-2, A-3 and A-4 occupancies, the automatic sprinkler system shall be provided throughout the story where the fire area containing the Group A-1, A-2, A-3 or A-4 occupancy is located, and throughout all stories from the Group A occupancy to, and including, the levels of exit discharge serving the Group A occupancy. For Group A-5 occupancies, the automatic sprinkler system shall be provided in the spaces indicated in Section 903.2.1.5. In all Group A occupancies providing live entertainment, dressing rooms and property rooms used in conjunction with such assembly occupancy shall be provided with an automatic sprinkler system. Stages shall comply with Section [~~410.6~~] 410.7.

903.2.1.1 Group A-1. An automatic sprinkler system shall be provided for fire areas containing Group A-1 occupancies and intervening floors of the building where one of the following conditions exists:

1. The fire area exceeds 12,000 square feet (~~[1115]~~ 1114.8 m²).
2. The fire area has an occupant load of 300 or more.
3. The fire area is located on a floor other than a level of exit discharge serving such occupancies.
4. The fire area contains a multitheater complex.

903.2.1.2 Group A-2. An automatic sprinkler system shall be provided for Group A-2 occupancies where any one of the following conditions exists:

1. The fire area exceeds 5,000 square feet (464.5 m²).
2. The fire area has an occupant load of 300 or more.
3. The aggregate occupant load of all fire areas occupied by Group A, located on any given floor other than the level of exit discharge, is 300 or more.
4. The A-2 occupancy is used as a cabaret.

903.2.1.3 Group A-3. An automatic sprinkler system shall be provided for fire areas containing Group A-3 occupancies and intervening floors of the building where one of the following conditions exists:

1. The fire area exceeds 12,000 square feet (~~[1115]~~ 1114.8 m²).
2. The fire area has an occupant load of 300 or more.
3. The aggregate occupant load of all fire areas occupied by Group A, located on any given floor other than the level of exit discharge, is 300 or more.

Exception: Areas used exclusively as participant sports areas where the main floor area is located at the same level as the level of exit discharge of the main entrance and exit.

903.2.1.4 Group A-4. An automatic sprinkler system shall be provided for fire areas containing Group A-4 occupancies and intervening floors of the building where one of the following conditions exists:

1. The fire area exceeds 12,000 square feet (~~[1115]~~ 1114.8 m²).
2. The fire area has an occupant load of 300 or more.
3. The aggregate occupant load of all fire areas occupied by Group A, located on any given floor other than the level of exit discharge, is 300 or more.

Exception: Areas used exclusively as participant sports areas where the main floor area is located at the same level as the level of exit discharge of the main entrance and exit.

903.2.1.5 Group A-5. An automatic sprinkler system shall be provided in all enclosed areas of the structure, including but not limited to the concession concourse, concession stands, retail areas, press boxes and other accessory occupancies, in excess of 1,000 square feet (~~[93]~~ 92.9 m²).

903.2.1.6 Assembly occupancies on roofs. Where an occupied roof has an assembly occupancy with an occupant load exceeding 100 for Group A-2 and 300 for other Group A occupancies, all floors between the occupied roof and the level of exit discharge shall be

equipped with an automatic sprinkler system in accordance with Section 903.3.1.1 or 903.3.1.2.

Exception: Open parking garages of Type I or Type II construction.

903.2.1.7 Multiple fire areas. An automatic sprinkler system shall be provided where multiple fire areas of Group A-1, A-2, A-3 or A-4 occupancies share exit or exit access components and the combined occupant load of these fire areas is 300 or more.

903.2.2 Group B. An automatic sprinkler system shall be installed for Group B occupancies as provided in Sections 903.2.2.1 and 903.2.2.2.

903.2.2.1 Ambulatory health care facilities. An automatic sprinkler system shall be installed throughout all fire areas containing a Group B ambulatory health care facility occupancy ~~[when either of the following conditions exists at any time:]~~. In buildings where ambulatory care is provided on levels other than the level of exit discharge, an automatic sprinkler system shall be installed throughout the entire floor where such care is provided as well as all floors below, and all floors between the level of ambulatory care and the nearest level of exit discharge, including the level of exit discharge.

~~[1. Four or more care recipients are incapable of self preservation.]~~

~~[2. One or more care recipients who are incapable of self preservation are located at other than the level of exit discharge serving such an occupancy.]~~

903.2.2.2 Animal service facilities. An automatic sprinkler system shall be provided for animal service facilities. ~~[This provision shall be retroactive and shall apply to all such facilities in existence on the effective date of this provision, and such facilities shall achieve compliance no later than December 31, 2016.]~~

Exceptions:

1. Animal service facilities ~~[which]~~ that provide 24 hour in-person supervision of animals sheltered therein and are equipped with smoke alarms.
2. Animal service facilities that were in operation on or before December 31, 2016, and are equipped with an automatic smoke detection system.

903.2.3 Group E. An automatic sprinkler system shall be provided for Group E occupancies as follows:

1. Throughout all Group E fire areas greater than ~~[20,000 square feet (1858 m²)]~~ 12,000 square feet (1114.8 m²) in area.
2. Throughout every portion of educational buildings below the level of exit discharge.

Exception: An automatic sprinkler system is not required in any fire area or area below the level of exit discharge where every classroom throughout the building has ~~[at least]~~ not fewer than one exterior exit door at ground level without intervening

corridors, passageways, [~~or exit enclosures~~] interior exit stairways or ramps or exit passageways.

903.2.4 Group F. An automatic sprinkler system shall be provided throughout all buildings containing a Group F occupancy where any one of the following conditions exists:

1. Where a Group F-1 fire area exceeds 12,000 square feet (~~[1115]~~ 1114.8 m²);
2. Where a Group F-1 fire area is located more than three stories above grade plane; [~~or~~]
3. Where the combined area of all Group F-1 fire areas on all floors, including any mezzanines, exceeds 24,000 square feet (~~[2230]~~ 2229.7 m²); [~~or~~]
4. Where required by Section 280 of the *New York State Labor Law* for “factory buildings” defined in Section 2 of such law~~[-];~~or
5. Where a Group F-1 occupancy used for the manufacture of upholstered furniture or mattresses exceeds 2,500 square feet (232.3 m²).

903.2.4.1 Woodworking operations. An automatic sprinkler system shall be provided throughout [~~any~~] all Group F-1 occupancy fire [~~area~~] areas that [~~contains wood working~~] contain woodworking operations in excess of 2,500 square feet (~~[232]~~ 232.3 m²) in area that generate finely divided combustible waste or use finely divided combustible materials.

903.2.4.2 Repair garages. An automatic sprinkler system shall be provided throughout all buildings used as repair garages in accordance with Section 406, as follows:

1. Buildings two or more stories in height, including basements, with a fire area containing a repair garage exceeding 10,000 square feet (929 m²).
2. One-story buildings with a fire area containing a repair garage exceeding 12,000 square feet (~~[1115]~~ 1114.8 m²).
3. A Group F-1 fire area used for the repair of commercial trucks or buses where the fire area exceeds 5,000 square feet (~~[464]~~ 464.5 m²).
4. Buildings with a repair garage servicing vehicles parked in the basement.

903.2.4.3 Group F-1 fire areas. An automatic sprinkler system shall be provided throughout any Group F-1 occupancy fire area where any one of the following conditions exists:

1. The fire area exceeds 7,500 square feet (~~[697]~~ 696.8 m²).
2. The fire area of any size is located more than three stories above grade.

903.2.5 Group H. Automatic sprinkler systems shall be provided in high-hazard occupancies as required in the New York City Fire Code and Sections 903.2.5.1 through 903.2.5.3 [~~and the New York City Fire Code~~] of this code.

903.2.5.1 General. An automatic sprinkler system shall be installed in Group H occupancies. An automatic sprinkler system shall be installed throughout buildings with a main use or dominant occupancy of Group H.

903.2.5.2 Group H-5 occupancies. An automatic sprinkler system shall be installed throughout buildings containing Group H-5 occupancies. The design of the sprinkler system shall be not [be] less than that required by this code for the occupancy hazard classifications in accordance with Table 903.2.5.2. Where the design area of the sprinkler system consists of a corridor protected by one row of sprinklers, the maximum number of sprinklers required to be calculated is 13.

**TABLE 903.2.5.2
GROUP H-5 SPRINKLER DESIGN CRITERIA**

LOCATION	OCCUPANCY HAZARD CLASSIFICATION
Fabrication areas	Ordinary Hazard Group 2
Service corridors	Ordinary Hazard Group 2
Storage rooms without dispensing	Ordinary Hazard Group 2
Storage rooms with dispensing	Extra Hazard Group 2
Corridors	Ordinary Hazard Group 2

903.2.5.3 Pyroxylin plastics. An automatic sprinkler system shall be provided in buildings, or portions thereof, where cellulose nitrate film or pyroxylin plastics are manufactured, stored or handled in quantities exceeding 100 pounds ([45] 45.4 kg).

903.2.6 Group I. An automatic sprinkler system shall be provided in Group I occupancies. An automatic sprinkler system shall be installed throughout buildings with a main use or dominant occupancy of Group I.

[Exception:] Exceptions:

1. An automatic sprinkler system installed in accordance with Section 903.3.1.2 or 903.3.1.3 shall be allowed in Group I-1 facilities if located in an I-1 occupancy building or a residential building, provided such building is six stories or less in height.
2. An automatic sprinkler system is not required where Group I-4 day care facilities are at the level of exit discharge and where every room where care is provided has not fewer than one exterior exit door.
3. In buildings where Group I-4 day care is provided on levels other than the level of exit discharge, an automatic sprinkler system in accordance with Section 903.3.1.1 shall be installed on the entire floor where care is provided, all floors between the level of care and the level of exit discharge, and all floors below the level of exit discharge other than areas classified as an open parking garage.

903.2.7 Group M. An automatic sprinkler system shall be provided throughout buildings containing a Group M occupancy where one of the following conditions exists:

1. A Group M fire area exceeds 12,000 square feet (~~[1115]~~ 1114.8 m²).
2. A Group M fire area is located more than three stories above grade plane.
3. The combined area of all Group M fire areas on all floors, including any mezzanines, exceeds 24,000 square feet (~~[2230]~~ 2229.7 m²).
4. A Group M occupancy used for the display and sale of upholstered furniture or mattresses exceeds 5,000 square feet (464.5 m²).

903.2.7.1 High-piled storage. An automatic sprinkler system shall be provided in accordance with the *New York City Fire Code* in all buildings of Group M where storage of merchandise is in high-piled or rack storage arrays.

903.2.7.2 Group M fire areas. An automatic sprinkler system shall be provided throughout any Group M occupancy fire area where any one of the following conditions exists:

1. The fire area exceeds 7,500 square feet (~~[697]~~ 696.8 m²).
2. The fire area of any size contains an unenclosed stair or escalator connecting two or more floors

903.2.8 Group R. An automatic sprinkler system shall be installed in Group R fire areas. An automatic sprinkler system shall be installed throughout buildings with a main use or dominant occupancy of Group R.

Exception: An automatic sprinkler system shall not be required in detached one- and two-family dwellings and multiple single-family dwellings (townhouses), provided that such structures are not more than three stories above grade plane in height and have separate means of egress.

903.2.9 Group S-1. An automatic sprinkler system shall be provided throughout all buildings containing a Group S-1 occupancy where any one of the following conditions exists:

1. A Group S-1 fire area exceeds 12,000 square feet (~~[1115]~~ 1114.8 m²)[~~;~~].
2. The building is greater than 1,000 square feet (92.9 m²) in area and the main use or dominant occupancy is Group S-1[~~;~~~~;~~].
3. A Group S-1 fire area is located more than three stories above grade plane.
4. The combined area of all Group S-1 fire areas on all floors, including any mezzanines, exceeds 24,000 square feet (~~[2230]~~ 2229.7 m²).
5. A Group S-1 fire area used for the storage of commercial motor vehicles where the fire area exceeds 5,000 square feet (464.5 m²).

6. A Group S-1 occupancy used for the storage of upholstered furniture or mattresses exceeds 2,500 square feet (232.3 m²).

903.2.9.1 Group S-1 fire areas. An automatic sprinkler system shall be provided throughout any Group S-1 occupancy fire area where the fire area exceeds 500 square feet [~~46~~ 46.5 m²].

903.2.9.2 Bulk storage of tires. Buildings and structures where the area for the storage of tires exceeds 500 square feet [~~47~~ 46.5 m²] or 7,500 cubic feet ([~~212~~] 212.3 m³) shall be equipped throughout with an automatic sprinkler system in accordance with Section 903.3.1.1.

903.2.9.3 High-piled storage. An automatic sprinkler system shall be provided in accordance with the *New York City Fire Code* in all buildings or portions thereof in Group S-1 occupancies where the storage of merchandise is in high-piled or rack storage arrays.

903.2.10 Group S-2. An automatic sprinkler system shall be installed throughout buildings greater than 5,000 square feet ([~~465~~] 464.5 m²) in area where the main use or dominant occupancy is Group S-2.

903.2.10.1 Commercial parking garages. An automatic sprinkler system shall be provided throughout buildings used for storage of commercial trucks [~~or~~], buses or other commercial motor vehicles where the fire area exceeds 5,000 square feet ([~~465~~] 464.5 m²).

903.2.10.2 Group S-2 fire areas. An automatic sprinkler system shall be provided throughout any Group S-2 occupancy fire area greater than 5,000 square feet ([~~465~~] 464.5 m²).

903.2.10.3 Parking garages. An automatic sprinkler system shall be provided throughout buildings classified as enclosed parking garages in accordance with Section 406.4 or where an open or enclosed parking garage is located beneath other occupancy groups.

Exception: Parking garages located beneath Group R-3 occupancies.

903.2.10.4 High-piled storage. An automatic sprinkler system shall be provided in all buildings or portions thereof of Group S-2 occupancies in accordance with the *New York City Fire Code*.

903.2.11 Specific building areas and hazards. An automatic sprinkler system shall be installed for building design or hazards in the locations set forth in Sections 903.2.11.1 through 903.2.11.13.

903.2.11.1 Above- or below-grade stories. An automatic sprinkler system shall be installed throughout every above- or below-grade story of all buildings where the floor area exceeds 1,500 square feet (139.4 m²) and where [~~at least~~] not fewer than one of the following types of exterior wall openings is provided:

1. Openings below grade that lead directly to ground level by an exterior stairway complying with Section [~~1009~~] 1011 or an outside ramp complying with Section

[1010] 1012. Openings shall be located in each 50 linear feet (15 240 mm), or fraction thereof, of exterior walls facing onto a street, public way or frontage space, in the story on at least one side. The required openings shall be distributed such that the lineal distance between adjacent openings does not exceed 50 feet (15 240 mm).

2. Openings entirely above the adjoining ground level totaling [~~at least~~] not less than 20 square feet (1.86 m²) in each 50 linear feet (15 240 mm), or fraction thereof, of exterior walls facing onto a street, public way or frontage space, in the story on at least one side. The required openings shall be distributed such that the lineal distance between adjacent openings does not exceed 50 feet (15 240 mm). The bottom of the clear opening shall not exceed 36 inches (914.4 mm) measured from the floor.

903.2.11.1.1 Opening dimensions and access. Such openings shall have a minimum dimension of not less than 30 inches (762 mm). Such openings shall be accessible to the Fire Department from the exterior and shall not be obstructed in a manner that [~~fire fighting~~] firefighting or rescue cannot be accomplished from the exterior.

903.2.11.1.2 Openings on one side only. Where such openings in a story are provided on only one side and the opposite wall of such story is more than 100 feet (30 480 mm) from such openings, the story shall be equipped throughout with an approved automatic sprinkler system, or openings as specified above shall be provided on [~~at least~~] not fewer than two sides of the story.

903.2.11.1.3 Below-grade stories. Where any portion of a below-grade story is located more than 75 feet (22 860 mm) from openings required by Section 903.2.11.1, or where walls, partitions, or other obstructions are installed that restrict the application of water from hose streams, the below-grade story shall be equipped throughout with an approved automatic sprinkler system.

903.2.11.2 Other above-grade stories. An automatic sprinkler system shall be installed throughout every above-grade story of buildings below a height of 100 feet (30 480 mm), other than the first story or ground floor, on which access is not provided directly from the outdoors by at least one window or readily identifiable access panel within each 50 feet (15 240 mm) or fraction thereof of horizontal length of every wall that fronts on a street or frontage space required pursuant to Section 501.3.1.

903.2.11.2.1 Opening dimensions and access. Such windows shall be openable from the inside or breakable from both the inside and the outside, and shall have a size when open of at least 24 inches by 36 inches ([~~610~~] 609.6 mm by [~~914~~] 914.4 mm). Such panels shall be openable from both the inside and outside and shall have a height when open of 48 inches ([~~1219~~] 1220 mm) and a width of at least 32 inches ([~~813~~] 812.8 mm). The sill of the window or panel shall not be higher than 36 inches ([~~914~~] 914.4 mm) above the inside floor. Where not all of the windows are openable or breakable, the windows intended to satisfy the requirements of this section shall be readily identifiable.

903.2.11.3 Other below-grade stories. An automatic sprinkler system shall be installed throughout every first basement or cellar story below grade of buildings on which access is not provided directly from the outdoors within each 100 feet (30 480 mm) or fraction thereof

of horizontal length of every wall that fronts on a street or frontage space required pursuant to Section 501.3.1.

Exceptions:

1. One- and two-family dwellings need not provide direct access.
2. Any building classified in Occupancy Group R-2 not more than three stories in height and with not more than two dwelling units on any story need not provide direct access when such first basement or cellar story is used for dwelling units or for uses accessory to the residential use in the building.
3. Except as provided in Exception 2, above, for Group R-1 and R-2 occupancies, only one direct access from the outdoors to the first basement or cellar story consisting of a stair or door shall be required when such story is used for dwelling units or for uses accessory to the residential use in the building.

903.2.11.3.1 Opening dimensions and access. Such access shall be by stairs, doors, windows or other means that provide an opening 48 inches (~~[1219]~~ 1220 mm) high and 32 inches (~~[813]~~ 812.8 mm) wide, the sill of which shall not be higher than 36 inches (~~[914]~~ 914.4 mm) above the inside floor. If an areaway is used to provide below grade access, the minimum horizontal dimension shall be at least one-third the depth of the areaway or 6 feet (~~[1829]~~ 1828.8 mm), whichever is less.

903.2.11.4 Signs obstructing openings. Where wall signs are erected to cover doors or windows of existing buildings, access panels shall be provided as necessary to comply with the requirements of Section 903.2.11.

903.2.11.5 Compliance with the *New York State Multiple Dwelling Law*. Nothing in Section 903.2.11 shall be construed so as to supersede any applicable provisions of Section 54 of the *New York State Multiple Dwelling Law* relating to access to cellars or basements in multiple dwellings.

903.2.11.6 Rubbish and linen chutes. An automatic sprinkler system shall be installed at the top of rubbish and linen chutes, in chute access rooms, and in their terminal rooms. Chutes ~~[extending through three or more floors]~~ shall have additional sprinkler heads installed ~~[within such chutes at alternate floors.]~~ at alternate floors and at the lowest intake. Where a rubbish chute extends through a building more than one floor below the lowest intake, or through areas with no openings, such an extension shall have sprinklers installed that are recessed from the drop area of the chute and protected from freezing in accordance with Section 903.3.1.1. Such sprinklers shall be installed at alternate floors, beginning with the second level below the last intake and ending with the floor above the discharge. [Chute] All chute sprinklers shall be accessible for servicing and shall not obstruct the vertical path for rubbish or linens.

903.2.11.7 Buildings ~~[over]~~ 55 feet (16 764 mm) or more in height. An automatic sprinkler system shall be installed throughout buildings that have one or more stories with ~~[a floor level~~

having] an occupant load of 30 or more [that is] located 55 feet (16 764 mm) or more above the lowest level of Fire Department vehicle access, measured to the finished floor.

Exceptions:

1. Open parking structures without any other occupancy groups, unless otherwise required.
2. Occupancies in Group F-2, unless required by the New York State Department of Labor.

903.2.11.8 Ducts conveying hazardous exhausts. Where required by the *New York City Mechanical Code*, automatic sprinklers shall be provided in ducts conveying hazardous exhaust[?] or flammable or combustible materials.

Exception: Ducts [in which] where the largest cross-sectional diameter of the duct is less than 10 inches (254 mm).

903.2.11.9 Commercial cooking operations. An automatic sprinkler system shall not be installed in a commercial kitchen exhaust hood and duct system. Fire-extinguishing systems shall be installed in commercial cooking systems in accordance with this code and the *New York City Fire Code*.

903.2.11.10 Other buildings, occupancies and areas. In addition to the requirements of Section 903.2, the provisions indicated in Table 903.2.11.10 also require the installation of a suppression system for certain buildings and areas. Suppression systems shall also be required as provided for in other sections of this code, the *New York City Fuel Gas Code*, and the *New York City Mechanical Code*.

**TABLE 903.2.11.10
ADDITIONAL REQUIRED SUPPRESSION SYSTEMS**

Occupancy Group, specified use, materials or equipment (in alphabetical order)	Code section
Aerosol warehouses	FC 2804.4.1
<u>Aircraft hangers</u>	<u>BC 412.4.6,</u> <u>BC 412.4.6.1,</u> <u>BC 412.6.5</u>
<u>Airport traffic control towers</u>	<u>BC 412.3.6</u>
Atriums	BC 404.3
Automated storage; buildings with	FC 2309.2
<u>Children’s play structures</u>	<u>BC 424.3</u>
Chutes; refuse and laundry	BC [708.13] 713.13

Occupancy Group, specified use, materials or equipment (in alphabetical order)	Code section
Chute vestibules	BC Appendix Q [21.16.2.1.1] <u>22.15.2.2.1</u>
Cold storage buildings: ice plants, food plants and food processing rooms with foam insulation up to 10 inches in thickness	BC 2603.3
Combustible fibers; storage at waterfront structures	FC 2906.6
Combustible fibers, loose; storage of more than 1,000 sq ft of	FC 2904.5
Commercial cooking systems	BC [904.11] <u>904.12</u> FC 904.11
Commercial cooking systems with solid fuel storage	FC 904.11.7
Commercial cooking system with Type I hood	BC 904.2.1 MC 509.1
Covered mall and open mall buildings	BC [402.9] <u>402.5</u>
Dead end public streets; buildings on	FC 503.8.1
Dip tank rooms	FC 1505.1
Dip tanks	FC 1505.6.1
Dry cleaning machines	FC 1208.3
Dry cleaning plants	FC 1208.2
Drying rooms	BC 417.4
Elevator lobbies	BC [708.14.1] <u>3006.1.1</u>
Exhausted enclosures	FC 2703.8.5.3
Extra-high-rack combustible storage; buildings with	FC 2308.5.1
Flammable and combustible liquid in Group H-2 or H-3 areas	FC 3405.3.7.3
Flammable and combustible liquid storage rooms	FC 3404.3.7.5.1
Flammable and combustible liquid storage warehouses	FC 3404.3.8.4
Flammable finishes	BC 416.5

Occupancy Group, specified use, materials or equipment (in alphabetical order)	Code section
Fuel-oil tanks and fuel-oil burning equipment; rooms containing	MC 1305.13.3
Furnaces: Class A and B	FC 2106.1
Furnaces: Class C and D	FC 2106.2
Gas rooms	FC 2703.8.4
Glazing in smoke partition	BC [711.2] <u>710.2</u>
Group H-2	BC [415.6.2.4] <u>415.9.1.3</u>
Group H-5, including but not limited to: workstations, gas cabinet, exhausted enclosures, pass-throughs in exit access corridors and exhaust ducts	BC [415.8] <u>415.11</u>
Group I-2	BC [407.5] <u>407.6</u>
Hardening and tempering tanks	FC 1505.8.4
Hazardous exhaust system ducts	MC [510.7] <u>510.8</u>
Hazardous materials; indoor handling or use of	FC 2705.1.8
Hazardous materials; indoor storage of	FC 2704.5
Hazardous Production Material ("HPM") corridors	FC 1803.10.3
Hazardous Production Material ("HPM") exhaust ducts	FC 1803.10.4
Hazardous Production Material ("HPM") facilities	FC 1803.10
Hazardous Production Material ("HPM") gas cabinets	FC 1803.10.2
Hazardous Production Material ("HPM") work station exhaust	FC 1803.10.1.1
High Pressure Gas Installations; buildings with	FGC G.2.3
Highly toxic and toxic compressed gases; exhausted enclosures for	FC 3704.1.3
Highly toxic and toxic compressed gases; gas cabinets containing	FC 3704.1.2
Highly toxic and toxic compressed gases; gas rooms utilizing	FC 3704.2.2.6

Occupancy Group, specified use, materials or equipment (in alphabetical order)	Code section
Highly toxic and toxic compressed gases; outdoor storage of	FC 3704.3.3
High-rise buildings	BC 403.3
Incidental uses	BC 509.4.2
Equipment platforms	BC [505.5.2] <u>505.3.2</u>
Kiosks in covered mall buildings	BC [402.11] <u>402.6.2</u>
Kiosks, displays, booths, or concession stands; covered	FC 314.5.1
Laboratory units; non-production	BC [424.6.1] <u>427.6.1</u>
Liquefied petroleum gas ("LPG") within buildings accessible to the public; storage of	FC 3809.9
Liquids, Class II and III, below grade storage of	FC 3404.3.5.1
Liquids, Class II and III, below grade storage of, accessory to retail	BC 414.2.5.1
Medical gas; storage of	FC 3006.2.1
Organic coatings; manufacturing of	BC 418.1
Oxidizer, solid and liquid; storage areas	FC 4004.1.4
Plastic light diffusing system	BC 2606.7.4
Pyroxylin plastic; areas with	FC 4204.1.1
Pyroxylin plastic; storage and manufacturing	FC 4204.2
Pyroxylin plastic; storage vaults	FC 4204.1.3
Rack storage	FC 2308.2
Radioactive materials and radiation-producing equipment; uses and occupancies involving	BC [425.3.4] <u>428.3.4</u>
Resin application areas	FC 1511.3
Silane gas; exhausted enclosures or gas cabinets for	FC 4106.2.2
Small arms ammunition and primers, black powder or smokeless propellant; storage of	FC 3306.7

Occupancy Group, specified use, materials or equipment (in alphabetical order)	Code section
Solid-piled and shelf storage	FC 2307.2
Smoke-protected assembly seating	BC [4028.6.2.3] <u>1029.6.2.3</u>
Special amusement buildings	BC 411.4
Spray booths and rooms	FC 1504.6
Spray booths involving the use of organic peroxide coatings	FC 1509.6
Spray finishing in Group A, E, I or R	FC 1504.1
Stages	BC [410.6] <u>410.7</u>
Sterilization systems; rooms with	FC 3506.3.2
Storage	FC Table 2306.2 FC 2306.4
Substandard width public streets; buildings on	FC 503.8.2
Textile ceiling finish	BC 803
Textile wall coverings	BC 803
Underground buildings and spaces	BC 405.3
Unlimited area buildings	BC 507

903.2.11.11 Steel-plated and vault-like occupancies. An automatic sprinkler system shall be installed throughout all steel-plated or similarly reinforced or secured vault-like occupancies regardless of area.

903.2.11.12 Refuse collection and disposal areas. An automatic sprinkler system shall be installed throughout all areas used for the storage and sorting of refuse and recyclables.

903.2.11.13 Laundry drying areas. An automatic sprinkler system shall be installed in spaces in which two or more clothes drying machines are installed. Sprinkler heads shall be spaced to cover the areas 5 feet (1524 mm) on all sides of the drying machines.

903.2.12 During construction. Automatic sprinkler systems required during construction, alteration and demolition operations shall be provided in accordance with [~~Chapter 33 and~~] the *New York City Fire Code* and Chapter 33 of this code.

903.2.13 Type IV construction with cross-laminated timber (CLT) or structural composite lumber (SCL). Automatic sprinkler systems in accordance with NFPA 13 shall be required throughout buildings utilizing Type IV construction with CLT or SCL as follows:

1. In all occupancies where the building is more than three stories above grade plane.
2. In Group B occupancies, where a floor exceeds 28,500 square feet (2647.7 m²).

903.3 Installation requirements. Automatic sprinkler systems shall be designed and installed in accordance with Sections 903.3.1 through ~~[903.3.6]~~ 903.3.8.

903.3.1 Standards. Sprinkler systems shall be designed and installed in accordance with Section 903.3.1.1, 903.3.1.2 or 903.3.1.3.

903.3.1.1 NFPA 13 sprinkler systems. Where the provisions of this code require that a building or portion thereof be equipped throughout with an automatic sprinkler system in accordance with this section, sprinklers shall be installed throughout in accordance with NFPA 13 ~~[as modified in Appendix Q]~~ except as provided in Section 903.3.1.1.1 and 903.2 of this code.

903.3.1.1.1 Exempt locations protected by other means. When approved by the Fire Department, automatic sprinklers shall not be required in the following:

1. In rooms or areas protected with an approved automatic fire detection system in accordance with Section 907.2 that will respond to visible or invisible particles of combustion, and an alternative automatic fire-extinguishing system in accordance with this code and the *New York City Fire Code*. Sprinklers shall not be omitted from any room merely because it is of fire-resistance-rated construction or contains electrical equipment. This exemption shall not apply to a generator or transformer room unless, in addition to the above requirements, such room is separated from the remainder of the building by walls and floor/ceiling or roof/ceiling assemblies having a fire-resistance rating of not less than 2 hours, and the generator in such room shall not use high pressure flammable gas in excess of 15 psig (~~[103]~~ 103.4 kPa gauge).
2. Machine rooms, machinery spaces, control rooms and control spaces associated with occupant evacuation elevators designed in accordance with Section 3008.

903.3.1.2 NFPA 13R sprinkler systems. Where allowed in buildings of Group R, up to and including six stories in height, automatic sprinkler systems shall be installed throughout in accordance with NFPA 13R ~~[as modified in Appendix Q]~~.

The number of stories of Group R occupancies constructed in accordance with Sections 510.2 and 510.4 shall be measured from the horizontal assembly creating separate buildings.

903.3.1.2.1 Balconies and decks. Sprinkler protection shall be provided for exterior balconies, decks and ground-floor patios of dwelling units where the building is of Type V construction and automatic sprinkler protection is required for the Group R occupancy. Side wall sprinklers that are used to protect such areas shall be permitted to be located such that their deflectors are within 1 inch (~~[25]~~ 25.4 mm) to 6 inches (~~[152]~~ 152.4 mm) below the structural members, and a maximum distance of 14 inches (~~[356]~~ 355.6 mm)

below the deck of the exterior balconies and decks that are constructed of open wood joist construction.

903.3.1.2.2 Open-ended corridors. Sprinkler protection and freeze protection shall be provided in open-ended corridors and associated exterior stairways and ramps as specified in Section 1027.6, Exception 3.

903.3.1.3 NFPA 13D sprinkler systems. Where allowed, automatic sprinkler systems in one- and two-family dwellings and townhouses, up to and including six stories in height, shall be installed throughout in accordance with NFPA 13D [as modified].

903.3.2 Quick-response and residential sprinklers. Where automatic sprinkler systems are required by this code, quick-response or residential automatic sprinklers shall be installed in all of the following areas in accordance with Section 903.3.1 and their listings:

1. Throughout all spaces within a smoke compartment containing [~~patient dwelling~~] care recipient sleeping units in Group I-2 in accordance with this code.
2. Throughout all spaces within a smoke compartment containing treatment rooms in ambulatory care facilities.
- [2-] 3. Dwelling units and sleeping units in Group [~~R and~~] I-1 and R occupancies.
- [3-] 4. Light-hazard occupancies as defined in NFPA 13.

903.3.3 Obstructed locations. Automatic sprinklers shall be installed with due regard to obstructions that will delay activation or obstruct the water distribution pattern. Automatic sprinklers shall be installed in or under covered kiosks, displays, booths, concession stands, or equipment that exceeds 4 feet ([~~1219~~] 1220 mm) in width. Not less than a 3-foot ([~~914~~] 914.4 mm) clearance shall be maintained between automatic sprinklers and the top of piles of combustible fibers.

Exception: Kitchen equipment under exhaust hoods protected with a fire-extinguishing system in accordance with this code and the *New York City Fire Code*.

903.3.4 Actuation. Automatic sprinkler systems shall be automatically actuated unless [~~otherwise~~] specifically provided for in this code.

903.3.5 Water supplies. Water supplies for automatic sprinkler systems shall comply with this section and the standards referenced in Section 903.3.1. The potable water supply shall be protected against back flow in accordance with the requirements of this section, the *New York City Plumbing Code*, and Rules of the New York City Department of Environmental Protection.

903.3.5.1 Domestic services. Where the domestic service provides the water supply for the automatic sprinkler system, the supply shall be in accordance with NFPA 13, 13R and 13D.

903.3.5.1.1 [~~Limited area sprinkler systems.~~ ~~Limited area sprinkler systems serving fewer than 20 sprinklers on any single connection are permitted to be connected to the~~

~~domestic service where a wet automatic standpipe is not available. Limited area sprinkler systems connected to domestic water supplies shall comply with NFPA 13.]~~

~~[The domestic service shall be capable of supplying the simultaneous domestic demand and the sprinkler demand required to be hydraulically calculated by NFPA 13, NFPA 13R or NFPA 13D.]~~

[903.3.5.1.2] Residential combination services. A single combination water supply shall be permitted in accordance with NFPA 13R.

903.3.5.2 Secondary on-site water supply. ~~[A secondary on-site water supply equal to the hydraulically calculated sprinkler demand, including the hose stream requirement, shall be provided for high-rise buildings in Seismic Design Category C or D as determined by this code, and in any high-rise building with occupied floors located more than 300 feet (91 440 mm) above the lowest level of Fire Department vehicle access. The secondary water supply shall have a duration not less than 30 minutes as determined by the occupancy hazard classification in accordance with NFPA 13.]~~ A secondary on-site water supply for high-rise buildings shall be provided in accordance with Section 403.3.3.

903.3.6 Hose threads. Fire hose threads and fittings used in connection with automatic sprinkler systems shall be approved and compatible with Fire Department hose threads.

903.3.7 Fire Department connections. The location of Fire Department connections for automatic sprinkler systems shall be installed in accordance with Sections 905 and 912.

903.3.8 Limited area sprinkler systems. Limited area sprinkler systems shall be in accordance with the standards listed in Section 903.3.1 except as provided in Sections 903.3.8.1 through 903.3.8.5.

903.3.8.1 Number of sprinklers. Limited area sprinkler systems shall not exceed six sprinklers in any single fire area.

903.3.8.2 Occupancy hazard classification. Only areas classified by NFPA 13 as Light Hazard or Ordinary Hazard Group 1 shall be permitted to be protected by limited area sprinkler systems.

903.3.8.3 Piping arrangement. Where a limited area sprinkler system is installed in a building with an automatic wet standpipe system, sprinklers shall be supplied by the standpipe system. Where a limited area sprinkler system is installed in a building without an automatic wet standpipe system, water shall be permitted to be supplied by the plumbing system provided that the plumbing system is capable of simultaneously supplying domestic and sprinkler demands.

903.3.8.4 Supervision. Control valves shall not be installed between the water supply and sprinklers unless the valves are of an approved indicating type that are supervised or secured in the open position.

903.3.8.5 Calculations. Hydraulic calculations in accordance with NFPA 13 shall be provided to demonstrate that the available water flow and pressure are adequate to supply all sprinklers installed in any single fire area with discharge densities corresponding to the hazard classification.

903.4 Sprinkler system supervision and alarms. ~~[All valves]~~ Valves controlling the water supply for automatic sprinkler systems, pumps, tanks, water levels and temperatures, critical air pressures and water-flow switches on all sprinkler systems shall be electrically supervised by the fire alarm system where ~~[a]~~ such fire alarm system is required by Section 907.

Exceptions:

1. Automatic sprinkler systems protecting one- and two-family dwellings.
2. Limited area sprinkler systems in accordance with Section 903.3.8.
3. Automatic sprinkler systems installed in accordance with NFPA 13R where a common supply main is used to supply both domestic water and the automatic sprinkler ~~[systems]~~ system, and a separate shutoff valve for the automatic sprinkler system is not provided.
- ~~[3-]~~ 4. Jockey pump control valves that are sealed or locked in the open position.
- ~~[4-]~~ 5. Control valves to commercial kitchen hoods, paint spray booths or dip tanks that are sealed or locked in the open position.
- ~~[5-]~~ 6. Valves controlling the fuel supply to fire pump engines that are sealed or locked in the open position.
- ~~[6-]~~ 7. Trim valves to pressure switches in dry, preaction and deluge sprinkler systems that are sealed or locked in the open position.

903.4.1 Signals and monitoring. Alarm, supervisory and trouble signals shall be distinctly different and shall be automatically transmitted to a central supervising station or when approved by the Fire Department, shall sound an audible signal at a constantly attended location.

Exceptions:

1. Underground key or hub valves in roadway boxes provided by the city or a public utility are not required to be monitored.
2. ~~[Back flow]~~ Backflow prevention device test valves, located in limited area sprinkler system supply piping, shall be locked in the open position. In occupancies required to be equipped with a fire alarm system, the backflow preventer valves shall be electrically supervised by a tamper switch installed in accordance with NFPA 72 and separately annunciated.

903.4.2 Alarms. ~~[Approved]~~ An approved audible ~~[devices]~~ device, located on the exterior of the building in an approved location, shall be connected to ~~[every]~~ each automatic sprinkler system. Such sprinkler water-flow alarm devices shall be activated by water flow equivalent to the flow

of a single sprinkler of the smallest orifice size installed in the system. Alarm devices shall be provided on the exterior of the building in an approved location or in a location approved by the Fire Department, except in buildings equipped with a fire alarm system. Where a fire alarm system is installed, actuation of the automatic sprinkler system shall actuate the building fire alarm system.

903.4.3 Floor control valves. Approved supervised indicating control valves shall be provided at the point of connection to the riser on each floor in high-rise buildings.

903.5 Testing and maintenance. Sprinkler systems shall be tested and maintained in accordance with the *New York City Fire Code*.

~~**903.6 Painting of dedicated sprinkler piping and valve handles.** Dedicated sprinkler piping shall be painted and such painting certified in accordance with Sections 903.6.1 through 903.6.5. In addition to painting, sprinkler piping may also be identified by lettered legend in accordance with ANSI A13.1. Where the piping is required to be listed and labeled, such painting shall not obscure such labeling.~~

- ~~1. Attachments, gauges, valves and operable parts of sprinkler systems other than valve handles.~~
- ~~2. Horizontal branch lines.~~
- ~~3. Where different color coding may be required by Section 3406 of the *New York City Fire Code* for facilities storing, handling, and using flammable and combustible liquids in connection with special operations.]~~

903.6 Painting of dedicated sprinkler piping and valve handles. Dedicated sprinkler piping shall be painted and such painting certified in accordance with Sections 903.6.1 through 903.6.5 of this code. In addition to painting, sprinkler piping may also be identified by lettered legend in accordance with ANSI A13.1. Where the piping is required to be listed and labeled, such painting shall not obscure such labeling.

Exceptions:

1. Attachments, gauges, valves and operable parts of sprinkler systems other than valve handles.
2. Horizontal branch lines.
3. Where different color coding may be required by Section 3406 of the *New York City Fire Code* for facilities storing, handling, and using flammable and combustible liquids in connection with special operations.

903.6.1 New buildings. Cross connections and risers in new buildings, including buildings constructed pursuant to Section 28-101.4.2 of the *Administrative Code*, shall be painted red and the handles of valves serving dedicated sprinklers shall be painted green prior to the hydrostatic pressure test regardless of whether they will be enclosed at a later point in time.

Exception: Where a standpipe system is used as a combination standpipe and sprinkler system, the sprinkler risers and cross connections that are also used for the standpipe system shall be painted red and the handles of valves serving such combination system shall be painted yellow.

903.6.2 Alterations. Cross connections and risers for independent (stand-alone) existing sprinkler systems that are exposed during alterations, including alterations pursuant to Section 28-101.4.2 of the *Administrative Code*, shall be painted red and the handles of valves serving such existing sprinkler systems shall be painted green. Where the alteration requires a hydrostatic pressure test such painting shall be completed prior to such test.

Exception: Where a standpipe system is used as a combination standpipe and sprinkler system, the sprinkler risers and cross connections that are also used for the standpipe system shall be painted red and the handles of valves serving such combination system shall be painted yellow.

903.6.3 Retroactive requirement for completed buildings. Notwithstanding any other provision of law, all exposed risers and cross connections of completed buildings in existence on March 2, 2010, shall be painted red [~~by June 2, 2010,~~] and all handles of valves serving such sprinkler system shall be painted green.

Exception: Where a standpipe system is used as a combination standpipe and sprinkler system, the sprinkler risers and cross connections that are also used for the standpipe system shall be painted red and the handles of valves serving such combination system shall be painted yellow.

903.6.4 Buildings under construction on March 2, 2010. Notwithstanding any other provision of law, where construction documents were approved and permits issued for the construction of a new building or alteration of an existing building prior to March 2, 2010, and the work is not signed off by the department prior to such date, all exposed cross connections and risers in any such building shall be painted red prior to the hydrostatic pressure test, including cross connections and risers that will be enclosed at a later point in time, and handles of valves serving such sprinkler system shall be painted green.

Exceptions:

1. Where a standpipe system is used as a combination standpipe and sprinkler system, the sprinkler risers and cross connections that are also used for the standpipe system shall be painted red and the handles of valves serving such combination system shall be painted yellow.
2. Cross connections and risers enclosed prior to March 2, 2010, need not be painted.

903.6.5 Certification of completion of system painting. For all buildings where sprinkler and combination sprinkler and standpipe systems are not subject to a special inspection pursuant to Section [~~1704.23~~] 1705.2.9 of this code, a licensed master plumber, licensed master fire suppression piping contractor, registered design professional or an individual holding an appropriate certificate of fitness from the Fire Department for the operation and/or maintenance

of such system shall certify on forms provided by the department that all required painting has been completed in accordance with Section 903.6. Such certification shall be maintained on the premises and made available for inspection by the department and the Fire Department.

SECTION BC 904
ALTERNATIVE AUTOMATIC
FIRE-EXTINGUISHING SYSTEMS

904.1 General. Automatic fire-extinguishing systems, other than automatic sprinkler systems, shall be designed, installed, inspected, tested and maintained in accordance with the provisions of this section, the *New York City Fire Code*, and the applicable referenced standards.

904.1.1 Construction documents. Construction documents for alternative automatic fire-extinguishing systems shall be approved by the Fire Department and shall contain plans that include at least the following data and information:

1. Commercial kitchen suppression systems:
 - 1.1. Location of all surface, plenum and duct nozzles; surface dimensions and location of all cooking appliances; the location of automatic fuel shutoff and statement as to type (gas or electric); location and distance of the remote control or manual pull station;
 - 1.2. Identification of the grease filters to be used in any kitchen hood; the dimensions of all hoods and all related ducts, including termination of duct at the exterior of the building;
 - 1.3. Identification of the fire suppression piping system; the make and model of the system; the type of extinguishing agent and number and size of agent containers; size, length, and type of all piping that will be used; the number and location of all fusible links or detectors and the temperature setting; any surface, plenum and duct nozzles.
2. For extinguishing agent systems, the plan should also include type and concentration of the extinguishing agent, the method of providing power supply to smoke or heat detectors, fire rating of partitions, location of all audible/visible alarms within and outside the location involved and the details of construction of the room to contain the extinguishing agent. If the area is not sprinklered, the following information is required:
 - 2.1. The size and location of the reserve supply, and
 - 2.2. Information as to why it has been determined that water is not effective as an extinguishing agent for the fire hazard in such location.
3. The plans must note whether the proposed system is connected to the building's fire alarm system.

Exception: For that portion of a fire suppression piping system within an approved preengineered system, a schematic isometric diagram shall be acceptable in lieu of full

plans, provided that the location and method of pressure relief must be indicated with areas and volumes to where said relief is taken.

904.2 Where required. Automatic fire-extinguishing systems installed as an alternative to the required automatic sprinkler systems of Section 903 shall be approved by the Fire Department. Automatic fire-extinguishing systems shall not be considered alternatives for the purposes of exceptions or reductions allowed by other requirements of this code.

904.2.1 Hood system suppression. Each required commercial kitchen exhaust hood and duct system required by Chapter 5 of the *New York City Mechanical Code* to have a Type I hood shall be protected with an automatic fire-extinguishing system installed in accordance with this code and the *New York City Fire Code*.

904.3 Installation. Automatic fire-extinguishing systems shall be installed in accordance with this section.

904.3.1 Electrical wiring. Electrical wiring shall be in accordance with the *New York City Electrical Code*.

904.3.2 Actuation. Automatic fire-extinguishing systems shall be automatically actuated and provided with a manual means of actuation in accordance with Section [904.11.1] 904.12.1. Where more than one hazard could be simultaneously involved in fire due to their proximity, all hazards shall be protected by a single system designed to protect all hazards that could become involved.

Exception: Multiple systems shall be permitted to be installed if they are designed to operate simultaneously.

904.3.3 System interlocking. Automatic equipment interlocks with fuel shutoffs, ventilation controls, door closers, window shutters, conveyor openings, smoke and heat vents and other features necessary for proper operation of the fire-extinguishing system shall be provided as required by the design and installation standard utilized for the hazard.

904.3.4 Alarms and warning signs. Where alarms are required to indicate the operation of automatic fire-extinguishing systems, distinctive audible and visible alarms and warning signs shall be provided to warn of pending agent discharge. Where exposure to automatic-extinguishing agents poses a hazard to persons and a delay is required to ensure the evacuation of occupants before agent discharge, a separate warning signal shall be provided to alert occupants once agent discharge has begun. Audible signals shall be in accordance with Section [907.5.2.1] 907.5.2.

904.3.5 Monitoring. Where a fire alarm system is installed, automatic fire-extinguishing systems shall be monitored by the fire alarm system in accordance with NFPA 72.

904.4 Inspection and testing. Automatic fire-extinguishing systems shall be inspected and tested in accordance with the provisions of this section and the *New York City Fire Code* prior to acceptance.

904.4.1 Inspection. Prior to conducting final acceptance tests, all of the following items shall be inspected:

1. Hazard specification for consistency with design hazard.
2. Type, location and spacing of automatic- and manual initiating devices.
3. Size, placement and position of nozzles or discharge orifices.
4. Location and identification of audible and visible alarm devices.
5. Identification of devices with proper designations.
6. Operating instructions.

904.4.2 Alarm testing. Notification appliances, connections to fire alarm systems and connections to central supervising stations shall be tested in accordance with this section and Section 907 to verify proper operation.

904.4.2.1 Audible and visible signals. The audibility and visibility of notification appliances signaling agent discharge or system operation, where required, shall be verified.

904.4.3 Monitor testing. Connections to protected premises and supervising station fire alarm systems shall be tested to verify proper identification and retransmission of alarms from automatic fire-extinguishing systems.

904.5 Wet-chemical systems. Wet-chemical extinguishing systems shall be installed, maintained, periodically inspected and tested in accordance with the *New York City Fire Code*.

904.6 Dry-chemical systems. Dry-chemical extinguishing systems shall be installed, maintained, periodically inspected and tested in accordance with *New York City Fire Code*. New dry-chemical extinguishing systems are not permitted for the protection of kitchen equipment.

904.7 Foam systems. Foam-extinguishing systems shall be installed, maintained, periodically inspected and tested in accordance with the *New York City Fire Code*.

904.8 Carbon dioxide systems. Carbon dioxide extinguishing systems shall be installed, maintained, periodically inspected and tested in accordance with the *New York City Fire Code*.

904.9 Halon systems. Halogenated extinguishing systems shall not be permitted. However, existing systems shall be maintained, periodically inspected and tested in accordance with the *New York City Fire Code*.

904.10 Clean-agent systems. Clean-agent fire-extinguishing systems shall be installed, maintained, periodically inspected and tested in accordance with the *New York City Fire Code*.

904.11 Automatic water mist systems. Automatic water mist systems shall be permitted in applications that are consistent with the applicable listing or approvals and shall comply with Sections 904.11.1 through 904.11.3.

904.11.1 Design and installation requirements. Automatic water mist systems shall be designed and installed in accordance with Sections 904.11.1.1 through 904.11.1.4.

904.11.1.1 General. Automatic water mist systems shall be designed and installed in accordance with the manufacturer's instructions and the *New York City Fire Code*.

904.11.1.2 Actuation. Automatic water mist systems shall be automatically actuated.

904.11.1.3 Water supply protection. Connections to a potable water supply shall be protected against backflow in accordance with the *New York City Plumbing Code*.

904.11.1.4 Secondary water supply. Where a secondary water supply is required for an automatic sprinkler system, an automatic water mist system shall be provided with an approved secondary water supply in accordance with the *New York City Fire Code*.

904.11.2 Water mist system supervision and alarms. Supervision and alarms shall be provided as required for automatic sprinkler systems in accordance with Section 903.4.

904.11.2.1 Monitoring. Monitoring shall be provided as required for automatic sprinkler systems in accordance with Section 903.4.1.

904.11.2.2 Alarms. Alarms shall be provided as required for automatic sprinkler systems in accordance with Section 903.4.2.

904.11.2.3 Floor control valves. Floor control valves shall be provided as required for automatic sprinkler systems in accordance with Section 903.4.3.

904.11.3 Testing, operation and maintenance. Automatic water mist systems shall be tested, operated and maintained in accordance with the *New York City Fire Code*.

904.12 Commercial cooking systems. The automatic fire-extinguishing system for commercial cooking systems shall be of a type recognized for protection of commercial cooking equipment and exhaust systems of the type and arrangement protected. Pre[-]engineered automatic wet-chemical extinguishing systems shall be approved by the [~~fire commissioner~~] Fire Commissioner, tested in accordance with UL 300, and listed and labeled for the intended application. The protected area shall include the area under the hood and over the cooking equipment, the area above or behind the filters and the opening of the hood into the branch duct. Where a preengineered system is installed and the size of the protected area exceeds that allowed for a single preengineered system, additional preengineered systems arranged for simultaneous operation shall be provided. Other types of automatic fire-extinguishing systems shall be listed and labeled for specific use as protection for commercial cooking operations. The system shall be installed in accordance with this code, its listing and the manufacturer's [~~installation~~] instructions. [~~Automatic~~] Only automatic fire-extinguishing systems of the following types shall be installed in accordance with the *New York City Fire Code* [~~and the referenced standard indicated, as shown~~]:

1. [~~Carbon dioxide extinguishing systems, in accordance with the New York City Fire Code.~~] Foam water sprinkler system or foam water spray systems.
2. Wet-chemical extinguishing systems [~~, in accordance with the New York City Fire Code~~].

Automatic sprinkler systems, dry-chemical fire-extinguishing systems, and carbon dioxide fire-extinguishing systems shall not be installed to protect commercial cooking equipment and exhaust systems.

~~[904.11.1]~~ **904.12.1 Manual system operation.** A manual actuation device shall be located at or near a means of egress from the cooking ~~[areas, a minimum of]~~ area not less than 10 feet (3048 mm) [and a maximum of] and not more than 20 feet (6096 mm), from the kitchen exhaust system. The manual actuation device shall be installed not more than 48 inches ~~[(1200 mm)]~~ (1220 mm) or less than 42 inches ~~[(1067)]~~ 1066.8 mm above the finished floor and shall clearly identify the hazard protected. The manual actuation device shall require a maximum force of 40 pounds ~~[(178)]~~ 177.9 N and a maximum movement of 14 inches ~~[(356)]~~ 355.6 mm to actuate the fire suppression system.

Exception: Automatic sprinkler systems shall not be required to be equipped with manual actuation means.

~~[904.11.2]~~ **904.12.2 System interconnection.** The actuation of the fire suppression system shall automatically shut down the fuel or electrical power supply to the cooking equipment. The fuel and electrical supply reset shall be manual.

~~[904.11.3 Carbon dioxide systems.~~ When carbon dioxide systems are used, there shall be a nozzle at the top of the ventilating duct. Additional nozzles that are symmetrically arranged to give uniform distribution shall be installed within vertical ducts exceeding 20 feet (6096 mm) and horizontal ducts exceeding 50 feet (15 240 mm). Dampers shall be installed at either the top or the bottom of the duct and shall be arranged to operate automatically upon activation of the fire-extinguishing system. Where the damper is installed at the top of the duct, the top nozzle shall be immediately below the damper. Automatic carbon dioxide fire-extinguishing systems shall be sufficiently sized to protect against all hazards venting through a common duct simultaneously.]

~~[904.11.3.1 Ventilation system.~~ Commercial-type cooking equipment protected by an automatic carbon dioxide-extinguishing system shall be arranged to shut off the ventilation system upon activation.]

~~[904.12 Water-mist systems.~~ Water-mist fire-extinguishing systems shall be installed, maintained, periodically inspected and tested in accordance with the *New York City Fire Code*.]

904.13 Domestic cooking systems in Group I-2. In Group I-2 occupancies where cooking facilities are installed in accordance with Section 407.2.6 of this code, the domestic cooking hood provided over the cooktop or range shall be equipped with an automatic fire-extinguishing system of a type recognized for protection of domestic cooking equipment. Preengineered automatic extinguishing systems shall be tested in accordance with UL 300A and listed and labeled for the intended application. The system shall be installed in accordance with this code, its listing and the manufacturer's instructions.

904.13.1 Manual system operation and interconnection. Manual actuation and system interconnection for the hood suppression system shall be installed in accordance with Sections 904.12.1 and 904.12.2, respectively.

904.13.2 Portable fire extinguishers for domestic cooking equipment in Group I-2. A portable fire extinguisher complying with Section 906 shall be installed within a 30-foot (9144 mm) distance of travel from domestic cooking appliances.

SECTION BC 905 STANDPIPE SYSTEMS

905.1 General. Standpipe systems shall be provided in buildings and structures in accordance with this section. Fire hose threads used in connection with standpipe systems shall be approved by the ~~[fire commissioner]~~ Fire Commissioner. Standpipe systems in buildings used for high-piled combustible storage shall be in accordance with the *New York City Fire Code*. Installation of standpipe systems shall comply with the special inspection requirements of Chapter 17 of this code.

Any space or room that contains equipment of such nature that the use of water would be ineffective in fighting a fire therein, or would be otherwise hazardous, shall have a conspicuous sign on each door opening on such space or room stating the nature of the use and the warning: "IN CASE OF FIRE, USE NO WATER."

905.1.1 Construction documents. Construction documents for standpipe systems shall contain plans that include, at ~~least~~ a minimum, the following data and information:

1. The locations and sizes of all risers, cross-connections, hose racks, valves, Department connections, sources of water supply, piping, and other essential features of the system;
2. A floor plan for each group of floors that have typical riser locations and no special features within such group of floor levels, with the indication in title block of such plan indicating clearly the floors to which the arrangement is applicable;
3. A riser diagram showing the essential features of the system, including the risers, cross-connections, valves, Fire Department connections, tanks, pumps, sources of water supply, pipe sizes, capacities, floor heights, zone pressures, and other essential data and features of the system; ~~and~~
4. The available water pressure at the top and bottom floors of each zone, and at each floor where the ~~[weight pipe fittings change]~~ pressure rating of piping, fittings, couplings, and valves are required to change, shall be shown on the riser diagram; and
5. For street pressure-fed systems and fire pumps, a statement from the New York City Department of Environmental Protection, giving the minimum water pressure in the main serving the building.

905.2 Installation standards. Standpipe systems shall be installed in accordance with this section and NFPA 14~~[as modified in Appendix Q]~~.

905.3 Required installations. Standpipe systems shall be installed where required by Sections 905.3.1 through ~~[905.3.6]~~ 905.3.9 and in the locations indicated in Sections 905.4, 905.5 and 905.6. Standpipe systems are allowed to be combined with automatic sprinkler systems.

Exception: Standpipe systems are not required in buildings occupied entirely by Group R-3.

905.3.1 Applicability. Class III standpipe systems shall be installed throughout the following buildings:

1. In buildings two stories or more in height with floor area of 10,000 square feet (929 m²) or greater on any story;
2. In buildings three stories or more in height with floor area of 7,500 square feet (~~[697]~~ 696.8 m²) or greater on any story;
3. In buildings of any area with a floor level having an occupant load of 30 or more that is located 55 feet (16 764 mm) or more above the lowest level of Fire Department vehicle access; and
4. In buildings of any area, constructed in accordance with Section 403, with occupied floors located 75 feet (22 860 mm) or more above the lowest level of Fire Department vehicle access.

Exceptions: The following exceptions are allowed as an alternative to the requirement of a Class III standpipe system:

1. Class I standpipes are allowed in buildings equipped throughout with an automatic sprinkler system in accordance with Section 903.3.1.1 or 903.3.1.2 provided that the following additional requirements are met:
 - 1.1. A locked noncombustible storage cabinet shall be provided on the main entrance floor. One additional locked storage cabinet shall be provided on every tenth floor above the main entrance floor, such that no occupant on any floor would have to travel more than five floors to reach a cabinet in a location within 15 feet (4572 mm) of each standpipe riser. Where one standpipe riser is installed in the building, such cabinet shall contain at least one fog nozzle, one ~~[4.5]~~ 1/₂-inch (~~[38]~~ 38.1 mm) spanner wrench, one ~~[2.5]~~ 2/₂-inch (~~[64]~~ 63.5 mm) spanner wrench, one ~~[2.5]~~ 2/₂-inch (~~[64]~~ 63.5 mm) by ~~[4.5]~~ 1/₂ inch (~~[38]~~ 38.1 mm) nonswivel reducing coupling, and 125 feet (~~[38]~~ 38.1 m) of ~~[4.5]~~ 1/₂ inch (~~[38]~~ 38.1 mm) hose. ~~[Where two or more standpipe risers are installed in the building, at least two of each of the above items of equipment shall be provided. However, the hose may be omitted when serving Group R-2 occupancies.]~~
 - 1.1.1. The cabinet shall be kept locked, openable by a Fire Department citywide standard key.

- 1.1.2. The cabinet shall be labeled, “FOR FIRE DEPARTMENT ONLY.”
- 1.1.3. A metal sign stating clearly where the storage cabinet is located shall be placed in each stair enclosure on the main entrance floor and on each floor where the cabinet is located.
- 1.2. Hose valves are capped with a hose valve cap fastened to the valve with a chain.
2. Class I manual standpipes are allowed in open parking garages where the highest floor is located not more than 150 feet (45 720 mm) above the lowest level of Fire Department vehicle access.
3. Class I manual dry standpipes are allowed in open parking garages that are subject to freezing temperatures, provided that the hose connections are located as required for Class ~~[H]~~ III standpipes in accordance with Section ~~[905.5]~~ 905.6.
4. Class I standpipes are allowed in below-grade stories equipped throughout with an automatic sprinkler system.
5. Standpipe outlets may be omitted in portions of first floors or basements that are completely separated from the entrance hall or enclosed stairways leading to the upper floors, provided that portable fire extinguishers are installed, subject to the approval of the ~~[fire commissioner]~~ Fire Commissioner.

905.3.2 Group A. Class I automatic wet standpipes shall be provided in nonsprinklered Group A buildings having an occupant load exceeding 1,000 persons.

Exceptions:

1. Open-air-seating spaces without enclosed spaces.
2. Class I automatic dry and semiautomatic dry standpipes or manual wet standpipes are allowed in buildings where the highest floor surface used for human occupancy is not more than 75 feet (22 860 mm)~~[or less]~~ above the lowest level of Fire Department vehicle access. Dry standpipes are permitted only where subject to freezing temperatures.

905.3.3 Covered mall buildings. Covered mall buildings and buildings connected thereto shall be equipped throughout with a Class I automatic wet standpipe system, except as permitted by Sections 905.3.3.1 through 905.3.3.3.

905.3.3.1 Covered-mall building height. Covered-mall buildings where the highest occupied floor level is located not more than 30 feet (9144 mm) above the lowest level of the Fire Department vehicle access shall be permitted to be provided with Class I hose connections connected to the mall sprinkler system in accordance with Section 8.17.5.2 of

NFPA 13 regarding hose connections for Fire Department use and under the following conditions:

1. Any individual outlet shall be capable of delivering water flow at a rate of 250 gallons per minute ([946] 946.4 L/m) while concurrently supplying the mall sprinkler demand; and
2. Each of the two most hydraulically remote outlets shall be capable of concurrently delivering 250 gallons per minute ([946] 946.4 L/m) at a pressure of 100 pounds per square inch (689.4 kPa) with no mall sprinkler demand, based on a supply pressure at the system Fire Department connection of not more than 175 pounds per square inch ([1207] 1206.6 kPa). Adequacy of the water supply available to the Fire Department [~~to meet the hydraulic calculations~~] shall be demonstrated through hydraulic calculations provided by the registered design professional.

905.3.3.2 Location of hose connections. Hose connections shall be provided in accordance with Section 905.4 and at each of the following locations:

1. Within the mall at the entrance to each exit passageway or exit.
2. At each floor-level landing within [~~enclosed stairways~~] interior exit stairways opening directly on the mall.
3. At exterior public entrances to the mall of a covered mall building.
4. At public entrances at the perimeter line of an open mall building.
5. At other locations as necessary so that the distance to reach all portions of a tenant space does not exceed 150 feet (45 720 mm) from a hose connection.

905.3.3.3 Installation standard. Except as provided in Sections 905.3.3.1 and 905.3.3.2, the Class I hose connections and Fire Department connections shall be designed in conformance with NFPA 14.

905.3.4 Stages. Stages greater than 1,000 square feet in area ([93] 92.9 m²)[~~and~~], or any assembly occupancy [with a stage and] having an occupant load of 1,000 or [greater] more with a stage of any size, shall be equipped with a Class III wet standpipe system with [~~1½ inch and 2½ inch (38 mm and 64 mm)~~] a hose [connections] station on each side of the stage. Such hose stations shall comply with Section 905.6 and shall have sufficient hose to provide protection for the entire stage area from either standpipe location. The exceptions allowed under Section 905.3.1 shall not apply to these hose stations.

~~[905.3.4.1 Hose and cabinet. The 1½ inch (38 mm) hose connections shall be equipped with sufficient lengths of 1½ inch (38 mm) hose to provide fire protection for the stage area. Hose connections shall be equipped with an approved adjustable fog nozzle and be mounted in a cabinet or on a rack.]~~

905.3.5 Underground buildings. Underground buildings shall be equipped throughout with a Class I automatic wet or manual wet standpipe system.

905.3.6 Helistops and heliports. Buildings with a helistop or heliport that are equipped with a standpipe shall extend the standpipe to the roof level on which the helistop or heliport is located in accordance with the *New York City Fire Code*. All portions of the helistop and heliport area shall be within 150 feet (45 720 mm) of a 2½-inch ([64] 63.5 mm) outlet on a Class I or III standpipe, in accordance with the *New York City Fire Code*.

905.3.7 Marinas and boatyards. Standpipes in marine terminals, piers, wharves, marinas and boatyards shall comply with the *New York City Fire Code* or other requirements of the Fire Department.

905.3.8 Rooftop gardens, landscaped roofs and green roofs. Buildings with a rooftop garden, landscaped roof, green roof, or roof used for any purpose other than weather protection or maintenance that are equipped with a standpipe system shall extend the standpipe system to the roof level on which the rooftop garden, landscaped roof, green roof, or roof used for any purpose other than weather protection or maintenance is located.

905.3.9 High-piled stock or rack storage. Where exit passageways are required in accordance with Chapter 10 of this code, a standpipe system shall be provided in accordance with the *New York City Fire Code* in all buildings containing high-piled stock or rack storage.

905.4 Location of Class I standpipe hose connections. Class I standpipe hose connections shall be provided in all of the following locations:

1. In every required stairway, a hose connection shall be provided for each floor level above or below grade. Hose connections shall be readily accessible and located at the riser on each floor-level landing and on the entrance floor above the standpipe riser control valve. Nonrequired enclosed stairways that do not serve as a means of egress are not required to have hose connections. Stairways without hose connections shall have a sign on the door to the stairway stating, “No standpipe connections in stairway”.
2. On each side of the wall adjacent to the exit opening of a horizontal exit.

Exception: Where floor areas adjacent to a horizontal exit are reachable from exit stairway hose connections by a 30-foot (9144 mm) hose stream from a nozzle attached to 100 feet (30 480 mm) of hose, a hose connection shall not be required at the horizontal exit.

3. In every exit passageway at the entrance from the exit passageway to the other areas of a building.

Exception: Where floor areas adjacent to an exit passageway are reachable from exit stairway hose connections by a 30-foot (9144 mm) hose stream from a nozzle attached to 100 feet (30 480 mm) of hose, a hose connection shall not be required at the entrance from the exit passageway to other areas of the building.

4. In covered mall buildings, in accordance with Section 905.3.3.2.
5. Where the roof has a slope of less than four units vertical in 12 units horizontal (33.3-percent slope), each standpipe shall be provided with a hose connection located either on the roof or

at the highest landing of stairways with stair access to the roof. An additional hose connection shall be provided at the top of the most hydraulically remote standpipe for testing purposes. This additional hose connection shall not be required when a roof manifold is installed in accordance with NFPA 14.

6. Where the most remote portion of a floor or story is more than 150 feet (45 720 mm) from a hose connection, additional hose connections shall be provided in approved locations. For the purposes of this section, a penthouse with an occupant load greater than 10 shall be considered a story.
7. In any staircase where the change in elevation between floor landings is more than 25 feet (7620 mm), in addition to the hose connections required by Item 1, a hose connection shall be installed at the first intermediate stair landing below the higher floor level.

905.4.1 Protection. Risers and laterals of Class I standpipe systems not located within an enclosed stairway or pressurized enclosure shall be protected by a degree of fire resistance equal to that required for vertical enclosures in the building in which they are located. No standpipe riser shall be placed in any shaft containing a gas or fuel pipeline.

Exception: In buildings equipped throughout with an approved automatic sprinkler system, laterals that are not located within an enclosed stairway or pressurized enclosure are not required to be enclosed in fire resistance rated construction.

905.4.2 Interconnection. In buildings where more than one standpipe is provided, the standpipes shall be interconnected in accordance with NFPA 14.

905.5 Location of Class II standpipe hose connections. Class II standpipe hose connections shall be ~~[accessible and located in accordance with Section 905.3.4]~~ prohibited.

905.5.1 Reserved.

~~[905.5.2 Protection. Fire resistance rated protection of risers and laterals of Class II standpipe systems is not required.]~~

905.6 Location of Class III standpipe hose connections. Class III standpipe systems shall have 2½-inch (63.5 mm) hose connections located as required for Class I standpipes in Section 905.4 [and shall have Class II hose connections as required in Section 905.5]. At each hose connection, there shall be a hose station. The hose stations shall be equipped with a minimum of 125 feet (38 100 mm) but not more than a maximum of 150 feet (45 720 mm) of 1½-inch (38.1 mm) fire hose connected to an adjustable fog nozzle. The hose shall be attached to the 2½-inch (63.5 mm) hose connection by a 2½-inch (63.5 mm) by 1½-inch (38.1 mm) non-swivel reducing coupling. The hose shall be mounted on a rack and may be located in a cabinet, in accordance with Section 905.7. A pressure restricting device shall be installed when required by NFPA 14. Such pressure restricting device and reducing coupling shall be installed in such a manner that they are readily removable by the Fire Department.

905.6.1 Protection. Risers and laterals of Class III standpipe systems shall be protected as required for Class I systems in accordance with Section 905.4.1.

905.6.2 Interconnection. In buildings where more than one standpipe is provided, the standpipes shall be interconnected in accordance with NFPA 14.

905.7 Cabinets. Cabinets containing [~~fire fighting~~] firefighting equipment such as standpipes, fire hoses, fire extinguishers or Fire Department valves shall not be blocked from use or obscured from view.

905.7.1 Cabinet equipment identification. Cabinets shall be identified in an approved manner by a permanently attached sign with white letters not less than 2 inches (~~[54]~~ 50.8 mm) high and a red background color, indicating the equipment contained therein.

[Exception:] Exceptions:

1. Doors not large enough to accommodate a written sign with 2-inch lettering shall be marked with a permanently attached pictogram indicating the equipment contained therein, in addition to corresponding smaller white lettering on a red background adjacent to such pictogram.
2. Doors that have either an approved visual identification clear glass panel or a complete glass door panel are not required to be marked.

905.7.2 Locking cabinet doors. Cabinets shall be unlocked.

Exceptions:

1. Visual identification panels of glass or other approved transparent frangible material that is easily broken and allows access.
2. Approved locking arrangements.
3. Locking of cabinets shall be permitted in Group I-3.

905.8 Dry standpipes. Dry standpipes shall not be installed.

Exception: Where subject to freezing and in accordance with NFPA 14.

905.9 Valve supervision. Valves controlling water supplies shall be supervised in the open position so that a change in the normal position of the valve will generate a supervisory signal at the central supervising station required by Section 903.4. Where a fire alarm system is provided, a signal shall also be transmitted to the fire alarm system.

Exceptions:

1. Valves to underground key or hub valves in roadway boxes provided by the city or a public utility do not require supervision.
2. Valves locked in the normal position and inspected as provided in this code in buildings not equipped with a fire alarm system.

905.10 During construction. Standpipe systems required during construction, alteration and demolition operations shall be provided in accordance with Section 3303.8.

905.11 Painting of dedicated standpipes. Dedicated standpipes and the handles of valves serving standpipes shall be painted and such painting certified in accordance with Sections 905.11.1 through 905.11.6. In addition to painting, standpipe piping may also be identified by lettered legend in accordance with ANSI A13.1. Where the piping is required to be listed and labeled such painting shall not obscure such labeling.

Exceptions:

1. Attachments, gauges, valves and operable parts of standpipes other than valve handles.
2. Where different color coding may be required by Section 3406 of the *New York City Fire Code* for facilities storing, handling, and using flammable and combustible liquids in connection with special operations.

905.11.1 New buildings. All portions of a standpipe system and the handles of valves serving the standpipe system in new buildings, including buildings constructed pursuant to Section 28-101.4.2 of the *Administrative Code*, shall be painted red prior to the hydrostatic pressure test whether or not they are intended to be enclosed at the end of construction.

905.11.2 Alterations. Existing handles of valves serving existing standpipe systems and existing unpainted standpipe risers that are exposed during alterations, including alterations pursuant to Section 28-101.4.2 of the *Administrative Code* shall be painted red. Where the alteration requires a hydrostatic pressure test such painting shall be completed prior to such test.

905.11.3 Retroactive requirement for completed buildings. Notwithstanding any other provision of law, all portions of exposed standpipe systems and handles of valves serving the standpipe system of completed buildings in existence March 2, 2010 shall be painted red [~~by June 2, 2010~~].

905.11.4 Buildings under construction on March 2, 2010. Notwithstanding any other provision of law, where construction documents were approved and permits issued for the construction of a new building or alteration of an existing building prior to March 2, 2010, and the work is not signed off by the department prior to such date, all exposed portions of the standpipe system and handles of valves serving the standpipe system shall be painted red prior to the hydrostatic pressure test, including portions that will be enclosed at a later point in time.

Exception: Portions of the standpipe system enclosed prior to March 2, 2010, need not be painted.

905.11.5 Combination standpipe and sprinkler systems. Where a standpipe system that is used as a combination standpipe and sprinkler system is required to be painted pursuant to Section 905.11.1, 905.11.2, 905.11.3 or 905.11.4, the sprinkler risers and cross connections that are also used for the standpipe system shall be painted red, and the handles of valves serving such combination standpipe and sprinkler system shall be painted yellow.

905.11.6 Certification of completion of system painting. For all buildings where standpipe and combination sprinkler and standpipe systems are not subject to a special inspection pursuant to Section [1704.24] 1705.30 of this code, a licensed master plumber, licensed master fire suppression piping contractor, registered design professional or an individual holding an appropriate certificate of fitness from the Fire Department for the operation and/or maintenance of such system shall certify on forms provided by the department that all required painting has been completed in accordance with Section 905.11. Such certification shall be maintained on the premises and made available for inspection by the department and the Fire Department.

SECTION BC 906 PORTABLE FIRE EXTINGUISHERS

906.1 General. Portable fire extinguishers shall be provided in occupancies and locations as required by the *New York City Fire Code*.

SECTION BC 907 FIRE ALARM AND DETECTION SYSTEMS

907.1 General. This section covers the application, installation, performance and maintenance of fire alarm systems and their components. Systems shall be designed and installed in accordance with NFPA 72 [~~as modified in Appendix Q~~] and the *New York City Electrical Code*. Systems shall be tested and maintained in accordance with this code and the *New York City Fire Code*.

907.1.1 Construction documents. Construction documents for fire alarm systems shall be submitted for review and approval to the Fire Department prior to system installation. Construction documents shall include, but not be limited to, all of the following:

1. A floor plan that indicates the use of all rooms.
2. Locations of alarm-initiating devices.
3. Locations of alarm notification appliances, including candela ratings for visible alarm notification appliances.
4. Location of fire command center, fire alarm control units, transponders and notification power supplies.
5. Location of remote annunciators.
6. Location of all primary, secondary and local sources of power.
7. Fire alarm riser diagram showing all fire alarm devices indicated on the floor plans. Quantities of devices on the floor plans shall match the quantities indicated on the riser diagram. Riser diagram shall include class and style of circuits and levels of survivability. The riser diagram shall show the interface of fire safety control functions.
8. Copies of any variances granted by the department or the Fire Department.
9. Legend of all fire alarm symbols and abbreviations used.

10. Design criteria for fire alarm audibility in various occupancies indicated on plans.
11. Fire alarm sequence of operation for the fire alarm system in a matrix format.
12. Classification of the central supervising station.

907.1.1.1 Amended construction documents. Amendments to approved construction documents shall be submitted[;] and approved by the Fire Department before the final inspection of the work or equipment is completed, and such amendments when approved shall be deemed part of the original construction documents. The Fire Department may allow minor revisions of construction documents to be made and submitted to the Fire Department after the completion of work but prior to sign-off of the work in accordance with rules promulgated by the Fire Department regarding such amendments.

907.1.2 Equipment. Systems and their components shall be listed for the purpose for which they are installed. The fire alarm control unit shall meet the requirements of the Fire Department.

907.2 Where required. An approved fire alarm system installed in accordance with the provisions of this code and NFPA 72 [as modified by Appendix Q] shall be provided in accordance with Sections 907.2.1 through [907.2.22] 907.2.23 and provide occupant notification in accordance with Section 907.5, unless other requirements are provided by another section of this code.

A minimum of one manual fire alarm box shall be provided in an approved location to initiate a fire alarm signal for fire alarm systems employing automatic fire detectors or waterflow detection devices. Where other sections of this code allow elimination of fire alarm boxes due to sprinklers, a single fire alarm box shall be installed.

Exceptions:

1. The manual fire alarm box is not required for fire alarm systems dedicated to elevator recall control and supervisory service.
2. The manual fire alarm box is not required for Group R-2 occupancies unless required by the Fire Department to provide a means for fire watch personnel to initiate an alarm during a sprinkler system impairment event. Where provided, the manual fire alarm box shall not be located in an area that is accessible to the public.

In all occupancies where an automatic fire alarm system is required by this section, selective coverage smoke detectors shall be located as follows, unless partial or total coverage automatic detection is specified.

1. In each mechanical equipment, electrical, transformer, telephone equipment or similar room, in elevator machine rooms, and in elevator lobbies.
2. In air distribution systems in accordance with Section 606 of the *New York City Mechanical Code*.

907.2.1 Group A. A manual and automatic fire alarm system that activates the occupant notification system in accordance with Section 907.5 shall be installed in Group A occupancies

~~[having an]~~ where the occupant load [of] due to the assembly occupancy is 300 or more. Group A occupancies not separated from one another in accordance with Section 707.3.10 shall be considered as a single occupancy for the purposes of applying this section. Portions of Group E occupancies occupied for assembly purposes shall be provided with a fire alarm system as required for the Group E occupancy.

Exceptions:

1. Manual fire alarm boxes are not required where the building is equipped throughout with an automatic sprinkler system and the notification appliances will activate upon sprinkler water flow. This exception shall not apply to Group A-2 occupancies used as a cabaret.
2. A Group A-2 occupancy used as a cabaret with an occupant load of 75 or more, including associated stages, dressing rooms, and property rooms, shall be equipped with a manual fire alarm system. Such a Group A-2 occupancy with an occupant load of 300 or more shall also be equipped with an automatic fire alarm system.
3. Group A occupancies with a stage in accordance with Section 410, and having an occupant load of 75 or more, shall be provided with a voice/alarm communication system as required by Sections ~~[410.8]~~ 410.9 and 907.2.1.1.

907.2.1.1 System initiation in Group A occupancies. Activation of the fire alarm in Group A-1 occupancies with an occupant load of 300 or more, and in all other Group A occupancies with an occupant load of 1,000 or more, shall initiate a presignal system in accordance with NFPA 72 ~~[as amended by Appendix Q]~~ at a constantly attended location from which the Fire Department shall be notified and live voice evacuation instructions shall be initiated using an emergency voice/alarm communications system in accordance with Section 907.5.2.2.

907.2.1.2 Emergency voice/alarm communication captions. Stadiums, arenas and grandstands required to caption audible public announcements shall be in accordance with Section 907.5.2.2.4.

907.2.2 Group B. A manual and automatic fire alarm system shall be installed in Group B occupancies ~~[that are protected by an automatic sprinkler system]~~ where one of the following conditions exists:

1. The combined Group B occupant load of all floors is 500 or more.
2. The Group B occupant load is more than 100 persons above or below the lowest level of exit discharge.
3. The ~~[Group B]~~ fire area contains ~~[a Group B]~~ an ambulatory [health] care facility, which shall comply with Section 907.2.2.1.

Where such Group B occupancies meeting any one of the above conditions are not protected by an automatic sprinkler system, a partial coverage automatic smoke detection system shall be installed in accordance with NFPA 72.

907.2.2.1 ~~[Group B ambulatory health]~~ Ambulatory care facilities. Fire areas containing ~~[Group B]~~ ambulatory ~~[health]~~ care facilities shall be provided with an electronically supervised automatic partial-coverage smoke detection system installed within the ambulatory ~~[health]~~ care facility and in public use areas outside of tenant spaces and along the path of egress, including public corridors and elevator lobbies.

Exception: Buildings equipped throughout with an automatic sprinkler system in accordance with Section 903.3.1.1, provided the occupant notification appliances will activate throughout the notification zones upon sprinkler waterflow.

907.2.2.2 Large-area buildings. Group B occupancies having a total gross area exceeding 100,000 square feet (~~[9290]~~ 9290.3 m²) located in buildings where the highest occupied floor is ~~[less than]~~ 75 feet (22 860 mm) or less above the lowest level of Fire Department vehicle access shall be provided with automatic smoke detection connected to an automatic fire alarm system in accordance with Section 907.2.13.1 and emergency voice/alarm communication system in accordance with Section 907.5.2.2 that initiates a total evacuation signal.

907.2.3 Group E. A manual and automatic fire alarm system shall be installed in Group E occupancies. An emergency voice/alarm communication system meeting the requirements of Section 907.5.2.2 and installed in accordance with Section 907.6 shall be installed in Group E occupancies. ~~[When automatic]~~ Automatic sprinkler systems ~~[øø]~~, smoke detectors ~~[are installed,]~~ and/or other initiating devices, shall be installed in accordance with other sections of this code. When such systems, initiating devices, and/or detectors are installed, they shall be connected to the building fire alarm system.

Exception: Emergency voice/alarm communication systems meeting the requirements of Section 907.5.2.2 and installed in accordance with Section 907.6 shall not be required in Group E occupancies with occupant loads of 100 or less, provided that activation of the manual and automatic fire alarm system initiates an approved occupant notification signal in accordance with Section 907.5.

907.2.4 Group F. A manual and automatic fire alarm system shall be installed in Group F occupancies that are two or more stories in height and have an occupant load of 100 or more, or when 25 persons or more are above or below the lowest level of exit discharge.

907.2.5 Group H. A manual and automatic fire alarm system shall be installed in Group H-5 occupancies and in occupancies used for the manufacture of organic coatings. In addition to the automatic fire alarm system requirements of Section 907.2, an automatic smoke detection system shall be installed for highly toxic gases, organic peroxides and oxidizers in accordance with the *New York City Fire Code* ~~[, and shall be connected to a central supervising station].~~

[Exceptions: A smoke detection system shall not be required in detached storage buildings equipped throughout with an approved automatic fire extinguishing system and used only to store the following:]

[1. ~~Organic peroxides.~~]

[2. ~~Liquid or solid oxidizers.~~]

Exception: Where exempt under the *New York City Fire Code*.

907.2.6 Group I. A manual and automatic fire alarm system that activates the occupant notification system in accordance with Section 907.5 shall be installed in Group I occupancies. An automatic smoke detection system that activates the occupant notification system shall be provided in accordance with Sections 907.2.6.1, 907.2.6.2 and 907.2.6.3.3.

907.2.6.1 Group I-1. An automatic smoke detection system shall be installed in corridors, waiting areas open to corridors and habitable spaces other than sleeping units and kitchens. The system shall be activated in accordance with Section 907.5.

Exception: Smoke detection is not required for exterior balconies.

907.2.6.1.1 Smoke detectors within dwelling and sleeping units. Smoke detectors and notification appliances shall be installed in dwelling units and such notification appliances shall activate only in the unit in which the alarm originates. Such detectors and appliances shall be annunciated by dwelling unit at a constantly attended location from which the fire alarm system is capable of being manually activated. Smoke detectors are required in the following areas:

1. Sleeping areas;
2. Every room in the path of the means of egress from the sleeping area to the door leading from the dwelling unit; and
3. Each story within the unit, including below-grade stories. For dwelling units with split levels and without an intervening door between the adjacent levels, a smoke detector installed on the upper level shall suffice for the adjacent lower level.

907.2.6.2 Group I-2. An automatic smoke detection system shall be installed in corridors in nursing homes (both intermediate-care and skilled nursing facilities), corridors in detoxification facilities and spaces permitted to be open to the corridors by Section 407.2. The system shall be activated in accordance with Section 907.5. Hospitals shall be equipped with smoke detection as required in Section 407. A one-way voice communication system activated in accordance with Section 907.5.2.2 shall be provided at the fire command center for use by Fire Department personnel. A two-way voice communication system in accordance with Section 907.2.13.3 shall be provided for Group I-2 buildings.

~~**[907.2.6.2.1 Group I-2 hospital buildings.** Group I-2 hospital buildings where the highest occupied floor is less than 75 feet (22 860 mm) above the lowest level of Fire Department vehicle access shall be provided with partial coverage automatic smoke detection connected to an automatic fire alarm system in accordance with Section 907.2.13.1 and an emergency voice/alarm communication system in accordance with Section 907.5.2.2.]~~

907.2.6.3 Group I-3. Group I-3 occupancies shall be equipped with a manual and automatic fire alarm system and automatic smoke detection system installed for alerting staff.

907.2.6.3.1 System initiation. Actuation of an automatic fire-extinguishing system, automatic sprinkler system, a manual fire alarm box, a fire detector, or a smoke detector shall initiate an approved alarm signal that automatically notifies staff.

907.2.6.3.2 Manual fire alarm boxes. Manual fire alarm boxes are not required to be located in accordance with Section 907.4.2 where the fire alarm boxes are provided at staff-attended locations having direct supervision over areas where manual fire alarm boxes have been omitted.

907.2.6.3.2.1 Manual fire alarm boxes in detainee areas. Manual fire alarm boxes are allowed to be locked in areas occupied by detainees, provided that staff members are present within the subject area and have keys readily available to operate the manual fire alarm boxes.

907.2.6.3.3 Automatic smoke detection system. An automatic smoke detection system shall be installed throughout resident housing [~~units~~] areas, including sleeping [~~areas~~] units and contiguous day rooms, group activity spaces and other common spaces normally accessible to residents.

Exceptions:

1. Other approved smoke detection arrangements providing equivalent protection, including, but not limited to, placing detectors in exhaust ducts from cells or behind protective guards listed for the purpose, are allowed when necessary to prevent damage or tampering.
2. Sleeping units in Use Conditions 2 and 3 as described in Section 308.
3. Smoke detectors are not required in sleeping units with four or fewer occupants in smoke compartments that are equipped throughout with an approved automatic sprinkler system installed in accordance with Section 903.3.1.1.

907.2.7 Group M. A manual and automatic fire alarm system shall be installed in Group M occupancies where any one of the following conditions exists:

1. Where a Group M fire area exceeds 12,000 square feet (~~[1115]~~ 1114.8 m²);
2. Where a Group M fire area is located more than three stories above grade;
3. Where the combined area of all Group M fire areas on all floors, including mezzanines, exceeds 24,000 square feet (~~[2230]~~ 2229.7 m²); or
4. Where a Group M fire area in a below-grade story exceeds 1,500 square feet (~~[139]~~ 139.4 m²).

Where such occupancies are not protected by an automatic sprinkler system, a manual fire alarm and partial coverage automatic smoke detection or automatic heat detection system shall be installed in accordance with NFPA 72.

907.2.7.1 Large-area buildings. Group M occupancies having a total gross area exceeding 100,000 square feet (~~[9290]~~ 9290.3 m²) located in buildings where the highest occupied floor is [~~less than~~] 75 feet (22 860 mm) or less above the lowest level of Fire Department vehicle access and covered mall buildings having a total gross area exceeding 50,000 square feet (~~[4645]~~ 4645.2 m²) shall be provided with automatic smoke detection connected to an automatic fire alarm system in accordance with Section 907.2.13.1 and an emergency voice/alarm communication system in accordance with Section 907.5.2.2 initiating a total evacuation signal.

907.2.8 Group R-1. Fire alarm systems shall be installed in Group R-1 occupancies as required in Sections 907.2.8.1 through [~~907.2.8.4]~~ 907.2.8.5.

907.2.8.1 Manual fire alarm system. A manual fire alarm system that activates the occupant notification system in accordance with Section 907.5 shall be installed in Group R-1 occupancies.

Exception: A manual fire alarm system is not required in buildings not over two stories in height where all individual [~~dwelling~~] sleeping units and contiguous attic and crawl spaces are separated from each other and public or common areas by at least 1-hour fire partitions and each individual dwelling unit has an exit directly to a public way, exit court or yard.

907.2.8.2 Automatic smoke detection system. An automatic smoke detection system that activates the occupant notification system in accordance with Section 907.5 shall be installed in all public corridors serving dwelling units [~~and~~] or sleeping units in accordance with Section 907.2.8.3.

Exception: An automatic fire detection system is not required in buildings that do not have public corridors serving [~~dwelling~~] sleeping units and each [~~dwelling~~] sleeping unit has a means of egress door opening directly to an exterior exit access that leads directly to an exit.

907.2.8.3 Smoke detectors within dwelling units and sleeping units. Smoke detectors and audible notification appliances shall be installed in dwelling units and sleeping units and shall be annunciated by dwelling unit and sleeping unit at a constantly attended location from which the fire alarm system is capable of being manually activated. Smoke detectors are required in the following areas:

1. In sleeping areas.
2. In every room in the path of the means of egress from the sleeping area to the door leading from the dwelling unit and sleeping unit.
3. In each story within the unit, including below-grade stories. For dwelling units and sleeping units with split levels and without an intervening door between the adjacent levels, a smoke alarm installed on the upper level shall suffice for the adjacent lower level.

907.2.8.4 Group R-1 student dormitories. A manual and automatic smoke detection system shall be installed in occupancies for student or school staff dormitory housing in all of the following locations:

1. Common spaces outside of sleeping units.
2. Laundry rooms, mechanical equipment rooms and storage rooms.
3. Interior corridors serving sleeping units.

Exception: An automatic smoke detection system is not required in buildings that do not have interior corridors serving sleeping units or dwelling units and where each sleeping unit or dwelling unit either has a means of egress door opening directly to an exterior exit access that leads directly to an exit or a means of egress door opening directly to an exit.

Required smoke alarms for student or staff dormitory housing shall be interconnected with the fire alarm system in accordance with NFPA 72.

[907.2.8.4] 907.2.8.5 Large Group R-1 occupancies. Group R-1 occupancies with a total of more than 50 sleeping rooms above street level located in buildings where the highest occupied floor is [~~less than~~] 75 feet (22 860 mm) or less above the lowest level of Fire Department vehicle access, or communal sleeping facilities above street level occupied or designed to be occupied by more than 50 lodgers, shall be provided with automatic smoke detection connected to an automatic fire alarm system in accordance with Section 907.2.13.1 and an emergency voice/alarm communication system in accordance with Section 907.5.2.2 that initiates a total evacuation signal.

907.2.9 Group R-2. A fire alarm system without alarm notification appliances and smoke alarms shall be installed in accordance with this section in Group R-2 occupancies, other than student apartments, where such occupancy satisfies any one of the following conditions:

1. Any dwelling unit is located three or more stories above the lowest level of exit discharge, including dwelling units in penthouses of any area;
2. Any dwelling unit is located more than one story below the highest level of exit discharge of exits serving the dwelling unit; or
3. The building contains more than 16 dwelling units.

Actuation of smoke detectors shall not initiate a signal to alarm notification appliances. The activation of any detector required by this section shall initiate a signal at a central station or a constantly attended location. Smoke detectors shall be located as follows:

1. In each mechanical equipment, electrical, transformer, telephone equipment or similar room [~~, greater than 75 square feet (6.96 m²) in area~~].
2. In air distribution systems in accordance with Section 606 of the *New York City Mechanical Code*.

3. In elevator machine rooms and in elevator lobbies.

907.2.9.1 Group R-2 student apartments. Where the main use or dominant occupancy of a building is classified as R-2 student apartments, as defined in Section 310.2, fire alarm systems shall be installed in accordance with Section 907.2.8. Where the main use or dominant occupancy of a building is not classified as R-2 student apartments and the building is occupied partially by Group R-2 student apartments, fire alarm systems shall be installed in accordance with Sections 907.2.9.1.1 through 907.2.9.2.

907.2.9.1.1 Manual fire alarm system. A manual fire alarm system shall be installed throughout all public corridors serving student apartments and student-related uses. Student-related uses shall include common spaces such as recreation rooms, lounges, dining rooms, laundry rooms and storage rooms.

Exceptions:

1. A manual fire alarm system is not required in buildings not over two stories in height where all individual dwelling units and contiguous attic and crawl spaces are separated from each other and public or common areas by at least 1-hour fire partitions and each individual dwelling unit has an exit directly to a public way, exit court or yard.
2. A manual fire alarm system is not required in buildings containing fewer than 15 student apartments.

907.2.9.1.2 Automatic fire alarm system. An automatic fire alarm system without alarm notification appliances shall be installed in accordance with this section in Group R-2 student apartments and student-related uses. The activation of any smoke detector required by this section shall initiate a signal at a central station or a constantly attended location. Smoke detectors shall be located as follows:

1. In each mechanical equipment, electrical, transformer, telephone equipment or similar room, in elevator machine rooms, and in elevator lobbies.
2. In air distribution systems in accordance with Section 606 of the *New York City Mechanical Code*.
3. Throughout all public corridors serving student apartments and student-related uses. Student-related uses shall include common spaces such as recreation rooms, lounges, dining rooms, laundry rooms and storage rooms. However, smoke detectors shall not be required in such public corridors in buildings containing fewer than 15 student apartments.

Exception: An automatic fire alarm system is not required in buildings not over two stories in height where all individual dwelling units and contiguous attic and crawl spaces are separated from each other and public or common areas by at least 1-hour fire barriers and each individual dwelling unit has an exit directly to a public way, exit court or yard.

907.2.9.2 Smoke alarms. Single- and multiple-station smoke alarms shall be installed in accordance with Section 907.2.11.

907.2.10 [Reserved.] Group S. A manual and automatic fire alarm system shall be installed in Group S occupancies where any one of the following conditions exists:

1. Group S fire area has an occupant load of 300 occupants or more;
2. The combined occupant load of all Group S fire areas on all floors, including mezzanines, is 300 or more.

907.2.10.1 Large-area buildings. Group S occupancies having a total gross area exceeding 500,000 square feet (46 451.5 m²) located in buildings, where the highest occupied floor is 75 feet (22 860) or less above the lowest level of Fire Department vehicle access, shall be provided with automatic smoke detection connected to an automatic fire alarm system in accordance with Section 907.2.13.1 and an emergency voice/alarm communication system in accordance with Section 907.5.2.2 that initiates a total evacuation signal.

907.2.11 Single- and multiple-station smoke alarms. Listed single- and multiple-station smoke alarms complying with UL 217 shall be installed in accordance with Sections 907.2.11.1 through ~~[907.2.11.4]~~ 907.2.11.7 and NFPA 72.

907.2.11.1 Smoke alarms in Groups R-2~~[,]~~ and R-3 ~~[, and I-1]~~. Single- or multiple-station smoke alarms shall be installed and maintained in Groups R-2~~[,]~~ and R-3 ~~[, and I-1]~~, regardless of occupant load at all of the following locations within all dwelling units:

1. On the ceiling or wall outside of each room used for sleeping purposes within 15 feet (4572 mm) from the door to such room.
2. In each room used for sleeping purposes.

[Exception: ~~Single or multiple station smoke alarms in Group I-1 shall not be required where smoke detectors are provided in the sleeping rooms as part of an automatic smoke detection system.]~~

3. In each story within a dwelling unit, including below-grade stories and penthouses of any area, but not including crawl spaces and uninhabitable attics. In dwellings or dwelling units with split levels and without an intervening door between the adjacent levels, a smoke alarm installed on the upper level shall suffice for the adjacent lower level provided that the lower level is less than one full story below the upper level.

907.2.11.1.1 Group R-2 occupancy. Smoke alarms shall be provided with the capability to support visible alarm notification appliances in accordance with ICC/ANSI A117.1.

907.2.11.2 Power source. Required smoke alarms shall receive their primary power from a dedicated branch circuit or the unswitched portion of a branch circuit also used for power or lighting, or both, and shall be equipped with a battery backup. Smoke alarms shall emit a signal when the batteries are low. Wiring shall be permanent and without a disconnecting switch other than as required for over-current protection.

Exception: Smoke alarms with integral strobes shall not require battery backup provided that the smoke alarms are connected to an emergency or standby power electrical source.

907.2.11.3 Installation near cooking appliances. Smoke alarms shall not be installed in the following locations unless this would prevent placement of a smoke alarm in a location required by Section 907.2.11.1:

1. Ionization smoke alarms shall not be installed less than 20 feet (6096 mm) horizontally from a permanently installed cooking appliance.
2. Ionization smoke alarms with an alarm-silencing switch shall not be installed less than 10 feet (3048 mm) horizontally from a permanently installed cooking appliance.
3. Photoelectric smoke alarms shall not be installed less than 6 feet (1828.8 mm) horizontally from a permanently installed cooking appliance.

907.2.11.4 Installation near bathrooms. Smoke alarms shall be installed not less than 3 feet (914.4 mm) horizontally from the door or opening of a bathroom that contains a bathtub or shower unless this would prevent placement of a smoke alarm required by Section 907.2.11.1.

~~[907.2.11.3]~~ **907.2.11.5 Interconnection.** Where more than one smoke alarm ~~[or detector]~~ is required to be installed within an individual dwelling unit or sleeping unit in Group ~~[I-1,]~~ R-2~~;~~ and R-3 occupancies, ~~[or within an individual dwelling unit or sleeping unit in Group R-1,]~~ the smoke alarms ~~[or detectors]~~ shall be interconnected in such a manner that the activation of one alarm ~~[or detector]~~ will activate all of the alarms ~~[or detectors]~~ in the individual unit. Physical interconnection of smoke alarms shall not be required where listed wireless alarms are installed and all alarms sound upon activation of one alarm. The alarm ~~[or detector]~~ shall be clearly audible in all bedrooms over background noise levels with all intervening doors closed.

~~[907.2.11.4 Group R-2 occupancy.~~ Smoke alarms shall be provided with the capability to support visible alarm notification appliances in accordance with ICC/ANSI A117.1-]

~~[907.2.11.5]~~ **907.2.11.6 Smoke alarms and smoke detectors in group R occupancies.** On and after January 1, 2021, smoke alarms and smoke detectors shall not be installed or replaced in an individual dwelling or sleeping unit, including dwellings or units in prior code buildings, within an area of exclusion determined by a 20 foot ~~[(6.0 m)]~~ (6096 mm) radial distance along a horizontal flow path from a stationary or fixed cooking appliance, unless listed in accordance with the 8th edition of UL 217 for smoke alarms or the 7th edition of UL 268 for smoke detectors.

907.2.11.7 Smoke detection system. Smoke detectors listed in accordance with UL 268 and provided as part of the building fire alarm system shall be an acceptable alternative to single and multiple station smoke alarms and shall comply with the following:

1. The fire alarm system shall comply with all applicable requirements in Section 907 of this code.

2. Activation of a smoke detector in a dwelling unit or sleeping unit shall initiate alarm notification in the dwelling unit or sleeping unit in accordance with Section 907.5.2 of this code.
3. Activation of a smoke detector in a dwelling unit or sleeping unit shall not activate alarm notification appliances outside of the dwelling unit or sleeping unit, provided that a supervisory signal is generated and monitored in accordance with Section 907.6.5 of this code.

907.2.12 Special amusement buildings. An automatic smoke detection system shall be provided in special amusement buildings in accordance with Sections 907.2.12.1 through 907.2.12.3.

Exception: In areas where ambient conditions will cause a smoke detection system to alarm, an approved alternative type of automatic detector shall be installed.

907.2.12.1 Alarm. ~~[Activation]~~ Actuation of [any] a single smoke detector, [the] automatic sprinkler system or [any] other automatic fire detection [device] system shall [immediately sound an alarm at the building] initiate a pre-signal system in accordance with NFPA 72 at a constantly attended location from which [emergency action can be initiated, including the capability of manual initiation of requirements in Section 907.2.12.2] the Fire Department shall be notified and live voice evacuation instructions shall be initiated using an emergency voice/alarm communications system in accordance with Section 907.5.2.2.

907.2.12.2 System response. The following minimum system actuations and responses shall be required upon approval by the department and the Fire Department. The activation of two or more smoke detectors, a single smoke detector equipped with an alarm verification feature, the automatic sprinkler system or other approved fire detection device shall automatically do all of the following:

1. Cause illumination of the means of egress with light of not less than 1 ~~[foot candle]~~ footcandle (11 lux) at the walking surface level[;].
2. Stop any conflicting or confusing sounds and visual distractions[; and].
3. Activate an approved directional exit marking that will become apparent in an emergency[; and].
- ~~[4. Activate a prerecorded message, clearly audible throughout the special amusement building, instructing patrons to proceed to the nearest exit. Alarm signals used in conjunction with the prerecorded message shall produce a sound that is distinctive from other sounds used during normal operation.]~~

907.2.12.3 Emergency voice/alarm communication system. An emergency voice/alarm communication system, which is also allowed to serve as a public address system, shall be installed in accordance with Section 907.5.2.2[;] and be audible throughout the entire special amusement building.

907.2.13 High-rise buildings. In addition to the requirements of Sections 907.2.1 through 907.2.12, buildings constructed in accordance with Section 403 and having floors used for human occupancy located more than 75 feet (22 860 mm) above the lowest level of Fire Department vehicle access shall be provided with an automatic smoke detection connected to an automatic fire alarm system in accordance with Section 907.2.13.1, a Fire Department communication system in accordance with Section 907.2.13.2, a two-way communication system in accordance with Section 907.2.13.3, and an emergency voice/alarm communication system in accordance with Section 907.5.2.2.

Exceptions:

1. Open parking garages in accordance with Section ~~[406.3]~~ 406.5.
2. Buildings with an occupancy in Group A-5 in accordance with Section ~~[303.1]~~ 303.6.
3. ~~[Special]~~ Low-hazard special occupancies in accordance with Section 503.1.1.
4. Buildings with an occupancy in Group H-1, H-2 or H-3 in accordance with Section 415.

907.2.13.1 Automatic smoke detection. In addition to smoke detection otherwise required by this code, automatic smoke detection in high-rise buildings shall be in accordance with Sections 907.2.13.1.1 and 907.2.13.1.2.

Exception for Group R-2 occupancies: In R-2 occupancies, the activation of smoke detectors shall initiate a signal at a central supervising station or a constantly attended location and shall not initiate a signal to ~~[an]~~ alarm notification appliances.

907.2.13.1.1 Automatic smoke detection. Automatic smoke detectors shall be provided in accordance with this section. Smoke detectors shall be connected to an automatic fire alarm system. The activation of any detector required by this section shall ~~[operate]~~ activate the emergency voice/alarm communication system. Smoke detectors shall be located as follows:

1. In each mechanical equipment, electrical, transformer, telephone equipment or similar room.
2. In each elevator machine room and in elevator lobbies.

907.2.13.1.2 Duct smoke detection. Duct smoke detectors complying with Section 907.3.1 shall be located in air distribution systems in accordance with Section 606 of the *New York City Mechanical Code*.

907.2.13.2 Fire Department communication system. ~~[A]~~ The Fire Department Auxiliary Radio Communication System (ARCS)~~[, which]~~ shall be in accordance with Section ~~[917, shall be required in all high-rise buildings]~~ 916.

[Exception: Where it is determined by the Fire Department that a radio communication system is not required.]

907.2.13.3 Two-Way Communication System. A two-way voice communication system (warden) phone that complies with the requirements of NFPA 72 shall be provided in the following locations and shall comply with the following requirements. Such phones shall communicate with the fire command center.

1. In Group B high-rise office buildings and large area office buildings, there shall be a minimum of two phones located on every floor accessible to all occupants, with each phone located within 5 feet (1524 mm) of a different exit stair.
2. Where elevator lobbies are permitted to be locked, the phones provided are permitted to be connected to the fire alarm system.
3. If phones are provided in areas of rescue assistance and refuge areas, the phones are permitted to be connected to the fire alarm system.
4. Where phones are provided to meet the requirements for stairway communication systems in Section 403.5.3.1, the phones are permitted to be connected to the fire alarm system.
5. In all Group I-2 buildings, there shall be a phone located at staff attended locations, such as nurses' stations or similar locations accessible to all staff members, on every patient floor per fire/smoke zone. Phones shall also be located in areas of the building where the fire alarm does not sound.

Exception: Group R-2 occupancies.

907.2.14 Atriums connecting more than two stories. A fire alarm system shall be installed in occupancies with an atrium that connects more than two stories, with smoke detection installed [~~throughout~~] in locations as required by a rational analysis in Section 909.4 and in accordance with the [atrium] system operation requirements in Section 909.17. The system shall be activated in accordance with Section 907.5. Such occupancies in Group A, E or M shall be provided with an emergency voice/alarm communication system complying with the requirements of Section 907.5.2.2.

907.2.15 High-piled combustibile storage areas. An automatic fire detection system shall be installed throughout high-piled combustibile storage areas where required by the *New York City Fire Code*.

907.2.16 Aerosol storage uses. Aerosol storage rooms and general-purpose warehouses containing aerosols shall be provided with an approved manual fire alarm system where required by the *New York City Fire Code*.

907.2.17 Lumber, wood structural panel and veneer mills. Lumber, wood structural panel and veneer mills shall be provided with a manual fire alarm system.

907.2.18 Underground buildings with compartment smoke control system. Where a compartment smoke control system is installed in an underground building as required by Section 405, automatic [~~fire~~] smoke detectors shall be provided in accordance with Section 907.2.18.1.

907.2.18.1 Smoke detectors. ~~[A minimum of]~~ Not fewer than one smoke detector listed for the intended purpose shall be installed in all of the following areas:

1. Mechanical equipment, electrical, transformer, telephone equipment, elevator machine or similar rooms.
2. Elevator lobbies.
3. The main supply ~~[and]~~, main return, and exhaust air plenum of each air-conditioning system serving more than one story and located in a serviceable area downstream from filters on supply ducts and in return/exhaust ducts downstream of the last duct inlet.
4. Each connection to a vertical duct or riser serving two or more floors from return air ducts or plenums of heating, ventilating and air-conditioning systems, except that in Group R occupancies, a listed smoke detector is allowed to be used in each return air riser carrying not more than 5,000 cfm (2.4 m³/s) and serving not more than 10 air inlet openings.

907.2.18.2 Alarm required. Activation of the smoke exhaust system shall activate an audible alarm at a constantly attended location.

907.2.19 Underground buildings. In underground buildings complying with Section 405 where the lowest level of a structure is more than 30 feet ~~[(18 144 mm)]~~ (9144 mm) below the lowest level of exit discharge, the structure shall be equipped throughout with a manual and automatic fire alarm system, including an emergency voice/alarm communication system installed in accordance with Section 907.5.2.2.

907.2.20 Covered and open mall buildings. ~~[Covered mall buildings exceeding]~~ Where the total floor area exceeds 50,000 square feet ([4645] 4645.2 m²) [in total floor area shall be provided with] within either a covered mall building or within the perimeter line of an open mall building, an emergency voice/alarm communication system shall be provided. ~~[An emergency]~~ Emergency voice/alarm communication ~~[system]~~ systems serving a mall, required or otherwise, shall be accessible to the Fire Department. The system shall be provided in accordance with Section 907.5.2.2.

907.2.21 ~~[Battery rooms.~~ ~~An approved automatic smoke detection system shall be installed in areas containing stationary storage battery systems having a liquid capacity of more than 50 gallons (189.3 L). Where the battery room is located in a building or space that is provided with a fire alarm system or subsystem, the smoke detectors shall be connected to such building fire alarm system or subsystem. The detection system shall be supervised by a central supervising station, or a local alarm that will sound an audible signal at a constantly attended location.]~~
Reserved.

907.2.22 Airport traffic control towers. An automatic smoke detection system that activates the occupant notification system in accordance with Section 907.5 shall be provided in airport control towers in ~~[all occupiable and equipment spaces]~~ accordance with Sections 907.2.22.1 and 907.2.22.2.

Exception: Audible appliances shall not be installed within the control tower cab.

907.2.22.1 Airport traffic control towers with multiple exits and automatic sprinklers.

Airport traffic control towers with multiple exits and equipped throughout with an automatic sprinkler system in accordance with Section 903.3.1.1 shall be provided with smoke detectors in all of the following locations:

1. Airport traffic control cab.
2. Electrical and mechanical equipment rooms.
3. Airport terminal radar and electronics rooms.
4. Outside each opening into interior exit stairways.
5. Along the single means of egress permitted from observation levels.
6. Outside each opening into the single means of egress permitted from observation levels.

907.2.22.2 Other airport traffic control towers. Airport traffic control towers with a single exit or where sprinklers are not installed throughout shall be provided with smoke detectors in all of the following locations:

1. Airport traffic control cab.
2. Electrical and mechanical equipment rooms.
3. Airport terminal radar and electronics rooms.
4. Office spaces incidental to the tower operation.
5. Lounges for employees, including sanitary facilities.
6. Means of egress.
7. Accessible utility shafts.

907.2.23 Battery rooms. An approved automatic smoke detection system shall be installed in areas containing any battery systems. Where the battery room is located in a building or space that is provided with a fire alarm system or subsystem, the smoke detectors shall be connected to such building fire alarm system or subsystem. The detection system shall be supervised by a central supervising station, or a local alarm that will sound an audible signal at a constantly attended location. Battery rooms shall also comply with the requirements of the *New York City Fire Code*.

907.3 Fire safety functions. Automatic fire detectors utilized for the purpose of performing fire safety functions shall be connected to the building's fire alarm control unit where a fire alarm system is required by Section 907.2. Detectors shall, upon actuation, perform the intended function and

activate the alarm notification appliances or activate a visible and audible supervisory signal at a constantly attended location.

Exception: In buildings not equipped with a fire alarm system, the automatic fire detector shall be powered by normal electrical service and, upon actuation, perform the intended function. The detectors shall be located in accordance with NFPA 72.

907.3.1 Duct smoke detectors. Smoke detectors installed in ducts shall be listed for the air velocity, temperature and humidity present in the duct. Duct smoke detectors shall be connected to the building's fire alarm control unit when a fire alarm system is required by Section 907.2. Activation of a duct smoke detector shall initiate a visible and audible [~~supervisory~~] alarm signal at a constantly attended location and shall perform the intended fire safety function in accordance with this code and the *New York City Mechanical Code*. Duct smoke detectors shall not be used as a substitute for required open area detection.

Exceptions:

1. The [~~supervisory~~] alarm signal at a constantly attended location is not required where duct smoke detectors activate the [~~building~~] building's alarm notification appliances.
2. In occupancies not required to be equipped with a fire alarm system, actuation of a smoke detector shall activate a visible and an audible signal in an approved location. Smoke detector trouble conditions shall activate a visible or audible signal in an approved location and shall be identified as air duct detector trouble.

907.3.2 Delayed egress locks. Where delayed egress locks are installed on means of egress doors in accordance with Section [~~1008.1.9.7~~] 1010.1.9.7, an automatic smoke or heat detection system shall be installed as required by that section.

907.3.3 Elevator emergency operation. Automatic fire detectors installed for elevator emergency operation shall be installed in accordance with the provisions of Chapter 30 of this code, ASME A17.1 and NFPA 72.

907.3.4 Wiring. The wiring to the auxiliary devices and equipment used to accomplish [~~the above~~] fire safety functions shall be monitored for integrity in accordance with NFPA 72 and the *New York City Electrical Code*.

907.3.5 Monitoring of hold-open devices and closers. All hold-open devices used in automatic-closing doors pursuant to the exception to Section [~~708.7~~] 713.7 shall be electrically supervised to monitor the integrity of the wiring connections among the fire alarm system, the smoke detection system, and the hold-open devices.

907.4 Initiating devices. Where manual or automatic alarm initiation is required as part of a fire alarm system, the initiating devices shall be installed in accordance with Sections 907.4.1 through [~~907.4.3~~] 907.4.4.

907.4.1 Protection of fire alarm control unit. In areas that are not continuously occupied, a single smoke detector shall be provided at the location of each fire alarm control unit, notification appliance circuit power extenders, and supervising station transmitting equipment.

Exceptions:

1. Where ambient conditions prohibit installation of a smoke detector, a heat detector shall be permitted.
2. In prior code buildings, where a fire alarm control unit is installed in an ~~[exit enclosure]~~ interior exit stairway or ramp or exit passageway, a smoke detector is not required at the location of such fire alarm control unit.

907.4.2 Manual fire alarm boxes. Where a manual fire alarm system is required by another section of this code, it shall be activated by fire alarm boxes installed in accordance with Sections 907.4.2.1 through ~~[907.4.2.5]~~ 907.4.2.6.

907.4.2.1 Location. Manual fire alarm boxes shall be located not more than 5 feet (1524 mm) from the entrance to each exit. Additional manual fire alarm boxes shall be located so that travel distance to the nearest box does not exceed 200 feet (60 960 mm).

907.4.2.2 Height. The height of the manual fire alarm boxes shall be ~~[a minimum of]~~ not less than 42 inches (~~[1067]~~ 1066.8 mm) and ~~[a maximum of]~~ not more than 48 inches (~~[1219]~~ 1220 mm) measured vertically, from the floor level to the activating handle or lever of the box.

907.4.2.3 Color. Manual fire alarm boxes shall be red in color.

907.4.2.4 Signs. Where fire alarm systems are not required to be monitored by a supervising station, an approved permanent sign that reads: WHEN ALARM SOUNDS—CALL 911 shall be installed adjacent to each manual fire alarm box.

Exception: Where the manufacturer has permanently provided this information on the manual fire alarm box.

907.4.2.5 Protective covers. The Fire Department is authorized to require the installation of listed manual fire alarm box protective covers to prevent malicious false alarms or provide the manual fire alarm box with protection from physical damage. The protective cover shall be transparent or red in color with a transparent face to permit visibility of the manual fire alarm box. Each cover shall include proper operating instructions. A protective cover that emits a local alarm signal shall not be installed unless approved. Protective covers shall not project more than that permitted by Section 1003.3.3.

907.4.2.6 Unobstructed and unobscured. Manual fire alarm boxes shall be readily accessible, unobstructed, unobscured and visible at all times.

907.4.3 Automatic smoke detection. Where an automatic smoke detection system is required, it shall utilize smoke detectors unless ambient conditions prohibit such an installation. In spaces

where smoke detectors cannot be utilized due to ambient conditions, approved automatic heat detectors shall be permitted.

907.4.3.1 Automatic sprinkler system. For conditions other than specific fire safety functions noted in Section 907.3, in areas where ambient conditions prohibit the installation of smoke detectors, an automatic sprinkler system installed in such areas in accordance with Section 903.3.1.1 or 903.3.1.2 and that is connected to the fire alarm system shall be approved as automatic heat detection.

907.4.4 Fire-extinguishing systems. Where a fire alarm system is required by another section of this code or is otherwise installed, automatic fire-extinguishing systems installed in accordance with Section 904 shall be monitored by the fire alarm system.

907.5 Occupant notification systems. A fire alarm system shall annunciate at the [~~panel~~] fire alarm control unit and shall initiate occupant notification upon activation, in accordance with Sections 907.5.1 through [~~907.5.2.3.3~~] 907.5.2.3.2. Where a fire alarm system is required by another section of this code, it shall be activated by:

1. Automatic fire detectors.
2. [~~Sprinkler~~] Automatic sprinkler system waterflow devices.
3. Manual fire alarm boxes.
4. Automatic fire-extinguishing systems.

Exception: Where notification systems are allowed elsewhere in Section 907 to annunciate at a constantly attended location or to a central supervising station.

907.5.1 Presignal feature. A presignal feature shall not be installed unless approved by the Fire Department. Where a presignal feature is provided, a signal shall be annunciated at a constantly attended location approved by the Fire Department, in order that occupant notification can be activated in the event of fire or other emergency.

907.5.2 Alarm notification appliances. Alarm notification appliances shall be provided and shall be listed for their purpose.

907.5.2.1 Audible alarms. Audible alarm notification appliances shall be provided and emit a distinctive sound that is not to be used for any purpose other than that of a fire alarm.

[~~Exception:~~] Exceptions:

1. Visible alarm notification appliances shall be allowed in lieu of audible alarm notification appliances in critical care areas of Group I-2 occupancies.
2. Where provided, audible notification appliances located in each occupant evacuation elevator lobby in accordance with Section 3008.10.1 shall be connected to a separate notification zone for manual paging only.

907.5.2.1.1 Average sound pressure. The audible alarm notification appliances shall provide a sound pressure level of 15 decibels (dBA) above the average ambient sound level or 5 dBA above the maximum sound level having a duration of ~~[at least]~~ not less than 60 seconds, whichever is greater, in every occupiable space within the building. The minimum sound pressure levels shall be: 75 dBA in occupancies in Groups R and I-1; 90 dBA in mechanical equipment rooms and 60 dBA in other occupancies. For one-way voice communication system in Group R-2 occupancies, the minimum sound pressure level of the alert tone shall be 75 dBA throughout the dwelling unit.

907.5.2.1.2 Maximum sound pressure. The maximum sound pressure level for audible alarm notification appliances shall be 110 dBA at the minimum hearing distance from the audible appliance. Where the average ambient noise is greater than 95 dBA, visible alarm notification appliances shall be provided in accordance with NFPA 72 and audible alarm notification appliances shall not be required.

907.5.2.2 Emergency voice/alarm communication systems. Emergency voice/alarm communication systems required by this code shall be designed and installed in accordance with NFPA 72. The operation of any automatic fire detector, sprinkler waterflow device or manual fire alarm box shall automatically sound an alert tone followed by voice instructions giving approved information and directions for a general or staged evacuation in accordance with the building's fire safety and evacuation plans required by the *New York City Fire Code*. In high-rise buildings, the system shall operate on ~~[a minimum of]~~ at least the alarming floor, the floor above and the floor below. Speakers shall be provided throughout the building by paging zones. At a minimum, paging zones shall be provided as follows:

1. Each exit stairway.
2. Each floor.
3. Refuge areas as defined in ~~[Section 1002.4]~~ Chapter 2 of this code.

Exceptions:

1. **Group I-1 and I-2 occupancies.** In Group I-1 and I-2 occupancies, the alarm shall sound in a constantly attended area and a general occupant notification shall be broadcast over the overhead page.
- ~~2. **Group R-2 occupancies 125 feet or less in height.** Emergency voice/alarm communication systems shall not be required in Group R-2 occupancies in buildings 125 feet (33 100 mm) or less in height.~~
- ~~3.~~ 2. **Group R-2 occupancies greater than [125 feet] 75 feet (22 860 mm) in height.** In Group R-2 occupied buildings greater than [125 feet (33 100 mm)] 75 feet (22 860 mm) in height above the lowest level of Fire Department vehicle access, activation of any smoke detector or sprinkler water flow device shall initiate a signal at a central supervising station or constantly attended location and shall not initiate a signal to an alarm notification appliance. An emergency voice/alarm communication system shall not be required. However, a one-way

voice communication shall be provided between the fire command center for use by Fire Department personnel and the following terminal areas:

~~[3-1.]~~ 2.1. Within dwelling units. An intercom system may be utilized when provided with an override feature for use by Fire Department personnel. Such intercom system shall comply with rules promulgated by the commissioner establishing installation requirements.

~~[3-2.]~~ 2.2. Within required exit stairs. Annunciation devices shall be located at least on every other story units. Such annunciation devices shall comply with rules promulgated by the commissioner establishing installation requirements.

907.5.2.2.1 Manual override. A manual override for emergency voice communication shall be provided on a selective and all-call basis for all paging zones.

907.5.2.2.2 Live voice messages. The emergency voice/alarm communication system shall have multi-channel capability to broadcast live voice messages by paging zones on a selective and all-call basis without automatic interruption of the alarm tones on the floor of incidence, floor above or floor below.

907.5.2.2.3 Alternate uses. When approved by the ~~[fire commissioner]~~ Fire Commissioner, the emergency voice/alarm communication system may be allowed to be used for other announcements.

907.5.2.2.4 Emergency voice/alarm communication captions. Where stadiums, arenas and grandstands provide audible public announcements, the emergency/voice alarm communication system shall be captioned. Emergency captions shall be approved by the Fire Department.

907.5.2.2.5 Emergency power. Emergency voice/alarm communications systems shall be provided with an approved emergency power source in accordance with Section 2702 of this code and the New York City Electrical Code.

907.5.2.3 Visible alarms. Visible alarm notification appliances shall be provided in accordance with Sections 907.5.2.3.1 through ~~[907.5.2.3.3]~~ 907.5.2.3.2.

Exceptions:

1. Visible alarm notification appliances shall not be required in exits as defined in Chapter 2.
2. Visible alarm notification appliances shall not be required in elevator cars.

907.5.2.3.1 Public and common areas. Visible alarm notification appliances shall be provided in public use areas and common use areas, as defined in Chapter 2.

~~[907.5.2.3.2 Employee work areas.]~~ **Exception:** Where employee work areas have audible alarm coverage, the notification appliance circuits serving the employee work

areas shall be initially designed with ~~[a minimum of]~~ not less than 20-percent spare capacity to account for the potential of adding visible notification appliances in the future to accommodate hearing impaired employee(s).

[907.5.2.3.3] 907.5.2.3.2 Groups I-1 and R-1. Group I-1 and R-1 dwelling units or sleeping units in accordance with Table ~~[907.5.2.3.3]~~ 907.5.2.3.2 shall be provided with a visible alarm notification appliance, activated by both the in-room smoke detector and the building fire alarm system.

**TABLE ~~[907.5.2.3.3]~~ 907.5.2.3.2
VISIBLE ALARMS**

NUMBER OF UNITS	UNITS WITH VISIBLE ALARMS
6 to 25	2
26 to 50	4
51 to 75	7
76 to 100	9
101 to 150	12
151 to 200	14
201 to 300	17
301 to 400	20
401 to 500	22
501 to 1,000	5% of total
1,001 and over	50 plus 3 for each 100 over 1,000

907.6 Installation and monitoring. A fire alarm system shall be installed and monitored in accordance with ~~[this section]~~ Sections 907.6.1 through 907.6.5.2 of this code and NFPA 72 [as modified by Appendix Q].

907.6.1 Wiring. Wiring shall comply with the requirements of the *New York City Electrical Code* and NFPA 72 ~~[as modified by Appendix Q]~~. Wireless protection systems utilizing radio-frequency transmitting devices shall comply with the special requirements for supervision of low-power wireless systems in NFPA 72~~[as modified by Appendix Q]~~.

907.6.2 Power supply. The primary and secondary power supply for the fire alarm system shall be provided in accordance with the *New York City Electrical Code*.

Exception: Secondary power for single-station and multiple-station smoke alarms as required in Section ~~[907.2.11.2]~~ 907.2.11.2.

907.6.3 Zones. Each floor shall be zoned separately. For non-addressable systems, ~~[each floor shall be zoned separately and]~~ a zone shall not exceed 22,500 square feet (~~[2090]~~ 2090.3 m²). The length of any zone shall not exceed 300 feet (91 440 mm) in any direction.

Exception: Automatic sprinkler system zones shall not exceed the area permitted by NFPA 13.

907.6.3.1 Zoning indicator panel. A zoning indicator panel and the associated controls shall be provided at the main building entrance accessible to responding Fire Department personnel and in other locations approved by the ~~[department]~~ commissioner and the Fire Department. The visual zone indication shall lock in until the system is reset and shall not be canceled by the operation of an audible-alarm silencing switch.

907.6.3.2 High-rise buildings. In high-rise buildings constructed in accordance with Section 403, a separate zone by floor shall be provided for each of the following types of alarm-initiating devices where provided:

1. Smoke detectors.
2. Sprinkler waterflow devices.
3. Manual fire alarm boxes.
4. Other approved types of automatic fire detection devices or suppression systems.

907.6.4 Access. Access shall be provided to each fire alarm device and notification appliance for periodic inspection, maintenance and testing.

907.6.5 Monitoring. Fire alarm systems required by this chapter or by the *New York City Fire Code* shall be monitored by a central supervising station in accordance with NFPA 72 and approved by the ~~[fire commissioner]~~ Fire Commissioner.

Exception: Monitoring by a central supervising station is not required for:

1. Single- and multiple-station smoke alarms required by Section 907.2.11.
2. Smoke detectors in Group I-3 occupancies.
3. Automatic sprinkler systems in one- and two-family dwellings.

907.6.5.1 Automatic telephone-dialing devices. Automatic telephone-dialing devices used to transmit an emergency alarm shall not be connected to any Fire Department telephone number unless approved by the Fire Commissioner.

907.6.5.2 Termination of monitoring service. Termination of fire alarm monitoring services shall be in accordance with the *New York City Fire Code*.

907.7 Acceptance tests and completion. Upon completion of the installation, the fire alarm system and all fire alarm components shall be tested in accordance with NFPA 72.

907.7.1 Single- and multiple-station alarm devices. When the installation of the alarm devices is complete, each device and interconnecting wiring for multiple-station alarm devices shall be tested in accordance with the smoke alarm provisions of NFPA 72.

907.7.2 Record of completion. A record of completion in accordance with NFPA 72 verifying that the system has been installed and tested in accordance with the approved construction documents and specifications shall be provided.

907.7.3 Instructions. Operating, testing and maintenance instructions, and record drawings (“as built”) and equipment specifications shall be provided at an approved location.

907.8 Inspection, testing and maintenance. The maintenance and testing schedules and procedures for fire alarm and fire detection systems shall be in accordance with the *New York City Fire Code*.

SECTION BC 908 EMERGENCY ALARM SYSTEMS

908.1 Group H occupancies. Emergency alarms for the detection and notification of an emergency condition in Group H occupancies shall be provided in accordance with Section [414.7] 415.5 of this code and the *New York City Fire Code*.

908.2 Group H-5 occupancy. Emergency alarms for notification of an emergency condition in [am] a Hazardous Production Material (HPM) facility shall be provided as required in Section [415.8.4.6] 415.11.3.5. A continuous gas[-]detection system shall be provided for HPM gases in accordance with Section [415.8.7] 415.11.7 of this code and the *New York City Fire Code*.

908.3 Highly toxic and toxic materials. A gas detection system shall be provided to detect the presence of highly toxic or toxic gas at or below the permissible exposure limit (PEL) or ceiling limit of the gas for which detection is provided. The system shall be capable of monitoring the discharge from the treatment system at or below one-half the immediately dangerous to life and health (IDLH) limit and shall comply with the *New York City Fire Code*.

Exception: A gas detection system is not required for toxic gases when the physiological warning threshold level for the gas is at a level below the accepted PEL for the gas.

908.3.1 Alarms. The gas detection system shall initiate a local alarm and transmit a signal to a constantly attended control station when a short-term hazard condition is detected. The alarm shall be both visible and audible and shall provide warning both inside and outside the area where gas is detected. The audible alarm shall be distinct from all other alarms.

Exception: Signal transmission to a constantly attended control station is not required when not more than one cylinder of highly toxic or toxic gas is stored.

908.3.2 Shutoff of gas supply. The gas detection system shall automatically close the shutoff valve at the source on gas supply piping and tubing related to the system being monitored for whichever gas is detected.

Exception: Automatic shutdown is not required for reactors utilized for the production of highly toxic or toxic compressed gases where such reactors are:

1. Operated at pressures less than 15 pounds per square inch gauge (psig) (103.4 kPa)[-];
2. Constantly attended[-]; and
3. Provided with readily accessible emergency shutoff valves.

908.3.3 Valve closure. The automatic closure of shutoff valves shall be in accordance with the following:

1. When the gas-detection sampling point initiating the gas detection system alarm is within a gas cabinet or exhausted enclosure, the shutoff valve in the gas cabinet or exhausted enclosure for the specific gas detected shall automatically close.
2. Where the gas-detection sampling point initiating the gas detection system alarm is within a gas room and compressed gas containers are not in gas cabinets or exhausted enclosures, the shutoff valves on all gas lines for the specific gas detected shall automatically close.
3. Where the gas-detection sampling point initiating the gas detection system alarm is within a piping distribution manifold enclosure, the shutoff valve for the compressed container of specific gas detected supplying the manifold shall automatically close.

Exception: When the gas-detection sampling point initiating the gas detection system alarm is at a use location or within a gas valve enclosure of a branch line downstream of a piping distribution manifold, the shutoff valve in the gas valve enclosure for the branch line located in the piping distribution manifold enclosure shall automatically close.

908.4 Ozone gas-generator rooms. Ozone gas-generator rooms shall be equipped with a continuous gas[-]detection system that will shut off the generator and sound a local alarm when concentrations above the PEL occur and shall comply with the *New York City Fire Code*.

908.5 Repair garages. A flammable-gas detection system shall be provided in repair garages for vehicles fueled by enumerated gases in accordance with Section [~~406.6.6~~] 406.8.5 of this code and the *New York City Fire Code*.

908.6 Refrigerant [~~detector~~] detectors. Machinery rooms shall contain [~~a~~] refrigerant [~~detector~~] detectors with [~~an~~] audible and visual [~~alarm~~] alarms. The [~~detector~~] detectors, or [~~a~~] sampling [~~tube~~] tubes that [~~draws~~] draw air to [~~the~~] each detector, shall be located in [~~an~~] all [~~area~~] areas where refrigerant from a leak will concentrate. The alarm shall be actuated at a value not greater than the corresponding TLV-TWA values for the refrigerant classification indicated in the *New York City Mechanical Code*. Detectors and alarms shall be placed in approved locations. Refrigerant detectors shall initiate all functions as required by the *New York City Mechanical Code* and *New York City Fire Code*.

~~**908.7 Carbon monoxide alarms and detectors.** Carbon monoxide alarms and detectors shall be provided and installed in accordance with Sections 908.7.1 through 908.7.4.]~~

~~[908.7.1 Group I-1 and R occupancies. Listed carbon monoxide alarms or detectors shall be installed as follows:]~~

~~[1. Group R-1 and Group R-2 where the main use or dominant occupancy of a building is classified as Group R-2 student apartments. Carbon monoxide detectors and audible notification appliances shall be installed in affected dwelling units as per Section 908.7.1.1 and shall be annunciated by dwelling unit at a constantly attended location from which the fire alarm system is capable of being manually activated.]~~

~~[2. Groups I-1, R-2 (other than occupancies covered by Item 1) and R-3. Carbon monoxide alarms shall be installed in affected dwelling units as per Section 908.7.1.1.]~~

~~[908.7.1.1 Affected dwelling units. Carbon monoxide alarms or detectors shall be required within the following dwelling units:]~~

~~[1. Units on the same story where carbon monoxide producing equipment or enclosed parking is located.]~~

~~[2. Units on the stories immediately above and below the floor where carbon monoxide producing equipment or enclosed parking is located.]~~

~~[3. Units in a building containing a carbon monoxide producing furnace, boiler, or water heater as part of a central system.]~~

~~[4. Units in a building served by a carbon monoxide producing furnace, boiler, or water heater as part of a central system that is located in an adjoining or attached building.]~~

~~[908.7.1.1.1 Required locations within dwelling units. Carbon monoxide alarms or detectors shall be located within dwelling units as follows:]~~

~~[1. Outside of any room used for sleeping purposes, within 15 feet (4572 mm) of the entrance to such room.]~~

~~[2. In any room used for sleeping purposes.]~~

~~[3. On any story within a dwelling unit, including below grade stories and penthouses of any area, but not including crawl spaces and uninhabitable attics.]~~

~~[908.7.1.1.2 Installation requirements. Carbon monoxide alarms or detectors shall comply with the power source, interconnection, and acceptance testing requirements as required for smoke alarms in accordance with Sections 907.2.11.2 through 907.2.11.3.]~~

~~[908.7.1.1.3 Exhaust of Carbon Monoxide in Group R-3 Occupancy (One and Two-Family dwellings and townhouses). Means of exhausting carbon monoxide from garages shall be provided when a carbon monoxide alarm or detector is activated in a Group R-3 occupancy, provided such garage is attached within the Group R-3 occupancy. Such exhaust system shall be arranged to operate automatically upon detection of a concentration of carbon monoxide of 35 parts per million (ppm) or greater by approved automatic detection device. The system shall be capable of producing an exhaust rate of~~

~~1.5 cfm per square foot of floor area of the garage. Removal of sensor, interruption of power or cut wires shall cause the relay circuit to open and start fan. The relay contact shall close and the fan may shut off when the carbon monoxide level is below 35 ppm. Carbon monoxide exhausting means shall be connected to a separate circuit and provided with a lock and identified at the power source. Such circuit shall not be connected to a power source through an arc fault or Ground Fault Circuit Interrupter (GFCI) devices. Additionally, when the carbon monoxide exhausting means is connected to the plug-in type overcurrent protection device, such device shall be secured in place by an additional fastener.]~~

~~**[908.7.2 Group E, I-2 and I-4 occupancies.** Listed carbon monoxide detectors with built-in sounder bases shall be transmit a signal to a central supervising station and shall be permitted to initiate an audible and visual supervisory alarm at a constantly attended location.]~~

~~[1. Carbon monoxide detectors with built-in sounder bases shall be installed within any room containing carbon monoxide producing equipment.]~~

~~**Exception:** Kitchens or laboratories.]~~

~~[2. Carbon monoxide detectors with built-in sounder bases shall be installed in corridors on the story where carbon monoxide producing equipment unit is located, as well as one story above and one story below.]~~

~~[3. Carbon monoxide detectors with built-in sounder bases shall be installed in all corridors on the story where enclosed parking is located, as well as one story above and one story below.]~~

~~**[908.7.3 Buildings that are equipped with a fire alarm system and that contain Group A-1, A-2, A-3, Group B or Group M occupancies.** Listed carbon monoxide detectors shall be installed in buildings that are equipped with a fire alarm system and that contain Group A-1, A-2 or A-3, Group B or Group M occupancies. Such carbon monoxide detectors installed pursuant to this section shall have built-in sounder bases, shall transmit a signal to a central supervising station and shall be permitted to initiate an audible and visual supervisory alarm at a constantly attended location. The department shall adopt rules and/or reference standards (i) governing the installation and location of carbon monoxide detectors provided such detectors shall be required within rooms containing carbon monoxide producing equipment and (ii) addressing the installation of such detectors or any alternative means of compliance in existing buildings.]~~

~~**[Exception:** Carbon monoxide detectors shall not be required in kitchens.]~~

~~**[908.7.3.1 Retroactive provisions for existing buildings.** Notwithstanding any other provision of law, listed carbon monoxide detectors shall be installed in existing buildings that are equipped with a fire alarm system and that contain group A-1, A-2, A-3, Group B or Group M occupancies in accordance with Section 908.7.3 by January 1, 2021.]~~

~~**[908.7.4 Installation.** Carbon monoxide alarms and detectors shall be listed in accordance with UL 2034 and UL 2075.]~~

908.7 Carbon dioxide (CO₂) systems. The emergency alarm system for a carbon dioxide system, including detection, pre-discharge and discharge alarms, shall be provided in accordance with the New York City Fire Code.

908.8 Gas detection systems. Gas detection systems shall be provided in accordance with Section 918.

~~[908.8]~~ **908.9 Medical gas.** Medical gas pressure monitoring and alarm systems shall be provided in accordance with NFPA 99~~[and NFPA 99C]~~.

~~[908.9]~~ **908.10 Flammable gas.** Rooms and spaces containing flammable gas distribution piping operating at levels above 15 pounds per square inch gauge (psig) (103.4 kPa) shall be provided with an approved flammable gas detection-alarm system and shall comply with the New York City Fire Code.

~~[908.10]~~ **908.11 Construction documents.** Construction documents for emergency alarm systems shall be submitted for review and approval to the Fire Department prior to system installation.

~~[908.11]~~ **908.12 Acceptance testing and maintenance.** Acceptance testing and maintenance of emergency alarm systems shall be performed in accordance with the *New York City Fire Code*.

SECTION BC 909 SMOKE CONTROL SYSTEMS

909.1 Scope and purpose. This section applies to mechanical or passive smoke control systems ~~[when] where~~ they are required by other provisions of this code. A smoke control system ~~[is a life safety system, and]~~, where required, facilitates the evacuation of the occupants. The purpose of this section is to establish minimum requirements for the design, installation and acceptance testing of smoke control systems that are intended to provide a tenable environment for the evacuation or relocation of occupants. These provisions are not intended for the preservation of contents, the timely restoration of operations or for assistance in fire suppression or post-fire smoke purge. Smoke control systems regulated by this section serve a different purpose than the smoke- and heat-venting provisions found in Section 910. Mechanical smoke control systems shall not be considered exhaust systems under Chapter 5 of the *New York City Mechanical Code*.

909.1.1 Definitions. The following ~~[words and]~~ terms ~~[shall, for the purposes of this section and as used elsewhere in this code, have the meaning shown herein.]~~ are defined in Chapter 2 of this code:

ELEVATOR LANDING.

PRESSURIZATION. ~~[Creation and maintenance of pressure levels in zones of a building, including elevator shafts and stairwells, that are higher than the pressure level at the smoke source, such pressure levels being produced by positive pressures of a supply of uncontaminated air; by exhausting air and smoke at the smoke source; or by a combination of these methods.]~~

SMOKE. [~~Air borne solid and liquid particulates and gases evolved when a material undergoes pyrolysis or combustion, including the quality of air that is entrained or otherwise mixed into the mass.~~]

SMOKE BARRIER. [~~See Section 702.1.~~]

SMOKE CONTROL MODE. [~~A predefined operational configuration of a system or device for the purpose of smoke control.~~]

SMOKE CONTROL SYSTEM, MECHANICAL. [~~An engineered system that uses mechanical fans to produce pressure differences across smoke barriers or that establishes airflows to limit and direct smoke movement.~~]

SMOKE CONTROL SYSTEM, PASSIVE. [~~A system of smoke barriers arranged to limit the migration of smoke.~~]

SMOKE CONTROL ZONE. [~~A space within a building enclosed by smoke barriers.~~]

SMOKE DAMPER. [~~See Section 702.1.~~]

STACK EFFECT. [~~Vertical airflow within buildings caused by temperature differences.~~]

TENABLE ENVIRONMENT. [~~An environment in which the concentration and location of smoke is limited or otherwise restricted to allow for ready evacuation through the space.~~]

909.2 General design requirements. Buildings, structures or parts thereof required by this code to have a smoke control system or systems shall have such systems designed in accordance with the applicable requirements of Section 909 and the generally accepted and well-established principles of engineering relevant to the design. The construction documents shall include sufficient information and detail to adequately describe the elements of the design necessary for the proper implementation of the smoke control systems. These documents shall be accompanied by sufficient information and analysis to demonstrate compliance with these provisions.

909.3 Special inspection and test requirements. In addition to the ordinary inspection and test requirements that buildings, structures and parts thereof are required to undergo, smoke control systems subject to the provisions of Section 909 shall undergo special inspections and tests sufficient to verify the proper commissioning of the smoke control design in its final installed condition. The design submission accompanying the construction documents shall clearly detail procedures and methods to be used and the devices, flow measurement, and other items subject to such inspections and tests. Such commissioning shall be in accordance with generally accepted engineering practice and, where possible, based on published standards for the particular testing involved. The special inspections and tests required by this section shall be conducted under the same terms in Section [1704] 1705. [~~A record~~] Records of the special inspection, including device locations, duct air leakage, pressure [differences,] differentials, air/smoke flow measurements, smoke detection and control verification shall be maintained on the premises as a baseline against which future tests can be compared.

909.3.1 Periodic testing. Smoke control systems shall be verified weekly through the automatic control system in accordance with Section 909.12 and shall be tested annually to ensure proper operation of detection devices, dampers, fans and controls in accordance with the requirements of Sections 909.18.1, 909.18.3, 909.18.5 and 909.18.7. Full testing of smoke control systems in accordance with Sections 909.18 through 909.18.7 shall be conducted at 5-year intervals by an inspector qualified in accordance with Section 909.18.8.2. Test reports shall include all information required by Section 909.18.8.3 and shall be compared against the baseline special inspection report. Causes for any significant deviations from the baseline report shall be identified and corrected. A record of each inspection and test shall be maintained on the premises by the owner or lessee, and the records for at least the last 5 years of operation shall be made available for inspection by the department and the ~~[fire commissioner]~~ Fire Commissioner.

909.4 Analysis. A rational analysis supporting the types of smoke control systems to be employed, their methods of operation, the systems supporting them and the methods of construction to be utilized shall accompany the submitted construction documents and shall include, but not be limited to, the items indicated in Sections 909.4.1 through ~~[909.4.6]~~ 909.4.7. The basis of design and design analysis of the smoke control system shall be submitted to the department and the Fire Department.

909.4.1 Stack effect. The system shall be designed such that the maximum probable normal or reverse stack effect will not adversely interfere with the system's capabilities. In determining the maximum probable stack effect, altitude, elevation, weather history and interior temperatures shall be used.

909.4.2 Temperature effect of fire. Buoyancy and expansion caused by the design fire in accordance with Section 909.9 shall be analyzed. The system shall be designed such that these effects do not adversely interfere with the system's capabilities.

909.4.3 Wind effect. The design shall consider the adverse effects of wind. Such consideration shall be consistent with the wind-loading provisions of Chapter 16.

909.4.4 HVAC systems. The design shall consider the effects of the heating, ventilating and air-conditioning (HVAC) systems on both smoke and fire transport. The analysis shall include all permutations of systems' status. The design shall consider the effects of the fire on the HVAC systems.

909.4.5 Climate. The design shall consider the effects of low temperatures on systems, property and occupants. Air inlets and exhausts shall be located so as to prevent snow or ice blockage.

909.4.6 Duration of operation. All portions of active or passive smoke control systems shall be capable of continued operation after detection of the fire event for a period of not less than either 20 minutes or 1.5 times the ~~[calculated]~~ required safe egress time, whichever is ~~[more]~~ greater.

909.4.7 Smoke control system interaction. The design shall consider the interaction effects of the operation of multiple smoke control systems for all design scenarios.

909.5 Smoke barrier construction. Smoke barriers required for passive smoke control and a smoke control system using the pressurization method shall comply with Section ~~[710, and]~~ 709. Smoke barriers shall be constructed and sealed to limit leakage areas exclusive of protected openings. The

maximum allowable leakage area shall be the aggregate area calculated using the following leakage area ratios:

1. Walls: $A/A_w = 0.00100$
2. ~~[Exit enclosures]~~ Interior exit stairways and ramps and exit passageways:
 $A/A_w = 0.00035$
3. ~~[All]~~ Enclosed exit access stairways and ramps and all other shafts:
 $A/A_w = 0.00150$
4. Floors and roofs: $A/A_F = 0.00050$

where:

A = ~~[Total]~~ Maximum allowable leakage area, square feet (m^2).

A_F = Unit floor or roof area of barrier, square feet (m^2).

A_w = Unit wall area of barrier, square feet (m^2).

The leakage area ratios shown do not include openings due to gaps around doors and operable windows ~~[or similar gaps. These]~~ The total leakage area of the smoke barrier shall be included in calculating the total leakage area determined in accordance with Section 909.5.1 and tested in accordance with Section 909.5.2.

909.5.1 ~~[Leakage]~~ Total leakage area. ~~[The total]~~ Total leakage area of the barrier is the product of the smoke barrier gross area multiplied by the allowable leakage area ratio, plus the area of other openings such as gaps around doors and operable windows. ~~[Compliance shall be determined by achieving the minimum air pressure difference across the barrier with the system in the smoke control mode for mechanical smoke control systems. Passive smoke control systems tested using other approved means such as door fan testing shall be approved by the department and the fire commissioner.]~~

909.5.2 ~~[Opening protection.]~~ Testing of leakage area. Compliance with the maximum allowable leakage area shall be determined by achieving the minimum air pressure difference across the barrier with the system in the smoke control mode for mechanical smoke control systems utilizing the pressurization method. Compliance with the maximum allowable leakage area of passive smoke control systems shall be verified through methods such as door fan testing or other methods, as approved by the commissioner and the Fire Commissioner.

909.5.3 Opening protection. Openings in smoke barriers shall be protected by automatic-closing devices actuated by the required controls for the mechanical smoke control system. Door openings shall be protected by fire door assemblies complying with Section [715.4.3] 716.5.3.

Exceptions:

1. Passive smoke control systems with automatic-closing devices actuated by spot-type smoke detectors listed for releasing service installed in accordance with Section 907.3.
2. Fixed openings between smoke zones that are protected utilizing the airflow method.
3. In Group I-1, Group I-2, and Group B ambulatory care facilities, where ~~[such doors are installed across corridors,]~~ a pair of opposite-swinging doors ~~[without a center mullion shall be installed having vision panels with approved fire protection-rated glazing materials in approved fire protection-rated frames]~~ are installed across a corridor in accordance with Section 909.5.3.1, the ~~[area of which]~~ doors shall not ~~[exceed that tested]~~ be required to be protected in accordance with Section 716. The doors shall be ~~[close fitting]~~ close-fitting within operational tolerances and shall not have a center mullion, louvers, grilles, or door undercuts~~[-louvers or grilles]~~ in excess of ¾ inch (19.1 mm). The doors shall have head and jamb stops~~[-]~~ and astragals or rabbets at meeting edges ~~[-and shall be automatic closing by smoke detection in accordance with Section 715.4.8.3. Positive latching devices are not required].~~ If allowed by the door manufacturer's listing, positive-latching devices are not required.
4. In Group I-1, Group I-2 and Group B ambulatory care facilities, where such doors are special-purpose horizontal sliding, accordion or folding door assemblies installed in accordance with Section 1010.1.4.3 and are automatic closing by smoke detection in accordance with Section 716.5.9.3.

~~[4:]~~ 5. Group I-3.

~~[5:]~~ 6. _____ Openings between smoke zones with clear ceiling heights of 14 feet (4267 mm) or greater and bank-down capacity of greater than 20 minutes as determined by the design fire size.

909.5.3.1 Group I-2 and Group B ambulatory care facilities. In Group I-2 and Group B ambulatory care facilities, where doors are installed across a corridor, the doors shall be automatic closing by smoke detection in accordance with Section 716.5.9.3 and shall have a vision panel with fire protection-rated glazing materials in fire protection-rated frames, the area of which shall not exceed that tested.

~~[909.5.2.1]~~ **909.5.3.2 Ducts and air transfer openings.** Ducts and air transfer openings are required to be protected with a minimum Class II, 250°F (~~[+24]~~ 121.1°C) smoke damper complying with Section ~~[716]~~ 717.

909.6 Pressurization method. The primary mechanical means of controlling smoke shall be by pressure differences across smoke barriers. Maintenance of a tenable environment is not required in the smoke control zone of fire origin.

909.6.1 Minimum pressure difference. The minimum pressure difference across a smoke barrier shall be 0.05-inch water ~~[gage]~~ gauge (0.0124 kPa) in fully sprinklered buildings. In buildings permitted to be other than fully sprinklered, the smoke control system shall be designed to achieve pressure differences ~~[at least]~~ not less than two times the maximum calculated pressure difference produced by the design fire ~~[-but in no case less than the values indicated in Table 909.6.1:]~~.

[TABLE 909.6.1]
[MINIMUM PRESSURE DIFFERENCES]
[ACROSS SMOKE BARRIERS]

[CEILING HEIGHT]	[MINIMUM DESIGN PRESSURE DIFFERENCE]
[Less than 15 feet (4572 mm)]	[0.10 inch water gage (0.0259 kPa)]
[Equal to or greater than 15 feet (4572 mm), but less than 21 feet (6401 mm)]	[0.14 inch water gage (0.0349 kPa)]
[Equal to or greater than 21 feet (6401 mm)]	[0.18 inch water gage (0.0448 kPa)]

909.6.2 Maximum pressure difference. The maximum air pressure difference across a smoke barrier shall be determined by required door-opening or closing forces. The actual force required to open exit doors when the system is in the smoke control mode shall be in accordance with Section [1008.1.3] 1010.1.3. Opening and closing forces for other doors shall be determined by standard engineering methods for the resolution of forces and reactions. The calculated force to set a side-hinged, swinging door in motion shall be determined by:

$$F = F_{dc} + K(WA\Delta P)/2(W - d) \quad \text{(Equation 9-1)}$$

where:

- A = Door area, square feet (m²).
- d = Distance from door handle to latch edge of door, feet (m).
- F = Total door opening force, pounds (N).
- F_{dc} = Force required to overcome closing device, pounds (N).
- K = Coefficient 5.2 (1.0).
- W = Door width, feet (m).
- ΔP = Design pressure difference, inches of water (Pa).

909.6.3 Pressurized stairways and elevator hoistways. Where stairways or elevator hoistways are pressurized, such pressurization systems shall comply with Section 909 of this code as smoke control systems, in addition to the requirements of Sections 909.20 and 909.21 of this code and the *New York City Fire Code*.

909.7 Air flow design method. ~~[When]~~ Where approved by the ~~[department]~~ commissioner, smoke migration through openings fixed in a permanently open position, which are located between smoke control zones by the use of the airflow method, shall be permitted. The design air flow shall be in accordance with this section. Air flow shall be directed to limit smoke migration from the fire zone.

The geometry of openings shall be considered to prevent flow reversal from turbulent effects. Smoke control systems using the airflow method shall be designed in accordance with NFPA 92.

909.7.1 [Velocity. The minimum average velocity through a fixed opening shall not be less than:]

$$[v = 217.2[h(T_f - T_o)/(T_f + 460)]^{1/2} \text{ (Equation 9-2)}]$$

$$[\text{For SI: } v = 119.9[h(T_f - T_o)/T_f]^{1/2}]$$

[where:]

[h = Height of opening, feet (m).]

[T_f = Temperature of smoke, °F (°K).]

[T_o = Temperature of ambient air, °F (°K).]

[v = Air velocity, feet per minute (m/minute).]

[909.7.2] Prohibited conditions. This method shall not be employed where either the quantity of air or the velocity of the airflow will adversely affect other portions of the smoke control system, unduly intensify the fire, disrupt plume dynamics or interfere with exiting. In no case shall airflow toward the fire exceed 200 feet per minute (1.02 m/s). Where the [formula in Section 909.7.1 requires] calculated airflow [~~to exceed~~] exceeds this limit, the airflow method shall not be used.

909.8 Exhaust method. [~~When~~] Where approved by the [~~department~~] commissioner, mechanical smoke control for large enclosed volumes, such as in atriums or malls, shall be permitted to utilize the exhaust method. [~~The design~~] Smoke control systems using the exhaust [~~volumes~~] method shall be designed in accordance with NFPA [~~92B~~] 92.

909.8.1 Smoke layer. The height of the lowest horizontal surface of the accumulating smoke layer shall be maintained [~~at least~~] not less than 6 feet ([~~1829~~] 1828.8 mm) above any walking surface that forms a portion of a required egress system within the smoke zone.

909.9 Design fire. The design fire shall be based on a [~~Q of not less than 5,000 Btu/s (5275 kW)~~] unless a rational analysis performed by the registered design professional and approved by the [~~department~~] commissioner. The design fire shall be based on the analysis in accordance with Section 909.4 and this section.

909.9.1 Factors considered. The engineering analysis shall include the characteristics of the fuel, fuel load, effects included by the fire and whether the fire is likely to be steady or unsteady.

909.9.2 [~~Separation distance.~~] Design fire fuel. Determination of the design fire shall include consideration of the type of fuel, fuel spacing and configuration.

909.9.3 Heat-release assumptions. The analysis shall make use of best available data from approved sources and shall not be based on excessively stringent limitations of combustible material.

909.9.4 Sprinkler effectiveness assumptions. A documented engineering analysis shall be provided for conditions that assume fire growth is halted at the time of sprinkler activation.

909.10 Equipment. Equipment including, but not limited to, fans, ducts, automatic dampers and balance dampers, shall be suitable for its intended use, suitable for the probable exposure temperatures that the rational analysis indicates[;] and as approved by the [department] commissioner.

909.10.1 Exhaust fans. Components of exhaust fans shall be rated and certified by the manufacturer for the probable temperature rise to which the components will be exposed. This temperature rise shall be computed [by:] in accordance with NFPA 92.

~~[Exception: Reduced T_s as calculated based on the assurance of adequate dilution air.]~~

$$[T_s = (Q_e/mc) + (T_a)] \quad \text{[(Equation 9-3)]}$$

[where:]

~~[c = Specific heat of smoke at smoke layer temperature, Btu/lb°F (kJ/kg • K).]~~

~~[m = Exhaust rate, pounds per second (kg/s).]~~

~~[Q_e = Convective heat output of fire, Btu/s (kW).]~~

~~[T_a = Ambient temperature, °F (°K).]~~

~~[T_s = Smoke temperature, °F (°K).]~~

909.10.2 Ducts. Duct materials and joints shall be capable of withstanding the probable temperatures and pressures to which they are exposed as determined in accordance with Section 909.10.1. Ducts shall be constructed and supported in accordance with the *New York City Mechanical Code*. Ducts shall be leak tested to 1.5 times the maximum design pressure in accordance with nationally accepted practices. Measured leakage shall not exceed 5 percent of design flow. Results of such testing shall be a part of the documentation procedure. Ducts shall be supported directly from fire-resistance-rated structural elements of the building by substantial, noncombustible supports.

Exception: Flexible connections, [{} for the purpose of vibration isolation{}], complying with the *New York City Mechanical Code*[;] and that are constructed of approved fire-resistance-rated materials.

909.10.3 Equipment, inlets and outlets. Equipment shall be located so as not to expose uninvolved portions of the building to an additional fire hazard. Outside air inlets shall be located so as to minimize the potential for introducing smoke or flame into the building. Exhaust outlets shall be located so as to minimize reintroduction of smoke into the building and to limit exposure of the building or adjacent buildings to an additional fire hazard.

909.10.4 Automatic dampers. Automatic dampers, regardless of the purpose for which they are installed within the smoke control system, shall [~~be listed for their use~~] comply with Section 717.3.1.

909.10.5 Fans. In addition to other requirements, belt-driven fans shall have 1.5 times the number of belts required for the design duty[~~, but not less than~~] with the minimum number of belts being

two. Fans shall be selected for stable performance based on normal temperature and, where applicable, elevated temperature. Calculations and manufacturer's fan curves shall be part of the documentation procedures. Fans shall be supported and restrained by noncombustible devices in accordance with the requirements of Chapter 16. Motors driving fans shall not be operated beyond their nameplate horsepower (kilowatts), as determined from measurement of actual current draw, and shall have a minimum service factor of 1.15.

909.10.6 Seismic Requirements. Smoke control systems covered by Section 909 [~~are life safety systems and~~] are required to function after an earthquake. Such smoke control systems shall be seismically designed in accordance with Section 1613 of this code and ASCE 7 [-40]. The component importance factor, I_p , shall be taken as 1.5 in accordance with ASCE 7 [-40], Section 13.1.3. The smoke control system includes all components required for its operation, including but not limited to fans, ducts, electrical power, switchboards, motor control centers, starters, and controls.

Exception: Smoke control systems in structures classified in Seismic Design Categories A or B shall have a component importance factor, I_p , of 1.0.

909.11 [~~Power systems~~] Standby power. The smoke control system shall be supplied with two sources of power. [~~Primary power~~] The primary power supply shall be from the normal building power systems [-Secondary power], while the secondary power source shall be from a standby [source] power system complying with Section [2702.4] 2702.

909.11.1 Equipment room. The standby power source shall be located in a room separate from the normal power transformers and switch gears, and ventilated directly to and from the exterior. The room shall be enclosed with not less than 2-hour fire barriers constructed in accordance with Section 707, or with not less than 2-hour fire-resistance-rated horizontal assemblies constructed in accordance with Section 711, or both.

909.11.2 Power sources and power surges. Elements of the smoke [~~management~~] control system relying on electronic volatile memories or similar systems shall be supplied with uninterruptable power sources of sufficient duration to span a 15-minute primary power interruption. Elements of the smoke [~~management~~] control system susceptible to power surges shall be suitably protected by conditioners, suppressors or other approved means.

909.12 Detection and control systems. Fire detection systems providing control input or output signals to mechanical smoke control systems or elements thereof shall comply with the requirements of Section 907. Such systems shall be equipped with a control unit complying with UL 864 and listed as smoke control equipment.

909.12.1 Verification. Control systems for mechanical smoke control systems shall include provisions for verification. Verification shall include positive confirmation of actuation, testing, manual override[;] and the presence of power downstream of all disconnects [and, through a]. A preprogrammed weekly test sequence shall report, abnormal conditions audibly, visually and by printed report. The preprogrammed weekly test shall operate all devices, equipment and components used for smoke control.

Exception: Where verification of individual components tested through the preprogrammed weekly testing sequence will interfere with, and produce unwanted effects to, normal building operation, such individual components are permitted to be bypassed from the preprogrammed weekly testing, where approved by the Fire Department and in accordance with both of the following:

1. Where the operation of components is bypassed from the preprogrammed weekly test, presence of power downstream of all disconnects shall be verified weekly by a listed control unit.
2. Testing of all components bypassed from the preprogrammed weekly test shall be tested semi-annually, and be tested under standby power conditions in accordance with Section 909 of the *New York City Fire Code*.

[909.12.1] 909.12.2 Wiring. In addition to meeting requirements of the *New York City Electrical Code*, all wiring, regardless of voltage, shall be fully enclosed within continuous raceways.

[909.12.2] 909.12.3 Activation. Smoke control systems shall be activated in accordance with this section.

[909.12.2.1] 909.12.3.1 Pressurization, airflow or exhaust method. Mechanical smoke control systems using the pressurization, airflow or exhaust method shall have completely automatic control.

[909.12.2.2] 909.12.3.2 Passive method. Passive smoke control systems actuated by spot-type detectors listed for releasing service shall be permitted.

[909.12.3] 909.12.4 Automatic control. Where completely automatic control is required or used, the automatic-control sequences shall be initiated from an appropriately zoned automatic sprinkler system complying with Section 903.3.1.1, manual controls that are readily accessible to the Fire Department and any smoke detectors required by engineering analysis. See Section 909.16 for manual control requirements.

[909.12.3.1] 909.12.4.1 Building Management System. Automatic and manual operation of the smoke control system may alternately be done through a Building Management System (BMS) that is approved by the Fire Department and meets the following requirements [~~and is approved by the Fire Department~~]:

1. The BMS system shall be listed for UL 864 UUKL Smoke Control.
2. The BMS Control Center shall be staffed 24 hours a day by operators trained in the building's smoke control systems and their operation. [~~In buildings where Fire Safety Directors are required, they shall operate the~~] The smoke control system shall be operated by a certificate of fitness holder where required by the *New York City Fire Code*.
3. The control room shall be 2-hour fire-resistance-rated construction.

4. BMS annunciation and additional control station locations shall be located in the fire command center in accordance with Section 909.16.

909.13 Control air tubing. Control air tubing shall be of sufficient size to meet the required response times. Tubing shall be flushed clean and dry prior to final connections and shall be adequately supported and protected from damage. Tubing passing through concrete or masonry shall be sleeved and protected from abrasion and electrolytic action.

909.13.1 Materials. Control air tubing shall be hard drawn copper, Type L, ACR in accordance with ASTM B 42, ASTM B 43, ASTM B 68, ASTM B 88, ASTM B 251 and ASTM B 280. Fittings shall be wrought copper or brass, solder type, in accordance with ASME B 16.18 or ASME B16.22. Changes in direction shall be made with appropriate tool bends. Brass compression-type fittings shall be used at final connection to devices; other joints shall be brazed using a BCuP-5 brazing alloy with solidus above 1,100°F ([593] 593.3°C) and liquids below 1,500°F ([816] 815.6°C). Brazing flux shall be used on copper-to-brass joints only.

Exception: Nonmetallic tubing used within control panels and at the final connection to devices [~~providing~~] provided all of the following conditions are met:

1. Tubing shall [~~be listed by an approved agency for flame and smoke characteristics~~] comply with the optical density, flame spread, and the listing & labeling requirements of Section 602.2.1.3 of the *New York City Mechanical Code*.
2. Tubing and connected devices shall be completely enclosed within a galvanized or paint-grade steel enclosure having a minimum thickness of 0.0296 inch (0.7534 mm) (No. 22 gage). Entry to the enclosure shall be by copper tubing with a protective grommet of neoprene or [~~teflon~~] Teflon or by suitable brass compression to male-barbed adapter.
3. Tubing shall be identified by appropriately documented coding.
4. Tubing shall be neatly tied and supported within the enclosure. Tubing bridging [~~cabinet~~] cabinets and [~~door~~] doors or moveable [~~device~~] devices shall be of sufficient length to avoid tension and excessive stress. Tubing shall be protected against abrasion. Tubing serving devices on doors shall be fastened along hinges.

909.13.2 Isolation from other functions. Control tubing serving other than smoke control functions shall be isolated by automatic isolation valves or shall be an independent system.

909.13.3 Testing. Control air tubing shall be tested at three times the operating pressure for not less than 30 minutes without any noticeable loss in gauge pressure prior to final connection to devices.

909.14 Marking and identification. The detection and control systems shall be clearly marked at all junctions, accesses and terminations.

909.15 Control diagrams. Identical control diagrams showing all devices in the system and identifying their location and function shall be maintained current and kept on file with the

department, the Fire Department and in the fire command center in a format and manner approved by the Fire Commissioner.

909.16 [Fire-fighter's] Firefighter's smoke control panel. A ~~[fire-fighter's]~~ firefighter's smoke control panel for Fire Department emergency response purposes only shall be provided and shall include manual control or override of automatic control for mechanical smoke control systems. The panel shall be located in a fire command center complying with Section 911 in high-rise buildings or buildings with smoke-protected assembly seating. In all other buildings, the ~~[fire-fighter's]~~ firefighter's smoke control panel shall be installed in the ground floor lobby of the building, adjacent to the fire alarm control panel or remote annunciator, or in another approved location. The firefighter's smoke control panel shall either be a separate panel or can be integrated with a UUKL listed fire alarm control panel. The ~~[fire-fighter's]~~ firefighter's smoke control panel shall comply with Sections 909.16.1 through 909.16.3 [~~, and NFPA 72 Annex E, Fire Service Annunciator and Interface~~]. Where required in Section ~~[916]~~ 917, the post-fire smoke purge system shall be manually activated from the ~~[fire-fighter's]~~ firefighter's control panel or an adjacent panel.

909.16.1 Panel indicators. Fans within the building shall be shown on the ~~[fire-fighter's]~~ firefighter's control panel. A clear indication of the direction of airflow and the relationship of components shall be displayed. Status indicators shall be provided for all smoke control equipment, annunciated by fan and zone, and by pilot-lamp-type indicators as follows:

1. Fans, dampers and other operating equipment in their normal status—WHITE.
2. Fans, dampers and other operating equipment in their ~~[off]~~ on or ~~[closed]~~ open status—~~[RED]~~ GREEN.
3. Fans, dampers and other operating equipment in ~~[their on or open]~~ a fault status—~~[GREEN]~~ YELLOW/AMBER.
4. Fans, dampers and other operating equipment in ~~[a fault]~~ their off or closed status—~~[YELLOW/AMBER]~~ RED.

The indicators shall be provided in the following order: WHITE, GREEN, YELLOW/AMBER then RED.

909.16.2 Panel controls. The ~~[fire-fighter's]~~ firefighter's control panel shall provide control capability over the complete ~~[smoke-control]~~ smoke control system equipment within the building as follows:

1. ON-AUTO-OFF control over each individual piece of operating smoke control equipment that can also be controlled from other sources within the building. This includes stairway pressurization fans; smoke exhaust fans; supply, return and exhaust fans; elevator shaft fans and other operating equipment used or intended for smoke control purposes.
2. OPEN-AUTO-CLOSE control over ~~[individual]~~ dampers relating to smoke control and that are also controlled from other sources within the building. Dampers are permitted to be controlled by individual damper or grouped by smoke zone.

3. ON-OFF or OPEN-CLOSE control over smoke control and other critical equipment associated with a fire or smoke emergency and that can only be controlled from the ~~[fire-fighter's]~~ firefighter's control panel. The ~~[fire-fighter's]~~ firefighter's control panel shall be configured as described in Section 911.

Exceptions:

1. ~~[Complex systems]~~ Systems, where approved by the commissioner and the Fire Department, where the controls and indicators are combined to control and indicate all elements of a single smoke zone as a unit.
2. ~~[Complex systems]~~ Systems, where approved by the commissioner and the Fire Department, where the control is accomplished by computer interface using approved, plain English commands.

909.16.3 Control action and priorities. The ~~[fire-fighter's]~~ firefighter's control panel actions shall be as follows:

1. ON-OFF~~[,]~~ and OPEN-CLOSE control actions shall have the highest priority of any control point within the building. Once issued from the ~~[fire-fighter's]~~ firefighter's control panel, ~~[no]~~ automatic or manual control from any other control point within the building shall not contradict the control action. Where automatic means are provided to interrupt normal, nonemergency equipment operation or produce a specific result to safeguard the building or equipment ~~[i.e.,]~~ including, but not limited to, duct freezestats, duct smoke detectors, high-temperature cutouts, temperature-actuated linkage and similar devices~~]~~, such means shall be capable of being overridden by the ~~[fire-fighter's]~~ firefighter's control panel. The last control action as indicated by each ~~[fire-fighter's]~~ firefighter's control panel switch position shall prevail. ~~[In no case shall control]~~ Control actions shall not require the smoke control system to assume more than one configuration at any one time.

Exception: Power disconnects required by the *New York City Electrical Code*.

2. Only the AUTO position of each three-position ~~[fire-fighter's]~~ firefighter's control panel switch shall allow automatic or manual control action from other control points within the building. The AUTO position shall be the NORMAL, nonemergency, building control position. Where a ~~[fire-fighter's]~~ firefighter's control panel is in the AUTO position, the actual status of the device (on, off, open, closed) shall continue to be indicated by the status indicator described ~~[above. When]~~ in Section 909.16.1. Where directed by an automatic signal to assume an emergency condition, the NORMAL position shall become the emergency condition for that device or group of devices within the zone. ~~[In no case shall control]~~ Control actions shall not require the smoke control system to assume more than one configuration at any one time.

909.17 System response time. Smoke-control system activation shall be initiated immediately after receipt of an appropriate automatic or manual activation command. Smoke control systems shall activate individual components (such as dampers and fans) in the sequence necessary to prevent physical damage to the fans, dampers, ducts and other equipment. For purposes of smoke control, the ~~[fire-fighter's]~~ firefighter's control panel response time shall be the same for automatic or manual

smoke control action initiated from any other building control point. The total response time, including that necessary for detection, shutdown of operating equipment and smoke control system startup, shall allow for full operational mode to be achieved before the conditions in the space exceed the design smoke condition. The system response time for each component and their sequential relationships shall be detailed in the required rational analysis and verification of their installed condition reported in the required final report.

909.18 Acceptance testing. Devices, equipment, components and sequences shall be individually tested. These tests, in addition to those required by other provisions of this code, shall consist of determination of function, sequence and, where applicable, capacity of their installed condition.

909.18.1 Detection devices. Smoke or fire detectors that are a part of a smoke control system shall be tested in accordance with Chapter 9 in their installed condition. [~~When~~] Where applicable, this testing shall include verification of airflow in both minimum and maximum conditions.

909.18.2 Ducts. Ducts that are part of a smoke control system shall be traversed using generally accepted practices to determine actual air quantities.

909.18.3 Dampers. Dampers shall be tested for function in their installed condition.

909.18.4 Inlets and outlets. Inlets and outlets shall be read using generally accepted practices to determine air quantities.

909.18.5 Fans. Fans shall be examined for correct rotation. Measurements of voltage, amperage, revolutions per minute (rpm) and belt tension shall be made.

909.18.6 Smoke barriers. Measurements using inclined manometers or other approved calibrated measuring devices shall be made of the pressure differences across smoke barriers. Such measurements shall be conducted for each possible smoke control condition.

909.18.7 Controls. Each smoke zone[;] equipped with an automatic-initiation device[;] shall be put into operation by the actuation of one such device. Each additional device within the zone shall be verified to cause the same sequence without requiring the operation of fan motors in order to prevent damage. Control sequences shall be verified throughout the system, including verification of override from the [~~fire-fighter's~~] firefighter's control panel and simulation of standby power conditions.

909.18.8 Special inspections for smoke control. Smoke control systems shall be tested by a special inspector in accordance with Chapter 17.

909.18.8.1 Scope of testing. Special inspections shall be conducted in accordance with the following:

1. During erection of ductwork and prior to concealment for the purposes of leakage testing and recording of device location.
2. Prior to occupancy and after sufficient completion for the purposes of pressure-difference testing, flow measurements, and detection and control verification.

909.18.8.2 Qualifications. Special inspectors for smoke control shall have a certification as air balancers and expertise in fire protection engineering or mechanical engineering.

909.18.8.3 Reports. A complete report of testing shall be prepared by the special inspector or approved agency. The report shall include identification of all devices by manufacturer, nameplate data, design values, measured values and identification tag or mark. The report shall be reviewed by the responsible engineer and, when satisfied that the design intent has been achieved, the engineer shall seal, sign and date the report.

909.18.8.3.1 Report filing. A copy of the final report and each inspection report shall be filed with the department and Fire Commissioner, and an identical copy shall be maintained in an approved location at the building.

909.18.9 Identification and documentation. Charts, drawings and other documents identifying and locating each component of the smoke control system, and describing its proper function and maintenance requirements, shall be maintained on file at the building as an attachment to the report required by Section 909.18.8.3. Devices shall have an approved identifying tag or mark on them consistent with the other required documentation and shall be dated indicating the last time they were successfully tested and by whom.

909.18.10 Reacceptance testing. The smoke control system shall require a reacceptance test after any modifications to the system or physical changes to the building that may affect system performance. Reacceptance testing shall be a retest of the entire system in accordance with Sections 909.18.1 through 909.18.9.

909.19 System acceptance. Buildings, or portions thereof, required by this code to comply with this section shall not be issued a certificate of occupancy until such time that the department determines that the provisions of this section have been fully satisfied and a written maintenance program is approved by the New York City Fire Department.

Exception: In buildings of phased construction, the department may issue a temporary certificate of occupancy provided that those portions of the building to be occupied meet the requirements of this section and that the remainder does not pose a significant hazard to the safety of the proposed occupants or adjacent buildings.

909.20 Smokeproof enclosures. Where required by Section [~~1022.9~~] 1023.11, a smoke proof enclosure shall be constructed in accordance with this section. Where access to the roof is required by the *New York City Fire Code*, such access shall be from the smoke proof enclosure where a smoke proof enclosure is required. Smokeproof enclosures shall consist of one of the following systems:

1. An enclosed interior exit stairway constructed in accordance with Section [~~1022.4~~] 1023 and accessed through an open exterior balcony.
2. An enclosed interior exit stairway constructed in accordance with Section [~~1022.4~~] 1023 and accessed through a naturally ventilated vestibule.
3. An enclosed interior exit stairway constructed in accordance with Section [~~1022.4~~] 1023 and accessed through a mechanically ventilated vestibule.

4. A pressurized interior exit stairway constructed in accordance with Section ~~[4022.4]~~ 1023.

909.20.1 Access. Access to the interior exit stairway or ramp shall be by way of a vestibule or an open exterior balcony, unless such stairway is pressurized in accordance with Section 909.20.5. The minimum dimension of the vestibule or open exterior balcony shall not be less than the required width of the corridor leading to the vestibule or open exterior balcony but shall not have a width of less than 44 inches (~~[448]~~ 1117.6 mm) and shall not have a length of less than 72 inches (~~[4829]~~ 1828.8 mm) in the direction of egress travel.

909.20.2 Construction. The smoke proof enclosure shall be separated from the remainder of the building by not less than 2-hour fire barriers constructed in accordance with Section 707 or horizontal assemblies constructed in accordance with Section ~~[712]~~ 711, or both. Openings are not permitted other than the required means of egress doors. The vestibule shall be separated from the stairway or ramp by not less than a 2-hour fire-resistance-rated fire barrier. The open exterior balcony shall be constructed in accordance with the fire-resistance-rating requirements for floor construction.

909.20.2.1 Door closers. Doors in a smoke proof enclosure shall be self- or automatic-closing by actuation of a smoke detector in accordance with Section ~~[715.4]~~ 716.5.9.3 and shall be installed at the floor-side entrance to the smoke proof enclosure ~~[in accordance with Section 715.4.8]~~. The actuation of the smoke detector on any door shall activate the closing devices on all doors in the smoke proof enclosure at all levels. Smoke detectors shall be installed in accordance with Section 907.3.

909.20.3 Natural ventilation alternative. The provisions of Sections 909.20.3.1 through 909.20.3.3 shall apply to ventilation of smoke proof enclosures by natural means.

909.20.3.1 Balcony doors. Where access to the stairway or ramp is by way of an open exterior balcony, the door assembly into the enclosure shall be a fire door assembly in accordance with Section ~~[715.4]~~ 716.5.

909.20.3.2 Vestibule doors. Where access to the stairway or ramp is by way of a vestibule, the door assembly into the vestibule shall be a fire door assembly complying with Section ~~[715.4]~~ 716.5. The door assembly from the vestibule to the stairway shall have not less than a 90-minute fire protection rating complying with Section ~~[715.4]~~ 716.5.

909.20.3.3 Vestibule ventilation. Each vestibule shall have a minimum net area of 16 square feet (1.5 m²) of opening in a wall facing an outer court, yard or public way that is ~~[at least]~~ not less than 20 feet (6096 mm) in width.

909.20.4 Mechanical ventilation alternative. The provisions of Sections 909.20.4.1 through ~~[909.20.4.4]~~ 909.20.4.5 shall apply to ventilation of smoke proof enclosures by mechanical means.

909.20.4.1 Vestibule doors. The door assembly from the building into the vestibule shall be a fire door assembly complying with Section ~~[715.4.3]~~ 716.5.3. The door assembly from the vestibule to the stairway or ramp shall not have ~~[not]~~ less than a 90-minute fire protection

rating and shall meet the requirements for a smoke door assembly in accordance with Section [715.4.3] 716.5.3. The door shall be installed in accordance with NFPA 105.

909.20.4.2 Vestibule ventilation. The vestibule shall be supplied with not less than one air change per minute and the exhaust shall not be less than 150 percent of supply. Supply air shall enter and exhaust air shall discharge from the vestibule through separate, tightly constructed ducts used only for that purpose. Supply air shall enter the vestibule within 6 inches ([452] 152.4 mm) of the floor level. The top of the exhaust register shall be located at the top of the smoke trap but not more than 6 inches ([452] 152.4 mm) down from the top of the trap, and shall be entirely within the smoke trap area. Doors in the open position shall not obstruct duct openings. Duct openings with controlling dampers are permitted where necessary to meet the design requirements, but dampers are not otherwise required.

909.20.4.2.1 Engineered ventilation system. Where a specially engineered system is used, the system shall exhaust a quantity of air equal to not less than 90 air changes per hour from any vestibule in the emergency operation mode and shall be sized to handle three vestibules simultaneously. Smoke detectors shall be located at the floor-side entrance to each vestibule and shall activate the system for the affected vestibule. Smoke detectors shall be installed in accordance with Section 907.3.

909.20.4.3 Smoke trap. The vestibule ceiling shall [~~be at least~~] not be less than 20 inches (508 mm) higher than the door opening into the vestibule to serve as a smoke and heat trap and to provide an upward-moving air column. The height shall not be decreased unless approved and justified by design and test.

909.20.4.4 [Stair] Stairway or ramp shaft air movement system. The [~~stair~~] stairway or ramp shaft shall be provided with a dampered relief opening and supplied with sufficient air to maintain a minimum positive pressure of 0.10 inch of water ([25] 24.9 Pa) in the shaft relative to the vestibule with all doors closed. The system shall maintain a maximum of 0.35 inch of water ([87] 87.2 Pa) in the shaft relative to the building measured with all stairway doors closed under maximum anticipated stack pressures.

909.20.4.5 Door opening force. Door opening force shall not exceed limits in Section [1008.1.3] 1010.1.3.

909.20.5 [Stair] Stairway and ramp pressurization alternative. Where the building is equipped throughout with an automatic sprinkler system in accordance with Section 903.3.1.1, the vestibule is not required, provided [~~that~~] each interior exit [stairways are pressurized] stairway or ramp is pressurized to [a minimum of] not less than 0.10 [inches] inch of water ([25] 24.9 Pa) and [~~a maximum of~~] not more than 0.35 inches of water ([87] 87.2 Pa) in the shaft relative to the building measured with all interior exit stairway and ramp doors closed under maximum anticipated conditions of stack effect and wind effect.

909.20.6 Ventilating equipment. The activation of ventilating equipment required by the alternatives in Sections 909.20.4 and 909.20.5 shall be by smoke detectors installed at each floor level at an approved location at the entrance to the smokeproof enclosure. When the closing device for the [~~stair~~] stairway and ramp shaft and vestibule doors is activated by smoke detection or

power failure, the mechanical equipment shall activate and operate at the required performance levels. Smoke detectors shall be installed in accordance with Section 907.3.

909.20.6.1 Ventilation systems. Smokeproof enclosure ventilation systems shall be independent of other building ventilation systems. The equipment, control wiring, power wiring and ductwork shall comply with one of the following:

1. Equipment, control wiring, power wiring and ductwork shall be located exterior to the building and directly connected to the smokeproof enclosure or connected to the smokeproof enclosure by ductwork enclosed by not less than 2-hour fire barriers constructed in accordance with Section 707 or horizontal assemblies constructed in accordance with Section ~~[712]~~ 711, or both.
2. Equipment, control wiring, power wiring and ductwork shall be located within the smokeproof enclosure with intake or exhaust directly from and to the outside or through ductwork enclosed by not less than 2-hour fire barriers constructed in accordance with Section 707 or horizontal assemblies constructed in accordance with Section ~~[712]~~ 711, or both.
3. Equipment, control wiring, power wiring and ductwork shall be located within the building if separated from the remainder of the building, including other mechanical equipment, by not less than 2-hour fire barriers constructed in accordance with Section 707 or horizontal assemblies constructed in accordance with Section ~~[712]~~ 711, or both.

Exceptions:

1. Control wiring and power wiring utilizing a 2-hour rated cable or cable system in accordance with UL 2196.
2. Where encased with not less than 2 inches (~~[51]~~ 50.8 mm) of concrete.
3. Control wiring and power wiring protected by a listed electrical circuit protective system with a fire-resistance rating of not less than 2 hours.

909.20.6.2 Standby power. Mechanical vestibule and ~~[stair]~~ stairway and ramp shaft ventilation systems and automatic fire detection systems shall be ~~[powered by a]~~ provided with standby power ~~[system conforming to Section]~~ in accordance with Sections ~~[403.4.7]~~ 403.4.8 and ~~[Chapter 27]~~ 2702.

909.20.6.3 Acceptance and testing. Before the mechanical equipment is approved, the system shall be tested in the presence of the department or approved agency to confirm that the system is operating in compliance with these requirements.

909.21 Elevator hoistway pressurization alternative. Where elevator hoistway pressurization is provided in lieu of required enclosed elevator lobbies, the pressurization system shall comply with Sections 909.21.1 through 909.21.11.

909.21.1 Pressurization requirements. Elevator hoistways shall be pressurized to maintain a minimum positive pressure of 0.10 inch of water (24.9 Pa) and a maximum positive pressure of 0.25 inch of water (62.2 Pa) with respect to adjacent occupied space on all floors. This pressure shall be measured at the midpoint of each hoistway door, with all elevator cars at the floor of recall and all hoistway doors on the floor of recall open and all other hoistway doors closed. The pressure differentials shall be measured between the hoistway and the adjacent elevator landing. The opening and closing of hoistway doors at each level must be demonstrated during this test. The supply air intake shall be from an outside, uncontaminated source located a minimum distance of 20 feet (6096 mm) from any air exhaust system or outlet.

Exceptions:

1. On floors containing only Group R occupancies, the pressure differential is permitted to be measured between the hoistway and a dwelling unit or sleeping unit.
2. Where an elevator opens into a lobby enclosed in accordance with Section 3007.6 or 3008.7, the pressure differential is permitted to be measured between the hoistway and the floor space immediately outside of the door(s) to the enclosed lobby.
3. The pressure differential is permitted to be measured relative to the outdoor atmosphere on floors other than the following:
 - 3.1. The fire floor.
 - 3.2. The two floors immediately below the fire floor.
 - 3.3. The floor immediately above the fire floor.
4. The minimum positive pressure of 0.10 inch of water (24.9 Pa) and a maximum positive pressure of 0.25 inch of water (62.2 Pa) with respect to occupied floors are not required at the floors of recall with the doors open.

909.21.1.1 Use of ventilation systems. Ventilation systems, other than hoistway supply air systems, are permitted to be used to exhaust air from adjacent spaces on the fire floor, two floors immediately below and one floor immediately above the fire floor to the building's exterior where necessary to maintain positive pressure relationships as required in Section 909.21.1 during operation of the elevator shaft pressurization system.

Where ventilation systems are being used as a component of the elevator hoistway pressurization system, they shall comply with Section 909.21.

909.21.2 Rational analysis. A rational analysis complying with Section 909.4 shall be submitted with the construction documents.

909.21.3 Ducts for system. Any duct system that is part of the pressurization system shall be protected with the same fire-resistance rating as required for the elevator shaft enclosure.

909.21.4 Fan system. The fan system provided for the pressurization system shall be as required by Sections 909.21.4.1 through 909.21.4.4.

909.21.4.1 Fire resistance. Where located within the building, the fan system that provides the pressurization shall be protected with the same fire-resistance rating required for the elevator shaft enclosure.

909.21.4.2 Smoke detection. The supply fan system shall be equipped with a smoke detector that will automatically shut down the supply fan system when smoke is detected within the system.

909.21.4.3 Separate systems. A separate fan system shall be used for each elevator hoistway.

909.21.4.4 Fan capacity. The supply fan capacity shall be specified by a registered design professional to meet the requirements of a designed pressurization system in accordance with the rational analysis required by Section 909.21.2.

909.21.5 Standby power. The pressurization system, including ventilation systems used per Section 909.21.1.1, shall be provided with standby power in accordance with Section 2702.

909.21.6 Activation of pressurization system. The elevator pressurization system shall be activated upon activation of either the building fire alarm system or the elevator landing smoke detectors. Where both a building fire alarm system and elevator landing smoke detectors are present, each shall be independently capable of activating the pressurization system.

909.21.7 Testing and special inspections. Special inspections for performance shall be required in accordance with Section 909.18.8. System acceptance testing shall be in accordance with Section 909.19.

909.21.8 Marking and identification. Detection and control systems shall be marked in accordance with Section 909.14.

909.21.9 Control diagrams. Control diagrams shall be provided in accordance with Section 909.15.

909.21.10 Firefighter's smoke control panel. A control panel complying with Section 909.16 shall be provided.

909.21.11 System response time. Hoistway pressurization systems shall comply with the requirements for smoke control system response time in Section 909.17.

SECTION BC 910 SMOKE AND HEAT [~~VENTS~~] REMOVAL

910.1 General. Where required by this code [~~or otherwise installed~~], smoke and heat vents or mechanical smoke [~~exhaust~~] removal systems [~~and draft curtains~~] shall conform to the requirements of this section.

910.2 Where required. Smoke and heat vents or a mechanical smoke removal system shall be installed as required by Sections 910.2.1 and 910.2.2.

Exceptions:

1. Frozen-food warehouses used solely for storage of Class I and II commodities where protected by an automatic sprinkler system in accordance with Section 903.3.1.1.
2. ~~[Where] Smoke and heat removal shall not be required in areas of buildings [are] equipped with early suppression fast-response (ESFR) sprinklers[, automatic smoke and heat vents shall not be required within these areas].~~
3. Smoke and heat removal shall not be required in areas of buildings equipped with control mode special application sprinklers with a response time index of $50 (m \cdot s)^{1/2}$ or less that are listed to control a fire in stored commodities with 12 or fewer sprinklers.

~~[910.2 Where required. Smoke and heat vents shall be installed in the roofs of buildings or portions thereof occupied for the uses set forth in Sections 910.2.1 and 910.2.2. Vents shall be installed at the top of a closed shaft in accordance with Section 708.12.1.]~~

910.2.1 Group F-1 or S-1. ~~[Buildings] Smoke and heat vents installed in accordance with Section 910.3 or a mechanical smoke removal system installed in accordance with Section 910.4 shall be installed in buildings and portions thereof used as a Group F-1 or S-1 occupancy having more than 50,000 square feet ([4645] 4645.2 m^2) [in] of undivided area. In occupied portions of a building equipped throughout with an automatic sprinkler system in accordance with Section 903.3.1.1, where the upper surface of the story is not a roof assembly, a mechanical smoke removal system in accordance with Section 910.4 shall be installed.~~

Exception: Group S-1 aircraft repair hangars.

910.2.2 High-piled combustible storage. ~~[Buildings] Smoke and heat removal for buildings and portions thereof containing high-piled combustible [stock or rack] storage [in any occupancy group] shall be installed in accordance with [Section 413 of this code and] the *New York City Fire Code* and Section 413 of this code. Installation shall also be in conformance with Section 910.3 in unsprinklered buildings and portions thereof.~~

In buildings and portions thereof containing high-piled combustible storage equipped throughout with an automatic sprinkler system in accordance with Section 903.3.1.1, a smoke and heat removal system shall be installed in accordance with Section 910.3 or 910.4. In occupied portions of a building equipped throughout with an automatic sprinkler system in accordance with Section 903.3.1.1, where the upper surface of the story is not a roof assembly, a mechanical smoke removal system in accordance with Section 910.4 shall be installed.

910.3 [Design and installation] Smoke and heat vents. The design and installation of smoke and heat vents ~~[and draft curtains]~~ shall be ~~[as specified]~~ in accordance with Sections 910.3.1 ~~[and Table 910.3]~~ through 910.3.3.

[TABLE 910.3]

REQUIREMENTS FOR DRAFT CURTAINS AND SMOKE AND HEAT VENTS*

[OCCUPANCY GROUP AND COMMODITY CLASSIFICATION]	[DESIGNATED STORAGE HEIGHT (feet)]	[MINIMUM DRAFT CURTAIN DEPTH (feet)]	[MAXIMUM AREA FORMED BY DRAFT CURTAINS (square feet)]	[VENT AREA TO FLOOR AREA RATIO]	[MAXIMUM SPACING OF VENT CENTERS (feet)]	[MAXIMUM DISTANCE FROM VENTS TO WALL OR DRAFT CURTAIN ^b (feet)]
[Group F-1]	[—]	[$0.2 \times H^d$ but ≥ 4]	[50,000]	[1:100]	[120]	[60]
[High piled (see Section 910.2.2) Class I-IV commodities (Option 1)]	[≤ 20]	[6]	[10,000]	[1:100]	[100]	[60]
	[$> 20 \leq 40$]	[6]	[8,000]	[1:75]	[100]	[55]
[High piled Storage (see Section 910.2.2) Class I-IV commodities (Option 2)]	[≤ 20]	[4]	[3,000]	[1:75]	[100]	[55]
	[$> 20 \leq 40$]	[4]	[3,000]	[1:50]	[100]	[50]
[High piled Storage (see Section 910.2.2) High hazard commodities (Option 1)]	[≤ 20]	[6]	[6,000]	[1:50]	[100]	[50]
	[$> 20 \leq 30$]	[6]	[6,000]	[1:40]	[90]	[45]
[High piled Storage (see Section 910.2.2) Class High hazard commodities (Option 2)]	[≤ 20]	[4]	[4,000]	[1:50]	[100]	[50]
	[$> 20 \leq 30$]	[4]	[2,000]	[1:30]	[75]	[40]

[For SI: 1 foot = 304.8 mm, 1 square foot = 0.0929 m².]

- [1. Requirements for rack storage heights in excess of those indicated shall be in accordance with the *New York City Fire Code*. For solid piled storage heights in excess of those indicated, an approved engineered design shall be used.]
- [2. Vents adjacent to walls or draft curtains shall be located within a horizontal distance not greater than the maximum distance specified in this column as measured perpendicular to the wall or draft curtain that forms the perimeter of the draft curtained area.]
- [3. Where draft curtains are not required, the vent area to floor area ratio shall be calculated based on a minimum draft curtain depth of 6 feet (Option 1).]
- [4. H is the height of the vent, in feet, above the floor.]

910.3.1 [Design] Listing and labeling. Smoke and heat vents shall be listed and labeled to indicate compliance with UL 793 or FM 4430.

[910.3.2 Vent operation. Smoke and heat vents shall be capable of being operated by approved automatic and manual means. Automatic operation of smoke and heat vents shall conform to the provisions of Sections 910.3.2.1 through 910.3.2.3.]

[910.3.2.1 Gravity-operated drop-out vents. Automatic smoke and heat vents containing heat-sensitive glazing designed to shrink and drop out of the vent opening when exposed to

~~fire shall fully open within 5 minutes after the vent cavity is exposed to a simulated fire, represented by a time-temperature gradient that reaches an air temperature of 500°F (260°C) within 5 minutes.]~~

~~[**910.3.2.2 Sprinklered buildings.** Where installed in buildings provided with an automatic sprinkler system in accordance with Section 903.3.1.1, smoke and heat vents shall be designed to operate automatically.]~~

~~[**910.3.2.3 Nonsprinklered buildings.** Where installed in buildings not provided with an automatic sprinkler system, smoke and heat vents shall operate automatically by actuation of a heat responsive device rated at between 100°F (38°C) and 220°F (104°C) above ambient.]~~

~~[**Exception:** Gravity-operated drop-out vents complying with Section 910.3.2.1.]~~

~~[**910.3.3 Vent dimensions.** The effective venting area shall not be less than 16 square feet (1.5 m²) with no dimension less than 4 feet (1219 mm), excluding ribs or gutters having a total width not exceeding 6 inches (152 mm).]~~

~~[**910.3.4 Vent locations.]** **910.3.2 Smoke and heat vent locations.** Smoke and heat vents shall be located 20 feet (6096 mm) or more from adjacent lot lines and fire walls and 10 feet (3048 mm) or more from fire barriers. Vents shall be uniformly located within the roof in the areas of the building where the vents are required to be installed by Section 910.2[7] with consideration given to roof pitch[~~, draft curtain location~~], sprinkler location and structural members.~~

~~[**910.3.5 Draft curtains.** Where required by Table 910.3, draft curtains shall be installed on the underside of the roof in accordance with this section.]~~

~~[**Exception:** Where areas of buildings are equipped with early suppression fast response (ESFR) sprinklers, draft curtains shall not be provided within these areas. Draft curtains shall only be provided at the separation between the ESFR sprinklers and the conventional non-ESFR sprinklers.]~~

~~[**910.3.5.1 Construction.** Draft curtains shall be constructed of sheet metal, lath and plaster, gypsum board or other approved materials that provide equivalent performance to resist the passage of smoke. Joints and connections shall be smoke tight.]~~

~~[**910.3.5.2 Location and depth.** The location and minimum depth of draft curtains shall be in accordance with Table 910.3.]~~

910.3.3 Smoke and heat vents area. The required aggregate area of smoke and heat vents shall be calculated as follows:

For buildings equipped throughout with an automatic sprinkler system in accordance with Section 903.3.1.1:

$$A_{VR} = V/9000$$

(Equation 9-2)

where:

$$A_{VR} = \text{The required aggregate vent area (ft}^2\text{).}$$

$V =$ Volume (ft³) of the area that requires smoke removal.

For unsprinklered buildings:

$$A_{VR} = A_{FA}/50 \quad \text{(Equation 9-3)}$$

where:

A_{VR} = The required aggregate vent area (ft²).

A_{FA} = The area of the floor in the area that requires smoke removal.

910.4 Mechanical smoke [exhaust] removal systems. [~~Where approved by the department, engineered mechanical smoke exhaust shall be an acceptable alternate to smoke and heat vents.~~]
Mechanical smoke removal systems shall be designed and installed in accordance with Sections 910.4.1 through 910.4.7.

~~[910.4.1 Location. Exhaust fans shall be uniformly spaced within each draft-curtained area and the maximum distance between fans shall not be greater than 100 feet (30 480mm).]~~

910.4.1 Automatic sprinklers required. The building shall be equipped throughout with an approved automatic sprinkler system in accordance with Section 903.3.1.1.

~~[910.4.2 Size. Fans shall have a maximum individual capacity of 30,000 cfm (14.2 m³/s). The aggregate capacity of smoke exhaust fans shall be determined by the equation:]~~

$$[C = A \times 300 \quad \text{(Equation 9-4)}]$$

[where:]

[C = Capacity of mechanical ventilation required, in cubic feet per minute (m³/s).]

[A = Area of roof vents provided in square feet (m²) in accordance with Table 910.3.]

910.4.2 Exhaust fan construction. Exhaust fans that are part of a mechanical smoke removal system shall be rated for operation at 221°F (105°C). Exhaust fan motors shall be located outside of the exhaust fan air stream.

~~910.4.3 [Operation. Mechanical smoke exhaust fans shall be automatically activated by the automatic sprinkler system or by heat detectors having operating characteristics equivalent to those described in Section 910.3.2. Individual manual controls of each fan unit shall also be provided.]~~ **System design criteria.** The mechanical smoke removal system shall be sized to exhaust the building at a minimum rate of two air changes per hour based upon the volume of the building or portion thereof without contents. The capacity of each exhaust fan shall not exceed 30,000 cubic feet per minute (14.2 m³/sec).

910.4.3.1 Makeup air. No portion of the makeup air openings shall be higher than 6 feet (1828.8 mm) above the floor level. Operation of makeup air openings shall be manual or, if properly coordinated with the smoke removal system, automatic. The minimum gross area of makeup air inlets shall be 8 square feet per 1,000 cubic feet per minute (0.74 m² per 0.4719 m³/s) of smoke exhaust.

910.4.4 Activation. The mechanical smoke removal system shall be started by manual controls.

~~[910.4.4 Wiring and control. Wiring for operation and control of smoke exhaust fans shall be connected ahead of the main disconnect and protected against exposure to temperatures in excess of 1,000°F (538°C) for a period of not less than 15 minutes. Controls]~~

910.4.5 Manual control location. Manual controls shall be located so as to be [immediately] accessible to the [fire service] Fire Department from [the] an exterior door of the building and protected against interior fire exposure by not less than 1-hour fire barriers constructed in accordance with Section 707 or horizontal assemblies constructed in accordance with Section [712] 711, or both. The location of manual controls is subject to the approval of the Fire Commissioner.

~~[910.4.5 Supply air. Supply air for exhaust fans shall be provided at or near the floor level and shall be sized to provide a minimum of 50 percent of required exhaust. Openings for supply air shall be uniformly distributed around the periphery of the area served.]~~

~~910.4.6 [Interlocks. In combination comfort air handling/smoke removal systems or independent comfort air handling systems, fans shall be controlled to shut down in accordance with the approved smoke control sequence.]~~ **Control wiring.** Wiring for operation and control of mechanical smoke removal systems shall be connected ahead of the main disconnect in accordance with the *New York City Electrical Code* and be protected against interior fire exposure to temperatures in excess of 1,000°F (537.8°C) for a period of not less than 15 minutes.

910.4.7 Controls. Where building air-handling and mechanical smoke removal systems are combined or where independent building air-handling systems are provided, fans shall automatically shut down in accordance with the *New York City Mechanical Code*. The manual controls provided for the smoke removal system shall have the capability to override the automatic shutdown of fans that are part of the smoke removal system.

910.5 Maintenance. Smoke and heat vents and mechanical smoke removal systems shall be maintained in accordance with the *New York City Fire Code*.

SECTION BC 911 FIRE COMMAND CENTER

911.1 General. Where required by other sections of this code and in [all] buildings classified as high-rise buildings by this code, a fire command center for Fire Department operations shall be provided and shall comply with Sections 911.1.1 through [911.1.5] 911.1.6.

911.1.1 Location and access. The fire command center location shall be in the lobby of the building on the main entrance floor near the Fire Department designated response point.

911.1.2 Reserved.

911.1.3 Reserved.

911.1.4 Reserved.

911.1.5 Storage. Storage unrelated to operation of the fire command center shall be prohibited.

911.1.6 Required features. The fire command center shall comply with the New York City Fire Code and NFPA 72 and shall include the following features as applicable in their respective control units or panels:

1. Fire alarm control unit:
 - 1.1. The emergency voice/alarm communication system control unit.
 - 1.2. The two-way communications system.
 - 1.3. Fire detection and alarm system annunciator.
 - 1.4. Controls for unlocking stairway doors and locked elevator vestibule doors simultaneously.
 - 1.5. Sprinkler valve and water-flow detector display panels.
 - 1.6. Emergency and standby power status indicators (generator running, generator failure to start).
 - 1.7. Fire pump status indicators.
 - 1.8. Elevator fire recall switch in accordance with ASME A17.1.
2. Auxiliary Radio Communication System Panel.
3. Elevator control panel:
 - 3.1. Annunciator visually indicating the location of the elevators and whether they are operational.
 - 3.2. Elevator emergency or standby power selector switch(es), where emergency or standby power is provided.
4. The [~~fire-fighter's~~] firefighter's control panel required by Section 909.16 for smoke control systems installed in the building.
5. Monitoring/Control for Post-Fire Smoke Purge:
 - 5.1. Status indicators and controls for air distribution systems.
 - 5.2. Manual controls of post-fire smoke purge system in accordance with Section [~~916.2.3~~] 917.2.3.
6. A telephone for Fire Department use with controlled access to the public telephone system.
7. Public address system, where specifically required by other sections of this code.

8. Manual controls for the release of doors that are automatic-closing by the actuation of smoke detectors or activation of the fire alarm in accordance with the exception to Section ~~[708.7]~~ 713.7.

911.2 Secondary fire command center. Where required in locations described in Appendix G of this code, a secondary fire command center shall be provided subject to the approval of the Fire Department. Design and installation requirements shall be in accordance with NFPA 72.

SECTION BC 912 FIRE DEPARTMENT CONNECTIONS

912.1 Installation. Fire Department connections shall be installed in accordance with the NFPA standard applicable to the system design and shall comply with Sections 912.2 through ~~[912.5]~~ 912.6.

912.2 Location. With respect to hydrants, driveways, buildings and landscaping, Fire Department connections shall be so located that fire apparatus and hose connected to supply the system will not obstruct access to the buildings for other fire apparatus.

912.2.1 Fire Department connections. The location of Fire Department connections shall be as follows:

912.2.1.1 One Fire Department connection shall be provided for each 300 feet (91 140 mm) of exterior building wall or fraction thereof facing upon each street or public space.

912.2.1.2 Where buildings face upon two parallel streets or public spaces without an intersecting street or public space, one connection shall be provided for each 300 feet (91 140 mm) of exterior building wall or fraction thereof facing upon each such parallel street or public space.

912.2.1.3 Where a building faces upon two intersecting streets or public spaces and the total length of the exterior building walls facing upon such streets or public spaces does not exceed 300 feet (91 140 mm), only one Fire Department connection need be installed provided the Fire Department connection is located within 15 feet (4572 mm) of the corner and on the street with the longest building frontage.

912.2.1.4 Where a building faces on three streets or public spaces, one Fire Department connection shall be provided for each 300 feet (91 140 mm) of building wall or fraction thereof facing upon such streets or public spaces provided that at least one Fire Department connection is installed on each of the parallel streets or public spaces, and further provided that the Fire Department connections shall be located so that the distance between them does not exceed 300 feet (91 140 mm).

912.2.1.5 Where a building faces upon four streets or public spaces, at least one Fire Department connection shall be provided on each street front or public space; however, only one Fire Department connection need be provided at the corner of two intersecting streets or public spaces if the Fire Department connection is located within 15 feet (4572 mm) of the corner and on the street with the longest building frontage or public space, and if the distances between Fire Department connections, in all cases, do not exceed 300 feet (91 140 mm).

912.2.1.6 In any case where the exterior building walls of a building facing a street or public space are obstructed in part by another building, one Fire Department connection shall be provided for each clear 300 feet (91 140 mm) of exterior building wall or fraction thereof facing upon such street or public space.

912.2.2 Existing buildings. On existing buildings, wherever the Fire Department connection is not visible to approaching fire apparatus, the Fire Department connection shall be indicated by an approved sign mounted on the street front or on the side of the building. Such sign shall have the letters "FDC" [~~at least~~] not less than 6 inches (152] 152.4 mm) high and words in letters [~~at least~~] not less than 2 inches (51] 50.8 mm) high or an arrow to indicate the location. [~~All such~~] Such signs shall be subject to the approval of the Fire Department.

912.3 Fire hose threads. Fire hose threads used in connection with standpipe, sprinkler and combination standpipe-sprinkler systems shall be approved and shall be compatible with New York City Fire Department hose threads.

~~[912.3] 912.4 Access.~~ Immediate access to Fire Department connections shall be maintained at all times and without obstruction by fences, bushes, trees, walls or any other object. [~~A working space of not less than 36 inches (762 mm) in width, 36 inches (914 mm) in depth and 78 inches (1981 mm) in height shall be provided and maintained in front of and to the sides of wall-mounted Fire Department connections and around the circumference of free-standing Fire Department connections, except as otherwise required or approved.]~~

Exception: Fences, where provided with an access gate and a means of emergency operation that shall be maintained operational at all times in accordance with the *New York City Fire Code*.

912.4.1 Locking Fire Department connection caps. The Fire Department may require locking caps on Fire Department connections in accordance with the *New York City Fire Code*.

912.4.2 Clear space around connections. A working space of not less than 36 inches (914.4 mm) in width, 36 inches (914.4 mm) in depth and 78 inches (1981.2 mm) in height shall be provided and maintained in front of and to the sides of wall-mounted Fire Department connections and around the circumference of free-standing Fire Department connections, except as otherwise required or approved by the Fire Commissioner.

912.4.3 Physical protection. Where Fire Department connections are subject to impact by a motor vehicle, vehicle impact protection shall be provided in accordance with the *New York City Fire Code*.

~~[912.4] 912.5 Signs.~~ Fire Department connections shall be provided with signage in accordance with Section 912 of the *New York City Fire Code*.

~~[912.5] 912.6 Backflow protection.~~ The potable water supply to automatic sprinkler and standpipe systems shall be protected against backflow as required by the *New York City Plumbing Code*.

SECTION BC 913 FIRE PUMPS

913.1 General. Where provided or required, fire pumps shall be installed in accordance with this section, NFPA 20~~[Appendix Q]~~ and other applicable sections of this code.

913.2 Protection against interruption of service. The fire pump, driver and controller shall be protected in accordance with NFPA 20 against possible interruption of service.

913.2.1 Protection of fire pump rooms. Fire pumps shall be located in rooms that are separated from all other areas of the building by 2-hour fire barriers constructed in accordance with Section 707 or 2-hour horizontal assemblies constructed in accordance with Section ~~[712]~~ 711, or both.

Exceptions:

1. In other than high-rise buildings, separation by 1-hour fire barriers constructed in accordance with Section 707 or 1-hour horizontal assemblies constructed in accordance with Section ~~[712]~~ 711, or both, shall be permitted in buildings equipped throughout with an automatic sprinkler system in accordance with Section 903.3.1.1 or 903.3.1.2.
2. Separation is not required for fire pumps physically separated in accordance with NFPA 20.
3. Separation is not required for a fire pump, other than an automatic standpipe fire pump, where such fire pump is located in a mechanical equipment room, as defined by the *New York City Mechanical Code*, enclosed by 2-hour fire barriers constructed in accordance with Section 707 or 2-hour horizontal assemblies constructed in accordance with Section ~~[712]~~ 711, or both. Refrigerants, gas piping, gas consumption devices, gas meters or any other gas equipment and fuel storage or fuel consuming appliances shall not be installed in any space housing a fire pump.

913.2.2 Circuits supplying fire pumps. Cables used for survivability of circuits supplying fire pumps shall be in accordance with the *New York City Electrical Code*. Electrical circuit protective systems shall be installed in accordance with their listing requirements, and *the New York City Electrical Code*.

913.3 Temperature of pump room. Suitable means shall be provided for maintaining the temperature of a pump room or pump house, where required, above 40°F (~~[5]~~ 4.4°C).

913.3.1 Engine manufacturer's recommendation. Temperature of the pump room, pump house or area where engines are installed shall never be less than the minimum recommended by the engine manufacturer. The engine manufacturer's recommendations for oil heaters shall be followed.

913.4 Valve supervision. Where provided, the fire pump suction, discharge and bypass valves, and isolation valves on the backflow prevention device or assembly shall be supervised open as required by Section 907.

913.4.1 Test outlet control valve supervision. Fire pump test outlet control valves shall be supervised in the closed position. Individual hose valves on the test header are not required to be monitored.

913.5 Acceptance test. Acceptance testing shall be done in accordance with the requirements of Section 1705.30 of this code, the *New York City Fire Code* and NFPA 20. Refurbished or repaired fire pumps shall be tested in accordance with Section 1705.30 of this code, the *New York City Fire Code* and NFPA 20. All such tests shall be scheduled to include a department representative as a witness, if required.

SECTION BC 914 EMERGENCY RESPONDER SAFETY FEATURES

914.1 Shaftway markings. Vertical shafts shall be identified as required by the *New York City Fire Code* and Sections 914.1.1 and 914.1.2 of this code.

914.1.1 Exterior access to shaftways. Outside openings accessible to the Fire Department and that open directly on a hoistway or shaftway communicating between two or more floors in a building shall be plainly marked with the word “SHAFTWAY” in red letters [~~at least~~] not less than 6 inches (~~[152]~~ 152.4 mm) high on a white background. Such warning signs shall be placed so as to be readily discernible from the outside of the building.

914.1.2 Interior access to shaftways. Door or window openings to a hoistway or shaftway from the interior of the building shall be plainly marked with the word “SHAFTWAY” in red letters [~~at least~~] not less than 6 inches (~~[152]~~ 152.4 mm) high on a white background. Such warning signs shall be placed so as to be readily discernible.

Exception: Markings shall not be required on shaftway openings that are readily discernible as openings onto a shaftway by the construction or arrangement.

914.2 Equipment room identification. Fire protection equipment shall be identified in an approved manner. Rooms containing controls for air-conditioning systems, sprinkler risers and valves or other fire detection, suppression or control elements shall be identified for the use of the Fire Department. Approved signs required to identify fire protection equipment and equipment location shall be constructed of durable materials, permanently installed and readily visible.

SECTION BC 915 [RESERVED] CARBON MONOXIDE DETECTION

915.1 Carbon monoxide alarms and detectors. Carbon monoxide alarms and detectors shall be provided and installed in accordance with Sections 915.1.1 through 915.7.

915.1.1 Group I-1 and R occupancies. Listed carbon monoxide alarms or detectors shall be installed as follows:

1. Group I-1, Group R-1, and Group R-2 where the main use or dominant occupancy of a building is classified as Group R-2 student apartments. Carbon monoxide detectors and

audible notification appliances shall be installed in affected dwelling units in accordance with Section 915.1.1.1 and shall be annunciated by dwelling unit at a constantly attended location from which the fire alarm system is capable of being manually activated.

2. Groups R-2 (other than occupancies covered by Item 1) and R-3. Carbon monoxide alarms shall be installed in affected dwelling units in accordance with Section 915.1.1.1.

915.1.1.1 Affected dwelling units. Carbon monoxide alarms or detectors shall be required within the following dwelling units:

1. Units on the same story where carbon monoxide-producing equipment or enclosed parking is located.
2. Units on the stories immediately above and below the floor where carbon monoxide-producing equipment or enclosed parking is located.
3. Units in a building containing a carbon monoxide-producing furnace, boiler, or water heater as part of a central system.
4. Units in a building served by a carbon monoxide-producing furnace, boiler, or water heater as part of a central system that is located in an adjoining or attached building.

915.1.1.1.1 Required locations within dwelling units. Carbon monoxide alarms or detectors shall be located within dwelling units as follows:

1. Outside of any room used for sleeping purposes, within 15 feet (4572 mm) of the entrance to such room.
2. In any room used for sleeping purposes.
3. On any story within a dwelling unit, including below-grade stories and penthouses of any area, but not including crawl spaces and uninhabitable attics.

915.1.1.1.2 Exhaust of Carbon Monoxide in Group R-3 Occupancy (One- and Two-Family dwellings and townhouses). Means of exhausting carbon monoxide from garages shall be provided when a carbon monoxide alarm or detector is activated in a Group R-3 occupancy, provided such garage is attached within the Group R-3 occupancy. Such exhaust system shall be arranged to operate automatically upon detection of a concentration of carbon monoxide of 35 parts per million (ppm) or greater by approved automatic detection device. The system shall be capable of producing an exhaust rate of 1.5 cfm per square foot of floor area of the garage. Removal of sensor, interruption of power or cut wires shall cause the relay circuit to open and start fan. The relay contact shall close and the fan may shut off when the carbon monoxide level is below 35 ppm. Carbon monoxide exhausting means shall be connected to a separate circuit and provided with a lock and identified at the power source. Such circuit shall not be connected to a power source through an arc-fault or Ground Fault Circuit Interrupter (GFCI) devices. Additionally, when the carbon monoxide exhausting means is connected to the plug-in-

type overcurrent protection device, such device shall be secured in place by an additional fastener.

915.1.2 Buildings that are equipped with a fire alarm system and that contain Group A-1, A-2, A-3, Group B or Group M occupancies. Listed carbon monoxide detectors shall be installed in buildings that are equipped with a fire alarm system and that contain Group A-1, A-2 or A-3, Group B or Group M occupancies. Such carbon monoxide detectors installed pursuant to this section shall have built-in sounder bases, shall transmit a carbon monoxide alarm signal to a central supervising station and shall be permitted to initiate an audible and visual supervisory signal at a constantly attended location. The department shall adopt rules and/or reference standards governing the installation and location of carbon monoxide detectors provided such detectors shall be required within rooms containing carbon monoxide-producing equipment and addressing the installation of such detectors or any alternative means of compliance in existing buildings.

915.1.2.1 Retroactive provisions for existing buildings. Notwithstanding any other provision of law, listed carbon monoxide detectors shall be installed in existing buildings that are equipped with a fire alarm system and that contain group A-1, A-2, A-3, Group B or Group M occupancies in accordance with Section 915.1.2 by July 1, 2021.

915.2 Group E, I-2 and I-4 occupancies. Listed carbon monoxide detectors with built-in sounder bases shall transmit a carbon monoxide alarm signal to a central supervising station and shall be permitted to initiate an audible and visual supervisory signal at a constantly attended location.

1. Carbon monoxide detectors with built-in sounder bases shall be installed within any room containing carbon monoxide-producing equipment.
2. Carbon monoxide detectors with built-in sounder bases shall be installed in corridors on the story where carbon monoxide-producing equipment unit is located, as well as one story above and one story below.
3. Carbon monoxide detectors with built-in sounder bases shall be installed in all corridors on the story where enclosed parking or a loading dock is located, as well as one story above and one story below.

915.3 Installation requirement for all occupancies. Where a fire alarm system is required or provided, carbon monoxide detectors with sounder bases shall be installed within any room containing carbon monoxide-producing equipment.

915.3.1 Equipment shutdown. Activation of a carbon monoxide detector located at the source of carbon monoxide-producing equipment shall shut down that source.

Exception: This provision does not apply where the source is a generator.

915.4 Detection equipment. Carbon monoxide detection required by Sections 915.1 through 915.2 shall be provided by carbon monoxide alarms complying with Section 915.5 or carbon monoxide detection systems complying with Section 915.6, unless otherwise specified in this code.

915.5 Carbon monoxide alarms. Carbon monoxide alarms shall comply with Sections 915.5.1 through 915.5.4.

915.5.1 Power source. Carbon monoxide alarms shall receive their primary power from the building wiring where such wiring is served from a commercial source, and when primary power is interrupted, shall receive power from a battery. Wiring shall be permanent and without a disconnecting switch other than that required for overcurrent protection.

Exception: Where installed in buildings without commercial power, battery-powered carbon monoxide alarms shall be an acceptable alternative.

915.5.2 Listings. Carbon monoxide alarms shall be listed in accordance with UL 2034.

915.5.3 Combination alarms. Combination carbon monoxide/smoke alarms shall be an acceptable alternative to carbon monoxide alarms. Combination carbon monoxide/smoke alarms shall be listed in accordance with UL 2034 and UL 217.

915.5.4 Interconnection of alarms. When two or more alarms are installed, they shall be interconnected in accordance with NFPA 720.

915.6 Carbon monoxide detection systems. Carbon monoxide detection systems shall be an acceptable alternative to carbon monoxide alarms and shall comply with Sections 915.6.1 through 915.6.4.

915.6.1 General. Carbon monoxide detection systems shall comply with NFPA 720. Carbon monoxide detectors shall be listed in accordance with UL 2075.

915.6.2 Locations. Carbon monoxide detectors shall be installed in the locations specified in Section 915.2. These locations supersede the locations specified in NFPA 720.

915.6.3 Combination detectors. Combination carbon monoxide/smoke detectors installed in carbon monoxide detection systems shall be an acceptable alternative to carbon monoxide detectors, provided they are listed in accordance with UL 2075 and UL 268.

915.6.4 Wiring and power supply. Wiring and power supply for carbon monoxide detectors shall comply with Sections 907.6.1 and 907.6.2, respectively.

915.7 Inspection, testing and maintenance. Carbon monoxide alarms and carbon monoxide detection systems shall be inspected, tested and maintained in accordance with NFPA 720 and the *New York City Fire Code*.

SECTION BC 916
FIRE DEPARTMENT IN-BUILDING AUXILIARY
RADIO COMMUNICATION SYSTEM (ARCS)

916.1 General. This section covers the design, installation and performance criteria of Fire Department In-Building Auxiliary Radio Communication System (ARCS). Such systems shall be designed and installed by the *New York City Fire Code*, Sections 403 and 907 of this code, or where

installed voluntarily, such systems shall be designed and installed in accordance with this section, NFPA 72, the *New York City Electrical Code* and in accordance with Fire Department requirements.

916.1.1 Construction documents. Construction documents for ARCS shall be submitted for approval to the Fire Department prior to system installation. Construction documents shall include, but need not be limited to, all of the following:

1. Type of radio equipment and antenna.
2. Riser diagram and floor plans showing location of elements of the ARCS, including but not limited to building fire command center or fire alarm control panel, dedicated radio console, base station and all other critical system components such as antennas, amplifiers, cables as applicable.
3. Legend of all ARCS symbols and abbreviations used.
4. Location of primary and secondary power source.
5. Specification and listing details for all equipment, devices and cables.

916.1.2 Acceptance testing, maintenance and operational testing. Acceptance testing, maintenance and operational testing of the ARCS shall be performed in accordance with the *New York City Fire Code* and rules promulgated by the Fire Department.

916.2 Instructions. Operating, testing and maintenance instructions and record drawings (“as-builts”) and detailed specifications of all the components shall be provided at an approved location.

916.3 Where required. ARCS, which shall be in accordance with this section, shall be required in the following:

1. High-rise buildings constructed in accordance with Section 403.
2. Underground buildings constructed in accordance with Section 405.
3. Buildings having a total gross area exceeding 250,000 square feet (23 225.8 m²).

Exceptions:

1. Group R-2 buildings that meet all of the following requirements:
 - a. The highest occupied floor is less than 125 feet (38 100 mm) above the lowest level of Fire Department vehicle access;
 - b. The building has no more than 1 story below grade; and
 - c. The floor area of the building does not exceed 250,000 square feet (23 225.8 m²).
2. Where it is determined by the Fire Department that a radio communication system is not required.

SECTION BC 917
POST-FIRE SMOKE PURGE SYSTEMS

[916.1] 917.1 Scope and purpose. The purpose of this section is to establish minimum requirements for the design and installation of post-fire smoke purge systems, which are intended for the timely restoration of operations and overhaul activities once a fire is extinguished. Post-fire smoke purge systems are not intended or designed as life safety systems and are not required to meet the provisions of Section 909. Post-fire smoke purge systems shall be required in:

1. High-rise buildings subject to Section 403.
2. Buildings with any story exceeding 50,000 square feet (~~[4645]~~ 4645.2 m²) in floor area.
3. Building with spaces exceeding 100 feet (30 480 mm) from natural ventilation openings. Natural ventilation openings shall consist of operable windows and doors of at least 5 percent of the floor area or roof vents per Section 910.
4. High-piled stock or rack storage in accordance with the *New York City Fire Code*.

Exceptions: A post-fire smoke purge system is not required in Group R-2 occupancies where either of the following conditions exists:

1. **Openable windows.** A ~~[postfire]~~ post-fire smoke purge system is not required where every habitable room located in dwelling units is provided with windows complying with Chapter 12 and all of the following:
 - 1.1. **Minimum window area.** Each required window shall provide at least 12 square feet (1.1 m²) of glazed area. The total area of all such windows shall not be less than 10 percent of the floor area of the room or space served.
 - 1.2. **Minimum openable area.** Each required window shall provide a minimum of 6 square feet (0.56 m²) of openable area. The total area of all such openings shall not be less than 5 percent of the floor area of the room or space served. In addition, each required openable area shall be:
 - 1.2.1. Located wholly at least 30 inches (762 mm) above the finished floor; and
 - 1.2.2. Fully openable to the minimum 6 square feet (0.56 m²), at all times and without limiting stops or devices. Such openings may be achieved through the use of double-hung, sliding, or similar types of windows. However, in the event of the use of casement-, hopper-, pivot-, or awning-type windows, such windows shall satisfy the requirements of this section only when they open to at least 75 degrees (1.22 rad).
 - 1.3. **Window guards.** This exception shall not apply where the type of window guards installed in compliance with Section 27-2043.1 of the *Administrative Code* and Section 131.15 of the *New York City Health Code* requires the installation of limiting devices or stops.

2. **Smokeproof enclosures.** A post-fire smoke purge system is not required where all exits are constructed as smokeproof enclosures in accordance with Section [1022.9] 1023.11.

[916.2] 917.2 Post-fire smoke purge systems in occupancy groups other than R-2.

[916.2.1] 917.2.1 General design requirements. [Postfire] Post-fire smoke purge systems are permitted to use dedicated equipment, the normal building HVAC system or other openings and shall have the capability to exhaust smoke from occupied spaces. Smoke removal may be by either mechanical or natural ventilation, but shall be capable of removing cold smoke. Smoke removed from a space must be discharged to a safe location outside the building and shall not be recirculated into the building in accordance with the *New York City Mechanical Code*.

[916.2.2] 917.2.2 Exhaust capability. The system shall have an air supply and smoke exhaust capability that will provide a minimum of 6 air changes per hour or 1 cubic foot per minute per square foot (cfm/ft²) [~~0.00508 m³/s • m²~~] (0.00508 m³/s • m²), whichever is greater. The system need not exhaust from all areas at the same time, but is permitted to be zoned based on the largest fire area served. For the purpose of calculating system size, the height of a compartment shall be considered to run from slab to slab and include the volume above suspended ceilings. Provisions shall be made for sufficient make-up air. The provisions may include operable windows, doors, building leakage, or mechanical systems. In buildings having occupied floors located less than 75 feet (22 860 mm) above the lowest level of Fire Department vehicle access, breakable windows may be utilized.

[916.2.3] 917.2.3 Operation. The post-fire smoke purge system shall be operated by manual controls that are part of the fire command center, in accordance with Section 911, or fire alarm control unit when a fire command center is not required. Such control center or panel shall display a graphic indicating the portions of the building served by each [postfire] post-fire smoke purge system. When a system is zoned into areas of operation less than the entire building, each zone shall have an individual control. Fire Department manual controls of [postfire] post-fire smoke purge systems shall not override the manual or automatic operation of the smoke control system. Such Fire Department manual controls shall override the fire shutdown signal from the fire alarm system.

917.2.4 Interior exit stairways or ramps or exit passageways in occupancies other than Group R-2. Interior exit stairways or ramps or exit passageways shall not be used as a portion of the post-fire smoke purge system in occupancies other than Group R-2. Doors in interior exit stairways or ramps or exit passageways shall not be permitted to be used as a portion of the post-fire smoke purge system. Air transfer and duct openings associated with the post-fire smoke purge system shall not be permitted in the interior exit stairway or ramp or exit passageway.

[916.3] 917.3 Post-fire smoke purge systems in occupancy Group R-2. Post-fire smoke purge systems in Group R-2 occupancies shall comply with either Section [916.3.1 or 916.3.2] 917.3.1 or 917.3.2. Smoke removed must be discharged to a safe location outside the building and shall not be recirculated into the building in accordance with the *New York City Mechanical Code*.

[916.3.1] 917.3.1 Stair ventilation. The top of all enclosed exit stairs shall be provided with a reversible fan system capable of introducing fresh air or exhausting air at a rate of 6 air changes per hour or 1 cubic foot per minute per square foot (cfm/ft²) [~~0.00508 m³/s • m²~~] (0.00508

$\text{m}^3/\text{s} \cdot \text{m}^2$), whichever is greater, based on the area of the largest floor. Such system shall be operated by manual controls that are part of the fire command center, as per Section 911, or fire alarm panel when a fire command center is not required. Such control center or panel shall display a graphic indicating the portions of the building served by each post-fire smoke purge system. The operation of such system shall be controlled by Fire Department personnel by manually opening stair doors at the appropriate story.

[916.3.2] 917.3.2 Corridor ventilation. The ducts and fans that provide fresh air supply to the public corridors in accordance with the *New York City Mechanical Code* shall be provided with reversible fans and duct sizes capable of introducing fresh air to or exhausting air from the corridor at a rate of 6 air changes per hour or 1 cubic foot per minute per square foot (cfm/ft^2) [~~$\{0.00508 \text{ m}^3/\text{s} \cdot \text{m}^2\}$~~] ($0.00508 \text{ m}^3/\text{s} \cdot \text{m}^2$), whichever is greater, based on the area of the largest apartment plus the area of the public corridor. Such system shall be operated by manual controls that are part of the fire command center, as per Section 911 of this code, or fire alarm panel when a fire command center is not required. Each floor to be ventilated shall be by individual controls. Such control center or panel shall display a graphic indicating the portions of the building served by each postfire smoke purge system.

[916.4] 917.4 Maintenance. The building owner shall maintain [~~postfire~~] post-fire smoke exhaust systems in good operational condition. Records of testing shall be maintained on the premises for inspection by the department and Fire Department personnel.

~~[SECTION BC 917]
[FIRE DEPARTMENT IN-BUILDING AUXILIARY
RADIO COMMUNICATION SYSTEM (ARCS)]~~

~~[917.1 General. This section covers the design, installation and performance criteria of Fire Department In-Building Auxiliary Radio Communication System (ARCS). Where required to be installed by Section 403, Section 907, or the *New York City Fire Code* or where installed voluntarily, such systems shall be designed and installed in accordance with this section, NFPA 72 as modified in Appendix Q, the *New York City Electrical Code* and as per requirements set forth by the Fire Department.]~~

~~[917.1.1 Construction documents. Construction documents for ARCS shall be submitted for review and approval to the Fire Department prior to system installation. Construction documents shall include, but need not be limited to, all of the following:]~~

- ~~[1. Type of radio equipment and antenna.]~~
- ~~[2. Riser diagram and floor plans showing location of elements of the ARCS, including but not limited to building fire command center or fire alarm control panel, dedicated radio console, base station/s and all other critical system components such as antennas, amplifiers, cables as applicable.]~~
- ~~[3. Legend of all ARCS symbols and abbreviations used.]~~
- ~~[4. Location of primary and secondary power source.]~~

~~[5. Specification and listing details for all equipment, devices and cables.]~~

~~[**917.1.2 Acceptance testing, maintenance and operational testing.** Acceptance testing, maintenance and operational testing of the ARCS shall be performed in accordance with the *New York City Fire Code* and rules promulgated by the Fire Department.]~~

~~[**917.2 Instructions.** Operating, testing and maintenance instructions and record drawings (“as-builts”) and detailed specifications of all the components shall be provided at an approved location.]~~

SECTION BC 918 **GAS DETECTION SYSTEMS**

918.1 Gas detection systems. Gas detection systems, including systems designed to detect flammable, toxic, asphyxiants and other gases, required by the *New York City Construction Codes* or the *New York City Fire Code*, shall comply with Sections 918.2 through 918.10 of this code.

918.2 Design and installation. Gas detection systems shall be designed and installed in accordance with this code, the *New York City Electrical Code*, and manufacturer’s instructions. Such systems shall be inspected, tested and maintained in accordance with the *New York City Fire Code*.

918.2.1 Construction documents. Construction documents for gas detection systems shall be submitted for review and approval to the Fire Department prior to system installation. Construction documents shall include, but not be limited to, the following:

1. Gas detection system devices and equipment.
2. Engineering evaluation.
3. Items required by Section 907.1.1, as applicable.

918.3 Equipment. Gas detection system devices and equipment shall be designed for use with the particular gas being detected.

918.4 Reserved.

918.5 Emergency power. Gas detection systems shall be provided with emergency power in accordance with the *New York City Fire Code* and Chapter 27 of this code.

918.6 Sensor locations. Where leaking gases are expected to accumulate, sensors shall be installed in approved locations in accordance with the *New York City Fire Code* and NFPA 72.

918.7 Gas sampling. Gas detection systems shall perform continuous gas sampling. Sample analysis shall be processed immediately after sampling, except as follows:

1. For HPM gases, sample analysis shall be performed at intervals not exceeding 30 minutes.
2. For toxic gases, sample analysis shall be performed at intervals not exceeding 5 minutes in accordance with the Section 6004 of the *New York City Fire Code*.

3. Where a less frequent or delayed sampling interval is approved by the Fire Commissioner.

918.8 System activation. Gas detection systems shall activate and initiate an alarm system in compliance with the requirements of Sections 918.8.1 and 918.8.2.

918.8.1 Activation thresholds. A gas detection system alarm shall be initiated when a sensor detects a concentration of gas exceeding the following thresholds unless otherwise specified in this code or the *New York City Fire Code*:

1. For flammable gases, a gas concentration exceeding 25 percent of the lower flammability limit (LFL).
2. For nonflammable gases, a gas concentration exceeding one-half of the immediately dangerous to life and health (IDLH) concentration.

918.8.2 Alarm signals. The gas detection system shall initiate a local alarm and transmit a signal to a constantly attended control station when a short-term hazard condition is detected. The alarm shall be both visible and audible and shall provide warning both inside and outside the area where gas is detected. The audible alarm shall be distinct from all other alarms.

918.8.3 Shutoff of gas supply. The gas detection system shall automatically close the shutoff valve at the source of gas supply piping and tubing related to the system being monitored for whichever gas is detected.

Exception: Automatic shutdown is not required for reactors utilized for the production of highly toxic or toxic compressed gases where such reactors comply with all of the following:

1. Operated at pressures less than 15 pounds per square inch gauge (psig) (103.4 kPa).
2. Constantly attended.
3. Provided with readily accessible emergency shutoff valves.

918.8.4 Valve closure. The automatic closure of shutoff valves shall be in accordance with the following:

1. When the gas-detection sampling point initiating the gas detection system alarm is within a gas cabinet or exhausted enclosure, the shutoff valve in the gas cabinet or exhausted enclosure for the specific gas detected shall automatically close.
2. Where the gas-detection sampling point initiating the gas detection system alarm is within a gas room and compressed gas containers are not in gas cabinets or exhausted enclosures, the shutoff valves on all gas lines for the specific gas detected shall automatically close.
3. Where the gas-detection sampling point initiating the gas detection system alarm is within a piping distribution manifold enclosure, the shutoff valve for the compressed container of specific gas detected supplying the manifold shall automatically close.

Exception: When the gas-detection sampling point initiating the gas detection system alarm is at a use location or within a gas valve enclosure of a branch line downstream of a piping distribution manifold, the shutoff valve in the gas valve enclosure for the branch line located in the piping distribution manifold enclosure shall automatically close.

918.9 Reserved.

918.10 Fire alarm system connections. Gas detection systems shall be connected to and monitored at the Fire Command Center or fire alarm control unit where required or provided. Where a Fire Command Center or fire alarm control unit is not required or provided, an approved gas detection system control panel or annunciator shall be installed at the building main front entrance. A gas detection system shall be monitored by a central supervising station. Gas detection supervisory and alarm signals shall be transmitted as separate and distinct signals to the central supervising station.

§11 Chapter 10 of the New York city building code, as amended by, sections BC 1012, BC 1017, BC 1019 and BC 1024 as added by, and sections BC 1013, BC 1014, BC 1015, BC 1016, BC 1018, BC 1020, BC 1021, BC 1022, BC 1023, BC 1025, BC 1026, BC 1027, BC 1028, BC 1029 and BC 1030 as renumbered and amended by local law number 141 for the year 2013, sections 28-1022.1 and 28-1022.8 as amended by and section 28-1022.8.5 as added by local law number 17 for the year 2014, and section 28-1009.4.2 as amended by local law number 51 for the year 2014, is amended to read as follows:

**CHAPTER 10
MEANS OF EGRESS**

**SECTION BC 1001
ADMINISTRATION**

1001.1 General. Buildings or portions thereof shall be provided with a means of egress system as required by this chapter. The provisions of this chapter shall control the design, construction and arrangement of means of egress components required to provide an approved means of egress from structures and portions thereof.

1001.2 Minimum requirements. It shall be unlawful to alter a building or structure in a manner that will reduce the number of exits or the minimum width or required capacity of the means of egress to less than required by this code.

1001.3 Maintenance. Means of egress shall be maintained in accordance with the *New York City Fire Code*.

1001.3.1 Workplace exits. Except as specifically provided for in this chapter, no employer or agent of such employer shall lock the doors of or otherwise prohibit exit from any workplace,

when by so doing the health or safety of any employee, independent contractor or other individual working in such workplace may become endangered by fire or other hazardous condition. Refer to Article 307 of Title 28 of the *Administrative Code*.

[1001.4] 1001.3.2 Inadequate exits for existing structures. Every existing structure which is not provided with means of egress as required by this chapter and, in which the means of egress are, in the opinion of the commissioner, inadequate for the safety of the occupants, shall be provided with means of egress or fire protection as directed by the commissioner.

1001.4 Fire protection and emergency preparedness plans. Fire protection plans shall be provided for occupancies and buildings where required by Article 109 of the *Administrative Code*. Such fire protection plans shall comply with the applicable provisions of Section 28-109.3 of the *Administrative Code*. Emergency preparedness plans shall be provided for occupancies and buildings where required by the *New York City Fire Code*. Such emergency preparedness plans shall comply with the applicable provisions of Chapter 4 of the *New York City Fire Code*.

SECTION BC 1002 DEFINITIONS

1002.1 Definitions. ~~[The following words and terms shall, for the purposes of this chapter and as used elsewhere in this code, have the meanings shown herein]~~ This section contains terms defined elsewhere in the code, and terms with definitions that are specific to this section.

1002.1.1 Terms defined elsewhere in this code. The following terms are defined in Chapter 2:

ACCESSIBLE MEANS OF EGRESS. ~~[A continuous and unobstructed way of egress travel from any accessible point in a building or facility to a public way. Such way of egress travel may include an assisted rescue path.]~~

AISLE. ~~[An unenclosed exit access component that defines and provides a path of egress travel.]~~

AISLE ACCESSWAY. ~~[That portion of an exit access that leads to an aisle.]~~

ALTERNATING TREAD DEVICE. ~~[A device that has a series of steps between 50 and 70 degrees (0.87 and 1.22 rad) from horizontal, usually attached to a center support rail in an alternating manner so that the user does not have both feet on the same level at the same time.]~~

AREA OF RESCUE ASSISTANCE. ~~[An area where persons unable to use stairways can remain temporarily to await instructions or assistance during emergency evacuation.]~~

ASSEMBLY SPACE.

ASSISTED RESCUE PATH. ~~[A portion of the accessible means of egress which begins at the area of rescue assistance and terminates at the public way.]~~

BLEACHERS. ~~[Tiered seating supported on a dedicated structural system and two or more rows high and is not a building element (see “Grandstand”).]~~

BREAKOUT.

~~[COLLECTING SAFE AREA. A safe area that receives occupants from the assembly space it serves, as well as from other safe areas.]~~

~~COMMON PATH OF EGRESS TRAVEL. [That portion of exit access which the occupants are required to traverse before two separate and distinct paths of egress travel to two exits are available. Paths that merge are common paths of travel. Common paths of egress travel shall be included within the permitted travel distance.]~~

~~CORRIDOR. [An enclosed exit access component that defines and provides a path of egress travel to an exit. Corridors shall be either interior or public.]~~

~~CORRIDOR, INTERIOR. [A corridor that serves only one tenant. In Group E occupancies, corridors serving only one institution shall be deemed as serving a single tenant.]~~

~~CORRIDOR, PUBLIC. [A corridor that serves more than one tenant.]~~

~~CROSS AISLE. [An unenclosed exit access component in a place of assembly usually parallel to rows of seats, connecting aisles or connecting an aisle and an exit. For the purposes of this chapter, a cross aisle is not an aisle.]~~

~~DEAD END. [A portion of a corridor in which the travel to an exit is in one direction only.]~~

~~DOOR, BALANCED. [A door equipped with double pivoted hardware so designed as to cause a semicounterbalanced swing action when opening.]~~

~~EGRESS COURT. [A court or yard which provides access to a public way for one or more exits.]~~

~~EMERGENCY ESCAPE AND RESCUE OPENING. [An operable window, door or other similar device that provides for a means of escape and access for rescue in the event of an emergency.]~~

~~EXIT. [That portion of a means of egress system, which is separated from other interior spaces of a building or structure by fire resistance rated construction and opening protectives as required to provide a protected path of egress travel between the exit access and the exit discharge. Exits include exterior exit doors at the level of exit discharge, vertical exit enclosures, exit passageways, exterior exit stairways, exterior exit ramps and horizontal exits, but do not include access stairs, aisles, exit access doors opening to corridors, or corridors.]~~

~~EXIT ACCESS. [That portion of a means of egress system that leads from any occupied portion of a building or structure to an exit.]~~

~~EXIT ACCESS DOORWAY. [A door or access point along the path of egress travel from an occupied room, area or space where the path of egress enters an intervening room, corridor, unenclosed exit access stair or unenclosed exit access ramp.]~~

EXIT ACCESS RAMP.

EXIT ACCESS STAIRWAY.

EXIT DISCHARGE. [~~That portion of a means of egress system between the termination of an exit and a public way.~~]

EXIT DISCHARGE, LEVEL OF. [~~The story at the point at which an exit terminates and an exit discharge begins.~~]

[~~**EXIT ENCLOSURE.** An exit component that is separated from other interior spaces of a building or structure by fire-resistance-rated construction and opening protectives, and provides for a protected path of egress travel in a vertical or horizontal direction to the exit discharge or the public way.~~]

EXIT, HORIZONTAL. [~~An exit that provides a path of egress travel from one building to an area in another building on approximately the same level, or a path of egress travel through or around a wall or partition to an area on approximately the same level in the same building, or a bridge or tunnel between two buildings, which affords safety from fire and smoke from the area of incidence and areas communicating therewith.~~]

EXIT PASSAGEWAY. [~~An exit component that is separated from other interior spaces of a building or structure by fire-resistance-rated construction and opening protectives, and provides for a protected path of egress travel in a horizontal direction to the exit discharge or the public way.~~]

EXTERIOR EXIT RAMP.

EXTERIOR EXIT STAIRWAY.

FIRE EXIT HARDWARE. [~~Panic hardware that is listed for use on fire door assemblies.~~]

FIXED SEATING.

FLIGHT. [~~A continuous run of rectangular treads, winders or combination thereof from one landing to another.~~]

FLOOR AREA, GROSS. [~~The floor area within the inside perimeter of the exterior walls of the building under consideration, exclusive of courts, without deduction for corridors, stairways, closets, the thickness of interior walls, columns or other features. The floor area of a building, or portion thereof, not provided with surrounding exterior walls shall be the usable area under the horizontal projection of the roof or floor above. The gross floor area shall not include interior courts.~~]

FLOOR AREA, NET. [~~The actual occupied area not including the thickness of walls, partitions, columns, furred-in spaces, fixed cabinets, equipment, and unoccupied accessory areas such as corridors, stairways, toilet rooms, mechanical rooms and closets.~~]

FOLDING AND TELESCOPIC SEATING. [~~Tiered seating having an overall shape and size that is capable of being reduced for purposes of moving or storing and is not a building element.~~]

GRANDSTAND. [~~Tiered seating supported on a dedicated structural system and two or more rows high and is not a building element (see “Bleachers”).~~]

GUARD. [~~A building component or a system of building components located at or near the open sides of elevated walking surfaces that minimizes the possibility of a fall from the walking surface to a lower level.~~]

HANDRAIL. [~~A horizontal or sloping rail intended for grasping by the hand for guidance or support.~~]

INTERIOR EXIT RAMP.

INTERIOR EXIT STAIRWAY.

LOW ENERGY POWER-OPERATED DOOR.

MEANS OF EGRESS. [~~A continuous and unobstructed path of vertical and horizontal egress travel from any occupied portion of a building or structure to a public way. A means of egress consists of three separate and distinct parts: the exit access, the exit and the exit discharge.~~]

MERCHANDISE PAD. [~~A merchandise pad is an area for display of merchandise surrounded by aisles, permanent fixtures or walls. Merchandise pads contain elements such as nonfixed and moveable fixtures, cases, racks, counters and partitions from which customers browse or shop.~~]

NOSING. [~~The leading edge of treads of stairs and of landings at the top of stairway flights.~~]

OCCUPANT LOAD. [~~The number of persons for which the means of egress of a building or portion thereof is designed.~~]

OCCUPANT SENSOR.

OPEN-ENDED CORRIDOR.

[~~OPEN EXTERIOR SPACE.~~ A street or other public space; or a yard, court, or plaza open on one or more sides and unroofed or open on all sides, which provides egress to a street or public space.]

PANIC HARDWARE. [~~A door latching assembly incorporating a device that releases the latch upon the application of a force in the direction of egress travel.~~] [~~Having the property of emitting light that continues for a length of time after excitation by visible or invisible light has been removed.~~]

PHOTOSENSOR.

POWER-ASSISTED DOOR.

POWER-OPERATED DOOR.

PUBLIC WAY. [~~A street, alley or other parcel of land open to the outside air leading to a street, that has been deeded, dedicated or otherwise permanently appropriated to the public for public use and which has a clear width and height of not less than 10 feet (3048 mm).~~]

RAMP. [A walking surface that has a running slope steeper than one unit vertical in 20 units horizontal (5 percent slope).]

REFUGE AREA. [A floor area to which egress is made through a horizontal exit.]

~~[SAFE AREA. An interior or exterior space that serves as a means of egress by providing a transitional area from, and that also serves as a normal means of entry to, an assembly space.]~~

SCISSOR [STAIR] STAIRWAY. [Two interlocking stairways providing two separate paths of egress located within one stairwell enclosure.]

~~[SEATING SECTION. An area of seating bounded on all sides by aisles, cross aisles, walls or partitions.]~~

~~SELF-LUMINOUS. [Illuminated by a self-contained power source, other than batteries, and operated independently of external power sources.]~~

SMOKE-PROTECTED ASSEMBLY SEATING.[Seating served by means of egress that is not subject to smoke accumulation within or under a structure.]

STAIR.[A change in elevation, consisting of two or more risers.]

STAIRWAY. [One or more flights of stairs, either exterior or interior, with the necessary landings and platforms connecting them, to form a continuous and uninterrupted passage from one level to another.]

~~[Stairway, exterior. A stairway that is open on at least one side, except for required structural columns, beams, handrails and guards. The adjoining open areas shall be either yards, courts or public ways. The other sides of the exterior stairway need not be open.]~~

~~[Stairway, interior. A stairway not meeting the definition of an exterior stairway.]~~

~~[Stairway, spiral. A stairway having a closed circular form in its plan view with uniform section shaped treads attached to and radiating from a minimum diameter supporting column.]~~

STAIRWAY, SPIRAL.

~~[SUITE. A group of patient treatment rooms or patient sleeping rooms within Group I-2 occupancies where staff are in attendance within the suite, for supervision of all patients within the suite and the suite is in compliance with the requirements of Sections 1014.2.2 through 1014.2.7.]~~

WINDER.[A stair tread with nonparallel edges.]

1002.1.2 Definitions specific to this chapter. The following terms shall, for the purposes of this chapter, have the meanings shown herein:

COLLECTING SAFE AREA. A safe area that receives occupants from the assembly

space it serves, as well as from other safe areas.

OPEN EXTERIOR SPACE. A street or other public space; or a yard, court, or plaza open on one or more sides and unroofed or open on all sides, which provides egress to a street or public space.

SAFE AREA. An interior or exterior space that serves as a means of egress by providing a transitional area from, and that also serves as a normal means of entry to, an assembly space.

SEATING SECTION. An area of seating bounded on all sides by aisles, cross aisles, walls or partitions.

SECTION BC 1003 GENERAL MEANS OF EGRESS

1003.1 Applicability. The general requirements specified in Sections 1003 through ~~[4013]~~ 1015 shall apply to all three elements of the means of egress system, in addition to those specific requirements for the exit access, the exit and the exit discharge detailed elsewhere in this chapter.

1003.2 Ceiling height. The means of egress shall have a ceiling height of not less than 7 feet, 6 inches (2286 mm).

Exceptions:

1. Ceilings that are permitted to be less than 7 feet, 6 inches (2286 mm) in accordance with Section 1208.2.
2. Ceilings of dwelling units and sleeping units within residential occupancies in accordance with Section 1208.2.
3. Allowable projections in accordance with Section 1003.3.
4. Stair headroom in accordance with Section ~~[4009.2]~~ 1011.3.
5. Door height in accordance with Section ~~[4008.1.1.3]~~ 1010.1.3.
6. Ramp headroom in accordance with Section ~~[4010.5.2]~~ 1012.5.2.
7. The clear height of floor levels in vehicular and pedestrian traffic areas ~~[in]~~ of public and private parking garages in accordance with Section ~~[406.2.2]~~ 406.4.1.
8. Areas above and below mezzanine floors in accordance with Section ~~[505.1]~~ 505.2.

1003.3 Protruding objects. Protruding objects on circulation paths shall comply with the requirements of Sections 1003.3.1 through 1003.3.4.

1003.3.1 Headroom. Protruding objects are permitted to extend below the minimum ceiling height required by Section 1003.2 ~~[provided]~~ where a minimum headroom of 84 inches (~~[2134]~~)

2133.6 mm) ~~shall be~~ is provided ~~for~~ over any walking surface, including walks, corridors, aisles and passageways. Not more than 50 percent of the ceiling area of a means of egress shall be reduced in height by protruding objects.

Exception: Door closers and stops shall not reduce headroom to less than 78 inches (~~1981~~ 1981.2 mm).

A barrier shall be provided where the vertical clearance is less than 80 inches (2032 mm) high. The leading edge of such a barrier shall be located 27 inches (~~686~~ 685 mm) maximum above the floor.

1003.3.2 Post-mounted objects. A free-standing object mounted on a post or pylon shall not overhang that post or pylon more than 4 inches (~~102~~ 101.6 mm) where the lowest point of the leading edge is more than 27 inches (~~686~~ 685 mm) and less than 80 inches (2032 mm) above the walking surface. Where a sign or other obstruction is mounted between posts or pylons and the clear distance between the posts or pylons is greater than 12 inches (~~305~~ 304.8 mm), the lowest edge of such sign or obstruction shall be 27 inches (~~686~~ 685 mm) maximum or 80 inches (2032 mm) minimum above the finished floor or ground.

Exception: These requirements shall not apply to sloping portions of handrails between the top and bottom riser of stairs and above the ramp run.

1003.3.3 Horizontal projections. ~~Structural elements, fixtures or furnishings shall not project horizontally from either side~~ Objects with leading edges more than ~~4 inches (102 mm) over any walking surface between the heights of~~ 27 inches (~~686~~ 685 mm) and not more than 80 inches (2032) 2030 mm above the ~~walking surface~~ floor shall not project horizontally more than 4 inches (101.6 mm) into the circulation path.

Exception: Handrails are permitted to protrude ~~4.5~~ 4½ inches (~~114~~ 114.3 mm) from the wall.

1003.3.4 Clear width. Protruding objects shall not reduce the minimum clear width of accessible routes.

1003.4 Floor surface. Walking surfaces of the means of egress shall have a slip-resistant surface and be securely attached.

1003.5 Elevation change. Where changes in elevation of less than 12 inches (~~305~~ 304.8 mm) exist in the means of egress, sloped surfaces shall be used. Where the slope is greater than one unit vertical in 20 units horizontal (5-percent slope), ramps complying with Section ~~1010~~ 1012 shall be used. Where the difference in elevation is 6 inches (~~152~~ 152.4 mm) or less, the ramp shall be equipped with handrails or floor finish materials that contrast with adjacent floor finish materials.

Exceptions: At locations that are not required to be accessible by Chapter 11:

1. A single step with a maximum riser height of 7 inches (~~178~~ 177.8 mm) is permitted for buildings with occupancies in Groups F, H, R-2, R-3, S and U at exterior doors.

2. A step with a single riser or a stair with two risers and a tread is permitted ~~[provided that]~~ where the risers and treads comply with Section ~~[4009.4]~~ 1011.5, the minimum depth of the tread is 13 inches (330 mm) and ~~[at least]~~ not less than one handrail complying with Section ~~[4012]~~ 1014 is provided within 30 inches (762 mm) of the centerline of the normal path of egress travel on the step or stair.
3. A step is permitted in aisles serving seating that has a difference in elevation less than 12 inches (~~[305]~~ 304.8 mm) provided that the risers and treads comply with Section ~~[4028]~~ 1029.13 and the aisle is provided with a handrail complying with Section ~~[40288.13]~~ 1029.15.

Throughout a story in a Group I-2 occupancy, any change in elevation in portions of the ~~[exit access]~~ means of egress that serve nonambulatory persons shall be by means of a ramp or sloped walkway.

1003.6 Means of egress continuity. The path of egress travel along a means of egress shall not be interrupted by ~~[any]~~ a building element other than a means of egress component as specified in this chapter. Obstructions shall not be placed in the minimum width or required ~~[width]~~ capacity of a means of egress component except projections permitted by this chapter. The minimum width or required capacity of a means of egress system shall not be diminished along the path of egress travel.

1003.7 Elevators, escalators and moving walks. Elevators, escalators and moving walks shall not be used as a component of a required means of egress from any other part of the building.

Exceptions:

1. Elevators used as a component of an accessible means of egress in accordance with Section ~~[4007.4]~~ 1009.4.
2. Elevators permitted to be used for occupant self-evacuation pursuant to Sections 403.5.2 and 403.6.2.

**SECTION BC 1004
OCCUPANT LOAD**

1004.1 Design occupant load. In determining means of egress requirements, the number of occupants for whom means of egress facilities shall be provided shall be established by the largest number computed in accordance with Section ~~[4004.1.1]~~ 1004.1.3, unless otherwise permitted by Section ~~[4004.1.2]~~ 1004.1.3.1, ~~[4004.1.3]~~ 1004.1.3.2 or 1004.2. ~~[Where occupants from accessory areas egress through a primary space, the calculated occupant load for the primary space shall include the total occupant load of the primary space plus the number of occupants egressing through it from the accessory area.]~~

1004.1.1 Cumulative occupant loads. Cumulative occupant loads shall be determined in accordance with Sections 1004.1.1.1 and 1004.1.1.2.

1004.1.1.1 Cumulative occupant loads for interconnected spaces. Where the path of egress travel includes intervening rooms, areas or spaces, cumulative occupant loads shall be determined in accordance with this section.

1004.1.1.1.1 Intervening spaces or accessory areas. Where occupants egress from one or more rooms, areas or spaces through others, the design occupant load shall be the combined occupant load of interconnected accessory or intervening spaces. Design of egress path capacity shall be based on the cumulative portion of occupant loads of all rooms, areas or spaces to that point along the path of egress travel.

1004.1.1.1.2 Adjacent levels for mezzanines. That portion of the occupant load of a mezzanine with required egress through a room, area or space on an adjacent level shall be added to the occupant load of that room, area or space.

1004.1.1.1.3 Adjacent stories. Other than for the egress components designed for convergence in accordance with Section 1005.6, the occupant load from separate stories shall not be added.

1004.1.1.2 Cumulative occupant loads in Group R-2 occupancies. Rooms, areas or spaces that are accessory to a Group R-2 occupancy and that comply with the conditions below may have occupant loads calculated individually per room, area, or space, and be classified as Occupancy Group R-2.

1004.1.1.2.1 Maximum occupant load per room. The occupant load in each individual room, area and space, including those subject to Section 1004.1.1.1.1 where applicable, shall not exceed 74 persons.

1004.1.1.2.2 Separated rooms. Each individual room, area and space shall be separated from others by minimum 1-hour fire-resistance-rated fire barriers constructed in accordance with Section 707. Opening protectives in accordance with Exception 3 of Section 707.6 shall not be permitted.

1004.1.1.2.3 Group R-2 accessory spaces as primary function on a story. Where the aggregate Group R-2 occupancy accessory area of all rooms, areas or spaces, including outdoor spaces that are not provided with independent means of egress and that do not converge into interior means of egress, exceed 50 percent of the building area of the story in which they are located, and the total number of occupants on such story exceeds 150 persons, the following conditions shall apply:

1. The interior corridors or portions thereof serving such accessory spaces shall be constructed as public corridors in accordance with Table 1020.1.2 with 1-hour fire-resistance-rated fire barriers, and 2-hour fire-resistance-rated fire barriers where a dead-end corridor exceeds 40 feet (12 192 mm) in length;
2. Access to the corridors shall be limited to those necessary for exit access through the corridor from normally occupied spaces. Direct openings from the mechanical, electrical and other storage spaces shall not be permitted, except that access to the corridor may be provided through a vestibule constructed with fire barriers, with a

minimum fire-resistance rating consistent with the required hourly rating for the corridor;

3. Corridors or portions thereof serving such accessory spaces shall be sufficient to accommodate a total occupant load on the basis of 3 square feet (0.28 m²) per person;
4. The minimum dimension of such corridors shall be sufficient to accommodate the total occupant load discharging into such corridors, but shall in no case be less than 5 feet (1524 mm) in minimum dimension; and
5. In addition to Conditions 1 through 4 above, one of the following conditions shall be met:
 - 5.1. Each of the interior exit stairways and ramps serving such story shall be protected by a smokeproof enclosure in accordance with Section 909.20;
 - 5.2. The corridor or portions of the corridor serving the rooms, areas or spaces that are accessory to the Group R-2 occupancy shall be pressurized in accordance with requirements that are applicable to interior exit stairways. Connecting interior exit stairways need not be pressurized unless otherwise required by this code;
 - 5.3. All passenger elevators serving the rooms, areas, or spaces that are accessory to the Group R-2 occupancy shall comply with occupant self-evacuation elevator requirements in Section 3008.1 through 3008.11; or
 - 5.4. One additional exit stairway meeting the requirements of Sections 1009 and 1023 shall be provided in addition to the minimum number of exits required by Section 1006. The total width of any combination of remaining exit stairways with one exit stairway removed shall not be less than the total width required by Section 1005.3.

Rooms, areas or spaces that do not comply with the conditions in Sections 1004.1.1.2.1 and 1004.1.1.2.2, or Section 1004.1.1.2.3 where applicable, shall have occupant loads calculated cumulatively per story and be classified as Occupancy Group A.

1004.1.2 Multiple function occupant load. Where an area under consideration contains multiple functions having different occupant load factors, the design occupant load for such area shall be based on the floor area of each function calculated independently.

1004.1.3 Areas without fixed seating. The number of occupants shall be computed at the rate of one occupant per unit of area as prescribed in Table [4004.1.1] 1004.1.3. For areas without fixed seating, the occupant load shall be not [be] less than that number determined by dividing the floor area under consideration by the occupant [per unit of area] load factor assigned to the [functions] function of the space as set forth in Table [4004.1.1] 1004.1.3.

[1004.1.2] 1004.1.3.1 Modifications. Where the actual number of occupants of any space

will be significantly lower than listed in Table [1004.1.1] 1004.1.3, the commissioner may establish a lower basis for the determination of the number of occupants.

[1004.1.3] **1004.1.3.2 Unlisted functions.** Where data regarding the square feet area per person for a function is not listed in Table [1004.1.1] 1004.1.3, the occupant load shall be established by a registered design professional, subject to the approval of the commissioner.

**TABLE [1004.1.1] 1004.1.3
MAXIMUM FLOOR AREA ALLOWANCES PER OCCUPANT**

FUNCTION OF SPACE	[FLOOR AREA IN SQ. FT. PER OCCUPANT] OCCUPANT LOAD FACTOR ^a
<u>Accessory storage areas, mechanical equipment room</u>	300 gross
Agricultural building	300 gross
Aircraft hangars	500 gross
Assembly	
Gaming floors (keno, slots, etc.)	11 gross
Exhibit gallery and [museums] <u>museum</u>	30 net
Assembly with fixed seats	See Section [1004.7] 1004.3
Assembly without fixed seats	
Concentrated (chairs only – not fixed)	7 net
Dance floor	5 net
Dance floor (ballroom)	10 net
Standing space	5 net
Unconcentrated (tables and chairs)	15 net
Bowling centers, allow 5 persons for each lane including 15 feet of runway, and for additional areas	7 net
<u>Business areas, including accessory areas on terraces and rooftops</u>	100 gross ^{bd}
<u>Courtrooms – other than fixed seating areas</u>	40 net
Day Care:	
Age under 6 months	50 net
Age 6 months – 2 years	40 net
Age 2 years – 6 years	30 net
Age above 6 years	50 net
<u>Dormitories</u>	50 gross
Educational	
Classroom area	20 net
Shops and other vocational room areas	50 net
Kindergarten, and pre-kindergarten	30 net
Exercise rooms	50 gross
Gymnasiums	15 net
<u>Group H-5 Fabrication and manufacturing areas</u>	200 gross
Industrial areas	100 gross
Institutional areas	
Inpatient treatment areas	240 gross
Outpatient areas	100 gross
Sleeping areas	120 gross
<u>Kitchens, commercial</u>	200 gross
Library	
Reading rooms	50 net
Stack area	100 gross
Locker rooms	50 gross
<u>Mall buildings – covered and open</u>	See Section 402.8.2
Mercantile	
Areas on other floors	60 gross
Basement and grade floor areas	30 gross
Storage, stock, shipping areas	300 gross
Parking garages	200 gross

FUNCTION OF SPACE	[FLOOR AREA IN SQ. FT. PER OCCUPANT] OCCUPANT LOAD FACTOR ^a
Passenger terminal	
Baggage claim	20 gross
Baggage handling	300 gross
Concourse	100 gross
Passenger terminal or platform	1.5 X C*
Waiting area (Standing)	15 gross
Waiting areas (Seated)	5 net
Residential	
<u>Within dwelling units</u>	200 gross [within dwelling units]
<u>Rooftop and terrace accessory to Groups R-2 and R-3</u>	<u>200 gross</u> ^{b,c,d}
<u>Indoor residential amenity spaces accessory to Group R-2 (concentrated)^e</u>	<u>15 net</u>
<u>Indoor residential amenity spaces accessory to Group R-2 (unconcentrated)^e</u>	<u>50 net</u>
Skating rinks, swimming pools	
Rink and pool	50 gross
Decks	15 gross
Stages and platforms	15 net for performing area and 50 net remaining area
[Accessory storage areas, mechanical equipment room]	[300 gross]
Warehouses	500 gross

C*-capacity of all passenger vehicles that can be unloaded simultaneously.

For SI: 1 square foot = 0.0929 m², 1 foot = 304.8 mm.

a. Floor area in square feet per occupant.

b. For the purposes of occupant load calculation, permanent fixtures and amenities such as shrubs, decorative pools, non-walkable paving surfaces, etc. may be deducted from the total floor area.

c. A rooftop or terrace in Group R-2 or R-3 occupancies that is provided for the incidental, recreational use by the residential tenants residing in the same residential building.

d. Where the maximum occupant load of the rooftop or terrace exceeds 74 persons based on occupant load calculations, a Place of Assembly Certificate of Operation is required pursuant to Section 28-117.1 of the Administrative Code and Item 1 of Section 303.7 of this code.

e. To be used only when the occupant load for the function of the space is not listed elsewhere in Table 1004.1.3.

1004.2 Increased occupant load. The occupant load permitted in any building, or portion thereof, is permitted to be increased from that number established for the functions in Table [1004.1.1] 1004.1.3, provided that all other requirements of the code are also met based on such modified number and the occupant load shall not exceed one occupant per 5 square feet ([0.47] 0.46 m²) of occupiable floor space, except for safe areas as specified in Section 1029.19.3 and standee areas as specified in Section 1029.18. Where required by the commissioner, an approved aisle, seating or fixed equipment diagram substantiating any increase in occupant load shall be submitted. Where required by the commissioner, such diagram shall be posted. Capacity signs indicating the increased, stated occupant load in accordance with Sections 1029.1.3 and 1029.1.4 shall be posted where required by the commissioner.

~~[1004.3 Posting of occupant load. Every room or space that is an assembly occupancy shall have the occupant load of the room or space posted in a conspicuous place, near the main exit or exit access doorway from the room or space. Posted signs shall be of an approved legible permanent design and shall be maintained by the owner or authorized agent. Such sign shall also comply with Section 1028.1.2.]~~

~~[1004.4 Exiting from multiple levels. Where exits serve more than one floor, only the occupant load of each floor considered individually shall be used in computing the required capacity of the exits at that floor, provided that the exit capacity shall not decrease in the direction of egress travel.]~~

~~[1004.5 Egress convergence. Where means of egress from floors above and below converge at an intermediate level, the capacity of the means of egress from the point of convergence shall not be less than the sum of the two floors.]~~

~~[1004.6 Mezzanine levels. The occupant load of a mezzanine level with egress onto a room or area below shall be added to that room or area's occupant load, and the capacity of the exits shall be designed for the total occupant load thus established.]~~

~~[1004.7] **1004.3 Fixed seating.** For areas having fixed seats and aisles, the occupant load shall be determined by the number of fixed seats installed therein. The occupant load for areas in which fixed seating is not installed, such as waiting spaces ~~[and wheelchair spaces]~~, shall be determined in accordance with Section ~~[1004.1.1]~~ 1004.1.3 and added to the number of fixed seats.~~

The occupant load of wheelchair spaces and the associated companion seat shall be based on one occupant for each wheelchair space and one occupant for the associated companion seat provided in accordance with Section 1108.2.3.

For areas having fixed seating without dividing arms, the occupant load shall be not ~~[be]~~ less than the number of seats based on one person for each 18 inches (~~[457]~~ 457.2 mm) of seating length.

The occupant load of seating booths shall be based on one person for each 24 inches (~~[610]~~ 609.6 mm) of booth seat length measured at the backrest of the seating booth.

~~[1004.8] **1004.4 Outdoor areas.** Yards, patios, courts and similar outdoor areas accessible to and usable by the building occupants shall be provided with means of egress as required by this chapter. The occupant load of such outdoor areas shall be determined by the design professional subject to the approval of the commissioner. Where outdoor areas are to be used by persons in addition to the occupants of the building, and the path of egress travel from the outdoor areas passes through the building, means of egress requirements for the building shall be based on the sum of the occupant loads of the building plus the outdoor areas.~~

Exceptions:

1. Outdoor areas used exclusively for service of the building need only have one means of egress.
2. Both outdoor areas associated with Group R-3 and individual dwelling units of Group R-2.

~~[1004.9] **1004.5 Multiple occupancies.** Where a building contains two or more occupancies, the means of egress requirements shall apply to each portion of the building based on the occupancy of that space. Where two or more occupancies utilize portions of the same means of egress system, those egress components shall meet the more stringent requirements of all occupancies that are served.~~

SECTION BC 1005
MEANS OF EGRESS [WIDTH] SIZING

1005.1 General. All portions of the means of egress system shall be sized in accordance with this section.

Exception: Aisles and aisle accessways in rooms or spaces used for assembly purposes complying with Section 1029.

1005.2 Minimum [required egress] width based on component. The minimum width, in inches (mm), of any means of egress [width] components shall be not [be] less than that [required by this section] specified for such component, elsewhere in this code. [The total width of means of egress in inches (mm) shall not be less than the total occupant load served by the means of egress multiplied by 0.3 inches (7.62 mm) per occupant for stairways and by 0.2 inches (5.08 mm) per occupant for other egress components. The width shall not be less than specified elsewhere in this code. Multiple means of egress shall be sized such that the loss of any one means of egress shall not reduce the available capacity to less than 50 percent of the required capacity. The maximum capacity required from any story of a building shall be maintained to the termination of the means of egress.]

[**Exception:** Means of egress complying with Section 1028.]

1005.3 Required capacity based on occupant load. The required capacity, in inches (mm), of the means of egress for any room, area, space or story shall be not less than that determined in accordance with Sections 1005.3.1 and 1005.3.2.

1005.3.1 Stairways. The capacity, in inches, of means of egress stairways shall be calculated by multiplying the occupant load served by such stairways by a means of egress capacity factor of 0.3 inch (7.6 mm) per occupant. Where stairways serve more than one story, only the occupant load of each story considered individually shall be used in calculating the required capacity of the stairways serving that story.

Exceptions:

1. Facilities with smoke-protected assembly seating shall be permitted to use the capacity factors in Table 1029.6.2 indicated for stepped aisles for exit access or exit stairways where the entire path for means of egress from the seating to the exit discharge is provided with a smoke control system complying with Section 909.
2. Facilities with outdoor smoke-protected assembly seating shall be permitted to the capacity factors in Section 1029.6.3 indicated for stepped aisles for exit access or exit stairways where the entire path for means of egress from the seating to the exit discharge is open to the outdoors.

1005.3.2 Other egress components. The capacity, in inches, of means of egress components other than stairways shall be calculated by multiplying the occupant load served by such component by a means of egress capacity factor of 0.2 inch (5.1 mm) per occupant.

Exceptions:

1. Facilities with smoke-protected assembly seating shall be permitted to use the capacity factors in Table 1029.6.2 indicated for level or ramped aisles for means of egress components other than stairways where the entire path for means of egress from the seating to the exit discharge is provided with a smoke control system complying with Section 909.

2. Facilities with outdoor smoke-protected assembly seating shall be permitted to the capacity factors in Section 1029.6.3 indicated for level or ramped aisles for means of egress components other than stairways where the entire path for means of egress from the seating to the exit discharge is open to the outdoors.

1005.4 Continuity. The minimum width or required capacity of the means of egress required from any story of a building shall not be reduced along the path of egress travel until arrival at the public way.

1005.5 Distribution of minimum width and required capacity. Where more than one exit, or access to more than one exit, is required, the means of egress shall be configured such that the loss of any one exit, or access to one exit, shall not reduce the available capacity or width to less than 50 percent of the required capacity or width.

1005.6 Egress convergence. Where the means of egress from stories above and below converge at an intermediate level, the capacity of the means of egress from the point of convergence shall be not less than the largest minimum width or the sum of the required capacities for the stairways or ramps serving the two adjacent stories, whichever is larger.

1005.7 Encroachment. Encroachments into the required means of egress width shall be in accordance with the provisions of this section.

~~[1005.2 Door encroachment]~~ **1005.7.1 Doors.** Doors, when fully opened, [and handrails] shall not reduce the required [means of egress] width by more than 7 inches ([478] 177.8 mm). Doors in any position shall not reduce the required width by more than one-half.

Exceptions:

1. Surface-mounted latch release hardware shall be exempt from inclusion in the 7-inch (177.8 mm) maximum encroachment where both of the following conditions exist:
 - 1.1. The hardware is mounted to the side of the door facing away from the adjacent wall where the door is in the open position.
 - 1.2. The hardware is mounted not less than 34 inches (865 mm) nor more than 48 inches (1220 mm) above the finished floor.
2. The restrictions on door swing shall not apply to doors within individual dwelling units and sleeping units of Group R-2 occupancies and within individual dwelling units of Group R-3 occupancies.

1005.7.2 Other projections. Handrail projections shall be in accordance with the provisions of Section 1014.8. Other nonstructural projections such as trim and similar decorative features shall be permitted to project into the required width [a maximum of] not more than 1½ inches ([38] 38.1 mm) on each side.

Exception: ~~[The restrictions on a door swing shall not apply to doors within individual dwelling units and sleeping units of Group R-2 and dwelling units of Group R-3]~~ Projections are permitted in corridors within Group I-2 in accordance with Section 407.4.3.

[1005.3 Door hardware encroachment. Surface-mounted latch-release hardware shall be exempt from inclusion in the 7-inch (178 mm) maximum projection requirement of Section 1005.2 when:]

- [1. The hardware is mounted to the side of the door facing the corridor width when the door is in the open position; and]
- [2. The hardware is mounted not less than 34 inches (865 mm) or more than 48 inches (1220 mm) above the finished floor.]

1005.7.3 Protruding objects. Protruding objects shall comply with the applicable requirements of Section 1003.3.

**SECTION BC 1006
NUMBER OF EXITS AND EXIT ACCESS DOORWAYS**

1006.1 General. The number of exits or exit access doorways required within the means of egress system shall comply with the provisions of Section 1006.2 for spaces, including mezzanines, and Section 1006.3 for stories.

1006.2 Egress from spaces. Rooms, areas or spaces, including mezzanines, within a story or basement shall be provided with the number of exits or access to exits in accordance with this section.

1006.2.1 Egress based on occupant load and common path of egress travel distance. Two exits or exit access doorways from any space shall be provided where the design occupant load or the common path of egress travel distance exceeds the values listed in Table 1006.2.1.

Exception: Care suites in Group I-2 occupancies complying with Section 407.4.

**TABLE 1006.2.1
SPACES WITH ONE EXIT OR EXIT ACCESS DOORWAY**

<u>OCCUPANCY</u>	<u>MAXIMUM OCCUPANT LOAD OF SPACE</u>	<u>MAXIMUM COMMON PATH OF EGRESS TRAVEL DISTANCE (feet)</u>		
		<u>Without Sprinkler System (feet)</u>		<u>With Sprinkler System (feet)</u>
		<u>Occupant Load</u>		
		<u>OL ≤ 30</u>	<u>OL > 30</u>	
A ^c , E ^f , M	74	75	75	75 ^a
B	74	100	75	100 ^a
E	49	75	75	100 ^a
H-1, H-2, H-3	3	NP	NP	25 ^b
H-4 ^b , H-5 ^b , I-1, I-3, I-4	10	NP	NP	75 ^a
I-2 ^d	See Section 407	NP	NP	75 ^a
R-1	20	NP	NP	75 ^a
R-2	20 ^g	NP	NP	125 ^a
S	29	100	75 ^c	100 ^a
U	74	100	75	75 ^a

For SI: 1 foot = 304.8 mm.

NP = Not Permitted.

- a. Buildings equipped throughout with an automatic sprinkler system in accordance with Section 903.3.1.1 or 903.3.1.2. See Section 903 for occupancies where automatic sprinkler systems are permitted in accordance with Section 903.3.1.2.
- b. Group H occupancies equipped throughout with an automatic sprinkler system in accordance with Section 903.2.5.
- c. For a room or space used for assembly purposes having fixed seating, see Section 1029.8.
- d. For the travel distance limitations in Group I-2, see Section 407.4.

- e. The length of common path of egress travel distance in a Group S-2 open parking garage shall be not more than 100 feet (30 480 mm).
- f. Day care maximum occupant load is 10.
- g. Rooms, areas, or spaces that are accessory to a Group R-2 occupancy may have a maximum occupant load of 49.

1006.2.1.1 Three or more exits or exit access doorways. Three exits or exit access doorways shall be provided from any space with an occupant load of 501 to 1,000. Four exits or exit access doorways shall be provided from any space with an occupant load greater than 1,000.

1006.2.2 Egress based on use. The numbers of exits or access to exits shall be provided in the uses described in Sections 1006.2.2.1 through 1006.2.2.5.

1006.2.2.1 Boiler, incinerator and furnace rooms. Two exit access doorways are required in boiler, incinerator and furnace rooms where the area is over 500 square feet (46.5 m²) and any fuel-fired equipment exceeds 400,000 British thermal units (Btu) (422 000 KJ) input capacity. Where two exit access doorways are required, one such doorway is permitted to be served by a fixed ladder or an alternating tread device. Exit access doorways shall be separated by a horizontal distance equal to one-half the length of the maximum overall diagonal dimension of the room.

1006.2.2.2 Refrigeration machinery rooms. Machinery rooms larger than 1,000 square feet (92.9 m²) with refrigeration units or systems having a refrigerant circuit containing more than 220 pounds (100 kg) of Group A1 refrigerant, or more than 30 pounds (13.6 kg) of any other group refrigerant, as classified in Section 1103.1 of the *New York City Mechanical Code*, shall have not less than two exits or exit access doors. Where two exit access doorways are required, one such doorway is permitted to be served by a fixed ladder or an alternating tread device. Exit access doorways shall be separated by a horizontal distance equal to one-half the maximum horizontal dimension of the room.

All portions of machinery rooms shall be within 150 feet (45 720 mm) of an exit or exit access doorway. An increase in exit access travel distance is permitted in accordance with Section 1017.1.

Doors shall swing in the direction of egress travel and shall be equipped with panic hardware, regardless of the occupant load served. Doors shall be tight fitting and self-closing.

1006.2.2.3 Refrigerated rooms or spaces. Rooms or spaces having a floor area larger than 1,000 square feet (92.9 m²) containing a refrigerant evaporator and maintained at a temperature below 68°F (20°C), shall have access to not less than two exits or exit access doorways.

Exit access travel distance shall be determined as specified in Section 1017.1, but all portions of a refrigerated room or space shall be within 150 feet (45 720 mm) of an exit or exit access doorway where such rooms are not protected by an approved automatic sprinkler system. Egress is allowed through adjoining refrigerated rooms or spaces.

Exception: Where using refrigerants in quantities limited to the amounts based on the volume set forth in the *New York City Mechanical Code*.

1006.2.2.4 Day care means of egress. Day care facilities, rooms or spaces that are classified under Occupancy Group E providing care for more than 10 children shall have access to not less than two exits or exit access doorways.

1006.2.2.5 Vehicular ramps. Vehicular ramps shall not be considered as an exit access ramp unless provided with pedestrian facilities along the ramp in accordance with Section 1012.1.

1006.3 Egress from stories or occupied roofs. The means of egress system serving any story, or occupied roof designed for human occupancy or use, shall be provided with the number of exits or access to exits based on the aggregate occupant load served in accordance with this section. The path of egress travel to an exit shall not pass through more than one adjacent story.

Each story or occupied roof designed for human occupancy or use above the second story of a building shall have not less than one interior or exterior exit stairway, or interior or exterior exit ramp. Where three or more exits or access to exits are required, not less than 50 percent of the required exits shall be interior or exterior exit stairways or ramps.

Exceptions:

1. Interior exit stairways and interior exit ramps are not required in open parking garages where the means of egress serves only the open parking garage.
2. Interior exit stairways and interior exit ramps are not required in outdoor facilities where all portions of the means of egress are essentially open to the outside.

1006.3.1 Egress based on occupant load. Each story or occupied roof designed for human occupancy or use shall have the minimum number of exits, or access to exits, as specified in Table 1006.3.1. A single exit or access to a single exit shall be permitted in accordance with Section 1006.3.2. The required number of exits, or exit access stairways or ramps providing access to exits, from any such story or occupied roof shall be maintained until arrival at the exit discharge or a public way.

TABLE 1006.3.1
MINIMUM NUMBER OF EXITS OR ACCESS TO EXITS PER STORY

<u>OCCUPANT LOAD</u> <u>(persons per story)</u>	<u>MINIMUM NUMBER OF</u> <u>EXITS</u> <u>(per story)</u>
<u>1-500</u>	<u>2</u>
<u>501-1,000</u>	<u>3</u>
<u>More than 1,000</u>	<u>4</u>

1006.3.2 Single exits. A single exit or access to a single exit shall be permitted from any story or occupied roof designed for human occupancy or use where one of the following conditions exists:

1. The occupant load, number of dwelling units and exit access travel distance do not exceed the values in Table 1006.3.2.

2. Rooms, areas and spaces complying with Section 1006.2.1 with exits that discharge directly to the exterior at the level of exit discharge are permitted to have one exit or access to a single exit.
3. Open or enclosed parking garages where vehicles are mechanically parked shall be permitted to have one exit provided such exit shall not be a vehicle ramp.
4. Group R-3 occupancies shall be permitted to have one exit or access to a single exit.
5. Individual single-story or multistory dwelling units shall be permitted to have a single exit or access to a single exit from the dwelling unit provided that both of the following criteria are met:
 - 5.1. The dwelling unit complies with Section 1006.2.1 as a space with one means of egress.
 - 5.2. Either the exit from the dwelling unit discharges directly to the exterior at the level of exit discharge, or the exit access outside the dwelling unit's entrance door provides access to not less than two approved independent exits.
6. Buildings of Occupancy Group R-2 where all of the following conditions are met:
 - 6.1. The building does not exceed four stories;
 - 6.2. The building contains not more than three dwelling units per story;
 - 6.3. The building is of construction Type I or II;
 - 6.4. The building does not exceed 2,500 square feet (232.3 m²) per story;
 - 6.5. Each dwelling unit has at least one window facing the street, or facing a lawful yard with open, unobstructed, and direct access to the street. Such yard or direct access shall be a minimum width equal to 25 percent of the vertical distance from the windowsill of the highest operable window, facing such yard or direct access, to the grade of such yard or direct access directly below such window, but shall in no case be less than 36 inches (914.4 mm) wide;
 - 6.6. The stairway extends to the roof surface through a stairway bulkhead complying with Section 1509.2, provided the roof has a slope not steeper than 20 degrees (0.35 rad), or the stairway is constructed against the street wall, with one window facing the street at each landing and access to the roof is provided via a scuttle with a stationary, noncombustible access ladder;
 - 6.7. The stairway is enclosed in 2-hour fire-rated walls with all exit doors leading into the stairway having at least 1½-hour fire rating; and
 - 6.8. The building is equipped throughout with an automatic sprinkler system in accordance with Section 903.3.1.2.

7. Buildings of Occupancy Group R-2 of construction Type I or II not exceeding six stories and not exceeding 2,000 square feet (185.8 m²) per story.

TABLE 1006.3.2
STORIES WITH ONE EXIT OR ACCESS TO ONE EXIT

<u>STORY</u>	<u>OCCUPANCY</u>	<u>MAXIMUM OCCUPANT LOAD PER FLOOR</u>	<u>MAXIMUM TRAVEL DISTANCE (feet)</u>
First story above grade plane or cellar ^f	<u>A, B^b, E^c, F^b, M, U, S^b</u>	<u>49</u>	<u>75</u>
	<u>H-2, H-3</u>	<u>3</u>	<u>25</u>
	<u>H-4, H-5, I, R^c</u>	<u>10</u>	<u>75</u>
	<u>S^a</u>	<u>29</u>	<u>100</u>
Second story above grade plane	<u>B, F, M, S^a</u>	<u>29</u>	<u>75</u>
	<u>R-2^{d,e}</u>	<u>NA</u>	<u>50</u>
Third story above grade plane	<u>R-2^{d,e}</u>	<u>NA</u>	<u>50</u>

For SI: 1 foot = 304.8 mm.

NP = Not Permitted.

NA = Not Applicable.

- a. For the required number of exits for open or enclosed parking garages, see Section 1006.3.2, Item 3.
- b. Group B, F and S occupancies in buildings equipped throughout with an automatic sprinkler system in accordance with Section 903.3.1.1 shall have a maximum travel distance of 100 feet.
- c. Day care occupancies shall have a maximum occupant load of 10.
- d. Maximum four dwelling units per floor.
- e. Buildings classified as Occupancy Group R-2 equipped throughout with an automatic sprinkler system in accordance with Section 903.3.1.1 or 903.3.1.2 and provided with emergency escape and rescue openings in accordance with Section 1030.
- f. Limited to the cellar closest to grade plane.

1006.3.2.1 Mixed occupancies. Where one exit, or exit access stairway or ramp providing access to exits at other stories, is permitted to serve individual stories, mixed occupancies shall be permitted to be served by single exits provided each individual occupancy complies with the applicable requirements of Table 1006.3.2 for that occupancy. Where applicable, cumulative occupant loads from adjacent occupancies shall be considered in accordance with the provisions of Section 1004.1. In each story of a mixed occupancy building, the maximum number of occupants served by a single exit shall be such that the sum of the ratios of the calculated number of occupants of the space divided by the allowable number of occupants indicated in Table 1006.3.2 for each occupancy does not exceed one. Where dwelling units are located on a story with other occupancies, the actual number of dwelling units divided by four plus the ratio from the other occupancy does not exceed one.

1006.4 Open or enclosed parking garages. Open or enclosed parking garages shall not have less than two exits from each parking tier. An unenclosed vehicle ramp constructed in accordance with Section 1012.1 may serve as one of the required exits when provided with pedestrian facilities along the ramp. Such ramps serving as part of a nonaccessible means of egress in open or enclosed parking garages three stories or less in height and serving not more than one level below grade is permitted to comply with Section 1012.2, Exception 2.

Exception: One exit shall be permitted in parking garages complying with Item 3 of Section 1006.3.2.

SECTION BC 1007
EXIT AND EXIT ACCESS DOORWAY CONFIGURATION

1007.1 General. Exits, exit access doorways, and exit access stairways and ramps serving spaces, including individual building stories, shall be separated in accordance with the provisions of this section.

1007.1.1 Two exits or exit access doorways. Where two exits, exit access doorways, exit access stairways or ramps, or any combination thereof, are required from any portion of the exit access, they shall be placed a distance apart equal to not less than one-half of the length of the maximum overall diagonal dimension of the building or area to be served measured in a straight line between them. Stairs sharing any common wall, floor, ceiling, scissor stair assembly, or other enclosure shall be counted as one exit stairway.

Exceptions:

- 1. Corridor measurements.** Where interior exit stairways or ramps are interconnected by a 1-hour fire-resistance-rated corridor conforming to the requirements of Section 1020, the required exit separation shall be measured along the shortest direct line of travel within the corridor.
- 2. Remote location in sprinklered buildings.** Where a building is equipped throughout with an automatic sprinkler system in accordance with Section 903.3.1.1 or 903.3.1.2, the separation distance shall be not less than one-third of the length of the maximum overall diagonal dimension of the area served.
- 3. Group R-2 occupancies.** In Group R-2 occupancies, where stairs are enclosed in walls having at least a 2-hour fire resistance rating and constructed of masonry or masonry equivalent in accordance with department rules:
 - 3.1.** The exit doors to such stairs shall be placed a distance apart equal to no less than 15 feet (4572 mm); and
 - 3.2.** Such stairs shall be permitted to share common walls, floors, ceilings or scissor stairs assemblies or other enclosures provided that the construction separating the stairs is also of at least a 2-hour fire-resistance rating and constructed of masonry or masonry equivalent in accordance with department rules.
- 4. Group B occupancies.** In Group B occupancies of construction Type I or II not exceeding 60 feet (18 288 mm) in height, not exceeding 2,000 square feet (185.8 m²) on any story and not exceeding a travel distance of 50 feet (15 240 mm) on any story, where stairs are enclosed in walls having at least a 2-hour fire-resistance rating and constructed of masonry or masonry equivalent in accordance with department rules:
 - 4.1.** The exit doors to such stairs shall be placed a distance apart equal to no less than 15 feet (4572 mm); and

4.2. Such stairs shall be permitted to share common walls, floors, ceilings or scissor stairs assemblies.

1007.1.1.1 Measurement point. The separation distance required in Section 1007.1.1 shall be measured in accordance with the following:

1. The separation distance to exit or exit access doorways shall be measured to the center point of the required doorway.
2. The separation distance to exit access stairways shall be measured to the center point of the closest riser.
3. The separation distance to exit access ramps shall be measured to the center point of the start of the ramp run.

1007.1.2 Three or more exits or exit access doorways. Where access to three or more exits is required, not less than two exit or exit access doorways shall be arranged in accordance with the provisions of Section 1007.1.1. Additional required exit or exit access doorways shall be arranged a reasonable distance apart so that if one becomes blocked, the others will be available.

1007.1.3 Remoteness of exit access stairways or ramps. Where two exit access stairways or ramps provide the required means of egress to exits at another story, the required separation distance shall be maintained for all portions of such exit access stairways or ramps.

1007.1.3.1 Three or more exit access stairways or ramps. Where more than two exit access stairways or ramps provide the required means of egress, not less than two shall be arranged in accordance with Section 1007.1.3.

SECTION BC [~~1006~~] 1008 **MEANS OF EGRESS ILLUMINATION**

[~~1006.4~~] 1008.1 Means of egress illumination. Illumination shall be provided in the means of egress in accordance with Section 1008.2. Under emergency power, means of egress illumination shall comply with Section 1008.3.

1008.2 Illumination required. Exits, exit discharges and public corridors shall be illuminated at all times by either daylight or electric lighting fixtures. Exit access components shall be illuminated by either daylight or electric lighting fixtures at all times that the space served by the exit access component is occupied.

Exceptions:

1. Occupancies in Group U.
2. Aisle accessways in Group A.
3. Dwelling units and sleeping units in Groups I-1, R-1, R-2 and R-3.
4. Sleeping units of Group I occupancies.

5. Areas beyond safe dispersal area where such areas are provided, and designed in accordance with Section ~~[1027.6]~~ 1028.5, Exceptions 1 through 5.

~~[1006.2]~~ **1008.2.1 Illumination level under normal power.** The means of egress illumination level shall be not [be] less than 1 [foot-candle] footcandle (11 lux) at the walking surface.

Exceptions:

1. For auditoriums, theaters, concert or opera halls and similar assembly occupancies, the ~~[illumination at the]~~ externally illuminated walking surface is permitted to be reduced during performances to not less than 0.5 ~~[foot-candle]~~ footcandle (5.38 lux) for aisles and cross aisles, and 0.2 ~~[foot-candle]~~ footcandle (2.15 lux) for other portions of the space, provided that the required illumination is automatically restored upon activation of a premise's fire alarm system where such system is provided. ~~[Step lights shall be provided in accordance with Section 1028.11.4.]~~
2. Safe areas in assembly occupancies shall be illuminated in accordance with Section ~~[1028.17.3.2]~~ 1029.19.3.2.
3. Open exterior spaces used to receive occupants as Class 1 or 2 exits in assembly occupancies shall be illuminated in accordance with Section ~~[1028.17.4]~~ 1029.19.4.
4. In exits in buildings that contain existing photoluminescent exit path markings tested in laboratory conditions with 2 ~~[foot-candles]~~ footcandles (22 lux) of activating illumination, the illumination level shall not be less than 2 ~~[foot-candles]~~ footcandles (22 lux).

1008.2.2 Exit discharge. In Group I-2 occupancies where two or more exits are required, on the exterior landings required by Section 1010.1.6, means of egress illumination levels for the exit discharge shall be provided such that failure of any single lighting unit shall not reduce the illumination level on that landing to less than 1 footcandle (11 lux).

~~[1006.2.1]~~ **1008.2.3 Sensors and controls.** Automatic, occupant sensor or photosensor lighting controls shall be permitted within means of egress, provided that the illumination level is not reduced to a level below the minimum requirements of Section ~~[1006.2]~~ 1008.2.1, and the switch controllers are equipped for fail-safe operation ensuring that if the sensor or control fails, the lighting levels will be at the levels required by Section ~~[1006.2]~~ 1008.2.1.

~~[1006.3 Illumination emergency power]~~ **1008.3 Emergency power for illumination.** The power supply for means of egress illumination shall normally be provided by the premise's electrical supply.

1008.3.1 Rooms and spaces that require two or more means of egress. In the event of power supply failure in rooms and spaces that require two or more means of egress, an emergency electrical system shall automatically illuminate all of the following areas:

1. Aisles.
2. Corridors.

3. Exit access stairways and ramps.
4. Safe areas in assembly occupancies where required by Section 1029.19.3.2.

1008.3.2 Buildings that require two or more means of egress. In the event of power supply failure in buildings that require two or more means of egress, an emergency electrical system shall automatically illuminate all of the following areas:

1. [~~Aisles and unenclosed egress~~] Interior exit access stairways [~~in rooms and spaces that require two or more means of egress~~] and ramps.
2. [~~Corridors, exit enclosures and exit passageways.~~] Interior and exterior exit stairways and ramps.
3. [~~Exterior egress components at other than their levels of exit discharge until exit discharge is accomplished for buildings required to have two or more exits.~~] Exit passageways.
4. [~~Interior exit~~] Vestibules and areas on the level of discharge [~~elements, as permitted in Section 1027.1, in buildings required to have two or more exits~~] used for exit discharge in accordance with Section 1028.1.
5. Exterior landings as required by Section [~~1008.1.6~~] 1010.1.6 for exit [~~discharge~~] doorways [~~in buildings required~~] that lead directly to [~~have two or more exits~~] the exit discharge.

1008.3.3 Specific rooms and spaces. In the event of power supply failure, an emergency electrical system shall automatically illuminate all of the following areas:

1. Electrical equipment rooms containing electrical point of entry or building service disconnect.
2. Fire command centers.
3. Fire pump rooms.
4. Generator rooms.
5. Public restrooms with an area greater than 300 square feet (27.8 m²).

~~[1006.3.1 Emergency power source.]~~ **1008.3.4 Duration.** The emergency power system shall provide power for a duration of not less than 90 minutes and shall consist of storage batteries, unit equipment or an on-site generator. The installation of the emergency power system shall be in accordance with [~~Chapter 27~~] Section 2702.

~~[1006.3.2]~~ **1008.3.5 [Performance of system] Illumination level under emergency power.** Emergency lighting facilities shall be arranged to provide initial illumination that is [~~at least~~] not less than an average of 1 [~~foot-candle~~] footcandle (11 lux) and a minimum at any point of 0.1 [~~foot-candle~~] footcandle (1 lux) measured along the path of egress at floor level. Illumination levels shall be permitted to decline to 0.6 [~~foot-candle~~] footcandle [~~(6.46 lux)~~] (6 lux) average and a minimum at any point of 0.06 [~~foot-candle~~] footcandle [~~(0.646 lux)~~] (0.6 lux) at the end of

the emergency lighting time duration. A maximum-to-minimum illumination uniformity ratio of 40 to 1 shall not be exceeded. In buildings that contain existing photoluminescent exit path markings tested in laboratory conditions with greater than 1 ~~[foot-candle]~~ footcandle (11 lux) of activating, the initial illumination shall not be less than that required for activating the approved photoluminescent illumination. In Group I-2 occupancies, failure of any single lighting unit shall not reduce the illumination level to less than 0.2 footcandle (2.2 lux).

[1006.4 Reserved.]

SECTION BC ~~[1007]~~ 1009 ACCESSIBLE MEANS OF EGRESS

[1007.1] 1009.1 Accessible means of egress required. Accessible means of egress shall comply with this section. Accessible spaces shall be provided with not less than one accessible means of egress. Where more than one means of egress are required by Section ~~[1015.1]~~ 1006.2 or ~~[1021.1]~~ 1006.3 from any accessible space, each accessible portion of the space shall be served by not less than two accessible means of egress.

Exceptions:

1. Accessible means of egress are not required in alterations to prior code buildings where the level of alterations does not trigger full compliance of accessibility pursuant to Section 28-101.4 of the *Administrative Code*.
2. One accessible means of egress is required from an accessible mezzanine level in accordance with Section ~~[1007.3]~~ 1009.3, ~~[1007.4]~~ 1009.4 or ~~[1007.5]~~ 1009.5.
3. In assembly areas with ~~[sloped]~~ ramped aisles or stepped aisles, one accessible means of egress is permitted where the common path of egress travel is accessible and meets the requirements in Section ~~[1028.8]~~ 1029.8.

[1007.2] 1009.2 Continuity and components. Each required accessible means of egress shall be continuous to a public way and shall consist of one or more of the following components:

1. Interior accessible routes complying with Section 1104.
2. Area of rescue assistance complying with Section ~~[1007.6]~~ 1009.6.
3. Interior exit stairways complying with Sections ~~[1007.3]~~ 1009.3 and ~~[1022.1]~~ 1023.
4. Exit access stairways complying with Sections 1009.3 and 1019.3 or 1019.4.
- ~~[4.]~~ 5. Exterior exit stairways complying with Sections ~~[1007.3]~~ 1009.3 and ~~[1026]~~ 1027 and serving levels other than the level of exit discharge.
- ~~[5.]~~ 6. Elevators complying with Section ~~[1007.4]~~ 1009.4.
- ~~[6.]~~ 7. Platform lifts complying with Section ~~[1007.5]~~ 1009.5.

- [7.] 8. Horizontal exits complying with Section [4025] 1026.
 - [8.] 9. Ramps complying with Section [4040] 1012.
 - [9.] 10. Exit discharges complying with Section [4027] 1028.
 - [40.] 11. Exterior accessible routes complying with Section 1104.
 - [41.] 12. Exterior areas for assisted rescue complying with Section [4007.7] 1009.7 serving exits at the level of exit discharge.
13. Unenclosed vertical exits serving safe areas in assembly occupancies permitted by Section 1029.19.3.1.

[1007.2.1] 1009.2.1 High-rise buildings. In high-rise buildings subject to Section 403, at least one required accessible means of egress shall be an elevator complying with Section [4007.4] 1009.4.

Exceptions:

1. In buildings equipped throughout with an automatic sprinkler system installed in accordance with Section 903.3.1.1 or 903.3.1.2, the elevator shall not be required on floors provided with a horizontal exit and located at or above the level of exit discharge.
2. In buildings equipped throughout with an automatic sprinkler system installed in accordance with Section 903.3.1.1 or 903.3.1.2, the elevator shall not be required on floors provided with a ramp conforming to the provisions of Section [4040] 1012.
3. In buildings of [~~occupancy~~] Occupancy Group R-2 not subject to the requirements of emergency power in Section 403[~~of this code~~].

[1007.2.2] 1009.2.2 Exit discharge. Where an exit discharge is not accessible, an exterior area for assisted rescue shall be provided in accordance with Section [4007.7] 1009.7. An exterior area for assisted rescue shall not be required where an exit discharge is on an assisted rescue path from a stairway or an elevator.

[1007.2.3] 1009.2.3 Exterior exit stairway. Where an exit stairway is open to the exterior, the accessible means of egress shall include either an area of rescue assistance in accordance with Section [4007.6] 1009.6 or an exterior area for assisted rescue in accordance with Section [4007.7] 1009.7.

[1007.3 Exit stairways] 1009.3 Stairways. To be considered part of an accessible means of egress, [~~an exit access~~] a stairway [~~as permitted by Section 1016.1 or exit stairway~~] between stories shall have a clear width of 48 inches [~~(1219 mm)~~](1220 mm) minimum between handrails and shall either incorporate an area of rescue assistance within an enlarged floor-level landing or shall be accessed from [~~either~~] an area of rescue assistance complying with Section [4007.6 ~~or a horizontal exit~~] 1009.6. Exit access stairways that connect levels in the same story are not permitted as part of an accessible means of egress.

~~[Unenclosed exit stairways as permitted by Section 1022.1 are permitted to be considered part of an accessible means of egress.]~~

Exceptions: The following exceptions apply to the requirements of clear width and area of rescue assistance, and do not supersede the other requirements of the accessible means of egress:

1. ~~[The area of rescue assistance is not required for open exit access or exit stairways as permitted by Sections 1016.1 and 1022.1 in buildings that are equipped throughout with an automatic sprinkler system installed in accordance with Section 903.3.1.1 or 903.3.1.2]~~ Exit access stairways providing means of egress from mezzanines are permitted as part of an accessible means of egress.
2. The clear width of 48 inches (~~[1219]~~ 1220 mm) between handrails and the area of rescue assistance is not required at exit access stairways as permitted by Section ~~[1016.1]~~ 1017 or exit stairways in buildings equipped throughout with an automatic sprinkler system installed in accordance with Section 903.3.1.1 or 903.3.1.2.
3. ~~[Areas of rescue assistance are not required at exit stairways in buildings equipped throughout with an automatic sprinkler system installed in accordance with Section 903.3.1.1 or 903.3.1.2.]~~
- ~~[4.]~~ The clear width of 48 inches (~~[1219]~~ 1220 mm) between handrails is not required for ~~[enclosed]~~ interior exit stairways accessed from a refuge area in conjunction with a horizontal exit.
4. Areas of rescue assistance are not required at exit access stairways where two-way communication is provided at the elevator landing in accordance with Section 1009.8.
5. Areas of rescue assistance are not required at stairways in buildings equipped throughout with an automatic sprinkler system installed in accordance with Section 903.3.1.1 or 903.3.1.2.
- ~~[5.]~~ 6. Areas of rescue assistance are not required at ~~[exit]~~ stairways serving open parking garages.
- ~~[6.]~~ 7. Areas of rescue assistance are not required for ~~[smoke-protected]~~ smoke-protected assembly seating areas complying with Section ~~[1028.6.2]~~ 1029.6.2.
- ~~[7.]~~ 8. ~~[The areas]~~ Areas of rescue assistance are not required in Group R-2 occupancies.
9. Areas of rescue assistance are not required for stairways accessed from a refuge area in conjunction with a horizontal exit.

~~[1007.4]~~ **1009.4 Elevators.** To be considered part of an accessible means of egress, an elevator shall comply with the emergency operation and signaling device requirements of Section 2.27 of ASME A17.1 as modified by Appendix K, and Section ~~[1109.6]~~ 1109.7 of this code. Standby power shall be provided in accordance with Chapter 27 and Section 3003. The elevator shall be accessed from ~~[either]~~ an area of rescue assistance complying with Section ~~[1007.6 or a horizontal exit complying with Section 1025]~~ 1009.6.

Exceptions:

1. ~~[Elevators]~~ Areas of rescue assistance are not required ~~[to be accessed from an area of rescue assistance or horizontal exit]~~ at the elevator in open parking garages.
2. ~~[Elevators]~~ Areas of rescue assistance are not required ~~[to be accessed from an area of rescue assistance or horizontal exit]~~ in buildings and facilities equipped throughout with an automatic sprinkler system installed in accordance with Section 903.3.1.1 or 903.3.1.2.
3. ~~[Elevators]~~ Areas of rescue assistance are not required at elevators not required to be located in a shaft in accordance with Section ~~[708.2 are not required to be accessed from an area of rescue assistance or horizontal exit]~~ 712.
4. ~~[Elevators]~~ Areas of rescue assistance are not required ~~[to be accessed from an area of rescue assistance or horizontal exit for smoke]~~ at elevators serving smoke-protected assembly seating areas complying with Section ~~[4028.6.2]~~ 1029.6.2.
5. Areas of rescue assistance are not required for elevators accessed from a refuge area in conjunction with a horizontal exit.

~~[1007.5]~~ **1009.5 Platform lifts.** Platform (wheelchair) lifts shall ~~[not]~~ be permitted to serve as part of an accessible means of egress ~~[, except]~~ where allowed as part of a required accessible route in Section ~~[1109.7]~~ 1109.8, except for Item 10. Platform lifts shall be installed in accordance with ASME A18.1. Standby power for the platform lift shall be provided in accordance with Chapter 27 for platform lifts permitted to serve as part of an accessible means of egress.

~~[1007.5.1]~~ **1009.5.1 Openness.** Platform lifts on an accessible means of egress shall not be installed in a fully enclosed hoistway.

~~[1007.6]~~ **1009.6 Areas of rescue assistance.** Every required area of rescue assistance shall be accessible from the space it serves by one or more accessible means of egress components as listed in Section ~~[1007.2]~~ 1009.2.

1009.6.1 Travel distance. The maximum travel distance from any accessible space to an area of rescue assistance shall not exceed the exit access travel distance permitted for the occupancy in accordance with Section ~~[1016.1]~~ 1017.1.

1009.6.2 Stairway or elevator access. Every required area of rescue assistance shall have direct access to a stairway ~~[within an exit enclosure]~~ complying with Sections ~~[1007.3]~~ 1009.3 and ~~[1022]~~ 1023, or an elevator complying with Section ~~[1007.4]~~ 1009.4.

1009.6.2.1 Elevator lobby. Where an elevator lobby ~~[is used]~~ serves as an area of rescue assistance, the shaft and lobby shall comply with Section ~~[1022.9 for smokeproof enclosures except where the elevators are in an area of rescue assistance, such lobby shall be part of a horizontal exit or protected by a smoke barrier]~~ 713.14 and Chapter 30.

[Exceptions:]

~~[1. A stairway serving an area of rescue assistance is not required to be enclosed where permitted in Sections 1016.1 and 1022.1.]~~

~~[2. Smokeproof enclosure is not required for an elevator lobby used as an area of rescue assistance where the elevator is not required to be enclosed.]~~

[1007.6.1] 1009.6.3 Size. Each area of rescue assistance shall be sized to accommodate one wheelchair space of 30 inches by 48 inches (762 mm by ~~[1219]~~ 1220 mm) for each 200 occupants or portion thereof, based on the occupant load of the area of rescue assistance and areas served by the area of rescue assistance. Such wheelchair spaces shall not reduce the ~~[required]~~ means of egress minimum width or required capacity. Access to any of the required wheelchair spaces in an area of rescue assistance shall not be obstructed by more than one adjoining wheelchair space.

[1007.6.2] 1009.6.4 Separation. Each area of rescue assistance shall be separated from the remainder of the story by a smoke barrier complying with Section ~~[710]~~ 709 or a horizontal exit complying with Section ~~[1025]~~ 1026. Each area of rescue assistance shall be designed to minimize the intrusion of smoke.

[Exception:] Exceptions:

1. Areas of rescue assistance located within an ~~[exit]~~ enclosure for interior exit stairways complying with Section 1023.
2. Areas of rescue assistance in outdoor facilities where exit access is essentially open to the outside.

[1007.6.3] 1009.6.5 Two-way communication. Areas of rescue assistance shall be provided with a two-way communication system complying with Sections ~~[1007.8.1]~~ 1009.8.1 and ~~[1007.8.2]~~ 1009.8.2.

[1007.7] 1009.7 Exterior ~~[area]~~ areas for assisted rescue. ~~[The exterior area]~~ Exterior areas for assisted rescue ~~[must be open to the outside air and meet the requirements of Section 1007.6.1. Separation walls shall comply with the requirements of Section 705 for exterior walls]~~ shall be accessed by an accessible route from the area served.

~~Where ~~[walls or openings are between the area for assisted rescue and the interior of the building, the building exterior walls within 10 feet (3048 mm) horizontally of a nonrated wall or unprotected opening shall have a fire resistance rating of not less than 1 hour. Openings within such exterior walls shall be protected by opening protectives having a fire protection rating of not less than ¾ hour. This construction shall extend vertically from the ground to a point 10 feet (3048 mm) above the floor level of the area for assisted rescue or to the roof line, whichever is lower]~~ the exit discharge does not include an accessible route from an exit located on the level of exit discharge to a public way, an exterior area of assisted rescue shall be provided on the exterior landing in accordance with Sections 1009.7.1 through 1009.7.4.~~

1009.7.1 Size. Each exterior area for assisted rescue shall be sized to accommodate wheelchair spaces in accordance with Section 1009.6.3.

1009.7.2 Separation. Exterior walls separating the exterior area of assisted rescue from the interior of the building shall have a minimum fire-resistance rating of 1 hour, rated for exposure to fire from the inside. The fire-resistance-rated exterior wall construction shall extend horizontally 10 feet (3048 mm) beyond the landing on either side of the landing or equivalent fire-resistance-rated construction is permitted to extend out perpendicular to the exterior wall 4 feet (1220 mm) minimum on the side of the landing. The fire-resistance-rated construction shall extend vertically from the ground to a point 10 feet (3048 mm) above the floor level of the area for assisted rescue or to the roof line, whichever is lower. Openings within such fire-resistance-rated exterior walls shall be protected in accordance with Section 716.

~~[1007.7.1]~~ **1009.7.3 Openness.** The exterior area for assisted rescue shall be ~~[at least]~~ open to the outside air. The sides other than the separation walls shall be not less than 50 percent open, and the open area ~~[above the guards]~~ shall be ~~[so]~~ distributed so as to minimize the accumulation of smoke or toxic gases.

~~[1007.7.2 Exterior exit stairway]~~ **1009.7.4 Stairways.** ~~[Exterior exit stairways]~~ Stairways that are part of the accessible means of egress for the exterior area for assisted rescue shall provide a clear width of 48 inches ~~[(4249 mm)]~~ (1220 mm) between handrails.

Exception: The clear width of 48 inches (1220 mm) between handrails is not required at stairways serving buildings equipped throughout with an automatic sprinkler system installed in accordance with Section 903.3.1.1 or 903.3.1.2.

~~[1007.8]~~ **1009.8 Two-way communication.** A two-way communication system complying with Sections 1009.8.1 and 1009.8.2 shall be provided at the landing serving each elevator [landing] or bank of elevators on each accessible floor that is one or more stories above or below the [story] level of exit discharge ~~[complying with Sections 1007.8.1 and 1007.8.2]~~.

Exceptions:

1. Two-way communication systems are not required at the landing serving each elevator [landing] or bank of elevators where the two-way communication system is provided within areas of rescue assistance in accordance with Section ~~[1007.6.3]~~ 1009.6.5.
2. Two-way communication systems are not required on floors provided with ~~[exit]~~ ramps conforming to the provisions of Section ~~[1010]~~ 1012.
3. Two-way communication systems are not required at the landings serving only service elevators that are not designated as part of the accessible means of egress or serve as part of the required accessible route into a facility.
4. Two-way communication systems are not required at the landings serving only freight elevators that are not designated as part of the accessible means of egress or serve as part of the required accessible route into a facility.
5. Two-way communication systems are not required at the landing serving a private residence elevator.

[1007.8.1] 1009.8.1 System requirements. Two-way communication systems shall provide communication between each required location and the fire command center or a central control point location approved by the Fire Department. Where the central control point is not a constantly attended location, a two-way communication system shall have a timed automatic telephone dial-out capability to a monitoring location or 911. The two-way communication system shall include both audible and visible signals.

[1007.8.2] 1009.8.2 Directions. Directions for the use of the two-way communication system, instructions for summoning assistance via the two-way communication system and written identification of the location shall be posted adjacent to the two-way communication system. Signage shall comply with the ICC A117.1 requirements for visual characters.

[1007.9] 1009.9 Signage. Signage indicating special accessibility provisions shall be provided as shown:

1. Each door providing access to an area of rescue assistance from an adjacent floor area shall be identified by a sign stating: AREA OF RESCUE ASSISTANCE.
2. Each door providing access to an exterior area for assisted rescue shall be identified by a sign stating: EXTERIOR AREA FOR ASSISTED RESCUE.

Signage shall comply with the ICC A117.1 requirements for visual characters and include the International Symbol of Accessibility. Where exit sign illumination is required by Section ~~[1011.2]~~ 1013.3, the signs shall be illuminated. Additionally, ~~[tactile]~~ visual character, raised character and braille signage complying with ICC A117.1 shall be located at each door to an area of rescue assistance and exterior area for assisted rescue in accordance with Section ~~[1011.3]~~ 1013.4 of this code.

[1007.10] 1009.10 Directional signage. ~~[Direction]~~ Directional signage indicating the location of ~~[the]~~ all other means of egress and which of those are accessible means of egress shall be provided at the following:

1. At exits serving a required accessible space but not providing an approved accessible means of egress.
2. At elevator landings.
3. Within areas of rescue assistance.

[1007.11] 1009.11 Instructions. In areas of rescue assistance and exterior areas for assisted rescue, instructions on the use of the area under emergency conditions shall be posted. Signage shall comply with the ICC A117.1 requirements for visual characters. The instructions shall include all of the following:

1. Persons able to use the exit stairway do so as soon as possible, unless they are assisting others.
2. Information on planned availability of assistance in the use of stairs or supervised operation of elevators and how to summon such assistance.

3. Directions for use of the two-way communication system where provided.

SECTION BC [4008] 1010 DOORS, GATES AND TURNSTILES

[1008.1] 1010.1 Doors. Means of egress doors shall meet the requirements of this section. Doors serving a means of egress system shall meet the requirements of this section and Section [4020.2] 1022.2. Doors provided for egress purposes in numbers greater than required by this code shall meet the requirements of this section.

Means of egress doors shall be readily distinguishable from the adjacent construction and finishes such that the doors are easily recognizable as doors. Mirrors or similar reflecting materials shall not be used on means of egress doors. Means of egress doors shall not be concealed by curtains, drapes, decorations or similar materials.

[1008.1.1] 1010.1.1 Size of doors. The minimum width and height of each door opening shall be in accordance with this section.

[1008.1.1.1] 1010.1.1.1 Door width. The required capacity [~~minimum width~~] of each door opening shall be sufficient for the occupant load thereof and shall provide a minimum clear width of [~~not less than~~] 32 inches ([813] 812.2 mm). Clear openings of doorways with swinging doors shall be measured between the face of the door and the stop, with the door open 90 degrees (1.57 rad). Where this section requires a minimum clear width of 32 inches ([813] 812.8 mm) and a door opening includes two door leaves without a mullion, one leaf shall provide a clear opening width of 32 inches ([813] 812.8 mm). The maximum width of a swinging door leaf shall be 48 inches ([1219] 1220 mm) nominal. Means of egress doors in a Group I-2 occupancy used for the movement of beds shall provide a clear width not less than 41½ inches ([1054] 1054.1 mm).

Exceptions:

- 1 The minimum and maximum width shall not apply to door openings that are not part of the required means of egress in Group R-2 and R-3 occupancies.
2. Door openings to resident sleeping units in Group I-3 occupancies shall have a clear width of not less than 28 inches ([711] 711.2 mm).
3. Door openings to storage closets less than 10 square feet (0.93 m²) in area shall not be limited by the minimum width.
4. Width of door leaves in revolving doors that comply with Section [1008.1.4.1] 1010.1.4.1 shall not be limited.
5. [~~Except for~~] In other than Group R-1 occupancies, the minimum widths shall not apply to interior egress doors within a dwelling unit or sleeping unit that is not required to be an Accessible unit, Type B+NYC or Type B unit.
6. Doors to walk-in freezers and coolers less than 1,000 square feet (92.9 m²) in area shall have a maximum width of 60 inches (1524 mm).

7. In Group R-1 dwelling units or sleeping units not required to be Accessible units, the minimum width shall not apply to doors for showers or saunas.

~~[1008.1.1.2]~~ **1010.1.1.2 Projections into clear width.** There shall not be projections into the required clear width lower than 34 inches (~~[864]~~ 863.4 mm) above the floor or ground. Projections into the clear opening width between 34 inches (~~[864]~~ 863.4 mm) and 80 inches (2032 mm) above the floor or ground shall not exceed 4 inches (~~[102]~~ 101.6 mm).

Exception: Door closers and door stops shall be permitted to be 78 inches (1980 mm) minimum above the floor.

~~[1008.1.1.3]~~ **1010.1.1.3 Height.** The height of doors shall be not ~~[be]~~ less than 80 inches (2032 mm).

Exceptions:

1. Door openings within a dwelling unit or sleeping unit shall be not ~~[be]~~ less than 78 inches (~~[1984]~~ 1981.2 mm) in height.
2. Exterior door openings in dwelling units and sleeping units, other than the required exit door, shall be not ~~[be]~~ less than 76 inches (~~[1930]~~ 1930.4 mm) in height.

~~[1008.1.2]~~ **1010.1.2 Door swing.** Egress doors shall be installed in accordance with this section.

~~[1008.1.2.1]~~ **1010.1.2.1 Mounting.** Egress doors shall be of the pivoted or side-hinged swinging type.

Exceptions:

1. Private garages, office areas, factory and storage areas with an occupant load of 10 or less.
2. Group I-3 occupancies used as a place of detention.
3. Critical or intensive care patient rooms within suites of health care facilities.
4. Doors within or serving a single dwelling unit in Groups R-2 and R-3.
5. In other than Group H occupancies, revolving doors complying with Section ~~[1008.1.4.1]~~ 1010.1.4.1.
6. In other than Group H occupancies, special purpose horizontal sliding [doors], accordion or folding door assemblies complying with Section ~~[1008.1.4.3]~~ 1010.1.4.3 ~~[are permitted in a means of egress]~~.
7. Power-operated doors in accordance with Section ~~[1008.1.4.2]~~ 1010.1.4.2.
8. Doors serving a bathroom within an individual sleeping unit in Group R-1.

9. In other than Group H occupancies, manually operated horizontal sliding doors are permitted in a means of egress from spaces with an occupant load of 10 or less.

[1008.1.2.2] 1010.1.2.2 Direction of swing. Doors shall swing in the direction of egress travel where serving:

1. Group F or H occupancies.
2. Rooms or spaces with an occupant load of ~~[50]~~ 75 or more persons.
3. Rooms or spaces requiring more than one exit door.
4. Automatic teller machines in accordance with Section 10-160 of the *Administrative Code*.

Exception: Doors need not swing in the direction of egress travel for exterior street floor exit doors from lobbies serving only Group R-2 or R-3 occupancies.

[1008.1.3] 1010.1.3 Door opening force. The force for pushing or pulling open interior swinging egress doors, other than fire doors, shall not exceed ~~[5-pound]~~ 5-pounds (~~[22]~~ 22.2 N). These forces do not apply to the force required to retract latch bolts or disengage other devices that hold the door in a closed position. For other swinging doors, as well as sliding and folding doors, the door latch shall release when subjected to a 15-pound (~~[67]~~ 66.7 N) force. The door shall be set in motion when subjected to a 30-pound (~~[133]~~ 133.4 N) force. The door shall swing to a full-open position when subjected to a 15-pound (~~[67]~~ 66.7 N) force.

1010.1.3.1 Location of applied forces. Forces shall be applied to the latch side of the door.

[1008.1.4] 1010.1.4 Special doors. Special doors and security grilles shall comply with the requirements of Sections ~~[1008.1.4.1]~~ 1010.1.4.1 through ~~[1008.1.4.5]~~ 1010.1.4.4.

[1008.1.4.1] 1010.1.4.1 Revolving doors. Revolving doors shall comply with the following:

1. Revolving doors shall comply with BHMA A156.27 and shall be installed in accordance with the manufacturer's instructions.

~~[1.]~~ 2. Each revolving door shall be capable of ~~[collapsing into a book fold position with parallel egress paths providing]~~ breakout in accordance with BHMA A156.27 and shall provide an aggregate width of not less than 36 inches (~~[914]~~ 914.4 mm).

~~[2.]~~ 3. A revolving door shall not be located within 10 feet (3048 mm) of the foot ~~[of]~~ or top of ~~[stairs]~~ stairways or escalators. A dispersal area shall be provided between the ~~[stairs]~~ stairways or escalators and the revolving doors.

~~[3.]~~ 4. The revolutions per minute (rpm) for a revolving door shall not exceed ~~[those shown in]~~ the maximum rpm as specified in BHMA A156.27. Manual revolving doors shall comply with Table ~~[1008.1.4.1]~~ 1010.1.4.1(1). Automatic or power-operated revolving doors shall comply with Table 1010.1.4.1(2).

5. An emergency stop switch shall be provided near each entry point of power or automatic operated revolving doors within 48 inches (1220 mm) of the door and between 24 inches (609.6 mm) and 48 inches (1220 mm) above the floor. The activation area of the emergency stop switch button shall be not less than 1 inch (25.4 mm) in diameter and shall be red.

[4.] 6. Each revolving door shall have a side-hinged swinging door [~~which~~] that complies with Section [~~1008.1~~] 1010.1 in the same wall and within 10 feet (3048 mm) of the revolving door.

[5.] 7. Revolving doors shall not be part of an accessible route required by Section [~~1007~~] 1009 and Chapter 11.

**TABLE [~~1008.1.4.1~~] 1010.1.4.1(1)
MAXIMUM [~~REVOLVING~~] DOOR [~~SPEEDS~~] SPEED MANUAL REVOLVING DOORS**

<u>[INSIDE DIAMETER (feet-inches)] REVOLVING DOOR MAXIMUM NOMINAL DIAMETER (FT-IN)</u>	<u>[POWER-DRIVEN- TYPE SPEED CONTROL (rpm)]</u>	<u>[MANUAL-TYPE SPEED CONTROL (rpm)] MAXIMUM ALLOWABLE REVOLVING DOOR SPEED (RPM)</u>
[6-6] 6-0	[11]	12
7-0	[10]	11
[7-6]	[9]	[11]
8-0	[9]	10
[8-6]	[8]	[9]
9-0	[8]	9
[9-6]	[7]	[8]
10-0	[7]	8

For SI: 1 inch = 25.4 mm, 1 foot = 304.8 mm.

TABLE 1010.1.4.1(2)
MAXIMUM DOOR SPEED AUTOMATIC OR
POWER-OPERATED REVOLVING DOORS

<u>REVOLVING DOOR MAXIMUM NOMINAL DIAMETER</u> (FT-IN)	<u>MAXIMUM ALLOWABLE REVOLVING DOOR SPEED</u> (RPM)
<u>8-0</u>	<u>7.2</u>
<u>9-0</u>	<u>6.4</u>
<u>10-0</u>	<u>5.7</u>
<u>11-0</u>	<u>5.2</u>
<u>12-0</u>	<u>4.8</u>
<u>12-6</u>	<u>4.6</u>
<u>14-0</u>	<u>4.1</u>
<u>16-0</u>	<u>3.6</u>
<u>17-0</u>	<u>3.4</u>
<u>18-0</u>	<u>3.2</u>
<u>20-0</u>	<u>2.9</u>
<u>24-0</u>	<u>2.4</u>

For SI: 1 inch = 25.4 mm, 1 foot = 304.8 mm.

[1008.1.4.1.1] 1010.1.4.1.1 Egress component. A revolving door used as a component of a means of egress shall comply with Section [1008.1.4.1] 1010.1.4.1 and the following three conditions:

1. Revolving doors shall not be given credit for more than 50 percent of the minimum width or required [egress] capacity.
2. Each revolving door shall be credited with [~~no~~] a capacity based on not more than a 50-person [capacity] occupant load.
3. Each revolving door shall [~~be capable of being collapsed when a~~] provide for egress in accordance with BHMA A156.27 with a breakout force of not more than 130 pounds ([578] 578.3 N) [is applied within 3 inches (76 mm) of the outer edge of a wing].

[1008.1.4.1.2] 1010.1.4.1.2 Other than egress component. A revolving door used as other than a component of a means of egress shall comply with Section [1008.1.4.1] 1010.1.4.1. The [~~collapsing~~] breakout force of a revolving door not used as a component of a means of egress shall not be more than 180 pounds ([~~804~~] 800.7 N).

Exception: A [~~collapsing~~] breakout force in excess of 180 pounds ([~~804~~] 800.7 N) is permitted if the collapsing force is reduced to not more than 130 pounds ([~~578~~] 578.3 N) when [~~at least~~] not less than one of the following conditions is satisfied:

1. There is a power failure or power is removed to the device holding the door wings in position.
2. There is an actuation of the automatic sprinkler system where such system is provided.
3. There is an actuation of a smoke detection system ~~[which]~~ that is installed in accordance with Section 907 to provide coverage in areas within the building ~~[which]~~ that are within 75 feet (22 860 mm) of the revolving doors.
4. There is an actuation of a manual control switch, in an approved location and clearly ~~[defined, which]~~ identified, that reduces the ~~[holding]~~ breakout force to ~~[below the]~~ not more than 130~~[-pound]~~ pounds (~~[578]~~ 578.3 N)~~[force level]~~.

~~[1008.1.4.2]~~ 1010.1.4.2 Power-operated doors. Where means of egress doors are operated or assisted by power, ~~[such as doors with a photoelectric actuated mechanism to open the door upon the approach of a person, or doors with power assisted manual operation,]~~ the design shall be such that in the event of power failure, the door is capable of being opened manually to permit means of egress travel or closed where necessary to safeguard means of egress. The forces required to open these doors manually shall not exceed those specified in Section ~~[1008.1.3]~~ 1010.1.3, except that the force to set the door in motion shall not exceed 50 pounds (~~[220]~~ 222.4 N). The door shall be capable of swinging open from any position to the full width of the opening in which such door is installed when a force is applied to the door on the side from which egress is made. ~~[Full-]~~ Power-operated swinging doors, power-operated sliding doors and power-operated folding doors shall comply with BHMA A156.10. Power-assisted swinging doors and low-energy power-operated swinging doors shall comply with BHMA A156.19.

Exceptions:

1. Occupancies in Group I-3.
2. Horizontal sliding doors complying with Section ~~[1008.1.4.3]~~ 1010.1.4.3.
3. For a biparting door in the emergency breakout mode, a door leaf located within a multiple-leaf opening shall be exempt from the minimum 32-inch (~~[813]~~ 812.8 mm) single-leaf requirement of Section ~~[1008.1.1]~~ 1010.1.1, provided a minimum 32-inch (~~[813]~~ 812.8 mm) clear opening is provided when the two biparting leaves meeting in the center are broken out.

~~[1008.1.4.3]~~ 1010.1.4.3 ~~[Horizontal]~~ Special purpose horizontal sliding, accordion or folding doors. In other than Group H occupancies, special purpose horizontal sliding ~~[doors],~~ accordion or folding door assemblies permitted to be a component of a means of egress in accordance with Exception 6 to Section ~~[1008.1.2.1]~~ 1010.1.2.1 shall comply with all of the following criteria:

1. The doors shall be power operated and shall be capable of being operated manually in the event of power failure.

2. The doors shall be openable by a simple method from both sides without special knowledge or effort.
3. The force required to operate the door shall not exceed 30 pounds ([133] 133.4 N) to set the door in motion and 15 pounds ([67] 66.7 N) to close the door or open it to the minimum required width.
4. The door shall be openable with a force not to exceed 15 pounds ([67] 66.7 N) when a force of 250 pounds ([1100] 1112 N) is applied perpendicular to the door adjacent to the operating device.
5. The door assembly shall comply with the applicable fire protection rating and, where rated, shall be self-[~~closing~~] or [~~automatic-closing~~] automatic closing by smoke detection in accordance with Section [715.4.8.3] 716.5.9.3, shall be installed in accordance with NFPA 80 and shall comply with Section [715] 716 of this code.
6. The door assembly shall have an integrated standby power supply.
7. The door assembly power supply shall be electrically supervised.
8. The door shall open to the minimum required width within 10 seconds after activation of the operating device.
9. The door shall not be provided with a latch or lock other than panic hardware or fire exit hardware complying with Section 1010.1.10.

~~[1008.1.4.4 Access-controlled entrance doors. The exterior building entrance doors serving occupancies in Group A, B, E, M, R-1 or R-2 and entrance doors to tenant spaces in occupancies in Groups A, B, E, M, R-1 and R-2 are permitted to be equipped with an approved entrance and egress access control system which shall be installed in accordance with all of the following criteria:]~~

- ~~[1. A sensor shall be provided on the egress side arranged to detect an occupant approaching the doors. The doors shall be arranged to unlock by a signal from or loss of power to the sensor.]~~
- ~~[2. Loss of power to that part of the access control system which locks the doors shall automatically unlock the doors.]~~
- ~~[3. The doors shall be arranged to unlock from a manual unlocking device located 40 inches to 48 inches (1016 mm to 1219 mm) vertically above the floor and within 5 feet (1524 mm) of the secured doors. Ready access shall be provided to the manual unlocking device and the device shall be clearly identified by a sign that reads "PUSH TO EXIT." When operated, the manual unlocking device shall result in direct interruption of power to the lock independent of the access control system electronics and the doors shall remain unlocked for a minimum of 30 seconds.]~~

- ~~[4. Activation of the building fire alarm system, if provided, shall automatically unlock the doors, and the doors shall remain unlocked until the fire alarm system has been reset.]~~
- ~~[5. Activation of the building automatic sprinkler or fire detection system, if provided, shall automatically unlock the doors. The doors shall remain unlocked until the fire alarm system has been reset.]~~
- ~~[6. Entrance doors in buildings with an occupancy in Group A, B, E or M shall not be secured from the egress side during periods that the building is open to the general public.]~~

[1008.1.4.5] 1010.1.4.4 Security grilles. In Groups B, M and S, horizontal sliding or vertical security grilles are permitted at the main entrance where the opening of such grilles are essential to the operation of the establishments. Such grilles shall be installed in accordance with the following criteria:

1. Security grilles shall be openable from the inside without the use of a key or special knowledge or effort during periods that the space is occupied.
2. The security grilles shall remain secured in the full-open position during the period of occupancy by the general public.
3. Except as to buildings or structures classified in occupancy Group S, buildings or structures that have been designated as a landmark by the landmarks preservation commission or located in a historic district designated by such commission, on or after July 1, 2011, no security grille may be installed or replaced, nor shall the owner of a structure classified as a Group B or M occupancy or the operator of the business occupying such structure allow to be installed or replaced, a security grille to secure such property where the grille abuts the sidewalk, unless the grille, when closed, permits visibility from the sidewalk of at least 70 percent of the area covered by such grille.
4. No later than July 1, 2026, all security grilles installed on buildings or structures classified in occupancy Groups B or M shall comply with the provisions of ~~[paragraph]~~ Item 3 of this section.
5. Where two or more means of egress are required, not more than one-half of the exits or exit access doorways shall be equipped with horizontal sliding or vertical security grilles.

[1008.1.5] 1010.1.5 Floor elevation. There shall be a floor or landing on each side of a door. Such floor or landing shall be at the same elevation on each side of the door. Landings shall be level except for exterior landings, which are permitted to have a slope not to exceed 0.25 unit vertical in 12 units horizontal (2-percent slope).

Exceptions:

1. Doors serving individual dwelling units in Groups R-2 and R-3 where the following apply:
 - 1.1. A door is permitted to open at the top step of an interior flight of stairs within the dwelling unit, provided the door does not swing over the top step.
 - 1.2. Screen doors and storm doors are permitted to swing over stairs or landings.
2. Exterior doors as provided for in Section 1003.5, Exception 1, and Section ~~[1020.2]~~ 1022.2, which are not on an accessible route.
3. In Group R-3 occupancies not required to be Accessible units, Type B+NYC units or Type B units, the landing at an exterior doorway shall be not ~~[be]~~ more than 7³/₄ inches (~~[197]~~ 186.9 mm) below the top of the threshold, provided the door, other than an exterior storm or screen door, does not swing over the landing.
4. Variations in elevation due to differences in finish materials, but not more than ~~[0.5]~~ 1/₂ inch (12.7 mm).
5. Exterior spaces of Type B+NYC units and Type B units where permitted pursuant to the exception to Section 1107.4.
6. Doors serving equipment spaces not required to be accessible in accordance with Section 1103.2.9 and serving an occupant load of five or less shall be permitted to have a landing on one side to be not more than 7 inches (177.8 mm) above or below the landing on the egress side of the door.

~~[1008.1.6]~~ **1010.1.6 Landings at doors.** Landings shall have a width not less than the width of the stairway or the door, whichever is greater. Doors in the fully open position shall not reduce a required dimension by more than 7 inches (~~[178]~~ 177.8 mm). At any stairway landing, or when a door landing serves an occupant load of 50 or more, doors in any position shall not reduce the landing to less than 75 percent of its required width. Landings shall have a length measured in the direction of travel of not less than 44 inches (~~[118]~~ 1117.6 mm).

Exceptions:

1. Landing length in the direction of travel in Groups R-3 and U and within individual units of Group R-2 need not exceed 36 inches (~~[914]~~ 914.4 mm).
2. In Group R-2 occupancies, where 36 inches wide stairways are permitted pursuant to Section ~~[1009.1]~~ 1011.2, Exception 1.2, such stairway landing length in the direction of travel shall be permitted to be not less than 36 inches (~~[914]~~ 914.4 mm) or the width of the stairway, whichever is greater. Doors opening onto such stairway landings shall not reduce the landing width.

~~[1008.1.7]~~ **1010.1.7 Thresholds.** Thresholds at doorways shall not exceed ~~[0.75]~~ 3/₄ inch (19.1 mm) in height above the finished floor or landing for sliding doors serving dwelling units or ~~[0.5]~~

$\frac{1}{2}$ inch (12.7 mm) above the finished floor or landing for other doors. Raised thresholds and floor level changes greater than ~~[0.25]~~ $\frac{1}{4}$ inch (6.4 mm) at doorways shall be beveled with a slope not greater than one unit vertical in two units horizontal (50-percent slope).

[Exception:] Exceptions:

1. ~~[The threshold height shall be limited to 7.75 inches (197 mm) where the]~~ In occupancy [is] Group R-2 or R-3[; the door is an], threshold heights for sliding and side-hinged exterior [door that is not a component] doors shall be permitted to be up to 7 $\frac{3}{4}$ inches (196.9 mm) in height if all of the following apply:
 - 1.1. ~~The door is not part of the required means of egress[; the door, other than an exterior storm or screen door, does].~~
 - 1.2. ~~The door is not [swing over the landing or step; and the doorway is not on] part of an accessible route as required by Chapter 11 [and].~~
 - 1.3. ~~The door is not part of an Accessible unit, Type B+NYC unit or Type B unit.~~
 - 1.4. ~~The exterior door, other than a storm or screen door, does not swing over the landing or step.~~
2. In Type B+NYC units and Type B units, where permitted pursuant to the exception to Section 1107.4, the threshold height on the exterior side of the door shall not exceed 4 $\frac{3}{4}$ inches (120.7 mm) in height above the exterior deck, patio or balcony for sliding doors or 4 $\frac{1}{2}$ inches (114.3 mm) above the exterior deck, patio or balcony for other doors.

[1008.1.8] 1010.1.8 Door arrangement. Space between two doors in a series shall be 48 inches (~~[1219]~~ 1220 mm) minimum plus the width of a door swinging into the space. Doors in series shall swing either in the same direction or away from the space between the doors.

Exceptions:

1. The minimum distance between horizontal sliding power-operated doors in a series shall be 48 inches (~~[1219]~~ 1220 mm).
2. Storm and screen doors serving individual dwelling units in Groups R-2 and R-3 need not be spaced 48 inches (~~[1219]~~ 1220 mm) from the other door.
3. Doors within individual dwelling units in Group R-3.
4. Doors within individual dwelling units in Group R-2 that are not required to comply with Section 1107.
5. Exterior doors in vestibules in Group R-2 occupancies shall not be required to swing either in the same direction or away from the space between doors provided that the 48-inch (~~[1219]~~ 1220 mm) minimum space between door swings is maintained.

[1008.1.9] 1010.1.9 Door operations. Except as specifically permitted by this section, egress doors shall be readily openable from the egress side without the use of a key or special knowledge or effort.

[1008.1.9.1] 1010.1.9.1 Hardware. Door handles, pulls, latches, locks and other operating devices on doors required to be accessible by Chapter 11 shall not require tight grasping, tight pinching or twisting of the wrist to operate.

[1008.1.9.2] 1010.1.9.2 Hardware height. Door handles, pulls, latches, locks and other operating devices shall be installed 34 inches ([864] 863.4 mm) minimum and 48 inches ([1219] 1220 mm) maximum above the finished floor. Locks used only for security purposes and not used for normal operation are permitted at any height.

Exception: Access doors or gates in barrier walls and fences protecting pools, spas and hot tubs shall be permitted to have operable parts in compliance with Section 3109.4.2 or 3109.5.1.7, as applicable.

[1008.1.9.3] 1010.1.9.3 Locks and latches. Locks and latches shall be permitted to prevent operation of doors where any of the following [~~exists~~] exist:

1. Places of detention or restraint.
2. Places where extra safeguards are required such as banks, museums, and jewelry stores subject to the approval of the commissioner and provided the locks are equipped with electrical release devices for remote control in case of emergencies. However, museums shall be subject to further special review by the commissioner and Fire Commissioner.
3. Main entrances in Occupancy Groups B, M, and S as permitted by Section [~~1008.1.3.5~~] 1010.1.4.4.
4. Doors from individual dwelling or sleeping units of Group R occupancies having an occupant load of 10 or less are permitted to be equipped with a night latch, dead bolt or security chain, provided such devices are openable from the inside without the use of a key or tool.
5. Doors serving Group R-2 occupancies as required by Section [~~1008.4~~] 1010.4.
6. In educational occupancies classified in Occupancy Group B or E, and college or student dormitories in Group R-1, [~~Stairways~~] stairways leading from the top floor to a roof may be provided with locked wire mesh gates openable by key [~~in Occupancy Group E~~].
7. On roofs that are not intended to be accessed by occupants other than building maintenance personnel, the [~~The~~] use of a hook and eye closing device or other similar non-self-locking devices on the [~~inside~~] stairway side of all doors openable without the use of a key or special knowledge to roofs shall be permitted.

[7] 8. Fire doors after the minimum elevated temperature has disabled the unlatching mechanism in accordance with listed fire door test procedures.

~~[1008.1.9.4]~~ **1010.1.9.4 Bolt locks.** Manually operated flush bolts or surface bolts are not permitted.

Exceptions:

1. On doors not required for egress in individual dwelling units or sleeping units.
2. Where a pair of doors serves a storage or equipment room, manually operated edge- or surface-mounted bolts are permitted on the inactive leaf.
3. Where a pair of doors serves an occupant load of less than 75 persons in a Group B, F or S occupancy, manually operated edge- or surface-mounted bolts are permitted on the inactive leaf. The inactive leaf shall not contain ~~[no]~~ doorknobs, panic bars or similar operating hardware.
4. Where a pair of doors serves a Group B, F or S occupancy, manually operated edge- or surface-mounted bolts are permitted on the inactive leaf provided such inactive leaf is not needed to meet egress ~~[width]~~ capacity requirements and the building is equipped throughout with an automatic sprinkler system in accordance with Section 903.3.1.1. The inactive leaf shall ~~[contains no]~~ not contain doorknobs, panic bars or similar operating hardware.
5. Where a pair of doors serves patient care rooms in Group I-2 occupancies, self-latching edge- or surface-mounted bolts are permitted on the inactive leaf provided that the inactive leaf is not needed to meet egress ~~[width]~~ capacity requirements and the inactive leaf ~~[contains no]~~ shall not contain doorknobs, panic bars or similar operating hardware.

~~[1008.1.9.5]~~ **1010.1.9.5 Unlatching.** The unlatching of any door or leaf shall not require more than one operation.

Exception: More than one operation is permitted for unlatching doors in the following locations:

1. Places of detention or restraint.
2. Where manually operated bolt locks are permitted by Section ~~[1008.1.9.4]~~ 1010.1.9.4.
3. Doors from individual dwelling units and sleeping units of Group R occupancies as permitted by Section ~~[1008.1.9.3]~~ 1010.1.9.3, Items 4 and 5.

~~[1008.1.9.5.1]~~ **1010.1.9.5.1 Closet and bathroom doors in certain Group R occupancies.** In community residences or intermediate-care facilities classified as Group R-1, R-2 or R-3 occupancies pursuant to Section ~~[308.2.2]~~ 308.3.2, Exception 1, 2 or 3, within such facilities, closet doors that latch in the closed position shall be openable from

inside the closet, and bathroom doors that latch in the closed position shall be capable of being unlocked from the ingress side.

~~[1008.1.9.6 Special locking arrangements in Group I-2. Subject to special review and approval by the commissioner, approved, listed, delayed approved, listed, delayed egress locks may be permitted on doors serving spaces in a Group I-2 occupancy where the clinical needs of persons receiving care require such locking.]~~

1010.1.9.6 Controlled egress doors in Groups I-1 and I-2. Electric locking systems, including electro-mechanical locking systems and electromagnetic locking systems, shall be permitted to be locked in the means of egress in Group I-1 or I-2 occupancies where the clinical needs of persons receiving care require their containment. ~~[Delayed]~~ Controlled egress [locks may] doors shall be permitted in such occupancies where the building is equipped throughout with an ~~[automatic]~~ automatic sprinkler system in accordance with Section 903.3.1.1 or an approved automatic smoke or heat ~~[detection]~~ detection system installed in accordance with Section 907, provided that the doors ~~[unlock]~~ are installed and operate in accordance with ~~[Items 1 through 6 below. A building occupant shall not be required to pass through more than one door equipped with a delayed egress lock before entering an exit.]~~ all of the following:

1. The ~~[doors]~~ door locks shall unlock ~~[upon]~~ on actuation of the automatic sprinkler system or automatic fire detection system.
2. The ~~[doors]~~ door locks shall unlock ~~[upon]~~ on loss of power controlling the lock or lock mechanism.
3. The door ~~[locks]~~ locking system shall be installed to have the capability of being unlocked by a ~~[signal from]~~ switch located at the fire command center, a nursing station or other approved location. The switch shall directly break power to the lock.
4. A building occupant shall not be required to pass through more than one door equipped with a controlled egress locking system before entering an exit.
5. The procedures for [the operation(s) of the unlocking system] unlocking the doors shall be described and approved as part of the emergency planning and preparedness required by [Chapter 4 of] the *New York City Fire Code*.
- ~~[5.]~~ 6. All clinical staff shall have the keys, codes or other means necessary to operate the locking ~~[devices]~~ systems.
- ~~[6.]~~ 7. Emergency lighting shall be provided at the door.
8. The door locking system units shall be listed in accordance with UL 294.

[Exception:] Exceptions:

1. Items 1 through [3] 4 shall not apply to doors to areas [where] occupied by persons who, because of clinical needs, require restraint or containment as part of the function of a [mental hospital] psychiatric treatment area.

2. Items 1 through 4 shall not apply to doors to areas where a listed egress control system is utilized to reduce the risk of child abduction from nursery and obstetric areas of a Group I-2 hospital.

[1008.1.9.7] 1010.1.9.7 Delayed egress [locks] locking systems. Subject to special review and approval by the commissioner, approved, listed, delayed egress [~~locks~~] locking systems may be permitted on doors serving spaces where extra safeguards are required in buildings that are equipped throughout with an automatic sprinkler system in accordance with Section 903.3.1.1 or an approved automatic smoke or heat detection system installed in accordance with Section 907, provided that the doors unlock in accordance with Items 1 through ~~[6]~~ 8 below.~~[A building occupant shall not be required to pass through more than one door equipped with a delayed egress lock before entering an exit.]~~

1. The [~~doors unlock~~] delay electronics of the delayed egress locking system shall deactivate upon actuation of the automatic sprinkler system or automatic fire detection system, allowing immediate, free egress.
2. The [~~doors unlock~~] delay electronics of the delayed egress locking system shall deactivate upon loss of power controlling the lock or lock mechanism, allowing immediate free egress.
3. The [~~door locks~~] delayed egress locking system shall have the capability of being [~~unlocked by a signal from~~] deactivated at the fire command center and other approved locations.
4. [~~The initiation of~~] An attempt to egress shall initiate an irreversible process [~~which will release the latch~~] that shall allow such egress in not more than 15 seconds when a [~~force of~~] physical effort of 15 pounds (66.7 N) is applied to the egress side door hardware for not more than 3 seconds [~~15 pounds (67 N) is applied for 1 second to the release device~~]. Initiation of the irreversible process shall activate an audible signal in the vicinity of the door. Once the [~~door lock has~~] delay electronics have been [~~released by~~] deactivated, rearming the [~~application of force to the releasing device, relocking~~] delay electronics shall be by manual means only. Except [~~that~~] where approved by the department, a delay [~~in releasing the latch~~] of not more than 30 seconds is permitted on a delayed egress door.
5. The egress path from any point shall not pass through more than one delayed egress locking system. Except where approved by the department, in Group I-2 or I-3 occupancies, the egress path from any point in the building shall pass through not more than two delayed egress locking systems provided the combined delay does not exceed 30 seconds.
6. A sign shall be provided on the door and shall be located above and within 12 inches (~~[305]~~ 304.8 mm) of the [~~release device reading~~] door exit hardware.[:] Except where approved by the department, in Group I occupancies, the installation of a sign is not required where care recipients who because of clinical needs require restraint or containment as part of the function of the treatment area.

6.1. For doors that swing in the direction of egress, the sign shall read: PUSH UNTIL ALARM SOUNDS. DOOR CAN BE OPENED IN 15 SECONDS. Except [that] where [a delay in releasing the latch of] not more than 30 seconds is permitted on a delayed egress door is approved by the department, such sign shall read: PUSH UNTIL ALARM SOUNDS. DOOR CAN BE OPENED IN [45] 30 SECONDS.

6.2. For doors that swing in the opposite direction of egress, the sign shall read: PULL UNTIL ALARM SOUNDS. DOOR CAN BE OPENED IN 15 SECONDS. Except where not more than 30 seconds is permitted on a delayed egress door is approved by the department, such sign shall read: PULL UNTIL ALARM SOUNDS. DOOR CAN BE OPENED IN 30 SECONDS.

6.3. The sign shall comply with the visual character requirements in ICC A117.1.

~~[6-]~~ 7. Emergency lighting shall be provided [at] on the egress side of the door.

8. The delayed egress locking system units shall be listed in accordance with UL 294.

Exceptions:

1. Delayed egress [~~locks~~] locking systems shall not be permitted in buildings or spaces in Group A, E, F and H occupancies. However, in museums, delayed egress locks may be installed on exit doors subject to special review by the commissioner and Fire Commissioner.
2. Places of detention or restraints in Group I-3 are permitted to install delayed egress [~~locks~~] locking systems without the special review by the commissioner, provided that the installation complies with all of the other requirements of this section.

1010.1.9.8 Sensor release of electrically locked egress doors. The electric locks on sensor released doors located in a means of egress in buildings with an occupancy in Group A, B, E, M, R-1 or R-2 and entrance doors to tenant spaces in occupancies in Group A, B, E, M, R-1 or R-2 are permitted where installed and operated in accordance with all of the following criteria:

1. The sensor shall be installed on the egress side, arranged to detect an occupant approaching the doors. The doors shall be arranged to unlock by a signal from or loss of power to the sensor.
2. Loss of power to the lock or locking system shall automatically unlock the doors.
3. The doors shall be arranged to unlock from a manual unlocking device located 40 inches to 48 inches (1016 mm to 1220 mm) vertically above the floor and within 5 feet (1524 mm) of the secured doors. Ready access shall be provided to the manual unlocking device and the device shall be clearly identified by a sign that reads "PUSH TO EXIT." When operated, the manual unlocking device shall result in direct

interruption of power to the lock—independent of other electronics—and the doors shall remain unlocked for not less than 30 seconds.

4. Activation of the building fire alarm system, where provided, shall automatically unlock the doors, and the doors shall remain unlocked until the fire alarm system has been reset.
5. Activation of the building automatic sprinkler system or fire detection system, where provided, shall automatically unlock the doors. The doors shall remain unlocked until the fire alarm system has been reset.
6. The door locking system units shall be listed in accordance with UL 294.

[1008.1.9.8] 1010.1.9.9 Electromagnetically locked egress doors. Doors in the means of egress ~~[that are not otherwise required to have panic hardware]~~ in buildings with an occupancy in Group A, B, E, M, R-1 or R-2 and doors to tenant spaces in Group A, B, E, M, R-1 or R-2 shall be permitted to be ~~[electromagnetically]~~ locked ~~[if]~~ with an electromagnetic locking system where equipped with [listed] hardware that incorporates a built-in switch and [meet the requirements below] where installed and operated in accordance with all of the following:

1. The ~~[listed]~~ hardware that is affixed to the door leaf has an obvious method of operation that is readily operated under all lighting conditions.
2. The ~~[listed]~~ hardware is capable of being operated with one hand.
3. Operation of the ~~[listed]~~ hardware ~~[releases to]~~ directly interrupts the power to the electromagnetic lock and unlocks the door immediately.
4. Loss of power to the ~~[listed hardware]~~ electromagnetic locking system automatically unlocks the door to permit egress.
5. Where panic or fire exit hardware is required by Section 1010.1.10, operation of the panic or fire exit hardware also releases the electromagnetic lock.
6. The locking system units shall be listed in accordance with UL 294.

[1008.1.9.9] 1010.1.9.10 Locking arrangements in correctional facilities. In occupancies in Groups A-2, A-3, A-4, B, E, F, I-2, I-3, M and S within correctional and detention facilities, doors in means of egress serving rooms or spaces occupied by persons whose movements are controlled for security reasons shall be permitted to be locked ~~[when]~~ where equipped with egress control devices [which-] that shall unlock manually and by [at least] not less than one of the following means:

1. Activation of an automatic sprinkler system installed in accordance with Section 903.3.1.1[;].
2. Activation of an approved manual fire alarm box[; or].
3. A signal from a constantly attended location.

[1008.1.9.10] 1010.1.9.11 Stairway doors. Interior stairway means of egress doors shall be openable from both sides without the use of a key or special knowledge or effort.

Exceptions:

1. Stairway discharge doors shall be openable from the egress side and shall only be locked from the opposite side.
2. This section shall not apply to doors arranged in accordance with Section 403.5.3.
3. In stairways serving not more than four stories, doors are permitted to be locked from the side opposite the egress side, provided they are openable from the egress side and capable of being unlocked simultaneously without unlatching upon a signal from the fire command center, if present, or a signal by emergency personnel from a single location inside the main entrance to the building.
4. This section shall not apply to buildings permitted to be served by one exit in accordance with Item ~~[4-6]~~ 5 or 6 of Section ~~[4021.2]~~ 1006.3.2.
5. In schools classified as Group E occupancies that require lockdown drills as per New York State Education Law 807, stairway egress doors from occupied spaces are permitted to be locked from the side opposite the egress side for the duration of the lockdown drill, provided that they are openable from the occupied side for egress and are unlocked upon directions from the school administrative personnel following the completion of the lockdown drill.

[1008.1.10] 1010.1.10 Panic and fire exit hardware. Doors serving ~~[a Group H occupancy and doors serving rooms or spaces with an occupant load of 50 or more in a Group A or E occupancy]~~ the following shall not be provided with a latch or lock ~~[unless it is]~~ other than panic hardware or fire exit hardware[-];

1. Group H occupancies;
2. A room or space with an occupant load of 75 or more in a Group A or E occupancy;
3. A building or nonaccessory tenant space used for assembly purposes that is permitted to be classified as a Group B occupancy pursuant to Section 303.1.2; and
4. An accessory room or space used for assembly purposes where permitted to be classified as a Group B occupancy or as part of the occupancy it is accessory to, pursuant to Section 303.1.3.

[Exception:] Exceptions:

1. A main exit of a Group A occupancy shall be permitted to be locking in [compliance] accordance with Section [1008.1.9.3] 1010.1.9.3, Item 2.
2. Doors serving a Group A or E occupancy shall be permitted to be electromagnetically locked in accordance with Section 1010.1.9.9.

~~[Electrical rooms with equipment rated 1,200 amperes or more and over 6 feet (1829 mm) wide that contain overcurrent devices, switching devices or control devices with exit or exit access doors shall be equipped with panic hardware or fire exit hardware. The doors shall swing in the direction of egress travel.]~~

1010.1.10.1 Rooms with electrical equipment. Exit or exit access doors serving transformer vaults, rooms designated for batteries or energy storage systems, or modular data centers shall be equipped with panic hardware or fire exit hardware. Where rooms contain electrical rooms with equipment rated 800 amperes or more that contain overcurrent devices, switching devices or control devices and where the exit or exit access door is less than 25 feet (7629 mm) from the equipment working space, shall be equipped with panic hardware or fire exit hardware. The doors shall swing in the direction of egress travel.

1010.1.10.2 Refrigeration machinery room. Swinging doors in refrigeration machinery rooms, where required by Section 1006.2.2.3, shall not be provided with a latch or lock other than panic hardware or fire exit hardware.

~~[1008.1.10.1]~~ **1010.1.10.3 Installation.** Where panic or fire exit hardware is installed, it shall comply with the following:

1. Panic hardware shall be listed in accordance with UL 305[;].
2. Fire exit hardware shall be listed in accordance with UL 10C and UL 305[;].
3. The actuating portion of the releasing device shall extend [~~at least~~] not less than one-half of the door leaf width[; ~~and~~].
4. The maximum unlatching force shall not exceed 15 pounds ([~~67~~] 66.7 N).

~~[1008.1.10.2]~~ **1010.1.10.4 Balanced doors.** If balanced doors are used and panic hardware is required, the panic hardware shall be the push-pad type and the pad shall not extend more than one-half the width of the door measured from the latch side.

~~[1008.2]~~ **1010.2 Gates.** Gates serving the means of egress system shall comply with the requirements of this section. Gates used as a component in a means of egress shall conform to the applicable requirements for doors.

Exception: Horizontal sliding or swinging gates exceeding the 4-foot ([~~1219~~] 1220 mm) maximum leaf width limitation are permitted in fences and walls surrounding a stadium.

~~[1008.2.1]~~ **1010.2.1 Stadiums.** Panic hardware is not required on gates surrounding stadiums where such gates are under constant immediate supervision while the public is present, and where safe dispersal areas based on 3 square feet (0.28 m²) per occupant are located between the fence and enclosed space. Such required safe dispersal areas shall not be located less than 50 feet (15 240 mm) from the enclosed space. See Section [~~1027.6~~] 1028.5 for means of egress from safe dispersal areas.

[1008.3] 1010.3 Turnstiles. Turnstiles or similar devices that restrict travel to one direction shall not be placed so as to obstruct any required means of egress. Where portable turnstiles are installed for ticketing purposes, such turnstiles shall be moved from the egress path for proper exiting.

Exceptions:

1. **Manually-operated turnstiles.** Manually-operated turnstiles that consist of revolving devices that turn freely in the direction of exit travel may be used in any occupancy where revolving doors are permitted. Each manually-operated turnstile or similar device shall be credited with no more than a 50-person capacity where all of the following provisions are met:
 - 1.1. Each device shall turn free manually in the direction of egress travel when primary power is lost, and upon the manual release by an employee in the area.
 - 1.2. Such devices are not given credit for more than 50 percent of the required egress capacity or width.
 - 1.3. Each device is not more than 39 inches (~~[991]~~ 990.6 mm) high.
 - 1.4. Each device has ~~[at least 16.5]~~ not less than 16½ inches (~~[419]~~ 419.1 mm) clear width at and below a height of 39 inches (~~[994]~~ 990.6 mm) and ~~[at least]~~ not less than 22 inches (~~[559]~~ 558.8 mm) clear width at heights above 39 inches (~~[994]~~ 990.6 mm).
 - 1.5. Where located as part of an accessible route, turnstiles shall have ~~[at least]~~ not less than 36 inches (~~[914]~~ 914.4 mm) clear at and below a height of 34 inches (~~[864]~~ 863.4 mm), ~~[at least]~~ not less than 32 inches (~~[813]~~ 812.8 mm) clear width between 34 inches (~~[864]~~ 863.4 mm) and 80 inches (2032 mm) and shall consist of a mechanism other than a revolving device.
2. **Automatic turnstiles.** Automatic turnstiles that consist of mechanisms other than revolving devices, and are operated by power, such as turnstiles with a photoelectric-actuated mechanism to open the turnstile upon the approach of a person, may be used in any occupancy where revolving doors are permitted. Automatic turnstiles may serve a means of egress system where all of the following provisions are met:
 - 2.1. Each automatic turnstile shall have minimum widths sufficient for the occupant load served and shall provide at least 32 inches (~~[813]~~ 812.8 mm) of clear width at and below a height of 80 inches (2032 mm).
 - 2.2. The design shall be such that in the event of power failure, each automatic turnstile is capable of breaking away manually to permit means of egress travel. The force required to break away these turnstiles manually shall not exceed 13 pounds (~~[57]~~ 57.8 N). The turnstile shall be capable of swinging from any position to the full, clear opening width of the turnstile when a force is applied to the turnstile on the side from which egress is made.

2.3. Each automatic turnstile shall be operable from the egress side without special knowledge or effort.

2.4. Each automatic turnstile shall be connected to the building fire alarm system. Activation of the building fire alarm system shall automatically release each such turnstile to its full, clear opening width, and each such turnstile shall remain in its open position until the fire alarm system has been reset.

2.5 Each automatic turnstile shall, upon actuation of a manual release device, automatically open to its full, clear opening width, and shall remain in its open position until the automatic turnstile's access control system is reset. The manual release device shall be clearly identified with ready access that results in direct interruption of power to each turnstile. The manual release device shall be positioned at the fire command center or, if a fire command center is not required, at an approved location near the building entrance where the automatic turnstiles are located.

~~[2.5.]~~ 2.6 Each automatic turnstile shall have an integrated emergency power supply.

~~[2.6.]~~ 2.7 Each automatic turnstile power supply shall be electrically supervised.

~~[2.7.]~~ 2.8 Turnstiles provided for egress purposes in numbers greater than the egress capacity required by this code shall meet the requirements of this section.

~~[2.8.]~~ 2.9 Where located as part of an accessible route, such turnstiles shall have at least 36 inches (~~[914]~~ 914.4 mm) clear width at and below a height of 34 inches (~~[864]~~ 863.4 mm), at least 32 inches (~~[813]~~ 812.8 mm) clear width between 34 inches (~~[864]~~ 863.4 mm) and 80 inches (2032 mm).

~~[1008.3.1]~~ **1010.3.1 High turnstile.** Turnstiles more than 39 inches (~~[991]~~ 990.6 mm) high shall meet the requirements for revolving doors.

~~[1008.3.2]~~ **1010.3.2 Additional door.** Where serving an occupant load greater than 300, each manually-operated turnstile and automatic turnstile that is not portable shall have a side-hinged swinging door ~~[which]~~ that conforms to Section ~~[1008.1]~~ 1010.1 within 50 feet (15 240 mm).

~~[1008.4]~~ **1010.4 Security requirements for doors and windows.** The provisions of Sections ~~[1008.4.1]~~ 1010.4.1 through ~~[1008.4.4]~~ 1010.4.4 shall apply to Group R-2 occupancies.

~~[1008.4.1]~~ **1010.4.1 Entrance doors.** Building entrance doors and other exterior exit doors shall be equipped with heavy duty lock sets with auxiliary latch bolts to prevent the latch from being manipulated by means other than a key. Latch sets shall have stop-work in the inside cylinder controlled by a master key only. Outside cylinders of main entrance door locks shall be operated by the tenants' key, which shall not be keyed to also open the tenants' apartment door. A light or lights shall be provided at or near the outside of the front entranceway of the building providing not less than 5-~~[foot-candles-]~~footcandles (53.82 lux) intensity measured at the floor level for the full width of the entranceway.

[1008.4.2] 1010.4.2 Doors to dwelling units. Doors to dwelling units shall be equipped with a heavy duty latch set and a heavy duty dead bolt operable by a key from the outside and a thumb-turn from the inside. Those doors shall also be equipped with a chain guard so as to permit partial opening of the door. Dwelling unit entrance doors shall also be equipped with a viewing device located so as to enable a person on the inside of the entrance door to view a person immediately outside.

[1008.4.3] 1010.4.3 Windows. All openable windows shall be equipped with sash locks designed to be openable from the inside only. Grilles lockable from the inside only may be placed on the inside or outside of windows that are accessible from grade but that do not serve to provide access to exits.

[1008.4.4] 1010.4.4 Intercommunication system. Buildings containing eight or more dwelling units shall be provided with an intercommunication system located at the door giving access to the main entrance lobby, consisting of a device or devices for voice communication between the occupant of each dwelling unit and a person outside the door to the main entrance lobby, and permitting such dwelling unit occupant to release the locking mechanism of said door from the dwelling unit. In buildings provided with a full-time lobby attendant, the intercommunication system may be between each dwelling unit and the attendant's station.

SECTION BC [1009] 1011 STAIRWAYS

1011.1 General. Stairways serving occupied portions of a building shall comply with the requirements of Sections 1011.2 through 1011.13. Alternating tread devices shall comply with Section 1011.14. Ships ladders shall comply with Section 1011.15. Ladders shall comply with Section 1011.16.

Exception: Within rooms or spaces used for assembly purposes, stepped aisles shall comply with Section 1029.

[1009.1 Stairway width] 1011.2 Width and capacity. The [width] required capacity of stairways shall be determined as specified in Section [4005.1] 1005, but [such] the minimum width shall be not [be] less than 44 inches ([1118] 1117.6 mm). See Section [1007.3] 1009.3 for accessible means of egress stairways.

Exceptions:

1. A width of not less than 36 inches ([914] 914.4 mm) shall be permitted in:
 - 1.1. A stairway that serves an occupant load of 50 or less cumulative for all stories; or
 - 1.2. A stairway that provides egress to the exit discharge solely for the use of Group R-2 occupancies, provided the building it serves is 125 feet (38 100 mm) or less in height, and provided such a stairway serves not more than 30 occupants per floor.
2. Spiral stairways as provided for in Section [4009.9] 1011.10.
3. [~~Aisle stairs complying with Section 1028.~~]

[4.] Where an inclined platform lift or a stairway chairlift is installed on stairways serving occupancies in Group R-3, or within dwelling units in occupancies in Group R-2, a clear passage width not less than 20 inches (508 mm) shall be provided. [If] Where the seat and platform can be folded when not in use, the distance shall be measured from the folded

[1009.2] 1011.3 Headroom. Stairways shall have a [~~minimum~~] headroom clearance of not less than 84 inches (~~[2134]~~ 2133.6 mm) measured vertically from a line connecting the edge of the nosings. Such headroom shall be continuous above the stairway to the point where the line intersects the landing below, one tread depth beyond the bottom riser. The minimum clearance shall be maintained the full width of the stairway and landing. Projections into the required width shall not be limited above the minimum headroom height.

Exceptions:

1. In Group R-2 and R-3 occupancies stairways shall have a [~~minimum~~] headroom clearance of not less than 80 inches (2032 mm).
2. Spiral stairways complying with Section [~~1009.9]~~ 1011.10 are permitted a 78-inch (~~[1981]~~ 1981.2 mm) headroom clearance.
3. In Group R-3 occupancies; within dwelling units in Group R-2 occupancies; and in Group U occupancies that are accessory to a Group R-3 occupancy or accessory to individual dwelling units in Group R-2 occupancies; where the nosings of treads at the side of a flight extend under the edge of a floor opening through which the stair passes, the floor opening shall be allowed to project horizontally into the required headroom [~~a maximum of~~] not more than $4\frac{3}{4}$ inches (~~[121]~~ 120.7 mm).

[1009.3] 1011.4 Walkline. The walkline across winder treads shall be concentric to the direction of travel through the turn and located 12 inches (~~[305]~~ 304.8 mm) from the side where the winders are narrower. The 12-inch (~~[305]~~ 304.8 mm) dimension shall be measured from the widest point of the clear stair width at the walking surface of the winder. [If] Where winders are adjacent within the flight, the point of the widest clear stair width of the adjacent winders shall be used.

[1009.4] 1011.5 Stair treads and risers. Stair treads and risers shall comply with Sections [~~1009.4.1]~~ 1011.5.1 through [~~1009.4.5]~~ 1011.5.5.3.

[1009.4.1] 1011.5.1 Dimension reference surfaces. For the purpose of this section, all dimensions are exclusive of carpets, rugs or runners.

[1009.4.2] 1011.5.2 Riser height and tread depth. Stair riser heights shall be 7 inches (~~[178]~~ 177.8 mm) maximum and 4 inches (~~[102]~~ 101.6 mm) minimum. The riser height shall be measured vertically between the [~~leading edges~~] nosings of adjacent treads. Rectangular tread depths shall be 11 inches (~~[279]~~ 279.4 mm) minimum measured horizontally between the vertical planes of the foremost projection of adjacent treads and at a right angle to the tread's [~~leading edge~~] nosing. The greatest tread depth within any flight of stairs shall not exceed the smallest by more than $\frac{3}{8}$ inch (9.5 mm). Winder treads shall have a minimum tread depth of 11 inches (~~[279]~~ 279.4 mm)[~~measured~~] between the vertical planes of the foremost projection of adjacent treads at

the intersections with the walkline and a minimum tread depth of 10 inches (254 mm) within the clear width of the stair.

Exceptions:

~~[1. Alternating tread devices in accordance with Section 1009.10.]~~

~~[2. Ship ladders in accordance with Section 1009.11.]~~

~~[3.] 1.~~ Spiral stairways in accordance with Section ~~[4009.9]~~ 1011.10.

~~[4.] 2.~~ ~~[Aisle stairs in assembly seating areas where the stair pitch or slope is set, for sightline reasons, by the slope of the adjacent seating area in accordance with Section 1028.11.2.]~~ Stairways connecting stepped aisles to cross aisles or concourses shall be permitted to use the riser/tread dimension in Section 1029.13.2.

~~[5.] 3.~~ In Group R-2 occupancies:

~~[5.1.] 3.1.~~ Sum of treads and risers. The sum of two risers plus one tread exclusive of nosing shall be not less than 24 inches (~~[610]~~ 609.6 mm) nor more than 25½ inches (~~[648]~~ 647.7 mm).

~~[5.2.] 3.2.~~ Dimensions of treads and risers. The maximum riser height shall be 7¾ inches (~~[197]~~ 196.85 mm) and the minimum tread depth shall be 9½ inches (~~[241]~~ 241.3 mm) plus nosing. Treads may be undercut a distance equal to the nosing. A nosing not less than ¾ inch (19 mm) but not more than 1¼ inches (~~[32]~~ 31.8 mm) shall be provided on stairways with solid risers where the tread depth is less than 11 inches (~~[279]~~ 279.4 mm).

~~[5.3.] 3.3.~~ Tolerances. The greatest riser height, tread depth, and nosing projection, within any flight of stairs shall not exceed the smallest by more than ⅜ inch (9.5 mm).

~~[6.] 4.~~ In Group R-3 occupancies;~~[within dwelling units in Group R-2 occupancies not subject to accessibility provisions in Section 1107.2.5, Exception 2;]~~ and in Group U occupancies that are accessory to Group R-3 occupancy or accessory to individual dwelling units in Group R-2 occupancies:

~~[6.1.] 4.1.~~ Sum of treads and risers. The sum of two risers plus one tread exclusive of nosing shall be not less than 24 inches (~~[610]~~ 609.6 mm) nor more than 25½ inches (~~[648]~~ 647.7 mm).

~~[6.2.] 4.2.~~ Dimensions of treads and risers. The maximum riser height shall be 8¼ inches (~~[210]~~ 209.6 mm) and the minimum tread depth shall be 9 inches (~~[229]~~ 228.6 mm) plus nosing. Treads may be undercut a distance equal to the nosing. A 1¼[-]-inch (~~[32]~~ 31.75 mm) nosing shall be provided on stairways with solid risers where the tread depth is less than 11 inches (~~[279]~~ 279.4 mm).

[6.3.] 4.3. Tolerances. The greatest riser height, tread depth, and nosing projection, within any flight of stairs shall not exceed the smallest by more than [~~3/8~~] 3/8 inch (9.5 mm).

[7.] 5. In Group R-3 occupancies; and within dwelling units in Group R-2 occupancies; winders shall have a minimum tread depth of 10 inches (254 mm) measured horizontally between the vertical planes of the foremost projection of adjacent treads and at a right angle to the tread's leading edge, when measured at a point 12 inches ([~~305~~] 304.8 mm) from the side where the treads are narrower. Winder treads shall have a minimum tread depth of 6 inches ([~~152~~] 152.4 mm) at any point. Within any flight of stairs, the greatest winder tread depth at the 12-inch ([~~305~~] 304.8 mm) walk line shall not exceed the smallest by more than 3/8 inch (9.5 mm).

[8.] 6. In Group I-3 facilities, stairways providing access to guard towers, observation stations and control rooms, not more than 250 square feet ([~~23~~] 23.2 m²) in area, shall be permitted to have a maximum riser height of 8 inches ([~~203~~] 203.2 mm) and a minimum tread depth of 9 inches ([~~229~~] 228.6 mm).

[1009.4.3] 1011.5.3 Winder treads. Winder treads are not permitted in means of egress stairways except within a dwelling unit.

Exceptions:

1. Curved stairways in accordance with Section [~~1009.8~~] 1011.9.
2. Spiral stairways in accordance with Section [~~1009.9~~] 1011.10.

[1009.4.4] 1011.5.4 Dimensional uniformity. Stair treads and risers shall be of uniform size and shape. The tolerance between the largest and smallest riser height or between the largest and smallest tread depth shall not exceed [~~0.375~~] 3/8 inch (9.5 mm) in any flight of stairs. The greatest winder tread depth at the walkline within any flight of stairs shall not exceed the smallest by more than 3/8 inch (9.5 mm).

Exceptions:

1. [~~Nonuniform riser dimensions of aisle stairs complying with Section 1028.11.2.~~] Stairways connecting stepped aisles to cross aisles or concourses shall be permitted to comply with the dimensional nonuniformity in Section 1029.13.2.
2. Consistently shaped winders, complying with Section [~~1009.4.2~~] 1011.5, differing from rectangular treads in the same flight of stairs.
3. Where the bottom or top riser adjoins a sloping public way, walkway or driveway having an established grade and serving as a landing, the bottom or top riser is permitted to be reduced along the slope to less than 4 inches ([~~102~~] 101.6 mm) in height, with the variation in height of the bottom or top riser not to exceed one unit vertical in 12 units horizontal (8-percent slope) of [~~stairway~~] stair width. The nosings or leading edges of treads at such nonuniform height risers shall have a distinctive

marking stripe, different from any other nosing marking provided on the stair flight. The distinctive marking stripe shall be visible in descent of the stair and shall have a slip-resistant surface. Marking stripes shall have a width of [~~at least~~] not less than 1 inch (~~[25]~~ 25.4 mm) but not more than 2 inches (~~[54]~~ 50.8 mm).

[1009.4.5 Profile] 1011.5.5 Nosing and riser profile. [~~The radius of curvature at the leading edge of the tread shall be not greater than $\frac{9}{16}$ inch (14.3 mm). Beveling of nosings shall not exceed $\frac{9}{16}$ inch (14.3 mm).~~] Nosings shall have a curvature or bevel of not less than $\frac{1}{16}$ inch (1.6 mm) but not more than $\frac{9}{16}$ inch (14.3 mm) from the foremost projection of the tread. Risers shall be solid and vertical or sloped under the tread above from the underside of the nosing above at an angle not more than 30 degrees (0.52 rad) from the vertical.

1011.5.5.1 Nosing projection size. The leading edge (nosings) of treads shall project not more than $1\frac{1}{4}$ inches (~~[32]~~ 31.75 mm) beyond the tread below [~~and all~~].

1011.5.5.2 Nosing projection uniformity. Nosing projections of the leading edges shall be of uniform size, including the projections of the nosing's leading edge of the floor at the top of a flight.

1011.5.5.3 Solid risers. Risers shall be solid. Perforated risers with openings not exceeding $\frac{1}{4}$ inch (6.4 mm) shall be considered solid risers.

Exceptions:

1. Solid risers are not required for stairways that are not serving as exits or that are not required to comply with Section [~~1007.3~~] 1009.3, provided that the opening between treads does not permit the passage of a sphere with a diameter of 4 inches (~~[102]~~ 101.6 mm).
2. Solid risers are not required for occupancies in Group I-3 or in Group F, H and S occupancies other than areas accessible to the public. There are no restrictions on the size of the opening in the riser.
3. In Group R-3 occupancies, the following shall apply:
 - 3.1. The radius of curvature at the leading edge of the tread shall be no greater than $\frac{9}{16}$ inch (14.3 mm).
 - 3.2. Solid risers are not required provided that the opening between treads does not permit the passage of a sphere with a diameter of 4 inches (~~[102]~~ 101.6 mm). However, the opening between treads is not limited on stairways with a total rise of 30 inches (762 mm) or less.
4. Solid risers are not required for spiral stairways constructed in accordance with Section [~~1009.9~~] 1011.10.
5. Solid risers are not required for alternating tread devices constructed in accordance with Section [~~1009.10~~] 1011.14.

[1009.5] 1011.6 Stairway landings. There shall be a floor or landing at the top and bottom of each stairway. The width of landings shall be not [be] less than the width of stairways [they serve] served. Every landing shall have a minimum [dimension] width measured [in] perpendicular to the direction of travel equal to the width of the stairway. [Such dimension] Where the stairway has a straight run, the depth need not exceed 48 inches ([1219] 1220 mm) [where the stairway has a straight run]. Doors opening onto a landing shall not reduce the landing to less than one-half the required width. When fully open, the door shall not project more than 7 inches (177.8 mm) into a landing. When wheelchair spaces are required on the stairway landing in accordance with Section [1007.6.1] 1009.6.3, the wheelchair space shall not be located in the required width of the landing and doors shall not swing over the wheelchair spaces.~~[Where doors open onto a stairway landing, such landing shall also comply with Section 1008.1.6.]~~

Exception: ~~[Aisle stairs complying with Section 1028]~~ Where stairways connect stepped aisles to cross aisles or concourses, stairway landings are not required at the transition between stairways and stepped aisles constructed in accordance with Section 1029.

[1009.6] 1011.7 Stairway construction. ~~[All stairways]~~ Stairways shall be built of materials consistent with the types permitted for the type of construction of the building, except that wood handrails shall be permitted for all types of construction.

[1009.6.1] 1011.7.1 Stairway walking surface. The walking surface of treads and landings of a stairway shall not be sloped steeper than one unit vertical in 48 units horizontal (2-percent slope) in any direction. Stairway treads and landings shall have a solid surface. Finish floor surfaces shall be securely attached.

Exceptions:

1. Openings in stair walking surfaces shall be a size that does not permit the passage of ½-inch~~[diameter]~~ (12.7 mm) diameter sphere. Elongated ~~[opening]~~ openings shall be placed so that the long dimension is perpendicular to the direction of travel.
2. In Group F, H and S occupancies, other than areas of parking structures accessible to the public, openings in treads and landings shall not be prohibited provided a sphere with a diameter of 1⅝ inches (~~[29]~~ 28.6 mm) cannot pass through the opening.

[1009.6.2] 1011.7.2 Outdoor conditions. Outdoor stairways and outdoor approaches to stairways shall be designed so that water will not accumulate on walking surfaces. In ~~[other than]~~ occupancies [in] other than Group R-3~~[,]~~ and occupancies in Group U that are accessory to an occupancy in Group R-3, treads, platforms and landings that are part of exterior stairways in climates subject to snow or ice shall be protected to prevent the accumulation of same.

[1009.6.3] 1011.7.3 Enclosures under interior stairways. The walls and soffits within enclosed usable spaces under enclosed and unenclosed stairways shall be protected by 1-hour fire-resistance-rated construction or the fire-resistance rating of the stairway enclosure, whichever is greater. Access to the enclosed space shall not be directly from within the ~~[stair]~~ stairway enclosure.

Exception: Spaces under stairways serving and contained within a single residential dwelling unit in Group R-2 or R-3 shall be permitted to be protected on the enclosed side with ½-inch (12.7 mm) gypsum board.

1011.7.4 Enclosures under exterior stairways. There shall not be ~~no~~ enclosed usable space under exterior exit stairways unless the space is completely enclosed in 1-hour fire-resistance-rated construction. The open space under exterior stairways shall not be used for any purpose.

~~[1009.7]~~ **1011.8 Vertical rise.** A flight of stairs shall not have a vertical rise greater than 12 feet (~~[3658]~~ 3657.6 mm) between floor levels or landings.

Exceptions:

1. Aisle stairs ~~[empty]~~ complying with Section ~~[1028]~~ 1029.
2. Alternating tread devices ~~[used as means of egress shall not have a rise greater than 20 feet (6096 mm) between floor levels or landings]~~ complying with Section 1011.14.
3. Spiral stairways used as a means of egress from technical production areas.

~~[1009.8]~~ **1011.9 Curved stairways.** Curved stairways with winder treads shall have treads and risers in accordance with Section ~~[1009.4]~~ 1011.5 and the smallest radius shall ~~not~~ be not less than twice the minimum width or required [width] capacity of the stairway, whichever is greater.

Exception: The radius restriction shall not apply to curved stairways ~~[for occupancies]~~ in Group R-3 and within individual dwelling units in ~~[occupancies in]~~ Group R-2.

~~[1009.9]~~ **1011.10 Spiral stairways.** Spiral stairways are permitted to be used as a component in the means of egress only within dwelling units or from a space not more than 250 square feet (~~[23]~~ 23.2 m²) in area and serving not more than five occupants, or from ~~[galleries, catwalks and gridirons]~~ technical production areas in accordance with Section ~~[1015.6]~~ 410.6.

A spiral stairway shall have a ~~[7.5]~~ 7½-inch (~~[194]~~ 190.5 mm) minimum clear tread depth at a point 12 inches (~~[305]~~ 304.8 mm) from the narrow edge. The risers shall be sufficient to provide a headroom of 78 inches (~~[1981]~~ 1981.2 mm) minimum, but riser height shall not be more than ~~[9.5]~~ 9½ inches (~~[244]~~ 241.3 mm). The minimum stairway clear width at and below the handrail shall be 26 inches (~~[660]~~ 660.4 mm).

1011.11 Handrails. Stairways shall have handrails on each side and shall comply with Section 1014. Where glass is used to provide the handrail, the handrail shall also comply with Section 2407.

Exceptions:

1. Stairways within dwelling units and spiral stairways are permitted to have a handrail on one side only.
2. Decks, patios and walkways that have a single change in elevation where the landing depth on each side of the change of elevation is greater than what is required for a landing do not require handrails.

3. In Group R-3 occupancies, a change in elevation consisting of a single riser at an entrance or egress door does not require handrails.
4. Changes in room elevations of only one riser within dwelling units and sleeping units in Group R-2 and R-3 do not require handrails.
5. One handrail shall be allowed in enclosed interior exit stairways less than 44 inches (1117.6 mm) wide that do not serve as an accessible means of egress.
6. Handrails for ramped aisles and stepped aisles shall comply with Section 1029.15.

1011.12 Stairway to roof and roof access. In buildings four or more stories or more than 40 feet (12 192 mm) in height above grade, one stairway shall extend to the roof surface through a stairway bulkhead complying with Section 1510.2, unless the roof has a slope steeper than 20 degrees (0.35 rad). Access to setback roof areas may be through a door or window opening to the roof. Stairways terminating at the level of a setback shall provide access to the setback roof areas, except where the setback is less than 4 feet (1220 mm) in width and 10 feet (3048 mm) in length, measured from the inside of the parapet wall.

1011.12.1 Occupancy Groups I-1, R-1 and R-2. In buildings in Occupancy Groups I-1, R- 1 and R-2 two stories or more in height, with roofs having a slope of 15 degrees (0.26 rad) or less, all interior exit stairways, except those terminating at the level of a setback roof, shall extend to the roof surface.

Exceptions:

1. In buildings in Occupancy Groups R- 1 and R-2 that are two stories in height and in Occupancy Group R-2 that are three stories in height with not more than one dwelling unit per story, access to the roof shall be permitted to be a noncombustible roof hatch or trap door not less than 21 inches (533.4 mm) in width and 28 inches (711.2 mm) in length. Such hatches shall be located within the interior exit stairway enclosure and be provided with a stationary, noncombustible access ladder or alternating tread device.
2. In buildings in Occupancy Group R-2 complying with Item 6 of Section 1006.3.2, roof access shall be governed by Item 6.6 of such section.

1011.12.2 Stairway to elevator equipment. Roofs and penthouses containing elevator equipment that must be accessed for maintenance are required to be accessed by a stairway.

1011.13 Guards. Guards shall be provided along stairways and landings where required by Section 1015 and shall be constructed in accordance with Section 1015. Where the roof hatch opening providing the required access is located within 10 feet (3049 mm) of the roof edge, such roof access or roof edge shall be protected by guards installed in accordance with Section 1015.

~~[1009.10]~~ **1011.14 Alternating tread devices.** Alternating tread devices are limited to an element of a means of egress in buildings of Groups F, H and S from a mezzanine not more than 250 square feet ([23] 23.2 m²) in area and [which] that serves not more than five occupants; in buildings of Group I-3 from a guard tower, observation station or control room not more than 250 square feet ([23] 23.2

m²) in area and for access to unoccupied roofs. Alternating tread devices used as a means of egress shall not have a rise greater than 20 feet (6096 mm) between floor levels or landings.

~~[1009.10.1]~~ **1011.14.1 Handrails of alternating tread devices.** Handrails shall be provided on both sides of alternating tread devices and shall comply with Section ~~[4012]~~ 1014.

~~[1009.10.2]~~ **1011.14.2 Treads of alternating tread devices.** Alternating tread devices shall have a minimum ~~[projected]~~ tread depth of 5 inches (127 mm), a minimum projected tread depth of ~~[8.5]~~ 8½ inches (216) 215.9 mm, a minimum tread width of 7 inches (~~[178]~~ 177.8 mm) and a maximum riser height of ~~[9.5]~~ 9½ inches (241) 241.3 mm. The ~~[projected]~~ tread depth shall be measured horizontally between the vertical planes of the foremost projections of adjacent treads. The riser height shall be measured vertically between the leading edges of adjacent treads. The ~~[combination of]~~ riser height and ~~[projected]~~ tread depth provided shall result in an ~~[alternating tread device]~~ angle ~~[that complies with Section 1002]~~ of ascent from the horizontal of between 50 and 70 degrees (0.87 and 1.22 rad). The initial tread of the device shall begin at the same elevation as the platform, landing or floor surface.

Exception: Alternating tread devices used as an element of a means of egress in buildings from a mezzanine area not more than 250 square feet (~~[23]~~ 23.2 m²) in ~~[an]~~ area ~~[which]~~ that serves not more than five occupants shall have a minimum tread depth of 3 inches (76.2 mm) with a minimum projected tread ~~[of 8.5 inches (216 mm) with a minimum tread]~~ depth of ~~[10.5]~~ 10½ inches (267 mm). The rise to the next alternating tread surface ~~[should]~~ shall not ~~[be more than]~~ exceed 8 inches (~~[203]~~ 203.2 mm).

~~[1009.11 Ship]~~ **1011.15 Ships ladders.** ~~[Ship]~~ Ships ladders are permitted to be used in Group I-3 as a component of a means of egress to and from control rooms or elevated facility observation stations not more than 250 square feet (~~[23]~~ 23.2 m²) with not more than three occupants and for access to unoccupied roofs. The minimum clear width at and below the handrails shall be 20 inches (508 mm).

1011.15.1 Handrails of ships ladders. Handrails shall be provided on both sides of ships ladders.

1011.15.2 Treads of ships ladders. ~~[Ship]~~ Ships ladders shall have a minimum tread depth of 5 inches (127 mm). The tread shall be projected such that the total of the tread depth plus the nosing projection is ~~[no]~~ not less than 8½ inches (~~[216]~~ 215.9 mm). The maximum riser height shall be 9½ inches (~~[241]~~ 241.3 mm).

~~[Handrails shall be provided on both sides of ship ladders. The minimum clear width at and below the handrails shall be 20 inches (508 mm).]~~

1011.16 Ladders. Permanent ladders shall not serve as a part of the means of egress from occupied spaces within a building. Permanent ladders constructed in accordance with Section 306.5 of the *New York City Mechanical Code* shall be permitted to provide access to the following areas:

1. Spaces frequented only by personnel for maintenance, repair or monitoring of equipment.
2. Nonoccupiable spaces accessed only by catwalks, crawl spaces, freight elevators or very narrow passageways.

3. Raised areas used primarily for purposes of security, life safety or fire safety including, but not limited to, observation galleries, prison guard towers, fire towers or lifeguard stands.
4. Elevated levels in Group U not open to the general public.
5. Roofs that are permitted to have noncombustible access ladders in accordance with Section 1011.12.1.
6. Technical production areas in assembly occupancies.

~~[1009.12 Handrails. Stairways shall have handrails on each side and shall comply with Section 1012. Where glass is used to provide the handrail, the handrail shall also comply with Section 2407.]~~

- ~~[1. Handrails for aisle stairs are not required where permitted by Section 1028.13.]~~
- ~~[2. Stairways within dwelling units, spiral stairways and aisle stairs serving seating only on one side are permitted to have a handrail on one side only.]~~
- ~~[3. Decks, patios and walkways that have a single change in elevation where the landing depth on each side of the change of elevation is greater than what is required for a landing do not require handrails.]~~
- ~~[4. In Group R-3 occupancies, a change in elevation consisting of a single riser at an entrance or egress door does not require handrails.]~~
- ~~[5. Changes in room elevations of only one riser within dwelling units and sleeping units in Group R-2 and R-3 occupancies do not require handrails.]~~
- ~~[6. One handrail shall not be allowed in enclosed exit stairs less than 44 inches (1118 mm) wide that do not serve as an accessible means of egress.]~~

~~[1009.13 Stairway to roof and roof access. In buildings four or more stories or more than 40 feet (12 192 mm) in height above grade, one stairway shall extend to the roof surface through a stairway bulkhead complying with Section 1509.2, unless the roof has a slope steeper than 20 degrees (0.35 rad). Access to setback roof areas may be through a door or window opening to the roof. Stairs terminating at the level of a setback shall provide access to the setback roof areas, except where the setback is less than 4 feet (1219 mm) in width and 10 feet (3048 mm) in [length, measured from the inside of the parapet wall.]~~

~~[1009.13.1 Occupancy Groups I-1, R-1 and R-2. In buildings in Occupancy Groups I-1, R-1 and R-2 two stories or more in height, with roofs having a slope of 15 degrees (0.26 rad) or less, all interior stairs, except those terminating at the level of a setback roof, shall extend to the roof surface.]~~

- ~~[1. In buildings in Occupancy Groups R-1 and R-2 two stories in height and in Occupancy Group R-2 three stories in height with not more than one dwelling unit per story, access to the roof shall be permitted to be a noncombustible roof hatch or trap door not less than 21 inches (533 mm) in width and 28 inches (711 mm) in length. Such hatches shall be~~

located within the stair enclosure and be provided with a stationary, noncombustible access ladder or alternating tread device.]

[2. In buildings in Occupancy Group R-2 complying with Item 4 of Section 1021.2, roof access shall be governed by Item 4.6 of such section.]

~~[1009.13.2 Protection at roof hatch openings. Where the roof hatch opening providing the required access is located within 10 feet (3049 mm) of the roof edge, such roof access or roof edge shall be protected by guards installed in accordance with the provisions of Section 1013.]~~

~~[1009.14 Stairway to elevator equipment. Roofs and penthouses containing elevator equipment that must be accessed for maintenance are required to be accessed by a stairway.]~~

SECTION BC ~~[4010]~~ 1012 RAMPS

~~[1010.1] 1012.1 Scope.~~ The provisions of this section shall apply to ramps used as a component of a means of egress.

Exceptions:

1. Other than ramps that are part of the accessible routes providing access in accordance with Sections 1108.2 through 1108.2.4 and 1108.2.6, ramped aisles within assembly rooms or spaces shall ~~[conform]~~ comply with the provisions in Section ~~[4028.11]~~ 1029.
2. Curb ramps shall comply with ICC A117.1.
3. Vehicle ramps in parking garages for pedestrian exit access shall not be required to comply with Sections ~~[4010.3]~~ 1012.3 through ~~[4010.9 when]~~ 1012.10 where they are not an accessible route serving accessible parking spaces, other required accessible elements or part of an accessible means of egress.

~~[1010.2] 1012.2 Slope.~~ Ramps used as part of a means of egress or part of an accessible route shall have a running slope not steeper than one unit vertical in 12 units horizontal (8-percent slope). The slope of other pedestrian ramps shall not be steeper than one unit vertical in eight units horizontal (12.5-percent slope).

Exceptions:

1. Aisle ramp slope in occupancies of Group A shall comply with Section ~~[4028.11]~~ 1029.13.
2. In garages three stories or less in height and serving not more than one level below grade, ramps with a maximum slope of one unit vertical in seven units horizontal (14-percent slope) may serve as part of a nonaccessible means of egress.

~~[1010.3] 1012.3 Cross slope.~~ The slope measured perpendicular to the direction of travel of a ramp shall not be steeper than one unit vertical in 48 units horizontal (2-percent slope).

[1010.4] 1012.4 Vertical rise. The rise for any ramp run shall be 30 inches (762 mm) maximum.

[1010.5] 1012.5 Minimum dimensions. The minimum dimensions of means of egress ramps shall comply with Sections ~~[1010.5.1]~~ 1012.5.1 through ~~[1010.5.3]~~ 1012.5.3.

[1010.5.1] 1012.5.1 Width and capacity. The minimum width and required capacity of a means of egress ramp shall be not [be] less than that required for corridors by Section ~~[1018.2]~~ 1020.2. The clear width of a ramp between handrails, if provided, or other permissible projections shall be 36 inches (~~[914]~~ 914.4 mm) minimum.

[1010.5.2] 1012.5.2 Headroom. The minimum headroom in all parts of the means of egress ramp shall be not [be] less than 84 inches (~~[2134]~~ 2133.6 mm).

[1010.5.3] 1012.5.3 Restrictions. Means of egress ramps shall not reduce in width in the direction of egress travel. Projections into the required ramp and landing width are prohibited. Doors opening onto a landing shall not reduce the clear width to less than 42 inches (~~[1067]~~ 1066.8 mm).

[1010.6] 1012.6 Landings. Ramps shall have landings at the bottom and top of each ramp, points of turning, entrance, exits and at doors. Landings shall comply with Sections ~~[1010.6.1]~~ 1012.6.1 through ~~[1010.6.5]~~ 1012.6.5.

[1010.6.1] 1012.6.1 Slope. Landings shall have a slope not steeper than one unit vertical in 48 units horizontal (2-percent slope) in any direction. Changes in level are not permitted.

[1010.6.2] 1012.6.2 Width. The landing width shall be ~~[at least as wide as]~~ not less than the width of the widest ramp run adjoining the landing.

[1010.6.3] 1012.6.3 Length. The landing length shall be 60 inches (1525 mm) minimum.

Exceptions:

1. In Group R-2 and R-3 individual dwelling and sleeping units that are not required to be Accessible units, Type B+NYC units or Type B units in accordance with Section 1107, landings are permitted to be 36 inches (~~[914]~~ 914.4 mm) minimum.
2. Where the ramp is not a part of an accessible route, the length of the landing shall not be required to be more than 48 inches (1220 mm) in the direction of travel.

[1010.6.4] 1012.6.4 Change in direction. Where changes in direction of travel occur at landings provided between ramp runs, the landing shall be 60 inches by 60 inches (1524 mm by 1524 mm) minimum.

Exception: In Group R-2 and R-3 individual dwelling or sleeping units that are not required to be Accessible units, Type B+NYC units or Type B units in accordance with Section 1107, landings are permitted to be 36 inches by 36 inches (~~[914]~~ 914.4 mm by ~~[914]~~ 914.4 mm) minimum.

~~[1010.6.5]~~ **1012.6.5 Doorways.** Where doorways are located adjacent to a ramp landing, maneuvering clearances required by ICC A117.1 are permitted to overlap the required landing area.

~~[1010.7]~~ **1012.7 Ramp construction.** ~~[All ramps]~~ Ramps shall be built of materials consistent with the types permitted for the type of construction of the building~~[;]~~, except that wood handrails shall be permitted for all types of construction. ~~[Ramps used as an exit shall conform to the applicable requirements of Sections 1022.1 and 1022.3 through 1022.5 for vertical exit enclosures.]~~

~~[1010.7.1]~~ **1012.7.1 Ramp surface.** The surface of ramps shall be of slip-resistant materials that are securely attached.

~~[1010.7.2]~~ **1012.7.2 Outdoor conditions.** Outdoor ramps and outdoor approaches to ramps shall be designed so that water will not accumulate on walking surfaces. In other than occupancies in Group R-3, and occupancies in Group U that are accessory to an occupancy in Group R-3, surfaces and landings which are part of exterior exit ramps in climates subject to snow or ice shall be designed to minimize the accumulation of same.

~~[1010.8]~~ **1012.8 Handrails.** Ramps with a rise greater than 6 inches (~~[152]~~ 152.4 mm) shall have handrails on both sides. Handrails shall comply with Section ~~[1012]~~ 1014.

Exception: Handrails for ramped aisles are not required where permitted by Section ~~[1028.13]~~ 1029.15.

1012.9 Guards. Guards shall be provided where required by Section 1015 and shall be constructed in accordance with Section 1015. Such guards may be used to satisfy the requirement of edge protection of Section 1012.10.

~~[1010.9]~~ **1012.10 Edge protection.** Edge protection complying with Section ~~[1010.9.1]~~ 1012.10.1 shall be provided on each side of ramp runs and at each side of ramp landings not adjoining another ramp run or stairway.

Exceptions:

1. Edge protection is not required on ramps that are not required to have handrails, provided they have flared sides that comply with the ICC A117.1 curb ramp provisions.
2. Edge protection is not required on the sides of ramp landings having a vertical dropoff of not more than ~~[0.5]~~ ½ inch (~~[13 mm]~~) (12.7 mm) within 10 inches (254 mm) horizontally of the required landing area.
3. Edge protection is not required where the floor or ground surface of the ramp run or landing extends 12 inches (~~[305]~~ 304.8 mm) minimum beyond the inside face of handrail complying with Section ~~[1012]~~ 1014.

~~[1010.9.1]~~ **1012.10.1 Curb, rail, wall or barrier.** A curb, rail, wall or barrier serving as edge protection shall be provided as follows:

1. Solid barriers. Solid barriers shall extend at least 4 inches ([402] 101.6 mm) from the floor or ground surface.
2. Other types of barriers. Other types of barriers shall prevent the passage of a 4-inch-~~diameter~~ ([402] 101.6 mm) diameter sphere, where any portion of the sphere is within 4 inches ([402] 101.6 mm) of the floor or ground surface.

~~[1010.10 Guards. Guards shall be provided where required by Section 1013 and shall be constructed in accordance with Section 1013. Such guards may be used to satisfy the requirement of edge protection of Section 1010.9.]~~

SECTION BC [404] 1013 **EXIT SIGNS**

~~[1011.1] **1013.1 Where required.**~~ Exits and exit access doors shall be marked by an approved exit sign readily visible from any direction of egress travel. The path of egress travel to exits and within exits shall be marked by readily visible exit signs to clearly indicate the direction of egress travel in cases where the exit or the path of egress travel is not immediately visible to the occupants. Intervening means of egress doors within exits shall be marked by exit signs. Exit sign placement shall be such that no point in an exit access corridor or exit passageway is more than 100 feet (30 480 mm) or the listed viewing distance for the sign, whichever is less, from the nearest visible exit sign.

Exceptions:

1. Exit signs are not required in rooms or areas that require only one exit or exit access.
2. Exit signs are not required in occupancies in Group U and individual sleeping units or dwelling units in Group I-1 or R. However, in a congregate living unit where the occupancy of such unit exceeds four people, exit signs shall be provided.
3. Exit signs are not required in dayrooms, sleeping rooms or dormitories in occupancies in Group I-3.
4. In occupancies in Groups A-4 and A-5, exit signs are not required on the seating side of vomitories or openings into seating areas where exit signs are provided in the concourse that are readily apparent from the vomitories. Such vomitories shall be provided with emergency egress lighting to identify each vomitory or opening within the seating area.

~~[1011.1.1] **1013.1.1 Signs within exits in high-rise buildings.**~~ In high-rise buildings subject to Section 403, exit signs shall be placed within exits at horizontal extensions to indicate the transition from vertical to horizontal direction an at turns along the horizontal path.

1013.2 Floor-level exit signs in Group R-1. Where exit signs are required in Group R-1 occupancies by Section 1013.1, additional low-level exit signs shall be provided in all areas serving guest rooms in Group R-1 occupancies and shall comply with Section 1013.5.

The bottom of the sign shall be not less than 10 inches (254 mm) nor more than 12 inches (304.8 mm) above the floor level. The sign shall be flush mounted to the door or wall. Where mounted on the wall, the edge of the sign shall be within 4 inches (101.6 mm) of the door frame on the latch side.

~~[1011.2]~~ **1013.3 Illumination.** Exit signs shall be internally or externally illuminated.

Exception: Tactile signs required by Section ~~[4011.3]~~ 1013.4 need not be provided with illumination.

~~[1011.3 Tactile]~~ **1013.4 Raised character and braille exit signs.** A ~~[tactile]~~ sign stating “EXIT” in visual characters, raised characters and braille and complying with ICC A117.1 shall be provided adjacent to each door to an area of rescue assistance, an exterior area for assisted rescue, ~~[an exit stairway,]~~ an exit stairway or ramp, an exit passageway, a horizontal exit and the exit discharge.

~~[1011.4]~~ **1013.5 Internally illuminated exit signs.** Electrically powered exit signs shall be listed and labeled in accordance with UL 924, except that letters of exit signs shall be red. Exit signs shall be installed in accordance with the manufacturer’s instructions and Chapter 27 of this code. Exit signs shall be illuminated at all times. The letters of exit signs shall be red.

~~[1011.4.1]~~ **1013.5.1 Graphics.** The height of letters shall be not less than 6 inches (~~[152]~~ 152.4 mm), except that in Group A and Group R-1 occupancies letters shall be not less than 8 inches (~~[203]~~ 203.2 mm) high. Graphics shall have letter widths, strokes and spacing in proportion to their height.

~~[4011.5]~~ **1013.6 Externally illuminated exit signs.** Externally illuminated exit signs shall comply with Sections ~~[4011.5.1]~~ 1013.6.1 through ~~[4011.5.3]~~ 1013.6.3.

~~[1011.5.1]~~ **1013.6.1 Graphics.** Every exit sign and directional exit sign shall have plainly legible letters not less than 6 inches (~~[152]~~ 152.4 mm) high with the principal strokes of the letters not less than ~~[0.75]~~ $\frac{3}{4}$ inch (19.1 mm) wide. The word “EXIT” shall have letters having a width not less than 2 inches (~~[54]~~ 50.8 mm) wide, except the letter “I,” and the minimum spacing between letters shall be not less than ~~[0.375]~~ $\frac{3}{8}$ inch (9.5 mm). In Group A and R-1 occupancies letters shall be not less than 8 inches (~~[203]~~ 203.2 mm) high. Signs larger than the minimum established in this section shall have letter widths, strokes and spacing in proportion to their height.

The word “EXIT” shall be in high contrast with the background and shall be clearly discernible when the means of exit sign illumination is or is not energized. The letters of exit signs shall be red. If a chevron directional indicator is provided as part of the exit sign, the construction shall be such that the direction of the chevron directional indicator cannot be readily changed.

~~[4011.5.2]~~ **1013.6.2 Exit sign illumination.** The face of an exit sign illuminated from an external source shall have an intensity of not less than 25 ~~[foot-candles]~~ footcandles (269.1 lux).

~~[1011.5.3]~~ **1013.6.3 Power source.** Exit signs shall be illuminated at all times. To ensure continued illumination for a duration of not less than 90 minutes in case of primary power loss, the sign illumination means shall be connected to an emergency power system provided from storage batteries, unit equipment or an on-site generator. The installation of the emergency power system shall be in accordance with Chapter 27.

SECTION BC ~~[1012]~~ **1014** HANDRAILS

~~[1012.1]~~ **1014.1 Where required.** Handrails ~~[for stairways and ramps]~~ servicing stairways, ramps, stepped aisles and ramped aisles shall be adequate in strength and attachment in accordance with Section ~~[1607.7]~~ 1607.8. Handrails required for stairways by Section ~~[1009.12]~~ 1011.11 shall comply with Sections ~~[1012.2]~~ 1014.2 through ~~[1012.9]~~ 1014.9. Handrails required for ramps by Section ~~[1010.8]~~ 1012.8 shall comply with Sections ~~[1012.2]~~ 1014.2 through ~~[1012.8]~~ 1014.8. Handrails for stepped aisles and ramped aisles required by Section 1029.15 shall comply with Sections 1014.2 through 1014.8.

~~[1012.2]~~ **1014.2 Height.** Handrail height, measured above stair tread nosings, or finish surface of ramp slope, shall be uniform, not less than 34 inches (~~[864]~~ 863.4 mm) and not more than 38 inches (~~[965]~~ 965.2 mm). Handrail height of alternating tread devices and ~~[ship]~~ ships ladders, measured above tread nosings, shall be uniform, not less than 30 inches (762 mm) and not more than 34 inches (~~[864]~~ 863.4 mm).

Exceptions:

1. Where handrail fittings or bendings are used to provide continuous transition between flights, the fittings or bendings shall be permitted to exceed the maximum height.
2. In Group R-3 occupancies; within dwelling units in Group R-2 occupancies; and in Group U occupancies that are associated with a Group R-3 occupancy or associated with individual dwelling units in Group R-2 occupancies; where handrail fittings or bendings are used to provide continuous transition between flights, transition at winder treads, transition from handrail to guard, or where used at the start of a flight, the handrail height at the fittings or bendings shall be permitted to exceed the maximum height.
3. Top surface of a guard where permitted to be used as a handrail along stepped aisles and ramped aisles in accordance with Section 1029.15.

~~[1012.3]~~ **1014.3 Handrail graspability.** ~~[All required]~~ Required handrails shall comply with Section ~~[1012.3.1]~~ 1014.3.1 or shall provide equivalent graspability.

Exception: In Group R-3 occupancies; within dwelling units in Group R-2 occupancies; and in Group U occupancies that are accessory to a Group R-3 occupancy or accessory to individual dwelling units in Group R-2 occupancies; handrails shall be Type I in accordance with Section ~~[1012.3.1]~~ 1014.3.1, Type II in accordance with Section ~~[1012.3.2]~~ 1014.3.2, or shall provide equivalent graspability.

~~[1012.3.1]~~ **1014.3.1 Type I.** Handrails with a circular cross section shall have an outside diameter of ~~[at least]~~ not less than 1¼ inches (~~[32]~~ 31.75 mm) and not greater than 2 inches (~~[51]~~ 50.8 mm). ~~[If]~~ Where the handrail is not circular, it shall have a perimeter dimension of ~~[at least]~~ not less than 4 inches (~~[102]~~ 101.6 mm) and not greater than 6¼ inches (~~[160]~~ 158.75 mm) with a maximum cross-~~[section]~~ sectional dimension of 2¼ inches (~~[57]~~ 57.15 mm) and minimum cross-sectional dimension of 1 inch (25.4 mm). Edges shall have a minimum radius of 0.01 inch (0.25 mm).

[1012.3.2] 1014.3.2 Type II. Handrails with a perimeter greater than 6¼ inches ([160] 158.75 mm) shall provide a graspable finger recess area on both sides of the profile. The finger recess shall begin within a distance of ¾ inch (19 mm) measured vertically from the tallest portion of the profile and achieve a depth of [~~at least~~] not less than 5/16 inch ([8] 7.9 mm) within 7/8 inch (22 mm) below the widest portion of the profile. This required depth shall continue for [~~at least~~] not less than 3/8 inch ([10] 9.6 mm) to a level that is not less than 1¾ inches ([45] 44.5 mm) below the tallest portion of the profile. The [~~minimum~~] width of the handrail above the recess shall be not less than 1¼ inches ([32] 31.75 mm) to [~~a maximum~~] not greater than of 2¾ inches ([70] 69.9 mm). Edges shall have a minimum radius of 0.01 inch (0.25 mm).

[1012.4] 1014.4 Continuity. [~~Handrail gripping~~] Handrail gripping surfaces shall be continuous, without interruption by newel posts or other obstructions.

Exceptions:

1. Handrails within dwelling units are permitted to be interrupted by a newel post at a turn or landing.
2. Within a dwelling unit, the use of a volute, turnout, starting easing or starting newel is allowed over the lowest tread.
3. Handrail brackets or balusters attached to the bottom surface of the handrail that do not project horizontally beyond the sides of the handrail within 1½ inches ([38] 38.1 mm) of the bottom of the handrail shall not be considered obstructions. For each ½ inch (12.7 mm) of additional handrail perimeter dimension above 4 inches ([102] 101.6 mm), the vertical clearance dimension of 1½ inches ([38] 38.1 mm) shall be permitted to be reduced by 1/8 inch [~~(3 mm)~~] (3.2 mm).
4. Where handrails are provided along walking surfaces with slopes not steeper than 1:20 (5-percent slope), the bottoms of the handrail gripping surfaces shall be permitted to be obstructed along their entire length where they are integral to crash rails or bumper guards.
5. Handrails serving stepped aisles or ramped aisles are permitted to be discontinuous in accordance with Section 1029.15.1.

[1012.5] 1014.5 Fittings. Handrails shall not rotate within their fittings.

[1012.6] 1014.6 Handrail extensions. Handrails shall return to a wall, guard or the walking surface or shall be continuous to the handrail of an adjacent [~~stair~~] flight of stairs or ramp run. Where handrails are not continuous between flights, the handrails shall extend horizontally [~~at least~~] not less than 12 inches ([305] 304.8 mm) beyond the top riser and continue to slope for the depth of one tread beyond the bottom riser. At ramps where handrails are not continuous between runs, the handrails shall extend horizontally above the landing 12 inches ([305] 304.8 mm) minimum beyond the top and bottom of ramp runs. The extensions of handrails shall be in the same direction of the [~~stair~~] flights of stairs at stairways and the ramp runs at ramps.

Exceptions:

1. Handrails within a dwelling unit that is not an Accessible unit, Type B+NYC unit, or Type B unit need extend only from the top riser to the bottom riser.
2. Handrails within a Type B+NYC multistory dwelling unit that complies with Section 1107.2.5, Items 1 through 3, need extend only from the top riser to the bottom riser.
3. ~~[Aisle handrails in Group A and E occupancies in accordance with Section 1028.13.]~~ Handrails serving aisles in rooms or spaces used for assembly purposes are permitted to comply with the handrail extensions in accordance with Section 1029.15.
4. Handrails for alternating tread devices and ~~[ship]~~ ships ladders are permitted to terminate at a location vertically above the top and bottom risers. Handrails for alternating tread devices and ship ladders are not required to be continuous between flights or to extend beyond the top or bottom risers.

~~[1012.7]~~ **1014.7 Clearance.** Clear space between a handrail and a wall or other surface shall be ~~[a minimum of]~~ not less than 1½ inches (~~[38]~~ 38.1 mm). A handrail and a wall or other surface adjacent to the handrail shall be free of any sharp or abrasive elements.

~~[1012.8]~~ **1014.8 Projections.** On ramps and on ramped aisles that are part of an accessible route, the clear width between handrails shall be 36 inches (~~[914]~~ 914.4 mm) minimum. Projections into the required width of aisles, stairways and ramps at each ~~[handrail]~~ side shall not exceed 4½ inches (~~[114]~~ 114.3 mm) at or below the handrail height. Projections into the required width shall not be limited above the minimum headroom height required in Section ~~[4009.2.]~~ 1011.3. Projections due to intermediate handrails shall not constitute a reduction in the egress width.

Exception: The available egress width shall be reduced by the distance between the closest edges of a pair of intermediate handrails where:

1. Such pair of intermediate handrails are provided within the stairway width without a walking surface between the pair; and
2. The distance between the closest edges of such pair of intermediate handrails is greater than 6 inches (152.4 mm).

~~[1012.9]~~ **1014.9 Intermediate handrails.** Stairways shall have intermediate handrails located in such a manner that all portions of the stairway minimum width or required ~~[for egress]~~ capacity are within 30 inches (762 mm) of a handrail. On monumental stairs, handrails shall be located along the most direct path of egress travel.

SECTION BC ~~[4013]~~ **1015** GUARDS

1015.1 General. Guards shall comply with the provisions of Sections 1015.2 through 1015.7. Operable windows with sills located more than 72 inches (1828.8 mm) above finished grade or other surface below shall comply with Section 1015.8.

~~[4013.1]~~ **1015.2 Where required.** Guards adequate in strength and attachment in accordance with Section 1607.8 shall be located along open-sided walking surfaces that are more than 30 inches (762

mm) measured vertically to the floor or grade below at any point within 36 inches (914.4 mm) horizontally to the edge of the open side. Such open-sided walking surfaces shall[, including] include, but not be limited to, the following:

1. Roofs and setback roofs such as terraces accessible by a stairway, including those required by Section 1011.12;
2. Where protective guards are required on building roofs pursuant to Section 1510.8;
3. [mezzanines,] Mezzanines;
4. Balconies;
5. [equipment] Equipment platforms[;];
6. Aisles;
7. [stairs,] Stairs;
8. [ramps,] Ramps; and
9. [landings that are located more than 30 inches (762 mm) measured vertically to the floor or grade below at any point within 36 inches (914 mm) horizontally to the edge of the open side. Guards shall be adequate in strength and attachment in accordance with Section 1607.7.] Landings.

Exception: Guards are not required for the following locations:

1. On the loading side of loading docks or piers.
2. On the audience side of stages and raised platforms, including [steps] stairs and ramps leading up to the stage and raised platforms.
3. On raised stage and platform floor areas, such as runways, ramps and side stages used for entertainment or presentations.
4. At vertical openings in the performance area of stages and platforms.
5. At elevated walking surfaces appurtenant to stages and platforms for access to and utilization of special lighting or equipment.
6. Along vehicle service pits not accessible to the public.
7. In assembly seating [where guards] areas at cross aisles in accordance with Section [1028.14 are permitted and provided] 1029.16.2.

[1013.1.1] 1015.2.1 Glazing. Where glass is used to provide a guard or as a portion of the guard system, the guard shall [also] comply with Section 2407. Where the glazing provided does not

meet the strength and attachment requirements of Section ~~[1607.7]~~ 1607.8, complying guards shall ~~[also]~~ be located along glazed sides of open-sided walking surfaces.

~~[1013.2]~~ **1015.3 Height.** Required guards shall be not less than 42 inches (~~[1067]~~ 1066.8 mm) high, measured vertically ~~[above the adjacent walking surfaces, adjacent fixed seating or the line connecting the leading edges of the treads.]~~ as follows:

1. From the adjacent walking surfaces.
2. Where any portion of fixed seating, fixed planters or similar fixed elements are located within 21 inches (533.4 mm) horizontally of the guards, from the upper most surface of such portion of the fixed seating or fixed element.
3. On stairways and stepped aisles, from the line connecting the leading edges of the tread nosings.
4. On ramps and ramped aisles, from the ramp surface at the guard.

Exceptions:

1. For occupancies in Group R-3, and within individual dwelling units in occupancies in Group R-2, guards on the open sides of stairs shall have a height not less than 34 inches (~~[864]~~ 863.4 mm) measured vertically from a line connecting the leading edges of the treads.
2. For occupancies in Group R-3, and within individual dwelling units in occupancies in Group R-2, where the top of the guard also serves as a handrail on the open sides of stairs, the top of the guard shall be not ~~[be]~~ less than 34 inches (~~[864]~~ 863.4 mm) and not more than 38 inches (~~[965]~~ 965.2 mm) measured vertically from a line connecting the leading edges of the treads.
3. The guard height in assembly seating areas shall ~~[be in accordance]~~ comply with Section ~~[1028.14]~~ 1029.16 as applicable.
4. Along alternating tread devices and ~~[ship]~~ ships ladders, guards ~~[whose]~~ where the top rail also serves as a handrail~~[-]~~ shall have height not less than 30 inches (762 mm) and not more than 34 inches (~~[864]~~ 863.4 mm), measured vertically from the leading edge of the device tread nosing.

~~[1013.3]~~ **1015.4 Opening limitations.** Required guards shall not have openings ~~[which]~~ that allow passage of a sphere 4 inches (~~[102]~~ 101.6 mm) in diameter from the walking surface to the required guard height.

Exceptions:

1. From a height of 36 inches (~~[914]~~ 914.4 mm) to 42 inches (~~[1067]~~ 1066.8 mm), guards shall not have openings ~~[which]~~ that allow passage of a sphere 4³/₈ inches (~~[111]~~ 111.1 mm) in diameter.

2. The triangular openings at the open sides of a stair, formed by the riser, tread and bottom rail, shall not allow passage of a sphere 6 inches (~~[152]~~ 152.4 mm) in diameter.
3. At elevated walking surfaces that are not open to the public for access to and use of electrical, mechanical or plumbing systems or equipment, guards shall not have openings [~~which~~] that allow passage of a sphere 21 inches (~~[533]~~ 533.4 mm) in diameter.
4. In areas that are not open to the public within occupancies in Group I-3, F, H or S, and for alternating tread devices and [~~ship~~] ships ladders, guards shall not have openings [~~which~~] that allow passage of a sphere 21 inches (~~[533]~~ 533.4 mm) in diameter.
5. In assembly seating areas, guards required at the end of aisles [~~where they terminate at a fascia of boxes, balconies and galleries~~] in accordance with Section 1029.16.4 shall not have openings [~~which~~] that allow passage of a sphere 4 inches (101.6 mm) in diameter [~~(102 mm)~~] up to a height of 26 inches (~~[660]~~ 660.4 mm). From a height of 26 inches (~~[660]~~ 660.4 mm) to 42 inches (~~[1067]~~ 1066.8 mm) above the adjacent walking surfaces, guards shall not have openings [~~which~~] that allow passage of a sphere 8 inches (~~[203]~~ 203.2 mm) in diameter.
6. Within individual dwelling units and sleeping units in Group R-2 and R-3 occupancies, guards on the open sides of stairs shall not have openings [~~which~~] that allow passage of a sphere $4\frac{3}{8}$ inches (~~[111]~~ 111.1 mm) [~~inches~~] in diameter.

[1013.4] 1015.5 Screen porches. Porches and decks [~~which~~] that are enclosed with insect screening shall be provided with guards where the walking surface is located more than 30 inches (762 mm) above the floor or grade below.

[1013.5] 1015.6 Mechanical equipment, systems and devices. Guards shall be provided where [~~appliances, equipment, fans, roof hatch openings or other~~] various components that require service are located within 10 feet (3048 mm) of a roof edge or open side of a walking surface and such edge or open side is located more than 30 inches (762 mm) above the floor, roof or grade below. The guard shall extend not less than 30 inches (762 mm) beyond each end of such components. The guard shall be constructed so as to prevent the passage of a sphere 21 inches (~~[533]~~ 533.4 mm) in diameter. [~~The guard shall extend not less than 30 inches (762 mm) beyond each end of such appliance, equipment, fan or component.~~]

[1013.6] 1015.7 Roof access. Guards shall be provided where the roof hatch opening is located within 10 feet (3048 mm) of a roof edge or open side of a walking surface and such edge or open side is located more than 30 inches (762 mm) above the floor, roof or grade below. The guard shall be constructed so as to prevent the passage of a sphere 21 inches (~~[533]~~ 533.4 mm) in diameter.

1015.8 Window sills in Group R-3 occupancies. In one- and two-family dwellings, where the opening of the sill portion of an operable window is located more than 72 inches (1828.8 mm) above the finished grade or other surface below, the lowest part of the clear opening of the window shall be at a height not less than 36 inches (914.4 mm) above the finished floor surface of the room in which the window is located. Glazing between the floor and a height of 36 inches (914.4 mm) shall be fixed or have openings through which a 4-inch (101.6 mm) diameter sphere cannot pass.

Exception: Openings that are provided with window guards that comply with ASTM F 2090.

1015.9 Windows and openings in Group R-2 occupancies. Windows and openings that do not allow passageway onto grade, balcony, terrace, setback, roof or other walking surfaces in Group R-2 occupancies shall be subject to the applicable requirements of the New York City Department of Health and Mental Hygiene with regard to window guards.

SECTION BC ~~[4014]~~ 1016 EXIT ACCESS

~~[1014.1]~~ 1016.1 General. The exit access shall comply with the applicable provisions of Sections 1003 through ~~[4013]~~ 1015. Exit access arrangement shall comply with Sections ~~[4014]~~ 1016 through ~~[4019]~~ 1021.

~~[1014.2]~~ 1016.2 Egress through intervening spaces. Egress through intervening spaces shall comply with this section.

1. Exit access through an enclosed elevator lobby is permitted. Access to not less than one of the required exits shall be provided without travel through the enclosed elevator lobbies required by Section 3006. Where the path of exit access travel passes through an enclosed elevator lobby, the level of protection required for the enclosed elevator lobby is not required to be extended to the exit unless direct access to an exit is required by other sections of this code.
2. Egress from a room or space shall not pass through adjoining or intervening rooms or areas, except where such adjoining rooms or areas and the area served are accessory to~~[-]~~ one or the other, are not a Group H occupancy and provide a discernible path of egress travel to an exit.

Exception: Means of egress are not prohibited through adjoining or intervening rooms or spaces in a Group H, S or F occupancy ~~[when]~~ where the adjoining or intervening rooms or spaces are the same or a lesser hazard occupancy group.

~~[2-]~~ 3. An exit access shall not pass through a room that can be locked to prevent egress.

~~[3-]~~ 4. Means of egress from dwelling units or sleeping areas shall not lead through other sleeping areas, toilet rooms or bathrooms.

~~[4-]~~ 5. Egress shall not pass through kitchens, storage rooms, closets or spaces used for similar purposes.

Exceptions:

1. Means of egress are not prohibited through a kitchen area serving adjoining rooms constituting part of the same dwelling unit or sleeping unit.
2. Means of egress are not prohibited through stockrooms in Group M ~~[when]~~ where all of the following are met~~[-]~~:
 - 2.1. The stock is of the same hazard classification as that found in the main retail area ~~[-]~~.

- 2.2. Not more than 50 percent of the exit access is through the stockroom[;].
- 2.3. The stockroom is not subject to locking from the egress side[; and].
- 2.4. There is a demarcated, minimum 44-inch[-wide] ([1118] 1117.6 mm) wide aisle defined by full- or partial-height fixed walls or similar construction that will maintain the required width and lead directly from the retail area to the exit without obstructions.

[1014.2.1] 1016.2.1 Multiple tenants. Where more than one tenant occupies any one floor of a building or structure, each tenant space, dwelling unit and sleeping unit shall be provided with access to the required exits without passing through adjacent tenant spaces, dwelling units and sleeping units.

Exception: The means of egress from a smaller tenant space shall not be prohibited from passing through a larger adjoining tenant space where the following conditions are met:

1. Such rooms or spaces of the smaller tenant occupy less than 10 percent of the area of the larger tenant space through which they pass;
2. The larger tenant is a Group M occupancy and the smaller tenant space is of the same or similar occupancy group;
3. A [~~discernable~~] discernible path of egress travel is provided from the smaller tenant space to an exit;
4. The means of egress into the adjoining space is not subject to locking from the egress side of the smaller tenant space; and
5. The smaller tenant space serves the same occupants, customers, or patrons as the larger tenant space.

~~[1014.2.2 Group I-2. Habitable rooms or suites in Group I-2 occupancies shall have an exit access door leading directly to a corridor.]~~

~~[Exception: Rooms with exit doors opening directly to the outside at ground level to a public way.]~~

~~[1014.2.3 Suites in patient sleeping areas. Patient sleeping areas in Group I-2 occupancies shall be permitted to be divided into suites with one intervening room if one of the following conditions is met:]~~

- ~~[1. The intervening room within the suite is not used as an exit access for more than eight patient beds.]~~
- ~~[2. The arrangement of the suite allows for direct and constant visual supervision by nursing personnel.]~~

~~[1014.2.3.1 Area. Suites of sleeping rooms shall not exceed 5,000 square feet (465 m²).]~~

~~[1014.2.3.2 Exit access. Any patient sleeping room, or any suite that includes patient sleeping rooms, of more than 1,000 square feet (93 m²) shall have at least two exit access doors remotely located from each other.]~~

~~[1014.2.3.3 Travel distance. The travel distance between any point in a suite of sleeping rooms and an exit access door of that suite shall not exceed 100 feet (30 480 mm).]~~

~~[1014.2.4 Suites in areas other than patient sleeping areas. Areas other than patient sleeping areas in Group I-2 occupancies shall be permitted to be divided into suites.]~~

~~[1014.2.4.1 Area. Suites of rooms, other than patient sleeping rooms, shall not exceed 10,000 square feet (929 m²).]~~

~~[1014.2.4.2 Exit access. Any room or suite of rooms, other than patient sleeping rooms, of more than 2,500 square feet (232 m²) shall have at least two exit access doors remotely located from each other.]~~

~~[1014.2.4.3 One intervening room. For rooms other than patient sleeping rooms, suites of rooms are permitted to have one intervening room if the travel distance within the suite to the exit access door is not greater than 100 feet (30 480 mm).]~~

~~[1014.2.4.4 Two intervening rooms. For rooms other than patient sleeping rooms located within a suite, exit access travel from within the suite shall be permitted through two intervening rooms where the travel distance to the exit access door is not greater than 50 feet (15 240 mm).]~~

~~[1014.2.5 Exit access through suites. Exit access from all other portions of a building not classified as a suite in a Group I-2 occupancy shall not pass through a suite.]~~

~~[1014.2.6 Travel distance. The travel distance between any point in a Group I-2 occupancy patient sleeping room and an exit access door in that room shall not exceed 50 feet (15 240 mm).]~~

~~[1014.2.7 Separation. Suites in Group I-2 occupancies shall be separated from other portions of the building by a smoke partition complying with Section 711.]~~

~~[1014.3 Common path of egress travel. In occupancies other than Groups H-1, H-2 and H-3, the common path of egress travel shall not exceed 75 feet (22 860 mm). In Group H-1, H-2 and H-3 occupancies, the common path of egress travel shall not exceed 25 feet (7620 mm). For common path of egress travel in Group A occupancies having fixed seating, see Section 1028.8.]~~

[Exceptions:]

~~[1. The length of a common path of egress travel in Group B, F and S occupancies shall not be more than 100 feet (30 480 mm), provided that the building is equipped throughout with an automatic sprinkler system installed in accordance with Section 903.3.1.1.]~~

~~[2. Where a tenant space in Group B, S and U occupancies has an occupant load of not more than 30, the length of a common path of egress travel shall not be more than 100 feet (30 480 mm).]~~

~~[3. The length of a common path of egress travel in a Group I-3 occupancy shall not be more than 100 feet (30 480 mm).]~~

~~[4. The length of a common path of egress travel in a Group R-2 occupancy shall not be more than 125 feet (38 100 mm), provided that the building is protected throughout with an approved automatic sprinkler system in accordance with Section 903.3.1.1 or 903.3.1.2.]~~

~~[5. The length of a common path of egress travel in Group I-2 occupancies between any point in a suite of sleeping rooms and an exit access door of that suite shall not be more than 100 feet (30 480 mm) in accordance with Section 1014.2.3.3.]~~

[1014.4] 1016.3 Intervening public hall in Group R-2 occupancies. Buildings in Occupancy Group R-2 shall comply with the intervening public hall requirements in accordance with Sections ~~[1014.4.1] 1016.3.1~~ and ~~[1014.4.2] 1016.3.2~~.

[1014.4.1] 1016.3.1 Group R-2 nonhigh-rise occupancies. In buildings in Occupancy Group R-2 not subject to Section 403, a door from a dwelling unit shall open into an intervening public hall. Such public hall shall be constructed as a public corridor in accordance with Section ~~[1018] 1020~~. Opening protectives in accordance with Exception 3 of Section 707.6 shall not be permitted.

Exceptions:

1. No intervening public hall shall be required for any of the following:
 - 1.1. A building that is both three stories or less in height, and contains two or fewer dwelling units per story; or
 - 1.2. A building that complies with Item ~~[4] 6~~ of Section ~~[1021.2] 1006.3.2~~.
2. No intervening public hall shall be required where the doors opening to the apartments are smoke and draft controlled doors complying with UL 1784 without artificial bottom seals, in accordance with ~~[Section] Sections [715.3] 716.5~~ and ~~[715.3.5.3] 716.5.7.3 of this code~~, and the building is equipped throughout with an automatic sprinkler system in accordance with Section 903.3.1 of this code. This exception shall not apply to any building that complies with Item ~~[5] 7~~ of Section ~~[1021.2] 1006.3.2 of this code~~ where there is more than one apartment per story.

[1014.4.2] 1016.3.2 Group R-2 high-rise occupancies. In high-rise buildings in Occupancy Group R-2, all doors from a dwelling unit shall open into an intervening public hall. Such public hall shall be constructed as a public corridor in accordance with Section ~~[1018] 1020~~. Opening protectives in accordance with Exception 3 of Section 707.6 shall not be permitted. Such public hall shall provide access to at least two exits.

Exception: Where the only dwelling units on a story of a building are the upper stories of multi-story (duplex) dwelling units;

1. Any public halls shall be permitted to provide access to only one exit; or
2. No such public hall shall be required where smoke and draft controlled doors

complying with UL 1784 without artificial bottom seals, in accordance with Sections [715.4] 716.5 and [715.4.6.3] 716.5.7.3 of this code, are provided. This exception shall not be construed to effect, alter, or change any requirement of this code to provide two means of egress from each apartment on each story.

**[SECTION BC 1015
EXIT AND EXIT ACCESS DOORWAYS]**

~~[1015.1 Exits or exit access doorways from spaces. Two exits or exit access doorways from any space shall be provided where one of the following conditions exists:]~~

- ~~[1. The occupant load of the space exceeds one of the values in Table 1015.1.]~~
- ~~[2. The common path of egress travel exceeds one of the limitations of Section 1014.3.]~~
- ~~[3. Where required by Section 1015.3, 1015.4, 1015.5, 1015.6 or 1015.6.1.~~

~~Exception: Group I-2 occupancies shall comply with Sections 1014.2.2 through 1014.2.7.]~~

~~[Where a building contains mixed occupancies, each individual occupancy shall comply with the applicable requirements for that occupancy. Where applicable, cumulative occupant loads from adjacent occupancies shall be considered in accordance with the provisions of Section 1004.1.]~~

**[TABLE 1015.1
SPACES WITH ONE EXIT OR EXIT ACCESS DOORWAY]**

OCCUPANCY	MAXIMUM OCCUPANT LOAD
A, B, E ^a , M, U	74
F	49
H 1, H 2, H 3	3
H 4, H 5, I 1, I 3, I 4	10
I-2	See Sections 1014.2.2 through 1014.2.7
R	20
S	29

[a. Day care maximum occupant load is 10.]

~~[1015.1.1 Three or more exits or exit access doorways. Three exits or exit access doorways shall be provided from any space with an occupant load of 501 to 1,000. Four exits or exit access doorways shall be provided from any space with an occupant load greater than 1,000.]~~

~~[1015.2 Exit or exit access doorway arrangement. Required exits shall be located in a manner that makes their availability obvious. Exits shall be unobstructed at all times. Exit and exit access doorways shall be arranged in accordance with Sections 1015.2.1 and 1015.2.2.]~~

~~[1015.2.1 Two exits or exit access doorways. Where two exits or exit access doorways are required from any portion of the exit access, the exit doors or exit access doorways shall be placed a distance apart equal to not less than one half of the length of the maximum overall diagonal dimension of the building or area to be served measured in a straight line between exit doors or exit access doorways. Stairs sharing any common wall, floors, ceilings, scissor stair assemblies, or other enclosures shall be counted as one exit stairway.]~~

[Exceptions:]

~~[1. Corridor measurements. Where exit enclosures are provided as a portion of the required exit and are interconnected by a 1-hour fire resistance-rated corridor conforming to the requirements of Section 1018, the required exit separation shall be measured along the shortest direct line of travel within the corridor.]~~

~~[2. Remote location in sprinklered buildings. Where a building is equipped throughout with an automatic sprinkler system in accordance with Section 903.3.1.1 or 903.3.1.2, the separation distance of the exit doors or exit access doorways shall not be less than one-third of the length of the maximum overall diagonal dimension of the area served.]~~

~~[3. R-2 occupancies. In Group R-2 occupancies, where stairs are enclosed in walls having at least a 2-hour fire resistance rating and constructed of masonry or masonry equivalent in accordance with department rules.]~~

~~[3.1. The exit doors to such stairs shall be placed a distance apart equal to no less than 15 feet (4572 mm); and]~~

~~[3.2. Such stairs shall be permitted to share common walls, floors, ceilings or scissor stairs assemblies or other enclosures provided that the construction separating the stairs is also of at least a 2-hour fire resistance rating and constructed of masonry or masonry equivalent in accordance with department rules.]~~

~~[4. B occupancies. In Group B occupancies of construction Type I or II not exceeding 60 feet (18 288 mm) in height, not exceeding 2,000 square feet (186 m²) on any story and not exceeding a travel distance of 50 feet (15 240 mm) on any story, where stairs are enclosed in walls having at least a 2-hour fire resistance rating and constructed of masonry or masonry equivalent in accordance with department rules.]~~

~~[4.1. The exit doors to such stairs shall be placed a distance apart equal to no less than 15 feet (4572 mm); and]~~

~~[4.2. Such stairs shall be permitted to share common walls, floors, ceilings or scissor stairs assemblies.]~~

~~[1015.2.2 Three or more exits or exit access doorways. Where access to three or more exits is required, at least two exit doors or exit access doorways shall be arranged in accordance with the provisions of Section 1015.2.1.]~~

~~[1015.3 Boiler, incinerator and furnace rooms. Two exit access doorways are required in boiler, incinerator and furnace rooms where the area is over 500 square feet (46 m²) and any fuel fired equipment exceeds 400,000 British thermal units (Btu) (422 000 KJ) input capacity. Where two exit access doorways are required, one is permitted to be a fixed ladder or an alternating tread device. Exit access doorways shall be separated by a horizontal distance equal to one half the length of the maximum overall diagonal dimension of the room.]~~

~~[1015.4 Refrigeration machinery rooms. Machinery rooms larger than 1,000 square feet (93 m²) with refrigeration units or systems having a refrigerant circuit containing more than 220 pounds (100 kg) of Group A1 refrigerant or 30 pounds (14 kg) of any other group refrigerant, as classified in Section 1103.1 of the *New York City Mechanical Code*, shall have not less than two exits or exit access doors. Where two exit access doorways are required, one such doorway is permitted to be served by a fixed ladder or an alternating tread device. Exit access doorways shall be separated by a horizontal distance equal to one half the maximum horizontal dimension of room.]~~

~~[All portions of machinery rooms shall be within 150 feet (45 720 mm) of an exit or exit access doorway. An increase in travel distance is permitted in accordance with Section 1016.1.]~~

~~[Doors shall swing in the direction of egress travel, regardless of the occupant load served. Doors shall be tight fitting and self closing.]~~

~~[1015.5 Refrigerated rooms or spaces. Rooms or spaces having a floor area larger than 1,000 square feet (93 m²), containing a refrigerant evaporator and maintained at a temperature below 68°F (20°C), shall have access to not less than two exits or exit access doors.]~~

~~[Travel distance shall be determined as specified in Section 1016.1, but all portions of a refrigerated room or space shall be within 150 feet (45 720 mm) of an exit or exit access door where such rooms are not protected by an approved automatic sprinkler system. Egress is allowed through adjoining refrigerated rooms or spaces.]~~

~~[Exception: Where using refrigerants in quantities limited to the amounts based on the volume set forth in the *New York City Mechanical Code*.]~~

~~[1015.6 Stage means of egress. Where a minimum of two means of egress are required pursuant to Section 410.5.3, one means of egress shall be provided on each side of the stage.]~~

~~[1015.6.1 Gallery, gridiron and catwalk means of egress. The means of egress from lighting and access catwalks, galleries and gridirons shall meet the requirements for occupancies in Group F-2.]~~

~~[Exceptions:]~~

~~[1. A minimum width of 22 inches (559 mm) is permitted for lighting and access catwalks.]~~

~~[2. Stairways required by this subsection need not be enclosed.]~~

~~[3. Stairways with a minimum width of 22 inches (559 mm), ladders or spiral stairs are permitted in the means of egress.]~~

~~[4. A second means of egress is not required from these areas where a means of escape to a floor or to a roof is provided.]~~

SECTION BC ~~[1016]~~ 1017

EXIT ACCESS TRAVEL DISTANCE

~~**[1016.1 Travel distance limitations.** Exits shall be so located on each story such that the maximum length of exit access travel, measured from the most remote point within a story along the natural and unobstructed path of egress travel to an exterior exit door at the level of exit discharge, an entrance to a vertical exit enclosure, an exit passageway, a horizontal exit, an exterior exit stairway or an exterior exit ramp, shall not exceed the distances given in Table 1016.1.]~~

1017.1 General. Travel distance within the exit access portion of the means of egress system shall be in accordance with this section.

[Exceptions:]

- ~~[1. Travel distance in open parking garages is permitted to be measured to the closest riser of open exit stairways.]~~
- ~~[2. In outdoor facilities with open exit access components and open exterior exit stairways or exit ramps, travel distance is permitted to be measured to the closest riser of an exit stairway or the closest slope of the exit ramp.]~~
- ~~[3. In all occupancies other than occupancy Groups H and I, the exit access travel distance to a maximum of 50 percent of the exits is permitted to be measured from the most remote point within a building to an exit using unenclosed exit access stairways or ramps when connecting a maximum of two stories. Each such interconnected story shall have access to the minimum number of approved independent exits as required by Section 1021.1, but in no case shall there be less than two means of egress. Such interconnected stories shall not be open to other stories. Unenclosed exit stairways shall be remotely located in accordance with Section 1015.2.]~~
- ~~[4. In all occupancies other than occupancy Groups H and I, exit access travel distance is permitted to be measured from the most remote point within a building to an exit using unenclosed exit access stairways or ramps in the first and second stories above grade plane in buildings equipped throughout with an automatic sprinkler system in accordance with Section 903.3.1.1. The first and second stories above grade plane shall have access to the minimum number of approved independent exits as required by Section 1021.1, but in no case shall there be less than two means of egress. Such interconnected stories shall not be open to other stories. Unenclosed exit stairways shall be remotely located in accordance with Section 1015.2.]~~

~~[Where applicable, travel distance on unenclosed exit access stairways or ramps and on connecting stories shall also be included in the travel distance measurement. The measurement along stairways shall be made on a plane parallel and tangent to the stair tread nosings in the center of the stairway.]~~

1017.2 Limitations. Exit access travel distance shall not exceed the values given in Table 1017.2.

**TABLE ~~[4016.1]~~ 1017.2
EXIT ACCESS TRAVEL DISTANCE^A**

OCCUPANCY	WITHOUT SPRINKLER SYSTEM (feet)	WITH SPRINKLER SYSTEM (feet)
A	See Section [4028.7] 1029.7	
E, F-1, M, R, S-1	150	200 ^b
B	200	300 ^c
F-2, S-2, U	200	250 ^{[b]c}
H-1	Not Permitted	75 ^{[e]d}
H-2	Not Permitted	100 ^{[e]d}
H-3	Not Permitted	150 ^{[e]d}
H-4	Not Permitted	175 ^{[e]d}
H-5	Not Permitted	200 ^c
I-1, I-2, I-3, I-4	Not Permitted	200 ^c

For SI: 1 foot = 304.8 mm.

- a. See the following sections for modifications to exit access travel distance requirements:
 - Section ~~[402.4]~~ 402.8: For the distance limitation in malls.
 - Section 404.9: For the distance limitation through an atrium space.
 - Section 407.4: For the distance limitation in Group I-2.
 - Sections 408.6.1 and 408.8.1: For the distance limitations in Group I-3.
 - Section 411.4: For the distance limitation in special amusement buildings.
 - Section 412.7: For the distance limitations in aircraft manufacturing facilities.
 - ~~[Sections 1014.2.2 through 1014.2.7]~~ Section 407.4.2: For the distance limitation in Group I-2 hospital suites.
 - Section ~~[4015.4]~~ 1006.2.2.2: For the distance limitation in refrigeration machinery rooms.
 - Section ~~[4015.5]~~ 1006.2.2.3: For the distance limitation in refrigerated rooms and spaces.
 - Section ~~[4021.2]~~ 1006.3.2: For buildings with one exit.
 - Section ~~[4028.7]~~ 1029.7: For increased limitation in assembly seating.
 - ~~[Section 1028.7: For increased limitation for assembly open-air seating.]~~
 - Section 3103.4: For temporary structures.
 - Section 3104.9: For pedestrian walkways.
- b. Buildings equipped throughout with an automatic sprinkler system in accordance with Section 903.3.1.1 or 903.3.1.2. See Section 903 for occupancies where sprinkler systems ~~[according to]~~ are permitted in accordance with Section 903.3.1.2~~[are permitted]~~.
- c. Buildings equipped throughout with an automatic sprinkler system in accordance with Section 903.3.1.1.
- d. Group H occupancies equipped throughout with an automatic sprinkler system in accordance with Section 903.2.5.1.

~~[1016.2]~~ 1017.2.1 Exterior egress balcony increase. ~~[Travel]~~ Exit access travel distances specified in ~~[Section 1016.1]~~ Table 1017.2 shall be increased up to an additional 100 feet (30 480 mm) provided the last portion of the exit access leading to the exit occurs on an exterior egress balcony constructed in accordance with Section ~~[4019]~~ 1021. The length of such balcony shall be not ~~[be]~~ less than the amount of the increase taken.

1017.3 Measurement. Exit access travel distance shall be measured from the most remote point within a story along the natural and unobstructed path of horizontal and vertical egress travel to the entrance to an exit.

Exceptions:

1. In open parking garages, exit access travel distance is permitted to be measured to the closest riser of an exit access stairway or the closest slope of an exit access ramp.

2. In buildings of Group A-5 with open-air seating served by exit access stairways and ramps, exit access travel distance is permitted to be measured to the closest riser of an exit access stairway or the closest slope of an exit access ramp.
3. Exit access travel distance in assembly occupancies shall be measured in accordance with Section 1029.

1017.3.1 Exit access stairways and ramps. Travel distance on exit access stairways or ramps shall be included in the exit access travel distance measurement. The measurement along stairways shall be made on a plane parallel and tangent to the stair tread nosings in the center of the stair and landings. The measurement along ramps shall be made on the walking surface in the center of the ramp and landings.

SECTION BC ~~[1017]~~ 1018 **AISLES**

~~[1017.1]~~ 1018.1 General. Aisles and aisle accessways serving as a portion of the exit access in the means of egress system shall comply with the requirements of this section. Aisles or aisle accessways shall be provided from all occupied portions of the exit access ~~[which]~~ that contain seats, tables, furnishings, displays and similar fixtures or equipment. ~~[Aisles serving assembly areas shall comply with Section 1028. Aisles serving reviewing stands, grandstands and bleachers shall also comply with Section 1028.]~~ The minimum width or required ~~[width]~~ capacity of aisles shall be unobstructed.

Exception: ~~[Doors]~~ Encroachments complying with Section ~~[4005.2]~~ 1005.7.

1018.2 Aisles in assembly spaces. Aisles and aisle accessways serving a room or space used for assembly purposes shall comply with Section 1029.

~~[1017.2]~~ 1018.3 Aisles in Groups B and M. In Group B and M occupancies, the minimum clear aisle width shall be determined by Section ~~[1005.1]~~ 1005 for the occupant load served, but shall be not ~~[be]~~ less than 36 inches (~~[914]~~ 914.4 mm).

Exception: Nonpublic aisles serving less than 50 people and not required to be accessible by Chapter 11 need not exceed 28 inches (~~[744]~~ 711.2 mm) in width.

~~[1017.3]~~ 1018.4 Aisle accessways in Group M. An aisle accessway shall be provided on ~~[at least]~~ not less than one side of each element within the merchandise pad. The minimum clear width for an aisle accessway not required to be accessible shall be 30 inches (762 mm). The required clear width of the aisle accessway shall be measured perpendicular to the elements and merchandise within the merchandise pad. The 30-inch (762 mm) minimum clear width shall be maintained to provide a path to an adjacent aisle or aisle accessway. The common path of egress travel shall not exceed 30 feet (9144 mm) from any point in the merchandise pad.

Exception: For areas serving not more than 50 occupants, the common path of egress travel shall not exceed 75 feet (~~[(22 880 mm)]~~ (22 860 mm)).

~~[1017.4]~~ Seating at tables. Where seating is located at a table or counter and is adjacent to an aisle or aisle accessway, the measurement of required clear width of the aisle or aisle accessway shall be made

to a line 19 inches (483 mm) away from and parallel to the edge of the table or counter. The 19-inch (483 mm) distance shall be measured perpendicular to the side of the table or counter. In the case of other side boundaries for aisle or aisle accessways, the clear width shall be measured to walls, edges of seating and tread edges, except that handrail projections are permitted.]

[Exception: Where tables or counters are served by fixed seats, the width of the aisle accessway shall be measured from the back of the seat.]

[1017.4.1 Aisle accessway for tables and seating. Aisle accessways serving arrangements of seating at tables or counters shall have sufficient clear width to conform to the capacity requirements of Section 1005.1 but shall not have less than the appropriate minimum clear width specified in Section 1017.4.2.]

[1017.4.2 Table and seating accessway width. Aisle accessways shall provide a minimum of 12 inches (305 mm) of width plus ½ inch (12.7 mm) of width for each additional 1 foot (305 mm), or fraction thereof, beyond 12 feet (3658 mm) of aisle accessway length measured from the center of the seat farthest from an aisle.]

[Exception: Portions of an aisle accessway having a length not exceeding 6 feet (1829 mm) and used by a total of not more than four persons.]

[1017.4.3 Table and seating aisle accessway length. The length of travel along the aisle accessway shall not exceed 30 feet (9144 mm) from any seat to the point where a person has a choice of two or more paths of egress travel to separate exits.]

SECTION BC 1019 EXIT ACCESS STAIRWAYS AND RAMPS

1019.1 General. Exit access stairways and ramps serving as an exit access component in a means of egress system shall comply with the requirements of this section. The number of stories connected by exit access stairways and ramps shall include basements, but not mezzanines.

1019.2 All occupancies. Exit access stairways and ramps that serve floor levels within a single story are not required to be enclosed.

1019.3 Occupancies other than Groups H, I-2 and I-3. In other than Group H, I-2 and I-3 occupancies, exit access stairways or ramps shall be enclosed with a shaft enclosure constructed in accordance with Section 713.

Exception: In other than Group H, I-2 and I-3 occupancies, exit access stairways or ramps that comply with one of the following conditions need not be enclosed:

- 1.** A maximum of 50 percent of the exit access stairways and ramps that serve only two consecutive stories need not be enclosed, provided each such interconnected story has access to the minimum number of approved independent exits as required by Section 1006, and in no case be less than two means of egress. Such interconnected stories shall not be open to other stories. Unenclosed exit access stairways and ramps shall be remotely located in accordance with Section 1007.

2. In buildings equipped throughout with an automatic sprinkler system in accordance with Section 903.3.1.1, exit access stairways and ramps that serve between only the first and second stories above grade, provided the first and second stories have access to the minimum number of approved independent exits as required by Section 1006, and in no case be less than two means of egress. Such interconnected stories shall not be open to other stories. Unenclosed exit access stairways and ramps shall be remotely located in accordance with Section 1007.
3. In Group R-1, R-2 or R-3 occupancies that are fully sprinklered in accordance with Section 903.3.1.1, 903.3.1.2 or 903.3.1.3, exit access stairways and ramps connecting four stories or less and contained within an individual residential dwelling unit.
4. Exit access stairways and ramps in buildings equipped throughout with an automatic sprinkler system in accordance with Section 903.3.1.1, where the area of the vertical opening between stories does not exceed twice the horizontal projected area of the stairway or ramp and the opening is protected by a draft curtain and closely spaced sprinklers in accordance with NFPA 13 as modified by Appendix Q. In other than Group B and M occupancies, this provision is limited to openings that do not connect more than four stories.
5. Exit access stairways and ramps within an atrium complying with the provisions of Section 404.
6. Exit access stairways and ramps in open parking garages that serve only the parking garage.
7. Exit access stairways and ramps serving open-air seating in buildings of Group A-5, where all portions of the means of egress are essentially open to the outside.
8. Exit access stairways and ramps serving the balcony, gallery or press box and the main assembly floor in occupancies such as theaters, places of religious worship, auditoriums and sports facilities.

1019.4 Group I-2 and I-3 occupancies. In Group I-2 and I-3 occupancies, floor openings between stories containing exit access stairways or ramps are required to be enclosed with a shaft enclosure constructed in accordance with Section 713.

Exception: In Group I-3 occupancies, exit access stairways or ramps constructed in accordance with Section 408 are not required to be enclosed.

SECTION BC [~~4018~~] 1020 **CORRIDORS**

[~~1018.1~~] 1020.1 Construction. Corridors shall be constructed in accordance with this section. Interior corridor walls required to be fire-resistance rated shall comply with Section [~~709~~] 708 for fire partitions. Public corridor walls shall comply with Section 707 for fire barriers.

[1018.1.1] 1020.1.1 Interior corridors. Interior corridors shall be fire-resistance rated in accordance with Table [1018.1.1] 1020.1.1.

Exceptions:

1. A fire-resistance rating is not required for corridors in an occupancy in Group E where each room that is used for instruction has ~~[at least]~~ not less than one door opening directly to the exterior and rooms for assembly purposes have ~~[at least]~~ not less than one-half of the required means of egress doors opening directly to the exterior. Exterior doors specified in this exception are required to be at ground level.
2. A fire-resistance rating is not required for corridors contained within a dwelling unit or sleeping unit in an occupancy in Group R.
3. A fire-resistance rating is not required for corridors in open parking garages.
4. A fire-resistance rating is not required for corridors in an occupancy in Group B ~~[which]~~ that is a space requiring only a single means of egress complying with Section [1015.1] 1006.2.
5. Corridors adjacent to the exterior walls of buildings shall be permitted to have unprotected openings on unrated exterior walls where unrated walls are permitted by Table 602 and unprotected openings are permitted by Table 705.8.

**TABLE [1018.1.1] 1020.1.1
INTERIOR CORRIDOR FIRE-RESISTANCE RATING**

OCCUPANCY	OCCUPANT LOAD SERVED BY INTERIOR CORRIDOR	REQUIRED FIRE-RESISTANCE RATING (hours)	
		Without sprinkler system	With sprinkler system ^c
H-1, H-2, H-3	All	Not Permitted	1
H-4, H-5	Greater than 30	Not Permitted	1
A, B, E, F, M, S, U	Greater than 30	1	0
R	Greater than 10	1 ^d	0
I-2 ^a , I-4	All	Not Permitted	0
I-1, I-3	All	Not Permitted	1 ^b

- a. For requirements for occupancies in Group I-2, see Sections 407.2 and 407.3.
- b. For a reduction in the fire-resistance rating for occupancies in Group I-3, see Section 408.8.
- c. Buildings equipped throughout with an automatic sprinkler system in accordance with Section 903.3.1.1 or 903.3.1.2 where allowed.
- d. Interior corridors within dwelling or sleeping units in Group R occupancies pursuant to Section [1018.1.1] 1020.1.1, Exception 2 shall not require fire-resistance rating.

[1018.1.2] 1020.1.2 Public corridors. Public corridors shall be fire-resistance rated in accordance with Table [1018.1.2] 1020.1.2.

**TABLE [1018.1.2] 1020.1.2
PUBLIC CORRIDOR FIRE-RESISTANCE RATING**

OCCUPANCY	REQUIRED FIRE-RESISTANCE RATING (hours)
H-1, H-2, H-3	2

OCCUPANCY	REQUIRED FIRE-RESISTANCE RATING (hours)
H-4, H-5	1
A, E, F, M, S, U	1
B	1 ^a
R (Noncombustible)	1 ^c
R (Combustible)	2 ^b
I-1, I-2, I-3, I-4	1

- a. Public corridors need not be fire rated in high-rise buildings in Occupancy Group B equipped throughout with an automatic sprinkler system in accordance with Section 903.3.1.1, where such building is provided with smokeproof enclosures in stairways in accordance with Section 403.5.4.
- b. Public corridors in buildings not exceeding two stories in height, or that are three stories in height and occupied by not more than one family on each story, may be constructed with 1-hour fire-resistance rating.
- c. Corridors serving accessory rooms or spaces in Group R-2 occupancies pursuant to Section 1004.1.1.2.3 shall be constructed with fire barriers with 1-hour fire-resistance rating, and 2-hour fire-resistance rating where the dead-end distance exceeds 40 feet (12 192 mm) in length.

~~[1018.2 Corridor width]~~ **1020.2 Width and capacity.** The ~~[minimum corridor width]~~ required capacity of corridors shall be [as] determined as specified in Section [1005-1] 1005, but the minimum width shall be not less than [44 inches (1118 mm)] that specified in Table 1020.2.

[Exceptions:]

- ~~[1. Twenty four inches (610 mm) — For access to and utilization of electrical, mechanical or plumbing systems or equipment.]~~
- ~~[2. Thirty six inches (914 mm) — With a required occupant capacity of 50 or less, except as otherwise required by Chapter 11.]~~
- ~~[3. Thirty six inches (914 mm) — Within a dwelling unit in Occupancy Groups I-1 and R-1, except as otherwise required by Section 1107.]~~
- ~~[4. Thirty inches (762 mm) — Within a dwelling unit in Occupancy Groups R-2 and R-3, except as otherwise required by Section 1107.]~~
- ~~[5. Sixty six inches (1676 mm) — In Group E serving classrooms.]~~
- ~~[6. Seventy two inches (1829 mm) — In corridors and areas serving gurney traffic in occupancies where patients receive outpatient medical care, which causes the patient to be not capable of self-preservation.]~~
- ~~[7. Ninety six inches (2438 mm) — In Group I-2 in areas where required for bed movement.]~~

Exception: In Group I-2 occupancies, corridors are not required to have a clear width of 96 inches (2438.4 mm) in areas where there will not be stretcher or bed movement for access to care or as part of the defend-in-place strategy.

TABLE 1020.2
MINIMUM CORRIDOR WIDTH

<u>OCCUPANCY</u>	<u>MINIMUM WIDTH (inches)</u>
Any facilities not listed below	44
Access to and utilization of mechanical, plumbing or electrical systems or equipment	24
With an occupant load of 50 or less, except as otherwise required by Chapter 11	36
Within a dwelling unit, in Occupancy Groups I-1 and R-1, except as otherwise required by Section 1107	36
Within a dwelling unit, in Occupancy Groups R-2 and R-3, except as otherwise required by Section 1107	30
In Group E serving classrooms	66
In corridors and areas serving stretcher traffic in occupancies where patients receive outpatient medical care that causes the patients to be incapable of self-preservation	72
Group I-2 in areas where required for bed movement	96

For SI: 1 inch = 25.4 mm.

[1018.3 Corridor obstruction] 1020.3 Obstruction. The [required] minimum width or required capacity of corridors shall be unobstructed.

Exception: [Doors] Encroachments complying with Section [4005.2] 1005.7.

[1018.4] 1020.4 Dead ends. Where more than one exit or exit access doorway is required, the exit access shall be arranged such that there are no dead ends in corridors more than 20 feet (6096 mm) in length.

Exceptions:

1. In occupancies in Group I-3 of [Occupancy] Condition 2, 3 or 4 [~~(see Section 308.4)~~], the dead end in a corridor shall not exceed 50 feet (15 240 mm).
2. In occupancies in Groups B, E, F, I-1, M, R-1, S and U, where the building is equipped throughout with an automatic sprinkler system in accordance with Section 903.3.1.1, the length of the dead-end corridors shall not exceed 50 feet (15 240 mm).
3. Dead-end length not exceeding 2.5 times the least width of the dead-end corridor.
4. In occupancies in Group R-2, the dead end in a corridor shall not exceed 40 feet (12 192 mm). However, where the corridors are completely enclosed in construction having a 2-hour fire-resistance rating with all doors opening into the corridor being self-closing and having a fire-resistance rating of 1½ hours, the length of dead-end corridor shall not exceed 80 feet (24 384 mm).

[1018.5] 1020.5 Air movement in corridors. Use of corridors as part of direct supply, return, or exhaust air system shall be subject to the limitations of the *New York City Mechanical Code*.

[1018.5.1] 1020.5.1 Corridor ceiling. Use of the space between the corridor ceiling and the floor or roof structure above as a return air plenum shall be in accordance with the *New York City Mechanical Code*.

[1018.6] 1020.6 Corridor continuity. Fire-resistance-rated corridors shall be continuous from the point of entry to an exit, and shall not be interrupted by intervening rooms. Where the path of egress travel within a fire-resistance-rated corridor to the exit includes travel along unenclosed exit access stairways or ramps, the fire-resistance rating shall be continuous for the length of the stairway or ramp and for the length of the connecting corridor on the adjacent floor leading to the exit.

[Exception:] Exceptions:

1. Foyers, lobbies or reception rooms constructed as required for corridors shall not be construed as intervening rooms.
2. Enclosed elevator lobbies as permitted by Item 1 of Section 1016.2 shall not be construed as intervening rooms.

**SECTION BC [1019] 1021
EGRESS BALCONIES**

[1019.1] 1021.1 General. Balconies used for egress purposes shall conform to the same requirements as corridors for minimum width, required capacity, headroom, dead ends and projections.

[1019.2] 1021.2 Wall separation. Exterior egress balconies shall be separated from the interior of the building by walls and opening protectives as required for corridors.

Exception: Separation is not required where the exterior egress balcony is served by [at least] not less than two [stairs] stairways and a dead-end travel condition does not require travel past an unprotected opening to reach a [stair] stairway.

[1019.3] 1021.3 Openness. The long side of an egress balcony shall be at least 50 percent open, and the open area above the guards shall be so distributed as to minimize the accumulation of smoke or toxic gases.

1021.4 Location. Exterior egress balconies shall have a minimum fire separation distance of 10 feet (3048 mm) measured at right angles from the exterior edge of the egress balcony to the following:

1. Adjacent lot lines.
2. Other portions of the building.
3. Other buildings on the same lot unless the adjacent building exterior walls and openings are protected in accordance with Section 705 based on fire separation distance.

For the purposes of this section, other portions of the building shall be treated as separate buildings.

[1019.4] 1021.5 Outdoor conditions. Exterior egress balconies shall be designed to minimize accumulation of snow and ice that impedes the means of egress.

SECTION BC [4020] 1022 EXITS

[1020.1] 1022.1 General. Exits shall comply with Sections [4020] 1022 through [4026] 1027 and the applicable requirements of Sections 1003 through [4013] 1015. An exit shall not be used for any purpose that interferes with its function as a means of egress. Once a given level of exit protection is achieved, such level of protection shall not be reduced until arrival at the exit discharge. Exits shall be continuous from the point of entry into the exit to the exit discharge.

Exception: Interior exit stairways with doors that are automatic-closing by smoke detection pursuant to the exception set forth in Section 713.7 may be used for travel between floors and this use shall not be deemed to interfere with function as a means of egress.

[1020.2] 1022.2 Exterior exit doors. Buildings or structures used for human occupancy shall have [at least] not less than one exterior door that meets the requirements of Section [4008.1.1] 1010.1.1.

[1020.2.1] 1022.2.1 Detailed requirements. Exterior exit doors shall comply with the applicable requirements of Section [4008.1] 1010.1.

[1020.2.2] 1022.2.2 Arrangement. Exterior exit doors shall lead directly to the exit discharge or the public way.

[SECTION BC 1021 NUMBER OF EXITS AND CONTINUITY]

[1021.1 Exits from stories. All spaces within each story shall have access to the minimum number of approved independent exits as specified in Table 1021.1 based on the occupant load of such story. For the purposes of this chapter, occupied roofs shall be provided with exits as required for stories.]

[Exceptions:]

[1. As modified by Section 403.5.2.]

[2. As modified by Section 1021.2.]

[3. Exit access stairways and ramps that comply with Exception 3 or 4 of Section 1016.1 shall be permitted to provide the minimum number of approved independent exits required by Table 1021.1 on each story.]

[4. Unless otherwise required by other provisions of this chapter, the number of exits from rooms and spaces within a story discharging directly to the exterior at the level of exit discharge shall be determined in accordance with Table 1015.1.]

**[TABLE 1021.1
MINIMUM NUMBER OF EXITS FOR OCCUPANT LOAD**

OCCUPANT LOAD (persons per story)	MINIMUM NUMBER OF EXITS (per story)
1-500	2
501-1,000	3
More than 1,000	4

~~[1021.1.1 Exits maintained. The required number of exits from any story shall be maintained until arrival at grade or the public way.]~~

~~[1021.1.2 Open or enclosed parking garages. Open or enclosed parking garages shall not have less than two exits from each parking tier. An unenclosed vehicle ramp constructed in accordance with Section 1010.2 may serve as one of the required exits when provided with pedestrian facilities along the ramp. Such ramps serving open or enclosed parking garages three stories or less in height and serving not more than one level below grade shall further comply with Section 1010.2, Exception 2.]~~

~~[Exception: Where vehicles are mechanically parked, only one exit is required but such exit shall not be a vehicle ramp.]~~

~~[1021.2 Single exits. Only one exit shall be required in buildings or from stories of buildings as described below:]~~

~~[1. Stories in buildings as described in Table 1021.2.]~~

~~[2. Buildings of Group R-3 occupancy.]~~

~~[3. Single level buildings with the occupied space at the level of exit discharge provided that the story or space complies with Section 1015.1 as a space with one means of egress.]~~

~~[4. Buildings of Group R-2 occupancy where all of the following conditions are met:]~~

~~[4.1. The building does not exceed four stories;]~~

~~[4.2. The building contains not more than three dwelling units per story;]~~

~~[4.3. The building is of construction Type I or II;]~~

~~[4.4. The building does not exceed 2,500 square feet (232 m²) per story;]~~

~~[4.5. Each dwelling unit has at least one window facing the street, or facing a lawful yard with open, unobstructed, and direct access to the street;]~~

~~[4.6. The stairway extends to the roof surface through a stairway bulkhead complying with Section 1509.2 provided the roof has a slope not steeper than 20 degrees (0.35 rad). In lieu of the stairway bulkhead, the stair may be constructed against the street wall with one window facing the street at every landing and access to the roof is provided via a~~

scuttle with a stationary, noncombustible access ladder;]

[4.7. The stairway is enclosed in 2-hour fire-rated walls with all exit doors leading into the stairway having at least 1½-hour fire rating; and]

[4.8. The building shall be equipped throughout with an automatic sprinkler system in accordance with Section 903.3.1.2.]

[5. Buildings of Group R-2 occupancy of construction Type I or II not exceeding six stories and not exceeding 2,000 square feet (186 m²) per story.]

**[TABLE 1021.2
STORIES WITH ONE EXIT^{e, f, g}**

STORY	OCCUPANCY	MAXIMUM OCCUPANTS (OR DWELLING UNITS) PER FLOOR AND TRAVEL DISTANCE
First story or basement	A, B ^e , E ^d , F ^e , M, U, S ^e	49 occupants and 75-foot travel distance
	H-2, H-3	3 occupants and 25-foot travel distance
	H-4, H-5, I, R	10 occupants and 75-foot travel distance
	S ^a	29 occupants and 100-foot travel distance
Second story	B, F, M, S ^a	29 occupants and 75-foot travel distance
	R-2	4 dwelling units and 50-foot travel distance
Third story	R-2 ^b	4 dwelling units and 50-foot travel distance

For SI: 1 foot = 304.8 mm.

a.—For the required number of exits for open or enclosed parking garages, see Section 1021.1.2.

b.—Buildings classified as Group R-2 equipped throughout with an automatic sprinkler system in accordance with Section 903.3.1.1 or 903.3.1.2 and provided with emergency escape and rescue openings in accordance with Section 1029.

c.—Group B, F and S occupancies in buildings equipped throughout with an automatic sprinkler system in accordance with Section 903.3.1.1 shall have a maximum travel distance of 100 feet.

d.—Day care occupancies shall have a maximum occupant load of 10.

e.—Mixed occupancies shall be permitted to be served by single exits provided each individual occupancy complies with the applicable requirements of Table 1021.2 for that occupancy.

f.—Where applicable, cumulative occupant loads from adjacent occupancies shall be considered in accordance with the provisions of Section 1004.1.

g.—Basements with a single exit shall not be located more than one story below grade plane.]

[1021.3 Exit continuity. Exits shall be continuous from the point of entry into the exit to the exit discharge.]

[1021.4 Exit door arrangement. Exit door arrangement shall meet the requirements of Sections 1015.2 through 1015.2.2.]

SECTION BC [1022] 1023

[EXIT ENCLOSURES] INTERIOR EXIT STAIRWAYS AND RAMPS

[1022.1 Enclosures required. Interior exit stairways and interior exit ramps shall be enclosed with]

1023.1 General. Interior exit stairways and ramps serving as an exit component in a means of egress system shall comply with the requirements of this section. Interior exit stairways and ramps shall be enclosed and lead directly to the exterior of the building or shall be extended to the exterior of the building with an exit passageway conforming to the requirements of Section 1024, except as permitted in Section 1028.1. An interior exit stairway or ramp shall not be used for any purpose other than as a means of egress and a circulation path.

1023.2 Construction. Enclosures for interior exit stairways and ramps shall be constructed as fire barriers [constructed] in accordance with Section 707 or horizontal assemblies constructed in

accordance with Section ~~[712]~~ 711, or both. ~~[Exit enclosures]~~ Interior exit stairway and ramp enclosures shall have a fire-resistance rating of not less than 2 hours where connecting four stories or more and not less than 1 hour where connecting less than four stories. The number of stories connected by the interior exit ~~[enclosure]~~ stairways or ramps shall include any basements, but not any mezzanines. ~~[Exit enclosures]~~ Interior exit stairways and ramps shall have a fire-resistance rating not less than the floor assembly penetrated, but need not exceed 2 hours. In Group R-1 and R-2 occupancies, where interior exit ~~[enclosures]~~ stairways and ramps are required to have a fire-resistance rating of 2 hours, such enclosures shall be constructed of masonry or masonry equivalent. Wall assemblies constituting masonry equivalent shall be constructed in accordance with department rules. ~~[Exit enclosures shall lead directly to the exterior of the building or shall be extended to the exterior of the building with an exit passageway conforming to the requirements of Section 1023, except as permitted in Section 1027.1. An exit enclosure shall not be used for any purpose other than means of egress.]~~

Exceptions:

1. ~~[In all occupancies, other than Group H and I occupancies, a stairway is not required to be enclosed when the stairway serves an occupant load of less than 10 and stairway complies with either Item 1.1 or 1.2. In all cases, the maximum number of connecting open stories shall not exceed two.]~~ Interior exit stairways and ramps in Group I-3 occupancies in accordance with the provisions of Section 408.3.8.

~~[1.1 The stairway is open to not more than one story above its level of exit discharge; or]~~

~~[1.2 The stairway is open to not more than one story below its level of exit discharge.]~~

2. ~~[Exits in buildings of Group A-5 where all portions of the means of egress are essentially open to the outside need not be enclosed.]~~ Interior exit stairways within an atrium enclosed in accordance with Section 404.6.

~~[3. Stairways serving and contained within a single residential dwelling unit or sleeping unit in Group R-1, R-2 or R-3 occupancies are not required to be enclosed.]~~

~~[4. Stairways in open parking structures that serve only the parking structure are not required to be enclosed.]~~

~~[5. Stairways in Group I-3 occupancies as provided for in Section 408.3.8 are not required to be enclosed.]~~

~~[6. Means of egress stairways as required by Sections 410.5.3 and 1015.6.1 are not required to be enclosed.]~~

~~[7. Means of egress stairways from balconies, galleries or press boxes as provided for in Section 1028.5.1 are not required to be enclosed.]~~

~~[8. Vertical exit enclosures with doors that are automatic closing by smoke detection pursuant to the exception set forth in Section 708.7 may be used for travel between floors and this~~

~~use shall not be deemed to interfere with function as a means of egress.]~~

~~[1022.2]~~ **1023.3 Termination.** ~~[Exit enclosures]~~ Interior exit stairways and ramps shall terminate at an exit discharge or a public way.

Exception: ~~[An]~~ A combination of interior exit [enclosure] stairways, interior exit ramps and exit passageways, constructed in accordance with Sections 1023.2, 1023.3.1 and 1024, respectively, and forming a continuous protected enclosure, shall be permitted to [terminate at] extend an [exit passageway complying with Section 1023, provided the exit passageway terminates at an] interior exit stairway or ramp to the exit discharge or a public way.

~~[1022.2.1]~~ **1023.3.1 Extension.** Where ~~[an]~~ interior exit [enclosure is] stairways and ramps are extended to an exit discharge or a public way by an exit passageway, the interior exit [enclosure] stairway and ramp shall be separated from the exit passageway by a fire barrier constructed in accordance with Section 707 or a horizontal assembly constructed in accordance with Section ~~[712]~~ 711, or both. The fire-resistance rating shall be ~~[at least equal to]~~ not less than that required for the interior exit [enclosure] stairway and ramp. A fire door assembly complying with Section ~~[715.4]~~ 716.5 shall be installed in the fire barrier to provide a means of egress from the interior exit [enclosure] stairway and ramp to the exit passageway. Openings in the fire barrier other than the fire door assembly are prohibited. Penetrations of the fire barrier are prohibited.

~~[Exception:]~~ **Exceptions:**

1. Penetrations of the fire barrier in accordance with Section ~~[4022.4]~~ 1023.5 shall be permitted.
2. Separation between an interior exit stairway or ramp and the exit passageway extension shall not be required where there are no openings into the exit passageway extension.

~~[1022.3]~~ **1023.4 Openings.** Interior exit stairway and [penetrations. Exit enclosure] ramp opening protectives shall be in accordance with the requirements of Section ~~[715]~~ 716.

Openings in interior exit [enclosures] stairways and ramps other than unprotected exterior openings shall be limited to those necessary for exit access to the enclosure from normally occupied spaces and for egress from the enclosure.

Elevators shall not open into ~~[an]~~ interior exit [enclosure] stairways and ramps.

~~[1022.4]~~ **1023.5 Penetrations.** Penetrations into ~~[and openings]~~ or through [an] interior exit [enclosure] stairways and ramps are prohibited except for ~~[required exit doors,]~~ equipment and ductwork necessary for independent ventilation or pressurization, hydronic piping and related heating equipment limited to serving the interior exit [enclosure] stairway or ramp in which such piping and equipment is located, sprinkler piping, standpipes, electrical raceway for Fire Department communication systems and electrical raceway serving the interior exit [enclosure] stairway and ramp and terminating at a steel box not exceeding 16 square inches (0.010 m²). Such penetrations shall be protected in accordance with Section ~~[713]~~ 714. There shall not be ~~[no]~~ penetrations or

communication openings, whether protected or not, between adjacent interior exit [enclosures] stairways and ramps.

Exception: Membrane penetrations shall be permitted on the outside of the interior exit stairway and ramp. Such penetrations shall be protected in accordance with Section 714.3.2.

[1022.5] 1023.6 Ventilation. Equipment and ductwork for interior exit [enclosure] stairway and ramp ventilation [necessary for independent ventilation or pressurization] as permitted by Section [1022.4] 1023.5 shall comply with one of the following items:

1. Such equipment and ductwork shall be located exterior to the building and shall be directly connected to the interior exit [enclosure] stairway and ramp by ductwork enclosed in construction as required for shafts.
2. Where such equipment and ductwork is located within the interior exit [enclosure] stairway and ramp, the intake air shall be taken directly from the outdoors and the exhaust air shall be discharged directly to the outdoors, or such air shall be conveyed through ducts enclosed in construction as required for shafts.
3. Where located within the building, such equipment and ductwork shall be separated from the remainder of the building, including other mechanical equipment, with construction as required for shafts.

In each case, openings into the fire-resistance-rated construction shall be limited to those needed for maintenance and operation and shall be protected by opening protectives in accordance with Section [715] 716 for shaft enclosures. [~~Exit enclosure ventilation systems shall be independent of other building ventilation systems.~~]

The interior exit stairway and ramp ventilation systems shall be independent of other building ventilation systems.

[1022.6 Exit enclosure] 1023.7 Interior exit stairway and ramp exterior walls. Exterior walls of [~~an~~] the interior exit [enclosure] stairway or ramp shall comply with the requirements of Section 705 for exterior walls. Where nonrated walls or unprotected openings enclose the exterior of the stairway or ramps and the walls or openings are exposed [~~to~~] by other parts of the building at an angle of less than 180 degrees (3.14 rad), the building exterior walls within 10 feet (3048 mm) horizontally of a nonrated wall or unprotected opening shall have a fire-resistance rating of not less than 1 hour. Openings within such exterior walls shall be protected by opening protectives having a fire protection rating of not less than $\frac{3}{4}$ hour. This construction shall extend vertically from the ground to a point 10 feet (3048 mm) above the topmost landing of the stairway or ramp, or to the roof line, whichever is lower.

[1022.7] 1023.8 Discharge identification. [A] An interior exit stairway [in an exit enclosure] and ramp shall not continue below its level of exit discharge unless an approved barrier is provided at the level of exit discharge to prevent persons from unintentionally continuing into levels below. Directional exit signs shall be provided as specified in Section [1014] 1013. An approved barrier shall consist of partitions, doors, or gates separating the portion of the [~~vertical exit~~] interior exit stairway above grade from the portion below grade. Where doors or gates are provided as approved

barriers, such doors or gates shall be self-closing ~~[and]~~, opening in the direction of exit travel from the floors below grade, and provided with landings in accordance with Sections 1010.1.5 and 1010.1.6.

Exceptions:

1. Such barrier separating the above-grade portion of the ~~[vertical-exit]~~ interior exit stairways and ramps from the portion below grade shall not be required in Group E and R-3 occupancies.
2. Such barrier separating the above-grade portion of the ~~[vertical-exit]~~ interior exit stairways and ramps from the portion below grade shall not be required where the stairway or ramp design is intended to continue the path of egress through a below grade level.

[1022.8] 1023.9 Stairway identification and floor level signs. Signs identifying stairways shall comply with Section 1023.9.1. Signs identifying ~~[and]~~ floor levels shall comply with Sections ~~[1022.8.1]~~ 1023.9.2 through ~~[1022.8.5]~~ 1023.9.5.

~~[1022.8.1]~~ 1023.9.1 Stairway identification signs. A stairway identification sign indicating each stair by alphabetic letter shall be posted on both sides of each stair door. The alphabetic letters designating the identification of the interior exit stairway and ramp shall be not less than 3 inches (76.2 mm) in height. Such sign shall comply with Items 2, 5 and 6 of Section 1023.9.4.

~~[1022.8.2]~~ 1023.9.2 Floor identification signs. A floor identification sign shall be provided at each floor landing ~~[within]~~ in an interior exit [enclosures] stairway and ramp connecting more than three stories. Such sign shall designate:

1. The floor level;
2. The terminus of the top and bottom of the interior exit [enclosure] stairway and ramp;
3. The identification of the ~~[stair-øf]~~ interior exit stairway and ramp;
4. The story of the exit discharge; and
5. The availability of roof access from the ~~[enclosure]~~ interior exit stairway and ramp for the Fire Department.

~~[The signs shall be located 5 feet (1524 mm) above the floor landing in a position that is readily visible when the doors are in the open and closed positions.]~~

~~[1022.8.3 Tactile]~~ 1023.9.3 Accessible floor level identification signs. Floor level identification signs in ~~[tactile]~~ visual characters, raised characters and braille complying with ICC A117.1 shall be located at each floor level landing adjacent to the door on the stair side.

~~[1022.8.4]~~ 1023.9.4 Signage requirements. ~~[Stairway and floor]~~ Floor identification signs required by ~~[Sections 1022.8.1 and 1022.8.2]~~ Section 1023.9.2 shall comply with all of the following requirements:

1. The signs shall be a minimum size of 18 inches ([457] 457.2 mm) by 12 inches ([305] 304.8 mm).
2. ~~[The alphabetic letters designating the identification of the stair enclosure shall be a minimum of 1½ inches (38 mm) in height.]~~ The top of the signs shall be located 5 feet (1524 mm) above the floor landing in a position that is readily visible when the doors are in the open and closed positions.
3. The number designating the floor level shall be ~~[a minimum of]~~ not less than 5 inches (127 mm) in height and located in the center of the sign.
4. ~~[All other]~~ Other lettering and numbers shall be ~~[a minimum of]~~ not less than 1 inch ([25] 25.4 mm) in height.
5. Characters and their background shall have a nonglare finish. Characters shall contrast with their background, with either light characters on a dark background or dark characters on a light background.
6. ~~[When]~~ Where signs required by Section ~~[4022.8]~~ 1023.9 are installed in the interior exit [enclosures] stairways and ramps of buildings subject to Section ~~[4024]~~ 1025, the signs shall be made of the same luminous materials as required by Section ~~[4024.4]~~ 1025.4.

[1022.8.5] 1023.9.5 Directions to openable doors. Where doors serving ~~[vertical]~~ interior exit [enclosures] stairways are locked on the stair side, signage shall be posted in compliance with Sections ~~[4030.4.1]~~ 1031.4.1, ~~[4030.4.2]~~ 1031.4.2 and ~~[4030.4.3]~~ 1031.4.3.

[1022.9] 1023.10 Elevator lobby identification signs. At landings in interior exit stairways where two or more doors lead to the floor level, any door with direct access to an enclosed elevator lobby shall be identified by signage located on the door or directly adjacent to the door stating “Elevator Lobby.” Signage shall be in accordance with Section 1023.9.4, Items 4, 5 and 6.

1023.11 Smokeproof enclosures and ~~[pressurized stairways]~~ pressurization alternative. In buildings required to comply with Section 403 or 405, each of the ~~[exit enclosures]~~ interior exit stairways and ramps serving a story with a floor surface located more than 75 feet (22 860 mm) above the lowest level of Fire Department vehicle access or more than 30 feet (9144 mm) below the finished floor of a level of exit discharge serving such stories shall be protected by a smokeproof enclosure or ~~[pressurized stairway]~~ pressurization alternative in accordance with Section 909.20.

[1022.9.1] 1023.11.1 Termination and extension. A smokeproof enclosure or ~~[pressurized stairway]~~ pressurization alternative shall terminate at an exit discharge or a public way. The smokeproof enclosure or ~~[pressurized stairway]~~ pressurization alternative shall be permitted to be extended by an exit passageway in accordance with Section ~~[4022.2]~~ 1023.3. The exit passageway shall be without openings other than the fire door assembly required by Section ~~[4022.2]~~ 1023.3.1 and those necessary for egress from the exit passageway. The exit passageway shall be separated from the remainder of the building by 2-hour fire barriers constructed in accordance with Section 707 or horizontal assemblies constructed in accordance with Section ~~[712]~~ 711, or both.

Exceptions:

1. Openings in the exit passageway serving a smokeproof enclosure are permitted where the exit passageway is protected and pressurized in the same manner as the smokeproof enclosure, and openings are protected as required for access from other floors.
2. Openings in the exit passageway serving a [~~pressurized stairway~~] pressurization alternative are permitted where the exit passageway is protected and pressurized in the same manner as the [~~pressurized stairway~~] pressurization alternative.
3. The fire barrier separating the smokeproof enclosure or [~~pressurized stairway~~] pressurization alternative from the exit passageway is not required, provided the exit passageway is protected and pressurized in the same manner as the smokeproof enclosure or [~~pressurized stairway~~] pressurization alternative.
4. A smokeproof enclosure or [~~pressurized stairway~~] pressurization alternative shall be permitted to egress through areas on the level of exit discharge or vestibules as permitted by Section [~~1027~~] 1028.

~~[1022.9.2]~~ **1023.11.2 Enclosure access.** Access to the stairway or ramp within a smokeproof enclosure shall be by way of a vestibule or an open exterior balcony.

Exception: Access is not required by way of a vestibule or exterior balcony for stairways and ramps using the pressurization alternative complying with Section 909.20.5.

SECTION BC [~~1023~~] 1024 EXIT PASSAGEWAYS

~~[1023.1]~~ **1024.1 Exit [~~passageway~~] passageways.** Exit passageways serving as an exit component in a means of egress system shall comply with the requirements of this section. An exit passageway shall not be used for any purpose other than as a means of egress and a circulation path.

~~[1023.2]~~ **1024.2 Width.** The [~~width~~] required capacity of exit passageways shall be determined as specified in Section [~~1005.1~~] 1005 but [~~such~~] the minimum width shall be not [~~be~~] less than 44 inches (~~[1118]~~ 1117.6 mm), except that exit passageways serving an occupant load of less than 50 shall be not [~~be~~] less than 36 inches (~~[914]~~ 914.4 mm) in width. The minimum width or required capacity of exit passageways shall be unobstructed.

~~[The required width of exit passageways shall be unobstructed.]~~

Exception: [~~Doors~~] Encroachments complying with Section [~~1005.2~~] 1005.7.

~~[1023.3]~~ **1024.3 Construction.** Exit passageway enclosures shall have walls, floors and ceilings of not less than a 1-hour fire-resistance rating, and not less than that required for any connecting interior exit [~~enclosure~~] stairway or ramp. Exit passageways shall be constructed as fire barriers in accordance with Section 707 or horizontal assemblies constructed in accordance with Section [~~712~~] 711, or both.

[1023.4] 1024.4 Termination. Exit passageways on the level of exit discharge shall terminate at an exit discharge [or a public way]. Exit passageways on other levels shall terminate at an exit component.

[1023.5] 1024.5 Openings [and penetrations]. Exit passageway opening protectives shall be in accordance with the requirements of Section ~~[715]~~ 716.

Except as permitted in Section ~~[402.4.6]~~ 402.8.7, openings in exit passageways other than unprotected exterior openings shall be limited to those necessary for exit access to the exit passageway from normally occupied spaces and for egress from the exit passageway.

Where an interior exit [enclosure] stairway or ramp is extended to an exit discharge or a public way by an exit passageway, the exit passageway shall ~~[also]~~ comply with Section ~~[1022.2.1]~~ 1023.3.1.

Elevators shall not open into an exit passageway.

[1023.6] 1024.6 Penetrations. Penetrations into ~~[and openings]~~ or through an exit passageway are prohibited except for ~~[required exit doors,]~~ equipment and ductwork necessary for independent pressurization, hydronic piping and related heating equipment limited to serving the exit passageway in which such piping and equipment is located, sprinkler piping, standpipes, electrical raceway for fire department communication and electrical raceway serving the exit passageway and terminating at a steel box not exceeding 16 square inches (0.010 m²). Such penetrations shall be protected in accordance with Section ~~[713]~~ 714. There shall not be ~~[no]~~ penetrations or communicating openings, whether protected or not, between adjacent exit passageways.

Exception: Membrane penetrations shall be permitted on the outside of the exit passageway. Such penetrations shall be protected in accordance with Section 714.3.2.

1024.7 Ventilation. Equipment and ductwork for exit passageway ventilation as permitted by Section 1024.6 shall comply with one of the following:

1. The equipment and ductwork shall be located exterior to the building and shall be directly connected to the exit passageway by ductwork enclosed in construction as required for shafts.
2. Where the equipment and ductwork is located within the exit passageway, the intake air shall be taken directly from the outdoors and the exhaust air shall be discharged directly to the outdoors, or the air shall be conveyed through ducts enclosed in construction as required for shafts.
3. Where located within the building, the equipment and ductwork shall be separated from the remainder of the building, including other mechanical equipment, with construction as required for shafts.

In each case, openings into the fire-resistance-rated construction shall be limited to those needed for maintenance and operation and shall be protected by opening protectives in accordance with Section 716 for shaft enclosures.

Exit passageway ventilation systems shall be independent of other building ventilation systems.

SECTION BC ~~[4024]~~ 1025
LUMINOUS EGRESS PATH MARKINGS

~~[1024.1]~~ **1025.1 General.** Approved luminous egress path markings delineating the exit path shall be provided in all high-rise buildings subject to Section 403.5 having occupied floors located more than 75 feet (22 860 mm) above the lowest level of Fire Department vehicle access in accordance with Sections ~~[1024.1]~~ 1025.1 through ~~[1024.9]~~ 1025.9.

Exceptions:

1. Luminous egress path markings shall not be required on the level of exit discharge in lobbies that serve as part of the exit path in accordance with Section ~~[1027.1]~~ 1028.1, Exception 1.
2. ~~[Luminous]~~ In open parking garages, luminous egress path markings shall not be required in ~~[areas of]~~ open exit stairways serving only the open parking ~~[garages]~~ garage, and areas of open parking garages that serve ~~[as]~~ such part of the exit path ~~[in accordance with Section 1027.1, Exception 3].~~
3. Luminous egress path markings shall not be required on egress paths serving Group R-2.

~~[1024.2]~~ **1025.2 Required ~~[Markings]~~ markings.** Egress path markings shall be provided in interior exit ~~[enclosures, including vertical]~~ stairways, interior exit ~~[enclosures, horizontal exits,]~~ ramps and exit passageways, in accordance with Sections ~~[1024.2.1]~~ 1025.2.1 through ~~[1024.2.9]~~ 1025.2.9. Entrances to interior exit ~~[enclosure]~~ stairways, interior exit ramps and exit passageways shall be provided with exit signs in compliance with Section ~~[1024.2.6.1]~~ 1025.2.6.1.

~~[1024.2.1]~~ **1025.2.1 Steps.** A solid and continuous stripe shall be applied to the horizontal leading edge of each step and shall extend for the full length of the step. Outlining stripes shall have a minimum horizontal width of 1 inch (~~[25]~~ 25.4 mm) and a maximum width of 2 inches (~~[51]~~ 50.8 mm). The leading edge of the stripe shall be placed ~~[at a maximum of]~~ not more than ½ inch (~~[13]~~ 12.7 mm) from the leading edge of the step and the stripe shall not overlap the leading edge of the step by ~~[not]~~ more than ½ inch (~~[13 mm]~~ 12.7 mm) down the vertical face of the step. Outlining stripes on steps shall comply with Figure S101.1(2) ~~[of]~~ in Appendix S.

Exception: The minimum width of 1 inch (~~[25]~~ 25.4 mm) shall not apply to outlining stripes listed in accordance with UL 1994.

~~[1024.2.2]~~ **1025.2.2 Landings.** The leading edge of landings shall be marked with a stripe consistent with the dimensional requirements for steps. Stripes on landings shall comply with Figure S101.1(3) ~~[of]~~ in Appendix S.

~~[1024.2.3]~~ **1025.2.3 Handrails.** ~~[All handrails]~~ Handrails and handrail extensions shall be marked with a solid and continuous stripe having a minimum width of 1 inch (~~[25]~~ 25.4 mm). The stripe shall be placed on the top surface of the handrail for the entire length of the handrail, including extensions and newel post caps. Where handrails or handrail extensions bend or turn corners, the stripe shall not have a gap of more than 4 inches (~~[102]~~ 101.6 mm). Stripes on handrails shall comply with Figure S101.1(4) ~~[of]~~ in Appendix S.

Exception: The minimum width of 1 inch (~~[25]~~ 25.4 mm) shall not apply to outlining stripes listed in accordance with UL 1994.

[~~1024.2.4~~] 1025.2.4 Perimeter demarcation lines. Stair landings and other floor areas within interior exit ~~[enclosures]~~ stairways, interior exit ramps and exit passageways, with the exception of the sides of steps, shall be provided with solid and continuous demarcation lines on the floor or on the walls or a combination of both. The stripes shall be 1 to 2 inches (~~[25]~~ 25.4 mm to ~~[54]~~ 50.8 mm) wide with interruptions not exceeding 4 inches (~~[102]~~ 101.6 mm).

Exception: The minimum width of 1 inch (~~[25]~~ 25.4 mm) shall not apply to outlining stripes listed in accordance with UL 1994.

[~~1024.2.4.1~~] 1025.2.4.1 Floor-mounted demarcation lines. Perimeter demarcation lines shall be placed within 4 inches (~~[102]~~ 101.6 mm) of the wall and shall extend to within 2 inches (~~[54]~~ 50.8 mm) of the markings on the leading edge of landings. The demarcation lines shall continue across the floor in front of all doors. Perimeter demarcation lines shall comply with Figure S101.1(5) ~~[øf]~~ in Appendix S.

Exceptions:

1. Demarcation lines shall not extend in front of exit discharge doors that lead out of an exit ~~[enclosure]~~ and through which occupants must travel to complete the exit path.
2. Demarcation lines shall be continuous but need not extend into an area such as a dead end or an obstruction that is selected not to be outlined because it is not part of the egress path.

[~~1024.2.4.2~~] 1025.2.4.2 Wall-mounted demarcation lines. Perimeter demarcation lines shall be placed on the wall with the bottom edge of the stripe ~~[nø]~~ not more than 4 inches (~~[102]~~ 101.6 mm) above the finished floor. At the top or bottom of the stairs, demarcation lines shall drop vertically to the floor within 2 inches (~~[54]~~ 50.8 mm) of the step or landing edge. Demarcation lines on walls shall transition vertically to the floor and then extend across the floor where a line on the floor is the only practical method of outlining the path. Where the wall line is broken by a door, demarcation lines on walls shall continue across the face of the door or transition to the floor and extend across the floor in front of such door. Wall-mounted demarcation lines shall comply with Figure S101.1(8) ~~[øf]~~ in Appendix S.

Exceptions:

1. Demarcation lines shall not extend in front of exit discharge doors that lead out of an exit ~~[enclosure]~~ and through which occupants must travel to complete the exit path.
2. Perimeter demarcation lines are not required on the sides of steps.
3. Perimeter demarcation lines are not required where an area such as a dead end or an obstruction is selected not to be outlined because it is not part of the egress path,

the demarcation lines shall not be required in such area provided that a demarcation line is continuous across the floor.

[1024.2.4.3] 1025.2.4.3 Transition. Where a wall-mounted demarcation line transitions to a floor-mounted demarcation line, or vice versa, the wall-mounted demarcation line shall drop vertically to the floor to meet a complementary extension of the floor-mounted demarcation line, thus forming a continuous marking. Transitioning demarcation lines shall comply with Figure S101.1(7) [øf] in Appendix S.

[1024.2.5] 1025.2.5 Obstacles. Obstacles at or below 6 feet 6 inches ([1981] 1981.2 mm) in height and projecting more than 4 inches ([102] 101.6 mm) into the egress path shall be outlined with markings [nø] not less than 1 inch ([25] 25.4 mm) in width comprised of a pattern of alternating equal bands, of [luminescent] luminous material and black, with the alternating bands [nø] not more than 2 inches ([54] 50.8 mm) thick and angled at 45 degrees (0.79 rad). Obstacles shall include, but are not limited to, standpipes, hose cabinets, wall projections and restricted height areas. However, such markings shall not conceal any required information or indicators including[;] but not limited to[;] instructions to occupants for the use of standpipes. Markings on obstacles shall comply with Figure S101.1(6) [øf] in Appendix S.

[1024.2.6] 1025.2.6 Doors [from] within the exit [enclosures] path. Doors through which occupants [within an exit enclosure] must pass in order to complete the exit path, and doors serving horizontal exits, shall be provided with markings complying with Sections [1024.2.6.1] 1025.2.6.1 through [1024.2.6.3] 1025.2.6.3 of this chapter and Figures S101.1(11) and S101.1(12) [øf] in Appendix S. Exit discharge doors shall further comply with Section [1024.2.6.1.2] 1025.2.6.1.2.

[1024.2.6.1] 1025.2.6.1 Emergency exit symbol. The doors shall be identified by a low-location luminous emergency exit symbol complying with Section [1024.6.1] 1025.6.1. The exit symbol shall be [a minimum of] not less than 4 inches ([102] 101.6 mm) in height and shall be mounted on the door itself in accordance with Section [1024.2.6.1.1] 1025.2.6.1.1. Such signs shall be no higher than 18 inches ([457] 457.2 mm) above the finished floor.

[1024.2.6.1.1] 1025.2.6.1.1 Mounting location. The vertical centerline of the sign shall be centered with the door, or shall be in that half of the door, either the right or left, that contains the latch. In case of double-doors, both doors shall be marked and the signs shall be centered with the doors. Arrows may be omitted on door-mounted signs. Door-mounted signs shall comply with Figure S101.1(1) in Appendix S.

[1024.2.6.1.2] 1025.2.6.1.2 Exit discharge doors. At doors serving as exit discharge, a sign in compliance with Section [1024.2.6.1.1] 1025.2.6.1.1 shall contain supplemental directional text such as “FINAL EXIT,” “EXIT THROUGH LOBBY,” or “EXIT TO STREET” in sans serif letters one-half as high as the word EXIT. Exit discharge door sign shall comply with Figure S101.1(13) in Appendix S.

[1024.2.6.2] 1025.2.6.2 Door hardware markings. Door hardware shall be marked with [nø] not less than 16 square inches ([406 mm²]) (0.01 m²) of luminous material. This marking shall be located behind, immediately adjacent to, or on the door handle [and/] or escutcheon. Where a panic bar is installed, such material shall not be [nø] less than 1 inch ([25] 25.4 mm) wide

for the entire length of the actuating bar or touchpad. Additional hardware markings may include ANSI Z 535.1 safety green graphics such as arrows indicating door handle turning directions, or emergency egress symbols as per NFPA 170, the word “EXIT,” the word “PUSH,” and similar egress-related symbols, provided the minimum 16 square inches [~~406 mm²~~] (0.01 m²) of luminous materials is maintained.

[1024.2.6.3] 1025.2.6.3 Door frame markings. The top and sides of the door frame shall be marked with a solid and continuous [~~1-inch~~] 1- to [~~2-inch~~] 2-inch ([~~25~~] 25.4 mm to [~~51~~] 50.8 mm) wide [~~wide~~] stripe. Where the door molding does not provide sufficient flat surface on which to locate the stripe, the stripe shall be permitted to be located on the wall surrounding the frame.

[1024.2.7] 1025.2.7 Directional signage upon entering an interior exit [~~enclosures~~] stairway or ramp. Luminous directional signs designed in compliance with Section [~~1024.6.1~~] 1025.6.1 shall be placed in the interior exit [~~enclosure~~] stairway or ramp at every entrance thereto such that they are readily visible when the doors are in the open and closed positions. Such directional sign shall include an arrow indicating the direction of travel. The word “EXIT” shall not be required. The signs shall be located such that their top edge is within 18 inches ([~~457~~] 457.2 mm) above the finished floor. Directional signs shall comply with Figure S101.1(9) in Appendix S.

[1024.2.8] 1025.2.8 Directional signage at transfer levels and where egress direction is not clear. Luminous directional signs designed in compliance with Section [~~1024.6.1~~] 1025.6.1 and installed at heights indicated in Section [~~1024.2.7~~] 1025.2.7 shall be placed on the wall at transfer levels and wherever egress direction is not clear; including at turns along horizontal extensions, at transitions from vertical to horizontal direction and at a “T” intersection. These directional signs shall include arrows indicating the direction of travel. The word “EXIT” shall not be required. Directional signs at transfer levels shall comply with Figure S101.1(9) in Appendix S.

[1024.2.9] 1025.2.9 “No Exit” sign. Luminous signs shall be placed on doors along the egress path that lead to dead ends (mechanical rooms, storage closets, etc.). Such signs shall contain sans serif lettering at least 1 inch ([~~25~~] 25.4 mm) high reading “NO EXIT,” with the “NO” centered above the “EXIT.” The “NO” may be a larger size than the “EXIT” for clarity. The nonluminous portion of such signs shall not be green. No-exit signs shall comply with Figure S101.1(10) in Appendix S.

[1024.3] 1025.3 Uniformity. Placement and dimensions of markings shall be consistent and uniform throughout the same [~~exit~~] enclosure.

[1024.3.1] 1025.3.1 Solid and continuous. For the purposes of this section, solid and continuous means without gaps or interruption, except as required for the control of expansion and contraction. A series of dashes, chevrons, dots, or other similar patterns is not solid and continuous. Luminous materials shall be considered solid and continuous if they occasionally contain the following safety green (ANSI Z 535.1) symbols or text:

1. The word “EXIT”;
2. Egress symbol as per NFPA 170;

3. Direction arrows as per NFPA 170; or
4. Other text or symbols as approved by the commissioner.

[1024.4] 1025.4 Self-luminous and photoluminescent. Luminous egress path markings shall be permitted to be made of any material, including paint, provided that an electrical charge is not required to maintain the required luminance. Such materials shall include, but ~~are~~ not be limited to, self-luminous materials and photoluminescent materials. Materials shall comply with either of the following standards:

1. UL 1994~~[- or]~~.
2. ASTM E 2072, except that the charging source shall be 1 ~~foot-candle~~ footcandle (11 lux) of fluorescent illumination for 60 minutes, and the minimum luminance shall be 30 millicandelas per square meter at 10 minutes and 5 millicandelas per square meter after 90 minutes.

[1024.4.1] 1025.4.1 Labeling. All approved materials shall be labeled and identified with the manufacturer's name, model number and the name of the approved agency in a minimum of 6 point type with at least one such identification on each piece of material installed. However, labeling is not required for pieces of material less than 1 foot (304.8 mm) in length that are placed in immediate proximity of an identical model that is labeled. Materials may include supplemental identifying information such as the trade name or "NYC."

[1024.5] 1025.5 Reserved.

[1024.6] 1025.6 General standards. Luminous materials shall comply with the design standards of Sections ~~[1024.6.1]~~ 1025.6.1 and ~~[1024.6.2]~~ 1025.6.2.

[1024.6.1] 1025.6.1 Design of door and directional signs. Unless otherwise specified, all photoluminescent door signs and directional signs:

1. May be either positive or negative image;
2. Shall be made with the non-photoluminescent portions of the signs in safety green as per ANSI Z535.1; and
3. Shall include three components:
 - 3.1. The word "EXIT" printed in sans serif letters at least 4 inches high (~~[102]~~ 101.6 mm) with strokes no less than ½ inch (~~[13]~~ 12.7 mm);
 - 3.2. An emergency exit symbol at least 4 inches high (~~[102]~~ 101.6 mm), complying with NFPA 170; and
 - 3.3. An arrow at least 2¾ inches (~~[70]~~ 69.9 mm) high, complying with NFPA 170.

Design of door and directional sign shall comply with Figures S101.1(9), S101.1(13), S101.1(14) and S101.1(15) ~~[of]~~ in Appendix S.

[1024.6.1.1] 1025.6.1.1 Additional text for sign subject to this section. Additional descriptive text is permitted, provided such words are in sans serif letters and, where the word “EXIT” or the emergency symbol is required on such sign, such a descriptive text is no more than one-half as high as the word “EXIT” or the emergency exit symbol.

[1024.6.2] 1025.6.2 Figures. The figures in Appendix S are intended only for illustration, and where there is a conflict between the figures and this section, this section shall govern.

[1024.7] 1025.7 Voluntary installation. Where luminous egress path markings are not required but are voluntarily installed in the exit path, such markings shall comply with Section [1024] 1025.

[1024.8] 1025.8 Special inspection. Luminous exit path markings shall be subject to special inspection in accordance with Sections [1024.8.1] 1025.8.1 through [1024.8.3] 1025.8.3.

[1024.8.1] 1025.8.1 Inspection. A registered design professional shall verify by visual inspection that all components have been installed in accordance with Section [1024] 1025, both with the normal lighting turned on and with the normal and emergency lighting turned off.

[1024.8.2] 1025.8.2 Product identification. A registered design professional shall review the manufacturer product literature and information from the testing agency and verify that the products installed are labeled as meeting the standards in Section [1024.4] 1025.4. The registered design professional shall verify which particular products were installed in which parts of the building.

[1024.8.3] 1025.8.3 Paints. Where in situ painting was utilized, a registered design professional shall field-verify that the specified paint was utilized in accordance with the manufacturer recommended methods of application.

[1024.9] 1025.9 Maintenance program. Owners shall keep the required luminous egress path markings in good repair. At a minimum, owners shall, every 12 months, perform a visual inspection of the markings with the normal lighting turned on. Markings that are missing, damaged, loose, or that show signs of wear or missing labels shall be noted and promptly repaired. The log of such inspections, including the results and any corrective measures taken, shall be kept and maintained on the premises for inspection by the department and the Fire Department. The log shall contain the date of inspection and the printed name and signature of the person performing the inspection.

SECTION BC [1025] 1026 HORIZONTAL EXITS

[1025.1] 1026.1 Horizontal exits. Horizontal exits serving as an exit in a means of egress system shall comply with the requirements of this section. A horizontal exit shall not serve as the only exit from a portion of a building, and where two or more exits are required, not more than one-half of the total number of exits or total exit minimum width or required capacity shall be horizontal exits.

Exceptions:

1. Horizontal exits are permitted to comprise two-thirds of the required exits from any building or floor area for occupancies in Group I-2.

2. Horizontal exits are permitted to comprise 100 percent of the exits required for occupancies in Group I-3. ~~[At least]~~ Not less than 6 square feet (0.6 m²) of accessible space per occupant shall be provided on each side of the horizontal exit for the total number of people in adjoining compartments.
3. Horizontal exits are permitted to serve as the only exits from a portion of a building serving as an intermediate refuge area in accordance with Section 1026.4.2, Exception.

[1025.2] 1026.2 Separation. The separation between buildings or refuge areas connected by a horizontal exit shall be provided by a fire wall complying with Section 706; or ~~[it shall be provided]~~ by a fire barrier complying with Section 707 or a horizontal assembly complying with Section ~~[712]~~ 711, or both. The minimum fire-resistance rating of the separation shall be 2 hours. Opening protectives in horizontal exits shall also comply with Section ~~[715]~~ 716. Duct and air transfer openings in a fire wall or fire barrier that serves as a horizontal exit shall also comply with Section ~~[716]~~ 717. The horizontal exit separation shall extend vertically through all levels of the building unless floor assemblies have a fire-resistance rating of not less than 2 hours with no unprotected openings.

Exception: A fire-resistance rating is not required at horizontal exits between a building area and an above-grade pedestrian walkway constructed in accordance with Section 3104, provided that the distance between connected buildings is more than 20 feet (6096 mm).

Horizontal exits constructed as fire barriers shall be continuous from exterior wall to exterior wall so as to divide completely the floor served by the horizontal exit.

[1025.3] 1026.3 Opening protectives. Fire doors in horizontal exits shall be self-closing or automatic-closing when activated by a smoke detector in accordance with Section ~~[715.4.8.3]~~ 716.5.9.3. Doors, where located in a cross-corridor condition, shall be automatic-closing by activation of a smoke detector installed in accordance with Section ~~[715.4.8.3]~~ 716.5.9.3.

[1025.4 Capacity of refuge area] 1026.4 Refuge area. The refuge area of a horizontal exit shall be a space occupied by the same tenant or a public area and each such refuge area shall be adequate to accommodate the original occupant load of the refuge area plus the occupant load anticipated from the adjoining compartment. The anticipated occupant load from the adjoining compartment shall be based on the capacity of the horizontal exit doors entering the refuge area.

1026.4.1 Capacity. The capacity of the refuge area shall be computed based on a net floor area allowance of 3 square feet (0.2787 m²) for each occupant to be accommodated therein.

[Exception] Exceptions: The net floor area allowable per occupant shall be as follows for the indicated occupancies:

1. Six square feet (0.6 m²) per occupant for occupancies in Group I-3.
2. Fifteen square feet (1.4 m²) per occupant for ambulatory occupancies in Group I-2.
3. Thirty square feet (2.8 m²) per occupant for nonambulatory occupancies in Group I-2.

1026.4.2 Number of exits. The refuge area into which a horizontal exit leads shall be provided with exits adequate to meet the occupant requirements of this chapter, but not including the added occupant load imposed by persons entering ~~[it]~~ the refuge area through horizontal exits from ~~[other areas]~~ the adjoining compartment. ~~[At least]~~ Not less than one refuge area exit shall lead directly to the exterior or to an interior exit ~~[enclosure]~~ stairway or ramp. In addition to such refuge area exit, in buildings more than 420 feet (128 m) in height that are subject to Section 403.5.2, at least one other exit from each refuge area shall lead directly to the additional exit stairway required by Section 403.5.2, or shall provide access to occupant self-evacuation elevators where such elevators are permitted by Exception 1 or 2 of Section 403.5.2 in lieu of an additional exit stairway.

Exception: ~~[The]~~ A single intermediate refuge area between the adjoining compartment from which egress originates and the final refuge area shall not be required to have a stairway or door leading directly outside, provided the final refuge area into which a horizontal exit leads has stairways or doors leading directly outside and are so arranged that egress shall not require the occupants to return through the intermediate refuge area and the adjoining compartment from which egress originates.

SECTION BC ~~[1026]~~ 1027 **EXTERIOR EXIT ~~[RAMPS AND]~~ STAIRWAYS AND RAMPS**

~~[1026.1]~~ **1027.1 Exterior exit ~~[ramps and]~~ stairways and ramps.** Exterior exit ~~[ramps and]~~ stairways and ramps serving as an element of a required means of egress shall comply with this section.

~~[Exception: Exterior exit ramps and stairways for outdoor stadiums complying with Section 1022.1, Exception 2.]~~

~~[1026.2]~~ **1027.2 Use in a means of egress.** Exterior exit stairways shall not be used as an element of a required means of egress for Group I-2 occupancies. For all occupancies other than Group I-2, exterior exit ~~[ramps and]~~ stairways and ramps shall be permitted as an element of a required means of egress for buildings not exceeding six stories above grade plane or ~~[having occupied floors more than 75 feet (22 860 mm) above the lowest level of Fire Department vehicle access]~~ that are not high-rise buildings.

~~[1026.3]~~ **1027.3 Open side.** Exterior exit ~~[ramps and]~~ stairways and ramps serving as an element of a required means of egress shall be open on ~~[at least]~~ not less than one side~~[-]~~, except for required structural columns, beams, handrails and guards. An open side shall have ~~[a minimum of]~~ not less than 35 square feet (3.3 m²) of aggregate open area adjacent to each floor level and the level of each intermediate landing. The required open area shall be located not less than 42 inches (~~[1067]~~ 1066.8 mm) above the adjacent floor or landing level.

~~[1026.4]~~ **1027.4 Adjoining open areas.** The open areas adjoining exterior exit ~~[ramps or]~~ stairways or ramps shall be either yards, courts or public ways; the remaining sides are permitted to be enclosed by the exterior walls of the building.

[1026.5] 1027.5 Location. Exterior exit [~~ramps and~~] stairways [~~shall be located in accordance with Section 1027.3.~~] and ramps shall have a minimum fire separation distance of 10 feet (3048 mm) measured at right angles from the exterior edge of the stairway or ramps, including landings, to:

1. Adjacent lot lines.
2. Other portions of the building.
3. Other buildings on the same lot unless the adjacent building exterior walls and openings are protected in accordance with Section 705 based on fire separation distance.

For the purposes of this section, other portions of the building shall be treated as separate buildings.

Exception: Noncombustible stoops and ramps not exceeding one story above grade plane located at the street wall and terminating at the street are permitted to be located within 10 feet (3048 mm) of adjacent lot lines or buildings on the same lot when serving:

1. Group R-2 occupancies in buildings of noncombustible construction not exceeding four stories in height and a total of four dwelling units.
2. Group R-3 occupancies.

[1026.6] 1027.6 Exterior [~~ramps and~~] exit stairway and ramp protection. Exterior exit [~~ramps and~~] stairways and ramps shall be separated from the interior of the building as required in Section [1022.1] 1023.2. Openings shall be limited to those necessary for egress from normally occupied spaces. Where a vertical plane projecting from the edge of an exterior exit stairway or ramp and landings is exposed by other parts of the building at an angle of less than 180 degrees (3.14 rad), the exterior wall shall be rated in accordance with Section 1023.7.

Exceptions:

1. In all occupancies other than Group R-1 or R-2, separation from the interior of the building is not required in buildings that are [~~not~~] not more than two stories above grade plane where a level of exit discharge serving such occupancies is the first story above grade plane.
2. Separation from the interior of the building is not required where the exterior [~~ramp or~~] exit stairway or ramp is served by an exterior exit ramp or balcony that connects two remote exterior exit stairways or other approved exits, with a perimeter that is not less than 50 percent open. To be considered open, the opening shall be [~~a minimum of~~] not less than 50 percent of the height of the enclosing wall, with the top of the openings [~~not~~] not less than 7 feet ([~~2134~~] 2133.6 mm) above the top of the balcony.
3. Separation from the [~~interior~~] open-ended corridor of the building is not required for [~~an exterior ramp or stairway located in a building or structure that is permitted to have unenclosed interior stairways in accordance with Section 1022.1]~~ exterior exit stairways or ramps, provided that Items 3.1 through 3.5 are met.

[4. Separation from the interior of the building is not required for exterior ramps or stairways connected to open-ended corridors, provided that Items 4.1 through 4.4 are met:]

[4.1.] 3.1. The building, including open-ended corridors, and stairways and ramps [~~and stairs~~], shall be equipped throughout with an automatic sprinkler system in accordance with Section 903.3.1.1 or 903.3.1.2.

[4.2.] 3.2. The open-ended corridors comply with Section [~~1018~~] 1020.

[4.3.] 3.3. The open-ended corridors are connected on each end to an exterior exit [~~ramp or~~] stairway or ramp complying with Section [~~1026~~] 1027.

[4.4.] 3.4. The exterior walls and openings adjacent to the exterior exit stairway or ramp comply with Section 1023.7.

3.5. At any location in an open-ended corridor where a change of direction exceeding 45 degrees (0.79 rad) occurs, a clear opening of not less than 35 square feet (3.3 m²) or an exterior [~~ramp or~~] stairway or ramp shall be provided. Where clear openings are provided, they shall be located so as to minimize the accumulation of smoke or toxic gases.

[~~1026.7~~] 1027.7 Fire towers. Fire towers may be used as exits in lieu of interior stairs provided they comply with all of the requirements for stairways as per Section [~~1009~~] 1011, except as modified below.

[~~1026.7.1~~] 1027.7.1 Enclosure. The enclosing walls of fire towers shall be of noncombustible materials or assemblies having a fire-resistance rating of at least 4 hours. Such walls shall be without openings, except for doors serving as means of egress.

[~~1026.7.2~~] 1027.7.2 Access. At each story served by a fire tower, access to the stairways of such fire tower shall be provided through outside balconies or fireproof vestibules. Such balconies or vestibules shall be at least 44 inches ([~~1118~~] 1117.6 mm) in width and shall have unpierced floors of noncombustible materials and shall be provided with substantial guard railings at least 4 feet ([~~1219~~] 1220 mm) high, without any openings greater than 5 inches (127 mm) in width.

[~~1026.7.3~~] 1027.7.3 Balconies and vestibules. Such balconies or vestibules of fire towers shall be level with the floors of the structure and the platforms of the stairs connected by such balconies. Such balconies or vestibules shall be separated from the structure and the stairs by self-closing swinging doors with a one and ½-hour fire protection rating, capable of being opened from both sides without the use of a key or other unlocking device.

Balconies or vestibules of fire towers shall open on a street or yard, or on a court open vertically to the sky for its full height, having a minimum net area of 105 square feet (9.7 m²) and a minimum dimension of 7 feet ([~~2134~~] 2133.6 mm). The opening from the vestibule to the street, yard or court shall have a minimum area of 18 square feet (1.7 m²) and a minimum dimension of 30 inches (762 mm). It shall be unlawful to leave openings in the court walls surrounding an interior fire tower, other than the openings from the vestibules, within 15 feet (4572 mm) of the balcony, except that self-closing windows with a ¾-hour fire protection rating

may be used if such windows are at least 10 feet (3048 mm) from the balcony, provided that the area of the court is at least 12 feet by 24 feet (~~[3658]~~ 3657.6 mm by ~~[7315]~~ 7315.2 mm).

[1026.7.4] 1027.7.4 Termination. Fire towers shall terminate at grade level and shall exit directly to the street independently of corridors serving other stairways, except when the fire tower terminates in the ground floor corridor outside of the inner vestibule and within 10 feet (3048 mm) of the building line.

SECTION BC ~~[1027]~~ 1028 EXIT DISCHARGE

[1027.1] 1028.1 General. Exits shall discharge directly to the exterior of the building. The exit discharge shall be at grade or shall provide a direct [access] path of egress travel to grade. The exit discharge shall not reenter a building. The combined use of Exceptions 1 and 2 below shall not exceed 50 percent of the number and minimum width or required capacity of the required exits.

Exceptions:

1. ~~[A maximum of]~~ Not more than 50 percent of the number and minimum width or required capacity of ~~[the]~~ interior exit [enclosures] stairways and ramps is permitted to egress through protected areas on the level of discharge provided all of the following conditions are met:
 - 1.1. Such protected area shall ~~[provide]~~ be provided with a free and unobstructed path of travel to an exterior exit door and such exit is readily visible and identifiable within 40 feet from the point of termination of the ~~[exit]~~ enclosure.
 - 1.2. The protected area ~~[shall be]~~ of the level of exit discharge is separated from areas below by construction conforming to the fire-resistance rating for the ~~[exit]~~ enclosure.
 - 1.3. The protected area shall be provided with an approved automatic sprinkler system. ~~[All portions]~~ Portions of the level of exit discharge with access to the egress path shall be either ~~[be protected]~~ equipped throughout with an automatic sprinkler system installed in accordance with Section 903.3.1.1 or 903.3.1.2, or separated from the egress path in accordance with the requirements for the enclosure of ~~[exits]~~ interior exit stairways or ramps.
 - 1.4. Where a required interior exit stairway or ramp and an exit access stairway or ramp serve the same floor level and terminate at the same level of exit discharge, the termination of the exit access stairway or ramp and the exit discharge door of the interior exit stairway or ramp shall be separated by a distance of not less than 30 feet (9144 mm) or not less than one-fourth the length of the maximum overall diagonal dimension of the building, whichever is less. The distance shall be measured in a straight line between the exit discharge door from the interior exit stairway or ramp and the last tread of the exit access stairway or termination of slope of the exit access ramp.

- 1.5. The capacity of the protected area shall not be less than required by Section ~~[4027.2]~~ 1028.2 in addition to the occupant load of all exits serving communication spaces.
2. ~~[A maximum of]~~ Not more than 50 percent of the number and minimum width or required capacity of the interior exit ~~[enclosures]~~ stairways and ramps is permitted to egress through a vestibule provided all of the following conditions are met:
- 2.1. The entire area of the vestibule is separated from areas below by construction conforming to the fire-resistance rating ~~[for]~~ of the interior exit ~~[enclosure]~~ stairway or ramp enclosure.
- 2.2. The depth from the exterior of the building is not greater than 10 feet (3048 mm) and the length is not greater than 30 feet (9144 mm).
- 2.3. The area is separated from the remainder of the level of exit discharge by ~~[construction providing protection at least the equivalent of approved wired glass in steel frames]~~ a fire partition constructed in accordance with Section 708.
- Exception: The maximum transmitted temperature rise is not required.
- 2.4 The area is used only for means of egress and exits directly to the outside.
3. ~~[Stairways in open parking garages complying with Section 1022.1, Exception 4, are permitted to egress through the open parking garage at their levels of exit discharge.]~~
- ~~[4.]~~ In buildings in occupancy Group R-2, up to 100 percent of the number and minimum width and required capacity of the interior exit ~~[enclosures is]~~ stairways and ramps are permitted to egress through a protected area on the level of discharge, if all of the following conditions are met:
- ~~[4.1.]~~ 3.1. Egress is provided in two different directions from the discharge points of all interior exit ~~[enclosures]~~ stairways and ramps to the exterior of the building that are remote from each other.
- ~~[4.2.]~~ 3.2. The exit discharges are arranged and constructed so as to minimize the possibility that all exit discharges would be compromised by smoke, fire or other emergency condition~~[, and]~~.
- ~~[4.3.]~~ 3.3. Such protected areas shall comply with all requirements of Exception 1 above.
- ~~[5.]~~ 4. Horizontal exits complying with Section ~~[4025]~~ 1026 shall not be required to discharge directly to the exterior of the building.

1028.1.1 Fire Department access. Where Exception 1 or 2 to Section 1028.1 is not applied, not less than one exit that discharges directly to the exterior shall be accessible to the Fire Department:

1. Through an exit access door directly from the protected area or vestibule, as applicable. Such exit access door shall only be used by the Fire Department and shall not be used as

an exit. Signage indicating “No Exit. FDNY Access Only” shall be posted on both sides of the exit access door; or

2. Within a maximum of 100 feet (30 480 mm) from the exit of the protected area or vestibule, as applicable. Such distance shall be measured along a natural and unobstructed path between the nearest points of the exit doors.

[1027.2] 1028.2 Exit discharge width or capacity. The minimum width or required capacity of the exit discharge shall be not less than the minimum width or required [~~discharge~~] capacity of the exits being served.

[1027.3 Exit discharge location. Exterior balconies, stairways and ramps shall be located at least 10 feet (3048 mm) from adjacent lot lines and from other buildings on the same lot unless the adjacent building exterior walls and openings are protected in accordance with Section 705 based on fire separation distance.]

[Exception: Noncombustible stoops and ramps not exceeding one story above grade plane located at the street wall and terminating at the street are permitted to be located within 10 feet (3048 mm) of adjacent lot lines or buildings on the same lot when serving:]

- [1. Group R-2 occupancies in buildings of noncombustible construction not exceeding four stories in height and a total of four dwelling units.]

- [2. Group R-3 occupancies.]

[1027.4] 1028.3 Exit discharge components. Exit discharge components shall be sufficiently open to the exterior so as to minimize the accumulation of smoke and toxic gases.

[1027.5] 1028.4 Egress courts. Egress courts serving as a portion of the exit discharge in the means of egress system shall comply with the requirements of [~~Section 1027~~] Sections 1028.4.1 and 1028.4.2.

[1027.5.1] 1028.4.1 Width or capacity. The [~~width~~] required capacity of egress courts shall be determined as specified in Section [~~1005.1~~] 1005, but [~~such~~] the minimum width shall be not [~~be~~] less than 44 inches ([~~1118~~] 1117.6 mm), except as specified herein. Egress courts serving Group R-3 and U occupancies shall be not [~~be~~] less than 36 inches ([~~914~~] 914.4 mm) in width. The required capacity and width of egress courts shall be unobstructed to a height of 7 feet 6 inches (2286 mm).

Exception: [~~Doors~~] Encroachments complying with Section [~~1005.2~~] 1005.7.

Where an egress court exceeds the minimum required width and the width of such egress court is then reduced along the path of exit travel, the reduction in width shall be gradual. The transition in width shall be affected by a guard not less than 36 inches ([~~914~~] 914.4 mm) in height and shall not create an angle of more than 30 degrees (0.52 rad) with respect to the axis of the egress court along the path of egress travel. [~~In no case shall the~~] The width of the egress court shall not be less than the required [~~minimum~~] capacity.

[1027.5.1.1 Projections. Doors, when fully opened, and handrails shall not reduce the

~~required width by more than 7 inches (178 mm). Doors in any position shall not reduce the required width by more than one half. Other nonstructural projections such as trim and similar decorative features are permitted to project into the required width 1½ inches (38 mm) from each side.]~~

[1027.5.2] 1028.4.2 Construction and openings. Where an egress court serving a building or portion thereof is less than 10 feet (3048 mm) in width, the egress court walls shall have not less than 1-hour fire-resistance-rated construction for a distance of 10 feet (3048 mm) above the floor of the egress court. Openings within such walls shall be protected by opening protectives having a fire protection rating of not less than ¾ hour.

Exception: Protection of exterior walls shall not be required where:

1. Egress courts serving an occupant load of less than 10.
2. Egress courts serving Group R-3.

[1027.6] 1028.5 Access to a public way. The exit discharge shall provide a direct and unobstructed access to a public way.

Exception: Where access to a public way cannot be provided, a safe dispersal area shall be provided where all of the following are met:

1. The area shall be of a size to accommodate ~~[at least]~~ not less than 5 square feet (0.46 m²) for each person.
2. The area shall be located on the same lot ~~[at least]~~ not less than 50 feet (15 240 mm) away from the building requiring egress.
3. The area shall be permanently maintained and identified as a safe dispersal area.
4. The area shall be provided with a safe and unobstructed path of travel from the building.
5. The area shall be illuminated in accordance with Section ~~[4006.4]~~ 1008.

SECTION BC ~~[1028]~~ 1029 ASSEMBLY

[1028.1] 1029.1 General. ~~[Occupancies in Group]~~ A room or space used for assembly purposes that contains seats, tables, displays, equipment or other material shall comply with this section.

1029.1.1 Bleachers. Bleachers, grandstands and folding and telescopic seating, that are not building elements, shall comply with ICC 300. Bleachers, folding and telescopic seating, and grandstands shall be permitted to be constructed of combustible or noncombustible materials in accordance with Section 302 of ICC 300 and the following:

1. Where the number of seats or seating positions of the bleachers, grandstands, and folding and telescopic seating within an assembly space exceeds 300, the dedicated structural

system supporting the bleachers, folding and telescopic seating, or grandstands shall be constructed of noncombustible materials.

2. Where the space beneath the bleachers, grandstands, or folding and telescopic seating is used for placement of portable equipment, including but not limited to those for audio, video, data, lighting, motion control, and associated wiring, the decking on such bleachers, grandstands, or folding and telescopic seating shall be constructed of fire-retardant-treated wood complying with Section 2303.2 or other Class A materials.
3. Where the number of seats or seating positions of the bleachers, grandstands, and folding and telescopic seating within an assembly space exceeds 1,500, the dedicated structural system supporting the bleachers, grandstands, or folding and telescopic seating, and the decking on such bleachers, grandstands, or folding and telescopic seating, shall be constructed of noncombustible materials.

~~[No place of assembly shall be located within 250 feet (76 200 mm) of any occupancy containing explosive contents.]~~

1029.1.1.1 Spaces under grandstands and bleachers. Where spaces under grandstands or bleachers are used for purposes other than means of egress, ticket booths less than 100 square feet (9.29 m²) and toilet rooms, such spaces shall be separated by fire barriers complying with Section 707 and horizontal assemblies complying with Section 711, with not less than 1-hour fire-resistance-rated construction. An automatic smoke detection system shall be installed in such separated spaces. The system shall be activated in accordance with Section 907.5.

~~[1028.1.1]~~ **1029.1.2 Place of assembly Certificate of Operation.** A Certificate of Operation shall be required for a place of assembly in accordance with Section ~~[303.2]~~ 303.7. It shall be unlawful to occupy any building or space as a place of assembly unless and until a Certificate of Operation therefore has been issued by the department pursuant to the provisions of Chapter 1 of Title 28 of the *Administrative Code*.

~~[1028.1.2]~~ **1029.1.3 Posted capacity sign.** Signs shall be posted in all assembly spaces, indicating the number of persons who may legally occupy the space. Every room or space in such places of assembly shall have the occupant load of the room or space posted in a conspicuous place, near the main exit or exit access doorway from the room or space. Posted signs shall be of an approved legible permanent design in accordance with Section 1029.1.4, and shall be maintained by the owner or the owner's authorized agent.

Exception: Signs shall not be required where seating is fixed in place in accordance with an approved plan and no provision is made for standee spaces.

~~[Such]~~ Posted capacity signs, where required, shall read as follows:

OCCUPANCY BY MORE THAN
 PERSONS IS
 DANGEROUS AND UNLAWFUL
 Certificate of Operation No
 Commissioner, Dept. of Buildings, City of
 New York

[1028.1.2.1] 1029.1.3.1 Multiple-occupant load sign. When a space is occupied for multiple purposes involving different occupant loads the sign shall read as follows:

OCCUPANCY BY MORE THAN
 (number)PERSONS AS (type of occupancy) . . .
 OR BY
 (number)PERSONS AS (type of occupancy) . . .
 OR BY
 (number)PERSONS AS (type of occupancy) . . .
 IS DANGEROUS AND UNLAWFUL
 Certificate of Operation No
 Commissioner, Dept. of Buildings, City of New York

[1028.1.2.2] 1029.1.4 Design of capacity signs. Signs shall be at least 12 inches (~~[305]~~ 304.8 mm) wide and 16 inches (~~[406]~~ 406.4 mm) high. The lettering shall be red on a white background. The letters shall be at least 1 inch (~~[25]~~ 25.4 mm) high and the numerals at least 1¼ inches (~~[32]~~ 31.75 mm) high. Signs shall be framed under a transparent protective cover, and permanently mounted in a location that is conspicuously visible to a person entering the space. Signs shall be lighted by artificial illumination at all times during occupancy to maintain at least 5 ~~[foot-candles]~~ footcandles (54 lux) on the surface of the sign.

[1028.1.3] 1029.1.5 Approved plans. In every place of assembly providing seating or other moveable furnishings, copies of approved plans and approved alternate plans shall be kept on the premises. The plans shall be readily available for inspection, and shall provide the following information:

1. For assembly spaces:
 - 1.1. The location of each seat of each tier of seating, along with the number of occupants of each seating section.
 - 1.2. The location and number of standees for each standee area.
 - 1.3. The total number of occupants of each tier and of the assembly space.

- 1.4. The location and classification of all exits.
2. For safe areas:
 - 2.1. The furniture and equipment arrangement and location.
 - 2.2. The number of occupants to be accommodated.
3. For stage areas:
 - 3.1. The maximum number of occupants, including audience seating on the stage.
 - 3.2. Any conditions limiting the use of the stage area.
 - 3.3. The location of all exits.

These plans shall not be smaller in size than required for 1/8-inch (3.2 mm) scale plans.

[1028.2] 1029.2 Assembly with occupant load greater than 300. ~~[Buildings or spaces occupied by Group A that have]~~ A building, room or space used for assembly purposes that has an occupant load of greater than 300 [shall be] and is provided with a main exit[-Such], that main exit shall be of sufficient [width] capacity to accommodate not less than one-half of the occupant load, but such [width] capacity shall be not [be] less than the total required [width] capacity of all means of egress leading to the exit. Where the main use or dominant occupancy of the building is classified as a Group A occupancy, the main exit shall front on [at least] not less than one street or an unoccupied space of not less than 10 feet (3048 mm) in width that adjoins a street or public way. Other additional exits shall provide an egress capacity for at least one-half of the total occupant load served by that level and comply with Section [1015.2] 1007.1.

Exception: In a building, room or space used for assembly [occupancies] purposes where there is [no] not a well-defined main exit or where multiple main exits are provided, exits shall be permitted to be distributed around the perimeter of the building provided that the total [width] capacity of egress is not less than 100 percent of the required [width] capacity.

[1028.3] 1029.3 Reserved.

[1028.4] 1029.4 Foyers and lobbies. In Group A-1 occupancies, where persons are admitted to the building at times when seats are not available, such persons shall be allowed to wait in a lobby or similar space, provided such lobby or similar space shall not encroach upon the minimum width or required [clear width] capacity of the means of egress. Such foyer, if not directly connected to a public street by all the main entrances or exits, shall have a straight and unobstructed corridor or path of travel to every such main entrance or exit.

[1028.5] 1029.5 Interior balcony and gallery means of egress. For balconies, galleries or press boxes having a seating capacity of [50] 75 or more located in [Group A occupancies, at least] a building, room or space used for assembly purposes, not less than two means of egress shall be provided, with one from each side of every balcony, gallery[;] or press box[and at least one leading directly to an exit].

~~[1028.5.1 Enclosure of openings. Interior stairways and other vertical openings shall be enclosed in an exit enclosure as provided in Section 1022.1, except that stairways are permitted to be open between the balcony, gallery or press box and the main assembly floor in occupancies such as theaters, places of religious worship, auditoriums and sports facilities.]~~

1029.5.1 Accessible means of egress. At least one accessible means of egress is required from a balcony, gallery or press box level containing accessible seating locations in accordance with Section ~~[1007.3]~~ 1009.3 or ~~[1007.4]~~ 1009.4.

~~[1028.6]~~ **1029.6** ~~[Width of means]~~ **Capacity of [egress] aisle for assembly.** The ~~[clear width]~~ required capacity of aisles ~~[and other means of egress]~~ shall ~~[comply]~~ be not less than that determined in accordance with Section ~~[1028.6.1]~~ 1029.6.1 where smoke-protected assembly seating is not provided and with Section ~~[1028.6.2]~~ 1029.6.2 or ~~[1028.6.3]~~ 1029.6.3 where smoke-protected assembly seating is provided. ~~[The clear width shall be measured to walls, edges of seating and tread edges except for permitted projections.]~~

~~[1028.6.1]~~ **1029.6.1 Without smoke protection.** The ~~[clear width]~~ required capacity in inches (mm) of the aisles ~~[and other means of egress shall provide sufficient capacity]~~ for assembly seating without smoke protection shall be not less than the occupant load served by the egress element in accordance with all of the following, as applicable:

1. ~~[At least]~~ Not less than 0.3 inch (7.6 mm) of [width] aisle capacity for each occupant served shall be provided on ~~[stairs]~~ stepped aisles having riser heights 7 inches (~~[178]~~ 177.8 mm) or less and tread depths 11 inches (~~[279]~~ 279.4 mm) or greater, measured horizontally between tread ~~[nosing]~~ nosings.
2. ~~[At least]~~ Not less than 0.005 inch (0.127 mm) of additional [stair width] aisle capacity for each occupant shall be provided for each 0.10 inch (2.5 mm) of riser height above 7 inches (~~[178]~~ 177.8 mm).
3. Where egress requires ~~[stair]~~ stepped aisle descent, ~~[at least]~~ not less than 0.075 inch (1.9 mm) of additional [width] aisle capacity for each occupant shall be provided on those portions of ~~[stair width] aisle capacity~~ having no handrail within a horizontal distance of 30 inches (762 mm).
4. Ramped ~~[means of egress]~~ aisles, where slopes are steeper than one unit vertical in 12 units horizontal (8-percent slope), shall have ~~[at least]~~ not less than 0.22 inch (5.6 mm) of clear [width] aisle capacity for each occupant served. Level or ramped ~~[means of egress]~~ aisles, where slopes are not steeper than one unit vertical in 12 units horizontal (8-percent slope), shall have ~~[at least]~~ not less than 0.20 inch (5.1 mm) of clear [width] aisle capacity for each occupant served.

~~[1028.6.2]~~ **1029.6.2 Smoke-protected assembly seating.** The ~~[clear width]~~ required capacity in inches (mm) of [aisles and other means of egress] the aisle for smoke-protected assembly seating shall be not [be] less than the occupant load served by the egress element multiplied by the appropriate factor in Table [1028.6.2] 1029.6.2 of this code. The total number of seats specified shall be those within the space and exposed to the same smoke-protected environment. Interpolation is permitted between the specific values shown. A life safety evaluation, complying

with NFPA 101, shall be done for a facility utilizing the reduced width requirements of Table [1028.6.2] 1029.6.2 of this code for smoke-protected assembly seating subject to the approval by the commissioner.

Exception: For ~~an~~ outdoor smoke-protected assembly seating with an occupant load not greater than 18,000, the ~~clear width~~ required capacity in inches (mm) shall be determined using the factors in Section [1028.6.3] 1029.6.3.

**TABLE [1028.6.2] 1029.6.2
[WIDTH OF AISLES AND OTHER MEANS OF EGRESS] CAPACITY FOR AISLES
FOR SMOKE-PROTECTED ASSEMBLY**

TOTAL NUMBER OF SEATS IN THE [SPACE EXPOSED TO THE SAME] SMOKE-PROTECTED [ENVIRONMENT] ASSEMBLY SEATING	INCHES OF CLEAR WIDTH PER SEAT SERVED			
	[Stairs and aisle steps] Stepped aisles with handrails within 30 inches	[Stairs and aisle steps] Stepped aisles without handrails within 30 inches	[Passageways, doorways and ramps] Level aisles or ramped aisles not steeper than 1 in 10 in slope	[Ramps] Ramped aisles steeper than 1 in 10 in slope
Equal to or less than 5,000	0.200	0.250	0.150	0.165
10,000	0.130	0.163	0.100	0.110
15,000	0.096	0.120	0.070	0.077
20,000	0.076	0.095	0.056	0.062
Equal to or greater than 25,000	0.060	0.075	0.044	0.048

For SI: 1 inch = 25.4 mm.

[1028.6.2.1] 1029.6.2.1 Smoke control. ~~[Means of egress]~~ Aisles and aisle accessways serving a smoke-protected assembly seating area shall be provided with a smoke control system complying with Section 909 or natural ventilation designed to maintain the smoke level ~~[at least]~~ not less than 6 feet (~~[1829]~~ 1828.8 mm) above the floor of the means of egress.

[1028.6.2.2] 1029.6.2.2 Roof height. A smoke-protected assembly seating area with a roof shall have the lowest portion of the roof deck not less than 15 feet (4572 mm) above the highest aisle or aisle accessway.

Exception: A roof canopy in an outdoor stadium shall be permitted to be less than 15 feet (4572 mm) above the highest aisle or aisle accessway provided that there are no objects less than 80 inches (2032 mm) above the highest aisle or aisle accessway.

[1028.6.2.3] 1029.6.2.3 Automatic sprinklers. Enclosed areas with walls and ceilings in buildings or structures containing smoke-protected assembly seating shall be protected with an approved automatic sprinkler system in accordance with Section 903.3.1.1.

Exceptions:

1. The floor area used for contests, performances or entertainment, provided the roof construction is more than 50 feet (15 240 mm) above the floor level and the use is restricted to low fire hazard uses.

2. Press boxes and storage facilities less than 1,000 square feet (~~93~~ 92.9 m²) in area.
3. Outdoor seating facilities where seating and the means of egress in the seating area are essentially open to the outside.

~~[1028.6.3]~~ **1029.6.3** ~~[Width of means of egress for outdoor]~~ **Outdoor smoke-protected assembly seating.** The ~~[clear width]~~ required capacity in inches (mm) of aisles ~~[and other means of egress]~~ shall be not less than the total occupant load served by the egress element multiplied by 0.08 (2.0 mm) where egress is by ~~[aisles and stairs]~~ stepped aisle and multiplied by 0.06 (1.52 mm) where egress is by ramps, corridors, tunnels, ~~[or]~~ vomitories, level aisles or ramped aisles.

Exception: The ~~[clear width]~~ required capacity in inches (mm) of aisles ~~[and other means of egress]~~ shall be permitted to comply with Section ~~[1028.6.2]~~ 1029.6.2 for the number of seats in the outdoor smoke-protected assembly seating where Section ~~[1028.6.2]~~ 1029.6.2 permits less ~~[width]~~ capacity.

~~[1028.7]~~ **1029.7 Travel distance.** Exits and aisles shall be so located such that the travel distance to an exit door shall be provided in accordance with Table ~~[1028.7]~~ 1029.7. At least one exit ~~[opening]~~ door shall be available from every attached seat or standee space in an assembly space, or from the most remote point in the space when movable seats are provided or, when no seats are provided, within the primary travel distance limitation listed in Table ~~[1028.7]~~ 1029.7. In addition, an alternate exit ~~[opening]~~ door shall be available from every attached seat or standee space, or from the most remote point when attached seats are not provided within the secondary travel distance limitation listed in Table ~~[1028.7]~~ 1029.7. Such alternate exit ~~[openings]~~ door may serve to satisfy the requirements for primary travel distance for other seats or locations. Exit ~~[openings]~~ door satisfying the primary and secondary travel distance requirements for any one seat or location shall be separated ~~[from each other by a distance of at least 25 feet (7620 mm)]~~ in accordance with Section 1007.1. Where aisles are provided for seating, the distance shall be measured along the aisles and aisle accessway without travel over or on the seats.

[Exception] Exceptions: For the purposes of this section, travel distances may be measured in accordance with the following exceptions:

1. Smoke-protected assembly seating: The primary travel distance shall be permitted to be measured from each seat or standee space to the nearest entrance to a vomitory or concourse, and shall not exceed 200 feet (60 960 mm). The secondary travel distance shall be permitted to be measured from each such seat or standee space to an alternate entrance to the vomitory or concourse, and shall not exceed 300 feet (91 440 mm). The travel distance from any such [entrance] entrances to the vomitory or concourse to a [stair] stairway, ramp or walk on the exterior of the building shall not exceed 200 feet (60 960 mm).
2. Open-air seating served by exit access stairways and ramps: The primary travel distance shall be permitted to be measured from each seat or standee space to the closest riser of an exit access stairway or the closest slope of an exit access ramp that are outside the assembly space. The secondary travel distance shall be permitted to be measured to the closest riser of an alternate exit access stairway or the closest slope of an alternate exit

access ramp that are outside the assembly space.

3. Assembly with safe areas: Where an assembly space is provided with an exit access doorway that opens directly to a safe area in accordance with Section 1029.19, the primary travel distance shall be permitted to be measured to such an exit access doorway. The secondary travel distances shall also be permitted to be measured to an alternate exit access doorway that opens directly to a safe area. The travel distance within safe areas shall be in accordance with Section 1017 based on the occupancy classification of the main occupancy of the building or portion thereof to which the assembly space is ancillary. Where a safe area contains other occupancies, travel distances within such safe area shall comply with Section 1017.
4. Assembly with open exterior spaces: Where an assembly space is provided with an exit that opens directly to an open exterior space in accordance with Section 1029.19, the primary and secondary travel distances shall be measured to such an exit.

**TABLE [1028.7] 1029.7
TRAVEL DISTANCE**

OCCUPANCY	NON-SPRINKLERED		SPRINKLERED	
	PRIMARY	SECONDARY	PRIMARY	SECONDARY
A-1, A-2, A-3, A-4	100	150	150	250
A-5	200	300	200	300

[1028.8] 1029.8 Common path of egress travel. The common path of egress travel shall not exceed 30 feet (9144 mm) from any seat to a point where an occupant has a choice of two paths of egress travel to two exits.

Exceptions:

1. For areas, such as box seats, galleries or balconies, serving [~~not more~~] less than [50] 75 occupants, the common path of egress travel shall not exceed 75 feet (22 860 mm).
2. For smoke-protected assembly seating, the common path of egress travel shall not exceed 50 feet (15 240 mm).

1029.8.1 Path through adjacent row. Where one of the two paths of travel is across the aisle through a row of seats to another aisle, there shall be not more than 24 seats between the two aisles, and the minimum clear width between rows for the row between the two aisles shall be 12 inches (304.8 mm) plus 0.6 inch (15.2 mm) for each additional seat above seven in the row between aisles.

Exception: For smoke-protected assembly seating there shall be not more than 40 seats between the two aisles and the minimum clear width shall be 12 inches (304.8 mm) plus 0.3 inch (7.6 mm) for each additional seat.

~~[1028.9]~~ **1029.9 Assembly aisles are required.** Every occupied portion of any ~~[occupancy in Group A]~~ building, room or space used for assembly purposes that contains seats, tables, displays, similar fixtures or equipment shall be provided with aisles leading to exits or exit access doorways in accordance with this section. ~~[Aisle accessways for tables and seating shall comply with Section 1017.4.]~~

~~[1028.9.1]~~ **1029.9.1 Minimum aisle width.** The minimum clear width ~~[of]~~ for aisles shall ~~[be as shown]~~ comply with one of the following:

1. Forty-eight inches (~~[1219]~~ 1220 mm) for ~~[aisle stairs]~~ stepped aisles having seating on each side.

Exception: Thirty-six inches (~~[914]~~ 914.4 mm) where the ~~[aisle does not]~~ stepped aisles serve ~~[more]~~ less than ~~[50]~~ 51 seats.

2. Thirty-six inches (~~[914]~~ 914.4 mm) for ~~[aisle stairs]~~ stepped aisles having seating on only one side.

Exception: Twenty-three inches (584 mm) between a stepped aisle handrail and seating where a stepped aisle does not serve more than five rows on one side.

3. Twenty-three inches (584 mm) between an aisle stair handrail or guard and seating where the stepped aisle is subdivided by a mid-aisle handrail.

4. Forty-two inches (~~[1067]~~ 1066.8 mm) for level or ramped aisles having seating on both sides.

Exception: Thirty-six inches (~~[914]~~ 914.4 mm) where the aisle ~~[does not serve more]~~ serves less than ~~[50]~~ 51 seats.

5. Thirty-six inches (~~[914]~~ 914.4 mm) for level or ramped aisles having seating on only one side.

6. Thirty-six inches (914.4 mm) for aisles other than those listed above and cross-aisles serving less than 51 persons.

~~[1028.9.2]~~ **1029.9.2 Aisle ~~[width]~~ catchment area.** The aisle ~~[width]~~ shall provide sufficient ~~[egress]~~ capacity for the number of persons accommodated by the catchment area served by the aisle. The catchment area served by an aisle is that portion of the total space ~~[that is]~~ served by that section of the aisle. In establishing catchment areas, the assumption shall be made that there is a balanced use of all means of egress, with the number of persons in proportion to egress capacity.

~~[1028.9.3]~~ **1029.9.3 Converging aisles.** Where aisles converge to form a single path of egress travel, the required ~~[egress]~~ capacity of that path shall be not ~~[be]~~ less than the combined required capacity of the converging aisles.

~~[1028.9.4]~~ **1029.9.4 Uniform width and capacity.** Those portions of aisles, where egress is possible in either of two directions, shall be uniform minimum width or [in] required [width] capacity.

~~[1028.9.5]~~ **1029.9.5 [Assembly aisle termination] Dead end aisles.** Each end of an aisle shall ~~[terminate at]~~ be continuous to a cross aisle, foyer, doorway, vomitory, [or] concourse or stairway in accordance with Section 1029.9.7 having access to an exit. Travel through dead-end aisles shall be subject to Section 1029.8. Dead-end aisles shall be not greater than 20 feet (6096 mm) in length.

Exceptions:

1. ~~[Dead-end aisles shall not be greater than 20 feet (6096 mm) in length.]~~
2. ~~For smoke-protected assembly seating, the dead-end aisle length of vertical aisles shall not exceed a distance of 50 feet (15 240 mm)]~~ A dead-end aisle of up to 16 rows shall be permitted to exceed 20 feet (6096 mm) in length where seats served by the dead-end aisle are not more than 24 seats from another aisle, measured along a row of seats having a clear width of not less than 12 inches (304.8 mm) plus 0.6 inches (15.2 mm) for each additional seat over a total of 7 in the row.
2. For smoke-protected assembly seating, dead end aisles of up to 21 rows may be permitted to exceed 20 feet (6096 mm) in length provided seats served by the dead-end aisle are not more than 40 seats from another aisle, measured along a row of seats having a clear width of not less than 12 inches (304.8 mm) plus 0.3 inches (7.6 mm) for each additional seat over a total of 7 in the row.

1029.9.6 Aisle measurement. The clear width for aisles shall be measured to walls, edges of seating and tread edges except for permitted projections.

Exception: The clear width of aisles adjacent to seating at tables shall be permitted to be measured in accordance with Section 1029.12.1.

~~[1028.9.6]~~ **1029.9.6.1 Assembly aisle obstructions.** There shall not be ~~[no]~~ obstructions in the minimum width or required [width of aisles except for handrails as provided in Section 1028.13] capacity of aisles.

Exception: Handrails are permitted to project into the required width of stepped aisles and ramped aisles in accordance with Section 1014.8.

1029.9.7 Stairways connecting to stepped aisles and vomitories. A stairway that connects a stepped aisle or a vomitory to a cross aisle, concourse, or to another aisle shall be permitted to comply with the assembly aisle walking surface requirements of Section 1029.13. Transitions between stairways and stepped aisles shall comply with Section 1029.10.

1029.10 Transitions. Transitions between stairways and stepped aisles shall comply with either Section 1029.10.1 or 1029.10.2.

1029.10.1 Transitions and stairways that maintain stepped aisle riser and tread dimensions. Stepped aisles, transitions and stairways that maintain riser and tread dimensions shall comply with Section 1029.13 as one exit access component.

1029.10.2 Transitions to stairways that do not maintain stepped aisle riser and tread dimensions. Transitions to stairways from stepped aisles with riser and tread dimensions that differ from the stairways shall comply with Sections 1029.10.2.1 through 1029.10.3.

1029.10.2.1 Stairways and stepped aisles in a straight run. Transitions where the stairway is a straight run from the stepped aisle shall have a minimum depth of 22 inches (558.8 mm) where the treads on the descending side of the transition have greater depth and 30 inches (762 mm) where the treads on the descending side of the transition have lesser depth.

1029.10.2.2 Stairways and stepped aisles that change direction. Transitions where the stairway changes direction from the stepped aisle shall have a minimum depth of 11 inches (279.4 mm) or the stepped aisle tread depth, whichever is greater, between the stepped aisle and stairway.

1029.10.3 Transition marking. A distinctive marking stripe shall be provided at each nosing or leading edge adjacent to the transition. Such stripe shall be not less than 1 inch (25.4 mm), and not more than 2 inches (50.8 mm), wide. The edge marking stripe shall be distinctively different from the stepped aisle contrasting marking stripe.

1029.11 Construction. Aisles, stepped aisles and ramped aisles shall be built of materials consistent with the types permitted for the type of construction of the building.

Exception: Wood handrails shall be permitted for all types of construction. Bleachers, grandstands and folding and telescopic seating shall be built of materials permitted by Section 1029.1.1.

1029.11.1 Walking surface. The surface of aisles, stepped aisles and ramped aisles shall be of slip-resistant materials that are securely attached. The surface for stepped aisles shall comply with Section 1011.7.1.

1029.11.2 Outdoor conditions. Outdoor aisles, stepped aisles and ramped aisles and outdoor approaches to aisles, stepped aisles and ramped aisles shall be designed so that water will not accumulate on the walking surface.

1029.12 Aisle accessways. Aisle accessways for seating at tables shall comply with Section 1029.12.1. Aisle accessways for seating in rows shall comply with Section 1029.12.2.

1029.12.1 Seating at tables. Where seating is located at a table or counter and is adjacent to an aisle or aisle accessway, the measurement of required clear width of the aisle or aisle accessway shall be made to a line 19 inches (482.6 mm) away from and parallel to the edge of the table or counter. The 19-inch (482.6 mm) distance shall be measured perpendicular to the side of the table or counter. In the case of other side boundaries for aisles or aisle accessways, the clear width shall be measured to walls, edges of seating and tread edges.

Exception: Where tables or counters are served by fixed seats, the width of the aisle or aisle accessway shall be measured from the back of the seat.

1029.12.1.1 Aisle accessway capacity and width for seating at tables. Aisle accessways serving arrangements of seating at tables or counters shall comply with the capacity requirements of Section 1005 but shall not have less than 12 inches (304.8 mm) of width plus 1/2 inch (12.7 mm) of width for each additional 1 foot (304.8 mm), or fraction thereof, beyond 12 feet (3657.6 mm) of aisle accessway length measured from the center of the seat farthest from an aisle.

Exception: Portions of an aisle accessway having a length not exceeding 6 feet (1828.8 mm) and used by a total of not more than four persons.

1029.12.1.2 Seating at table aisle accessway length. The length of travel along the aisle accessway shall not exceed 30 feet (9144 mm) from any seat to the point where a person has a choice of two or more paths of egress travel to separate exits.

~~[1028.10]~~ **1029.12.2 Clear width of aisle accessways serving seating in rows.** Where seating rows have 14 or fewer seats, the minimum clear aisle accessway width shall be not [be] less than 12 inches (~~[305]~~ 304.8 mm) measured as the clear horizontal distance from the back of the row ahead and the nearest projection of the row behind. Where chairs have automatic or self-rising seats, the measurement shall be made with seats in the raised position. Where any chair in the row does not have an automatic or self-rising seat, the measurements shall be made with the seat in the down position. For seats with folding tablet arms, row spacing shall be determined with the tablet arm in the used position.

Exception: For seats with folding tablet arms, row spacing is permitted to be determined with the tablet arm in the stored position where the tablet arm when raised manually to vertical position in one motion automatically returns to the stored position by force of gravity.

~~[1028.10.1]~~ **1029.12.2.1 Dual access.** For rows of seating served by aisles or doorways at both ends, there shall be not [be] more than 100 seats per row. The minimum clear width of 12 inches (~~[305]~~ 304.8 mm) between rows shall be increased by 0.3 inch (7.6 mm) for every additional seat beyond 14 seats [, but the] where seats have backrests or beyond 21 where seats are without backrests. The minimum clear width is not required to exceed 22 inches (~~[559]~~ 558.8 mm).

Exception: For smoke-protected assembly seating, the row length limits for a 12-inch-wide (~~[305]~~ 304.8 mm) aisle accessway, beyond which the aisle accessway minimum clear width shall be increased, are in Table ~~[1028.10.1]~~ 1029.12.2.1.

**TABLE [1028.10.1] 1029.12.2.1
SMOKE-PROTECTED
ASSEMBLY AISLE ACCESSWAYS**

TOTAL NUMBER OF SEATS IN THE SMOKE-PROTECTED ASSEMBLY SEATING	MAXIMUM NUMBER OF SEATS PER ROW PERMITTED TO HAVE A MINIMUM 12-INCH	
	Aisle or doorway at both ends of row	
	Seats with backrests	Seats without backrests
Less than 4,000	14	<u>21</u>
4,000	15	<u>22</u>
7,000	16	<u>23</u>
10,000	17	<u>24</u>
13,000	18	<u>25</u>
16,000	19	<u>26</u>
19,000	20	<u>27</u>
22,000 and greater	21	<u>28</u>

For SI: 1 inch = 25.4 mm.

[1028.10.2] 1029.12.2.2 Single access. For rows of seating served by an aisle or doorway at only one end of the row, the minimum clear width of 12 inches ([305] 304.8 mm) between rows shall be provided. Not more than eight chairs shall be provided in such row of seating.

[1028.11] 1029.13 Assembly aisle walking surfaces. Ramped aisles shall comply with Section 1029.13.1. Stepped aisles shall comply with Section 1029.13.2.

1029.13.1 Ramped aisles. Aisles [~~with a slope not exceeding~~] that are sloped more than one unit vertical in [~~eight~~] 20 units horizontal ([~~12.5~~] 5-percent slope) shall [~~consist~~] be considered a ramped aisle. Ramped aisles that serve as part of [~~a ramp having~~] an accessible route in accordance with Sections 1009 and 1108.2 shall have a [~~slip-resistant walking surface~~] maximum slope of one unit vertical in 12 units horizontal (8-percent slope). The slope of other ramped aisles shall not exceed one unit vertical in 8 units horizontal (12.5-percent slope).

1029.13.1.1 Cross slope. The slope measured perpendicular to the direction of travel of a ramped aisle shall not be steeper than one unit vertical in 48 units horizontal (2-percent slope).

1029.13.1.2 Landings. Ramped aisles shall have landings in accordance with Sections 1012.6 through 1012.6.5. Landings for ramped aisles shall be permitted to overlap required aisles or cross aisles.

1029.13.1.3 Edge protection. Ramped aisles shall have edge protection in accordance with Section 1012.10 and 1012.10.1.

Exception: In assembly spaces with fixed seating, edge protection is not required on the sides of ramped aisles where the ramped aisles provide access to the adjacent seating and aisle accessways.

1029.13.2 Stepped aisles. Aisles with a slope exceeding one unit vertical in eight units horizontal (12.5-percent slope) shall consist of a series of risers and treads that extends across the full width of aisles and complies with Sections ~~[1028.11.1]~~ 1029.13.2.1 through ~~[1028.11.4]~~ 1029.13.2.4.

~~[1028.11.1]~~ **1029.13.2.1 Treads.** Tread depths shall be ~~[a minimum of]~~ not less than 11 inches (~~[279]~~ 279.4 mm) and shall have dimensional uniformity.

Exception: The tolerance between adjacent treads shall not exceed ~~[0.188]~~ $\frac{3}{16}$ inch (4.8 mm).

~~[1028.11.2]~~ **1029.13.2.2 Risers.** Where the gradient of ~~[aisle stairs]~~ stepped aisles is to be the same as the gradient of adjoining seating areas, the riser height shall be not ~~[be]~~ less than 4 inches (~~[102]~~ 101.6 mm) nor more than 8 inches (~~[203]~~ 203.2 mm) and shall be uniform within each flight.

Exception: Riser height nonuniformity shall be limited to the extent necessitated by changes in the gradient of the adjoining seating area to maintain adequate sightlines. Where nonuniformities exceed ~~[0.188]~~ $\frac{3}{16}$ inch (4.8 mm) between adjacent risers, the exact location of such nonuniformities shall be indicated with a distinctive marking stripe on each tread at the nosing or leading edge adjacent to the nonuniform risers. Such stripe shall be ~~[a minimum of]~~ not less than 1 inch (~~[25]~~ 25.4 mm), and ~~[a maximum of]~~ not more than 2 inches (~~[54]~~ 50.8 mm), wide. The edge marking stripe shall be distinctively different from the contrasting marking stripe.

1029.13.2.2.1 Construction tolerances. The tolerance between adjacent risers on a stepped aisle that were designed to be equal height shall not exceed $\frac{3}{16}$ inch (4.8 mm). Where the stepped aisle is designed in accordance with the Exception of Section 1029.13.2.2, the stepped aisle shall be constructed so that each riser of unequal height, determined in the direction of descent, is not more than $\frac{3}{8}$ inch (9.5 mm) in height different from adjacent risers where stepped aisle treads are less than 22 inches (560 mm) in depth and $\frac{3}{4}$ inch (19.1 mm) in height different from adjacent risers where stepped aisle treads are 22 inches (558.8 mm) or greater in depth.

~~[1028.11.3]~~ **1029.13.2.3 Tread contrasting marking stripe.** A contrasting marking stripe shall be provided on each tread at the nosing or leading edge such that the location of each tread is readily apparent when viewed in descent. Such stripe shall be ~~[a minimum of]~~ not less than 1 inch (~~[25]~~ 25.4 mm), and ~~[a maximum of]~~ not more than 2 inches (~~[54]~~ 50.8 mm), wide.

Exception: The contrasting marking stripe is permitted to be omitted where tread surfaces are such that the location of each tread is readily apparent when viewed in descent.

1029.13.2.4 Nosing and profile. Nosing and riser profile shall comply with Sections 1011.5.5 through 1011.5.5.3.

~~[1028.11.4 Step lighting. Each step shall have a steplight.]~~

~~[1028.11.5]~~ **1029.13.3 Aisle illumination.** Aisles, ~~[and]~~ cross aisles and stepped aisles shall be illuminated in accordance with Section ~~[1006.2]~~ 1008.2.1.

~~[1028.12]~~ **1029.14 Seat stability.** In ~~[places of]~~ a building, room or space used for assembly purposes, the seats shall be securely fastened to the floor.

Exceptions:

1. In ~~[places of]~~ a building, room or space used for assembly purposes or portions thereof ~~[without ramped or tiered floors]~~ for seating and with 200 or fewer seats, the seats shall not be required to be fastened to the floor, provided that the seating area has a minimum net floor area of 12 square feet (1.11 m²) per person or all seats in a row shall be fastened together with a maximum of 12 seats between aisles where 12 square feet (1.11 m²) per person is not provided.
2. In ~~[places of]~~ a building, room or space used for assembly purposes or portions thereof with seating at tables and without ramped or tiered floors for seating, the seats shall not be required to be fastened to the floor.
3. In a building, room or space used for assembly purposes or portions thereof with seating at tables on ramped or tiered floors, the seats shall not be required to be fastened to the floor provided that the seating area has a minimum net floor area of 12 square feet (1.11 m²) per person.
- ~~[3-]~~ 4. In ~~[places of]~~ a building, room or space used for assembly purposes or portions thereof ~~[without ramped or tiered floors]~~ for seating and with greater than 200 seats, the seats shall be securely fastened to the floor, or all seats in a row shall be fastened together with a maximum of 12 seats between aisles.
- ~~[4-]~~ 5. In ~~[places of]~~ a building, room or space used for assembly purposes where flexibility of the seating arrangement is an integral part of the design and function of the space ~~[and seating is on tiered levels]~~, a ~~[maximum]~~ seating area of up to 200 seats shall not be required to be fastened to the floor, provided that the seating area has a minimum net floor area of 12 square feet (1.11 m²) per person or all seats in a row in such seating area shall be fastened together with a maximum of 12 seats between aisles where 12 square feet (1.11 m²) per person is not provided.
- ~~[5-]~~ 6. Groups of seats within a ~~[place of]~~ building, room or space used for assembly purposes separated from other seating by railings, guards, partial height walls or similar barriers with level floors and having ~~[no]~~ not more than 14 seats per group shall not be required to be fastened to the floor.
- ~~[6-]~~ 7. Seats intended for musicians or other performers and separated by railings, guards, partial height walls or similar barriers shall not be required to be fastened to the floor.

Where a building, room or space used for assembly purposes includes mixed seating arrangements and conditions, the seat stability requirements and allowances shall be applied respectively to each portion of the space containing such seating.

~~[1028.13]~~ **1029.15 Handrails.** Ramped aisles having a slope exceeding one unit vertical in 15 units horizontal (6.7-percent slope) and ~~[aisle stairs]~~ stepped aisles shall be provided with handrails in compliance with Section 1014 located either at one or both sides of the ~~[side]~~ aisle or within the aisle width.

Exceptions:

1. Handrails are not required for ramped aisles ~~[having a gradient no greater than one unit vertical in eight units horizontal (12.5 percent slope) and]~~ with seating on both sides.
2. Handrails are not required ~~[if]~~ where, at the side of the aisle, there is a guard with a top surface that complies with the graspability requirements of handrails in accordance with Section 1014.3.
3. Handrail extensions are not required at the top and bottom of ~~[aisle stairs]~~ stepped aisles and ~~[aisle ramp runs]~~ ramped aisles to permit crossovers within the aisles.

~~[1028.13.1]~~ **1029.15.1 Discontinuous handrails.** Where there is seating on both sides of the aisle, the mid-aisle handrails shall be discontinuous with gaps or breaks at intervals not exceeding five rows to facilitate access to seating and to permit crossing from one side of the aisle to the other. These gaps or breaks shall have a clear width of ~~[at least]~~ not less than 22 inches (~~[559]~~ 558.8 mm) and not greater than 36 inches (~~[914]~~ 914.4 mm), measured horizontally, and the mid-aisle handrail shall have rounded terminations or bends.

1029.15.2 Handrail termination. Handrails located on the side of stepped aisles shall return to a wall, guard or the walking surface or shall be continuous to the handrail of an adjacent stepped aisle flight.

1029.15.3 Mid-aisle termination. Mid-aisle handrails shall not extend beyond the lowest riser and shall terminate within 18 inches (457.2 mm), measured horizontally, from the lowest riser. Handrail extensions are not required.

Exception: Mid-aisle handrails shall be permitted to extend beyond the lowest riser where the handrail extensions do not obstruct the width of the cross aisle.

~~[1028.13.2 Intermediate handrails.]~~ **1029.15.4 Rails.** Where mid-aisle handrails are provided in ~~[the middle of aisle stairs]~~ stepped aisles, there shall be an additional ~~[intermediate handrail]~~ rail located approximately 12 inches (~~[305]~~ 304.8 mm) below the ~~[main]~~ handrail. The rail shall be adequate in strength and attachment in accordance with Section 1607.8.1.2.

~~[1028.14]~~ **1029.16 Assembly guards.** ~~[Assembly guards shall comply with Sections 1028.14.1 through 1028.14.4.]~~ Guards adjacent to seating in a building, room or space used for assembly purposes shall be provided where required by Section 1015 of this code and shall be constructed in accordance with Section 1015 except where provided in accordance with Sections 1029.16.1 through 1029.16.5 of this code. At bleachers, grandstands and folding and telescopic seating, guards must be provided where required by ICC 300 and Section 1029.16.1 of this code.

1029.16.1 Perimeter guards. Perimeter guards shall be provided where the footboards or walking surface of seating facilities are more than 30 inches (762 mm) above the floor or grade below. Where the seatboards are adjacent to the perimeter, guard height shall be 42 inches (1066.8 mm) high minimum, measured from the seatboard. Where the seats are self-rising, guard height shall be 42 inches (1066.8 mm) high minimum, measured from the floor surface. Where there is an aisle between the seating and the perimeter, the guard height shall be measured in accordance with Section 1015.2.

Exceptions:

1. Guards that impact sightlines shall be permitted to comply with Section 1029.16.3.
2. Bleachers, grandstands and folding and telescopic seating shall not be required to have perimeter guards where the seating is located adjacent to a wall and the space between the wall and the seating is less than 4 inches (101.6 mm).

~~[1028.14.1]~~ **1029.16.2 Cross aisles.** Cross aisles located more than 30 inches (762 mm) above the floor or grade below shall have guards in accordance with Section ~~[1013]~~ 1015.

Where an elevation change of 30 inches (762 mm) or less occurs between a cross aisle and the adjacent floor or grade below, guards not less than 26 inches (~~[660]~~ 660.4 mm) above the aisle floor shall be provided.

Exception: Where the backs of seats on the front of the cross aisle project 24 inches (~~[610]~~ 609.6 mm) or more above the adjacent floor of the aisle, a guard need not be provided.

~~[1028.14.2]~~ **1029.16.3 Sightline-constrained guard heights.** Unless subject to the requirements of Section ~~[1028.14.3]~~ 1029.16.4, a fascia or railing system in accordance with the guard requirements of Section ~~[1013]~~ 1015 and having a minimum height of 26 inches (~~[660]~~ 660.4 mm) shall be provided where the floor or footboard elevation is more than 30 inches (762 mm) above the floor or grade below and the fascia or railing would otherwise interfere with the sightlines of immediately adjacent seating. ~~[At bleachers, a guard must be provided where required by ICC 300.]~~

~~[1028.14.3]~~ **1029.16.4 Guards at the end of aisles.** A fascia or railing system complying with the guard requirements of Section ~~[1013]~~ 1015 shall be provided for the full width of the aisle where the foot of the aisle is more than 30 inches (762 mm) above the floor or grade below. The fascia or railing shall be a minimum of 36 inches (~~[914]~~ 914.4 mm) high and shall provide a minimum 42 inches (~~[1067]~~ 1066.8 mm) measured diagonally between the top of the rail and the nosing of the nearest tread.

~~[1028.14.4]~~ **1029.16.5 Toe guard at balconies.** An unperforated curb or toe guard at least 12 inches (~~[305]~~ 304.8 mm) high above the level of the floor shall be provided at the fascia of all balconies.

~~[1028.15]~~ **1029.17 Bench seating.** Where bench seating is used, the number of persons shall be based on one person for each 18 inches (~~[457]~~ 457.2 mm) of length of the bench.

~~[1028.16 Standee areas]~~ **1029.18 Standing spaces.** ~~[Standee areas]~~ Standing spaces may be permitted within assembly spaces ~~[provide]~~ provided each standee has a minimum of 5 square feet (0.47 m²) of occupiable floor space [width of 22 inches (559 mm) and a minimum depth of 21 inches (533 mm)]. ~~[Standee areas]~~ Standing spaces shall not encroach on the required exit facilities and shall be separated from the space to be left clear for passage ~~[by tape, ribbon or other easily broken material, supported by lightweight posts fixed in stationary sockets]~~.

~~[1028.17]~~ **1029.19 Places of assembly with an occupant load of less than 12 square feet per person.** Places of assembly in which the net floor area, exclusive of stage area, is less than 12 square feet (1.11 m²) per person shall have special egress provisions in accordance with this section.

~~[1028.17.1]~~ **1029.19.1 Classification of exit [openings] access doorways and exits.** For the purposes of Section ~~[1028.17]~~ 1029.19, exit [openings] access doorways and exits shall be classified as follows:

1. Class 1—Exit [openings] access doorways and exits that are used for normal entry to the assembly space, and that open directly to a safe area or to an open exterior space.
2. Class 2—Exit [openings] access doorways and exits that are not used for normal entry to the assembly space, and that open directly to a safe area or to an open exterior space.
3. Class 3—Exit [openings] access doorways and exits that open from the assembly space into corridors, exit passageways or vertical exits.

~~[1028.17.2]~~ **1029.19.2 Distribution of classes.** The required exit capacity from assembly spaces in which the net floor area, exclusive of stage area, is less than 12 square feet (1.11 m²) per person shall be distributed so that exit [openings] access doorways and exits of each class are provided to comply with the following requirements:

1. For assembly spaces in which the mean floor level is not more than 15 feet (4572 mm) above or below the adjoining grade elevation, the exit capacity shall be distributed as follows:
 - 1.1. Class 1—not less than 40 percent.
 - 1.2. Class 2—not more than 60 percent.
 - 1.3. Class 3—not more than 40 percent.
2. For assembly spaces in which the mean floor level is more than 15 feet (4572 mm) above or below the adjoining grade elevation, the exit capacity shall be distributed as follows:
 - 2.1. Class 1—not less than 60 percent.
 - 2.2. Class 3—not more than 40 percent.

~~[1028.17.3]~~ **1029.19.3 Safe areas.** The capacity of exits from safe areas shall be provided for all occupants of the safe area. Safe areas shall comply with the following requirements:

1. When provided to serve Class 1 or 2 exit ~~[openings]~~ access doorways, safe areas shall be separated from assembly spaces by fire barriers constructed in accordance with Section 707 or horizontal assemblies constructed in accordance with Section ~~[712]~~ 711, or both, each having a 2-hour fire-resistance rating. Such safe areas shall serve as transition areas in the line and direction of exit travel. They shall serve for normal entry to the assembly space and may be used as corridors, lobbies or lounges.
2. No room or space classified in Occupancy Group H, S-1, F-1 or F-2 shall open upon a safe area.
3. Safe areas shall be at a level not more than 6 feet (~~[1829]~~ 1828.8 mm) above or below the level at which egress is made from the assembly space.
4. Ventilating systems for safe areas shall not be connected to systems serving any other spaces, unless separated from such systems by fire/smoke dampers actuated by smoke detectors.
5. Collecting safe areas. Places of assembly having more than one assembly space may have a collecting safe area that receives the occupant load discharged into it by other safe areas. Collecting safe areas shall be located within 6 feet (~~[1829]~~ 1828.8 mm) above or below the assembly space nearest to grade.
6. Occupant load. The occupant load of a safe area shall be the aggregate occupant load of all exit ~~[openings]~~ access doorways discharging directly into it. The occupant load of a collecting safe area shall be the aggregate occupant load of all exit ~~[openings]~~ access doorways discharging directly into it, plus 50 percent of the occupant load of other safe areas discharging into it.
7. Dimensions. The clear unobstructed floor area of each safe area shall be sufficient to accommodate the total occupant load of the safe area on the basis of 3 square feet (0.28 m²) per person, not including space occupied by furniture or equipment. The minimum dimension of such unobstructed space shall be 8 feet (~~[2438]~~ 2438.4 mm). The width of the unobstructed space shall be measured at right angles to the direction of travel to an exit and shall not be less than required for the occupant load. The height of safe areas shall be at least 8 feet (~~[2438]~~ 2438.4 mm) at all points.
8. Safe areas near grade. When a safe area provides egress to an open exterior space, either directly or through a vestibule, the safe area need not provide the floor area required by this section when the level of discharge from the safe area to the open exterior space is not more than 4 feet (~~[1219]~~ 1220 mm) above or below the grade of the open exterior space.

[1028.17.3.1] 1029.19.3.1 Unenclosed ~~[vertical-exits]~~ exit access stairways and ramps. ~~[Vertical-exits]~~ Where permitted by Section 1019, exit access stairways or ramps leading directly from one safe area to another, or leading from a safe area directly to an open exterior space, need not be enclosed. Travel distance on such unenclosed exit access stairway or ramp shall be in accordance with the primary travel distance in Table 1029.7, and shall be measured in accordance with Section 1017.3.1.

~~[1028.17.3.2]~~ **1029.19.3.2 Safe area lighting.** In addition to requirements of Section ~~[1006]~~ 1008, safe areas shall be artificially lighted by electrical means at all times during occupancy of a place of assembly so as to provide illumination of at least 5 ~~[foot-candles]~~ footcandles (54 lux) at the level of the floor and on the surface of all stairs, steps, ramps, and escalators within the safe area.

~~[1028.17.4]~~ **1029.19.4 Open exterior space.** The following provisions shall apply when an open exterior space is used as an exit discharge:

1. **Capacity.** Open exterior spaces shall be adequate in width and area to accommodate the accumulated occupant load of all exits discharging into them on the basis of 2 square feet (0.19 m²) per person.
2. **Minimum dimensions.** The minimum dimension of open exterior spaces shall be 20 feet (6096 mm), except that when the principal entrance to the place of assembly is from an open exterior space, the minimum dimension of this space shall be 30 feet (9144 mm). No open exterior space shall have less than 400 square feet (~~[37]~~ 37.2 m²) of floor area, and floor area shall be measured exclusive of the following:
 - 2.1. The area immediately outside any exit door from the place of assembly for a distance perpendicular to the exit doors of 10 feet (3048 mm) for the full width of the exit opening.
 - 2.2. The area of steps, platforms, stairs, or ramps within or leading to or from the space.
 - 2.3. The area of obstructions such as shrubs, trees, fixed furniture, signs, sculptures, pools, and similar obstructions to occupancy or exit travel.
3. **Above or below grade.** When an open exterior space is more than 15 feet (4572 mm) above or below the grade of the street or public space to which it discharges, its required area shall be increased by one-third.
4. **Egress from open exterior spaces.** Exterior exit passageways, ramps, or steps leading from open exterior spaces shall be not less in width than required for the occupant load of all exits discharging into the open exterior space. The width of such exit passageways shall be based on the capacities listed in Section ~~[1005.1]~~ 1005.1, but in no case less than 10 feet (3048 mm).
5. **Open exterior spaces.** Yards or courts ~~[which]~~ that serve as open exterior spaces shall be artificially lighted by electrical means at all times between sunset and sunrise during occupancy of a place of assembly so as to provide illumination of at least 5 ~~[foot-candles]~~ footcandles (54 lux) at the level of the floor over at least the required area.

SECTION BC ~~[1029]~~ 1030 **EMERGENCY ESCAPE AND RESCUE**

~~[1029.1]~~ **1030.1 General.** In addition to the means of egress required by this chapter, provisions shall be made for emergency escape and rescue openings in Group ~~[R and Group I-1]~~ R-2 occupancies that

are subject to Table 1006.3.2, and Group R-3 occupancies. Sleeping rooms below the fourth story above grade plane and below-grade stories shall have at least one exterior emergency escape and rescue opening in accordance with this section. Where below-grade stories contain one or more sleeping rooms, emergency escape and rescue openings shall be required in each sleeping room, but shall not be required in adjoining areas of such below-grade story. Such ~~[opening]~~ openings shall open directly into a public way or to a yard or court that opens to a public way.

Exceptions:

1. ~~[Buildings equipped throughout with an approved automatic sprinkler system in accordance with Section 903.3.1 or 903.3.1.2.]~~
- ~~[2.]~~ Sleeping rooms provided with a door to a fire-resistance-rated corridor having access to two remote exits in opposite directions.
- ~~[3. The emergency escape and rescue opening is permitted to open onto a balcony within an atrium in accordance with the requirements of Section 404, provided the balcony provides access to an exit and the dwelling unit or sleeping unit has a means of egress that is not open to the atrium.]~~
- ~~[4. High-rise buildings in accordance with Section 403.]~~
- ~~[5.]~~ 2. Emergency escape and rescue openings are not required from below-grade stories or sleeping rooms that have an exit door or exit access door that opens directly into a public way or to a yard, court or exterior exit balcony that opens to a public way.
- ~~[6.]~~ 3. Below-grade stories without habitable spaces and having ~~[no]~~ not more than 200 square feet (18.6 m²) in floor area shall not be required to have emergency escape ~~[windows]~~ and rescue openings.

~~[1029.2]~~ **1030.2 Minimum size.** Emergency escape and rescue openings shall have a minimum net clear opening of 6 square feet (0.56 m²).

Exception: The minimum net clear opening for grade-floor emergency escape and rescue ~~[grade-floor]~~ openings shall be 5 square feet (0.46 m²) unless such opening is required for natural ventilation in accordance with Chapter 12.

~~[1029.2.1]~~ **1030.2.1 Minimum dimensions.** The minimum net clear opening height dimension shall ~~[not]~~ be ~~[less than]~~ 30 inches (762 mm). The net clear opening width dimension shall not be less than 24 inches (~~[610]~~ 609.6 mm). The final dimensions shall result in a net clear opening area as required above. The net clear opening dimensions shall be the result of normal operation of the opening.

~~[1029.3]~~ **1030.3 Maximum height from floor.** Emergency escape and rescue openings shall have the bottom of the clear opening not greater than 36 inches (~~[914]~~ 914.4 mm) measured from the floor.

~~[1029.4]~~ **1030.4 Operational constraints.** Emergency escape and rescue openings shall be operational from the inside of the room without the use of keys or tools in accordance with the provisions of Chapter 10 of the *New York City Fire Code*.

[1029.5] 1030.5 Window wells. An emergency escape and rescue opening with a finished sill height below the adjacent ground level shall be provided with a window well in accordance with Sections [1029.5.1] 1030.5.1 and [1029.5.2] 1030.5.2.

[1029.5.1] 1030.5.1 Minimum size. The minimum horizontal area of the window well shall be 9 square feet (0.84 m²), with a minimum dimension of 36 inches ([914] 914.4 mm). The area of the window well shall allow the emergency escape and rescue opening to be fully opened.

[1029.5.2] 1030.5.2 Ladders or steps. Window wells with a vertical depth of more than 44 inches ([1118] 1117.6 mm) shall be equipped with an approved permanently affixed ladder or steps. Ladders or rungs shall have an inside width of at least 12 inches ([305] 304.8 mm), shall project at least 3 inches ([76] 76.2 mm) from the wall and shall be spaced not more than 18 inches ([457] 457.2 mm) on center (o.c.) vertically for the full height of the window well. The ladder or steps shall not encroach into the required dimensions of the window well by more than 6 inches ([152] 152.4 mm). The ladder or steps shall not be obstructed by the emergency escape and rescue opening. Ladders or steps required by this section are exempt from the stairway requirements of Section [1009] 1011.

SECTION BC [1030] 1031 SIGNAGE

[1030.1] 1031.1 Signage. Signage shall be provided in accordance with this section and the rules of the department.

[1030.2] 1031.2 Exit signs. Exits signs shall be provided in accordance with Section [1011] 1013.

[1030.3] 1031.3 Stairway and elevator identification signs. Stairway floor number and stairway identification signs shall be provided in accordance with Section [1022.8] 1023.9. Elevator identification and emergency signs shall be provided in accordance with Section 3002.3.

[1030.4] 1031.4 Door signs. For the following buildings, signs shall be posted and maintained on exit stair doors in accordance with this section:

1. Buildings or portions thereof occupied by Group B or arranged to be occupied by more than 100 persons above or below the street level or more than 500 persons in the entire building.
2. High-rise buildings subject to Section 403.
3. Buildings where any stair side door is locked pursuant to Section [1008.1.9.10] 1010.1.9.11.

Exception: Signs shall not be required on exit stair doors opening directly to dwelling or sleeping units in occupancy Group R where permitted by Section [1014.4] 1016.3.

[1030.4.1] 1031.4.1 Occupied side. Where reentry is not provided from a stair to every floor, a sign that reads, "NO REENTRY FROM THIS STAIR" shall be posted on the occupied side of the stair door at every floor.

[1030.4.2] 1031.4.2 Stair side. On the stair side, signs shall be posted and maintained at all stair doors at every floor. Such signs shall be either:

1. **Reentry.** Where reentry is provided, a sign shall read, "REENTRY ON THIS FLOOR."
2. **No Reentry.** Where reentry is not provided on that floor, the sign shall read:
 - 2.1. "NO REENTRY"; where reentry is not provided on any floor;
 - 2.2. "NO REENTRY, NEAREST REENTRY ON THE AND FLOORS"; where reentry is provided on other floors; and
 - 2.3. "NO REENTRY. REENTRY IS PROVIDED ONLY DURING FIRE EMERGENCIES. NEAREST TELEPHONE ON THE AND FLOORS"; where stair side doors are locked in accordance with Section 403.5.3.

[1030.4.3] 1031.4.3 Graphics. The lettering and numerals of the signs shall be at least 1/2 inch (12.7 mm) high of bold type. The lettering and background shall be contrasting colors and the signs shall be securely attached approximately 5 feet (1524 mm) above the floor. The signs may be either independent or combined with floor and stairway identification signs.

[1030.5] 1031.5 Wall signs, stair side. In high-rise buildings subject to Section 403, signs shall be posted and maintained on the wall as follows:

1. **Reentry.** Where a reentry door is recessed, a supplementary sign complying with Section ~~[1030.4.3]~~ 1031.4.3, except that the lettering and numerals shall be at least 1 inch (~~[25]~~ 25.4 mm) high, shall be securely attached on the wall of the landing and shall be readily visible to the evacuee on the stairs indicating the location of such recessed reentry door.
2. **No reentry.** Where there is no reentry from the stair, an additional sign complying with ~~[Subdivision 2 of Sections 1030.4.2]~~ Item 2 of Section 1031.4.2, and ~~[1030.4.3]~~ Section 1031.4.3, except that the lettering and numerals shall be at least 1 inch (~~[25]~~ 25.4 mm) high, shall be securely attached at the beginning of the descent into such portion of the stair on the wall of the landing and shall be readily visible to the evacuee on the stairs.

[1030.6] 1031.6 Accessible means of egress signs. Accessible means of egress shall be provided with signs in accordance with Section ~~[1007.9]~~ 1009.9.

[1030.7] 1031.7 Capacity sign. Occupant load signs shall be provided in accordance with Section ~~[1004.3]~~ 1029.1.3.

[1030.8] 1031.8 Access-controlled doors. Access-controlled doors shall be provided with signs in accordance with Section ~~[1008.1.4.4]~~ 1010.1.9.8.

[1030.9] 1031.9 Delayed egress locks. Doors equipped with delayed egress shall be provided with signs in accordance with ~~[Sections]~~ Section [1008.1.9.7] 1010.1.9.7.

[1030.10] 1031.10 Signs in sleeping rooms. A sign shall be posted on the inside of every door opening onto a corridor giving access to a sleeping room in all Group R-1 occupancies. The sign shall contain a diagram showing the location where it is posted and the location and letter identification of the exit stairs on the floor. The diagram shall indicate the number of doors opening onto the public corridor which must be passed to reach each exit stair. The sign shall be at least 8

inches by 10 inches (~~[203]~~ 203.2 mm by 254 mm), located on the inside of the door and securely attached. The top of such sign shall not be more than 6 feet (~~[1829]~~ 1828.8 mm) from the floor level. Such sign shall contain such additional information as the Fire Department may require.

~~[1030.11]~~ **1031.11 Luminous egress path markings.** Luminous egress path markings in high-rise buildings subject to Section 403.5.5 shall be provided in accordance with Section ~~[1024]~~ 1025 and Appendix S.

~~[1030.12]~~ **1031.12 Materials for signs.** Signs required by this section shall be of metal or other durable material.

§ 12. Chapter 11 of the New York city building code, as amended by local law number 141 for the year 2013, item 3 of section 1109.2, as added by local law number 51 for the year 2014, section 1109.2.4 as amended by local law number 34 for the year 2018, item 4 of section 1110.2 as amended by local law number 79 for the year 2016 and item 7 of section 1110.3 as amended by local law number 122 for the year 2019, is amended to read as follows:

CHAPTER 11 ACCESSIBILITY

SECTION BC 1101 GENERAL

1101.1 Scope. The provisions of this chapter and Appendices E~~[,]~~ and N ~~[and P]~~ shall control the design and construction of facilities for accessibility ~~[to persons]~~ for individuals with ~~[physical]~~ disabilities.

1101.2 Design. Buildings and facilities shall be designed and constructed to be accessible in accordance with ~~[this code and]~~ ICC A117.1 and this code.

1101.3 Special provisions for prior code buildings. The provisions of this chapter shall apply to alterations, including minor alterations but excluding ordinary repairs, and changes of use or occupancy to prior code buildings, portions of such buildings, and spaces within such buildings in accordance with ~~[Section]~~ Sections 1101.3.1 through 1101.3.5. Alterations within prior code buildings affecting an area containing a primary function shall comply with the requirements of Section 1101.4. This section shall not impose a requirement for greater accessibility than that which would be required for new construction, nor shall it reduce or have the effect of reducing accessibility.

Exception: The provisions of this chapter are not applicable to:

1. ~~[Ordinary repairs.]~~

~~[2-]~~ Group R-3 occupancies in buildings with first occupancy on or before March 13, 1991.

~~[3.]~~ 2. Group R-3 occupancies in buildings with first occupancy after March 13, 1991, and originally constructed in a single structure with fewer than ~~[4]~~ four dwelling or sleeping units.

1101.3.1 Requirements based on change of occupancy or how a space is used. Accessible features and construction governed by this chapter shall be provided:

1. To the entire building, as if the building were hereafter erected, where a change is made in the main use or dominant occupancy of such building.
2. Throughout a space, including the immediate entrance(s) thereto, where an alteration is made that is considered either: (i) a change in occupancy classification of such space in accordance with this code, or (ii) a change in the zoning use group of such space in accordance with the *New York City Zoning Resolution*.

~~[2.2. Entrances within 18 inches (457.2 mm) of the sidewalk.]~~

2.1. Where the ~~[floor elevation of a space is within 18 inches (457.2 mm) of the sidewalk, and the]~~ immediate entrance(s) to such space provides direct access to the sidewalk, such immediate entrance(s) shall be provided with an accessible route to the sidewalk. Where the immediate entrance(s) to such space are only through an adjacent space, such as a building lobby, such space shall be provided with an accessible route, through the adjacent space, to the sidewalk.

2.2. Where elevator service is provided in the building, an accessible route shall be required to a rooftop, where prior to a change in use or occupancy, such rooftop was not intended for general public or occupant use.

~~[3. To provide an accessible route to a space, including rooftops, where prior to a change in use of occupancy or in how such space is used, this chapter would not have required an accessible route for new construction.]~~

1101.3.2 Requirements based on value of alterations. Accessible features and construction governed by this chapter shall be provided:

1. To the entire building undergoing alterations, as if the building were hereafter erected, where the value of alterations exceeds 50 percent of the value of the existing building.
2. To the portion of the building being altered, to the extent of the alteration, including minor alterations but excluding ordinary repairs, where the value of the alteration does not exceed 50 percent of the value of the existing building.
 - 2.1. Within buildings with first occupancies on or before March 13, 1991, bathrooms and powder rooms located in dwelling units in such portion being altered shall comply with this chapter or ~~[be permitted to comply]~~ with prototype layouts established by rule.

1101.3.3 Directional accessibility signage. Directional signage shall be provided in accordance with Section ~~[1110.2]~~ 1111.2 at or in close proximity to inaccessible building entrances,

inaccessible public toilets and bathing facilities, and elevators not serving an accessible route, indicating the route to the nearest like accessible element where such accessible element is provided, such that ~~[a person]~~ an individual with disabilities will not be required to retrace the approach route from the inaccessible element.

1101.3.4 Identifying accessibility signage. Identifying accessibility signage shall be provided in accordance with Item [7] 5 of Section [~~1110.1~~] 1111.1 at accessible building entrances where not all entrances are accessible.

1101.3.5 Waiver of requirements. The commissioner may waive the requirements of this chapter for the alteration of ~~[existing]~~ prior code buildings, provided ~~[-however,]~~ that such waiver would not significantly adversely affect provisions for health, safety and security and that equally safe and proper alternatives are prescribed and, ~~[further,]~~ that such waiver is based upon a specific finding that strict compliance with the requirement:

1. Would create an undue economic burden;
2. Would not achieve its intended objective;
3. Would be physically or legally impossible;
4. Would be unnecessary in light of alternatives which ensure the achievement of the intended objective or which, without a loss in the level of safety, achieve the intended objective more efficiently, effectively or economically; or
5. Would entail a change so slight as to produce a negligible additional benefit consonant with the purposes of this chapter.

1101.3.5.1 Application process. Each application for a waiver shall be made to the commissioner in writing, setting forth each requirement sought to be waived and the specific reason or reasons therefore. The commissioner shall determine, under all of the circumstances presented by such application, which of such requirements may appropriately be waived. The commissioner shall render such determination in [a] writing, which shall set forth in detail, the commissioner's findings and conclusions with respect to each requirement sought to be waived. A copy of such written determination shall be forwarded to the applicant. Such written determination shall be filed with the department and shall be available for public inspection.

1101.3.5.2 Waiver recommendation. The Mayor's Office for People with Disabilities or its successor agency shall be consulted by and shall advise the commissioner concerning each application for a waiver under Section 1101.3.5.

1101.4 Alterations affecting an area containing a primary function. Where an alteration affects the accessibility to, or contains an area of primary function, the route to the primary function area shall be accessible. The costs of providing the accessible route are not required to exceed 20 percent of the value of the alterations affecting the area of primary function. The accessible route to the primary function area shall include toilet facilities and drinking fountains serving the area of primary function.

Exceptions:

1. This provision does not apply to alterations limited solely to windows, hardware, operating controls, electrical outlets and signs.
2. This provision does not apply to alterations limited solely to mechanical systems, electrical systems, installation or alteration of fire protection systems and abatement of hazardous materials.
3. This provision does not apply to alterations undertaken for the primary purpose of increasing the accessibility of a facility.
4. This provision does not apply to altered areas limited within a Type B or Type B+NYC dwelling unit.

SECTION BC 1102 DEFINITIONS

1102.1 Definitions. The following [~~words and~~] terms [~~shall, for the purposes of this chapter, applicable appendices and as used elsewhere in this code, have the meanings shown herein~~] are defined in Chapter 2:

ACCESSIBLE. [~~A site, building, facility or portion thereof that complies with this chapter.~~]

ACCESSIBLE UNIT. [~~A dwelling unit or sleeping unit that complies with this code and the provisions for Accessible units in ICC A117.1.~~]

AREA OF SPORT ACTIVITY.

CIRCULATION PATH. [~~An exterior or interior way of passage from one place to another for pedestrian travel.~~]

COMMON USE. [~~Interior or exterior circulation paths, rooms, spaces or elements that are made available for the shared use of two or more people but are not for public use.~~]

DETECTABLE WARNING. [~~A standardized surface feature built in or applied to walking surfaces or other elements to warn visually impaired persons of hazards on a circulation path.~~]

DWELLING UNIT (ACCESSIBILITY). [~~For the purposes of Chapter 11 and applicable appendices: A single unit providing complete, independent living facilities for one or more persons, including permanent provisions for living, sleeping, eating, cooking and sanitation.~~]

DWELLING UNIT OR SLEEPING UNIT, MULTI[-] STORY. [See “Multistory unit.”]

DWELLING UNIT OR SLEEPING UNIT, TYPE B. [See “Type B unit.”]

EMPLOYEE WORK AREA. [~~All or any portion of a space used only by employees and only for work. Corridors, toilet rooms, kitchenettes and break rooms are not employee work areas.~~]

FACILITY. [~~All or any portion of buildings, structure, site improvements, elements and pedestrian or vehicular routes located on a site.~~]

HALL CALL CONSOLE.

INTENDED TO BE OCCUPIED AS A RESIDENCE. [~~This refers to a dwelling unit or sleeping unit that can or will be used all or part of the time as the occupant’s place of abode.~~]

MULTILEVEL ASSEMBLY SEATING. [~~Seating that is arranged in distinct levels where each level is comprised of either multiple rows, or single row of box seats accessed from a separate level.~~]

MULTISTORY UNIT. [~~A dwelling unit or sleeping unit with habitable space located on more than one story.~~]

PRIMARY FUNCTION AREAS.

PUBLIC ENTRANCE.~~[An entrance that is not a service entrance.]~~

PUBLIC-USE AREAS.~~[Interior or exterior rooms or spaces that are made available to the general public.]~~

RESTRICTED ENTRANCE. ~~[An entrance that is made available for public use but on a controlled basis, and that is not a service entrance.]~~

SELF-SERVICE STORAGE FACILITY. ~~[Real property designed and used for the purpose of renting or leasing individual storage spaces to customers for the purpose of storing and removing personal property on a self-service basis.]~~

~~[SERVICES. Includes but is not limited to toilet rooms, drinking fountains, public telephones and food.]~~

SERVICE ENTRANCE. ~~[An entrance solely for delivery of goods or services.]~~

SERVICES.

SITE. ~~[A parcel of land bounded by a lot line or a designated portion of a public right-of-way.]~~

SLEEPING UNIT (ACCESSIBILITY). ~~[For the purposes of Chapter 11 and applicable appendices: A room or space in which people sleep, which can also include permanent provisions for living, eating, and either sanitation or kitchen facilities but not both. Such rooms and spaces that are also part of a dwelling unit are not sleeping units.]~~

TYPE B UNIT. ~~[A dwelling unit or sleeping unit designed and constructed for accessibility in accordance with this code and the provisions for Type B units in ICC A117.1, consistent with the design and construction requirements of the federal Fair Housing Act.]~~

TYPE B+NYC UNIT. ~~[A dwelling unit or sleeping unit designed and constructed for accessibility in accordance with this code, Section 1004 (Type B Units) of ICC A117.1 as modified by Sections 1107.2.1 through 1107.2.8, and Appendix P of this code.]~~

~~[VALUE (OF EXISTING BUILDING OR SPACE).]~~

VALUE (OF ALTERATIONS, TO DETERMINE REQUIRED ACCESSIBILITY). ~~[The value of alterations shall be determined by adding the estimated cost of the proposed alteration, including minor alterations but excluding ordinary repairs, computed as of the time of submitting the application for construction document approval, or, where no permit is required, computed at the time of the work, to the actual cost of any and all alterations and minor alterations made in the preceding 12-month period. Where the alteration includes an enlargement, the value of the alteration shall include the cost of the enlargement.]~~

VALUE (OF EXISTING BUILDING OR SPACE).

WHEELCHAIR SPACE.~~[A space for a single wheelchair and its occupant.]~~

SECTION BC 1103 SCOPING REQUIREMENTS

1103.1 Where required. Sites, buildings, structures, facilities, elements and spaces, temporary or permanent, shall be accessible to ~~[persons]~~ individuals with ~~[physical]~~ disabilities.

1103.2 General exceptions. Sites, buildings, structures, facilities, elements and spaces shall be exempt from this chapter to the extent specified in this section.

1103.2.1 Specific requirements. Accessibility is not required in buildings and facilities, or portions thereof, to the extent permitted by Sections 1104 through ~~[440]~~ 1111.

1103.2.2 ~~[Prior code buildings.~~ ~~Prior code buildings shall comply with Section 1101.3.3.]~~

~~[1103.2.3 Employee work areas. All or any portion of a space used exclusively by employees and only for work shall be required to comply only with Section 1103.2.3. However, common use circulation paths, located within employee work areas shall also comply with Section 1104.3.1.]~~

~~[1103.2.3.1 Employee work areas ~~[and work stations]~~.~~ Spaces and elements within employee work areas shall only be required to comply with Sections ~~[907.5.2.3.2]~~ 907.5.2.3.1, ~~[4007]~~ 1009 and 1104.3.1, and shall be designed and constructed so that individuals with disabilities can approach, enter and exit the work area. In addition, at least one ~~[and]~~ but not less than five percent of fixed seating, tables, desks, and/or work ~~[stations]~~ surfaces, if provided, within employee work areas shall be located on an accessible route and comply with ~~[applicable sections]~~ Section 902 (Dining Surfaces and Work Surfaces) of ICC A117.1. Work areas, or portions of work areas, other than raised courtroom stations in accordance with Section 1108.4.1.4, that are less than 300 square feet (27.8 m²) in area and located 7 inches (177.8 mm) or more above or below the ground or finished floor where the change in elevation is critical to the work operation shall be exempt from all requirements.

~~[1103.2.3.2 Elevated employee work areas. Where the elevation is critical to the proper work operations, work areas or portions of work areas, other than raised courtroom stations, that are less than 300 square feet (30 m²) in area and elevated 7 inches (178 mm) or more above the ground or finish floor shall be exempt from all requirements.]~~

~~[1103.2.4] 1103.2.3 Detached dwellings.~~ Detached ~~[one]~~ one- and two-family dwellings ~~[and]~~, their accessory structures and their associated sites and facilities are not required to ~~[be accessible]~~ comply with this chapter.

~~[1103.2.5] 1103.2.4 Utility buildings.~~ ~~[Occupancies in]~~ Group U ~~[are exempt from the requirements of]~~ occupancies are not required to comply with this chapter other than the following:

1. In agricultural buildings and livestock shelters, access is required to paved work areas and areas open to the general public.
2. Green houses and stables open to the public.

3. Private garages or carports that contain required accessible parking.

~~[1103.2.6]~~ **1103.2.5 Construction sites.** Structures, sites and equipment directly associated with the actual processes of construction including, but not limited to, scaffolding, bridging, materials hoists, materials storage or construction trailers are not required to ~~[be accessible]~~ comply with this chapter.

~~[1103.2.7]~~ **1103.2.6 Raised areas.** Raised areas used for purposes of security, life safety or fire safety including, but not limited to, observation galleries, prison guard towers, fire towers or lifeguard stands are not required to ~~[be accessible or to be on an accessible route]~~ comply with this chapter.

~~[1103.2.8]~~ **1103.2.7 Limited access spaces.**~~[Nonoccupiable spaces]~~ Spaces accessed only by ladders, catwalks, crawl spaces, freight elevators that are not part of an accessible route, or very narrow passageways are not required to ~~[be accessible]~~ comply with this chapter.

1103.2.8 Reserved.

1103.2.9 Equipment spaces. Spaces frequented only by service personnel for maintenance, repair or occasional monitoring of equipment are not required to ~~[be accessible]~~ comply with this chapter. Such spaces include, but are not limited to, elevator pits, elevator penthouses, mechanical, electrical or communications equipment rooms, piping or equipment catwalks, water or sewerage treatment pump rooms and stations, electrical substations and transformer vaults, and highway and tunnel utility facilities.

~~1103.2.10 [Nongrade single-occupant structures. Single-occupant structures that are accessed only by passageways below grade or above grade including, but not limited to, toll booths that are accessed only by bridges or underground tunnels, are not required to be accessible.]~~
Reserved.

1103.2.11 Reserved.

1103.2.12 Reserved.

1103.2.13 [Reserved.]

~~[1103.2.14]~~ **Detention and correctional facilities.** In detention and correctional facilities, common use areas that are used only by inmates or detainees and security personnel, and that do not serve holding cells or housing cells required to be ~~[accessible pursuant to Section 1107.5.5]~~ Accessible units, are not required to ~~[be accessible or to be on an accessible route]~~ comply with this chapter.

~~[1103.2.15]~~ **1103.2.14 Walk-in coolers and freezers.** Walk-in coolers and freezers intended for employee use only are not required to ~~[be accessible]~~ comply with this chapter.

SECTION BC 1104 ACCESSIBLE ROUTE

1104.1 Site arrival points. ~~[Accessible routes]~~ At least one accessible route within the site shall be provided from public transportation stops, accessible parking, accessible passenger loading zones, and public streets or sidewalks to the accessible building entrance served.

1104.2 Within a site. At least one accessible route shall connect accessible buildings, accessible facilities, accessible elements and accessible spaces that are on the same site and shall comply with Section 1104.5.

Exceptions:

1. An accessible route is not required between accessible buildings, accessible facilities, accessible elements and accessible spaces that have, as the only means of access between them, a vehicular way not providing for pedestrian access.
2. An accessible route to recreational facilities shall only be required to the extent specified in Section 1110.

1104.3 Connected spaces. When a building[;] or portion of a building[;] is required to be accessible, ~~[an]~~ at least one accessible route shall be provided to each portion of the building, to accessible building entrances connecting accessible pedestrian walkways and to the public way.

Exceptions:

1. Stories and mezzanines exempted by Section 1104.4.
2. In a building, room or space used for assembly [areas] purposes with fixed seating, an accessible route shall not be required to serve levels where wheelchair spaces are not provided as permitted by other sections of this chapter.
- ~~[2. Accessible routes shall not be required where multiple levels are not required to be connected by an accessible route as permitted by Section 1104.4.]~~
3. [In Group I-2 facilities, doors to sleeping units shall be exempted from the requirements for maneuvering clearance at the room side provided the door is a minimum of 44 inches (1118 mm) in width.] Vertical access to elevated employee work stations within a courtroom complying with Section 1108.4.1.4.
4. An accessible route to recreational facilities shall only be required to the extent specified in Section 1110.

1104.3.1 ~~[Circulation paths within employee]~~ Employee work areas. Common use circulation paths within employee work areas shall be accessible routes.

Exceptions: The following exceptions apply only to the common use circulation paths within an employee work area and are not intended to remove the requirement of Section ~~[1103.2.3]~~ 1103.2.2 that employee work areas be designed and constructed so that individuals with

disabilities can approach, enter and exit the employee work area.

1. Common use circulation paths, located within employee work areas that are less than 300 square feet (27.9 m²) in size [-] and defined by permanently installed partitions, counters, casework or furnishings not serving accessible employee work stations that are required in Section [~~1103.2.3.1~~] 1103.2.2, shall not be required to be accessible routes.
2. Common use circulation paths, located within employee work areas, that are an integral component of equipment, shall not be required to be accessible routes.

1104.3.2 Press boxes. Press boxes in a building, room or space used for assembly [areas] purposes shall be on an accessible route.

Exceptions:

1. An accessible route shall not be required to press boxes in bleachers that have [~~points~~] a single point of entry [at only one level] from the bleachers, provided that the aggregate area of all press boxes for each area of sport activity is not more than 500 square feet (46.5 m²) [maximum].
2. An accessible route shall not be required to free-standing press boxes that are [~~elevated above grade~~] more than 12 feet ([~~3658~~] 3657.6 mm) [minimum] above grade provided that the aggregate area of all press boxes for each area of sport activity is not more than 500 square feet (46.5 m²) [maximum].

1104.4 Multilevel buildings and facilities. At least one accessible route shall connect each accessible level[~~, including mezzanines,~~] and mezzanine in multilevel buildings and facilities.

Exceptions:

1. In [~~non-residential~~] nonresidential buildings, an accessible route is not required to levels and mezzanines above and below accessible levels where the aggregate area of all such levels and mezzanines that are not provided with accessible routes is not more than 2,500 square feet (232.3 m²). This exception shall not apply to:
 - 1.1. Multiple tenant facilities of Group M occupancies containing five or more tenant spaces where all such tenant spaces are located on the accessible levels;
 - 1.2. Levels or mezzanines containing offices of health care providers (Group B or I occupancies);
 - 1.3. Passenger transportation facilities and airports (Group A-3 or B occupancies); or
 - 1.4. Levels frequented by the public for assembly purposes other than levels where wheelchair spaces are not required to be provided as determined in accordance with Section 1108.2.4.[-]
 - 1.5. Levels frequented by the public for government, public utility or health facility

purposes.

2. Levels or mezzanines that do not contain accessible elements or other spaces as ~~[permitted]~~ determined by [Sections] Section 1107 or 1108 are not required to be served by an accessible route from an accessible level.
3. In air traffic control towers, an accessible route is not required to serve the cab and the floor immediately below the cab.
- ~~[3.]~~ 4. Where a two-story building or facility has one story or mezzanine with an occupant load of five or fewer persons that does not contain public use space, that story or mezzanine shall not be required to be connected by an accessible route to the story above or below.
- ~~[4. Vertical access to elevated employee work stations within a courtroom is not required at the time of initial construction, provided a ramp, lift or elevator complying with ICC A117.1 can be installed without requiring reconfiguration or extension of the courtroom or extension of the electrical system.]~~

The exemption of a level from accessible route requirements pursuant to the exceptions set forth in this section shall not be construed to automatically exempt such level from other accessibility provisions of this chapter including but not limited to requirements for accessible doors~~[, toilets and level floors]~~ and toilet rooms. Such other accessibility provisions remain applicable to such level unless specifically exempted by other sections of this code.

1104.5 Location. Accessible routes shall coincide with or be located in the same area as a general circulation path. Where the circulation path is interior, the accessible route shall also be interior. Where only one accessible route is provided, the accessible route shall not pass through kitchens, storage rooms, restrooms, closets or similar spaces.

Exception: A single accessible route is permitted to pass through a kitchen in an Accessible unit, Type B+NYC unit, or Type B unit.

1104.6 Security barriers. Security barriers including, but not limited to, security bollards and security check points shall not obstruct a required accessible route or accessible means of egress.

Exception: Where security barriers incorporate elements that cannot comply with these requirements, such as certain metal detectors, fluoroscopes or other similar devices, the accessible route shall be permitted to be provided adjacent to security screening devices. The accessible route shall permit ~~[persons]~~ individuals with disabilities passing around security barriers to maintain visual contact with their personal items to the same extent provided others passing through the security barrier.

SECTION BC 1105 ACCESSIBLE ENTRANCES

1105.1 Public entrances. In addition to accessible entrances required by Sections 1105.1.1 through ~~[1105.1.6]~~ 1105.1.8, all public entrances shall be accessible.

Exceptions:

1. An accessible entrance is not required to areas [~~that are~~] not required to be accessible by [~~this chapter or~~] Appendix E or this chapter.
2. Loading and service entrances that are not the only entrance to a building or a tenant space.
3. Revolving doors, revolving gates, or turnstiles shall not be required to be accessible provided that an accessible entrance is available adjacent to such revolving doors, revolving gates or turnstiles.

1105.1.1 Parking garage entrances. Where provided, direct access for pedestrians from parking structures to buildings or facility entrances shall be accessible.

1105.1.2 Entrances from tunnels or elevated walkways. Where direct access is provided for pedestrians from a pedestrian tunnel or elevated walkway to a building or facility, entrances from such access to the building or facility shall be accessible.

1105.1.3 Restricted entrances. Where restricted entrances are provided to a building or facility, all such restricted [~~entrances~~] entrances to the building or facility shall be accessible.

1105.1.4 Entrances for inmates and detainees. Where entrances used only by inmates or detainees and security personnel are provided at judicial facilities, detention facilities or correctional facilities, all such entrances shall be accessible.

1105.1.5 Service entrances. If a service entrance is the only entrance to a building or a tenant space in a facility, that entrance shall be accessible.

1105.1.6 Tenant spaces. All entrances to tenant spaces that are required to be accessible shall be accessible entrances.

Exception: An accessible entrance is not required to self-service storage units that are not required to be accessible.

~~[1105.1.6.1]~~ **1105.1.7 Dwelling units and sleeping units.** Doors and doorways at entrance(s) to Accessible units and Type B+NYC units, including hardware, shall comply with Section 404 (Doors and Doorways) of ICC A117.1. Doors and doorways, including hardware, at entrance(s) to Type B units shall comply with Section 1003.5 (Doors and doorways) of ICC A117.1.

Exceptions:

1. An accessible entrance is not required to dwelling units and sleeping units that are not required to be Accessible units, Type B+NYC units, or Type B units.
2. Entrances to multistory dwelling or sleeping units in Group R-2 [~~occupancy~~] occupancies as provided in Section 1107.2.5 that are not on the primary entry story to the unit and are not part of the accessible route required in Exception 1 of Section 1107.2.5 shall not be required to be accessible.

[3. In Group I-2 facilities, doors to sleeping units shall be exempted from the requirements for maneuvering clearance at the room side provided the door is a minimum of 44 inches (1118 mm) in width.]

1105.1.8 Automatic doors. In facilities with the occupancies and building occupant loads indicated in Table 1105.1.8, at least one accessible public entrance shall be either a full power-operated door or a low-energy power-operated door.

Exception: For ground floor business or mercantile occupancies which are not yet demised for tenancy, the requirements of this section shall not apply until the occupant load for the tenant or tenants has been determined.

**TABLE 1105.1.8
PUBLIC ENTRANCE WITH POWER-OPERATED DOORS**

<u>Occupancy</u>	<u>Occupant Load ≥</u>
<u>A-1, A-2, A-3, A-4, B, R-1</u>	<u>200</u>
<u>E, M</u>	<u>300</u>

**SECTION BC 1106
PARKING AND PASSENGER LOADING FACILITIES**

1106.1 Required. Where parking is provided, 5 percent of the total number of parking spaces provided for a facility, but not less than one parking space, shall be accessible parking spaces except as otherwise required by Sections 1106.2 through 1106.4 of this code. Van-accessible parking spaces shall be provided in accordance with Section 1106.5 of this code. Accessible parking spaces shall be designed and constructed in accordance with Section 502 (Parking Spaces) of ICC A117.1. Where more than one parking facility is provided on a site, the number of parking spaces required to be accessible shall be calculated separately for each parking facility. Where a determination of the minimum number of parking spaces results in a number containing a decimal of 0.5 or more, the next highest integer shall be used.

Exception: This section does not apply to parking spaces used exclusively for buses, trucks, other delivery vehicles, law enforcement vehicles or vehicular impound where lots accessed by the public are provided with an accessible passenger loading zone.

1106.2 Groups R-2 and R-3. Where parking is provided for occupancies in Groups R-2 and R-3, which are required to have Accessible, Type B+NYC, or Type B units, the number of accessible parking spaces shall be in compliance with Section 1106.1 and such number of accessible parking spaces shall be dispersed in accordance with Section 1106.6. Where parking is provided within or beneath a building, accessible parking spaces shall also be provided within or beneath the building.

1106.2.1 Lease, rental, or assignment of spaces. In a parking facility accessory to Occupancy Group R-2 or R-3 serving only the residents or employees of the management of such occupancy, or provided in compliance with Section 25-412 of the New York City Zoning Resolution, the accessible parking spaces in such facility may be leased, rented or assigned to ~~[a person]~~ an

individual without [~~physical~~] disabilities on a no longer than month-to-month basis. Such leases, rentals, or assignments of the accessible parking spaces to [~~persons~~] individuals without [~~physical~~] disabilities shall be on written condition that such spaces be relinquished immediately at the end of the term of such lease, rental, or assignment to a resident or employee of the management of such occupancy who is [~~a person~~] an individual with [~~physical~~] disabilities.

1106.3 Hospital outpatient facilities. At least 10 percent, but not less than one, of [~~patient~~] care recipient and visitor parking spaces provided to serve hospital outpatient facilities shall be accessible.

1106.4 Rehabilitation facilities and outpatient physical therapy facilities. At least 20 percent, but not less than one, of the portion of [~~patient~~] care recipient and visitor parking spaces serving rehabilitation facilities specializing in treating conditions that affect mobility and outpatient physical therapy facilities shall be accessible.

1106.5 Van spaces. For every six or fraction of six accessible parking spaces, at least one [~~space~~] shall be a van-accessible parking space. Van-accessible parking spaces shall be designed and constructed in accordance with ICC A117.1, including Section 502 (Parking Spaces).

Exception: In Group R-2 and R-3 occupancies, van-accessible spaces located within private garages not exceeding 300 square feet (27.9 m²) shall be permitted to have vehicular routes, entrances, parking spaces and access aisles with a minimum vertical clearance of 7 feet (~~[2134]~~ 2133.6 mm).

1106.6 Location. Accessible parking spaces shall be located on the shortest accessible route of travel from adjacent parking to an accessible building entrance. In parking facilities that do not serve a particular building, accessible parking spaces shall be located on the shortest route to an accessible pedestrian entrance to the parking facility. Where buildings have multiple accessible entrances with adjacent parking, accessible parking spaces shall be dispersed and located near the accessible entrances. In Occupancy Groups R-2 and R-3, at least one of each type of parking space shall be accessible.

Exceptions:

1. In multilevel parking structures, van-accessible parking spaces complying with Section 502 (Parking Spaces) of ICC A117.1 may be provided on one level.
2. Accessible parking spaces shall be permitted to be located in different parking facilities if substantially equivalent or greater accessibility is provided in terms of distance from an accessible entrance or entrances, parking fee and user convenience.
3. In an attended parking facility in which vehicles customarily are parked and later returned to their drivers by an attendant employed by the parking facility, [~~accessible parking spaces need not be designated by a sign or lines if all of the following conditions are met:~~] the number of accessible parking spaces shall be provided in accordance with Table 1106.7.3 and Section 1106.7.3 of this code.

~~[3.1. Van accessible parking spaces complying with Section 502 (Parking Spaces) of ICC A117.1 are provided;]~~

- ~~[3.2. A passenger loading zone complying with Section 1106.7 is provided where an attendant shall take control of the vehicles. A vertical clearance of 98 inches (2489 mm) shall be permitted at such loading zone;]~~
- ~~[3.3. At least one accessible parking space shall remain available unless all accessible parking spaces are occupied;]~~
- ~~[3.4. The attendant shall park and retrieve all vehicles not equipped with special controls entering the facility in which a person with disabilities is either the driver or a passenger, provided accessible parking space is available;]~~
- ~~[3.5. The attendant shall direct the drivers of vehicles equipped with special controls to accessible parking spaces. The attendant shall accompany such drivers to and from such space along an accessible route when they enter and exit the facility. If necessary, the accessible route and accessible parking space shall be created by the repositioning of vehicles parked previously by the attendant; and]~~
- ~~[3.6. Each van accessible parking space shall have two permanently and prominently posted signs. One shall include the International Symbol of Accessibility complying with Section 703.6.3.1 of ICC A117.1. The other sign shall note that vehicles parked in such spaces are subject to being moved by an attendant of the parking facility in order to accommodate a vehicle which cannot be accommodated in another accessible parking space. Such signs shall not be obstructed by a vehicle parked in the space.]~~

4. Mechanical access parking garages shall comply with Section 1106.7.4 of this code.

1106.7 Passenger loading zones. Passenger loading zones shall be designed and constructed in accordance with ICC A117.1 including Section 503 (Passenger Loading Zones). ~~[Where there are curbs between the access aisle and the vehicle pull up space, a curb ramp complying with ICC A117.1 including Section 406 (Curb Ramps) shall be provided.]~~

1106.7.1 Continuous loading zones. Where passenger loading zones are provided, at least one accessible passenger loading zone shall be provided within each continuous 100 linear feet (30 400 mm) of loading zone space, or fraction thereof, so that travel between accessible passenger loading zones will not exceed 100 linear feet (30 400 m).

1106.7.2 Medical facilities. A passenger loading zone shall be provided at an accessible entrance to licensed medical and long-term care facilities where people receive physical or medical treatment or care and where the period of stay exceeds 24 hours.

1106.7.3 Valet and attended parking. The number of accessible parking spaces in facilities that utilize valet and attended parking services shall be provided in accordance with Table 1106.7.3, and Sections 1106.7.3.1 and 1106.7.3.2.

**TABLE 1106.7.3
VALET AND ATTENDED ACCESSIBLE PARKING SPACES**

<u>TOTAL PARKING SPACES PROVIDED IN PARKING FACILITIES</u>	<u>REQUIRED MINIMUM NUMBER OF ACCESSIBLE SPACES</u>
<u>1 to 25</u>	<u>1s</u>
<u>26 to 50</u>	<u>2</u>
<u>51 to 75</u>	<u>3</u>
<u>76 to 100</u>	<u>4</u>
<u>101 to 150</u>	<u>5</u>
<u>151 to 200</u>	<u>6</u>
<u>201 to 300</u>	<u>7</u>
<u>301 to 400</u>	<u>8</u>
<u>401 to 500</u>	<u>9</u>
<u>501 to 1,000</u>	<u>2% of total</u>
<u>1,001 and over</u>	<u>20, plus one for each 100, or fraction thereof, over 1,000</u>

[1106.7.3] 1106.7.3.1 Valet parking. In a facility utilizing valet parking services in which vehicles are parked and later returned to their drivers by a valet employed by the facility, the number of accessible parking spaces shall be provided in accordance with Table 1106.7.3 of this code. A passenger loading zone complying with Section 1106.7 of this code shall be provided at valet parking services where the valet shall take control of the vehicles. Passenger loading zones shall comply with Section 503 (Passenger Loading Zones) of ICC A117.1.

1106.7.3.2 Attended parking. In an attended parking facility in which vehicles customarily are parked and later returned to their drivers by an attendant employed by the parking facility, the number of accessible parking spaces shall be provided in accordance with Table 1106.7.3 of this code.

1106.7.3.2.1 Passenger loading zone. A passenger loading zone complying with Section 1106.7 of this code shall be provided where an attendant shall take control of the vehicles. Passenger loading zones shall comply with Section 503 (Passenger Loading Zones) of ICC A117.1.

1106.7.3.2.2 Retrieval of vehicles. The attendant shall park and retrieve all vehicles not equipped with special controls entering the facility in which an individual with

disabilities is either the driver or a passenger, provided accessible parking space is available.

1106.7.4 Mechanical access parking garages. Mechanical access parking garages shall provide at least one passenger loading zone in compliance with Section 1106.7 at vehicle drop-off and vehicle pick-up areas.

1106.8 Electrical vehicle charging stations. Electrical vehicle charging stations shall comply with Sections 1106.8.1 through 1106.8.5.

Exception: Electrical vehicle charging stations intended for use by a designated vehicle or driver shall not be required to comply with this section.

1106.8.1 Number of accessible vehicle charging stations. Where provided for common use, at least five percent of the total number of electrical vehicle charging stations per facility, but not less than one for each type of electric vehicle charging station, shall be accessible. Where a multiport electric vehicle charging station can simultaneously charge more than one vehicle, the number of electric vehicle charging stations shall be counted as the number of electric vehicles that can be simultaneously charged. The number of accessible vehicle charging stations are in addition to the required accessible parking spaces.

1106.8.2 Electric vehicle charging space. At each electrical vehicle charging station required to be accessible, the charging space shall comply with the requirements for a van accessible parking space complying with Sections 502.2 through 502.5 of ICC A117.1.

1106.8.3 Accessible route. At each electric vehicle charging station required to be accessible, the charging station shall be located along an accessible route. An accessible route shall be provided between the charging station and the charging space.

Exception: In existing facilities with no accessible route, electrical vehicle charging stations are not required to be located along an accessible route.

1106.8.4 Obstructions. Electric vehicle charging stations shall be designed so accessible routes are not obstructed by cables or other elements.

1106.8.5 Electrical vehicle charging station controls. Electric vehicle charging stations and electric vehicle charging station controls shall comply with Sections 309.2 and 309.3 of ICC A117.1.

SECTION BC 1107 DWELLING UNITS AND SLEEPING UNITS

1107.1 General. In addition to the other requirements of this chapter, occupancies having dwelling units or sleeping units shall be provided with accessible features in accordance with this section.

1107.2 Design. Dwelling units and sleeping units which are required to be Accessible units, Type B+NYC units, or Type B units shall comply with this code [~~including Appendix P where applicable,~~] and the applicable provisions of Chapter 10 of ICC A117.1. [~~In addition,~~] Type B+NYC units shall further comply with Section 1004 (Type B Units) of ICC A117.1, including any modifications made

by Sections 1107.2.1 through 1107.2.8 of this code. Units required to be Type B+NYC units or Type B units are permitted to be designed and constructed as Accessible units.

1107.2.1 Type B+NYC unit doors and doorways. Doors and doorways at the entrance(s) to Type B+NYC dwelling or sleeping units shall comply with Section ~~[1105.1.6]~~ 1105.1.7 of this code. All other doors and doorways within the dwelling or sleeping unit, and patio or balcony doors of such dwelling or sleeping unit, meant for human passage shall comply with Section 1003.5 (Doors and Doorways) of ICC A117.1. ~~[In addition, doors]~~ Doors and doorways serving toilet and bathing rooms [that are required to comply with Appendix P shall also comply with Section P102.3.] shall comply with Section 1003.5 of ICC A117.1.

Exceptions:

1. Maneuvering clearance at doors.

1.1. Where pull side, latch approach maneuvering clearance is required within the dwelling or sleeping unit for a door without a closer as per Figure 404.2.3.2(f) of ICC A117.1, the minimum maneuvering clearance perpendicular to the doorway shall be permitted to be reduced to 42 inches (~~[1067]~~ 1066.8 mm).

1.2. Where exterior spaces are greater than 24 inches (609.6 mm) in clear depth such spaces shall comply with the required door maneuvering clearances on both the interior and exterior side of the door.

2. Door hardware. Door hardware on doors within the dwelling or sleeping unit, except on entrance doors, shall not be required to comply with Section 404.2.6 (Door Hardware) of ICC A117.1 provided such hardware is readily replaceable without the removal or replacement of the door.

3. Future reversibility for bedroom doors. Bedroom doors and frames shall be permitted to be provided with mortised hinge and latch blanks to permit future reversal of the door on the same frame using common hand tools and without further alterations to the door and frame, provided such future swing of the door will not obstruct the maneuvering clearances required at the door or doorway.

4. Storage facility doors. Door maneuvering clearances are not required for doors that are accessed from the interior of a closet within a dwelling unit or sleeping unit.

5. Supplemental toilet and bathing rooms. Where one Type A toilet and bathing room is provided in a Type B+NYC unit in accordance with the exception in Section 1107.2.2 of this code, the doors and doorways to all other toilet and bathing rooms in that dwelling unit or sleeping unit shall not be required to comply with maneuvering clearances on the interior side of the bathroom, but shall comply with Section 1004.5.2 (User Passage Doorways) of ICC A117.1 and shall provide clear opening width of 32 inches (~~[813]~~ 812.8 mm) minimum.

6. Bathroom and toilet room doors.

- 6.1. Doors shall not swing into the required clear floor or ground space or clearance for any fixture unless a clear floor or ground space complying with Section 305.3 of ICC A117.1 is provided within the room, beyond the arc of the door swing.
- 6.2. Bathroom and toilet room doors shall be provided with maneuvering clearances on the toilet room or bathroom side of the door in accordance with Section 404.2.3 of ICC A117.1.

1107.2.2 Type B+NYC unit toilet and bathing rooms. Where toilet and bathing rooms are provided in ~~the~~ a Type B+NYC dwelling unit or sleeping unit, all such toilet and bathing rooms shall comply with ~~[Appendix P]~~ Sections 1107.2.2.1 through 1107.2.2.9. Within each such toilet room, at least one lavatory, and one water closet shall comply with Sections 1107.2.2.1 through 1107.2.2.7. Within each bathing room, at least one lavatory, one water closet, and either a bathtub or shower shall comply with Sections 1107.2.2.1 through 1107.2.2.8. Toilet and bathing fixtures shall be in a single room, such that travel between fixtures does not require travel beyond the room in which the fixtures of such toilet or bathing room is located. Additional fixtures shall comply with Section 1107.2.2.9.

Exception for Type A toilet and bathing room: Where at least one toilet and bathing room complying with Sections 1003.11 (Toilet and Bathing Facility) and 1003.3.2 (Turning Space) of ICC A117.1 is provided within a Type B+NYC dwelling unit or sleeping unit in accordance with Items 1 through 3 of this exception, other toilet and bathing rooms in the same unit shall be required to comply only with Sections 1004.3 (Accessible route), 1004.4 (Walking Surfaces), 1004.5.2 (User Passage Doorways), 1004.9 (Operable Parts) and 1004.11.1 (Grab Bar and Shower Seat Reinforcement) of ICC A117.1. In addition, a vertical grab bar 18 inches (457.2 mm) minimum in length shall be mounted with the bottom of the bar located between 39 inches (990.6 mm) and 41 inches (1041.4 mm) above the floor, and with the center of the bar located at 30 inches (762 mm) from the rear wall. Doors and doorways to such toilet and bathing rooms shall be subject to Section 1107.2.1, Exception 5.

~~[1. Where at least one toilet and bathing room in the Type B+NYC dwelling unit or sleeping unit is constructed in accordance with the Type A toilet and bathing facilities requirements of Section 1003.11 (Toilet and Bathing Facilities), including Section 1003.3.2 (Turning Space), of ICC A117.1 and is in compliance with the following:]~~

~~[1.1.]~~ 1. At least one lavatory, one water closet and either a bathtub or shower within such toilet or bathing facility shall comply with Section 1003.11 of ICC A117.1. Such toilet and bathing fixtures shall be in a single toilet or bathing area, such that travel between fixtures does not require travel beyond the area in which the fixtures of such toilet or bathing room are located.

~~[1.2.]~~ 2. Toilet paper dispensers within such rooms shall comply with Section 604.7 (Dispensers) of ICC A117.1.

~~[1.3.]~~ 3. Medicine cabinets, if provided, must include a storage shelf no higher than 44 inches (~~[4418]~~ 1117.6 mm) above the floor.

~~[2. Where at least one toilet and bathing room complying with Sections 1003.11 and 1002.3.2 of ICC A117.1 is provided within the Type B+NYC dwelling unit or sleeping unit in accordance with Item 1 of this exception, other toilet and bathing rooms in the same unit shall be required to comply only with Sections 1004.3 (Accessible route), 1004.4 (Walking Surfaces), 1004.5.2 (User Passage Doorways), 1004.9 (Operable Parts) and 1004.11.1 (Grab Bar and Shower Seat Reinforcement) of ICC A117.1. Doors and doorways to such toilet and bathing rooms shall be subject to Section 1107.2.1, Exception 5.]~~

1107.2.2.1 Accessible route. At least one accessible route shall connect all spaces and elements with each toilet and bathing room within a dwelling unit or sleeping unit unless as permitted in Section 1107.2.5, Item 3 of this code. Accessible routes shall comply with ICC A117.1.

1107.2.2.2 Operable parts. Lighting controls, electrical switches and receptacle outlets, and environmental controls shall comply with Section 309 of ICC A117.1.

1107.2.2.3 Knee and toe clearance. Clear floor space at fixtures shall be permitted to include knee and toe clearances complying with Section 306 of ICC A117.1.

1107.2.2.4 Overlap. Clear floor or ground spaces and clearances are permitted to overlap.

1107.2.2.5 Lavatory. Lavatories shall comply with Section 606 of ICC A117.1.

Exception: Cabinetry shall be permitted under the lavatory, provided:

1. Such cabinetry can be removed without removal or replacement of the lavatory;
2. The finish floor extends under such cabinetry; and
3. The walls behind and surrounding such cabinetry are finished.

1107.2.2.6 Mirrors and medicine cabinets. Mirrors above lavatories shall have the bottom edge of the reflecting surface 40 inches (1016 mm) maximum above the floor or ground. Medicine cabinets, if provided, must include a storage shelf no higher than 44 inches (1117.6 mm) above the floor.

1107.2.2.7 Water closet. Water closets shall comply with Sections 1107.2.2.7.1 through 1107.2.2.7.6.

1107.2.2.7.1 Location. The water closet shall be positioned with a wall to the rear and to one side. The centerline of the water closet shall be 18 inches (457.2 mm) from the side wall.

1107.2.2.7.2 Clearance. Clearance around the water closet shall comply with Sections 1107.2.2.7.2.1 through 1107.2.2.7.2.3.

1107.2.2.7.2.1 Parallel approach. Where only a parallel approach is provided to the water closet, the clearance shall be 56 inches (1422 mm) minimum, measured perpendicular from the rear wall, and 48 inches (1220 mm) minimum, measured perpendicular from the sidewall. A lavatory complying with Section 1107.2.2.5 shall be permitted on the rear wall, 18 inches (457.2 mm) minimum from the water closet centerline.

1107.2.2.7.2.2 Forward approach. Where only a forward approach is provided to the water closet, the clearance shall be 66 inches (1676 mm) minimum, measured perpendicular from the rear wall, and 48 inches (1220 mm) minimum, measured perpendicular from the side wall. A lavatory complying with Section 1107.2.2.5 shall be permitted on the rear wall, 18 inches (457.2 mm) minimum from the water closet centerline.

1107.2.2.7.2.3 Parallel and forward approach. Where both a parallel and a forward approach are provided to the water closet, the clearance shall be 56 inches (1422 mm) minimum, measured perpendicular from the rear wall, and 60 inches (1524 mm) minimum, measured perpendicular from the side wall. No fixtures or obstructions, other than the water closet, shall be within the clearance.

1107.2.2.7.3 Grab bars. Grab bars for water closets shall comply with Section 609 of ICC A117.1 and shall be provided in accordance with Sections 1107.2.2.7.3.1 through 1107.2.2.7.3.2 of this code. Mounting heights of grab bars shall comply with Section 609.4 of ICC A117.1.

Exception: Grab bars are not required to be installed where reinforcement for such grab bars is installed and located to permit future installation of grab bars complying with Section 1107.2.2.7.3 of this code.

1107.2.2.7.3.1 Fixed side wall grab bars. Fixed side wall grab bars shall be 42 inches (1066.8 mm) minimum in length, located 12 inches (304.8 mm) maximum from the rear wall and extending 54 inches (1371.6 mm) minimum from the rear wall. In addition, a vertical grab bar 18 inches (457.2 mm) minimum in length shall be mounted with the bottom of the bar located between 39 inches (990.6 mm) and 41 inches (1041.4 mm) above the floor, and with the center of the bar located at 30 inches (762 mm) from the rear wall.

Exception: Where a side wall is not available for a 42-inch (1066.8 mm) grab bar, the sidewall grab bar shall be permitted to be 24 inches (609.2 mm) minimum in length, located 12 inches (304.8 mm) maximum from the rear wall.

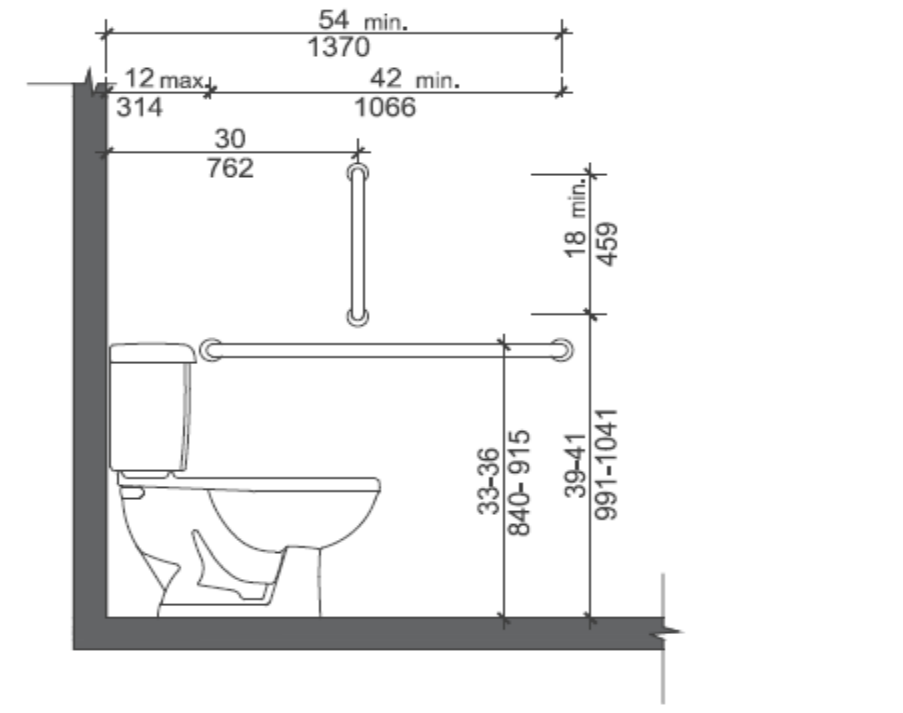

FIGURE 1107.2.2.7.3.1
SIDEWALL GRAB BAR LOCATION

1107.2.2.7.3.2 Rear wall grab bars. The rear wall grab bar shall be 36 inches (914.4 mm) minimum in length, and extend from the centerline of the water closet 12 inches (304.8 mm) minimum on the side closet to the wall, and 24 inches (609.2 mm) minimum on the transfer side.

Exception: Where wall space will not permit a grab bar 36 inches (914.4 mm) minimum in length, reinforcement for a rear wall grab bar 24 inches (609.2 mm) minimum in length centered on the water closet shall be provided.

1107.2.2.7.4 Height. The top of the toilet seat shall be 15 inches (381 mm) minimum and 19 inches (482.6 mm) maximum above the floor or ground.

1107.2.2.7.5 Flush controls. Flush controls shall comply with Section 309 of ICC A117.1. Flush controls shall be located in accordance with one of the following:

1. On the open side of the water closet; or
2. Centrally located on the top of the tank or water closet; or
3. Centrally located on the water closet rear wall.

1107.2.2.7.6 Dispensers. Toilet paper dispensers shall comply with this section. The outlet of the dispenser shall be located within an area 24 inches (609.2 mm) minimum

and 42 inches (1066.8 mm) maximum from the rear wall. The outlet of the dispenser shall be located 18 inches (457.2 mm) minimum above the floor. Dispensers shall comply with Section 609.3 of ICC A117.1.

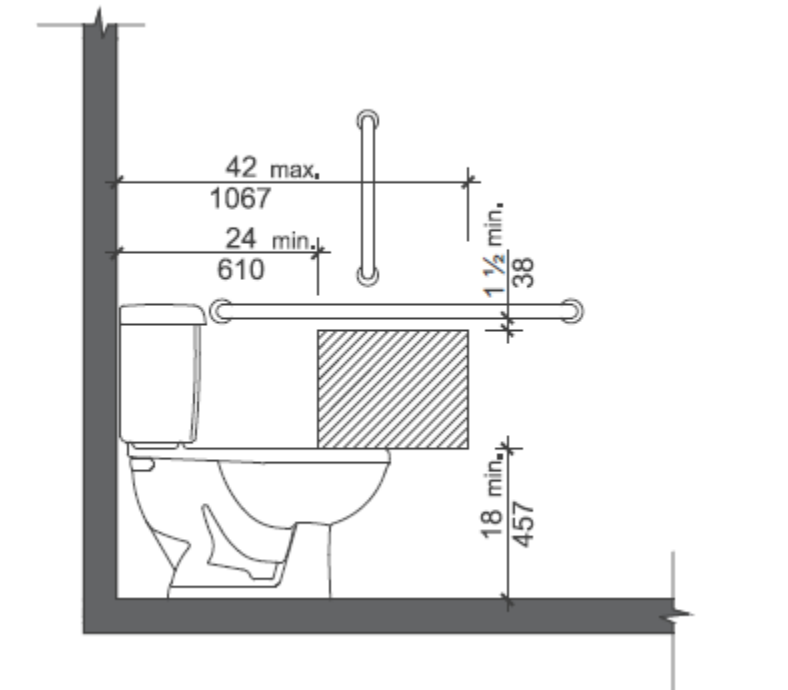

FIGURE 1107.2.2.7.6
DISPENSER OUTLET LOCATION

1107.2.2.8 Bathing facilities. Where provided, a bathtub shall comply with Section 1107.2.2.8.1, and a shower compartment shall comply with Section 1107.2.2.8.2.

1107.2.2.8.1 Bathtubs. Bathtubs shall comply with Section 607 of ICC A117.1. Lavatories complying with Section 1107.2.2.5 of this code shall be permitted in the clearance required by Section 607.2 of ICC A117.1. Bathtub seats shall not be required.

Exception: Where a hand shower in compliance with Section 607.6 of ICC A117.1 is not provided, the owner shall provide such a hand shower at the time an individual with disabilities takes occupancy of the unit, or within 10 days of the date the request is made by an individual with disabilities, whichever is later, at the owner's expense.

1107.2.2.8.1.1 Grab bars. Grab bars for bathtubs shall comply with Section 609 of ICC A117.1 and shall be provided in accordance with Section 607.4 of ICC A117.1.

Exception: Grab bars are not required to be installed where reinforcement for such grab bars is installed and located to permit future installation of grab bars complying with Section 1107.2.2.8.1.1.

1107.2.2.8.2 Showers. Showers shall comply with Section 608 of ICC A117.1.

Exceptions:

1. For showers other than transfer-type showers, counter tops and cabinetry shall be permitted at the control end of the clearance, provided such counter tops and cabinetry can be removed and the floor finish extends under such cabinetry.
2. Where a hand shower in compliance with Section 608.5 of ICC A117.1 is not provided pursuant to the exception in such section, the owner shall provide such a hand shower at the time an individual with disabilities takes occupancy of the unit, or within 10 days of the date the request is made by an individual with disabilities, whichever is later, at the owner's expense.

1107.2.2.8.2.1 Grab bars and seats. Grab bars and seats for showers shall comply with Sections 609 and 610 of ICC A117.1 and shall be provided in accordance with Sections 608.2.3.2 and 608.3 of ICC A117.1.

Exception: Grab bars and seats are not required to be installed where reinforcement for such grab bars and seats is installed and located to permit future installation of grab bars and seats complying with Section 1107.2.2.8.2.1 of this code.

1107.2.2.9 Additional fixtures. Additional fixtures provided within toilet and bathing rooms shall comply with Sections 1004.11.1 (Grab Bar and Shower Seat Reinforcement), 1004.11.3.1.1 (Lavatory), 1004.11.3.1.2 (Water Closet) and 1004.11.3.1.3 (Bathing Fixtures) of ICC A117.1.

1107.2.3 Type B+NYC unit kitchen and kitchenette. Where kitchens and kitchenettes are provided in ~~the~~ a Type B+NYC dwelling unit or sleeping unit, the primary kitchen or kitchenette shall be constructed in accordance with the kitchen requirements of Section 1003.12 (Kitchen) and 1003.3.2 (Turning Space) of ICC A117.1, ~~and~~ including any modifications made by Sections 1107.2.3.1 through 1107.2.3.5 of this code. Secondary kitchens and kitchenettes within the same dwelling unit or sleeping unit shall be required to comply only with Section 1004.12 (Kitchens) of ICC A117.1.

1107.2.3.1 Kitchen counters. A kitchen counter that is required to comply with Section 1003.12.3.2 or 1003.12.4.2 (Height) of ICC A117.1 shall be permitted to be adjustable or designed to be replaceable as a unit at variable heights between 29 inches and 36 inches (~~[737]~~ 736.6 mm and ~~[914]~~ 914.4 mm), measured from the floor to the top of the work surface. The owner shall adjust or replace such countertop at the time ~~[a person]~~ an individual with ~~physical~~ disabilities takes occupancy of the unit, or within 10 days of the date the request is made by ~~[a person with physical disabilities]~~ such individual, whichever is later, at the owner's expense.

1107.2.3.2 Appliances in kitchen and kitchenette. Appliances in kitchens and kitchenettes shall comply with Section 1003.12.5 (Appliances) of ICC A117.1.

Exception: Where appliances' controls are not in compliance with Section 309.3

(Height) of ICC A117.1, the owner shall replace such appliances with appliances in conformance with Section 309.3 of ICC A117.1 at the time ~~[a person]~~ an individual with ~~[physical]~~ disabilities takes occupancy of the unit, or within 10 days of the date the request is made by ~~[a person with physical disabilities]~~ such individual, whichever is later, at the owner's expense. However, the owner shall not be responsible to provide a particular model or type of appliances provided such appliances and controls comply with Sections 1003.12.5 and 309.3 of ICC A117.1.

1107.2.3.3 Refrigerator/freezers. Combination refrigerators and freezers shall comply with Section 1003.12.5.6 (Refrigerator/Freezer) of ICC A117.1. In addition, where less than 100 percent of storage volume of the freezer is located within 54 inches (~~[1372]~~ 1371.6 mm) maximum above the floor, such freezer shall be a self-defrosting type.

Exception: Where refrigerators and freezers are not in compliance with this section, the owner shall replace such appliances with complying appliances at the time ~~[a person]~~ an individual with ~~[physical]~~ disabilities takes occupancy of the unit, or within 10 days of the date the request is made by ~~[a person with physical disabilities]~~ such individual, whichever is later, at the owner's expense. However, the owner shall not be responsible to provide a particular model or type of appliances provided such appliances comply with this section.

1107.2.3.4 Cooktops and ovens. Cooktops and ovens shall comply with ~~[Section]~~ Sections 1003.12.5.4 and 1003.12.5.5 of ICC A117.1, respectively. However, oven controls shall not be required to be located on either side of the oven door, provided such controls comply with Section 1003.12.5.5.4 of ICC A117.1. Where double ovens are provided, at least one oven interior and its controls shall comply with Section 309.3 (Height) of ICC A117.1.

1107.2.3.5 Kitchen and kitchenette storage. Kitchen storage, kitchen cabinets, drawers, and shelf storage areas, within kitchen and kitchenettes ~~[that are required to]~~ shall comply with Section ~~[1003.12]~~ 905 (Storage Facilities) of ICC A117.1 pursuant to Section 1107.2.3 of this code, except overhead cabinets~~[-, shall comply with Section 905 (Storage Facilities) of ICC A117.1]~~. In addition, at least one storage shelf or cabinet, mounted above the work ~~[counters]~~ surface at 48 inches (~~[1219]~~ 1220 mm) maximum above the floor, shall be provided.

Exception: Where the storage shelf or cabinet is not provided in accordance with this section, the owner shall install such storage shelf or cabinet in compliance with this section at the time ~~[a person]~~ an individual with ~~[physical]~~ disabilities takes occupancy of the unit, or within 10 days of the date the request is made by ~~[a person with physical disabilities]~~ such individual, whichever is later, at the owner's expense.

1107.2.4 Type B+NYC unit operable windows. All operable windows required to provide natural ventilation and/or an emergency escape and rescue opening in rooms or spaces in ~~[the]~~ a Type B+NYC dwelling unit or sleeping unit shall comply with Section 1003.13 (Windows) of ICC A117.1.

Exceptions:

1. Where windows that are required to provide natural ventilation are not in compliance with reach ranges specified in Section 309.3 (Height) for operable parts as required by Section 1003.13.1 of ICC A117.1, the operable parts of such windows shall be designed to be operable by the use of adaptive devices. The owner shall provide such adaptive devices at the time ~~[a person]~~ with an individual with ~~[physical]~~ disabilities takes occupancy of the unit, or within 10 days of the date the request is made by ~~[a person with physical disabilities]~~ such individual, whichever is later, at the owner's expense.
2. Compliance with Section 1107.2.4 of this code is not required in kitchenettes less than 80 square feet (7.4 m²) in area and equipped with an accessible mechanical means of ventilation complying with the *New York City Mechanical Code*, and in bathrooms equipped with an accessible mechanical means of ventilation complying with the *New York City Mechanical Code*.

1107.2.5 Type B+NYC multistory units. Multistory Type B+NYC dwelling units or sleeping units shall comply with the following:

1. One of the stories with an accessible entrance shall be designated as the primary entry story to the unit;
2. All rooms, spaces and doors on the primary entry story shall comply with Section 1107.2; and
3. Rooms, spaces or doors located on other than the primary entry story, and interior routes thereto, need not comply with Section 1107.2 where the primary entry story contains equivalent functional facilities. Functional facilities shall include cooking facilities, bathing facilities, laundry equipment, sleeping areas, living areas, dining areas, and outdoor areas such as balconies or terraces.

Exception: Functional facilities in compliance with Section 1107.2 need not be located on the primary entry story, but may be located on any story within the dwelling unit or sleeping unit, provided that all rooms, spaces and doors located on such story containing such functional facilities comply with Section 1107.2. Notwithstanding the above, at least one toilet room complying with Section 1107.2.2 shall be provided on the primary entry story. In addition, one of the following conditions shall be met:

1. An accessible external elevator is provided to connect all such stories of the multistory dwelling unit or sleeping unit; or
 2. ~~[A stairway complying with Section 504 (Stairways) of ICCA117.1 with a minimum clear width of 36 inches (914 mm) is provided within the multistory dwelling unit or sleeping unit to connect all such stories of the unit; or]~~
- ~~[3.]~~An accessible route complying with Section 402 (accessible routes) of ICC A117.1 is provided within the dwelling unit or sleeping unit to connect all such stories of the unit.

1107.2.6 Type B+NYC unit raised or sunken floor area. Where a raised or sunken floor area in a portion of a living, dining, or sleeping room within a Type B+NYC dwelling unit or sleeping unit that is permitted by Section 1004.3 (Accessible route, Exception 1 and 2) of ICC A117.1 is provided, steps complying with Section 504 (Stairways) of ICC A117.1 with a minimum clear width of 36 inches (~~[914]~~ 914.4 mm) shall connect such portion of raised or sunken floor area to an accessible route. In addition, a minimum area of 80 square feet (7.4 m²), and 8 feet (~~[2438]~~ 2438.4 mm) in one dimension, of each of such living, dining, or sleeping room shall be connected by an accessible route that is in compliance with Section 1004.3.2 (Components) of ICC A117.1.

1107.2.7 Type B+NYC unit storage facilities. Where storage facilities are provided within ~~[the]~~ a Type B+NYC dwelling unit or sleeping unit, they shall comply with Section 905 (Storage Facilities) of ICC A117.1.

Exceptions:

1. A turning space shall ~~[not]~~ be required in storage facilities greater than 48 inches (12 mm) in depth in compliance with Section 1003.3.2 of ICC A117.1.
2. Where accessible storage elements are not in compliance with Section 905.3 of ICC A117.1, the owner shall relocate such elements to be in compliance with the section at the time ~~[a person]~~ an individual with ~~[physical]~~ disabilities takes occupancy of the unit, or within 10 days of the date the request is made by ~~[a person]~~ an individual with ~~[physical]~~ disabilities, whichever is later, at the owner's expense.

1107.2.8 Type B+NYC unit laundry equipment. Where washing machines or clothes dryers are provided within ~~[the]~~ a Type B+NYC dwelling unit or sleeping unit, such equipment shall comply with Section 611 (Washing Machines and Clothes Dryers) of ICC A117.1 and shall be front loading. Laundry equipment in accessible common-use areas as required in Section 1107.3 shall comply with Section E105.2 of Appendix E of this code.

Exception: At the option of the owner, laundry equipment conforming to this section within the dwelling unit or sleeping unit may be provided at the time ~~[a person]~~ an individual with ~~[physical]~~ disabilities takes occupancy of the unit, or within 10 days of the date the request is made by ~~[a person with physical disabilities]~~ such individual, whichever is later, at the owner's expense. However, the owner shall not be responsible to provide a particular model or type of equipment provided such equipment complies with this section.

1107.3 Accessible spaces. Rooms and spaces available to the general public or available for common use by residents ~~[of]~~ and serving Accessible units, Type B+NYC units~~;~~ or Type B units shall be accessible. Accessible spaces shall include, but not be limited to, spaces for residents' use, such as laundry rooms, refuse disposal and storage locations, mailbox areas, recreational facilities, assembly and tenants' meeting rooms, storage rooms, management offices, parking areas, toilet and bathing rooms, kitchen, living and dining areas~~;~~ and any exterior spaces, including patios, terraces and balconies~~;~~ management offices, and stores.

Exception: ~~[In Group I-2 facilities, doors to sleeping units shall be exempted from the requirements for maneuvering clearance at the room side provided the door is a minimum of 44 inches (1118 mm) in width.]~~ Stories and mezzanines exempted by Section 1107.4.

1107.3.1 Mailboxes. Except as otherwise provided by rules of the department for the purposes of complying with rules and regulations established by the United States Postal Service and/or the United States Department of Housing and Urban Development, where mailboxes are provided for each dwelling unit or sleeping unit in an interior location, 100 percent of such mailboxes shall comply with ICC A117.1, and the operable parts of such mailboxes shall be no higher than 48 inches ([4219] 1220 mm) above the finished floor.

1107.4 Accessible route. At least one accessible route shall connect accessible building or facility entrances with the required accessible entrance(s) of each Accessible unit, Type B+NYC unit, and Type B unit within the building or facility and with those exterior and interior spaces and facilities that serve the units.

[Exception] Exceptions:

1. Exterior spaces, including but not limited to roof terraces, exterior decks, patios or balconies that are part of Type B+NYC units or Type B units, that are not for public use or common use, that have impervious surfaces, and that are not more than 4 inches ([102] 101.6 mm) below the finished floor level of the adjacent interior space of the unit. Such roof terraces, decks, patios or balconies shall be designed so that accessibility can be readily provided, without modifications to the guard rail heights and structural supports, by the installation of a noncombustible ramp in compliance with Section 405 (Ramps) of ICC A117.1, or a noncombustible level platform, with removable panel for access to floor drainage, that is permeable to weather and in compliance with Section 302 (Floor Surfaces) and Section 303 (Changes in Level) of ICC A117.1.
2. In Group I-3 facilities, an accessible route is not required to connect other levels or mezzanines where Accessible units, all common use areas serving Accessible units and all public use areas are on levels served by an accessible route.
3. In Group R-1 occupancies, an accessible route is not required to connect stories or mezzanines within individual units, provided the accessible level meets the provisions for Accessible units and sleeping accommodations for two persons minimum and a toilet facility are provided on that level.
4. An accessible route between stories is not required where Type B units are exempted by Section 1107.7.

1107.5 Group I. Accessible units shall be provided in Group I occupancies in accordance with Sections 1107.5.1 through [4107.5.6] 1107.5.5.

1107.5.1 Group I-1 [Acessible] Accessible units. [~~Group I-1 occupancies shall be provided with accessible features in accordance with Section 1107.5.1.1.~~] In Group I-1 occupancies, at least [ten] 10 percent, but not less than one, of the dwelling units and sleeping units shall be Accessible units. The remainder shall be Type B+NYC units with all grab bars installed where grab bar reinforcements are required.

Exceptions:

1. In Group I-1 occupancies classified as “convalescent facilities,” one hundred percent of the dwelling units or sleeping units shall be Accessible units.
2. In Group I-1 occupancies where the governmental agency that licenses, funds or approves such facilities documents that such facilities are not targeted for people with conditions that affect mobility, at least five percent, but not less than one, of the dwelling units and sleeping units shall be Accessible units, and the remainder shall be Type B+NYC units. Conditions that affect mobility include conditions requiring the use or assistance of a brace, cane, crutch, prosthetic device, wheelchair, or powered mobility aid; arthritic, neurological, or orthopedic conditions that severely limit one’s ability to walk; respiratory diseases and other conditions which may require the use of portable oxygen; and cardiac conditions that impose significant functional limitations.

1107.5.2 Group I-2 [~~Nursing~~] nursing homes [~~Accessible units~~]. In nursing homes of Group I-2 occupancies 100 percent of the dwelling units and sleeping units shall be Accessible units.

1107.5.3 Group I-2 [~~Hospitals~~] hospitals. In general purpose hospitals, psychiatric facilities, detoxification facilities and residential care/assisted living facilities of Group I-2 occupancies, 100 percent of the dwelling units and sleeping units shall be Accessible units.

1107.5.3.1 Accessible unit entry doors. Entry doors to accessible dwelling units or sleeping units shall not be required to provide the maneuvering clearance beyond the latch side of the door.

1107.5.4 Group I-2 [~~Rehabilitation~~] rehabilitation facilities. In hospitals and rehabilitation facilities of Group I-2 occupancies [~~which~~] that specialize in treating conditions that affect mobility, or units within either [~~which~~] that specialize in treating conditions that affect mobility, 100 percent of the dwelling units and sleeping units shall be Accessible units.

1107.5.4.1 Enriched assisted living residences [~~(EARL)~~] (EALR) and special needs assisted living residences [~~(SNARL)~~] (SNALR). In enriched assisted living residences [~~(EARL)~~] (EALR) and special needs assisted living residences [~~(SNARL)~~] (SNALR) licensed by the New York State Department of Health, at least ten percent, but not less than one, of the dwelling units and sleeping units shall be Accessible units. The remainder shall be Type B+NYC units with all grab bars installed where grab bar reinforcements are required.

1107.5.5 Group I-3. Accessible units shall be provided in Group I-3 occupancies in accordance with Sections 1107.5.5.1 through 1107.5.5.3.

1107.5.5.1 Group I-3 sleeping units. In Group I-3 occupancies, at least [~~two~~] 3 percent of the total number of sleeping units in the facility, but not less than one [~~, of the dwelling units and sleeping units~~] unit in each classification level, shall be Accessible units.

1107.5.5.2 Special holding cells and special housing cells or rooms. In addition to the Accessible units required by Section 1107.5.5.1, where special holding cells or special housing cells or rooms are provided, at least one serving each purpose shall be an Accessible unit. Cells or rooms subject to this requirement include, but are not limited to, those used for

purposes of orientation, protective custody, administrative or disciplinary detention or segregation, detoxification and medical isolation.

Exception: Cells or rooms specially designed without protrusions and that are used solely for purposes of suicide prevention shall not be required to include grab bars.

1107.5.5.3 Medical care facilities. In addition to any medical isolation cells required by Section 1107.5.5.2 to be Accessible units, 100 percent of the patient sleeping units or cells in medical facilities of ~~[group]~~ Group I-3 occupancies shall be Accessible units.~~[-]~~

1107.6 Group R. Accessible units, Type B+NYC units and Type B units shall be provided in Group R occupancies in accordance with Sections 1107.6.1 through 1107.6.3.

1107.6.1 Group R-1. Accessible units, Type B+NYC units, and Type B units shall be provided in Group R-1 occupancies in accordance with Sections 1107.6.1.1 through 1107.6.1.3.

Exception: Boarding houses, dormitories, fraternity houses and sorority houses in Group R-1 occupancies shall comply with Section 1107.6.1.4.

1107.6.1.1 Accessible units. ~~[In Group R-1 occupancies,]~~ Accessible dwelling units and sleeping units shall be provided in accordance with Table 1107.6.1.1.~~[AH]~~ Where buildings contain more than 50 dwelling units or sleeping units, the number of Accessible units shall be determined per building. Where buildings contain 50 or fewer dwelling units or sleeping units, all dwelling units and sleeping units ~~[in Group R-1 occupancies]~~ on a site shall be considered to determine the total number of Accessible units. Accessible units shall be dispersed among the various classes of units. Roll-in showers provided in Accessible units shall include a permanently mounted folding shower seat.

**TABLE 1107.6.1.1
ACCESSIBLE DWELLING UNITS AND SLEEPING UNITS**

TOTAL NUMBER OF UNITS PROVIDED	MINIMUM REQUIRED NUMBER OF ACCESSIBLE UNITS WITHOUT ROLL-IN SHOWERS	MINIMUM REQUIRED NUMBER OF ACCESSIBLE UNITS WITH ROLL-IN SHOWERS	TOTAL NUMBER OF REQUIRED ACCESSIBLE UNITS
1 to 25	1	0	1
26 to 50	2	0	2
51 to 75	3	1	4
76 to 100	4	1	5
101 to 150	5	2	7
151 to 200	6	2	8
201 to 300	7	3	10
301 to 400	8	4	12
401 to 500	9	4	13
501 to 1,000	2% of total	1% of total	3% of total
Over 1,000	20, plus 1 for each 100, or fraction thereof, over 1,000	10 plus 1 for each 100, or fraction thereof, over 1,000	30 plus 2 for each 100, or fraction thereof, over 1,000

1107.6.1.2 Type B+NYC units. In structures with four or more dwelling units or sleeping units intended to be occupied as a residence, every dwelling unit and sleeping unit intended to be occupied as a residence and not required to be an Accessible unit shall be a Type B+NYC unit unless the number of Type B+NYC units is permitted to be reduced in accordance with Section 1107.7.4. Where no Type B+NYC units are required per Section 1107.7.4, all units not required to be Accessible units shall be Type B units.

Exception: The number of Type B units is permitted to be reduced in accordance with Section 1107.7.

1107.6.1.3 Doors and doorways. In all units, including those not required to be Accessible units, Type B+NYC units, or Type B units, entrances, [7] doors, and doorways providing user passage into and within units shall comply with Section 404.2.2 (Clear Width) of ICC A117.1.

1107.6.1.4 Boarding houses, dormitories, fraternity houses and sorority houses in Group R-1. Accessible units and Type B+NYC units shall be provided in boarding houses, dormitories, fraternity houses and sorority houses in Group R-1 occupancies in accordance with Sections 1107.6.1.4.1 and 1107.6.1.4.2. Where the building or part thereof contains sleeping units where residents share bathroom or kitchen facilities, or both, bedrooms shall be counted as sleeping units for the purpose of determining the number of units. Where the sleeping units are grouped in suites, only one sleeping unit in each suite shall be permitted to count towards the number of required Accessible units.

1107.6.1.4.1 Accessible units. Accessible dwelling units and sleeping units shall be provided in accordance with Table 1107.6.1.1.

1107.6.1.4.2 Type B+NYC units. Every dwelling unit and every sleeping unit not required to be an Accessible unit shall be a Type B+NYC unit unless the number of Type

B+NYC units is permitted to be reduced in accordance with Section 1107.7.4. Where no Type B+NYC units are required in accordance with Section 1107.7.4, all units shall be Type B units.

Exception: The number of Type B units is permitted to be reduced in accordance with Section 1107.7.

1107.6.2 Group R-2. Type B+NYC units and Type B units shall be provided in [~~occupancies in~~] Group R-2 occupancies in accordance with Section 1107.6.2.1.

1107.6.2.1 [~~Type B and~~] Type B+NYC units. Every dwelling unit and sleeping unit shall be a Type B+NYC unit.

Exception: [~~unless the~~] The number of Type B+NYC units is permitted to be reduced in accordance with Section 1107.7.4.

1107.6.2.2 Type B units. Where no Type B+NYC units are required in accordance with Section 1107.7.4, all units intended to be occupied as a residence shall be Type B units.

[~~Exception~~] Exceptions:

1. The number of Type B units is permitted to be reduced in accordance with Section 1107.7.
2. Buildings containing fewer than four dwelling units or sleeping units need not provide Type B units.

1107.6.3 Group R-3. In Group R-3 occupancies where there are four or more dwelling units or sleeping units intended to be occupied as a residence in a single structure, every dwelling unit and sleeping unit intended to be occupied as a residence shall be a Type B unit.

Exception: The number of Type B units is permitted to be reduced in accordance with Section 1107.7.

1107.7 General exceptions for Type B units. Where specifically permitted by Section 1107.6, the required number of Type B units is permitted to be reduced in accordance with Sections 1107.7.1 through 1107.7.3.

1107.7.1 Structures without elevator service where Type B units are required. Where no elevator service is provided in a structure or required by other sections of this code,^[5] only the dwelling units and sleeping units that are located on stories indicated in Sections 1107.7.1.1 and 1107.7.1.2 are required to be Type B units.

1107.7.1.1 One story with Type B units required. At least one story containing dwelling units or sleeping units intended to be occupied as a residence shall be provided with an accessible entrance and accessible route from the exterior of the structure and all units intended to be occupied as a residence on that story shall be Type B units.

1107.7.1.2 Other stories with Type B units required. If other stories containing dwelling

units or sleeping units intended to be occupied as a residence are served by a building entrance that is in proximity to arrival points as indicated in Items 1 and 2, such building entrance shall be accessible and all dwelling units and sleeping units intended to be occupied as a residence served by that entrance on that story shall be Type B units.

1. Where the slopes of the undisturbed site measured between the planned entrance and all vehicular or pedestrian arrival points within 50 feet (15 240 mm) of the planned entrance are 10 percent or less, and
2. Where the slopes of the planned finished grade measured between the entrance and all vehicular or pedestrian arrival points within 50 feet (15 240 mm) of the planned entrance are 10 percent or less.

Where no such arrival points are within 50 feet (15 240 mm) of the entrance, the closest arrival point shall be used unless that arrival point serves the story required by Section 1107.7.1.1.

1107.7.2 Multistory units where Type B units are required. A multistory dwelling unit or sleeping unit ~~[which]~~ that is not provided with elevator service is not required to be a Type B unit. Where a multistory unit is provided with external elevator service to only one floor, the floor provided with elevator service shall be the primary entry to the unit, shall comply with the requirements for a Type B unit and, where provided within the unit, a living area, a kitchen and a toilet facility shall be provided on that floor.

1107.7.3 Elevator service to the lowest story with Type B units. Where elevator service in the building ~~[is provided for the sole purpose of complying with the provisions of Section 1107.7.1.1 to serve as]~~ provides an accessible route only to the lowest story containing dwelling units or sleeping units intended to be occupied as a residence, only the units on that story that are intended to be occupied as a residence on the lowest story served by the elevator are required to be Type B units.

1107.7.4 General exceptions for Type B+NYC units. Where specifically permitted by Sections 1107.5 and 1107.6, the required number of Type B+NYC units is permitted to be reduced in accordance with Section 1107.7.4.1.

1107.7.4.1 Buildings or structures without elevator service where Type B+NYC units are required. In buildings or structures where no elevator service is provided or required by other sections of this code, only the dwelling units and sleeping units that are located on stories indicated in Section 1107.7.4.1.1 are required to be Type B+NYC units.

1107.7.4.1.1 Units located in the cellar, basement, or first floor. In buildings or structures where the lowest story containing dwelling or sleeping units is the cellar, basement, or first floor, at least one such story containing dwelling or sleeping units, regardless of intent to occupy as a residence, shall be provided with an accessible entrance and accessible route from the exterior of the building or structure and all units on that story, regardless of intent to occupy as a residence, shall be Type B+NYC units. Where no dwelling units or sleeping units are located in the cellar, basement, or first floor, Type B units shall be provided where required by Section 1107.7.1 through 1107.7.3.

Exceptions:

1. Buildings containing fewer than four dwelling units or sleeping units need not provide Type B units.
2. Group R-2 occupancies in buildings with first occupancy on or before March 13, 1991 need not provide Type B units.

**SECTION BC 1108
SPECIAL OCCUPANCIES**

1108.1 General. In addition to the other requirements of this chapter and applicable provisions of Appendices E and N, the requirements of Sections 1108.2 through ~~[1108.4]~~ 1108.5 shall apply to specific occupancies.

1108.2 Assembly area seating. Assembly areas with seating shall comply with Sections 1108.2.1 through ~~[1108.2.8]~~ 1108.2.5. Lawn seating shall comply with Section 1108.2.6. Assistive listening systems shall comply with Section 1108.2.7. Performance areas viewed from assembly seating areas shall comply with Section 1108.2.8. Dining and drinking areas shall comply with Section 1108.2.9. ~~[In addition, lawn seating shall comply with Section 1108.2.6.]~~

1108.2.1 Services. If a service or facility is provided in an area that is not required to be accessible in accordance with Section 1108.2.9, the same service or facility shall be provided on an accessible level and shall be accessible.

1108.2.2 Wheelchair spaces. In theaters, bleachers, grandstands, stadiums, arenas and other assembly areas, accessible wheelchair spaces, companion seats, and designated aisle seats complying with ICC A117.1, including Section 802 (Assembly Areas), shall be provided in accordance with Sections 1108.2.2.1 through ~~[1108.2.2]~~ 1108.2.2.4 of this code. Required accessible wheelchair spaces and their companion seats as required in Section 1108.2.5 shall be delineated on the approved seating plans. Such spaces and seats which are unsold 1 day (24 hours) before the event shall be permitted to be released for sale to the public, including ~~[persons]~~ individuals without ~~[physical]~~ disabilities.

1108.2.2.1 General seating. Wheelchair spaces shall be provided in accordance with Table 1108.2.2.1.

**TABLE 1108.2.2.1
ACCESSIBLE WHEELCHAIR SPACES**

CAPACITY OF SEATING IN ASSEMBLY AREAS	MINIMUM REQUIRED NUMBER OF WHEELCHAIR SPACES
4 to 25	1
26 to 50	2
51 to 100	4
101 to 300	5
301 to 500	6
501 to 5,000	6, plus 1 for each 150, or fraction thereof, between 501 through 5,000
5,001 and over	36 plus 1 for each 200, or fraction thereof, over 5,000

1108.2.2.2 Luxury boxes, club boxes and suites. In each luxury box, club box^[7] and suite within arenas, stadiums and grandstands, wheelchair spaces shall be provided in accordance with Table 1108.2.2.1.

1108.2.2.3 Other boxes. In boxes other than those required to comply with Section 1108.2.2.2, the total number of wheelchair spaces provided shall be determined in accordance with Table 1108.2.2.1. Wheelchair spaces shall be located in not less than 20 percent of all boxes provided.

~~**1108.2.2.4 Team or player seating.** At least one wheelchair space shall be provided in team or player seating areas serving areas of sport activity.]~~

~~[**Exception:** Wheelchair spaces shall not be required in team or player seating areas serving bowling lanes that are not required to be located on an accessible route in accordance with Section 1109.14.4.1.]~~

1108.2.3 Companion seats. At least one companion seat complying with ICC A117.1, including Section 802.7 (Companion Seat), shall be provided for each wheelchair space required by Sections 1108.2.2.1 through 1108.2.2.3 of this code.

1108.2.4 Dispersion of wheelchair spaces in multilevel assembly seating areas. In multilevel assembly seating areas, wheelchair spaces shall be provided on the main floor level and on one of each two additional floor or mezzanine levels. Wheelchair spaces shall be provided in each luxury box, club box and suite within assembly facilities.

Exceptions:

1. In multilevel assembly ~~[spaces]~~ seating areas utilized as place of religious worship where the second floor or mezzanine level contains 25 percent or less of the total seating capacity, wheelchair spaces shall be permitted to all be located on the main level.
2. In multilevel assembly seating areas where the second floor or mezzanine level provides 25 percent or less of the total seating capacity and 300 or fewer seats, all wheelchair spaces shall be permitted to be located on the main level.

3. Wheelchair spaces in team or player seating serving areas of sport activity are not required to be dispersed.

1108.2.5 Designated aisle seats. At least ~~[five]~~ 5 percent, but not less than one, of the total number of aisle seats provided shall be designated aisle seats~~;~~ and shall be the aisle seats located closest to accessible routes, and shall comply with ICC A117.1, including Section 802.8 (Designated Aisle Seats).

Exception: Designated aisle seats are not required in team or player seating serving areas of sport activity.

1108.2.6 Lawn seating. Lawn seating areas and exterior overflow seating areas, where fixed seats are not provided, shall connect to an accessible route.

1108.2.7 Assistive listening systems. Each building, room or space used for assembly [area] purposes where audible communications are integral to the use of the space, regardless of the occupancy load of such space, shall have an assistive listening system in compliance with ICC A117.1, including Section 706 (Assistive Listening Systems) and Appendix N of this code.

Exception: Other than in courtrooms, an assistive listening system is not required where there is no audio amplification system.

1108.2.7.1 Receivers.~~[Receivers]~~ The number and type of receivers shall be provided for assistive listening systems in accordance with Table 1108.2.7.1 of this code~~[All receivers shall be hearing-aid compatible].~~

Exceptions:

1. Where a building contains more than one room or space used for assembly [area] purposes, the total number of required receivers shall be permitted to be calculated ~~[according to]~~ based on the total number of seats in the ~~[assembly areas in the]~~ building, provided that all receivers are usable with all systems~~;~~ and if the rooms or spaces used for assembly [areas] purposes required to provide assistive listening are under one management.
2. Where all seats in ~~[an]~~ a building, room or space used for assembly [area] purposes are served by an induction loop assistive listening system, the minimum number of receivers required by Table 1108.2.7.1 of this code to be hearing-aid compatible shall not be required.

**TABLE 1108.2.7.1
RECEIVERS FOR ASSISTIVE LISTENING SYSTEMS**

CAPACITY OF SEATING IN ASSEMBLY AREAS	MINIMUM REQUIRED NUMBER OF RECEIVERS	MINIMUM NUMBER OF RECEIVERS TO BE HEARING-AID COMPATIBLE
50 or less	2	2
51 to 200	2, plus 1 per 25 seats over 50 seats*	2

CAPACITY OF SEATING IN ASSEMBLY AREAS	MINIMUM REQUIRED NUMBER OF RECEIVERS	MINIMUM NUMBER OF RECEIVERS TO BE HEARING-AID COMPATIBLE
201 to 500	2, plus 1 per 25 seats over 50 seats*	1 per 4 receivers*
501 to 1,000	20, plus 1 per 33 seats over 500 seats*	1 per 4 receivers*
1,001 to 2,000	35, plus 1 per 50 seats over 1,000 seats*	1 per 4 receivers*
Over 2,000	55, plus 1 per 100 seats over 2,000 seats*	1 per 4 receivers*

NOTE: * = or fraction thereof

1108.2.7.2 Ticket windows. Where ticket windows are provided, at least one window at each location shall have an assistive listening system.

1108.2.7.3 Public address systems. Where stadiums, arenas and grandstands provide audible public announcements, they shall also provide equivalent text information regarding events and facilities in compliance with Sections ~~[1108.2.7.2.1]~~ 1108.2.7.3.1 and ~~[1108.2.7.2.2]~~ 1108.2.7.3.2.

~~[1108.2.7.2.1]~~ **1108.2.7.3.1 Prerecorded text messages.** Where electronic signs are provided and have the capability to display prerecorded text messages containing information that is the same, or substantially equivalent, to information that is provided audibly, signs shall display text that is equivalent to audible announcements.

Exception: Announcements that cannot be prerecorded in advance of the event shall not be required to be displayed.

~~[1108.2.7.2.2]~~ **1108.2.7.3.2 Real-time messages.** Where electronic signs are provided and have the capability to display real-time messages containing information that is the same, or substantially equivalent, to information that is provided audibly, signs shall display text that is equivalent to audible announcements.

1108.2.8 Performance areas. An accessible route shall directly connect the performance area to the assembly seating area where a circulation path directly connects a performance area to an assembly seating area. An accessible route shall be provided from performance areas to ancillary areas or facilities used by performers.

1108.2.9 Dining and drinking areas. In dining and drinking areas, ~~[the total]~~ all interior and exterior floor [area allotted for seating and tables] areas shall be accessible and be on an accessible route.

Exceptions:

- ~~[In buildings or facilities not required to provide an]~~ An accessible route between accessible levels [as described in] and stories above or below is not required where permitted by Section 1104.4, Exception 1 [,-an].
- An accessible route to dining and drinking areas in a mezzanine [seating area] is not required, provided that the mezzanine contains less than ~~[33]~~ 25 percent of the total

[seating] combined area for dining and drinking and the same services, and decor are provided in the accessible area.

~~[2-]~~ 3. In sports facilities, tiered dining areas providing seating required to be accessible shall be required to have accessible routes serving at least 25 percent of the dining area, provided that accessible routes serve accessible seating and where each tier is provided with the same services and similar view.

4. Employee-only work areas shall comply with Sections 1103.2.2 and 1104.3.1.

1108.2.9.1 Dining surfaces. Where dining surfaces for the consumption of food or drink are provided, at least ~~[5]~~ 10 percent of the total number of seating and standing spaces, but not less than one, of each type of [the] dining surfaces [for the seating and standing spaces] shall be accessible and be distributed throughout the facility and located on a level ~~[connected]~~ accessed by an accessible route.

~~[Exception: Where food or drink is served at counters exceeding 34 inches (864 mm) in height, such dining surfaces shall not be required to comply with Section 1108.2.9.1 provided equivalent service is available at accessible tables or counters that are in compliance with Section 902 (Dining Surfaces and Work Surfaces) of ICC A117.1 within the same dining area.]~~

1108.2.9.2 Dining and drinking counters. Where seating is provided at dining or drinking counters, at least one 60 inch (1524 mm) long portion of the counter shall be provided with two accessible seating spaces. Such accessible seating space shall comply with Section 902 (Dining Surfaces and Work Surfaces) of ICC A117.1, and shall not be located within 40 inches (1016 mm) of either end of the counter, so as to provide individuals with disabilities with the same level of service and experience as that provided to others.

Exceptions:

1. Where the linear length of counter is 12 feet (3657.6 mm) or less, one accessible seating space shall be provided, at least 30 inches (762 mm) long, for each accessible seating space required by Section 1108.2.9.1 of this code. Such accessible seating space may be located anywhere along the counter.
2. In Group R-2 occupancies, one accessible seating space shall be provided, at least 30 inches (762 mm) long, for each accessible seating space required by Section 1108.2.9.1 of this code.

1108.3 Self-service storage facilities. Self-service storage facilities shall provide accessible individual self-storage spaces in compliance with Section 1104 of this code and ICC A117.1, including Section 905 (Storage Facilities). The number of required self-storage spaces shall be in accordance with Table 1108.3 of this code.

**TABLE 1108.3
ACCESSIBLE SELF-SERVICE STORAGE FACILITIES**

TOTAL SPACES IN FACILITY	MINIMUM NUMBER OF REQUIRED ACCESSIBLE SPACES
1 to 200	5%, but not less than 1
Over 200	10, plus 2% of total number of units over 200

1108.3.1 Dispersion. Accessible individual self-service storage spaces shall be dispersed throughout the various classes of spaces provided. Where more classes of spaces are provided than the number of required accessible spaces, the number of accessible spaces shall not be required to exceed that required by Table 1108.3. Accessible spaces are permitted to be dispersed in a single building of a multibuilding facility.

1108.4 Judicial facilities. Judicial facilities shall comply with Sections 1108.4.1 ~~[through 1108.4.3]~~ and 1108.4.2 of this code.

1108.4.1 Courtrooms. Each courtroom shall be accessible and comply with ICC A117.1, including Section 807 (Courtrooms), and Sections 1108.4.1.1 through 1108.4.1.5 of this code.

1108.4.1.1 Jury box. A wheelchair space complying with ICC A117.1 shall be provided within the jury box.

Exception: Adjacent companion seating is not required.

1108.4.1.2 Gallery seating. Wheelchair spaces complying with ICC A117.1 shall be provided in accordance with Table 1108.2.2.1 of this code. Designated aisle seats shall be provided in accordance with Section 1108.2.5 of this code.

1108.4.1.3 Assistive listening systems. An assistive listening system must be provided. Receivers shall be provided for the assistive listening system in accordance with Section 1108.2.7.1 of this code.

1108.4.1.4 Employee work stations. The judge’s bench, clerk’s station, bailiff’s station, deputy clerk’s station and court reporter’s station shall be located on an accessible route. The vertical access to elevated employee work stations within a courtroom is not required at the time of initial construction, provided a ramp, lift or elevator complying with ICC A117.1 can be installed without requiring reconfiguration or extension of the courtroom or extension of the electrical system.

1108.4.1.5 Other work stations. The litigant’s and counsel stations, including the lectern, shall be accessible in accordance with ICC A117.1.

1108.4.2 Holding cells. Central holding cells and court-floor holding cells shall comply with Sections 1108.4.2.1 and 1108.4.2.2.

1108.4.2.1 Central holding cells. Where separate central holding cells are provided for adult males, juvenile males, adult females or juvenile females, one of each type shall be accessible. Where central holding cells are provided and are not separated by age or ~~[sex]~~ gender, at least one accessible cell shall be provided.

1108.4.2.2 Court-floor holding cells. Where separate court-floor holding cells are provided for adult males, juvenile males, adult females or juvenile females, each courtroom shall be served by one accessible cell of each type. Where court-floor holding cells are provided and are not separated by age or [~~sex~~] gender, courtrooms shall be served by at least one accessible cell. Accessible cells shall be permitted to serve more than one courtroom.

~~[1108.4.3 Visiting areas. Visiting areas shall comply with Sections 1108.4.3.1 and 1108.4.3.2.]~~

~~[1108.4.3.1 Cubicles and counters. At least 5 percent, but not fewer than one, of the cubicles shall be accessible on both the visitor and detainee sides. Where counters are provided, at least one shall be accessible on both the visitor and detainee sides.]~~

~~[**Exception:** This requirement shall not apply to the detainee side of cubicles or counters at nonecontact visiting areas not serving accessible holding cells.]~~

~~[1108.4.3.2 Partitions. Where solid partitions or security glazing separate visitors from detainees, at least one of each type of cubicle or counter partition shall be accessible.]~~

1108.5 Assembly areas without seating. Assembly areas without seating shall comply with Section 1108.2.7.

SECTION BC 1109 OTHER FEATURES AND FACILITIES

1109.1 General. Accessible building features and facilities shall be provided in accordance with Sections 1109.2 through [~~1109.16~~] 1109.15 of this code.

Exception: Type B+NYC and Type B units shall comply with Section 1107 of this code and ICC A117.1.

1109.2 Toilet and bathing rooms. Each toilet room and bathing room shall be accessible. Where a floor level is not required to be connected by an accessible route, the only toilet rooms or bathing rooms provided within the facility shall not be located on the [~~in accessible~~] inaccessible floor. [~~At~~] Except as provided for in Sections 1109.2.2 and 1109.2.3 of this code, at least one of each type of fixture, element, control or dispenser in each accessible toilet room and bathing room shall be accessible.

Exceptions:

1. In nonresidential occupancies, for toilet rooms or bathing rooms accessed only through a private office, not for common or public use, and intended for use by a single occupant of such private office, any of the following alternatives are allowed:
 - 1.1. Doors are permitted to swing into the clear floor space provided the door swing can be reversed to meet the requirements in Section 603.2.2 (Door Swing) of ICC A117.1; [~~and~~]
 - 1.2. The height requirements for the water closet in Section 604.4 (Height) of ICC A117.1 are not applicable; [~~and~~]
 - 1.3. Grab bars are not required to be installed in a toilet room, provided that the reinforcement has been installed in the walls and located so as to permit the installation of such grab bars; and

- 1.4. The requirement for height, knee and toe clearance shall not apply to a lavatory.
2. This section is not applicable to dwelling units, sleeping units and patient toilet and bathing rooms that are not required to be accessible by Section 1107 of this code.
3. Where multiple single-user toilet rooms or bathing rooms are clustered to be within sight of, or adjacent to one another at a single location, at least 50 percent, but not less than one room for each use at each cluster, shall be accessible. In Group R-2 occupancies, where multiple single-user toilet rooms or bathing rooms are clustered, all such rooms must comply with the design and construction requirements of the Fair Housing Act.
4. ~~[Where]~~ In other than Group R-2 occupancies, where no more than one urinal is provided in a toilet room or bathing room, the urinal is not required to be accessible.
5. Toilet rooms or bathing rooms that are part of ~~[critical-care]~~ critical care or intensive care patient sleeping rooms servicing Accessible units are not required to be accessible.
6. Toilet rooms or bathing rooms designed for bariatrics patients are not required to comply with the toilet room and bathing room requirements in ICC A117.1. The sleeping units served by bariatrics toilet or bathing rooms shall not count toward the required number of Accessible sleeping units.
7. Where toilet facilities are primarily for children's use, required accessible water closets, toilet compartments and lavatories shall be permitted to comply with children's provision of ICC A117.1.
8. Where multiple single user portable toilet or bathing units are clustered at a single location, ~~[not less than 5]~~ at least 5 percent, but not less than one of the toilet units and bathing units at each cluster shall be accessible. Accessible portable toilet units and bathing units shall be identified by the ~~[International Symbol of Accessibility]~~ dynamic accessibility symbol complying with Section ~~[4440.4]~~ 1111.1 of this code.

1109.2.1 Family or assisted-use toilet and bathing rooms. In assembly and mercantile occupancies, an accessible family or assisted-use toilet room shall be provided where an aggregate of six or more male and female water closets is required. In buildings of mixed occupancy, only those water closets required for the assembly or mercantile occupancy shall be used to determine the family or assisted-use toilet room requirement. In recreational facilities where separate-sex bathing rooms are provided, an accessible family or assisted-use bathing room shall be provided. Fixtures located within family or assisted-use toilet and bathing rooms required by this section are permitted to be included in the number of fixtures required by the ~~[New York City Plumbing Code]~~ *New York City Plumbing Code* for either the male or female occupants.

Exception: Where each separate-sex bathing room has only one shower or bathtub fixture, a family or assisted-use bathing room is not required.

1109.2.1.1 Standard. Family or assisted-use toilet and bathing rooms shall comply with Sections 1109.2.1.2 through 1109.2.1.7~~[and ICC A117.1]~~ of this code.

1109.2.1.2 Family or assisted-use toilet rooms. Family or assisted-use toilet rooms shall include only one water closet and only one lavatory. A family or assisted-use bathing room in accordance with Section 1109.2.1.3 shall be considered a family or assisted-use toilet room.

Exception: A urinal is permitted to be provided in addition to the water closet in a family or assisted-use toilet room.

1109.2.1.3 Family or assisted-use bathing rooms. Family or assisted-use bathing rooms shall include only one shower or bathtub fixture. Family or assisted-use bathing rooms shall also include one water closet and one lavatory. Where storage facilities are provided for separate-sex bathing rooms, accessible storage facilities complying with Section ~~[4109.8]~~ 1109.9 shall be provided for family or assisted-use bathing rooms.

1109.2.1.4 Location. Family or assisted-use toilet and bathing rooms shall be located on an accessible route. Family or assisted-use toilet rooms shall be located not more than one story above or below separate-sex toilet rooms. The accessible route from any separate-sex toilet room to a family or assisted-use toilet room shall not exceed 500 feet (152 m).

1109.2.1.5 Prohibited location. In passenger transportation facilities and airports, the accessible route from separate-sex toilet rooms to a family or assisted-use toilet room shall not pass through security checkpoints.

1109.2.1.6 Clear floor space. Where doors swing into a family or assisted-use toilet or bathing room, a clear floor space not less than 30 inches by 48 inches (762 mm by ~~[4249]~~ 1220 mm) shall be provided, within the room, beyond the area of the door swing.

1109.2.1.7 Privacy. Doors to family or assisted-use toilet and bathing rooms shall be securable from within the room.

1109.2.2 Water closet compartment. Where water closet compartments are provided in a toilet room or bathing room, at least ~~[one wheelchair-accessible compartment shall be provided 5 percent, but not less than one of the total number of compartments shall be wheelchair accessible.~~ Where the combined total water closet compartments and urinals provided in a toilet room or bathing room is six or more, at least ~~[one ambulatory-accessible water closet compartment shall be] 5 percent, but not less than one of the total number of compartments shall be ambulatory accessible,~~ provided in addition to the wheelchair-accessible compartment. Wheelchair-accessible and ambulatory-accessible compartments shall comply with ICC A117.1 including ~~[Section]~~ Sections 604.9 (Wheelchair Accessible Compartments) and 604.10 (Ambulatory Accessible Compartments).

1109.2.3 Lavatories. Where lavatories are provided, at least 5 percent, but not less than one, shall be accessible. Where an accessible lavatory is located within the accessible water closet compartment, at least one additional accessible lavatory shall be provided in the multicompartment toilet room outside the accessible water closet compartment. Where the total lavatories provided in a toilet room or bathing ~~[room]~~ facility is six or more, at least one lavatory with enhanced reach ranges ~~[in accordance with ICC A117.1,]~~ shall be provided.

1109.2.4 Diaper changing accommodations. In assembly ~~[group A occupancies]~~ and mercantile ~~[group M]~~ occupancies on each floor level containing a public toilet room, both male and female occupants shall have access to at least one safe, sanitary and convenient diaper changing station, deck, table or similar amenity, which shall comply with Section 603.5 (Diaper Changing Tables) of ICC A117.1.

1109.3 Sinks. Where sinks are provided, at least ~~[five]~~ 5 percent~~[,]~~ but not less than one~~[,]~~ provided in accessible spaces shall comply with ICC A117.1, including Section 606 (Lavatories and Sinks).

Exception: Mop or service sinks are not required to be accessible.

1109.4 Kitchens, kitchenettes and wet bars. Where kitchen, kitchenettes and wet bars not located within dwelling or sleeping units, are provided in accessible spaces or rooms, they shall be accessible in accordance with ICC A117.1 including Section 804 (Kitchens and Kitchenettes), and Section 1109.9 of this code for storage.

1109.5 Drinking fountains. Where drinking fountains are provided on an exterior site, on a floor or within a secured area, the drinking fountains shall be provided in accordance with Sections 1109.5.1 and 1109.5.2.[-]

1109.5.1 Minimum number. No fewer than two drinking fountains shall be provided. One drinking fountain shall comply with the requirements for people who use a wheelchair and one drinking fountain shall comply with the requirements for standing persons.

[Exception] Exceptions:

1. A single drinking fountain with two separate spouts that complies with the requirements for people who use a wheelchair and standing persons shall be permitted to be substituted for two separate drinking fountains.
2. Where drinking fountains are primarily for children's use, drinking fountains for people using wheelchairs shall be permitted to comply with the children's provisions in ICC A117.1 and drinking fountains for standing children shall be permitted to provide the spout at 30 inches (762 mm) minimum above the floor.

1109.5.2 More than the minimum number. Where more than the minimum number of drinking fountains specified in Section 1109.5.1 ~~[are] is~~ provided,~~[50 percent of the total number of drinking fountains provided shall comply with the requirements for persons who use a wheelchair and]~~ 50 percent of the total number of drinking fountains provided shall comply with the requirements for [standing persons] people who use a wheelchair and 50 percent of the total number of drinking fountains provided shall comply with the requirements for standing persons.

[Exception] Exceptions:

1. Where 50 percent of the drinking fountains yields a fraction, 50 percent shall be permitted to be rounded up or down, provided that the total number of drinking fountains complying with this section equals 100 percent of the drinking fountains.
2. Where drinking fountains are primarily for children's use, drinking fountains for people using wheelchairs shall be permitted to comply with the children's provisions in ICC A117.1 and drinking fountains for standing children shall be permitted to provide the spout at 30 inches (762 mm) minimum above the floor.

1109.5.3 Container faucets. Where a separate faucet designed for filling a container is provided at the drinking fountain pursuant to Section 410.1 of the ~~[New York City Plumbing Code]~~ New York City Plumbing Code, such container faucet shall comply with Section 606.4 of ICC A117.1.

1109.6 Saunas and steam rooms. Where provided, saunas and steam rooms shall be accessible. Such saunas and steam rooms shall comply with Section 612 of ICC A117.1.

Exception: Where saunas or steam rooms are clustered at a single location, at least 5 percent of the saunas and steam rooms, but not less than one, of each type in each cluster shall be accessible.

1109.7 Elevators. All passenger elevators on an accessible route shall be accessible and comply with ~~[3001.3]~~ ICC A117.1 and Chapter 30 of this code.

Exception: Section 407.4.6.2.2 (Arrangement) of ICC A117.1 shall not apply.

~~[1109.6.1]~~ **1109.7.1 Limited-Use/Limited-Application (LULA) elevators.** LULA elevators shall comply with Section 408 (Limited-Use/Limited-Application Elevators) of ICC A117.1 and with Part ~~[XXV]~~ 5.2 of ASME A17.1 as modified by Appendix K of this code, and shall be limited to a maximum rise of not more than 25 feet (7620 mm) ~~[] and serving not more than three contiguous levels].~~ In new construction, such LULA elevators shall be permitted:

1. To be a part of the required accessible route where either a wheelchair lift complying with Section 1109.7 is permitted or a private residence elevator complying with Section 409 (Private Residence Elevators) of ICC A117.1 is permitted;
2. To be part of the required accessible route in places of religious services; or
3. In multilevel buildings and facilities not required to have an accessible route pursuant to the exceptions in Section 1104.4.

~~[1109.6.1.1]~~ **1109.7.1.1 Prior code buildings.** In prior code buildings, LULA elevators shall comply with Section 408 (Limited-use/Limited-Application Elevators) of ICC A117.1 and with Part 5.2 of ASME A17.1 as modified by Appendix K of this code. LULA elevators shall be limited to a maximum rise of not more than 25 feet (7620 mm) and shall be permitted to be a part of the required accessible route ~~[where the total floor area of the entire building is less than 10,000 square feet (929 m²) provided such LULA elevator is limited to a maximum rise of not more than 25 feet, serves not more than three contiguous levels, and elevators are not otherwise required by Chapter 30.]~~ as follows:

1. In spaces complying with Section 1109.7.1 of this code where a LULA is permitted in new construction;
2. Where the total floor area of the entire building is less than 10,000 square feet (929 m²); or
3. Where it serves an individual occupancy of less than 10,000 square feet (929 m²) in buildings of 10,000 square feet (929 m²) or more.

1109.7.2 Destination-oriented elevators. Where destination-oriented elevators are provided, hall call consoles shall comply with Sections 1109.7.2.1 through 1109.7.2.3. Responding elevator cars shall comply with Section 1109.7.2.5.

1109.7.2.1 Hall call console number and location. Hall call consoles shall be located and provided in a number complying with Section 1109.7.2.1.1 or 1109.7.2.1.2, as applicable. Where provided, hall call consoles shall be located on accessible routes connecting to the elevator landings they serve.

Exception: Where hall call consoles are an integral part of security barriers, at least one console for each type of use at each distinct location shall be located on an accessible route

connecting to the elevator landings served by all such consoles.

1109.7.2.1.1 Transfer floors, sky lobbies and floors containing building entrances.

Elevator landings on transfer floors, sky lobbies and floors containing building entrances shall provide at least one wall-mounted hall call console adjacent to each elevator hoistway entrance. When the accessibility function button is activated, the system shall assign an elevator car located to one side (left or right) of the hall call console to be the responding elevator.

1109.7.2.1.2 Other floors. Floors other than those subject to Section 1109.7.2.1.1 shall provide one hall call console for every five elevators, or fraction thereof, on each side of the elevator landing. The hall call console shall be located immediately adjacent to one or more elevator hoistway entrances. When the accessibility function button is activated, the system shall assign the elevator car located closest to one side (left or right) of the hall call console to be the responding elevator.

1109.7.2.2 Required features. Hall call consoles shall include the features specified in this section. Consoles shall not be flush with the surrounding surfaces and shall protrude or be recessed a minimum of 3/4 inch (19 mm) and a maximum 4 inches (101.6 mm).

1109.7.2.2.1 Accessibility function button. Hall call consoles shall provide accessibility function buttons complying with Section 1109.7.2.2.1.

1109.7.2.2.1.1 Upon Activation. The accessibility function button shall be programmed to activate the audio output required by Section 1109.7.2.2.2.

1109.7.2.2.1.2 Identification. Accessibility function buttons shall be visibly and tactilely identified. The visible identification shall consist of the International Symbol of Accessibility or the dynamic accessibility symbol and shall be a minimum height of 5/8 inch (15.9 mm). The visible symbol shall contrast with its background, light-on-dark or dark-on-light. The tactile identification shall consist of three raised dots. All dots shall be the same size and shall have a base diameter of 0.059 inch (1.5 mm) minimum and 0.063 inch (1.6 mm) maximum. Dot height shall be 0.025 inch (0.6 mm) minimum and 0.037 inch (0.9 mm) maximum. The dots shall be spaced 1/4 inch (6.4 mm) at base diameter, measured center to center, and shall be arranged in the form of an equilateral triangle with the vertex pointing up.

1109.7.2.2.2 Audio output. Audio output shall be provided for floor selection and responding elevator identification. Audio output shall be initiated upon activation of the accessibility function button and shall comply with Sections 1109.7.2.2.2.1 and 1109.7.2.2.2.

1109.7.2.2.2.1 Content. Audio output shall include all the information necessary to successfully call and locate the responding elevator without the use of a visual display including, but not limited to operating instructions, floor selection options, confirmation of floor selection, responding elevator car designation, directions to the responding elevator car and error messages.

1109.7.2.2.2.2 Delivery method and volume. Audio output shall be provided through a mechanism that does not require the use of private listening devices, and that is located at the hall call console. Audio output shall commence within one second of the activation of the accessibility function button. Audio output shall be synthesized

speech or recorded or digitized human speech. Volume shall be a minimum of 10 dBA above ambient sound level, measured during peak occupancy, but shall not exceed 80 dB, measured horizontally 36 inches (914.4 mm) from the source. Audio output for floor selection shall commence at the hall call console used within one second of activation of the accessibility function button. Audio output for responding car identification shall commence when the elevator arrives and shall be repeated until the elevator doors begin to close.

1109.7.2.2.3 Visible display screen. Visible display screens, including touchscreens, shall be provided in accordance with this section.

1109.7.2.2.3.1 Contrast. Characters, numbers and symbols shall contrast with the background on which they are displayed at a ratio of 4.5:1 (relative illuminance). The background shall be solid and static.

Exception: Information unrelated to floor levels and their selection shall not be required to comply with Section 1109.7.2.2.3.1.

1109.7.2.2.3.2 Size. Characters, numbers and symbols shall be a minimum height of $\frac{5}{8}$ inch (15.9 mm).

1109.7.2.2.3.3 Duration. Elevator assignment characters and numbers shall be displayed for a minimum of five seconds.

1109.7.2.2.4 Floor selection controls. Hall call consoles shall provide a method of floor selection that does not require user vision. Input methods shall comply with Section 1109.7.2.2.4.1 or 1109.7.2.2.4.2.

1109.7.2.2.4.1 Numeric keypad. Numeric keypads shall be a minimum of $2\frac{3}{4}$ inches (69.9 mm) wide by 5 inches (127 mm) high and shall be arranged in a 12-key ascending telephone keypad layout. Individual keys shall be tactilely discernible, and the number five key shall be tactilely distinct from the other keys. Where the keypad provides an alphabetic overlay on numeric keys, the relationships between letters and digits shall conform to ITU-T Recommendation E.161.

1109.7.2.2.4.2 Step scanner. Step scanners shall consist of three horizontally arranged buttons. The center button shall serve as the “select” button and may also serve as the accessibility function button. The button to the right of the center button shall be the “up” button and the button to the left of the center button shall be the “down” button. When the “up” and “down” buttons are pressed and released, the scanner shall announce the next floor above and below, respectively. When the user releases the “up” or “down” button, the system shall pause to allow the user to press the “select” button. If the “select” button is not chosen, the system shall resume at the next floor in the sequence when the button is again depressed. In buildings with more than ten floor levels, when the “up” or “down” buttons are depressed and held for more than three seconds, the scanner shall present options for floor selection in groups of ten beginning with the next group of ten above or below the floor last announced. An interval of silence, one second minimum and two seconds maximum, shall be provided between such announcements.

Exception: Step scanners may consist of one button, where the application for construction document approval is submitted within six months after the date of

enactment of this section. The button shall serve as the “select” button and may also serve as the accessibility function button.

1109.7.2.2.5 Tactile discernibility. Accessibility function buttons and floor selection controls shall be tactilely discernible and shall be raised above surrounding surfaces. When pressed, buttons shall provide mechanical motion to indicate activation. Where a step scanner complying with Section 1109.7.2.2.4.2 is provided, the “up” and “down” arrows shall include tactilely discernible “up” and “down” arrows. The “up” and “down” arrows shall be tactilely distinct from the tactile marking on the accessibility function button.

1109.7.2.3 Hall call console arrangement. Features of hall call consoles shall be arranged in accordance with Section 1109.7.2.3. Where an accessibility function button complying with Sections 1109.7.2.2.1 and 1109.7.2.3.1 also serves as the “select” button, the provisions of Section 1109.7.2.3.2 shall not apply.

1109.7.2.3.1 Accessibility function button. The accessibility function button shall be located at a height of 36 inches (914.4 mm) minimum and a maximum of 42 inches (1066.8 mm) above the finish floor and shall be nominally centered on the hall call console.

1109.7.2.3.2 Floor selection controls. Floor selection controls shall be located above the accessibility function button and shall be no higher than 48 inches (1220 mm) above the finish floor and shall be nominally centered on the console.

1109.7.2.3.3 Display screens. Where provided, display only screens shall be located above the floor selection controls.

1109.7.2.4 Instructions. Where hall call consoles are provided, written instructions on the proper use shall be posted in a conspicuous location, adjacent to such devices. The instructions shall include, but are not limited to, operating instructions, and console features.

1109.7.2.5 Responding car. When an elevator car responds to a call following activation of the accessibility function button, it shall provide audio output complying with Section 1109.7.2.2.2. In addition, during travel, the responding car shall provide an in-car announcement of all floors on which it stops.

~~[1109.7]~~ **1109.8 Lifts.** Platform (wheelchair) lifts shall not be a part of a required accessible route in new construction except as indicated in Items 1 through [9] 10. Platform (wheelchair) lifts shall be installed in accordance with [~~Chapter 30 of this code,~~] Section 410 (Platform Lifts) of ICC A117.1, [~~and~~] ASME A18.1, and Chapter 30 of this code. Platform (wheelchair) lifts are permitted to be part of a required accessible route in new construction as follows:

1. An accessible route to a performing area and speaker platforms [~~in Group A occupancies~~].
2. An accessible route to wheelchair spaces required to comply with the wheelchair space dispersion requirements of Sections 1108.2.2 through 1108.2.6.
3. An accessible route to spaces that are not open to the general public with an occupant load of not more than five.
4. An accessible route [~~as permitted in Section 1107.2.5~~] within [~~a~~] an individual dwelling unit or sleeping unit required to be an Accessible unit, Type A unit or Type B unit.

5. An interior accessible route to jury boxes and witness stands; raised courtroom stations including judges' benches, clerks' stations, bailiffs' stations, deputy clerks' stations and court reporters' stations; and to depressed areas such as the well of the court.
6. ~~[An accessible route where existing exterior site constraints make use of a ramp or elevator infeasible as determined by the commissioner pursuant to the rules of the department.]~~
- ~~[7.]~~ An accessible route to load and unload areas serving amusement rides.
- ~~[8.]~~ 7. An accessible route to play components or soft contained play structures.
- ~~[9.]~~ 8. An accessible route to team or player seating areas serving areas of sport activity.
9. An accessible route instead of gangways serving recreational boating facilities and fishing piers and platforms.
10. An accessible route where existing exterior site constraints make the use of a ramp or elevator infeasible as determined by the commissioner pursuant to the rules of the department.

1109.8.1 Prior code buildings. In prior code buildings, platform (wheelchair) lifts installed in accordance with Section 410 (Platform Lifts) of ICC A117.1, ASME A18.1, and Chapter 30 of this code, shall be permitted to be a part of the required accessible route.

[1109.8] 1109.9 Storage. Where fixed or built-in storage elements ~~[such as]~~ including but not limited to cabinets, coat hooks, shelves, medicine cabinets, lockers, closets~~;~~ and drawers are provided in required accessible spaces, at least ~~[one of each type shall contain storage space complying with ICC A117.1]~~ 5 percent, but not less than one of each type shall be accessible.

~~[1109.8.1 Lockers.~~ Where lockers are provided in accessible spaces, at least five percent, but not less than one, of each type shall be accessible.]

1109.9.1 Equity. Accessible facilities and spaces shall be provided with the same storage elements as provided in the similar nonaccessible facilities and spaces.

~~[1109.8.2]~~ **1109.9.2 Shelving and display units.** Self-service shelves and display units shall be located on an accessible route. Such shelving and display units shall not be required to comply with reach-range provisions.

~~[1109.8.3 Coat hooks and shelves.~~ Where coat hooks and shelves are provided in toilet rooms or toilet compartments, or in dressing, fitting or locker rooms, at least one of each type shall be provided in accessible toilet rooms without toilet compartment, accessible toilet compartments, and accessible dressing, fitting and locker rooms.]

1109.9.3 Cycle storage. Cycle storage shall comply with Section 905 (Storage Facilities) of ICC A117.1 and Sections 1109.9.3.1 through 1109.9.3.4 of this code.

1109.9.3.1 Accessible cycle storage. Where cycle storage is provided, 10 percent of the total number, but not less than one, shall be a minimum of 86 inches (2184.4 mm) long and 42 inches (1066.8 mm) wide to accommodate the storage of an accessible cycle.

1109.9.3.2 Accessible route. At least one accessible route shall connect to the accessible cycle storage area.

1109.9.3.3 Turning space. A turning space shall be provided and comply with Section 304 (Turning Space) of ICC A117.1.

1109.9.3.4 Loading area. A clear floor space shall be located on the long side of the accessible cycle storage and shall comply with Section 305 (Clear Floor Space) of ICC A117.1.

[1109.9] 1109.10 Detectable warnings. Detectable warnings shall be provided where required in Sections [~~1109.9.1~~] 1109.10.1 through [~~1109.9.5~~] 1109.10.3.

[~~1109.9.1~~] 1109.10.1 Detectable warnings at passenger transit platforms. Passenger transit platform edges bordering a drop-off and not protected by platform screens or guards shall have a detectable warning.

Exception: Detectable warnings are not required at bus stops.

[~~1109.9.2~~ Detectable warnings at hazardous vehicular areas. If a walk crosses or adjoins a vehicular way, and the walking surfaces are not separated by curbs, railings, or other elements between the pedestrian areas and vehicular areas, the boundary between the areas shall be defined by a continuous detectable warning which is 36 inches (914 mm) wide.]

[~~1109.9.3~~] 1109.10.2 Detectable warnings at pools. The edges of reflecting pools and similar decorative pools without physical barriers, and in which occupants are not expected or permitted to engage in swimming, bathing, therapeutic or other physical activities, shall be provided with detectable warnings.

[~~1109.9.4~~] 1109.10.3 Detectable warnings at curb ramps. A curb ramp shall have a detectable warning. The detectable warning shall extend the full width and a depth of 24 inches (609.2 mm) along the curb ramp. The curb ramp shall comply with Section 406 of ICC A117.1.

[~~1109.9.5~~ Detectable warnings at other locations. Detectable warnings shall be located at hazardous locations on floors, doors, and stairs. Doors that lead to areas that might prove hazardous to a person who is blind, including, but not limited to, doors to leading platforms, boiler rooms, and stages, shall be made identifiable to the touch by a textured surface on the door handle, knob, pull or other operating hardware. This textured surface may be made by knurling or roughening or by material applied to the contact surface. Such textured surfaces shall not be provided for emergency exit doors or any doors other than those to hazardous areas.]

[~~1109.10~~] 1109.11 Seating at tables, counters and work surfaces. Where seating or standing space at fixed or built-in tables, counters or work surfaces is provided in accessible spaces, at least [~~5~~] 10 percent of the total number of seating and standing spaces, but not less than one of each type, shall be accessible. [~~In Group I-3 occupancy visiting areas at least 5 percent, but not less than one, cubicle or counter shall be accessible on both the visitor and detainee sides.~~]

[Exceptions] Exception:

[~~1-~~] Check-writing surfaces at check-out aisles not required to comply with Section [~~1109.11.2~~] 1109.12.2 are not required to be accessible.

[2. In Group I-3 occupancies, the counter or cubicle on the detainee side is not required to be accessible at noncontact visiting areas or in areas not serving accessible holding cells or sleeping units.]

[1109.10.1] 1109.11.1 Dispersion. Accessible fixed or built-in seating at tables, counters or work surfaces shall be distributed throughout the space or facility containing such elements and located on a level accessed by an accessible route.

1109.11.2 Visiting areas. Visiting areas in judicial facilities and Group I-3 shall comply with Sections 1109.11.2.1 and 1109.11.2.2.

1109.11.2.1 Cubicles and counters. At least 5 percent, but not less than one of the cubicles, shall be accessible on both the visitor and detainee sides. Where counters are provided, at least one shall be accessible on both the visitor and detainee sides.

Exception: This requirement shall not apply to the detainee side of cubicles or counters at noncontact visiting areas not serving Accessible unit holding cells.

1109.11.2.2 Partitions. Where solid partitions or security glazing separate visitors from detainees, at least one of each type of cubicle or counter partition shall be accessible.

[1109.11] 1109.12 Service facilities. [Customer service] Service facilities shall provide for accessible features in accordance with Sections [1109.11.1] 1109.12.1 through [1109.11.5] 1109.12.5.

[1109.11.1] 1109.12.1 Dressing, fitting and locker rooms. Where dressing rooms, fitting rooms⁷ or locker rooms are provided, at least [five] 5 percent, but not less than one, of each type of use in each cluster provided shall be accessible.

[1109.11.2] 1109.12.2 Check-out aisles. Where check-out aisles are provided, accessible check-out aisles shall be provided in accordance with Table [1109.11.2] 1109.12.2. [Where check-out aisles serve different functions, at least one accessible check-out aisle shall be provided for each function.] Where check-out aisles serve different functions, accessible check-out aisles shall be provided in accordance with Table [1109.11.2] 1109.12.2 for each function. Where check-out aisles are dispersed throughout the building or facility, accessible check-out aisles shall also be dispersed. Traffic control devices, security devices and turnstiles located in accessible check-out aisles or lanes shall be accessible.

Exception: Where the public use area is under 5,000 square feet (464.5 m²), not more than one accessible check-out aisle shall be required.

**TABLE [1109.11.2] 1109.12.2
ACCESSIBLE CHECK-OUT AISLES**

TOTAL CHECK-OUT AISLES OF EACH FUNCTION	MINIMUM NUMBER OF ACCESSIBLE CHECK-OUT AISLES OF EACH FUNCTION
1 to 4	1
5 to 8	2
9 to 15	3
Over 15	3, plus 20% of additional aisles

[1109.11.3] 1109.12.3 Point of [sales] sale and service counters. Where counters are provided for sales or distribution of goods or services, at least one of each type provided shall be accessible. Where such counters are dispersed throughout the building or facility, ~~[the]~~ accessible counters shall also be dispersed.

[1109.11.4] 1109.12.4 Food service lines. Food service lines shall be accessible. Where self-service shelves are provided, at least 50 percent, but not less than one, of each type provided shall be accessible.

[1109.11.5] 1109.12.5 Queue and waiting lines. Queue and waiting lines servicing accessible counters or check-out aisles shall be accessible.

[1109.12] 1109.13 Controls, operating mechanisms and hardware. Controls, operating mechanisms and hardware intended for operation by the occupant, including switches that control lighting and ventilation[-] and electrical convenience outlets, in accessible spaces, along accessible routes or as parts of accessible elements shall be accessible.

Exceptions:

1. Operable parts that are intended for use only by ~~[use only by]~~ service or maintenance personnel shall not be required to be accessible.
2. Electrical or communication receptacles serving a dedicated use shall not be required to be accessible.
3. Where two or more outlets are provided in a kitchen above a length of countertop that is uninterrupted by a sink or appliance, one outlet shall not be required to be accessible.
4. Floor electrical receptacles shall not be required to be accessible.
5. HVAC diffusers shall not be required to be accessible.
6. Except for light switches, where redundant controls are provided for a single element, one control in each space shall not be required to be accessible.
7. Access doors or gates in barrier walls and fences protecting pools, spas and hot tubs shall be permitted to ~~[have operable parts of the release of latch on self-latching devices at 54 inches (1370 mm) maximum and 48 inches (1219 mm) minimum above the finished floor or ground, provided the self-latching devices are not also self-locking devices, operated by means of a key, electronic opener, or integral combination lock]~~ comply with Sections 3109.4 and 3109.5.
8. Electrical panelboards in Type B+NYC units and Type B units shall not be required to be accessible.
9. Within kitchens and bathrooms, lighting controls, electrical switches and receptacle outlets are permitted to be located over cabinets with counter tops 36 inches (914.4 mm) maximum in height and 25½ inches (647.7 mm) maximum in depth.

~~[1109.12.1]~~ **1109.13.1 Operable windows.** Where operable windows are provided in rooms or spaces that are required to be accessible in accordance with Sections 1107.5.1, 1107.5.2, 1107.5.3, 1107.5.4, 1107.6.1.1, ~~[and] or~~ 1107.6.1.4.1, at least one window in each room shall be accessible and each required operable window shall be accessible. Where operable windows are provided in Type B+NYC units in accordance with Section 1107.6.2, such windows shall comply with Section 1107.2.4.

Exception: Accessible windows are not required in bathrooms or kitchens unless otherwise required in Section 1107.2.4.

~~[1109.13]~~ **1109.14 Fuel-dispensing systems.** Fuel-dispensing systems shall ~~[comply with ICC A117.1]~~ be accessible.

~~[1109.14 Recreational and sports facilities. Recreational and sports facilities shall be accessible.]~~

~~[1109.14.1 Recreational and sports facilities exceptions. Recreational and sports facilities required to be accessible shall be exempt from this chapter to the extent specified in this section.]~~

~~[1109.14.1.1 Bowling lanes. An accessible route shall be provided to at least 5 percent, but no less than one, of each type of bowling lane.]~~

~~[1109.14.1.2 Court sports. In court sports, at least one accessible route shall directly connect both sides of the court.]~~

~~[1109.14.1.3 Raised boxing or wrestling rings. Raised boxing or wrestling rings are not required to be accessible.]~~

~~[1109.14.1.4 Raised refereeing, judging and scoring areas. Raised structures used solely for refereeing, judging or scoring a sport are not required to be accessible.]~~

~~[1109.14.1.5 Raised diving boards and diving platforms. Raised diving boards and diving platforms are not required to be accessible.]~~

1109.15 Gaming machines and gaming tables. Five percent, but not less than one, of each type of gaming table provided shall be accessible and provided with a front approach. Five percent of gaming machines provided shall be accessible and provided with a front approach. Accessible gaming machines shall be distributed throughout the different types of gaming machines provided.

~~[1109.15]~~ **1109.16 Stairways.** Stairways located alongside accessible routes connecting floor levels that are not connected by an elevator shall be designed and constructed to comply with ICC A117.1 and Chapter 10 of this code.

1109.17 Refuse disposal, refuse recyclable and refuse storage rooms. Refuse disposal, refuse recyclable and refuse storage rooms intended for common-use shall comply with this section. Each room must comply with Section 304 (Turning Space), Section 305 (Clear Floor Space), Section 309 (Operable Parts) and Section 404 (Doors and Doorways) of ICC A117.1. The room door is permitted to swing into the room provided that a clear floor space not less than 30 inches by 48 inches (762 mm by 1220 mm) is provided within the room and beyond the arc of the door swing.

Exceptions:

1. An alternative design is permitted provided that all of the following conditions are met:
 - 1.1. The room shall be designed so that the wheelchair user can enter the room head on, and back out without turning or changing direction.
 - 1.2. An automatic door complying with Section 404.3 (Automatic Doors) of ICC A117.1 must be provided.
 - 1.3. The minimum doorway clear opening required by Section 404.3.1 must be increased to a minimum 36 inches (914.4 mm) in power-on and power-off mode.
 - 1.4. All controls, trash chutes, recycling bins and operating mechanisms intended for operation shall comply with Section 305 (Clear Floor Space) and Section 309 (Operable Parts) of ICC A117.1.
 - 1.5. An occupancy sensor shall be provided in the refuse room to detect the presence and the absence of occupants. Upon the detection of an occupant in the room, the door shall be maintained in the open position during the entire period of occupancy of the room. Upon the absence of an occupant in the room, the door shall automatically return to the closed position.
 - 1.6. The automatic door shall return to the closed position in the case of a power failure, upon the activation of the fire alarm systems or upon the activation of smoke detectors.
2. Controls for maintenance and service are not required to comply with this section.

SECTION BC 1110 RECREATIONAL FACILITIES

1110.1 General. Recreational facilities shall be provided with accessible features in accordance with Sections 1110.2 through 1110.4.

1110.2 Facilities serving Group R-2 and R-3 occupancies. Recreational facilities that serve Group R-2 and R-3 occupancies shall comply with Sections 1110.2.1 through 1110.2.3, as applicable.

1110.2.1 Facilities serving Accessible units. In Group R-2 occupancies where recreational facilities serve Accessible units, every recreational facility of each type serving Accessible units shall be accessible.

1110.2.2 Facilities serving Type A, Type B+NYC and Type B units in a single building. In Group R-2 and R-3 occupancies and where there are four or more dwelling units, where common recreational facilities serve a single building containing Type A, Type B+NYC units or Type B units, 25 percent, but not less than one, of each type of recreational facility shall be accessible. Every recreational facility of each type on a site shall be considered to determine the total number of each type that is required to be accessible.

1110.2.3 Facilities serving Type A, Type B+NYC and Type B units in multiple buildings. In Group R-2 and R-3 occupancies, where there are four or more dwelling units within a single structure, on a single site where multiple buildings containing Type A, Type B+NYC units or Type B units are served by common recreational facilities, 25 percent, but not less than one, of each type of recreational facility serving each building shall be accessible. The total number of each type of recreational facility that is required to be accessible shall be determined by considering every recreational facility of each type serving each building on the site.

1110.3 Other occupancies. Recreational facilities not falling within the purview of Section 1110.2 shall be accessible.

1110.4 Recreational facilities. Recreational facilities shall be accessible and shall be on an accessible route to the extent specified in this section.

1110.4.1 Area of sport activity. Each area of sport activity shall be on an accessible route and shall not be required to be accessible except as provided for in Sections 1110.4.2 through 1110.4.14.

1110.4.2 Team or player seating. At least one wheelchair space shall be provided in team or player seating areas serving areas of sport activity.

Exception: Wheelchair spaces shall not be required in team or player seating areas serving bowling lanes that are not required to be accessible in accordance with Section 1110.4.3.

1110.4.3 Bowling lanes. An accessible route shall be provided to at least 5 percent, but not less than one, of each type of bowling lane.

1110.4.4 Court sports. In court sports, at least one accessible route shall directly connect both sides of the court.

1110.4.5 Raised boxing or wrestling rings. Raised boxing or wrestling rings are not required to be accessible or to be on an accessible route.

1110.4.6 Raised refereeing, judging and scoring areas. Raised structures used solely for refereeing, judging or scoring a sport are not required to be accessible or to be on an accessible route.

1110.4.7 Animal containment areas. Animal containment areas that are not within public use areas are not required to be accessible or to be on an accessible route.

1110.4.8 Amusement rides. Amusement rides that move persons through a fixed course within a defined area shall comply with Sections 1110.4.8.1 through 1110.4.8.3.

Exception: Mobile or portable amusement rides shall not be required to be accessible.

1110.4.8.1 Load and unload areas. Load and unload areas serving amusement rides shall be accessible and be on an accessible route. Where load and unload areas have more than one loading or unloading position, at least one loading and unloading position shall be on an accessible route.

1110.4.8.2 Wheelchair spaces, ride seats designed for transfer and transfer devices. Where amusement rides are in the load and unload position, the following shall be on an accessible route.

1. The position serving a wheelchair space.
2. Amusement ride seats designed for transfer.
3. Transfer devices.

1110.4.8.3 Minimum number. Amusement rides shall provide at least one wheelchair space, amusement ride seat designed for transfer or a transfer device.

Exceptions:

1. Amusement rides that are controlled or operated by the rider are not required to comply with this section.
2. Amusement rides designed primarily for children, where children are assisted on and off the ride by an adult, are not required to comply with this section.
3. Amusement rides that do not provide seats that are built-in or mechanically fastened shall not be required to comply with this section.

1110.4.9 Recreational boating facilities. Boat slips required to be accessible by Sections 1110.4.9.1 and 1110.4.9.2 and boarding piers at boat launch ramps required to be accessible by Section 1110.4.9.3 shall be on an accessible route.

1110.4.9.1 Boat slips. Accessible boat slips shall be provided in accordance with Table 1110.4.9.1. All units on the site shall be combined to determine the number of accessible boat slips required. Where the number of boat slips is not identified, each 40 feet (12 m) of boat slip edge provided along the perimeter of the pier shall be counted as one boat slip for the purpose of this section.

Exception: Boat slips not designed for embarking or disembarking are not required to be accessible or be on an accessible route.

TABLE 1110.4.9.1
BOAT SLIPS

<u>TOTAL NUMBER OF BOAT SLIPS PROVIDED</u>	<u>MINIMUM NUMBER OF REQUIRED ACCESSIBLE BOAT SLIPS</u>
<u>1 to 25</u>	<u>1</u>
<u>26 to 50</u>	<u>2</u>
<u>51 to 100</u>	<u>3</u>
<u>101 to 150</u>	<u>4</u>
<u>151 to 300</u>	<u>5</u>
<u>301 to 400</u>	<u>6</u>
<u>401 to 500</u>	<u>7</u>
<u>501 to 600</u>	<u>8</u>

<u>TOTAL NUMBER OF BOAT SLIPS PROVIDED</u>	<u>MINIMUM NUMBER OF REQUIRED ACCESSIBLE BOAT SLIPS</u>
<u>601 to 700</u>	<u>9</u>
<u>701 to 800</u>	<u>10</u>
<u>801 to 900</u>	<u>11</u>
<u>901 to 1000</u>	<u>12</u>
<u>1001 and over</u>	<u>12, plus 1 for every 100, or fraction thereof, over 1,000</u>

1110.4.9.2 Dispersion. Accessible boat slips shall be dispersed throughout the various types of boat slips provided. Where the minimum number of accessible boat slips has been met, no further dispersion shall be required.

1110.4.9.3 Boarding piers at boat launch ramps. Where boarding piers are provided at boat launch ramps, at least 5 percent, but not less than one, of the boarding piers shall be accessible.

1110.4.10 Exercise machines and equipment. At least one of each type of exercise machine and equipment shall be on an accessible route and shall be in compliance with Section 1104 (Exercise Machines and Equipment) of ICC A117.1.

1110.4.11 Fishing piers and platforms. Fishing piers and platforms shall be accessible and be located on an accessible route and shall be in compliance with Section 1105 (Fishing Piers and Platforms) of ICC A117.1.

1110.4.12 Miniature golf facilities. Miniature golf facilities shall be accessible and shall comply with Section 1107 (Miniature Golf Facilities) of ICC A117.1.

1110.4.13 Swimming pools, wading pools, hot tubs and spas. Swimming pools, wading pools, hot tubs and spas shall be accessible and be on an accessible route.

Exceptions:

1. Catch pools or a designated section of a pool used as a terminus for a water slide flume shall not be required to provide an accessible means of entry, provided that a portion of the catch pool edge is on an accessible route.
2. Where spas or hot tubs are provided in a cluster, at least 5 percent, but not less than one spa or hot tub in each cluster, shall be accessible and be on an accessible route.
3. Swimming pools, wading pools, spas and hot tubs that are required to be accessible by Sections 1110.2.2 and 1110.2.3 are not required to provide accessible means of entry into the water.

1110.4.13.1 Raised diving boards and diving platforms. Raised diving boards and diving platforms are not required to be accessible or to be on an accessible route.

1110.4.13.2 Water slides. Water slides are not required to be accessible or to be on an accessible route.

1110.4.14 Shooting facilities with firing positions. Where shooting facilities with firing positions are designed and constructed at a site, at least 10 percent, but not less than one, of each type of firing position shall be accessible and be on an accessible route.

**SECTION BC ~~1110~~ 1111
SIGNAGE**

~~[1110.4]~~ **1111.1 Signs.** Required accessible elements shall be identified by the ~~[International Symbol of Accessibility]~~ dynamic accessibility symbol, in accordance with Figure 1111.1, at the following locations~~[:]~~.

1. Accessible parking spaces required by Section 1106.1 ~~[except where]~~.

Exception: Where the total number of parking spaces provided is ~~[no more than]~~ one, identification of the accessible parking space is not required.

2. Accessible parking spaces required by Section 1106.2.

Exception: In Group I-1, R-2 and R-3 occupancies, where parking spaces are assigned to specific dwelling units or sleeping units, identification of accessible parking spaces is not required.

3. Accessible passenger loading zones.

~~[3.— Accessible areas of rescue assistance required by Section 1007.6.]~~

4. ~~[Exterior areas of assisted rescue required by Section 1007.6.]~~

~~[5.—]~~ Accessible rooms where multiple ~~[single-user]~~ single-occupant toilet rooms or bathing rooms are clustered at a single location pursuant to Section 1109.2, Exception 3.

~~[6.— Accessible rooms where]~~ Where multiple single user portable toilet or bathing units are clustered at a single location pursuant to Section 1109.2, Exception ~~[6]~~ 8.

~~[7-]~~ 5. Accessible entrances where not all entrances are accessible. The sign, where provided, shall include a contact telephone number or instructions to gain access if an otherwise accessible building entrance is locked at all times or locked when the building is otherwise open.

~~[8-]~~ 6. Accessible check-out aisles where not all aisles are accessible. The sign, where provided, shall be above the check-out aisle in the same location as the check-out aisle number or type of check-out identification.

~~[9-]~~ 7. Family or assisted-use toilet and bathing rooms.

~~[10-]~~ 8. Accessible dressing, fitting and locker rooms where not all such rooms are accessible.

9. Accessible areas of rescue assistance in accordance with Section 1009.9.

10. Exterior areas for assisted rescue in accordance with Section 1009.9.
11. In recreational facilities, lockers that are required to be accessible in accordance with Section 1109.9.
12. Accessible seating.
- [42.] 13. Accessible portable toilets.
- [43.] 14. Public telephones.
15. Refuse Disposal and Refuse Storage Rooms.



FIGURE 1111.1
DYNAMIC ACCESSIBILITY SYMBOL

~~[410.2]~~ **1111.2 Directional signage.** Directional signage indicating the route to the nearest like accessible element shall be provided at or in close proximity to the following locations, such that ~~[a person]~~ an individual with disabilities will not be required to retrace the approach route from the inaccessible element.

1. Inaccessible building entrances.
2. Inaccessible public toilets and bathing facilities.
3. Elevators not serving an accessible route.
4. At each separate-sex toilet and bathing room indicating the location of the nearest accessible family or assisted-use toilet ~~[ø]~~ and bathing room where provided in accordance with Section 1109.2.1 of this code.

5. At exits and exit stairways serving an accessible space, but not providing an approved accessible means of egress, signage shall be provided in accordance with Section ~~[4007.10]~~ 1009.10 of this code.
6. Where drinking fountains for people using wheelchairs and drinking fountains for standing persons are not located adjacent to each other, directional signage shall be provided indicating the location of the other drinking fountains.

These directional signs shall include the ~~[International Symbol of Accessibility]~~ dynamic accessibility symbol. Such signs shall comply with either ~~[section]~~ Section 703.2, or Sections 703.3 and 703.4 of ICC A117.1 [;].

[1110.3] 1111.3 Other signs. Signage indicating special accessibility provisions shall be provided as follows:

1. Each assembly area required to comply with Section 1108.2.7 of this code shall provide a sign notifying patrons of the availability of assistive listening systems. The sign shall comply with ICC A117.1 requirements for visual characters and shall include the International Symbol of Access for Hearing Loss.

Exception: Where ticket offices or windows are provided, signs are not required at each assembly area provided that signs are displayed at each ticket office or window informing patrons of the availability of assistive listening systems.

2. At each door to an area of rescue assistance, an exterior area for assisted rescue, an egress stairway, exit passageway and exit discharge, signage shall be provided in accordance with Section ~~[4011.3]~~ 1013.4.
3. At areas of rescue assistance, signage shall be provided in accordance with Section ~~[4007.11]~~ 1009.11.
4. At exterior areas for assisted rescue, signage shall be provided in accordance with Section ~~[4007.11]~~ 1009.11.
5. At two-way communication systems, signage shall be provided in accordance with Section ~~[4007.8.2]~~ 1009.8.2.
6. ~~[Within]~~ In interior exit [enclosures,] stairways and ramps, floor level signage shall be provided in accordance with Section ~~[4022.8]~~ 1023.9.
7. At prior code buildings with one or more inaccessible entrances, signage stating that a portable ramp is available, if provided by the building, shall be provided at each inaccessible building entrance and shall contain the phone number to request such ramp. The use of a portable ramp by any building must comply with all applicable laws and any such ramp shall comply with Section 405 (Ramps) of ICC A117.1, except to the extent the commissioner has waived a requirement pursuant to section 28-313.3.1 of the Administrative Code. All signage posted pursuant to this section shall comply with Section 1110 of this code and be maintained in good

condition. Nothing in this section shall be construed to authorize the provision of a portable ramp where such provision would not otherwise be lawful.

8. Signs identifying the type of access provided on amusement rides required to be accessible by Section 1110.4.8 of this code shall be provided at entries to queues and waiting lines. In addition, where accessible unload areas also serve as accessible load areas, signs indicating the location of the accessible load and unload areas shall be provided at entries to queues and waiting lines. These directional sign characters shall meet the visual character requirements in accordance with Section 703.2 (Visual Characters) of ICC A117.1.

~~[1110.4]~~ **1111.4 Variable message signs.** Where provided in the locations in Sections ~~[1110.4.1]~~ 1111.4.1 and ~~[1110.4.2]~~ 1111.4.2 of this code, variable message signs ~~{(VMS)}~~ shall comply with the ~~[VMS]~~ variable message sign requirements of ICC A117.1.

~~[1110.4.1]~~ **1111.4.1 Transportation facilities.** Where provided in transportation facilities, variable message signs conveying transportation-related information shall comply with Section ~~[1110.4]~~ 1111.4 of this code.

~~[1110.4.2]~~ **1111.4.2 Emergency shelters.** Where provided in buildings that are designated as emergency shelters, variable message signs conveying emergency-related information shall comply with Section ~~[1110.4]~~ 1111.4 of this code.

Exception: Where equivalent information is provided in an audible manner, ~~[VMS]~~ variable message signs are not required to comply with ICC A117.1.

§ 13. Chapter 12 of the New York city building code, as added by local law number 33 for the year 2007, section 1213.2 as amended by local law number 8 for the year 2008, section 1213.1 as amended by local law number 60 for the year 2012, and sections 1202, 1203, 1205, 1206.4, 1207, 1210.1, 1210.2 and 1213.3 as amended by local law number 141 for the year 2013, is amended to read as follows:

CHAPTER 12 INTERIOR ENVIRONMENT

SECTION BC 1201 GENERAL

1201.1 Scope. The provisions of this chapter shall govern ventilation, temperature control, lighting, yards and courts, sound transmission, room dimensions, surrounding materials and rodent proofing associated with the interior spaces of buildings.

SECTION BC 1202 DEFINITIONS

1202.1 [General] Definitions. The following ~~[words and]~~ terms ~~[shall, for the purposes of this chapter and as used elsewhere]~~ are defined ~~[in this code, have the meanings shown herein.]~~ Chapter 2:

HABITABLE SPACE. ~~[All rooms and spaces within a dwelling unit in Group R or I-1, including bedrooms, living rooms, studies, recreation rooms, kitchens, dining rooms and other similar spaces.]~~

~~[**Exception:** The following spaces within a dwelling unit shall not be considered habitable spaces:]~~

~~[1. A dining space 55 square feet (5.1 m²) or less located off a living room, foyer or kitchen;]~~

~~[2. A kitchenette;]~~

~~[3. A bathroom or toilet room;]~~

~~[4. A laundry room; and]~~

~~[5. A corridor, passageway, or private hall; and a foyer used as an entrance hall in a dwelling unit: not exceeding 10 percent of the total floor area of the dwelling unit; or not exceeding 20 percent of the floor area of the dwelling unit where every habitable room is at least 20 percent larger than the required minimum room sizes established by the *New York City Housing Maintenance Code*.]~~

KITCHEN. ~~[A room with 80 square feet (7.4 m²) or more of floor area which is intended, arranged, designed or used for cooking or warming of food.]~~

KITCHENETTE. ~~[A space with less than 80 square feet (7.4 m²) of floor area which is intended, arranged, designed or used for cooking or warming of food.]~~

OCCUPIABLE SPACE. ~~[A room or enclosed space, other than a habitable space, designed for human occupancy or use in which individuals may remain for a period of time for rest, amusement, treatment, education, dining, shopping, employment, labor or other similar purposes.]~~

SUNROOM. ~~[A one-story structure attached to a building with a glazing area in excess of 40 percent of the gross area of the structure's exterior walls and roof.]~~

THERMAL ISOLATION. ~~[Physical and space conditioning separation from conditioned space(s). The conditioned space(s) shall be controlled as separate zones for heating and cooling or conditioned by separate equipment.]~~

SECTION BC 1203 VENTILATION

1203.1 General. Buildings shall be provided with ~~[natural]~~ ventilation in accordance with Section ~~[1203.4.]~~ 1203.5 of this code and ~~[/or mechanical ventilation in accordance with]~~ the *New York City Mechanical Code* ~~[and this chapter. All habitable spaces shall be provided with natural ventilation in accordance with Section 1203.4].~~

1203.2 ~~[Attic spaces]~~ Ventilation required. Enclosed attics and enclosed rafter spaces formed where ceilings are applied directly to the underside of roof framing members shall have cross ventilation for each separate space by ~~[ventilating]~~ ventilation openings protected against the entrance of rain and snow. Blocking and bridging shall be arranged so as not to interfere with the movement of air. ~~[A~~

~~minimum~~ An airspace of not less than 1 inch (25.4 mm) [of airspace] shall be provided between the insulation and the roof sheathing. The net free ventilating area shall be not less than $\frac{1}{150}$ of the area of the space ventilated. [- with 50 percent of the required ventilating area provided by ventilators located in the upper portion of the space to be ventilated at least 3 feet (914 mm) above eave or cornice vents with the balance of the required ventilation provided by eave or cornice vents.] Ventilators shall be installed in accordance with the manufacturer's instructions.

1203.2.1 Openings into attic. Exterior openings into the attic space of any building intended for human occupancy shall be protected to prevent the entry of birds, squirrels, rodents, snakes and other similar creatures. Openings for ventilation having a least dimension of not less than $\frac{1}{16}$ inch (1.6 mm) [minimum] and not more than $\frac{1}{4}$ inch (6.4 mm) [maximum] shall be permitted.~~[-]~~ Openings for ventilation having a least dimension larger than $\frac{1}{4}$ inch (6.4 mm) shall be provided with corrosion-resistant wire cloth screening, hardware cloth, perforated vinyl or similar material with openings having a least dimension of not less than $\frac{1}{16}$ inch (1.6 mm) [minimum] and not more than $\frac{1}{4}$ inch (6.4 mm) [maximum]. Where combustion air is obtained from an attic area, it shall be in accordance with Chapter 7 of the *New York City Mechanical Code*.

1203.3 Unvented attic and unvented enclosed rafter assemblies. Unvented attics and unvented enclosed roof framing assemblies created by ceilings applied directly to the underside of the roof framing members/rafters and the structural roof sheathing at the top of the roof framing members shall be permitted where all the following conditions are met:

1. The unvented attic space is completely within the building thermal envelope.
2. No interior Class I vapor retarders are installed on the ceiling side (attic floor) of the unvented attic assembly or on the ceiling side of the unvented enclosed roof framing assembly.
3. Where wood shingles or shakes are used, a minimum $\frac{1}{4}$ -inch (6.4 mm) vented airspace separates the shingles or shakes and the roofing underlayment above the structural sheathing.
4. Insulation shall be located in accordance with the following:
 - 4.1. Item 4.1.1, 4.1.2, 4.1.3 or 4.1.4 shall be met, depending on the air permeability of the insulation directly under the structural roof sheathing.
 - 4.1.1. Where only air-impermeable insulation is provided, it shall be applied in direct contact with the underside of the structural roof sheathing.
 - 4.1.2. Where air-permeable insulation is provided inside the building thermal envelope, it shall be installed in accordance with Item 4.1. In addition to the air-permeable insulation installed directly below the structural sheathing, rigid board or sheet insulation shall be installed directly above the structural roof sheathing in accordance with the R values in Table 1203.3 for condensation control.
 - 4.1.3. Where both air-impermeable and air-permeable insulation are provided, the air-impermeable insulation shall be applied in direct contact with the underside of the structural roof sheathing in accordance with Item 4.1.1 and shall be in accordance

with the R values in Table 1203.3 for condensation control. The air-permeable insulation shall be installed directly under the air-impermeable insulation.

4.1.4. Alternatively, sufficient rigid board or sheet insulation shall be installed directly above the structural roof sheathing to maintain the monthly average temperature of the underside of the structural roof sheathing above 45°F (7°C). For calculation purposes, an interior air temperature of 68°F (20°C) is assumed and the exterior air temperature is assumed to be the monthly average outside air temperature of the three coldest months.

4.2. Where preformed insulation board is used as the air-permeable insulation layer, it shall be sealed at the perimeter of each individual sheet interior surface to form a continuous layer.

Exception: Section 1203.3 does not apply to special use structures or enclosures such as swimming pool enclosures, data processing centers, hospitals or art galleries.

TABLE 1203.3
INSULATION FOR CONDENSATION CONTROL

<u>CLIMATE ZONE</u>	<u>MINIMUM R-VALUE OF AIR-IMPERMEABLE INSULATION^a</u>
<u>2B and 3B tile roof only</u>	<u>0 (none required)</u>
<u>1, 2A, 2B, 3A, 3B, 3C</u>	<u>R-5</u>
<u>4C</u>	<u>R-10</u>
<u>4A, 4B</u>	<u>R-15</u>
<u>5</u>	<u>R-20</u>
<u>6</u>	<u>R-25</u>
<u>7</u>	<u>R-30</u>
<u>8</u>	<u>R-35</u>

a. Contributes to, but does not supersede, thermal resistance requirements for attic and roof assemblies in the *New York City Energy Conservation Code*.

1203.4 Under-floor ventilation. The space between the bottom of the floor joists and the surface under any building except spaces occupied by basements or cellars shall be provided with ventilation openings through foundation walls or exterior walls. Such openings shall be placed so as to provide cross ventilation of the under-floor space.

[1203.3.1] 1203.4.1 Openings for under-floor ventilation. The [minimum] net area of ventilation openings shall be not [be] less than 1 square foot for each 150 square feet ([0-09] 304.8 mm² for each [13-9] 45 720 mm²) of [crawl-space] crawl space area. Ventilation openings shall

be covered for their height and width with any of the following materials, provided that the least dimension of the covering shall ~~[not exceed]~~ be not greater than ¼ inch (6.4 mm):

1. Perforated sheet metal plates not less than 0.070 inch (1.8 mm) thick.
2. Expanded sheet metal plates not less than 0.047 inch (1.2 mm) thick.
3. Cast-iron grilles or gratings.
4. Extruded load-bearing vents.
5. Hardware cloth of 0.035 inch (0.89 mm) wire or heavier.
6. Corrosion-resistant wire mesh, with the least dimension not ~~[exceeding]~~ greater than ⅛ inch (3.2 mm).

~~[1203.3.2]~~ **1203.4.2 Exceptions.** The following are exceptions to Sections ~~[1203.3]~~ 1203.4 and ~~[1203.3.1]~~ 1203.4.1:

1. Where warranted by climatic conditions, ventilation openings to the outdoors are not required if ventilation openings to the interior are provided.
2. The total area of ventilation openings is permitted to be reduced to $1/1,500$ of the under-floor area where the ground surface is covered with a Class I vapor retarder material and the required openings are placed so as to provide cross ventilation of the space. The installation of operable louvers, in accordance with Section ~~[1203.3.1]~~ 1203.4.1, shall not be prohibited.
3. Ventilation openings are not required where continuously operated mechanical ventilation is provided at a rate of 1.0 cubic foot per minute (cfm) for each 50 square feet (1.02 L/s for each 10 m²) of crawl space floor area and the ground surface is covered with a Class I vapor retarder.
4. Ventilation openings are not required ~~[when]~~ where the ground surface is covered with a Class I vapor retarder, the perimeter walls are insulated and the space is conditioned in accordance with the *New York City Energy Conservation Code*.
5. ~~[For buildings in areas of special flood hazard, the openings]~~ Openings for under-floor ventilation for buildings in flood hazard areas shall also comply with the additional requirements of Appendix G.

~~[1203.4]~~ **1203.5 Natural ventilation.** Natural ventilation of occupiable and habitable space shall be through openings to the outdoors. The openings shall be of a type permitted under Sections ~~[1203.4.1.1]~~ 1203.5.1.1, ~~[1203.4.1.2]~~ 1203.5.1.2, ~~[1203.4.1.3]~~ 1203.5.1.3 and ~~[1203.4.1.4]~~ 1203.5.1.4. The operating mechanism for such openings shall be provided with ready access so that the openings are readily controllable by the building occupants.

Exception: An opening providing the required dimensional operable area shall be permitted to be reduced by limiting devices in accordance with the *New York City Health Code*, provided that

the owner shall remove such limiting devices where requested by the occupant. In such cases, where required by the *New York City Health Code*, alternative means of compliance shall be provided in accordance with the *New York City Health Code*.

[1203.4.1] 1203.5.1 Ventilation area required. Ventilation areas shall be as set forth in Sections [1203.4.1.1] 1203.5.1.1 through [1203.4.1.4] 1203.5.1.4.

[1203.4.1.1] 1203.5.1.1 Occupiable spaces. Where occupiable spaces are not required to be provided with mechanical ventilation in accordance with the *New York City Mechanical Code*, natural ventilation shall be provided in accordance with Section [1203.4.1.1] 1203.5.1.1. Openings providing required natural ventilation to occupiable spaces shall be windows, doors, louvers, skylights or other similar ventilating openings.

Exceptions:

1. Bathrooms and toilet rooms in Group R or I-1 occupancies shall comply with Section [1203.4.1.3] 1203.5.1.3.
2. Kitchenettes in Group R or I-1 occupancies shall comply with Section [1203.4.1.4] 1203.5.1.4.

[1203.4.1.1.1] 1203.5.1.1.1 Minimum opening. The minimum openable area to the outdoors shall be 4 percent of the floor area of the occupiable space being ventilated.

[1203.4.1.1.2] 1203.5.1.1.2 Adjoining spaces. Where occupiable rooms and spaces without openings to the outdoors are ventilated through an adjoining room, the opening to the adjoining room shall be unobstructed and shall have an area of not less than 8 percent of the floor area of the interior room or space, but not less than 25 square feet (2.3 m²). The [minimum] openable area of the openings to the outdoors shall be based on the total floor area being ventilated.

Exception: Exterior openings required for ventilation shall be permitted to open into a sunroom or covered patio provided that the openable area between such sunroom addition or covered patio and the interior room shall have an area of not less than 8 percent of the floor area of the interior room or space, but not less than 20 square feet (1.9 m²). The [minimum] openable area of the openings to the outdoors shall be based on the total floor area being ventilated.

[1203.4.1.1.3] 1203.5.1.1.3 Openings below grade. Where openings below grade provide required natural ventilation, the outside horizontal clear space measured perpendicular to the opening shall be one and one-half times the depth of the opening. The depth of the opening shall be measured from the average adjoining ground level to the bottom of the opening.

[1203.4.1.1.4] 1203.5.1.1.4 Mezzanines. Where an interior balcony or mezzanine opens to form part of another room or space, its area shall be added to the area of the room or space in which it is located to compute the ventilation required for both spaces.

[1203.4.1.2] 1203.5.1.2 Habitable spaces. All habitable spaces shall be provided with natural ventilation in accordance with ~~[Section 1203.4.1.2]~~ this section. Openings providing required natural ventilation to habitable spaces shall be windows and/or glazed doors to the outdoors.

Exception: Group R-3 occupancies. Openable skylights opening directly to the outer air, transparent or translucent panels, or other natural light-transmitting media may be substituted for window openings in Group R-3 occupancies provided that they meet the minimum dimensional requirements of Section ~~[1203.4.1.2.1]~~ 1203.5.1.2.1.

[1203.4.1.2.1] 1203.5.1.2.1 Minimum opening. The minimum openable area to the outdoors shall be 5 percent of the floor area of the habitable space being ventilated. Every opening providing required natural ventilation shall be at least 12 square feet (1.1 m²) of glazed area, providing a minimum of 6 square feet (0.56 m²) of openable area.

Exceptions:

1. Where fresh air is furnished in any habitable room or space by mechanical means supplying a minimum of 40 cubic feet per minute (0.02 m³/s), the free openable area of the openings may be reduced to 2½ percent of the floor area but each such opening shall provide not less than 5½ square feet (0.51 m²) of openable area.
2. The minimum free openable area of a mullioned casement window shall be 5½ square feet (0.51 m²), provided that the minimum ratio of floor area to openable area is met.

[1203.4.1.2.2] 1203.5.1.2.2 Adjoining spaces. An alcove or room opening off another room or space shall be considered as a separate room in determining its requirements for ventilation.

Exceptions:

1. **Alcoves within Group R-3 dwelling units.** In Group R-3 occupancies, where an opening between the alcove and the room or space is at least 80 percent of the area of the common wall and the floor area of the alcove does not exceed twice the area of the opening, the alcove and the room opening into the alcove may be considered as a single space.
2. **Balconies, partially enclosed.** Exterior openings required for ventilation shall be permitted to open upon a partially enclosed balcony or space above a setback when:
 - 2.1. Such balcony or space faces upon a public street, space, alley, park, highway, or right of way; or upon a yard, court, plaza, or space above a setback where such yard, court, plaza, or space above a setback complies with Section 1206;

- 2.2. The maximum depth of any habitable room is 30 feet (9144 mm) measured from the outer face of the exterior wall forming the partial or full enclosure of the balcony or space;
 - 2.3. The enclosure of the balcony or space is not more than one story in height; and
 - 2.4. The front of a partially enclosed balcony or space above a setback shall be open to the outer air with an open area equal to at least 75 percent of the floor surface area of such balcony or space.
3. **Balconies, fully enclosed.** Exterior openings required for ventilation shall be permitted to open upon a fully enclosed balcony or space above a setback, including sunroom and patio covers, when:
- 3.1. Such balcony or space faces upon a public street, space, alley, park, highway, or right of way; or upon a yard, court, plaza, or space above a setback where such yard, court, plaza, or space above a setback complies with Section 1206;
 - 3.2. The maximum depth of any habitable room is 30 feet (9144 mm) measured from the outer face of the exterior wall forming the partial or full enclosure of the balcony or space;
 - 3.3. The enclosure of the balcony or space is not more than one story in height;
 - 3.4. The building is of Type I or II construction;
 - 3.5. The outer enclosing walls of the balcony or space are glazed with an area at least 50 percent of the area of the interior enclosing walls of such balcony or space; the glazing may be clear plate glass or slow burning plastic;
 - 3.6. At least 50 percent of the glazed area required by Exception 3.5 of this section is openable; and
 - 3.7. No window from any bathroom, toilet room, kitchen or kitchenette shall open on such balcony or space.
4. **Mezzanines and split-level rooms.** Where a habitable mezzanine or portion of a split-level room or space is not directly served by an opening providing natural ventilation in accordance with Section [~~1203.4.1.2~~] 1203.5.1.2, such mezzanine or space shall open for its full width with no obstruction, except for railings, to an adjoining habitable room which is provided with natural ventilation. The floor area of such mezzanine or portion of the split-level room or space shall be added to the floor area of the adjoining room to compute the required ventilation in accordance with Section [~~1203.4.1.2.1~~] 1203.5.1.2.1.

The combined space shall also comply with Section [~~1203.4.1.2.4~~] 1203.5.1.2.4. When required natural ventilation is not provided, mechanical ventilation shall be provided to the mezzanine and split-level rooms in accordance with the *New York City Mechanical Code* capable of providing 2 cubic feet per minute (0.00094 m³/s) of fresh air per 1 square foot (0.09 m²) of floor area of mezzanine.

[~~1203.4.1.2.3~~] 1203.5.1.2.3 Basements and cellars. Where openings provide natural ventilation to habitable spaces located in basements or cellars, such opening shall also comply with the applicable provisions of Sections 27-2081 through 27-2087 of the *New York City Housing Maintenance Code* and Sections 26(8) and 34 of the *New York State Multiple Dwelling Law*.

[~~1203.4.1.2.4~~] 1203.5.1.2.4 Maximum depth of room. No part of any room shall be more than 30 feet (9144 mm) from a window opening onto a street or yard unless such room also opens onto a court complying with Section 1206.

Exception: In dwelling units containing more than three habitable rooms in Group R-1 or R-2 occupancies in buildings of Type I or II construction, rooms may be greater than 30 feet (9144 mm) in depth provided that all other requirements of Section [~~1203.4.1.2~~] 1203.5.1.2 are met and that the required windows are so located as to properly light all portions of the room in accordance with Section 1205.

[~~1203.4.1.3~~] 1203.5.1.3 Bathrooms and toilet rooms in Group R and I-1 occupancies. Bathrooms [~~or~~] and toilet rooms in Group R or I-1 occupancies shall be provided with natural ventilation in accordance with Section [~~1203.4.1.3~~] 1203.5.1.3, unless provided with [~~exhaust~~] ventilation in accordance with the *New York City Mechanical Code*. Openings providing required natural ventilation shall be windows.

Exception: Openable skylights may be substituted for windows provided that the bathroom or toilet room is on the top story.

[~~1203.4.1.3.1~~] 1203.5.1.3.1 Minimum opening. The minimum openable area to the outdoors shall be 5 percent of the floor area of the space being ventilated. Every window or skylight providing required natural ventilation shall be at least 3 square feet (0.28 m²) providing a minimum of 1½ square feet (0.14 m²) of openable area.

[~~1203.4.1.3.2~~] 1203.5.1.3.2 Adjoining spaces. Natural ventilation for bathrooms and toilet rooms may not be through openings from another room or space.

Exception: A bathroom or toilet room may open onto a partially enclosed balcony or space above a setback conforming with Exception 2 of Section [~~1203.4.1.2.2~~] 1203.5.1.2.2.

[~~1203.4.1.3.3~~] 1203.5.1.3.3 Basements and cellars. Where openings provide natural ventilation to bathrooms or toilet rooms located in basements or cellars, such opening shall also comply with the applicable provisions of Sections 27-2081 through 27-2087 of

the *New York City Housing Maintenance Code* and Sections 26(8) and 34 of the *New York State Multiple Dwelling Law*.

[1203.4.1.4] 1203.5.1.4 Kitchenettes in Group R and I-1 occupancies. Kitchenettes in Group R or I-1 occupancies shall be provided with natural ventilation in accordance with Section ~~[1203.4.1.4]~~ 1203.5.1.4, unless provided with ~~[exhaust]~~ ventilation in accordance with the *New York City Mechanical Code*. Openings providing required natural ventilation shall be windows.

Exception: Openable skylights may be substituted for windows provided that:

1. The kitchenette is on the top story;
2. The skylight is 12 inches (~~[305]~~ 304.8 mm) in its least dimensions;
3. The skylight is at least 4 square feet (0.37 m²) or one-eighth of the area of the kitchenette, whichever is greater; and
4. The skylight provides ventilating openings for at least one-half of its area.

[1203.4.1.4.1] 1203.5.1.4.1 Minimum opening. The minimum openable area to the outdoors shall be 5 percent of the floor area of the space being ventilated. Every window or other opening providing required natural ventilation shall be at least 1 foot (~~[305]~~ 304.8 mm) wide and at least 3 square feet (0.28 m²) in total area, providing a minimum of 1½ square feet (0.14 m²) of openable area.

Exception: Skylights shall comply with the exception of Section ~~[1203.4.1.4]~~ 1203.5.1.4.

[1203.4.1.4.2] 1203.5.1.4.2 Adjoining spaces. Natural ventilation for kitchenettes shall not be through openings off another room or space.

Exception: A kitchenette may open onto a partially enclosed balcony or space above a setback conforming with Exception 2 of Section ~~[1203.4.1.2.2]~~ 1203.5.1.2.2.

[1203.4.1.4.3] 1203.5.1.4.3 Basements and cellars. Where openings provide natural ventilation to kitchenettes less than 80 square feet (7.4 m²) located in basements or cellars, such opening shall also comply with the applicable provisions of Sections 27-2081 through 27-2087 of the *New York City Housing Maintenance Code* and Sections 26(8) and 34 of the *New York State Multiple Dwelling Law*.

[1203.4.2] 1203.5.2 Contaminants exhausted. Contaminant sources in naturally ventilated spaces, including kitchens, kitchenettes, toilet rooms and bathing rooms, shall be ~~[removed]~~ exhausted in accordance with the *New York City Mechanical Code*.

[1203.4.2.1] 1203.5.2.1 Bathrooms. Rooms containing bathtubs, showers, spas and similar bathing fixtures in other than Group R and I-1 occupancies shall be mechanically ventilated in accordance with the *New York City Mechanical Code*, whether or not they are also provided with natural ventilation.

[1203.4.3] 1203.5.3 Openings on yards or courts. Natural ventilation shall be provided by openings to a public street, space, alley, park, highway, or right-of-way; or upon a yard, court, plaza, or space above a setback where such yard, court, plaza, or space above a setback complies with Section 1206. No such opening shall be on a recess of less than 6 feet (~~[1829]~~ 1828.8 mm) in width.

Exceptions:

1. Openings providing natural ventilation to habitable spaces located in basements or cellars shall also comply with the applicable provisions of Sections 27-2081 through 27-2087 of the *New York City Housing Maintenance Code* and Sections 26(8) and 34 of the *New York State Multiple Dwelling Law*.
2. A kitchenette, a bathroom, or a water closet compartment may be located on a recess of less than 6 feet (~~[1829]~~ 1828.8 mm) in width.

[1203.4.4] 1203.5.4 Measurement of openings. Dimensions of windows and other openings shall always be taken between stop beads or, if there are no stop beads, between the sides, head, and sill of the sash opening.

[1203.5.] 1203.6 Other ventilation and exhaust systems. Ventilation and exhaust systems for occupancies and operations involving flammable or combustible hazards or other contaminant sources as covered in the *New York City Mechanical Code* or the *New York City Fire Code* shall be provided as required by both codes.

**SECTION BC 1204
TEMPERATURE AND HUMIDITY CONTROL**

1204.1 Equipment and systems. Interior spaces intended for human occupancy shall be provided with active or passive [~~space heating~~] space heating systems capable of maintaining [~~a minimum~~] an indoor temperature as indicated in Table 1204.1 at a point 3 feet (~~[914]~~ 914.4 mm) above the finished floor. The heating capacity of heat-producing devices and equipment which are contained in the room and in constant use during occupancy may be deducted from the capacity of the heating system. Portable heating systems shall not be considered as contributing to the capacity of the heating system.

Exception: Where specific rooms or spaces are not listed, the temperature shall be determined by the requirements of the listed space to which they most nearly conform or as determined by the registered design professional.

**TABLE 1204.1
MINIMUM SPACE TEMPERATURE REQUIREMENTS^A**

ROOMS OR SPACES	MINIMUM TEMPERATURE [(F)] (<u>°F</u>)
Habitable rooms in all buildings	68
Building equipment and machinery rooms	50

ROOMS OR SPACES	MINIMUM TEMPERATURE [(F)] (°F)
Patients' rooms, bathrooms and toilet rooms, stairs and corridors in hospitals and nursing homes	As per the <i>New York State Health Code</i>
Bathrooms and toilet rooms except patients' bathrooms and toilet rooms in hospitals and nursing homes	68
Offices, waiting rooms, art galleries, museums, libraries, meeting rooms, houses of worship, classrooms, auditoriums, lecture halls, nightclubs, restaurants, theatres, locker rooms, dressing rooms, and spaces where persons are engaged in sedentary activities	68
Laboratories, light machine work, product inspections, loft buildings, shops, stores, display rooms, show rooms, sales rooms, and spaces where persons are engaged in moderate physical activities	65
Gymnasias, dance halls, skating rinks, bowling alleys, heavy assembly workrooms or shops, and spaces where persons are engaged in vigorous physical activities	60
Automotive repair shops	50
Storage areas, garages, space where work or process requires a low temperature	None
Hospital operating rooms, and recovery, labor, delivery, and nursery rooms	As per the <i>New York State Health Code</i>
Swimming pools, bath houses, and shower rooms	75

- a. Temperatures listed here are the minimum requirements of the department. However, other jurisdictional authorities may have more stringent requirements.

Exceptions:

1. Heating systems are not required when occupancy is seasonal and the rooms or buildings are not occupied between November 1st and May 1st of the following year.
2. Heating systems are not required when the processes or activities normally conducted in the space will generate sufficient heat to maintain the prescribed temperatures during the time of occupancy.
3. Spaces where strict process requirements mandate temperatures other than those cited above shall be exempt from the minimum requirements listed in Table 1204.1.

1204.2 Air conditioning. Interior spaces intended for human occupancy that are provided with air conditioning shall be provided with active or passive systems that are capable of maintaining 78°F (26°C) at 50-percent relative humidity when the outdoor air temperature is 89°F (32°C) and the coincident wet bulb temperature is 73°F (23°C). Interior spaces without air conditioning shall be provided with mechanical or natural ventilation in compliance with other subsections of this code.

1204.3 Freeze protection. All interior spaces shall be provided with active or passive systems or with methods of construction capable of preventing wet piping systems and vessels from freezing at all times, including permanently installed pipe heat tracing systems.

1204.4 System design. The heating system and air-conditioning system, as applicable, shall be designed to provide sufficient capacity to meet the temperature and humidity requirements of Section 1204 when considering the outdoor air ventilation requirements and all losses in the system and ancillary uses, such as domestic hot water, for which the system is used. The system shall be designed and installed to meet all other applicable provisions of this code.

SECTION BC 1205 LIGHTING

1205.1 General. Every room and space in every building shall be provided with artificial light in accordance with Section 1205.3. Every habitable room and space shall also be provided with natural light by means of exterior glazed openings in accordance with Section 1205.2.

Exceptions: Artificial light need not be provided in rooms or spaces:

1. Occupied exclusively during the daylight hours between 1 hour after sunrise and 1 hour before sunset, and which are provided with natural light meeting the requirements of Section 1205.2; or
2. With less than 40 square feet (3.7 m²) of floor area if they are used exclusively for storage purposes or for mechanical facilities containing no rotating or moving parts, no combustion equipment, or no other hazardous equipment.

1205.2 Natural light. Every opening providing required natural light shall be so located so as to properly light all portions of the room. Openings providing required natural light shall be windows [~~and~~] or glazed doors.

Exception: Group R-3 occupancies. Skylights, opening directly to the outer air, transparent or translucent panels, or other light-transmitting media, may be substituted for window openings in Group R-3 occupancies provided that they meet the minimum dimensional requirements of Section [~~1205.2.2~~] 1205.2.1.

1205.2.1 Minimum opening. The minimum net glazed area shall [~~not~~] be not less than 10 percent of the floor area of the room served. Every opening providing required natural light shall be at least 12 square feet (1.1 m²) of glazed area.

Exception: For Group R-3 occupancies, the net glazed area shall be not less than 10 percent of the floor area of the room served, or 12 square feet (1.1 m²), whichever is greater.

1205.2.2 Adjoining spaces. An alcove or room opening off another room or space shall be considered as a separate room in determining its requirements for natural lighting.

Exceptions:

1. **Alcoves within Group R-3 dwelling units.** In Group R-3 occupancies, where an

opening between the alcove and the room or space is at least 80 percent of the area of the common wall and the floor area of the alcove does not exceed twice the area of the opening, the alcove and the room opening into the alcove may be considered as a single space.

2. **Balconies, partially enclosed.** Exterior openings required for natural light shall be permitted to open upon a partially enclosed balcony or space above a setback when:
 - 2.1. Such balcony or space faces upon a public street, space, alley, park, highway, or right of way; or upon a yard, court, plaza, or space above a setback where such yard, court, plaza, or space above a setback complies with Section 1206;
 - 2.2. The maximum depth of any habitable room is 30 feet (9144 mm) measured from the outer face of the exterior wall forming the partial or full enclosure of the balcony or space;
 - 2.3. The enclosure of the balcony or space is not more than one story in height; and
 - 2.4. The front of a partially enclosed balcony or space above a setback shall be open to the outer air with an open area equal to at least 75 percent of the floor surface area of such balcony or space.

3. **Balconies, fully enclosed.** Exterior openings required for natural lighting shall be permitted to open upon a fully enclosed balcony or space above a setback, including thermally isolated sunroom additions and covered patios, when:
 - 3.1. Such balcony or space faces upon a public street, space, alley, park, highway, or right of way; or upon a yard, court, plaza, or space above a setback where such yard, court, plaza, or space above a setback complies with Section 1206;
 - 3.2. The maximum depth of any habitable room is 30 feet (9144 mm) measured from the outer face of the wall forming the partial or full enclosure of the balcony or space;
 - 3.3. The enclosure of the balcony or space is not more than one story in height;
 - 3.4. The building is of Type I or II construction;
 - 3.5. The outer enclosing walls of the balcony or space are glazed with an area at least 50 percent of the area of the interior enclosing walls of such balcony or space; the glazing may be clear plate glass or slow burning plastic;
 - 3.6. At least 50 percent of the glazed area required by Exception 3.5 of this section is openable; and
 - 3.7. No window from any bathroom, toilet room, kitchen or kitchenette shall open on such balcony or space.

4. **Mezzanines and split-level rooms.** Where a habitable mezzanine or portion of a split-level room or space is not directly served by an opening providing natural lighting in accordance with Section 1205.2, such space shall be open for its full width with no obstruction, except for railings, to an adjoining habitable room which is provided with such window or other opening. The floor area of the mezzanine or portion of the split level room or space shall be added to the floor area of the adjoining room to compute the required lighting in accordance with Section 1205.2.1. The combined space shall also comply with Sections 1205.2.4 and 1205.2.7.

1205.2.3 Basements and cellars. Where openings provide natural light to habitable spaces located in basements or cellars, such openings shall comply with Sections 1205.2.3.1 through 1205.2.3.2.

1205.2.3.1 Adequate adjacent space for multiple dwellings. Where rooms within a dwelling unit in a multiple dwelling are located in a cellar or a basement, such rooms shall have at least one-half of their height and all of their required window surfaces above every part of an “adequate adjacent space.” Such “adequate adjacent space” shall be open to the sky and shall be a continuous surface area not less than 30 feet (9144 mm) in its least dimension abutting at same level or directly below the exterior walls of every part of the basement and cellar portions of such dwelling unit. Such “adequate adjacent space” shall be spaces that are located on the same tax lot or plot in compliance with Section 1206.1 as the building or a public street, space, alley, park, highway or right of way and the level of such areas which abut or adjoin the habitable room shall be at least 6 inches (~~[1452]~~ 152.4 mm) below the window sills of any windows.

1205.2.3.2 Other applicable laws. Where openings provide natural lighting to habitable spaces located in basements or cellars, such opening shall comply with the applicable provisions of Sections 27-2081 through 27-2087 of the *New York City Housing Maintenance Code* and Sections 26(8) and 34 of the *New York State Multiple Dwelling Law*.

1205.2.4 Maximum depth of room. No part of any room shall be more than 30 feet (9144 mm) from a window opening on a street or yard unless such room also opens onto a legal court in compliance with Section 1206.1.

Exception: In dwelling units containing more than three habitable rooms in Group R- 1 or R-2 occupancies in buildings of Type I or II construction, rooms may be greater than 30 feet (9144 mm) in depth provided that all other requirements of Section 1205.2 are met and that the required windows are located so as to properly light all portions of the room.

1205.2.5 Openings on yards or courts. Exterior glazed openings shall open directly onto a public street, space, alley, park, highway, or right-of-way; or upon a yard, court, plaza, or space above a setback where such yard, court, plaza, or space above a setback complies with Section 1206. No such opening shall be on a recess of less than 6 feet (~~[1829]~~ 1828.8 mm) in width.

Exception: Spaces located in basements or cellars shall also comply with Section 1205.2.3.

1205.2.6 Measurement of glazed areas. Dimensions of windows and other glazed areas shall always be taken between stop beads or, if there are no stop beads, between the sides, head, and sill.

1205.2.7 Height of glazed areas. Height of glazed areas on openings providing natural light shall comply with Sections 1205.2.7.1 and 1205.2.7.2.

1205.2.7.1 Only that portion of glazed areas higher than 30 inches (9144 mm) above the floor shall be considered as providing the required natural lighting.

1205.2.7.2 The top of at least one window or other opening providing required natural lighting to a habitable room shall be a minimum of 7 feet (~~[2134]~~ 2133.6 mm) above the floor of the room or space served by the window or opening.

Exception: Mezzanines. Where the required natural lighting for a habitable mezzanine level is provided by a window(s) on the lower level in accordance with Section 1205.2.2, Exception 4, and where compliance with Section 1205.2.7.2 is not feasible on the mezzanine floor, Section 1205.2.7.2 shall not apply to such mezzanine floor provided that such window(s) is on the opposite wall from the mezzanine, and the top of such window is at least 12 inches (~~[305]~~ 304.8 mm) above the floor of the mezzanine.

1205.3 Artificial light. Artificial light shall be provided in accordance with Sections 1205.3.1 through 1205.3.5.

1205.3.1 General. Artificial light shall meet the minimum illumination standards set forth in Section 1205.3. Artificial light shall not exceed maximum energy consumption requirements, if applicable, as required by the *New York City Energy Conservation Code*.

1205.3.2 Rooms and spaces. Artificial light shall be adequate to provide an average illumination of 10 ~~[foot-candles]~~ footcandles (107 lux) over the area of the room at a height of 30 inches (762 mm) above the floor level.

1205.3.3 Stairways. Stairways within dwelling units and exterior stairways serving a dwelling unit shall have an illumination level on tread runs of not less than 1 ~~[foot-candle]~~ footcandle (11 lux). Stairs in other occupancies shall be governed by Chapter 10.

1205.3.4 Means of egress. The means of egress shall be illuminated in accordance with Section ~~[1006.4]~~ 1008. Exterior lights near entranceways to multiple dwellings shall also comply with Section 27-2040 of the *New York City Housing Maintenance Code*.

1205.3.5 Places of assembly. Places of assembly shall be illuminated in accordance with Chapter 10.

1205.4 Reserved.

1205.5 Reserved.

SECTION BC 1206 YARDS AND COURTS

1206.1 General. This section shall apply to yards and courts adjacent to exterior openings that provide required natural light or required natural ventilation. Such yards and courts shall be on the same zoning lot as the building. Where such yard or court is wholly or partially on a different tax lot from the exterior opening which the yard or court serves, a light and air easement or restrictive declaration acceptable to the commissioner shall be recorded against the tax lot or lots where such yard or court is located.

1206.2 Yards. Yards shall ~~[not]~~ be not less than the dimensions prescribed by the *New York City Zoning Resolution* and other applicable laws, rules, and regulations.

1206.2.1 Rear yard access for multiple dwellings. For multiple dwellings, there shall be direct access from the street to every rear yard through a noncombustible 2-hour fire-resistance-rated passage either in a direct line or through a court, except that the passage may be 1-hour fire-resistance-rated for dwellings not exceeding three stories in height and occupied by not more than two families on any story. Such passage shall be at least 36 inches (~~[914]~~ 914.4 mm) in clear width and 7 feet (~~[2134]~~ 2133.6 mm) in height.

Exceptions: No such passage shall be required for:

1. Buildings of Type IA or IB construction.
2. Buildings not exceeding three stories in height, and occupied by not more than one family on any story nor more than three families in all.
3. Buildings not exceeding two stories in height, and occupied by not more than two families on any story nor more than four families in all.

1206.3 Courts. Courts shall not be less than the dimensions prescribed by the *New York City Zoning Resolution* and other applicable laws, rules and regulations.

1206.3.1 Court access. Access shall be provided to the bottom of courts for cleaning purposes.

1206.3.2 Air intake. Courts more than two stories in height shall be provided with a horizontal air intake at the bottom not less than 10 square feet (0.93 m²) in area and leading to the exterior of the building unless abutting a yard or public way.

Exception: For multiple dwellings more than two stories in height, an air intake with a vertical cross-sectional area of 21 square feet (1.95 m²) and a least minimum dimension of 3 feet (~~[914]~~ 914.4 mm) shall be provided at or near the lowest level of any court, in accordance with Section 26(7)(a) of the *New York State Multiple Dwelling Law*.

1206.3.3 Court drainage. The bottom of every court shall be properly graded and drained to a public sewer or other approved disposal system complying with the *New York City Plumbing Code*. For Group R and I-1 occupancies, such grading and drainage shall also comply with Section 27-2027 of the *New York City Housing Maintenance Code*. For Group R-1, R-2 and I-1

occupancies, such grading and drainage shall also comply with Section 77 of the *New York State Multiple Dwelling Law*.

1206.3.4 Court walls for multiple dwellings. All walls enclosing courts of multiple dwellings shall be of light colored materials or shall be painted a light color.

Exceptions:

1. Outer courts that open to a street.
2. Courts that exceed the minimum dimension set forth in the *New York City Zoning Resolution* by at least 50 percent.

1206.4 Lighting in courts and yards. In Group I-1, R-1 or R-2 occupancies, all yards and courts shall be artificially illuminated with a minimum intensity of not less than 1 [~~foot-candle~~] footcandle (11 lux) measured 30 inches (762 mm) above the floor of the lowest level of such yards or courts.

Exception: Such lighting is not required in an inner court that is accessible only from the interior of the building and to which access is restricted for clean-out purposes.

**SECTION BC 1207
SOUND TRANSMISSION**

1207.1 Scope. This section shall apply to common interior walls, partitions and floor/ceiling assemblies between adjacent dwelling units, between dwelling units and adjacent mechanical equipment spaces, or between dwelling units and adjacent occupancies, and public areas such as halls, corridors, stairs or service areas.

1207.2 Air-borne sound. Walls, partitions and floor/ceiling assemblies separating dwelling units from each other, from adjacent occupancies, from public or service areas, from stairs or from mechanical equipment spaces, including boiler rooms, or elevator or other shafts shall have a sound transmission class (STC) for air-borne noise of not less than 50 based upon laboratory measurements made in accordance with ASTM E 90, or not less than 45 if field tested in accordance with ASTM E 336. Dwelling unit entrance doors shall be installed of assemblies having an STC of not less than 30 based upon laboratory measurements made in accordance with ASTM E 90. Penetrations or openings in construction assemblies for piping; electrical devices; recessed cabinets; bathtubs; soffits; or heating, ventilating or exhaust ducts shall be sealed, lined, insulated or otherwise treated to maintain the required ratings.

1207.2.1 Masonry. The sound transmission class of concrete masonry and clay masonry assemblies shall be calculated in accordance with TMS [~~0302~~] 302 or determined through testing in accordance with ASTM E 90.

1207.2.2 Machine and equipment rooms. Elevator machine rooms and machinery spaces containing equipment totaling more than 75 rated h.p. shall not be located vertically or horizontally adjacent to dwelling units unless the total sound pressure level output of all the equipment in the machine room or space is certified not to exceed the maximum sound pressure levels of Table 1207.2.1 in any octave band.

**TABLE 1207.2.1
MAXIMUM SOUND PRESSURE LEVELS FOR MACHINE ROOMS ADJACENT TO
DWELLING UNITS, MEASURED IN THE DWELLING UNIT**

OCTAVE BANDS, HZ MID-FREQUENCY	MAXIMUM SOUND PRESSURE LEVEL db ^a
	db re 0.0002 microbars
63	61
125	53
250	46
500	40
1000	36
2000	34
4000	33
8000	32

- a. The maximum sound pressure levels shall be reduced [~~five~~] 5 db in any octave band where the equipment data indicate pure tone generation. The presence of pure tones may be determined by means of one-third octave band analysis. The criterion for a significant pure tone component shall be an audible pure-tone sound together with an increase of the sound pressure level in the corresponding one-third octave band above the mean of the two adjacent one-third of at least:

Center frequency of one-third octave band:	40/125	160/250	215/500	630/1,000	1,000/10,000
Increase in sound pressure level (db):	6	4	3	2	1½

1207.3 Structure-borne sound. Floor/ceiling assemblies between dwelling units and sleeping units or between a dwelling unit or sleeping unit and a public or service area stair, exterior mechanical equipment, or other mechanical equipment space, including boiler rooms, shall be constructed of assemblies having an impact insulation class (IIC) rating of not less than 50 based upon laboratory measurements made in accordance with ASTM E 492, or not less than 45 if field tested in accordance with ASTM E 1007 in completed construction. See Chapter 30 of this code for additional sound control requirements for elevator machinery.

1207.3.1 Refuse chutes. Metal refuse chutes, metal chute supports, and [~~or~~] metal chute bracing shall be free of direct contact with the shaft enclosure and the openings provided in the floor construction. Metal chutes shall be resiliently supported at each structural support location.

Isolators shall provide a minimum static deflection of 0.3 inches (7.62 mm). All chutes shall be plumb.

1207.4 Field testing. Where conditions indicate that the installed construction or equipment does not meet the noise control prescribed in Section 1207, measurements shall be taken to determine conformance or nonconformance.

SECTION BC 1208 INTERIOR SPACE DIMENSIONS

1208.1 Minimum room widths. Habitable spaces, other than a kitchen, shall ~~not~~ be not less than 8 feet (~~[2438]~~ 2438.4 mm) in any plan dimension. Kitchens and kitchenettes shall have a clear passageway of not less than 3 feet (~~[914]~~ 914.4 mm) between counter fronts and appliances or counter fronts and walls.

Exceptions:

1. A room that complies with the requirements for natural light and natural ventilation and in addition has an unobstructed opening of not less than 60 square feet (5.6 m²) into an immediately adjoining room shall ~~not~~ be not less than 7 feet (~~[2134]~~ 2133.6 mm) in any plan dimension.
2. A habitable dining space that complies with the requirements for natural light and natural ventilation may be less than 8 feet (~~[2438]~~ 2438.4 mm) in any plan dimension.
3. One-half the number of bedrooms in a dwelling unit containing three or more bedrooms shall ~~not~~ be not less than 7 feet (~~[2134]~~ 2133.6 mm) in any plan dimension.
4. A room in a Group R-1 dwelling or sleeping unit shall ~~not~~ be not less than 6 feet (~~[1829]~~ 1828.8 mm) in any plan dimension.

1208.2 Minimum ceiling heights. Habitable rooms and spaces shall have a ceiling height of not less than 8 feet (~~[2438]~~ 2438.4 mm). Occupiable spaces and corridors shall have a ceiling height of not less than 7 feet 6 inches (2286 mm). Bathrooms, toilet rooms, kitchens in other than Group I-1 and R occupancies, kitchenettes in Group I-1 or R occupancies, storage rooms and laundry rooms shall ~~[be permitted to]~~ have a ceiling height of not less than 7 feet (~~[2134]~~ 2133.6 mm). All measurements shall be taken from the finished floor to the finished underside of the ceiling or ceiling beams.

Exceptions:

1. In one- and two-family dwellings, beams or girders spaced not less than 4 feet (~~[1219]~~ 1220 mm) on center may project not more than 6 inches (~~[152]~~ 152.4 mm) below the required ceiling height, provided that a clear height of 7 feet (~~[2134]~~ 2133.6 mm) is maintained.
2. Habitable rooms in basements of one- or two-family dwellings, including any projecting beams, shall have a ceiling height of not less than 7 feet (~~[2134]~~ 2133.6 mm).

3. Habitable rooms in basements of multiple dwellings may have as many as four beams crossing the ceiling if none of the beams exceeds 12 inches (~~[305]~~ 304.8 mm) in width or extends below the ceiling more than 6 inches (~~[152]~~ 152.4 mm).
4. Spaces above and below a mezzanine, other than habitable spaces, shall have a ceiling height of not less than 7 feet (~~[2134]~~ 2133.6 mm).

1208.2.1 Furred ceiling. Any room with a furred ceiling shall be required to have the minimum ceiling height in two-thirds of the area thereof, but in no case shall the height of the furred ceiling be less than 7 feet (~~[2134]~~ 2133.6 mm).

Exception: Minimum ceiling heights of habitable rooms and spaces shall ~~[not]~~ be not less than established in Section 1208.2.

1208.3 Room area. Minimum net floor areas of rooms shall be in accordance with Sections 1208.3.1 and 1208.3.2.

1208.3.1 Habitable rooms and spaces. Every habitable room or space shall have not less than 80 square feet (7.4 m²) in net floor area.

Exceptions:

1. A room that complies with the requirements for natural light and natural ventilation and in addition has an unobstructed opening of not less than 60 square feet (5.6 m²) into an immediately adjoining room shall have not less than 70 square feet (6.5 m²) of net floor area.
2. A habitable dining space, as defined by the *New York City Housing Maintenance Code*, that complies with the requirements for natural light and natural ventilation may have less than 80 square feet (7.4 m²) of net floor area.
3. A room in a Group R-1 dwelling unit shall have not less than 60 square feet (5.6 m²) of net floor area.

1208.3.2 Dwelling units. In a dwelling unit, at least one habitable room shall have not less than 150 square feet (13.9 m²) of net floor area.

Exception: Group R-1 dwelling or sleeping units.

1208.3.2.1. Single room occupancy of a single room. Where a single room within a dwelling unit is used for single room occupancy, as such term is used in Section 27-2074(e) of the *New York City Housing Maintenance Code*, such room shall have not less than 150 square feet (13.9 m²) of net floor area.

1208.3.2.2 Single room occupancy of a suite of rooms. Where two or more rooms, joined together and separated from all other rooms within a dwelling unit, are used for single room occupancy, as such term is used in Section 27-2074(e) of the *New York City Housing Maintenance Code*, at least one of such separated rooms shall have not less than 150 square feet (13.9 m²) of net floor area.

1208.4 Reserved.

**SECTION BC 1209
ACCESS TO UNOCCUPIED SPACES**

1209.1 Crawl spaces. Crawl spaces shall be provided with ~~[a minimum of]~~ not fewer than one access opening that shall be not less than 18 inches by 24 inches (~~[457]~~ 457.2 mm by ~~[610]~~ 609.6 mm). All crawl spaces shall have a minimum clear height of 18 inches (~~[457]~~ 457.2 mm).

1209.2 Attic spaces. An opening not less than 20 inches by 30 inches (508 mm by 762 mm) shall be provided to any attic area having a clear height of over 30 inches (762 mm). ~~[A]~~ Clear headroom of not less than 30~~[-inch]~~ inches (762 mm) ~~[minimum clear headroom]~~ shall be provided in the attic space ~~[shall be provided]~~ at or above the access opening.

1209.3 Mechanical appliances. Access to mechanical appliances installed in under-floor areas, in attic spaces and on roofs or elevated structures shall be in accordance with the *New York City Mechanical Code*.

**SECTION BC 1210
~~[SURROUNDING MATERIALS]~~ TOILET AND BATHROOM REQUIREMENTS**

1210.1 Required fixtures. The number and type of plumbing fixtures provided in any occupancy shall comply with the *New York City Plumbing Code*.

1210.2 Finish materials. Walls, floors and partitions in toilet and bathrooms shall comply with Sections 1210.2.1 through 1210.2.4.

1210.2.1 Floors and wall ~~[base finish materials]~~ bases. ~~[Toilet,]~~ In other than dwelling units, toilet, bathing~~[,]~~ and shower room floor finish materials shall have a smooth, hard, nonabsorbent surface. The intersections of such floors with walls shall have a smooth, hard, nonabsorbent vertical base that extends upward onto the walls ~~[at least]~~ not less than 4 inches (101.6 mm).

Exception: ~~[Occupancy Classes]~~ Group I-1, R-1 and R-2 occupancies shall have a vertical base that extends upward onto walls at least 6 inches (~~[152]~~ 152.4 mm).

~~[1210.2]~~ **1210.2.2 Walls and partitions.** Walls and partitions within 2 feet (~~[610]~~ 609.6 mm) of service sinks, urinals and water closets shall have a smooth, hard, nonabsorbent surface, to a height of not less than 4 feet (~~[1219]~~ 1220 mm) above the floor, and except for structural elements, the materials used in such walls shall be of a type that is not adversely affected by moisture.

Exceptions:

1. Dwelling units.
2. Toilet rooms that are not accessible to the public and ~~[which]~~ that have not more than one water closet.

Accessories such as grab bars, towel bars, paper dispensers and soap dishes, provided on or within walls, shall be installed and sealed to protect structural elements from moisture.

~~[1210.3]~~ **1210.2.3 Showers.** Shower compartments and walls above bathtubs with installed shower heads shall be finished with a smooth, nonabsorbent surface to a height not less than ~~[70]~~ 72 inches ([1778] 1828.8 mm) above the drain inlet.

~~[1210.4]~~ **1210.2.4 Waterproof joints.** Built-in tubs with showers shall have waterproof joints between the tub and adjacent wall.

1210.3 Privacy. Privacy at water closets and urinals shall be provided in accordance with Sections 1210.3.1 and 1210.3.2.

1210.3.1 Water closet compartment. Each water closet utilized by the public or employees shall occupy a separate compartment with walls or partitions and a door enclosing the fixtures for privacy.

Exceptions:

1. Water closet compartments shall not be required in a single-occupant toilet room with a lockable door.
2. Toilet rooms located in child day care facilities and containing two or more water closets shall be permitted to have one water closet without an enclosing compartment.
3. This provision is not applicable to toilet areas located within Group I-3 occupancy housing areas.

1210.3.2 Urinal partitions. Each urinal utilized by the public or employees shall occupy a separate area with walls or partitions to provide privacy. The walls or partitions shall begin at a height not more than 12 inches (304.8 mm) from and extend not less than 60 inches (1524 mm) above the finished floor surface. The walls or partitions shall extend from the wall surface at each side of the urinal not less than 18 inches (457.2 mm) or to a point not less than 6 inches (152.4 mm) beyond the outermost front lip of the urinal measured from the finished backwall surface, whichever is greater.

Exceptions:

1. Urinal partitions shall not be required in a single-occupant or family or assisted-use toilet room with a lockable door.
2. Toilet rooms located in child day care facilities and containing two or more urinals shall be permitted to have one urinal without partitions.

~~[1210.5]~~ **1210.4 Toilet rooms.** Toilet rooms shall not open directly into a room used for the preparation of food for service to the public. In multiple dwellings no toilet room or bathroom shall open onto any kitchen or kitchenette.

**SECTION BC 1211
KITCHENS AND KITCHENETTES**

1211.1 Sleeping. No kitchen or kitchenette shall be occupied for sleeping purposes.

1211.2 Kitchenettes in multiple dwellings. Except at entrances thereto, every kitchenette in a multiple dwelling shall be surrounded by partitions extending from floor to ceiling, and/or by a soffit dropped 1 foot (~~[305]~~ 304.8 mm) from the ceiling.

**SECTION BC 1212
~~[RODENT-PROOFING]~~ RODENTPROOFING**

1212.1 General. ~~[Rodent-proofing]~~ Rodentproofing shall be in accordance with Appendix F.

**SECTION BC 1213
REFUSE AND RECYCLABLE STORAGE**

1213.1 General. Multiple dwellings shall comply with Section 81 of the *New York State Multiple Dwelling Law* and Section 27-2021 of the *New York City Housing Maintenance Code*. In Group R-2 occupancies, space shall be provided for the storage of refuse and recyclables as a common accessory space. The location of such refuse and recyclables storage space shall be clearly identified on the construction documents and configured to permit separate unobstructed access by building personnel to stored refuse and recyclables. Such refuse and recyclables storage space shall be a minimum of 1.5 square feet (0.140 m²) per dwelling unit, or a minimum of 350 square feet (32.516 m²), whichever is less, for the storage of collected refuse and recyclables.

Exceptions:

1. In multiple dwellings required to have a compactor in accordance with Section 1213.2, such refuse and recyclables storage space shall be, in addition to space required for equipment or circulation, a minimum of 1.0 square foot (0.094 m²) per dwelling unit, or a minimum of 350 square feet (32.516 m²), whichever is less, for the storage of collected refuse and recyclables.
2. Refuse and recyclables storage space shall not be required in multiple dwellings equipped with a chute system that provides for source separation of refuse and recyclable materials without cross contamination and an integrated mechanical system to transport such materials off-site that has been approved by the commissioner.

1213.1.1 Interior space. Where an interior room is provided for the storage of refuse and recyclables, such room shall be completely enclosed by construction that has a fire-resistance rating of not less than 2 hours, with self-closing opening protective having a fire protection rating of not less than 1½ hours.

1213.1.2 Exterior space. Where space is provided on the exterior of a building for the storage of refuse and recyclables, such refuse and recyclables storage space shall include a minimum of 4 square feet (0.372 m²) in addition to the space per dwelling unit required by Section 1213.1, shall

be clearly identified on the construction documents, and shall not be located in the public right-of-way.

1213.2 Compactor. A refuse compacting system shall be provided in multiple dwellings in a [~~Groups~~] Group I-1 or R-2 occupancy that are four or more stories in height and contain 12 or more dwelling units, and in buildings of any size occupied as a Group R-1 multiple dwelling. Such system shall be located within a refuse storage room constructed in accordance with Section 1213.1 or in a refuse chute termination room constructed in accordance with Section [~~707.13.4~~] 713.13.4. The floor within such room shall be constructed of concrete and shall be sloped to a floor drain connected to the building sewer. A hose connection shall be provided within such room.

1213.3 Refuse chute. A multiple dwelling that is five or more stories in height and that contains 9 or more dwelling units shall be provided with a refuse chute, refuse chute access rooms, and refuse chute termination room constructed in accordance with Section [~~707.13~~] 713.13. A minimum of 5 square feet (0.470 m²) of floor area within each refuse chute access room shall be provided for the temporary holding of recyclables. Such floor area shall be clearly identified on the construction documents. In Group I-1 and R-1 occupancies, access to the chute access room shall be permitted to be restricted to employees provided that separate refuse storage rooms are located on each story for general occupant use.

Exceptions:

1. In buildings without an elevator, floor area within refuse chute access rooms for the temporary holding of recyclables is not required.
2. In buildings equipped with separate chutes designated for refuse, for paper and cardboard, and for metal, glass and plastic, and in buildings equipped with a chute system that provides for source separation of recyclable materials without cross contamination, floor area within refuse chute access rooms for the temporary holding of recyclables is not required. Chutes for designated recyclable materials shall be constructed in accordance with Section [~~707.13~~] 713.13 of this code.
3. The refuse chute and the occupant use storage rooms shall not be required in transient hotels meeting the following requirements:
 - 3.1. the refuse is removed from rooms by a daily cleaning service, with the staff using a service elevator that is not accessed by hotel guests;
 - 3.2. the building is of [~~Group~~] Type I or [~~Group~~] Type II construction; or
 - 3.3. a compactor and refuse storage room is provided in accordance with Section 1213.2.

1213.3.1 Refuse chute access room floor and wall base finish materials. Refuse chute access rooms shall have a smooth, hard and nonabsorbent surface. The intersection of such floors with walls shall have a smooth, hard and nonabsorbent vertical base that extends upward onto the walls at least 4 inches (101.6 mm).

§ 15. Chapter 14 of the New York city building code, as amended by local law number 141 for the year 2013, is amended to read as follows:

**CHAPTER 14
EXTERIOR WALLS**

**SECTION BC 1401
GENERAL**

1401.1 Scope. The provisions of this chapter shall establish the minimum requirements for exterior: walls; wall coverings; wall openings; windows and doors; architectural trim; balconies; projections; and other appendages.

1401.2 Construction documents. Construction documents for exterior wall coverings required to be tested in accordance with NFPA 285 pursuant to this code shall include the following data and information:

1. Design documentation of the NFPA 285 tested assembly from the manufacturer shall be included in the construction documents. This shall include section and elevation drawings that identify materials and components of the tested assembly, including panel sizes and joint locations. All components used in the tested assembly shall be clearly identified. Material thicknesses, relative locations of components and offsets shall be fully dimensioned.
2. Information shall be provided for verification in accordance with Sections 1706.16 and 1705.20 special inspections.
3. A certification by the applicant that “Any deviation which occurs during the course of installation will be evaluated and approved by the applicant of record or registered design professional. No deviation shall be approved that would result in an assembly that would otherwise fail to pass the acceptance criteria of NFPA 285.”

**SECTION BC 1402
DEFINITIONS**

1402.1 [General] Definitions. ~~The following [words and terms shall, for the purposes of this chapter and as used elsewhere in this code, have the meanings shown herein.]~~ terms are defined in Chapter 2:

ADHERED MASONRY VENEER.~~[Veneer secured and supported through the adhesion of an approved bonding material applied to an approved backing.]~~

ANCHORED MASONRY VENEER.~~[Veneer secured with approved mechanical fasteners to an approved backing.]~~

BACKING.~~[The wall or surface to which the veneer is secured.]~~

BIRD FRIENDLY MATERIAL. ~~[A material or assembly that has, or has been treated to have a maximum threat factor of 25 in accordance with the American Bird Conservancy Bird Collision Deterrence Material Threat Factor Reference Standard, or with the American Bird Conservancy Bird-~~

friendly Materials Evaluation Program at Carnegie Museum's Avian Research Center test protocol, or with a relevant ASTM standard.]

BIRD HAZARD INSTALLATIONS. [~~Monolithic glazing installations that provide a clear line of sight on the exterior of buildings, including, but not limited to, glass awnings, glass handrails and guards, glass wind break panels, or glass acoustic barriers.~~]

CURTAIN WALL. [~~A curtain wall or panel wall system is a nonload-bearing building wall, in skeleton frame construction attached and supported to the structure at every floor or other periodic locations. Assemblies may include glass, metal, precast concrete or masonry elements arranged so as not to exert common action under load and to move independently of each other and the supporting structure.~~]

EXTERIOR INSULATION AND FINISH SYSTEMS (EIFS). [~~EIFS are nonstructural, nonload-bearing, exterior wall cladding systems that consist of an insulation board attached either adhesively or mechanically, or both, to the substrate, an integrally reinforced base coat and a textured protective finish coat.~~]

EXTERIOR INSULATION AND FINISH SYSTEMS (EIFS) WITH DRAINAGE. [~~An EIFS that incorporates a means of drainage applied over a water resistive barrier.~~]

EXTERIOR WALL. [~~A wall, bearing or nonbearing, that is used as an enclosing wall for a building, other than a fire wall, and that has a slope of 60 degrees (1.05 rad) or greater with the horizontal plane.~~]

EXTERIOR WALL COVERING. [~~A material or assembly of materials applied on the exterior side of exterior walls for the purpose of providing a weather-resisting barrier, insulation or for aesthetics, including but not limited to, veneers, siding, exterior insulation and finish systems, architectural trim and embellishments such as cornices, soffits, facias, gutters and leaders.~~]

EXTERIOR WALL ENVELOPE. [~~A system or assembly of exterior wall components, including exterior wall finish materials, that provides protection of the building structural members, including framing and sheathing materials, and conditioned interior space, from the detrimental effects of the exterior environment.~~]

FENESTRATION.

[~~**FIBER-CEMENT SIDING.** A manufactured, fiber-reinforcing product made with an inorganic hydraulic or calcium silicate binder formed by chemical reaction and reinforced with discrete organic or inorganic nonasbestos fibers, or both. Additives that enhance manufacturing or product performance are permitted. Fiber cement siding products have either smooth or textured faces and are intended for exterior wall and related applications.~~]

FIBER-CEMENT SIDING.

FLY-THROUGH CONDITIONS. [~~One or more panels of glass that provide a clear line of sight through such elements creating the illusion of a void leading to the other side, including parallel glass elements, at a distance of 17 feet (5182 mm) or less, or a convergence of glass sides creating a perpendicular, acute or obtuse corner.~~]

HIGH-PRESSURE DECORATIVE EXTERIOR-GRADE COMPACT LAMINATE (HPL).

METAL COMPOSITE MATERIAL (MCM).~~[A factory-manufactured panel consisting of metal skins bonded to both faces of a plastic core.]~~

METAL COMPOSITE MATERIAL (MCM) SYSTEM.~~[An exterior wall covering fabricated using MCM in a specific assembly including joints, seams, attachments, substrate, framing and other details as appropriate to a particular design.]~~

POLYPROPYLENE SIDING.

PORCELAIN TILE.

veneER.~~[A facing attached to a wall for the purpose of providing ornamentation, protection or insulation, but not counted as adding strength to the wall. Veneers are nonstructural in that they do not carry any load other than their own weight.]~~

VINYL SIDING.~~[A shaped material, made principally from rigid polyvinyl chloride (PVC) that is used as an exterior wall covering.]~~

WATER-RESISTIVE BARRIER.~~[A material behind an exterior wall covering that is intended to resist liquid water that has penetrated behind the exterior wall covering from further intruding into the exterior wall assembly.]~~

**SECTION BC 1403
PERFORMANCE REQUIREMENTS**

1403.1 General. The provisions of this section shall apply to exterior walls, exterior wall coverings and components thereof.

1403.2 Weather protection. Exterior walls shall provide the building with a weather-resistant exterior wall envelope. The exterior wall envelope shall include flashing, as described in Section 1405.4. The exterior wall envelope shall be designed and constructed in such a manner as to prevent the accumulation of water within the wall assembly by providing a water-resistive barrier behind the exterior veneer, as described in Section 1404.2, and a means for draining water that enters the assembly to the exterior. Protection against condensation shall be provided as required.

Exceptions:

1. A weather-resistant exterior wall envelope shall not be required over concrete and masonry walls[-] designed to resist water penetration and detrimental effects from freeze/thaw cycling and in accordance with Chapters 19 and 21 of this code, as applicable.
2. Compliance with the requirements for a means of drainage, and the requirements of Sections 1404.2 and 1405.4 of this code, shall not be required for an exterior wall envelope that has been demonstrated through testing to resist wind-driven rain, including joints, penetrations and intersections with dissimilar materials, in accordance with ASTM E 331 under the following conditions:

- 2.1. Exterior wall envelope test assemblies shall include at least one opening, one control joint, and where required, one wall/eave interface and one wall sill. ~~[All tested]~~ Tested openings and penetrations shall be representative of the intended end-use configuration.
- 2.2. Exterior wall envelope test assemblies shall be at least 4 feet by 8 feet (~~[1219]~~ 1220 mm by ~~[2438]~~ 2438.4 mm) in size.
- 2.3. Exterior wall envelope assemblies shall be tested at a minimum differential pressure of 6.24 pounds per square foot (psf) (0.297 kN/m²) for a duration of 2 hours. The exterior wall envelope assemblies shall also be tested at a minimum differential pressure not less than 20 percent of the positive design wind load as calculated per Chapter 16, or 15 pounds per square foot (psf) (0.718 kN/m²) for a duration of 15 minutes.
- 2.4. The exterior wall envelope design shall be considered to resist wind-driven rain where the results of testing indicate that water did not penetrate the test assembly including control joints in the exterior wall envelope, joints at the perimeter of openings[;] or intersections of terminations with dissimilar materials.

3. Exterior insulation and finish systems (EIFS) complying with Section 1408.4.1.

1403.3 Structural. Exterior wall envelope, and the associated openings, shall be designed and constructed to resist safely the superimposed loads required by Chapter 16.

1403.4 Fire resistance. Exterior wall envelope shall be fire-resistance rated as required by other sections of this code with opening protection as required by Chapter 7.

1403.5 Vertical and lateral flame propagation. Exterior walls that contain foam plastic insulation including exterior insulation and finish systems (EIFS), metal composite material (MCM) systems, high-pressure decorative exterior-grade compact laminates (HPL), and fiber-reinforced polymer (FRP) shall be tested in accordance with and comply with the acceptance criteria of NFPA 285. Foam plastic insulation assemblies and FRP shall be tested in accordance with Section 2603.5.5. MCM systems shall be tested in accordance with Section 1407.11. HPL systems shall be tested in accordance with Section 1409.11. Approved NFPA 285 tested assembly design documentation shall be included on the submitted construction documents complying with Section 1401.2. Deviation from the NFPA 285 tested design shall be approved by the registered design professional and additional documentation shall be provided if requested by the department. Combustible exterior wall coverings shall comply with Section 1406 of this code.

Exception: Fiber-reinforced polymer (FRP) where permitted by Section 2613.5 not to be tested.

1403.5.1 Exterior walls with water-resistive barriers. Exterior walls on buildings of Type I, II, III, or IV construction that are greater than 40 feet (12 192 mm) in height above grade plane and contain a combustible water-resistive barrier shall be tested in accordance with and comply with the acceptance criteria of NFPA 285. For the purposes of this section, fenestration products and flashing of fenestration products and water-resistive barrier flashing and accessories at other

locations, including through wall flashings and attachment accessories, shall not be considered part of the water-resistive barrier.

Exceptions:

1. Walls in which the water-resistive barrier is the only combustible component and the exterior wall has a wall covering of brick, concrete, stone, terra cotta, stucco or steel with minimum thicknesses in accordance with Table 1405.2 of this code.
2. Walls in which the water-resistive barrier is the only combustible component and the water-resistive barrier has a peak heat release rate of less than 150 kW/m² (203.9 hp/m²), a total heat release of less than 20 MJ/m² (18 956 BTU/m²) and an effective heat of combustion of less than 18 MJ/kg (17 060 BTU/lb) as determined in accordance with ASTM E 1354 and has a flame spread index of 25 or less and a smoke-developed index of 450 or less as determined in accordance with ASTM E 84 or UL 723. The ASTM E 1354 test shall be conducted on specimens at the thickness intended for use, in the horizontal orientation and at an incident radiant heat flux of 50 kW/m².

1403.6 Flood resistance. For buildings in [~~areas of special~~] flood hazard areas, the exterior wall envelope extending below the design flood elevation shall be resistant to water damage and shall comply with Appendix G.

1403.7 Thermal and condensation resistance. The exterior wall envelope shall be designed and constructed [~~required~~] for thermal and condensation resistance as necessary to meet the requirements of the *New York City Energy Conservation Code*.

1403.8 Bird friendly materials. Bird friendly materials shall be required in accordance with [~~sections~~] Sections 1403.8.1 through 1403.8.4.

1403.8.1 Exterior wall envelope. The exterior wall envelope, and any associated openings, shall be constructed with bird friendly materials up to 75 feet (22 860 mm) above grade. Materials other than bird friendly materials shall not exceed an aggregate of 10 square feet (0.93 m²) within any 10 feet (3048 mm) by 10 feet (3048 mm) square area of exterior wall below 75 feet (22 860 mm) above grade.

Exceptions:

1. Where ground floor transparency is required by the *New York City Zoning Resolution*, transparent bird friendly material with a UV-reflective pattern and a maximum threat factor of 27 shall be provided.
2. In areas of special flood hazard and shaded X-Zones where flood resistant glazing is proposed and ground floor transparency is required by the *New York City Zoning Resolution*, transparent bird friendly material with a UV-reflective pattern and a maximum threat factor of 36 shall be provided.

1403.8.2 Bird hazard installations. Bird hazard installations shall be constructed of bird friendly materials regardless of their height above grade.

1403.8.3 Fly-through conditions. Fly-through conditions located 75 feet (22 860 mm) or less above grade shall be constructed with bird friendly materials.

1403.8.4 Adjacency to green roofs. The exterior wall envelope, and any associated openings, installed adjacent to a green roof system on the same building shall be constructed with bird friendly materials up to 12 feet (~~[3658]~~ 3657.6 mm) above the walking surface.

1403.9 Air barrier. The exterior wall envelope shall be designed and constructed with an air barrier as necessary to meet the requirements of the *New York City Energy Conservation Code* and this code.

SECTION BC 1404 MATERIALS

1404.1 General. Materials used for the construction of exterior walls shall comply with the provisions of this section. Materials not prescribed herein shall be permitted, provided that any such alternative has been approved.

1404.2 Water-resistive barrier. ~~[A minimum of]~~ Not fewer than one layer of No. 15 asphalt felt~~[,]~~ complying with ASTM D 226 for Type 1 felt~~[,]~~ or other approved materials~~[,]~~ shall be attached to the studs or sheathing, with flashing as described in Section 1405.4 of this code, in such a manner as to provide a continuous water-resistive barrier behind the exterior wall veneer. Combustible water-resistive barriers shall comply with special inspection requirements of Chapter 17 of this code.

1404.3 Wood. Exterior walls of wood construction shall be designed and constructed in accordance with Chapter 23.

1404.3.1 Basic hardboard. Basic hardboard shall conform to the requirements of ~~[AHA]~~ ANSI A135.4.

1404.3.2 Hardboard siding. Hardboard siding shall conform to the requirements of ~~[AHA]~~ ANSI A135.6 and, where used structurally, shall be so identified by the label of an approved agency.

1404.4 Masonry. Exterior walls of masonry construction shall be designed and constructed in accordance with this chapter and Chapter 21. Masonry units, mortar and metal accessories used in anchored and adhered veneer shall meet the physical requirements of Chapter 21. The backing of anchored and adhered veneer shall be of concrete, masonry, steel framing or wood framing. Continuous insulation meeting the applicable requirements of this code shall be permitted between the backing and the masonry veneer.

1404.5 Metal. Exterior walls ~~[of formed steel construction, structural steel or lightweight metal alloys]~~ constructed of cold-formed steel, structural steel or aluminum shall be designed in accordance with Chapters ~~[22 and 20]~~ 20 and 22, as applicable.

1404.5.1 Aluminum siding. Aluminum siding shall conform to the requirements of AAMA 1402.

1404.5.2 Cold-rolled copper. Copper shall conform to the requirements of ASTM B 370.

1404.5.3 Lead-coated copper. Lead-coated copper shall conform to the requirements of ASTM B 101.

1404.6 Concrete. Exterior walls of concrete construction shall be designed and constructed in accordance with Chapter 19.

1404.7 Glass-unit masonry. Exterior walls of glass-unit masonry shall be designed and constructed in accordance with Chapter 21.

1404.8 Plastics. Plastic panel, apron or spandrel walls as defined in this code shall not be limited in thickness, provided that such plastics and their assemblies conform to the requirements of Chapter 26 and other applicable requirements of this chapter, and are constructed of approved weather-resistant materials of adequate strength to resist the wind loads for cladding specified in Chapter 16.

1404.9 Vinyl siding. Vinyl siding shall be certified and labeled as conforming to the requirements of ASTM D 3679 by an approved agency.

1404.10 [~~Fiber-cement~~] Fiber-cement siding. [~~Fiber-cement~~] Fiber-cement siding shall conform to the requirements of ASTM C 1186, Type A[~~7~~] or ISO 8336, Category A, and shall be so identified on labeling listing an approved agency.

1404.11 Exterior insulation finish system (EIFS). EIFS shall be designed and constructed in accordance with Section 1408.

1404.12 Polypropylene siding. Polypropylene siding shall be certified and labeled as conforming to the requirements of ASTM D 7254 and those of Section 1404.12.1 or 1404.12.2 of this code by an approved agency. Polypropylene siding shall be installed in accordance with manufacturer's instructions and the requirements of Section 1405.18 of this code. Polypropylene siding shall be secured to the building so as to provide weather protection for the exterior walls of the building.

1404.12.1 Flame spread index. The certification of the flame spread index shall be accompanied by a test report stating that all portions of the test specimen ahead of the flame front remained in position during the test in accordance with ASTM E 84 or UL 723.

1404.12.2 Distance between adjacent buildings. The distance between a building with polypropylene siding and the adjacent building shall be not less than 10 feet (3048 mm).

1404.13 Foam plastic insulation. Foam plastic insulation used in exterior wall covering assemblies shall comply with Chapter 26 and be fireblocked in accordance with Section 718.2.6.1.

SECTION BC 1405 INSTALLATION OF WALL COVERINGS

1405.1 General. Exterior wall coverings shall be designed and constructed in accordance with the applicable provisions of this section. Installations not prescribed herein shall be permitted, provided that such alternative has been approved. Installations shall be in accordance with approved construction documents where a permit is required. Installations of exterior wall coverings shall comply with the special inspection requirements of Chapter 17.

1405.2 Weather protection. ~~[Exterior]~~ The exterior wall envelope shall provide weather protection for the building. The materials of the minimum nominal thickness specified in Table 1405.2 shall be acceptable as approved weather coverings.

Exception: Weather coverings not meeting the minimum nominal thicknesses specified in Table 1405.2 shall be permitted provided such alternative has been approved.

**TABLE 1405.2
MINIMUM THICKNESS OF WEATHER COVERINGS**

COVERING TYPE	MINIMUM THICKNESS (inches)
Adhered masonry veneer [*]	0.25
Aluminum siding	0.019
Anchored masonry veneer	2.625
Asbestos-cement boards	0.125
Asbestos shingles	0.156
Cold-rolled copper ^d	0.0216 nominal
Copper shingles ^d	0.0162 nominal
Exterior plywood (with sheathing)	0.313
Exterior plywood (without sheathing)	See Section 2304.6
Fiber-cement lap siding	0.25 ^c
Fiber-cement panel siding	0.25 ^c
Fiberboard siding	0.5
Glass-fiber reinforced concrete panels	0.375
Hardboard siding ^c	0.25
High-yield copper ^d	0.0162 nominal
Lead-coated copper ^d	0.0216 nominal
Lead-coated high-yield copper	0.0162 nominal
Marble slabs	1
Particleboard (with sheathing)	See Section 2304.6
Particleboard (without sheathing)	See Section 2304.6
[Precast stone facing] Porcelain tile	[0.625] 0.25
Steel (approved corrosion resistant)	0.0149
Stone [(cast artificial)] (cast artificial, anchored)	1.5
Stone (natural)	2
Structural glass	0.344
Stucco or exterior cement plaster	
Three-coat work over:	
Metal plaster base	0.875 ^b
Unit masonry	0.625 ^b
Cast-in-place or precast concrete	0.625 ^b
Two-coat work over:	
Unit masonry	0.5 ^b
Cast-in-place or precast concrete	0.375 ^b
Terra cotta (anchored)	1
Terra cotta (adhered)	0.25
Vinyl siding	0.035
Wood shingles	0.375
Wood siding (without sheathing) ^a	0.5

For SI: 1 inch = 25.4 mm, 1 ounce = 28.35 g, 1 square foot = 0.093 m².

- a. Wood siding of thicknesses less than 0.5 inch shall be placed over sheathing that conforms to Section 2304.6.
- b. Exclusive of texture.
- c. As measured at the bottom of decorative grooves.
- d. 16 ounces per square foot for cold-rolled copper and lead-coated copper, 12 ounces per square foot for copper shingles, high-yield copper and lead-coated high-yield copper.

*Veneer units in this group shall be on approved type and not be greater than 2 inches in thickness.

1405.3 Vapor retarders. ~~[Class I or II vapor retarders shall be provided on the interior side of frame walls in Zones 5, 6, 7, 8 and Marine 4.]~~ Vapor retarders as described in Section 1405.3.3 shall be provided based on an approved design using accepted engineering practice for hygrothermal analysis.

[Exceptions:]

~~[1. Basement walls.]~~

~~[2. Below grade portion of any wall.]~~

~~[3. Construction where moisture or its freezing will not damage materials.]~~

1405.3.1 ~~[Class III vapor retarders. Class III vapor retarders shall be permitted where any one of the conditions in Table 1405.3.1 is met.]~~ **Reserved.**

**[TABLE 1405.3.1
CLASS III VAPOR RETARDERS**

ZONE	CLASS III VAPOR RETARDERS PERMITTED FOR:^a
Marine 4	Vented cladding over OSB Vented cladding over plywood Vented cladding over fiberboard Vented cladding over gypsum Insulated sheathing with R value ~ R2.5 over 2x4 wall Insulated sheathing with R value ~ R3.75 over 2x6 wall
5	Vented cladding over OSB Vented cladding over plywood Vented cladding over fiberboard Vented cladding over gypsum Insulated sheathing with R value ~ R5 over 2x4 wall Insulated sheathing with R value ~ R7.5 over 2x6 wall
6	Vented cladding over fiberboard Vented cladding over gypsum Insulated sheathing with R value ~ R7.5 over 2x4 wall Insulated sheathing with R value ~ R11.25 over 2x6 wall
7 and 8	Insulated sheathing with R value ~ R10 over 2x4 wall Insulated sheathing with R value ~ R15 over 2x6 wall

For SI: 1 pound per cubic foot = 16 kg/m³.

a. ~~Spray foam with a minimum density of 2 lbs/ft³ applied to the interior cavity side of OSB, plywood, fiberboard, insulating sheathing or gypsum is deemed to meet the insulating sheathing requirement where the spray foam R value meets or exceeds the specified insulating sheathing R value.]~~

1405.3.2 Reserved.

1405.3.3 Material vapor retarder class. The vapor retarder class shall be based on the manufacturer’s certified testing or a tested assembly.

The following shall be deemed to meet the class specified:

~~[1-]~~ Class I: Sheet polyethylene, non-perforated aluminum foil with a perm rating of less than or equal to 0.1.

~~[2-]~~ Class II: Kraft-faced fiberglass batts or paint with a perm rating greater than 0.1 and less than or equal to 1.0.

~~[3-]~~ Class III: Latex or enamel paint with a perm rating of greater than 1.0 and less than or equal to 10.0.

1405.3.4 Minimum clear airspaces and vented openings for vented cladding. For the purposes of this section, vented cladding shall include the following minimum clear airspaces~~[-]~~:

1. Vinyl lap or horizontal aluminum siding applied over a weather-resistive barrier as specified in this chapter.
2. Brick veneer with a clear airspace as specified in this code.
3. Other approved vented claddings.

1405.4 Flashing. Flashing shall be installed in such a manner so as to prevent moisture from entering the wall or to redirect ~~[it]~~ moisture to the exterior. Flashing shall be installed where required at the perimeters of exterior door and window assemblies, penetrations and terminations of exterior wall assemblies, exterior wall intersections with roofs, chimneys, porches, decks, balconies and similar projections and at built-in gutters and similar locations where moisture could enter the wall. Flashing with projecting flanges shall be installed on both sides and the ends of copings, under sills and continuously above projecting trim.

1405.4.1 Exterior wall pockets. In exterior walls of buildings or structures, wall pockets or crevices in which moisture can accumulate shall be avoided or protected with caps or drips, or other approved means shall be provided to prevent water damage.

1405.4.2 Masonry. Flashing and ~~[weepholes]~~ weep holes in anchored veneer shall be located in the first course of masonry above finished ground level above the foundation wall or slab, and other points of support, including structural floors, shelf angles and lintels where anchored veneers are designed in accordance with Section 1405.6.

1405.5 Wood veneers. Wood veneers on exterior walls of buildings of Type I, II, III and IV construction shall be not less than 1-inch (~~[25]~~ 25.4 mm) nominal thickness, 0.438-inch (11.1 mm) exterior hardboard siding or 0.375-inch (9.5 mm) exterior-type wood structural panels or particleboard and shall conform to the following:

1. The veneer shall not exceed 40 feet (12 190 mm) in height above grade. Where fire-retardant-treated wood is used, the height shall not exceed 60 feet (18 290 mm) in height above grade.
2. The veneer is attached to or furred from a noncombustible backing that is fire-resistance rated as required by other provisions of this code.
3. Where open or spaced wood veneers (without concealed spaces) are used, they shall not project more than 24 inches (~~[640]~~ 609.6 mm) from the building wall.

1405.6 Anchored masonry veneer. Anchored masonry veneer shall comply with the provisions of Sections 1405.6, 1405.7, 1405.8[;] and 1405.9 and Sections [6.1] 12.1 and [6.2] 12.2 of TMS 402[/~~ACI 530/ASCE 5~~], as modified by Chapter 21 of this code.

1405.6.1 Tolerances. Anchored masonry veneers in accordance with Chapter 14 are not required to meet the tolerances in Article 3.3 [G1] F1 of TMS 602 [/~~ACI 530.1/ASCE 6~~].

1405.6.2 Seismic requirements. Anchored masonry veneer located in Seismic Design Category C or D shall conform to the requirements of Section [6.2.2.10] 12.2.2.10 of TMS 402[/~~ACI 530/ASCE 5~~], as modified by Chapter 21 of this code.[~~Anchored masonry veneer located in Seismic Design Category D shall also conform to the requirements of Section 6.2.2.10.3.3 of TMS 402/ACI 530/ASCE 5.~~]

1405.7 Stone veneer. [~~Stone~~] Anchored stone veneer units not exceeding 10 inches (254 mm) in thickness shall be anchored directly to masonry, concrete or to stud construction by one of the following methods:

1. With concrete or masonry backing, anchor ties shall be not less than 0.1055-inch (2.68 mm) corrosion-resistant wire, or approved equal, formed beyond the base of the backing. The legs of the loops shall be not less than 6 inches ([452] 152.4 mm) in length bent at right angles and laid in the mortar joint, and spaced so that the eyes or loops are 12 inches ([305] 304.8 mm) maximum on center [~~o.c.~~] in both directions. There shall be provided not less than a 0.1055-inch (2.68 mm) corrosion-resistant wire tie, or approved equal, threaded through the exposed loops for every 2 square feet (0.2 m²) of stone veneer. This tie shall be a loop having legs not less than 15 inches (381 mm) in length, so bent [~~so~~] that [~~it~~] the tie will lie in the stone veneer mortar joint. The last 2 inches ([54] 50.8 mm) of each wire leg shall have a right-angle bend. One-inch ([25] 25.4 mm) minimum thickness of cement grout shall be placed between the backing and the stone veneer.
2. With wood stud backing, a 2-inch by 2-inch ([54] 50.8 mm by [54] 50.8 mm) 0.0625-inch (1.59 mm) [~~corrosion-resistant~~] zinc-coated or nonmetallic coated wire mesh with two layers of [~~water resistive~~] water-resistive barrier in accordance with Section 1404.2 shall be applied directly to wood studs spaced [~~a maximum of~~] not more than 16 inches ([406] 406.4 mm) [~~o.c.~~] on center. On studs, the mesh shall be attached with 2-inch [~~long~~] ([54] 50.8 mm) long corrosion-resistant steel wire furring nails at 4 inches ([402] 101.6 mm) [~~o.c.~~] on center providing a minimum 1.125-inch ([29] 28.58 mm) penetration into each stud and with 8d (0.120 in. diameter) [~~common~~] annular threaded nails at 8 inches ([203] 203.2 mm) [~~o.c.~~] on center into top and bottom plates or with equivalent wire ties. There shall be not less than a 0.1055-inch (2.68 mm) [~~corrosion-resistant~~] zinc-coated or nonmetallic coated wire, or approved equal, [~~looped through the mesh~~] attached to the stud with not smaller than an 8d (0.120 in. diameter) annular threaded nail for every 2 square feet (0.2 m²) of stone veneer. This tie shall be a loop having legs not less than 15 inches (381 mm) in length, so bent that [~~it~~] the tie will lie in the stone veneer mortar joint. The last 2 inches ([54] 50.8 mm) of each wire leg shall have a right-angle bend. One-inch ([25] 25.4 mm) minimum thickness of cement grout shall be placed between the backing and the stone veneer.
3. With cold-formed steel stud backing, a 2-inch by 2-inch (50.8 mm by 50.8 mm) 0.0625-inch (1.59 mm) zinc-coated or nonmetallic coated wire mesh with two layers of water-resistive

barrier in accordance with Section 1404.2 shall be applied directly to steel studs spaced at not more than 16 inches (406.4 mm) on center. The mesh shall be attached with corrosion-resistant #8 self-drilling, tapping screws at 4 inches (101.6 mm) on center, and at 8 inches (203.2 mm) on center into top and bottom tracks or with equivalent wire ties. Screws shall extend through the steel connection not fewer than three exposed threads. There shall be not less than a 0.1055-inch (2.68 mm) corrosion-resistant wire, or approved equal, attached to the stud with not smaller than a #8 self-drilling, tapping screw extending through the steel framing not fewer than three exposed threads for every 2 square feet (0.2 m²) of stone veneer. This tie shall be a loop having legs not less than 15 inches (381 mm) in length, so bent that the tie will lie in the stone veneer mortar joint. The last 2 inches (50.8 mm) of each wire leg shall have a right-angle bend. One inch (25.4 mm) minimum thickness of cement grout shall be placed between the backing and the stone veneer. The cold-formed steel framing members shall have a minimum bare steel thickness of 0.0428 inches (1.087 mm).

1405.8 Slab-type veneer. ~~[Slab-type]~~ Anchored slab-type veneer units not exceeding 2 inches (51) 50.8 mm) in thickness shall be anchored directly to masonry, concrete or [stud] light-frame construction. For veneer units of marble, travertine, granite or other stone units of slab form, ties of corrosion-resistant dowels in drilled holes shall be located in the middle third of the edge of the units, spaced [a maximum of] not more than 24 inches ([640] 609.6 mm) apart around the periphery of each unit with not less than four ties per veneer unit. Units shall not exceed 20 square feet (1.9 m²) in area. If the dowels are not tight fitting, the holes shall be drilled not more than 0.063 inch (1.6 mm) larger in diameter than the dowel, with the hole countersunk to a diameter and depth equal to twice the diameter of the dowel in order to provide a tight-fitting key of cement mortar at the dowel locations [when] where the mortar in the joint has set. Veneer ties shall be corrosion-resistant metal capable of resisting, in tension or compression, a force equal to two times the weight of the attached veneer. If made of sheet metal, veneer ties shall be not smaller in area than 0.0336 by 1 inch (0.853 by [25] 25.4 mm) or, if made of wire, not smaller in diameter than 0.1483-inch (3.76 mm) wire.

1405.9 Terra cotta. ~~[Anchored terra cotta or ceramic units not less than 1½ inches (41 mm) thick shall be anchored directly to masonry, concrete or stud construction. Tied terra cotta or ceramic veneer units shall be not less than 1½ inches (41 mm) thick with projecting dovetail webs on the back surface spaced approximately 8 inches (203 mm) o.c. The facing shall be tied to the backing wall with corrosion-resistant metal anchors of not less than No. 8 gage wire installed at the top of each piece in horizontal bed joints not less than 12 inches (305 mm) nor more than 18 inches (457 mm) o.c.; these anchors shall be secured to ¼ inch (6.4 mm) corrosion-resistant pencil rods that pass through the vertical aligned loop anchors in the backing wall. The veneer ties shall have sufficient strength to support the full weight of the veneer in tension. The facing shall be set with not less than a 2-inch (51 mm) space from the backing wall and the space shall be filled solidly with Portland cement grout and pea gravel. Immediately prior to setting, the backing wall and the facing shall be drenched with clean water and shall be distinctly damp when the grout is poured.]~~ Anchored terra cotta or ceramic units not less than 1 inch (25.4 mm) thick shall be anchored directly to masonry, concrete or stud construction. Terra cotta or ceramic unit anchorage shall be engineered to transfer loads to stable backup walls utilizing not less than two non-corrosive anchors per unit.

1405.10 Adhered masonry veneer. Adhered masonry veneer shall comply with the applicable requirements in ~~[Section 1405.10.1]~~ this section and Sections ~~[6.1]~~ 12.1 and ~~[6.3]~~ 12.3 of TMS 402/~~[ACI 530/ASCE 5]~~, as modified by Chapter 21 of this code.

1405.10.1 Exterior adhered masonry veneer. Exterior adhered masonry veneer shall be installed in accordance with the manufacturer's instructions and Section 1405.10.

1405.10.1.1 Water-resistive barriers. Water-resistive barriers shall be installed as required in Section 2510.6.

1405.10.1.2 Flashing. Flashing shall comply with this section and the applicable requirements of Section 1405.4.

1405.10.1.2.1 Flashing at foundation. A corrosion-resistant screed or flashing of a minimum 0.019-inch (0.48 mm) or 26 gage galvanized or plastic with a minimum vertical attachment flange of 3½ inches (88.9 mm) shall be installed to extend not less than 1 inch (25.4 mm) below the foundation plate line on exterior stud walls in accordance with Section 1405.4. The water-resistive barrier shall lap over the exterior of the attachment flange of the screed or flashing.

1405.10.1.3 Clearances. On exterior stud walls, adhered masonry veneer shall be installed not less than 4 inches (101.6 mm) above the earth, or not less than 2 inches (50.8 mm) above paved areas, or not less than ½ inch (12.7 mm) above exterior walking surfaces that are supported by the same foundation that supports the exterior wall.

1405.10.1.4 Adhered masonry veneer installed with lath and mortar. Exterior adhered masonry veneer installed with lath and mortar shall comply with the following.

1405.10.1.4.1 Lathing. Lathing shall comply with the requirements of Section 2510.

1405.10.1.4.2 Scratch coat. A nominal ½-inch (12.7 mm) thick layer of mortar complying with the material requirements of Sections 2103 and 2512.2 shall be applied, encapsulating the lathing. The surface of this mortar shall be scored horizontally, resulting in a scratch coat.

1405.10.1.4.3 Adhering veneer. The masonry veneer units shall be adhered to the mortar scratch coat with a nominal ½-inch (12.7 mm) thick setting bed of mortar complying with Sections 2103 and 2512.2 applied to create a full setting bed for the back of the masonry veneer units. The masonry veneer units shall be worked into the setting bed resulting in a nominal ⅜-inch (9.5 mm) setting bed after the masonry veneer units are applied.

1405.10.1.5 Adhered masonry veneer applied directly to masonry and concrete. Adhered masonry veneer applied directly to masonry or concrete shall comply with the applicable requirements of Section 1405.10, and with the requirements of Section 1405.10.1.4 or 2510.7.

1405.10.1.6 Cold weather construction. Cold weather construction of adhered masonry veneer shall comply with the requirements of Sections 2104 and 2512.4.

1405.10.1.7 Hot weather construction. Hot weather construction of adhered masonry veneer shall comply with the requirements of Section 2104.

1405.10.2 Exterior adhered masonry veneers—porcelain tile. Adhered units shall not exceed ⅝ inch (15.8 mm) thickness and 24 inches (609.6 mm) in any face dimension nor more than 3

square feet (0.28 m²) in total face area and shall not weigh more than 9 pounds psf (0.43 kN/m²). Porcelain tile shall be adhered to an approved backing system.

1405.10.3 Interior adhered masonry veneers. Interior adhered masonry veneers shall have a maximum weight of 20 psf (0.958 kg/m²) and shall be installed in accordance with Section 1405.10. [~~Where the interior adhered masonry veneer is supported by wood construction, the~~] The supporting members shall be designed to limit deflection to 1/600 of the span of the supporting members.

1405.11 Metal veneers. Veneers of metal shall be fabricated from approved corrosion-resistant materials or shall be protected front and back with porcelain enamel, or otherwise be treated to render the metal resistant to corrosion. Such veneers shall be not [~~be~~] less than 0.0149-inch (0.378 mm) nominal thickness sheet steel mounted on wood or metal furring strips or approved sheathing on [~~the wood~~] light-frame construction.

1405.11.1 Attachment. Exterior metal veneer shall be securely attached to the supporting masonry or framing members with corrosion-resistant fastenings, metal ties or by other approved devices or methods. The spacing of the fastenings or ties shall not exceed 24 inches (~~[610]~~ 609.6 mm) either vertically or horizontally, but where units exceed 4 square feet (0.4 m²) in area there shall be not less than four attachments per unit. The metal attachments shall have a cross-sectional area not less than provided by W 1.7 wire. Such attachments and their supports shall be [~~capable of resisting a horizontal force in accordance with the wind loads specified in Section 1609, but in no case less than 20 psf (0.958 kg/m²)~~] designed and constructed to resist the wind loads as specified in Section 1609 for components and cladding.

1405.11.2 Weather protection. Metal supports for exterior metal veneer shall be protected by painting, galvanizing or by other approved coating or treatment. Wood studs, furring strips or other wood supports for exterior metal veneer shall be approved pressure-treated wood or protected as required in Section 1403.2. Joints and edges exposed to the weather shall be caulked with approved durable waterproofing material or by other approved means to prevent penetration of moisture.

1405.11.3 Backup. Masonry backup shall not be required for metal veneer [~~except as is necessary to meet~~] unless required by the fire-resistance requirements of this code.

1405.11.4 Grounding. Grounding of metal veneers on buildings shall comply with the requirements of [~~Chapter 27 and the *New York City Electrical Code*~~] the *New York City Electrical Code* and Chapter 27 of this code.

1405.12 Thin exterior structural glass veneer. The area of a single section of thin exterior structural glass veneer shall not exceed 10 square feet (0.93 m²) where [~~it~~] that section is not more than 15 feet (4572 mm) above the level of the sidewalk or grade level directly below, and shall not exceed 6 square feet (0.56 m²) where it is more than 15 feet (4572 mm) above that level. In no event shall thin exterior structural glass veneer be installed more than 35 feet (10 668 mm) above the level of the sidewalk or grade level directly below.

1405.12.1 Length and height. The length or height of any section of thin exterior structural glass veneer shall not exceed 48 inches (~~[1219]~~ 1220 mm).

1405.12.2 Thickness. The thickness of thin exterior structural glass veneer shall be not less than 0.344 inch (8.7 mm).

1405.12.3 Application. Thin exterior structural glass veneer shall be set only after backing is thoroughly dry and after application of an approved bond coat uniformly over the entire surface of the backing so as to effectively seal the surface. Glass shall be set in place with an approved mastic cement in sufficient quantity so that at least 50 percent of the area of each glass unit is directly bonded to the backing by mastic not less than ¼ inch (6.4 mm) thick and not more than ⅝ inch (15.9 mm) thick. The bond coat and mastic shall be evaluated for compatibility and shall bond firmly together.

1405.12.4 Installation at sidewalk level. Where thin exterior structural glass veneer extends to a sidewalk surface, each section shall rest in an approved metal molding, and be set at least ¼ inch (6.4 mm) above the highest point of the sidewalk. The space between the molding and the sidewalk shall be thoroughly caulked and made water tight.

1405.12.4.1 Installation above sidewalk level. Where thin exterior structural glass veneer is installed above the level of the top of a bulkhead facing, or at a level more than 36 inches (~~[914]~~ 914.4 mm) above the sidewalk level, the mastic cement binding shall be supplemented with approved nonferrous metal shelf angles located in the horizontal joints in every course. Such shelf angles shall be not less than 0.0478-inch (~~[1.21]~~ 1.2 mm) thick and not less than 2 inches (~~[51]~~ 50.8 mm) long and shall be spaced at approved intervals, with not less than two angles for each glass unit. Shelf angles shall be secured to the wall or backing with expansion bolts, toggle bolts or by other approved methods.

1405.12.5 Joints. Unless otherwise specifically approved by the commissioner, abutting edges of thin exterior structural glass veneer shall be ground square. Mitered joints shall not be used except where specifically approved for wide angles. Joints shall be uniformly buttered with an approved jointing compound and horizontal joints shall be held to not less than 0.063 inch (1.6 mm) by an approved nonrigid substance or device. Where thin exterior structural glass veneer abuts nonresilient material at sides or top, expansion joints not less than ¼ inch (6.4 mm) wide shall be provided.

1405.12.6 Mechanical fastenings. Thin exterior structural glass veneer installed above the level of the heads of show windows and veneer installed more than 12 feet (~~[3658]~~ 3657.6 mm) above sidewalk level shall, in addition to the mastic cement and shelf angles, be held in place by the use of fastenings at each vertical or horizontal edge, or at the four corners of each glass unit. Fastenings shall be secured to the wall or backing with expansion bolts, toggle bolts or by other methods. Fastenings shall be so designed as to hold the glass veneer in a vertical plane independent of the mastic cement. Shelf angles providing both support and fastenings shall be permitted.

1405.12.7 Flashing. Exposed edges of thin exterior structural glass veneer shall be flashed with overlapping corrosion-resistant metal flashing or equivalent and caulked with a waterproof compound in a manner to effectively prevent the entrance of moisture between the glass veneer and the backing.

1405.13 Exterior windows and doors. Windows and doors installed in exterior walls shall conform to the testing and performance requirements of Section ~~[1715.5]~~ 1709.5.

1405.13.1 Installation. Windows and doors shall be installed in accordance with ~~[approved]~~ the manufacturer's instructions. Fastener size and spacing shall be provided in such instructions and shall be calculated based on maximum loads and spacing used in the tests.

1405.13.2 Windows in Group R-2 and R-3 occupancies. Windows in Group R-2 and R-3 occupancies shall comply with Sections 1015.9 and 1015.8, respectively.

~~[1405.13.2 Window sills in R-3 occupancy. In Occupancy Group R-3, one and two family dwellings, where the opening of the sill portion of an operable window is located more than 72 inches (1829 mm) above the finished grade or other surface below, the lowest part of the clear opening of the window shall be at a height not less than 24 inches (610 mm) above the finished floor surface of the room in which the window is located. Glazing between the floor and a height of 24 inches (610 mm) shall be fixed or have openings through which a 4-inch (102 mm) diameter sphere cannot pass.]~~

~~[Exception: Openings that are provided with window guards that comply with ASTM F 2090.]~~

~~[1405.13.3 Windows in R-2 occupancy. Windows in R-2 occupancy shall be subject to any applicable requirements of the *New York City Department of Health and Mental Hygiene with regard to window guards.*]~~

1405.14 Vinyl siding. Vinyl siding conforming to the requirements of this section and complying with ASTM D 3679 shall be permitted on exterior walls of buildings located in areas where the ~~[basic wind speed specified in Chapter 16]~~ allowable stress design speed V_{asd} , as determined in accordance with Section 1609.3.1, does not exceed 100 miles per hour (~~[45]~~ 44.7 m/s) and the building height is less than or equal to 40 feet (12 192 mm) in Exposure C. Where construction is located in areas where the ~~[basic wind speed]~~ allowable stress design speed V_{asd} , as determined in accordance with Section 1609.3.1, exceeds 100 miles per hour ~~[45 m/s]~~ (44.7 m/s), or building heights are in excess of 40 feet (12 192 mm), tests or calculations ~~[indicating]~~ showing compliance with Chapter 16 of this code shall be submitted. Vinyl siding shall be secured to the building so as to provide weather protection for the exterior walls of the building.

1405.14.1 Application. The siding shall be applied over sheathing or materials listed in Section 2304.6. Siding shall be applied to conform ~~[with]~~ to the water-resistive barrier requirements in Section 1403. Siding and accessories shall be installed in accordance with ~~[approved]~~ the manufacturer's instructions. Unless otherwise specified in the ~~[approved]~~ manufacturer's instructions, nails used to fasten the siding and accessories shall have a minimum 0.313-inch (7.9 mm) head diameter and 1/8-inch (3.18 mm) shank diameter. The nails shall be corrosion resistant and shall be long enough to penetrate the studs or nailing strip at least 3/4 inch (~~[19]~~ 19.1 mm). For cold-formed steel light-frame construction, corrosion-resistant fasteners shall be used. Screw fasteners shall penetrate the cold-formed steel framing at least three exposed threads. Other fasteners shall be installed in accordance with the manufacturer's instructions. Where the siding is installed horizontally, the fastener spacing shall not exceed 16 inches (~~[406]~~ 406.4 mm) horizontally and 12 inches (~~[305]~~ 304.8 mm) vertically. Where the siding is installed vertically,

the fastener spacing shall not exceed 12 inches (~~[305]~~ 304.8 mm) horizontally and 12 inches (~~[305]~~ 304.8 mm) vertically.

1405.15 Cement plaster. Cement plaster applied to exterior walls shall conform to the requirements specified in Chapter 25.

1405.16 ~~[Fiber cement]~~ Fiber-cement siding. ~~[Fiber cement]~~ Fiber-cement siding complying with Section 1404.10 shall be permitted on exterior walls of Type I, II, III, IV and V construction for wind pressure resistance or wind speed exposures as indicated by the manufacturer's listing and label, and ~~[approved]~~ the installation instructions. Where specified, the siding shall be installed over sheathing or materials listed in Section 2304.6 and shall be installed to conform to the water-resistive barrier requirements in Section 1403. Siding and accessories shall be installed in accordance with ~~[approved]~~ the manufacturer's instructions. Unless otherwise specified in the ~~[approved]~~ manufacturer's instructions, nails used to fasten the siding to wood studs shall be corrosion-resistant round head smooth shank and shall be long enough to penetrate the studs at least 1 inch (~~[25]~~ 25.4 mm). ~~[For metal framing, all weather screws shall be used and shall penetrate the metal]~~ For cold-formed steel light-frame construction, corrosion-resistant fasteners shall be used. Screw fasteners shall penetrate the cold-formed steel framing at least three exposed full threads. Other fasteners shall be installed in accordance with the manufacturer's instructions.

1405.16.1 Panel siding. Fiber-cement panels shall comply with the requirements of ASTM C 1186, Type A, minimum Grade II or ISO 8336, Category A, minimum Class 2. Panels shall be installed with the long dimension either parallel or perpendicular to framing. Vertical and horizontal joints shall occur over framing members and shall be ~~[sealed]~~ protected with ~~[caulking]~~ sealant, ~~[covered with]~~ battens or ~~[shall be]~~ flashing. Alternatively, vertical or horizontal joints shall be shiplap or otherwise designed to comply with Section 1403.2 of this code. Panel siding shall be installed with fasteners in accordance with the ~~[approved]~~ manufacturer's instructions.

1405.16.2 Lap siding. Fiber-cement lap siding having a maximum width of 12 inches (~~[305]~~ 304.8 mm) shall comply with the requirements of ASTM C 1186, Type A, minimum Grade II or ISO 8336, Category A, minimum Class 2. Lap siding shall be lapped a minimum of 1¼ inches (32 mm) and lap siding not having tongue-and-groove end joints shall have the ends ~~[sealed]~~ protected with caulking, covered with an H-section joint cover, located over a strip of flashing or shall be otherwise designed to comply with Section 1403.2 of this code. Lap siding courses shall be installed with the fastener heads exposed or concealed in accordance with the ~~[approved]~~ manufacturer's instructions.

1405.17 Fastening. Weather boarding and wall coverings shall be securely fastened with aluminum, copper, zinc, zinc-coated or other approved corrosion-resistant fasteners in accordance with the nailing schedule in Table ~~[2304.9.1]~~ 2304.10.1 or the ~~[approved]~~ manufacturer's ~~[installation]~~ instructions. Shingles and other weather coverings shall be attached with appropriate ~~[standard shingle]~~ standard-shingle nails to furring strips securely nailed to studs, or with approved mechanically bonding nails, except where sheathing is of wood not less than 1-inch (~~[25]~~ 25.4 mm) nominal thickness or of wood structural panels as specified in Table ~~[2308.9.3(3)]~~ 2308.6.3(3).

1405.18 Polypropylene siding. Polypropylene siding conforming to the requirements of this section and complying with Section 1404.12 shall be limited to exterior walls of Type VB construction located in areas where the wind speed specified in Chapter 16 does not exceed 100 miles per hour

(44.7 m/s) and the building height is less than or equal to 40 feet (12 192 mm) in Exposure C. Where construction is located in areas where the basic wind speed exceeds 100 miles per hour (44.7 m/s), or building heights are in excess of 40 feet (12 192 mm), tests or calculations showing compliance with Chapter 16 shall be submitted. Polypropylene siding shall be installed in accordance with the manufacturer's instructions. Polypropylene siding shall be secured to the building so as to provide weather protection for the exterior walls of the building.

SECTION BC 1406 COMBUSTIBLE MATERIALS ON THE EXTERIOR SIDE OF EXTERIOR WALLS

1406.1 General. Section 1406 shall apply to exterior wall coverings, exterior balconies and similar projections, bay and oriel windows, decks, porches, porticos, entranceways, and storm enclosures constructed of combustible materials. Combustible water-resistive barriers complying with Section 1403.5.1 shall be permitted in exterior wall coverings. Fireblocking shall be installed in accordance with Section 1406.2.3. Existing building retrofits utilizing combustible exterior wall coverings shall also comply with Section 1406.5. Combustible exterior wall coverings shall be subject to the special inspection requirements of Section 1705.16.

1406.2 Combustible exterior wall coverings. Combustible exterior wall coverings, including architectural trim, shall comply with this section.

[Exception:] Exceptions:

1. Plastics complying with Chapter 26.
2. Metal composite materials (MCM) complying with Section 1407.
3. High-pressure decorative exterior-grade compact laminates (HPL) complying with Section 1409.

1406.2.1 Type I, II, III and IV construction. In buildings of Type I, II, III and IV construction, exterior wall coverings shall be permitted to be constructed of combustible materials in accordance with Section 1406.2.1.1, subject to the following limitations:

1. Combustible exterior wall coverings shall not exceed 10 percent of an exterior wall surface area on any given story. Such combustible exterior wall covering shall not be permitted on exterior walls where the fire separation distance is 5 feet (1524 mm) or less.
2. Combustible exterior wall coverings shall be limited to 40 feet (12 192 mm) in height above grade plane.
3. Combustible exterior wall coverings constructed of fire-retardant-treated wood complying with Section 2303.2 for exterior installation shall not be limited in wall surface area where the fire separation distance is 5 feet (1524 mm) or less and shall be permitted up to 60 feet (18 288 mm) in height above grade plane, regardless of the fire separation distance.
4. Wood veneers shall comply with Section 1405.5.

5. Combustible exterior wall coverings shall not be permitted on buildings of Type IV construction utilizing CLT or SCL complying with Section 602.4.
6. Combustible exterior wall coverings shall not be permitted at exterior balconies in accordance with Section 1406.3.

[1406.2.1] 1406.2.1.1 Ignition resistance. ~~[Combustible]~~ Where permitted by Section 1406.2.1 of this code, combustible exterior wall coverings shall be tested in accordance with NFPA 268.

Exceptions: The following materials are not required to be tested in accordance with NFPA 268. However, such materials shall comply with all other provisions of Section 1406 of this code.

1. Wood or wood-based products.
2. Other combustible materials covered with an exterior weather covering other than vinyl sidings ~~[listed in,]~~ included in and complying with the thickness requirements of Table 1405.2 of this code.
3. Aluminum having a minimum thickness of 0.019 inch (0.48 mm).

~~[4. Exterior wall coverings on exterior walls of Type V construction.]~~

[1406.2.1.1] 1406.2.1.1.1 Fire separation 5 feet or less. Where installed on exterior walls having a fire separation distance of 5 feet (1524 mm) or less, combustible exterior wall coverings shall not exhibit sustained flaming as defined in NFPA 268.

[1406.2.1.2] 1406.2.1.1.2 Fire separation greater than 5 feet. For fire separation distances greater than 5 feet (1524 mm), ~~[an assembly]~~ any exterior wall covering shall be permitted that has been exposed to a reduced level of incident radiant heat flux in accordance with the NFPA 268 test method without exhibiting sustained flaming. The minimum fire separation distance required for the [assembly] exterior wall covering shall be determined from Table [1406.2.1.2] 1406.2.1.1.2 of this code based on the maximum tolerable level of incident radiant heat flux that does not cause sustained flaming of the [assembly] exterior wall covering.

**TABLE [1406.2.1.2] 1406.2.1.1.2
MINIMUM FIRE SEPARATION FOR COMBUSTIBLE ~~[VENEERS]~~ EXTERIOR WALL COVERINGS**

FIRE SEPARATION DISTANCE (feet)	TOLERABLE LEVEL INCIDENT RADIANT HEAT ENERGY (kW/m ²)	FIRE SEPARATION DISTANCE (feet)	TOLERABLE LEVEL INCIDENT RADIANT HEAT ENERGY (kW/m ²)
5	12.5	16	5.9
6	11.8	17	5.5
7	11.0	18	5.2
8	10.3	9	4.9

**TABLE [1406.2.1.2] 1406.2.1.1.2
MINIMUM FIRE SEPARATION FOR COMBUSTIBLE [VENEERS] EXTERIOR WALL COVERINGS**

FIRE SEPARATION DISTANCE (feet)	TOLERABLE LEVEL INCIDENT RADIANT HEAT ENERGY (kW/m ²)	FIRE SEPARATION DISTANCE (feet)	TOLERABLE LEVEL INCIDENT RADIANT HEAT ENERGY (kW/m ²)
9	9.6	20	4.6
10	8.9	21	4.4
11	8.3	22	4.1
12	7.7	23	3.9
13	7.2	24	3.7
14	6.7	25	3.5
15	6.3		

For SI: 1 foot = 304.8 mm, 1 Btu/H² × °F = [0.0057] 0.0057 kW/m² × K.

[1406.2.2 Type I, II, III and IV construction. In buildings of Type I, II, III and IV construction, exterior wall coverings shall be permitted to be constructed of combustible materials in accordance with Section 1406.2.1 and with the following limitations.]

- [1. Combustible exterior wall coverings shall not exceed 10 percent of the exterior wall surface area on any given story. Such combustible exterior wall coverings shall not be permitted on exterior walls where the fire separation distance is 5 feet (1524 mm) or less.]
- [2. Combustible wall coverings shall be limited to 40 feet (12 192 mm) in height above grade plane.]
- [3. Combustible exterior wall coverings constructed of fire retardant treated wood complying with Section 2303.2 for exterior installation shall not be limited in wall surface area where the fire separation distance is 5 feet (1524 mm) or less and shall be permitted up to 60 feet (18 288 mm) in height above grade plane regardless of the fire separation distance.]

[1406.2.3] 1406.2.2 Location. [Where combustible] Combustible exterior wall [covering is] coverings located along the top of exterior walls[, such trim] shall be completely backed up by the exterior wall and shall not extend over or above the top of the exterior walls.

[1406.2.4] 1406.2.3 Fireblocking. [Where the combustible exterior wall covering is furred from the wall and forms a solid surface, the distance between the back of the covering and the wall shall not exceed 1 5/8 inches (41 mm). Where required by Section 717, the space thereby created shall be fireblocked.] Exterior wall coverings shall be fireblocked in accordance with Section 718.2.6.

1406.3 Exterior balconies and similar projections. [Exterior balconies and similar projections shall be permitted to be constructed of combustible materials provided that the exterior balcony or similar projection affords the fire resistance rating required by Table 601 for floor construction.] Exterior

wall covering on walls abutting balconies, and cladding on the sides and underside of balconies, shall be constructed of noncombustible materials. Exterior walls abutting balconies shall be noncombustible up to 12 feet (3657.6 mm) above the walking surface or to the underside of the balcony above, whichever is less. On cantilevered balconies, the exterior wall abutting the balcony, plus 3 feet (914.4 mm) on each side, shall be constructed of noncombustible materials. On recessed and semirecessed balconies, the exterior walls abutting the balconies shall be constructed of noncombustible materials.

[Exceptions:]

- ~~[1. Balconies or similar projections serving as a required exit shall not be constructed of combustible materials.]~~
- ~~[2. Balconies or similar projections on the exterior of buildings of Type I or II construction shall not be constructed of combustible materials.]~~

Exception: Combustible exterior wall coverings shall be allowed on balconies in Type V construction with a fire separation distance greater than or equal to 5 feet (1524 mm).

1406.4 Bay and oriel windows, decks, porches, porticos, entranceways, and storm enclosures. Bay and oriel windows, decks, porches, porticos, entranceways and storm enclosures shall conform to the type of construction required for the building to which they are attached, including required fire rating, unless otherwise modified by the requirements of this section. For the purposes of this section, such structures shall be referred to as, “appendages.”

Exception: Plastic complying with Chapter 26.

1406.4.1 Appendages on Type I and II construction. Appendages on buildings of Type I or II construction shall be constructed of noncombustible materials. However, on buildings not more than three stories or 40 feet (12 192 mm) in height, whichever is less, fire-retardant-treated wood shall be permitted.

1406.4.2 Appendages on Type III, IV and VA construction. Appendages on buildings of Type III, IV and VA construction may be constructed of combustible materials, provided that all the following conditions are met:

1. Such building does not exceed [~~3~~] three stories or 40 feet (12 192 mm) in height, whichever is less.
2. The main use or dominant occupancy of such building is classified in Occupancy Group R-2 or R-3.
3. The appendage has an exterior separation on all exposed sides of at least 15 feet (4572 mm), measured from the outermost surface of the appendage, except that appendages with exposed sides protected by minimum 1-hour fire-rated construction extending at least 36 inches ([~~914~~] 914.4 mm) above the highest combustible horizontal surface may be located up to a minimum distance of 36 inches ([~~914~~] 914.4 mm) from any property line.

4. The appendage is so constructed that its removal or destruction will not reduce the structural stability or fire-resistive integrity of the building.
5. The appendage has a superficial area not exceeding 150 square feet (13.9 m²) when viewed from directly above and is included in the area limitations of Table 503 for the entire building.
6. The appendage is not higher than the sills of the second-story windows.
7. The vertical surface area of the combustible portions of the appendage does not exceed 10 percent of the total wall area (windows excluded) of the building.
8. For enclosed appendages, the roof of the appendage has a class A roof covering, and the soffit or ceiling covering the combustible roof framing shall have a minimum 1-hour fire-resistance rating.

Exception: Appendages constructed of fire-retardant-treated wood, on buildings not exceeding 3 stories or 40 feet (12 192 mm) in height, whichever is less, need not comply with Items 2 through 8.

1406.4.3 Appendages on Type VB construction. Appendages may be constructed of combustible materials on buildings of construction Type VB.

1406.5 Retrofit of existing buildings. Combustible materials shall not be permitted for use at the outermost surface of the exterior wall covering for exterior envelope retrofits of existing nonsprinklered buildings over 75 feet (22 860 mm), unless the following conditions are satisfied:

1. The outermost surface of the combustible exterior wall covering shall be interrupted by a noncombustible material at least 3 feet (914.4 mm) high between the top of one opening and the bottom of the opening immediately above to form a continuous band across building elevations.
2. On walls without openings, a 3 feet (914.4 mm) high noncombustible band shall interrupt the outermost surface of the combustible exterior wall covering at least every 15 feet (4572 mm) vertically.

SECTION BC 1407 METAL COMPOSITE MATERIALS (MCM)

1407.1 General. The provisions of this section shall govern the materials, construction and quality of metal composite materials (MCM) for use as exterior wall coverings in addition to other applicable requirements of Chapters 14 and 16.

1407.1.1 Plastic core. The plastic core of the MCM shall not contain foam plastic insulation as defined in Section [~~2602.1~~] 202.

1407.1.2 Prohibited locations. The use of MCM in exterior wall coverings is subject to the following limitations:

1. MCM is prohibited in exterior wall coverings in Type IV construction utilizing cross-laminated timber (CLT) or structural composite lumber (SCL) complying with Section 602.4.
2. MCM is prohibited in exterior wall coverings at exterior balconies in accordance with Section 1406.3.

1407.2 Exterior wall finish. MCM used as exterior wall finish or as elements of [~~balconies and similar appendages and~~] bay and oriel windows to provide cladding or weather resistance shall comply with Sections 1407.4 through [~~1407.14~~] 1407.16.

1407.3 Architectural trim and embellishments. MCM used as architectural trim or embellishments shall comply with Sections 1407.7 through 1407.14.

1407.4 Structural design. MCM systems shall be designed and constructed to resist wind loads as required by Chapter 16 for components and cladding.

1407.5 Approval. Results of approved tests or an engineering analysis shall be submitted to the commissioner to verify compliance with the requirements of Chapter 16 for wind loads.

1407.6 Weather resistance. MCM systems shall comply with Section 1403 and shall be designed and constructed to resist wind and rain in accordance with this section and the manufacturer's installation instructions.

1407.7 Durability. MCM systems shall be constructed of approved materials that maintain the performance characteristics required in Section 1407 for the duration of use.

1407.8 Fire-resistance rating. Where MCM systems are used on exterior walls required to have a fire-resistance rating in accordance with Section 705, evidence shall be submitted to the commissioner that the required fire-resistance rating is maintained.

Exception: MCM systems not containing foam plastic insulation, which are installed on the outer surface of a fire-resistance-rated exterior wall in a manner such that the attachments do not penetrate through the entire exterior wall assembly, shall not be required to comply with this section.

~~**1407.9 [Surface-burning characteristics.** Unless otherwise specified, MCM shall have a flame spread index of 75 or less and a smoke developed index of 450 or less when tested in the maximum thickness intended for use in accordance with ASTM E 84 or UL 723.]~~

~~**[1407.10 Type I, II, III and IV construction.** Where installed on buildings of Type I, II, III and IV construction, MCM systems shall comply with Sections 1407.10.1 through 1407.10.3, or Section 1407.11.]~~

~~**[1407.10.1] Surface-burning characteristics.** MCM shall have a flame spread index of not more than 25 and a smoke-developed index of not more than 450 when tested as an assembly in the maximum thickness intended for use in accordance with ASTM E 84 or UL 723.~~

[1407.10.2] 1407.10 Thermal barriers. MCM shall be separated from the interior of a building by an approved thermal barrier consisting of ~~[1/2-inch (12.7 mm)]~~ 5/8-inch (15.9 mm) Type X gypsum wallboard or equivalent thermal barrier material that will limit the average temperature rise of the unexposed surface to not more than 250°F (121°C) after [15] 20 minutes of fire exposure in accordance with the standard time-temperature curve of ASTM E 119 or UL 263. The thermal barrier shall be installed in [such a manner that it will remain in place for not less than 15 minutes based on a test conducted] accordance with criteria established by testing in accordance with UL 1715, where the thermal barrier shall remain in place for 20 minutes.

[Exceptions:]

- ~~[1. The thermal barrier is not required where the MCM system is specifically approved based on tests conducted in accordance with UL 1040 or UL 1715. Such testing shall be performed with the MCM in the maximum thickness intended for use. The MCM system shall include seams, joints and other typical details used in the installation and shall be tested in the manner intended for use.]~~
- ~~[2. The thermal barrier is not required where the MCM is used as elements of balconies and similar appendages, architectural trim or embellishments.]~~

[1407.10.3] 1407.11 Full-scale tests. ~~[The] All MCM [system] systems shall be tested in accordance with, and comply with, the acceptance criteria of NFPA 285. Such testing shall be performed on the MCM system with the MCM in the maximum thickness intended for use, including any required fireblocking. Approved NFPA 285 tested assembly design documentation of the MCM system shall be included on the submitted construction documents complying with Section 1401.2 of this code. Deviation from the NFPA 285 tested design shall be approved by the registered design professional and additional documentation shall be provided if requested by the department.~~

~~**[1407.11 Alternate conditions.** MCM and MCM systems shall not be required to comply with Sections 1407.10.1 through 1407.10.3 provided such systems comply with Section 1407.11.1 or 1407.11.2.]~~

~~**[1407.11.1 Installations up to 40 feet in height.** MCM shall be permitted to be installed no more than 40 feet (12 190 mm) in height above grade provided the MCM is installed in accordance with Sections 1407.11.1.1 and 1407.11.1.2.]~~

~~**[1407.11.1.1 Fire separation distance of 5 feet or less.** Where the fire separation distance is 5 feet (1524 mm) or less, the area of MCM shall not exceed 10 percent of the exterior wall surface.]~~

~~**[1407.11.1.2 Fire separation distance greater than 5 feet.** Where the fire separation distance is greater than 5 feet (1524 mm), there shall be no limit on the area of exterior wall surface coverage using MCM.]~~

~~**[1407.11.2 Installations up to 50 feet in height.** MCM shall be permitted to be installed no more than 50 feet (15 240 mm) in height above grade provided the MCM meets the requirements of Sections 1407.11.2.1 and 1407.11.2.2.]~~

~~[1407.11.2.1 Self ignition temperature. MCM shall have a self ignition temperature of 650°F (343°C) or greater when tested in accordance with ASTM D 1929.]~~

~~[1407.11.2.2 Limitations. Sections of MCM shall not exceed 300 square feet (27.9 m²) in area and shall be separated by a minimum of 4 feet (1219 mm) vertically.]~~

~~1407.12 [Type V construction. MCM shall be permitted to be installed on buildings of Type V construction.]~~ **Reserved.**

1407.13 Foam plastic insulation. MCM systems containing foam plastic insulation shall also comply with the requirements of Section 2603.

1407.14 Labeling. MCM shall be labeled in accordance with ~~[Chapter 17]~~ this code and Section 28-113 of the *Administrative Code*.

1407.15 Special inspection. MCM shall be subject to special inspection in accordance with Chapter 17.

1407.16 Fireblocking. MCM installations shall be fireblocked in accordance with Section 718.2.6.1.

SECTION BC 1408 EXTERIOR INSULATION AND FINISH SYSTEMS (EIFS)

1408.1 General. The provisions of this section shall govern the materials, construction and quality of exterior insulation and finish systems (EIFS) for use as exterior wall coverings in addition to other applicable requirements of Chapters 7, 14, 16, 17 and 26.

1408.1.1 Prohibited locations. The use of EIFS containing foam plastic insulation in exterior wall coverings is subject to the following limitations:

1. EIFS containing foam plastic insulation is prohibited in exterior wall coverings in Type IV construction utilizing cross-laminated timber (CLT) or structural composite lumber (SCL) complying with Section 602.4.
2. EIFS containing foam plastic insulation is prohibited in exterior wall coverings at exterior balconies in accordance with Section 1406.3.

1408.2 Performance characteristics. EIFS shall be constructed such that it meets the performance characteristics required in ASTM E 2568.

1408.3 Structural design. The underlying structural framing and substrate shall be designed and constructed to resist loads as required by Chapter 16.

1408.4 Weather resistance. EIFS shall comply with Section 1403 and shall be designed and constructed to resist ~~[wind and rain in accordance with this section and the manufacturer's application instructions]~~ environmental conditions in accordance with this section, the approved construction documents and manufacturer's installation instructions.

1408.4.1 EIFS with drainage. EIFS with drainage shall have an average minimum drainage efficiency of 90 percent when tested in accordance with requirements of ASTM E 2273 and is required on framed walls of Type V construction, residential Group R occupancies.

1408.4.1.1 Water-resistive barrier. For EIFS with drainage, the water-resistive barrier shall comply with Section 1404.2 of this code or ASTM E 2570.

1408.5 Installation. Installation of the EIFS and EIFS with drainage shall be in accordance with the EIFS manufacturer's instructions and this section.

1408.6 Special inspections. EIFS installations shall comply with the provisions of Chapter 17.

1408.7 Fireblocking. EIFS installations containing foam plastic insulation shall be fireblocked in accordance with Section 718.2.6.1.

1408.8 Foam plastic insulation. EIFS installations containing foam plastic insulation shall be tested and comply with the requirements of Section 2603.

1408.9 Thermal barrier. EIFS installations containing foam plastic insulation shall be separated from the interior of a building in accordance with Section 2603.5.2.

SECTION BC 1409
HIGH-PRESSURE DECORATIVE
EXTERIOR-GRADE COMPACT LAMINATES (HPL)

1409.1 General. The provisions of this section shall govern the materials, construction and quality of High-Pressure Decorative Exterior-Grade Compact Laminates (HPL) for use as exterior wall coverings in addition to other applicable requirements of Chapters 14 and 16.

1409.1.1 Prohibited locations. The use of HPL in exterior wall coverings is subject to the following limitations:

1. HPL is prohibited in exterior wall coverings in Type IV construction utilizing cross-laminated timber (CLT) or structural composite lumber (SCL) complying with Section 602.4.
2. HPL is prohibited in exterior wall coverings at exterior balconies and shall comply with Section 1406.3.

1409.2 Exterior wall finish. HPL used as exterior wall covering or as elements of bay and oriel windows to provide cladding or weather resistance shall comply with Sections 1409.4 through 1409.16.

1409.3 Architectural trim and embellishments. HPL used as architectural trim or embellishments shall comply with Sections 1409.7 through 1409.14.

1409.4 Structural design. HPL systems shall be designed and constructed to resist wind loads as required by Chapter 16 for components and cladding.

1409.5 Approval. Results of approved tests or an engineering analysis shall be submitted to the commissioner to verify compliance with the requirements of Chapter 16 for wind loads.

1409.6 Weather resistance. HPL systems shall comply with Section 1403 and shall be designed and constructed to resist wind and rain in accordance with this section and the manufacturer's instructions.

1409.7 Durability. HPL systems shall be constructed of approved materials that maintain the performance characteristics required in Section 1409 for the duration of use.

1409.8 Fire-resistance rating. Where HPL systems are used on exterior walls required to have a fire-resistance rating in accordance with Section 705, evidence shall be submitted to the commissioner that the required fire-resistance rating is maintained.

Exception: HPL systems not containing foam plastic insulation that are installed on the outer surface of a fire-resistance-rated exterior wall in a manner such that the attachments do not penetrate through the entire exterior wall assembly shall not be required to comply with this section.

1409.9 Surface-burning characteristics. HPL shall have a flame spread index of not more than 25 and a smoke-developed index of not more than 450 when tested in the minimum and maximum thicknesses intended for use in accordance with ASTM E 84 or UL 723.

1409.10 Thermal barriers. HPL shall be separated from the interior of a building by an approved thermal barrier consisting of ⁵/₈-inch (15.9 mm) Type X gypsum wallboard or equivalent thermal barrier material that will limit the average temperature rise of the unexposed surface to not more than 250°F (121°C) after 20 minutes of fire exposure in accordance with the standard time temperature curve of ASTM E 119 or UL 263. The thermal barrier shall be installed in accordance with criteria established by testing performed in accordance with UL 1715, where the thermal barrier shall remain in place for 20 minutes.

1409.11 Full-scale tests. All HPL systems shall be tested in accordance with, and comply with, the acceptance criteria of NFPA 285. Such testing shall be performed on the HPL system with the HPL in the minimum and maximum thicknesses intended for use, including any required fireblocking. Approved NFPA 285 tested assembly design documentation of the HPL system shall be included on the submitted construction documents complying with Section 1401.2 of this code. Deviation from the NFPA 285 tested design shall be approved by the registered design professional and additional documentation shall be provided if requested by the department.

1409.12 Reserved.

1409.13 Foam plastic insulation. HPL systems containing foam plastic insulation shall also comply with the requirements of Section 2603.

1409.14 Labeling. HPL shall be labeled in accordance with this code and Article 113 of title 28 of the *Administrative Code*.

1409.15 Special inspection. HPL shall be subject to the special inspection requirements of Chapter 17.

1407.16 Fireblocking. HPL installations shall be fireblocked in accordance with Section 718.2.6.1.

SECTION BC 1410
PLASTIC COMPOSITE DECKING

1410.1 Plastic composite decking. Exterior deck boards, stair treads, handrails and guardrail systems constructed of plastic composites, including plastic lumber, shall comply with Section 2612.

§ 16. Chapter 15 of the New York city building code, as amended by local law number 141 for the year 2013, sections 1507.3.9, 1507.5.7, 1507.8.8 and 1507.9.9 as amended by local law number 51 for the year 2014, and sections 1504.9 and 1511 as amended by local law number 94 for the year 2019, is amended to read as follows:

CHAPTER 15
ROOF ASSEMBLIES AND ROOFTOP STRUCTURES

SECTION BC 1501
GENERAL

1501.1 Scope. The provisions of this chapter shall govern the design, materials, construction and quality of roof assemblies, and rooftop structures.

SECTION BC 1502
DEFINITIONS

1502.1 [General] Definitions. The following terms [~~shall, for the purposes of this chapter and as used elsewhere in this code, have the meanings shown herein.~~] are defined in Chapter 2:

AGGREGATE. [~~In roofing, crushed stone, crushed slag or water worn gravel used for surfacing for roof coverings.~~]

BALLAST. [~~In roofing, ballast comes in the form of large stones or paver systems or light weight interlocking paver systems and is used to provide uplift resistance to components of the roof assembly systems that are not adhered or mechanically attached to the roof deck.~~]

BUILDING-INTEGRATED PHOTOVOLTAIC (BIPV) PRODUCT.

BUILT-UP ROOF COVERING. [~~Two or more layers of felt cemented together and surfaced with a cap sheet, mineral aggregate, smooth coating or similar surfacing material.~~]

BULKHEAD. [~~An enclosed rooftop structure enclosing a shaft, stairway, tank or service equipment, or other space not designed or used for human occupancy.~~]

CONTAINER GARDEN. [~~A plant or plants maintained in a pot or planters that is at least 6 inches (152 mm) high and located on a roof, terrace, or other horizontal exterior area.~~]

GREEN ROOF SYSTEM. [~~A system constructed in situ consisting of either a roof assembly and additional landscape material components, including growing media, engineered soils, filter fabric, integral drainage systems and roof surface to facilitate the growth of vegetation or a pre-vegetated~~]

~~tray or trays no more than 6 inches (152 mm) high and assembled on top of a roof covering.] “See definition for **VEGETATIVE ROOF.**”~~

~~**INTERLAYMENT.**[A layer of felt or nonbituminous saturated felt not less than 18 inches (457 mm) wide, shingled between each course of a wood shake roof covering.]~~

~~**MECHANICAL EQUIPMENT SCREEN.**[A partially enclosed rooftop structure used to aesthetically conceal heating, ventilating and air conditioning (HVAC) electrical or mechanical equipment from view.]~~

~~**METAL ROOF PANEL.**[An interlocking metal sheet having a minimum installed weather exposure of 3 square feet (.279 m²) per sheet.]~~

~~**METAL ROOF SHINGLE.**[An interlocking metal sheet having an installed weather exposure less than 3 square feet (.279 m²) per sheet.]~~

~~**MODIFIED BITUMEN ROOF COVERING.**[One or more layers of polymer modified asphalt sheets. The sheet materials shall be fully adhered or mechanically attached to the substrate or held in place with an approved ballast layer.]~~

~~**PENTHOUSE.**[An enclosed rooftop structure which is designed or used for human occupancy.]~~

PHOTOVOLTAIC MODULE.

PHOTOVOLTAIC PANEL.

PHOTOVOLTAIC PANEL SYSTEM.

PHOTOVOLTAIC SHINGLES.

~~**POSITIVE ROOF DRAINAGE.**[The drainage condition in which consideration has been made for all loading deflections of the roof deck, including ponding instability, and additional slope has been provided to ensure drainage of the roof within 48 hours of precipitation.]~~

RADIANT BARRIER.

~~**REROOFING.**[The process of recovering or replacing an existing roof covering. See “Roof recover” and “Roof replacement.”]~~

~~**ROOF ASSEMBLY.**[A system designed to provide weather protection and resistance to design loads. The system consists of a roof covering and roof deck or a single component serving as both the roof covering and the roof deck. A roof assembly includes the roof deck, substrate or thermal barrier, insulation, vapor retarder and roof covering. This definition of “Roof assembly” is limited in application to the provisions of Chapter 15.]~~

~~**ROOF COVERING.**[The covering applied to the roof deck for weather resistance, fire classification or appearance.]~~

~~**ROOF COVERING SYSTEM.**[See “Roof assembly.”]~~

ROOF DECK.~~[The flat or sloped surface not including its supporting members or vertical supports.]~~

ROOF RECOVER.~~[The process of installing an additional roof covering over a prepared existing roof covering without removing the existing roof covering.]~~

ROOF REPAIR.

ROOF REPLACEMENT.~~[The process of removing the existing roof covering, repairing any damaged substrate and installing a new roof covering.]~~

ROOF VENTILATION.~~[The natural or mechanical process of supplying conditioned or unconditioned air to, or removing such air from, attics, cathedral ceilings or other enclosed spaces over which a roof assembly is installed.]~~

ROOFTOP STRUCTURE.~~[An enclosed or unenclosed structure on or above the roof of any part of a building.]~~

SCUPPER.

SINGLE-PLY MEMBRANE.~~[A roofing membrane that is field applied using one layer of membrane material (either homogeneous or composite) rather than multiple layers.]~~

SUSTAINABLE ROOFING ZONE. [Areas of a roof assembly where a solar photovoltaic electricity generating system, a green roof system, or a combination thereof, is installed.]

UNDERLAYMENT. ~~[One or more layers of felt, sheathing paper, nonbituminous saturated felt or other approved material over which a steep slope roof covering is applied.]~~

VEGETATIVE ROOF.

**SECTION BC 1503
WEATHER PROTECTION**

1503.1 General. Roof decks shall be covered with approved roof coverings secured to the building or structure in accordance with the provisions of this chapter. Roof coverings shall be designed and installed in accordance with this code and the ~~[approved]~~ manufacturer's instructions such that the roof covering shall serve to protect the building or structure.

1503.2 Flashing. Flashing shall be installed in such a manner so as to prevent moisture entering the wall and roof through joints in copings, through moisture-permeable materials and at intersections with parapet walls and other penetrations through the roof plane.

1503.2.1 Locations. Flashing shall be installed at wall and roof intersections, at gutters, wherever there is a change in roof slope or direction and around roof openings. Where flashing is of metal, the metal shall be corrosion resistant with a thickness of not less than 0.019 inch (~~[.483]~~ 0.483 mm) (No. 26 galvanized sheet).

1503.3 Coping. Parapet walls shall be properly coped with noncombustible, weatherproof materials of a width no less than the thickness of the parapet wall.

1503.4 Roof drainage. Design and installation of roof drainage systems shall comply with ~~[this section and]~~ Chapter 11 of the *New York City Plumbing Code* and this section.

1503.4.1 Secondary ~~[drainage required]~~ (emergency overflow) drains or scuppers. ~~[Secondary]~~ Where roof drains are required, secondary (emergency overflow) roof drains or scuppers shall be provided where the roof perimeter construction extends above the roof in such a manner that water will be entrapped if the primary drains allow buildup for any reason. The installation and sizing of secondary (emergency overflow) drains, leaders and conductors shall comply with Chapter 11 of the *New York City Plumbing Code*, as applicable.

1503.4.2 Scuppers. When scuppers are used for secondary (emergency overflow) roof drainage, the quantity, size, location and inlet elevation of the scuppers shall be sized to prevent the depth of ponding water from exceeding that for which the roof was designed as determined by Section ~~[1503.4.1]~~ 1611.1. Scuppers shall not have an opening dimension of less than 4 inches (~~[102]~~ 101.6 mm). The flow through the primary system shall not be considered when locating and sizing scuppers.

1503.4.3 Gutters. Gutters ~~[and leaders]~~ placed on the outside of buildings shall be of noncombustible, corrosion-resistant material~~[, or a minimum of Schedule 40 plastic pipe]~~ in accordance with Chapter 11 of the *New York City Plumbing Code*. Gutters and vertical sections of exterior leaders shall be adequately anchored. Gutters and leaders installed more than 15 feet (4572 mm) above grade shall be designed to resist loads in accordance with Chapter 16 of this code.

1503.4.3 Gutters. Gutters ~~[and leaders]~~ placed on the outside of buildings shall be of noncombustible, corrosion-resistant ~~[material, or a minimum of Schedule 40 plastic pipe]~~ materials. Leaders placed on the outside of buildings shall be of noncombustible, corrosion-resistant materials in accordance with Chapter 11 of the *New York City Plumbing Code*.

~~[1503.4.3.1 Height limitations. Vertical sections of exterior leaders made from galvanized steel, galvanized wrought iron, cast iron, brass, or similar heavy material shall be permitted only for the first 15 feet (4572 mm) of leader extending up from grade, provided that the leader is securely anchored with offset clamps to the face of the building at no fewer than two points along the vertical section of the leader. Horizontal sections of exterior gutter made from such heavy materials shall not be permitted higher than 15 feet (4572 mm) above grade.]~~

1503.5 ~~[Roof ventilation.] Attic and rafter ventilation.~~ Intake and exhaust vents shall be provided in accordance with Section 1203.2 and the vent product's manufacturer's [installation] instructions.

1503.6 Crickets and saddles. A cricket or saddle shall be installed on the ridge side of any chimney or penetration greater than 30 inches (762 mm) wide as measured perpendicular to the slope. Cricket or saddle coverings shall be sheet metal or of the same material as the roof covering.

Exception: Unit skylights installed in accordance with Section 2405.5 and flashed in accordance with the manufacturer's instructions shall be permitted to be installed without a cricket or saddle.

**SECTION BC 1504
PERFORMANCE REQUIREMENTS**

1504.1 Wind resistance of roofs. Roof decks and roof coverings shall be designed for wind loads in accordance with Chapter 16 and Sections 1504.2, 1504.3 and 1504.4.

1504.1.1 Wind resistance of asphalt shingles. Asphalt shingles shall ~~[comply with Section 1507.2.]~~ be tested in accordance with ASTM D 7158. Asphalt shingles shall meet the classification requirements of Table 1504.1.1 of this code for the appropriate maximum wind speed. Asphalt shingle packaging shall bear a label to indicate compliance with ASTM D 7158 and the required classification in Table 1504.1.1 of this code.

Exception: Asphalt shingles that are not included in the scope of ASTM D 7158 shall be tested and labeled to indicate compliance with ASTM D 3161 and the required classification in Table 1504.1.1 of this code.

**TABLE 1504.1.1
CLASSIFICATION OF ASPHALT SHINGLES**

<u>MAXIMUM ALLOWABLE STRESS DESIGN WIND SPEED, V_{asd}</u>	<u>MAXIMUM BASIC DESIGN WIND SPEED, V, FROM TABLE 1609.3</u>	<u>ASTM D 7158^a CLASSIFICATION</u>	<u>ASTM D 3161 CLASSIFICATION</u>
88	110	D, G or H	A, D or F
94	117	G or H	A, D or F
102	127	G or H	F
106	132	G or H	F

1504.2 Wind resistance of clay and concrete tile. Wind loads on clay and concrete tile roof coverings shall be in accordance with Section 1609.

1504.2.1 Testing. Testing of concrete and clay roof tiles shall be in accordance with Sections 1504.2.1.1 and 1504.2.1.2.

1504.2.1.1 Overturning resistance. Concrete and clay roof tiles shall be tested to determine their resistance to overturning due to wind in accordance with SBCCI SSTD 11 and this chapter.

1504.2.1.2 Wind tunnel testing. Where concrete and clay roof tiles do not satisfy the limitations in Chapter 16 of this code for rigid tile, a wind tunnel test shall be used to determine the wind characteristics of the concrete or clay tile roof covering in accordance with SBCCI SSTD 11 and this chapter.

1504.3 Wind resistance of nonballasted roofs. Roof coverings installed on roofs in accordance with Section 1507 that are mechanically attached or adhered to the roof deck shall be designed to resist the design wind load pressures for components and cladding in accordance with Section 1609.

1504.3.1 Other roof systems. ~~[Roof systems with built-up]~~ Built-up, modified bitumen, fully adhered or mechanically attached single-ply [through fastened] roof systems, metal panel roof

systems[;] applied to a solid or closely fitted deck and other types of membrane roof coverings shall ~~also~~ be tested in accordance with FM 4474, UL 580 or UL 1897.

1504.3.2 ~~[Metal panel roof systems.]~~ **Structural metal panel roof systems.** ~~[Metal panel roof systems through fastened or standing seam]~~ Where the metal roof panel functions as the roof deck and roof covering and it provides both weather protection and support for loads, the structural metal panel roof system shall comply with this section. Structural standing-seam metal panel roof systems shall be tested in accordance with ASTM E 1592 or FM 4474. Structural through-fastened metal panel roof systems shall be tested in accordance with FM 4474, UL 580 or ASTM E 1592.

~~[Exception: Metal roofs constructed of cold-formed steel, where the roof deck acts as the roof covering and provides both weather protection and support for structural loads, shall be permitted to be designed and tested in accordance with the applicable referenced structural design standard in Section 2209.1.]~~

Exceptions:

1. Metal roofs constructed of cold-formed steel shall be permitted to be designed and tested in accordance with the applicable referenced structural design standard in Section 2210.1.
2. Metal roofs constructed of aluminum shall be permitted to be designed and tested in accordance with the applicable referenced structural design standard in Section 2002.1.

1504.4 Ballasted low-slope roof systems. Ballasted low-slope (roof slope < 2:12) single-ply roof system coverings installed in accordance with Sections 1507.12 and 1507.13 shall be designed in accordance with ANSI/SPRI RP-4 and Section 1504.8 ~~[and ANSI/SPRI RP-4]~~ of this code.

1504.5 Edge securement for low-slope roofs. Low-slope membrane roof systems metal edge securement, except gutters, shall be designed and installed for wind loads in accordance with Chapter 16 and tested for resistance in accordance with ~~[ANSI/SPRI ES-1,]~~ Test Methods RE-1, RE-2 and RE-3 of ANSI/SPRI/FM 4435 ES-1, except the basic design wind speed V shall be determined in accordance with Chapter 16 of this code.

1504.6 Physical properties. Roof coverings installed on low-slope roofs (roof slope < 2:12) in accordance with Section 1507 shall demonstrate physical integrity over the working life of the roof based upon 2,000 hours of exposure to accelerated weathering tests conducted in accordance with ASTM G 152, ASTM G 155 or ASTM G 154. Those roof coverings that are subject to cyclical flexural response due to wind loads shall not demonstrate any significant loss of tensile strength for unreinforced membranes or breaking strength for reinforced membranes when tested as herein required.

1504.7 Impact resistance. Roof coverings installed on low-slope roofs (roof slope < 2:12) in accordance with Section 1507 shall resist impact damage based on the results of tests conducted in accordance with ASTM D 3746, ASTM D 4272, CGSB 37-GP-52M or the “Resistance to Foot Traffic Test” in Section 5.5 of FM 4470.

1504.8 [Aggregate.] Surfacing and ballast materials. Aggregate, gravel or crushed stone shall not be used as surfacing for roof coverings. ~~and aggregate, gravel or stone used as ballast shall not be used on the roof of a building located in a hurricane prone region as defined in Section 1609.2, or on any other building with a mean roof height exceeding that permitted by Table 1504.8 based on the exposure category and basic wind speed at the site.]~~

**[TABLE 1504.8
MAXIMUM ALLOWABLE MEAN ROOF HEIGHT
PERMITTED FOR BUILDINGS WITH AGGREGATE ON THE
ROOF IN AREAS OUTSIDE A HURRICANE PRONE REGION^d**

BASIC WIND SPEED FROM SECTION 1609.3 (mph) ^b	MAXIMUM MEAN ROOF HEIGHT (ft) ^{a,c}		
	Exposure category		
	B	C	D
85	170	60	30
90	110	35	15
95	75	20	NP
100	55	15	NP
105	40	NP	NP
110	30	NP	NP
115	20	NP	NP
120	15	NP	NP
Greater than 120	NP	NP	NP

For SI: 1 foot = 304.8 mm; 1 mile per hour = 0.447 m/s.

a. Mean roof height as defined in ASCE 7.

b. For intermediate values of basic wind speed, the height associated with the next higher value of wind speed shall be used, or direct interpolation is permitted.

c. NP = gravel and stone not permitted for any roof height.

d. New York City is in a Hurricane Prone Region pursuant to Section 1609.2.

1504.9 Reflectance. Roof coverings on roofs or setbacks with slope equal to or less than two units vertical in 12 units horizontal (17 percent) shall have:

1. A minimum initial solar reflectance of 0.7 in accordance with ASTM C 1549 or ASTM E 1918, and a minimum thermal emittance of 0.75 as determined in accordance with ASTM C 1371 or ASTM E 408; or
2. A minimum SRI of 82 as determined in accordance with ASTM E 1980.

Roof coverings on roofs or setbacks with slope greater than two units vertical in 12 units horizontal (17 percent) shall have:

1. A minimum initial solar reflectance of 0.25 in accordance with ASTM C 1549 or ASTM E 1918, and a minimum thermal emittance of 0.75 as determined in accordance with ASTM C 1371 or ASTM E 408; or
2. A minimum SRI of 39 as determined in accordance with ASTM E 1980.

Exceptions:

1. Terraces on setbacks comprising less than 25 percent of the area of the largest floor

plate in the building.

2. Any portion of a roof covered by a green roof system, including such a system with agricultural plantings, in compliance with Section 1507.16 of this code.
3. Any portion of a roof used as outdoor recreation space by the occupants of the building that is landscaped, covered by wood decking or covered with a walking surface or other protective surface, provided that such walking surface or protective surface has a minimum initial solar reflectance of 0.3 as determined in accordance with ASTM C 1549 or ASTM E 1918.
4. Ballasted roofs, provided that the ballast has a minimum initial solar reflectance of 0.2 as determined in accordance with ASTM C 1549 or ASTM E 1918.
5. Any portion of a roof that is under mechanical equipment, duckboarding, decking, platform, roof tank, cooling tower or any other rooftop structure or equipment exempted by rule by the commissioner.
6. Any roof or portion of a roof composed of glass, metal, clay or concrete tile or plastic/rubber intended to simulate clay or concrete tile, wood, or slate.
7. Any portion of a roof used by a school or daycare center as a playground for children.
8. Any roof, if the amount of rooftop space not subject to exceptions 1 through 7 is in the aggregate less than 100 square feet (9.3 m²).

**SECTION BC 1505
FIRE CLASSIFICATION**

1505.1 General. Roof assemblies shall be divided into the classes defined below. Class A, B and C roof assemblies and roof coverings required to be listed by this section shall be tested in accordance with ASTM E 108 or UL 790. In addition, fire-retardant-treated wood roof coverings shall be tested in accordance with ASTM D 2898. The minimum roof coverings installed on buildings shall comply with Table 1505.1 of this code based on the type of construction of the building.

Exception: Skylights and sloped glazing that comply with Chapter 24 or Section 2610 of this code.

**TABLE 1505.1^{a,b}
MINIMUM ROOF COVERING CLASSIFICATION
FOR TYPES OF CONSTRUCTION**

IA	IB	IIA	IIB	IIIA	IIIB	IV	VA	VB
B	B	B	B	B	B	B	B	C ^b

For SI: 1 foot = 304.8 mm, 1 square foot = 0.0929 m².

- a. Unless otherwise required due to the location of the building within a fire district in accordance with Section D102.2.3 in Appendix D.
- b. Buildings that are not more than two stories above grade plane and having not more than 6,000 square feet (557.4 m²) of projected roof area and where there is a minimum 10-foot fire-separation distance from the leading edge of the roof to a lot line on all sides of the building, except for street fronts or public ways, shall be permitted to have roofs of No. 1 cedar or redwood shakes and No. 1 shingles in accordance with Section 1505.6.

1505.2 Class A roof assemblies. Class A roof assemblies are those that are effective against severe fire test exposure. Class A roof assemblies and roof coverings shall be listed and identified as Class A by an approved testing agency. Class A roof assemblies shall be permitted for use in buildings or structures of all types of construction.

Exceptions:

1. Class A roof assemblies include those with coverings of brick, masonry, or an exposed concrete roof deck.
2. Class A roof assemblies also include ferrous or copper shingles or sheets, metal sheets and shingles, clay or concrete roof tile or slate installed on noncombustible decks or ferrous, copper or metal sheets installed without a roof deck on noncombustible framing.
3. Class A roof assemblies include minimum 16 ounce per square foot (0.0416 kg/m²) copper sheets installed over combustible decks.
4. Class A roof assemblies include slate installed over ASTM D 226, Type II underlayment over combustible decks.

1505.3 Class B roof assemblies. Class B roof assemblies are those that are effective against moderate fire-test exposure. Class B roof assemblies and roof coverings shall be listed and identified as Class B by an approved testing agency.

1505.4 Class C roof assemblies. Class C roof assemblies are those that are effective against light fire-test exposure. Class C roof assemblies and roof coverings shall be listed and identified as Class C by an approved testing agency.

1505.5 Construction of sloping roofs. Roofs having a slope of more than 60 degrees (1.05 rad) to the horizontal shall be constructed of material having the same fire-resistance rating as required for an exterior nonbearing wall of the building of which it is a part. When the slope is 60 degrees (1.05 rad) or less to the horizontal, the sloping roof shall be constructed as required for the roof of the building. Where the back of a false mansard is exposed to the outdoors, the back shall be covered with noncombustible material or with roof covering as required for the roof of the building.

1505.6 Fire-retardant-treated wood shingles and shakes. Fire-retardant-treated wood shakes and shingles shall be treated by impregnation with chemicals by the full-cell vacuum-pressure process, in accordance with AWWA C1. Each bundle shall be marked to identify the manufactured unit and the manufacturer, and shall also be labeled to identify the classification of the material in accordance with the testing required in Section 1505.1, the treating company and the quality control agency.

1505.7 Special purpose roofs. Special purpose wood shingle or wood shake roofing shall conform ~~[with]~~ to the grading and application requirements of Section 1507.8 or Section 1507.9. In addition, an underlayment of $\frac{5}{8}$ -inch (15.9 mm) Type X water-resistant gypsum backing board or gypsum sheathing shall be placed under minimum nominal $\frac{1}{2}$ -inch~~[-thick]~~ (12.7 mm) thick wood structural panel solid sheathing or 1-inch (~~[25]~~ 25.4 mm) nominal spaced sheathing.

~~1505.8 [Photovoltaic systems. Rooftop installed photovoltaic systems that are adhered or attached to the roof covering or photovoltaic modules/shingles installed as roof coverings shall be labeled to identify their fire classification in accordance with the testing required in Section 1505.1.]~~ **Building-integrated photovoltaic products.** Building-integrated photovoltaic products installed as the roof covering shall be tested, listed and labeled for fire classification in accordance with Section 1505.1.

1505.9 Photovoltaic panels and modules. Rooftop-mounted photovoltaic panel systems shall be tested, listed and identified with a fire classification in accordance with UL 1703. The fire classification shall comply with Table 1505.1 of this code based on the type of construction of the building.

1505.10 Roof gardens and landscaped roofs. Roof gardens and landscaped roofs shall comply with Section 1507.16.

SECTION BC 1506 MATERIALS

1506.1 Scope. The requirements set forth in this section shall apply to the application of roof-covering materials specified herein. Roof coverings shall be applied in accordance with this chapter and the manufacturer's [~~installation~~] instructions. Installation of roof coverings shall comply with the applicable provisions of Section 1507.

~~1506.2 [Compatibility of materials. Roofs and roof coverings shall be of materials that are compatible with each other and with the building or structure to which the materials are applied.]~~

~~[1506.3]~~ **1506.3 Material specifications and physical characteristics.** Roof-covering materials shall conform to the applicable standards listed in this chapter. In the absence of applicable standards or where materials are of questionable suitability, testing by an approved agency shall be required by the commissioner to determine the character, quality and limitations of application of the materials.

~~[1506.4]~~ **1506.3 Product identification.** Roof-covering materials shall be delivered in packages bearing the manufacturer's identifying marks and approved testing agency labels required in accordance with Section 1505. Bulk shipments of materials shall be accompanied with the same information issued in the form of a certificate or on a bill of lading by the manufacturer.

SECTION BC 1507 REQUIREMENTS FOR ROOF COVERINGS

1507.1 Scope. Roof coverings shall be applied in accordance with the applicable provisions of this section and the manufacturer's [~~installation~~] instructions.

1507.2 Asphalt shingles. The installation of asphalt shingles shall comply with the provisions of this section.

1507.2.1 Deck requirements. Asphalt shingles shall be fastened to solidly sheathed decks.

1507.2.2 Slope. Asphalt shingles shall only be used on roof slopes of two units vertical in 12 units horizontal (17-percent slope) or greater. For roof slopes from two units vertical in 12 units

horizontal (17-percent slope) up to four units vertical in 12 units horizontal (33-percent slope), double underlayment application is required in accordance with Section 1507.2.8.

1507.2.3 Underlayment. Unless otherwise noted, required underlayment shall conform to ASTM D 226, Type I, ASTM D 4869, Type I, or ASTM D 6757.

1507.2.4 Self-adhering polymer modified bitumen sheet. Self-adhering polymer modified bitumen sheet shall comply with ASTM D 1970.

1507.2.5 Asphalt shingles. Asphalt shingles shall comply with ASTM D 225 or ASTM D 3462.

1507.2.6 Fasteners. Fasteners for asphalt shingles shall be galvanized, stainless steel, aluminum or copper roofing nails, minimum ~~[12-gage]~~ 12-gage (0.105 ~~[inches]~~-inch (2.67 mm)) shank with a minimum 3/8 inch-diameter (9.5 mm) head, of a length to penetrate through the roofing materials and a minimum of 3/4 inch (19.1 mm) into the roof sheathing. Where the roof sheathing is less than 3/4 inch (19.1 mm) thick, the nails shall penetrate through the sheathing. Fasteners shall comply with ASTM F 1667.

1507.2.7 Attachment. Asphalt shingles shall have the minimum number of fasteners required by the manufacturer, but not less than four fasteners per strip shingle or two fasteners per individual shingle. Where the roof slope exceeds 21 units vertical in 12 units horizontal (21:12), shingles shall be installed as required by the manufacturer.

~~[1507.2.7.1 Wind resistance. Asphalt shingles shall be tested in accordance with ASTM D 7158. Asphalt shingles shall meet the classification requirements of Table 1507.2.7.1(1) for the maximum basic wind speed per Section 1609. Asphalt shingle packaging shall bear a label to indicate compliance with ASTM D 7158 and the required classification in Table 1507.2.7.1(1).]~~

~~[Exception: Asphalt shingles not included in the scope of ASTM D 7158 shall be tested and labeled to indicate compliance with ASTM D 3161 and the required classification in Table 1507.2.7.1(2).]~~

~~[TABLE 1507.2.7.1(1)
CLASSIFICATION OF ASPHALT ROOF PER
ASTM D 7158*~~

MAXIMUM BASIC WIND SPEED FROM SECTION 1609	CLASSIFICATION REQUIREMENT
85	D, G, or H
90	D, G, or H
100	G or H
110	G or H
120	G or H
130	H
140	H

**[TABLE 1507.2.7.1(1)
CLASSIFICATION OF ASPHALT ROOF PER
ASTM D 7158^a**

MAXIMUM BASIC WIND SPEED FROM SECTION 1609	CLASSIFICATION REQUIREMENT
150	H

a. The standard calculations contained in ASTM D 7158 assume exposure category B or C and building height of 60 feet (18 288 mm) or less. Additional calculations are required for conditions outside of these assumptions.

**[TABLE 1507.2.7.1(2)
CLASSIFICATION OF ASPHALT SHINGLES PER
ASTM D 3161**

MAXIMUM BASIC WIND SPEED FROM SECTION 1609	CLASSIFICATION REQUIREMENT
85	A, D or F
90	A, D or F
100	A, D or F
110	F
120	F
130	F
140	F
150	F

1507.2.8 Underlayment application. For roof slopes from two units vertical in 12 units horizontal (17-percent slope) up to four units vertical in 12 units horizontal (33-percent slope), underlayment shall be two layers applied in the following manner. Apply a minimum 19-inch[-wide] ([483] 482.6 mm) wide strip of underlayment felt parallel with and starting at the eaves, fastened sufficiently to hold in place. Starting at the eave, apply 36-inch[-wide] ([914] 914.4 mm) wide sheets of underlayment overlapping successive sheets 19 inches ([483] 482.6 mm) and fastened sufficiently to hold in place. Distortions in the underlayment shall not interfere with the ability of the shingles to seal. For roof slopes of four units vertical in 12 units horizontal (33-percent slope) or greater, underlayment shall be one layer applied in the following manner. Underlayment shall be applied shingle fashion, parallel to and starting from the eave and lapped 2 inches ([51] 50.8 mm), fastened only as necessary to hold in place. Distortions in the underlayment shall not interfere with the ability of the shingles to seal.

1507.2.8.1 Ice barrier. An ice barrier that consists of at least two layers of underlayment cemented together or of a self-adhering polymer modified bitumen sheet shall be used in lieu of normal underlayment and extend from the lowest edges of all roof surfaces to a point at least 24 inches ([610] 609.6 mm) inside the exterior wall line of the building.

Exception: Detached accessory structures that contain no conditioned floor area.

1507.2.9 Flashings. Flashing for asphalt shingles shall comply with this section. Flashing shall be applied in accordance with this section and the asphalt shingle manufacturer’s [printed] instructions.

1507.2.9.1 Base and cap flashing. Base and cap flashing shall be installed in accordance with the manufacturer’s instructions. Base flashing shall be of either corrosion-resistant metal of minimum nominal 0.019-inch (0.483 mm) thickness or mineral-surfaced roll roofing weighing a minimum of 77 pounds per 100 square feet (3.76 kg/m²). Cap flashing shall be corrosion-resistant metal of minimum nominal 0.019-inch (0.483 mm) thickness.

1507.2.9.2 Valleys. Valley linings shall be installed in accordance with the manufacturer’s instructions before applying shingles. Valley linings of the following types shall be permitted:

1. For open valleys (valley lining exposed) lined with metal, the valley lining shall be at least 24 inches ([610] 609.6 mm) wide and of any of the corrosion-resistant metals in Table 1507.2.9.2.
2. For open valleys, valley lining of two plies of mineral-surfaced roll roofing complying with ASTM D 3909 or ASTM D 6380 shall be permitted. The bottom layer shall be 18 inches ([457] 457.2 mm) and the top layer a minimum of 36 inches ([914] 914.4 mm) wide.
3. For closed valleys (valleys covered with shingles), valley lining of one ply of smooth roll roofing complying with ASTM D 6380, and at least 36 inches ([914] 914.4 mm) wide or types as described in Item 1 or 2 above shall be permitted. Self-adhering polymer modified bitumen underlayment complying with ASTM D 1970 shall be permitted in lieu of the lining material.

**TABLE 1507.2.9.2
VALLEY LINING MATERIAL**

MATERIAL	MINIMUM THICKNESS	GAGE	WEIGHT
Aluminum	0.024 in.	—	—
Cold-rolled copper	0.0216 in.	—	ASTM B 370, 16 oz. per [sq-] square ft.
Copper	—	—	16 oz.
Galvanized steel	0.0179 in.	26 (zinc-coated G90)	—
High-yield copper	0.0162 in.	—	ASTM B 370, 12 oz. per [sq-] square ft.
Lead	—	—	2.5 pounds

**TABLE 1507.2.9.2
VALLEY LINING MATERIAL**

MATERIAL	MINIMUM THICKNESS	GAGE	WEIGHT
Lead-coated copper	0.0216 in.	—	ASTM B 101, 16 oz. per square [foot] <u>ft.</u>
Lead-coated high-yield copper	0.0162 <u>in.</u>	—	ASTM B 101, 12 oz. per [sq.] <u>square ft.</u>
Painted terne	—	—	20 pounds
Stainless steel	—	28	—
Zinc alloy	0.027 in.	—	—

For SI: 1 inch = 25.4 mm, 1 pound = 0.454 kg, 1 ounce = 28.35 g, 1 square foot = 0.0929 m².

1507.2.9.3 Drip edge. ~~[Provide drip edge at eaves and gables of shingle roofs. Overlap to be a minimum of 2 inches (51 mm). Eave drip edges shall extend ¼ inch (6.4 mm) below sheathing and extend back on the roof a minimum of 2 inches (51 mm). Drip edge shall be mechanically fastened a maximum of 12 inches (305 mm) o.c.]~~ A drip edge shall be provided at eaves and rake edges of shingle roofs. Adjacent segments of the drip edge shall be lapped a minimum of 2 inches (50.8 mm). The vertical leg of drip edges shall be a minimum of 1½ inches (38.1 mm) in width and shall extend a minimum of ¼ inch (6.4 mm) below sheathing. The drip edge shall extend back on the roof a minimum of 2 inches (50.8 mm). Underlayment shall be installed over drip edges along eaves. Drip edges shall be installed over underlayment along rake edges. Drip edges shall be mechanically fastened a maximum of 12 inches (304.8 mm) on center.

1507.3 Clay and concrete tile. The installation of clay and concrete tile shall comply with the provisions of this section.

1507.3.1 Deck requirements. Concrete and clay tile shall be installed only over solid sheathing or spaced structural sheathing boards.

1507.3.2 Deck slope. Clay and concrete roof tile shall be installed on roof slopes of 2½ units vertical in 12 units horizontal (21-percent slope) or greater. For roof slopes from 2½ units vertical in 12 units horizontal (21-percent slope) to four units vertical in 12 units horizontal (33-percent slope), double underlayment application is required in accordance with Section 1507.3.3.

1507.3.3 Underlayment. Unless otherwise noted, required underlayment shall conform to: ASTM D 226, Type II; ASTM D 2626 or ASTM D 6380, Class M mineral-surfaced roll roofing.

1507.3.3.1 Low-slope roofs. For roof slopes from 2½ units vertical in 12 units horizontal (21-percent slope), up to four units vertical in 12 units horizontal (33-percent slope), underlayment shall be a minimum of two layers applied as follows:

1. Starting at the eave, a 19-inch (~~[483]~~ 482.6 mm) strip of underlayment shall be applied parallel with the eave and fastened sufficiently in place.
2. Starting at the eave, 36-inch~~[-wide]~~ (~~[914]~~ 914.4 mm) wide strips of underlayment felt shall be applied overlapping successive sheets 19 inches (~~[483]~~ 482.6 mm) and fastened sufficiently in place.

1507.3.3.2 High-slope roofs. For roof slopes of four units vertical in 12 units horizontal (33-percent slope) or greater, underlayment shall be a minimum of one layer of underlayment felt applied shingle fashion, parallel to, and starting from the eaves and lapped 2 inches (~~[54]~~ 50.8 mm), fastened only as necessary to hold in place.

1507.3.4 Clay tile. Clay roof tile shall comply with ASTM C 1167.

1507.3.5 Concrete tile. Concrete roof tile shall comply with ASTM C 1492.

1507.3.6 Fasteners. Tile fasteners shall be corrosion resistant and not less than 11 gage, ⁵/₁₆-inch (8.0 mm) head, and of sufficient length to penetrate the deck a minimum of ³/₄ inch (19.1 mm) or through the thickness of the deck, whichever is less. Attaching wire for clay or concrete tile shall be not ~~[be smaller]~~ less than 0.083 inch (2.1 mm). Perimeter fastening areas include three tile courses but not less than 36 inches (~~[914]~~ 914.4 mm) from either side of hips or ridges and edges of eaves and gable rakes.

1507.3.7 Attachment. Clay and concrete roof tiles shall be fastened in accordance with Table 1507.3.7.

**TABLE 1507.3.7
CLAY AND CONCRETE TILE ATTACHMENT^{a,b,c}**

GENERAL - CLAY OR CONCRETE ROOF TILE			
Maximum [basic wind speed] Nominal Design Wind Speed, V_{as}^d (mph)	Mean roof height (feet)	Roof slope [up to] \leq <u>3:12</u>	Roof slope 3:12 and over
85	0-60	One fastener per tile. Flat tile without vertical laps, two fasteners per tile.	Two fasteners per tile. Only one fastener on slopes of 7:12 and less for tiles with installed weight exceeding 7.5 lbs./sq. ft. having a width not more than 16 inches.
100	0-40		
100	>40-60	The head of all tiles shall be nailed. The nose of all eave tiles shall be fastened with approved clips. All rake tiles shall be nailed with two nails. The nose of all ridge, hip and rake tiles shall be set in a bead of roofer's mastic.	
110	0-60	The fastening system shall resist the wind forces in Section [1609.7.3] 1609.5.3.	
120	0-60	The fastening system shall resist the wind forces in Section [1609.7.3] 1609.5.3.	
130	0-60	The fastening system shall resist the wind forces in Section [1609.7.3] 1609.5.3.	
All	>60	The fastening system shall resist the wind forces in Section [1609.7.3] 1609.5.3.	
INTERLOCKING CLAY OR CONCRETE ROOF TILE WITH PROJECTING ANCHOR LUGS^{d,e} (Installations on spaced/solid sheathing with battens or spaced sheathing)			

**TABLE 1507.3.7
CLAY AND CONCRETE TILE ATTACHMENT^{a,b,c}
GENERAL - CLAY OR CONCRETE ROOF TILE**

Maximum [basic wind speed] Nominal Design Wind Speed, V_{asd}^f (mph)	Mean roof height (feet)	Roof slope [up to] \leq 3:12	Roof slope 3:12 and over	
Maximum [basic wind speed] Nominal Design Wind Speed, V_{asd}^f (mph)	Mean roof height (feet)	Roof slope [up to] < 5:12	Roof slope 5:12 < 12:12	Roof slope 12:12 and over
85	0-60	Fasteners are not required. Tiles with installed weight less than 9 lbs./sq. ft. require a minimum of one fastener per tile.	One fastener per tile every other row. All perimeter tiles require one fastener. Tiles with installed weight less than 9 lbs./sq. ft. require a minimum of one fastener per tile.	One fastener required for every tile. Tiles with installed weight less than 9 lbs./sq. ft. require a minimum of one fastener per tile.
100	0-40			
100	>40-60	The head of all tiles shall be nailed. The nose of all eave tiles shall be fastened with approved clips. All rake tiles shall be nailed with two nails. The nose of all ridge, hip and rake tiles shall be set in a bead of roofer's mastic.		
110	0-60	The fastening system shall resist the wind forces in Section [1609.7.3] 1609.5.3.		
120	0-60	The fastening system shall resist the wind forces in Section [1609.7.3] 1609.5.3.		
130	0-60	The fastening system shall resist the wind forces in Section [1609.7.3] 1609.5.3.		
All	>60	The fastening system shall resist the wind forces in Section [1609.7.3] 1609.5.3.		
INTERLOCKING CLAY OR CONCRETE ROOF TILE WITH PROJECTING ANCHOR LUGS (Installations on solid sheathing without battens)				
Maximum [basic wind speed] Nominal Design Wind Speed, V_{asd}^f (mph)	Mean roof height (feet)	All roof slopes		
85	0-60	One fastener per tile.		
100	0-40	One fastener per tile.		
100	>40-60	The head of all tiles shall be nailed. The nose of all eave tiles shall be fastened with approved clips. All rake tiles shall be nailed with two nails. The nose of all ridge, hip and rake tiles shall be set in a bead of roofer's mastic.		
110	0-60	The fastening system shall resist the wind forces in Section [1609.7.3] 1609.5.3.		
120	0-60	The fastening system shall resist the wind forces in Section [1609.7.3] 1609.5.3.		
130	0-60	The fastening system shall resist the wind forces in Section [1609.7.3] 1609.5.3.		
All	>60	The fastening system shall resist the wind forces in Section [1609.7.3] 1609.5.3.		

For SI: 1 inch = 25.4 mm, 1 foot = 304.8 mm, 1 mile per hour = 0.447 m/s, 1 pound per square foot = 4.882 kg/m².

- Minimum fastener size. Corrosion-resistant nails not less than No. 11 gage with ⁵/₁₆-inch head. Fasteners shall be long enough to penetrate into the sheathing ³/₄-inch or through the thickness of the sheathing, whichever is less. Attaching wire for clay and concrete tile shall not be smaller than 0.083 inch.
- Snow areas. A minimum of two fasteners per tile are required or battens and one fastener.
- Roof slopes greater than 24:12. The nose of all tiles shall be securely fastened.
- Horizontal battens. Battens shall be not less than 1 inch by 2 inch nominal. Provisions shall be made for drainage by a minimum of ¹/₈-inch riser at each nail or by 4-foot-long battens with at least a ¹/₂-inch separation between battens. Horizontal battens are required for slopes over 7:12.

- e. Perimeter fastening areas include three tile courses but not less than 36 inches from either side of hips or ridges and edges of eaves and gable rakes.
- f. V_{end} shall be determined in accordance with Section 1609.3.1.

1507.3.8 Application. Tile shall be applied according to the manufacturer's [~~installation~~] instructions, based on the following:

1. Climatic conditions.
2. Roof slope.
3. Underlayment system.
4. Type of tile being installed.

1507.3.9 Flashing. At the juncture of the roof vertical surfaces, flashing and counterflashing shall be provided in accordance with the manufacturer's [~~installation~~] instructions, and where of metal, shall not be less than 0.019-inch (0.483 mm) (No. 26 galvanized sheet gage) corrosion-resistant metal. The valley flashing shall extend at least 11 inches (279 mm) from the centerline each way and have a splash diverter rib not less than 1 inch (~~[25]~~ 25.4 mm) high at the flow line formed as part of the flashing. Sections of flashing shall have an end lap of not less than 4 inches (~~[102]~~ 101.6 mm). For roof slopes of three units vertical in 12 units horizontal (25-percent slope) and over, the valley flashing shall have a 36-inch [~~-wide~~] (~~[914]~~ 914.4 mm) wide underlayment of either one layer of Type I underlayment running the full length of the valley, or a self-adhering polymer-modified bitumen sheet complying with ASTM D 1970, in addition to other required underlayment. For slopes under seven units vertical in 12 units horizontal (58-percent slope), the metal valley flashing underlayment shall be solid cemented to the roofing underlayment or a self-adhering polymer modified bitumen sheet shall be installed.

1507.4 Metal roof panels. The installation of metal roof panels shall comply with the provisions of this section.

1507.4.1 Deck requirements. Metal roof panel roof coverings shall be applied to a solid or closely fitted deck, except where the roof covering is specifically designed to be applied to spaced supports.

1507.4.2 Deck slope. The minimum slope for metal roof panels shall comply with the following:

1. The minimum slope for lapped, nonsoldered seam metal [~~roofs~~] roof panels without applied lap sealant shall be three units vertical in 12 units horizontal (25-percent slope).
2. The minimum slope for lapped, nonsoldered seam metal [~~roofs~~] roof panels with applied lap sealant shall be one-half unit vertical in 12 units horizontal (4-percent slope). Lap sealants shall be applied in accordance with the [~~approved~~] manufacturer's [~~installation~~] instructions.
3. The minimum slope for standing-seam [~~of~~] metal roof panel systems shall be one-quarter unit vertical in 12 units horizontal (2-percent slope).

1507.4.3 Material standards. Metal-sheet roof covering systems that incorporate supporting structural members shall be designed in accordance with Chapter 22. Metal-sheet roof coverings

installed over structural decking shall comply with Table 1507.4.3(1). The materials used for metal-sheet roof coverings shall be naturally corrosion resistant or provided with corrosion resistance in accordance with the standards and minimum thicknesses shown in Table 1507.4.3(2).

**TABLE 1507.4.3(1)
METAL ROOF COVERINGS**

ROOF COVERING TYPE	STANDARD APPLICATION RATE/THICKNESS
Aluminum	ASTM B 209, 0.024 inch minimum thickness for roll-formed panels and 0.019 inch minimum thickness for press-formed shingles.
Aluminum-zinc alloy coated steel	ASTM A 792 AZ 50
Cold-rolled copper	ASTM B 370 minimum 16 oz./sq. ft. and 12 oz./sq. ft. high yield copper for metal-sheet roof covering systems: 12 oz./sq. ft. for [pre-formed] <u>pre-formed</u> metal shingle systems.
Copper	16 oz./sq. ft. for metal-sheet roof-covering systems; 12 oz./sq. ft. for preformed metal shingle systems.
Galvanized steel	ASTM A 653 G-90 zinc-coated ^a [;]
Hard [Lead] <u>lead</u>	2 lbs./sq. ft.
Lead-coated copper	ASTM B 101
Prepainted steel	ASTM A 755
Soft [Lead] <u>lead</u>	3 lbs./sq. ft.
Stainless steel	ASTM A 240, 300 Series Alloys
Steel	ASTM A 924
Terne and terne-coated stainless	Terne coating of 40 lbs. per double base box, field painted where applicable in accordance with manufacturer's [installation] instructions.
Zinc	0.027 inch minimum thickness; 99.995% electrolytic high grade zinc with alloy additives of copper (0.08% - 0.20%), titanium (0.07% - 0.12%) and aluminum (0.015%).

For SI: 1 ounce per square foot = ~~[0.0026]~~ 0.305 kg/m², 1 pound per square foot = 4.882 kg/m², 1 inch = 25.4 mm, 1 pound = 0.454 kg.

a. For Group U buildings, the minimum coating thickness for ASTM A 653 galvanized steel roofing shall be G-60.

**TABLE 1507.4.3(2)
MINIMUM CORROSION RESISTANCE**

<u>MATERIAL</u>	<u>STANDARD</u>
55% Aluminum-zinc alloy coated steel	ASTM A 792 AZ 50
5% Aluminum alloy-coated steel	ASTM A 875 GF60
Aluminum-coated steel	ASTM A 463 T2 65
Galvanized steel	ASTM A 653 G-90
Prepainted steel	ASTM A 755 ^a

a. Paint systems in accordance with ASTM A 755 shall be applied over steel products with corrosion-resistant coatings complying with ASTM A 792, ASTM A 875, ASTM A 463 or ASTM A 653.

1507.4.4 Attachment. Metal roof panels shall be secured to the supports in accordance with the approved manufacturer's fasteners. In the absence of manufacturer recommendations, the following fasteners shall be used:

1. Galvanized fasteners shall be used for steel roofs.
2. Copper, brass, bronze, copper alloy or 300 series stainless-steel fasteners shall be used for copper roofs.
3. Stainless-steel fasteners are acceptable for all types of metal roofs.
4. Aluminum fasteners are acceptable for aluminum roofs attached to aluminum supports.

1507.5 Metal roof shingles. The installation of metal roof shingles shall comply with the provisions of this section.

1507.5.1 Deck requirements. Metal roof shingles shall be applied to a solid or closely fitted deck, except where the roof covering is specifically designed to be applied to spaced sheathing.

1507.5.2 Deck slope. Metal roof shingles shall not be installed on roof slopes below three units vertical in 12 units horizontal (25-percent slope).

1507.5.3 Underlayment. Underlayment shall comply with ASTM D 226, Type I or ASTM D 4869.

1507.5.4 Ice barrier. An ice barrier that consists of at least two layers of underlayment cemented together or of a self-adhering polymer-modified bitumen sheet, shall be used in lieu of normal underlayment and extend from the lowest edges of all roof surfaces to a point at least 24 inches (~~[610]~~ 609.6 mm) inside the exterior wall line of the building.

Exception: Detached accessory structures that contain no conditioned floor area.

1507.5.5 Material standards. Metal roof shingle roof coverings shall comply with Table 1507.4.3(1). The materials used for metal-roof shingle roof coverings shall be naturally corrosion resistant or provided with corrosion resistance in accordance with the standards and minimum thicknesses specified in the standards listed in Table 1507.4.3(2).

1507.5.6 Attachment. Metal roof shingles shall be secured to the roof in accordance with the ~~[approved]~~ manufacturer's ~~[installation]~~ instructions.

1507.5.7 Flashing. Roof valley flashing shall be of corrosion-resistant metal of the same material as the roof covering or shall comply with the standards in Table 1507.4.3(1). The valley flashing shall extend at least 8 inches (~~[203]~~ 203.2 mm) from the centerline each way and shall have a splash diverter rib not less than $\frac{3}{4}$ inch (19.1 mm) high at the flow line formed as part of the flashing. Sections of flashing shall have an end lap of not less than 4 inches (~~[102]~~ 101.6 mm). The metal valley flashing shall have a 36-inch~~[-wide]~~ (~~[914]~~ 914.4 mm) wide underlayment directly under it consisting of either one layer of underlayment running the full length of the valley or a self-adhering polymer-modified bitumen sheet complying with ASTM D 1970, in addition to underlayment required for metal roof shingles. For slopes under seven units vertical in 12 units horizontal (58-percent slope), the metal valley flashing underlayment shall be solid cemented to the roofing underlayment) or a self-adhering polymer modified bitumen sheet shall be installed.

1507.6 Mineral-surfaced roll roofing. The installation of mineral-surfaced roll roofing shall comply with this section.

1507.6.1 Deck requirements. Mineral-surfaced roll roofing shall be fastened to solidly sheathed roofs.

1507.6.2 Deck slope. Mineral-surfaced roll roofing shall not be applied on roof slopes below one unit vertical in 12 units horizontal (8-percent slope).

1507.6.3 Underlayment. Underlayment shall comply with ASTM D 226, Type I or ASTM D 4869.

1507.6.4 Ice barrier. An ice barrier that consists of at least two layers of underlayment cemented together or of a self-adhering polymer-modified bitumen sheet, shall be used in lieu of normal underlayment and extend from the lowest edges of all roof surfaces to a point at least 24 inches (~~[610]~~ 609.6 mm) inside the exterior wall line of the building.

Exception: Detached accessory structures that contain no conditioned floor area.

1507.6.5 Material standards. Mineral-surfaced roll roofing shall conform to ASTM D 3909 or ASTM D 6380.

1507.7 Slate shingles. The installation of slate shingles shall comply with the provisions of this section.

1507.7.1 Deck requirements. Slate shingles shall be fastened to solidly sheathed roofs.

1507.7.2 Deck slope. Slate shingles shall only be used on slopes of four units vertical in 12 units horizontal (4:12) or greater.

1507.7.3 Underlayment. Underlayment shall comply with ASTM D 226, Type ~~[I]~~ II or ASTM D 4869, Type III or IV.

1507.7.4 Ice barrier. An ice barrier that consists of at least two layers of underlayment cemented together or of a self-adhering polymer-modified bitumen sheet, shall extend from the lowest edges of all roof surfaces to a point at least 24 inches (~~[610]~~ 609.6 mm) inside the exterior wall line of the building.

Exception: Detached accessory structures that contain no conditioned floor area.

1507.7.5 Material standards. Slate shingles shall comply with ASTM C 406.

1507.7.6 Application. Minimum headlap for slate shingles shall be in accordance with Table 1507.7.6. Slate shingles shall be secured to the roof with two fasteners per slate.

**TABLE 1507.7.6
SLATE SHINGLE HEADLAP**

SLOPE	HEADLAP (inches)
4:12 < slope < 8:12	4
8:12 < slope < 20:12	3
slope ≥ 20:12	2

For SI: 1 inch = 25.4 mm.

1507.7.7 Flashing. Flashing and counterflashing shall be made with sheet metal. Valley flashing shall be a minimum of 15 inches (381 mm) wide. Valley and flashing metal shall be a minimum uncoated thickness of 0.0179-inch (0.455 mm) zinc-coated G90. Chimneys, stucco or brick walls shall have a minimum of two plies of felt for a cap flashing consisting of a 4-inch [~~wide~~] (~~102~~] 101.6 mm) wide strip of felt set in plastic cement and extending 1 inch (~~25~~] 25.4 mm) above the first felt and a top coating of plastic cement. The felt shall extend over the base flashing 2 inches (~~51~~] 50.8 mm).

1507.8 Wood shingles. The installation of wood shingles shall comply with the provisions of this section and Table 1507.8.

**TABLE 1507.8
WOOD SHINGLE AND SHAKE INSTALLATION**

ROOF ITEM	WOOD SHINGLES	WOOD SHAKES
1. Roof slope	Wood shingles shall be installed on slopes of <u>not less than</u> three units vertical in 12 units horizontal [(3:12) or greater] (3:12).	Wood shakes shall be installed on slopes of <u>not less than</u> four units vertical in 12 units horizontal [(4:12) or greater] (4:12).
2. Deck requirement	[—]	[—]
Temperate climate	Shingles shall be applied to roofs with solid or spaced sheathing. Where spaced sheathing is used, sheathing boards shall <u>be</u> not [be] less than 1" × 4" nominal dimensions and shall be spaced on [center] <u>centers</u> equal to the weather exposure to coincide with the placement of fasteners.	Shakes shall be applied to roofs with solid or spaced sheathing. Where spaced sheathing is used, sheathing boards shall <u>be</u> not [be] less than 1" × 4" nominal dimensions and shall be spaced on [center] <u>centers</u> equal to the weather exposure to coincide with the placement of fasteners. When 1" × 4" spaced sheathing is installed at 10 inches, boards must be installed between the sheathing boards.
Ice forming along the eaves causing a backup of water.	Solid sheathing required.	Solid sheathing is required.

**TABLE 1507.8
WOOD SHINGLE AND SHAKE INSTALLATION**

ROOF ITEM	WOOD SHINGLES	WOOD SHAKES
3. Interlayment	No requirements.	Interlayment shall comply with ASTM D 226, Type 1.
4. Underlayment	[—]	[—]
Temperate climate	Underlayment shall comply with ASTM D 226, Type 1.	Underlayment shall comply with ASTM D 226, Type 1.
Ice forming along the eaves causing a backup of water.	An ice barrier that consists of at least two layers of underlayment cemented together or of a self-adhering polymer-modified bitumen sheet shall extend from the eave's edge to a point at least 24 inches inside the exterior wall line of the building.	An ice barrier that consists of at least two layers of underlayment cemented together or of a self-adhering polymer-modified bitumen sheet shall extend from the lowest eave's edge of all roof surfaces to a point at least 24 inches inside the exterior wall line of the building.
5. Application	[—]	[—]
Attachment	Fasteners for wood shingles shall be hot-dipped galvanized or Type 304 (Type 316 for coastal areas) stainless steel with a minimum penetration of 0.75 inch into the sheathing. For sheathing less than 0.5 inch thick, the fasteners shall extend through the sheathing.	Fasteners for wood shakes shall be hot-dipped galvanized or Type 304 (Type 316 for coastal areas) with a minimum penetration of 0.75 inch into the sheathing. For sheathing less than 0.5 inch thick, the fasteners shall extend through the sheathing.
No. of fasteners	Two per shingle.	Two per shake.
Exposure	Weather exposures shall not exceed those set forth in Table 1507.8.7.	Weather exposures shall not exceed those set forth in Table 1507.9.8.
Method	Shingles shall be laid with a side lap of not less than 1.5 inches between joints in courses, and no two joints in any three adjacent courses shall be in direct alignment. Spacing between shingles shall be 0.25 to 0.375 inch.	Shakes shall be laid with a side lap of not less than 1.5 inches between joints in adjacent courses. Spacing between shakes shall not be less than 0.375 inch or more than 0.625 inch for shakes and [taper sawn] <u>taper sawn</u> shakes of naturally durable wood and shall be 0.25 to 0.375 inch for [preservative] <u>preservative-treated</u> taper sawn shakes.
Flashing	In accordance with Section 1507.8.8.	In accordance with Section 1507.9.9.

For SI: 1 inch = 25.4 mm, °C = ((°F) – 32)/1.8.

1507.8.1 Deck requirements. Wood shingles shall be installed on solid or spaced sheathing. Where spaced sheathing is used, sheathing boards shall be not [be] less than 1-inch by 4-inch ([~~25~~] 25.4 mm by [~~402~~] 101.6 mm) nominal dimensions and shall be spaced on centers equal to the weather exposure to coincide with the placement of fasteners.

1507.8.1.1 Solid sheathing required. Solid sheathing is required.

1507.8.2 Deck slope. Wood shingles shall be installed on slopes of not less than three units vertical in 12 units horizontal [~~(25-percent slope) or greater.~~] (25-percent slope).

1507.8.3 Underlayment. Underlayment shall comply with ASTM D 226, Type I or ASTM D 4869.

1507.8.4 Ice barrier. An ice barrier that consists of at least two layers of underlayment cemented together or of a self-adhering polymer-modified bitumen sheet shall be used in lieu of normal underlayment and extend from the lowest edges of all roof surfaces to a point at least 24 inches (~~[610]~~ 609.6 mm) inside the exterior wall line of the building.

Exception: Detached accessory structures that contain no conditioned floor area.

1507.8.5 Material standards. Wood shingles shall be of naturally durable wood and comply with the requirements of Table 1507.8.5.

**TABLE 1507.8.5
WOOD SHINGLE MATERIAL REQUIREMENTS**

MATERIAL	APPLICABLE MINIMUM GRADES	GRADING RULES
Wood shingles of naturally durable wood	1, 2 or 3	CSSB

CSSB = Cedar Shake and Shingle Bureau

1507.8.6 Attachment. Fasteners for wood shingles shall be corrosion resistant with a minimum penetration of ¾ inch (19.1 mm) into the sheathing. For sheathing less than ½ inch (12.7 mm) in thickness, the fasteners shall extend through the sheathing. Each shingle shall be attached with a minimum of two fasteners.

1507.8.7 Application. Wood shingles shall be laid with a side lap not less than 1½ inches (~~[38]~~ 38.1 mm) between joints in adjacent courses, and not be in direct alignment in alternate courses. Spacing between shingles shall be ¼ to ⅜ inches (6.4 to 9.5 mm). Weather exposure for wood shingles shall not exceed that set in Table 1507.8.7.

**TABLE 1507.8.7
WOOD SHINGLE WEATHER EXPOSURE AND ROOF SLOPE**

ROOFING MATERIAL	LENGTH (inches)	GRADE	EXPOSURE (inches)	
			3:12 pitch to < 4:12	4:12 pitch or steeper
Shingles of naturally durable wood	16	No. 1	3.75	5
		No. 2	3.5	4
		No. 3	3	3.5
	18	No. 1	4.25	5.5
		No. 2	4	4.5
		No. 3	3.5	4
	24	No. 1	5.75	7.5
		No. 2	5.5	6.5
		No. 3	5	5.5

For SI: 1 inch = 25.4 mm.

1507.8.8 Flashing. At the juncture of the roof and vertical surfaces, flashing and counterflashing shall be provided in accordance with the manufacturer's ~~[installation]~~ instructions, and where of metal, shall be not ~~[be]~~ less than 0.019-inch (0.48 mm) (No. 26 galvanized sheet gage) corrosion-resistant metal. The valley flashing shall extend at least 11 inches (279 mm) from the centerline each way and have a splash diverter rib not less than 1 inch (~~[25]~~ 25.4 mm) high at the flow line formed as part of the flashing. Sections of flashing shall have an end lap of not less than 4 inches (~~[402]~~ 101.6 mm). For roof slopes of three units vertical in 12 units horizontal (25-percent slope)

and over, the valley flashing shall have a 36-inch~~[-wide]~~ ([914] 914.4 mm) wide underlayment of either one layer of Type I underlayment running the full length of the valley [~~valley~~] or a self-adhering polymer-modified bitumen sheet complying with ASTM D 1970, in addition to other required underlayment. For slopes under seven units vertical in 12 units horizontal (58-percent slope), the metal valley flashing underlayment shall be solid cemented to the roofing underlayment or a self-adhering polymer modified bitumen sheet shall be installed.

1507.9 Wood shakes. The installation of wood shakes shall comply with the provisions of this section and Table 1507.8.

1507.9.1 Deck requirements. Wood shakes shall only be used on solid or spaced sheathing. Where spaced sheathing is used, sheathing boards shall be not [be] less than 1-inch by 4-inch (~~[25]~~ 25.4 mm by [~~402]~~ 101.6 mm) nominal dimensions and shall be spaced on centers equal to the weather exposure to coincide with the placement of fasteners. Where 1-inch by 4-inch (~~[25]~~ 25.4 mm by [~~402]~~ 101.6 mm) spaced sheathing is installed at 10 inches (254 mm) [~~o-e.~~] on center, additional 1-inch by 4-inch (~~[25]~~ 25.4 mm by [~~402]~~ 101.6 mm) boards shall be installed between the sheathing boards.

1507.9.1.1 Solid sheathing required. Solid sheathing is required in areas where the average daily temperature in January is 25°F (-4°C) or less or where there is a possibility of ice forming along the eaves causing a backup of water.

1507.9.2 Deck slope. Wood shakes shall only be used on slopes of not less than four units vertical in 12 units horizontal (33-percent slope)~~[or greater]~~.

1507.9.3 Underlayment. Underlayment shall comply with ASTM D 226, Type I or ASTM D 4869.

1507.9.4 Ice barrier. An ice barrier that consists of at least two layers of underlayment cemented together or of a self-adhering polymer-modified bitumen sheet shall be used in lieu of normal underlayment and extend from the lowest edges of all roof surfaces to a point at least 24 inches (~~[640]~~ 609.6 mm) inside the exterior wall line of the building.

Exception: Detached accessory structures that contain no conditioned floor area.

1507.9.5 Interlayment. Interlayment shall comply with ASTM D 226, Type I.

1507.9.6 Material standards. Wood shakes shall comply with the requirements of Table 1507.9.6.

**TABLE 1507.9.6
WOOD SHAKE MATERIAL REQUIREMENTS**

MATERIAL	MINIMUM GRADES	APPLICABLE GRADING RULES
Wood shakes of naturally durable wood	1	CSSB
Taper sawn shakes of naturally durable wood	1 or 2	CSSB
Preservative-treated shakes and shingles of naturally durable wood	1	CSSB

**TABLE 1507.9.6
WOOD SHAKE MATERIAL REQUIREMENTS**

MATERIAL	MINIMUM GRADES	APPLICABLE GRADING RULES
Fire-retardant-treated shakes and shingles of naturally durable wood	1	CSSB
Preservative-treated taper sawn shakes of Southern pine treated in accordance with AWP A U1 (Commodity Specification A, Use Category 3B and Section 5.6)	1 or 2	TFS

CSSB = Cedar Shake and Shingle Bureau.

TFS = Forest Products Laboratory of the Texas Forest Services.

1507.9.7 Attachment. Fasteners for wood shakes shall be corrosion resistant with a minimum penetration of ¾ inch (19.1 mm) into the sheathing. For sheathing less than ½ inch (12.7 mm) in thickness, the fasteners shall extend through the sheathing. Each shake shall be attached with a minimum of two fasteners.

1507.9.8 Application. Wood shakes shall be laid with a side lap not less than 1½ inches ([38] 38.1 mm) between joints in adjacent courses. Spacing between shakes in the same course shall be ⅜ to ⅝ inches (9.5 to 15.9 mm) for shakes and taper sawn shakes of naturally durable wood and shall be ¼ to ⅜ inch (6.4 to 9.5 mm) for preservative taper sawn shakes. Weather exposure for wood shakes shall not exceed those set in Table 1507.9.8.

**TABLE 1507.9.8
WOOD SHAKE WEATHER EXPOSURE AND ROOF SLOPE**

ROOFING MATERIAL	LENGTH (inches)	GRADE	EXPOSURE (inches) 4:12 PITCH OR STEEPER
Shakes of naturally durable wood	18	No. 1	7.5
	24	No. 1	10 ^a
Preservative-treated taper sawn shakes of Southern yellow pine	18	No. 1	7.5
	24	No. 1	10
	18	No. 2	5.5
	24	No. 2	7.5
Taper sawn shakes of naturally durable wood	18	No. 1	7.5
	24	No. 1	10
	18	No. 2	5.5
	24	No. 2	7.5

For SI: 1 inch = 25.4 mm.

a. For 24-inch by 0.375-inch handsplit shakes, the maximum exposure is 7.5 inches.

1507.9.9 Flashing. At the juncture of the roof and vertical surfaces, flashing and counterflashing shall be provided in accordance with the manufacturer's [installation] instructions, and where of metal, shall be not [be] less than 0.019-inch (0.48 mm) (No. 26 galvanized sheet gage) corrosion-resistant metal. The valley flashing shall extend at least 11 inches (279 mm) from the centerline each way and have a splash diverter rib not less than 1 inch ([25] 25.4 mm) high at the flow line formed as part of the flashing. Sections of flashing shall have an end lap of not less than 4 inches ([402] 101.6 mm). For roof slopes of three units vertical in 12 units horizontal (25-percent slope) and over, the valley flashing shall have a 36-inch[-wide] ([914] 914.4 mm) wide underlayment of either one layer of Type I underlayment running the full length of the valley or a self-adhering polymer-modified bitumen sheet complying with ASTM D 1970, in addition to other required

underlayment. For slopes under seven units vertical in 12 units horizontal (58-percent slope) the metal valley flashing underlayment shall be solidly cemented to the roofing underlayment or a self-adhering polymer-modified bitumen sheet shall be installed.

1507.10 Built-up roofs. The installation of built-up roofs shall comply with the provisions of this section.

1507.10.1 Slope. Built-up roofs shall have a slope designed and built to provide positive roof drainage.

1507.10.2 Material standards. Built-up roof covering materials shall comply with UL 55A or the standards in Table 1507.10.2 of this code.

**TABLE 1507.10.2
BUILT-UP ROOFING MATERIAL STANDARDS**

MATERIAL STANDARD	STANDARD
Acrylic coatings used in roofing	ASTM D 6083
Aggregate surfacing	ASTM D 1863
Asphalt adhesive used in roofing	ASTM D 3747
Asphalt cements used in roofing	ASTM D 3019; D 2822; D 4586
Asphalt-coated glass fiber base sheet	ASTM D 4601
Asphalt coatings used in roofing	ASTM D 1227; D 2823; <u>D 2824</u> ; D 4479
Asphalt glass felt	ASTM D 2178
Asphalt primer used in roofing	ASTM D 41
Asphalt-saturated and asphalt-coated organic felt base sheet	ASTM D 2626
Asphalt-saturated organic felt (perforated)	ASTM D 226
Asphalt used in roofing	ASTM D 312
Coal-tar cements used in roofing	ASTM D 4022; D 5643
Coal-tar saturated organic felt	ASTM D 227
Coal-tar pitch used in roofing	ASTM D 450; Type I or II
Coal-tar primer used in roofing, dampproofing and waterproofing	ASTM D 43
Glass mat, coal tar	ASTM D 4990
Glass mat, venting type	ASTM D 4897
Mineral-surfaced inorganic cap sheet	ASTM D 3909
Thermoplastic fabrics used in roofing	ASTM D 5665, D 5726

1507.11 Modified bitumen roofing. The installation of modified bitumen roofing shall comply with the provisions of this section.

1507.11.1 Slope. Modified bitumen membrane roofs shall have a slope designed and built to provide positive roof drainage.

1507.11.2 Material standards. Modified bitumen roof coverings shall comply with CGSB 37-GP-56M, ASTM D 6162, ASTM D 6163, ASTM D 6164, ASTM D 6222, ASTM D 6223, ASTM D 6298 [~~and~~] or ASTM D 6509.

1507.12 Thermoset single-ply roofing. The installation of thermoset single-ply roofing shall comply with the provisions of this section.

1507.12.1 Slope. Thermoset single-ply membrane roofs shall have a slope designed and built to provide positive roof drainage.

1507.12.2 Material standards. Thermoset single-ply roof coverings shall comply with ASTM D 4637, ASTM D 5019 or CGSB 37-GP-52M.

1507.12.3 Ballasted thermoset low-slope roofs. Ballasted thermoset low-slope roofs (roof slope < 2:12) shall be installed in accordance with this section and Section 1504.4, and subject to the limitations of Section 1504.8. [~~Stone used as ballast shall comply with ASTM D 448.~~]

1507.13 Thermoplastic single-ply roofing. The installation of thermoplastic single-ply roofing shall comply with the provisions of this section.

1507.13.1 Slope. Thermoplastic single-ply membrane roofs shall have a slope designed and built to provide positive roof drainage.

1507.13.2 Material standards. Thermoplastic single-ply roof coverings shall comply with ASTM D 4434, ASTM D 6754, ASTM D 6878 or CAN/CGSB 37-54.

1507.13.3 Ballasted thermoplastic low-slope roofs. Ballasted thermoplastic low-slope roofs (roof slope < 2:12) shall be installed in accordance with this section and Section 1504.4, and subject to the limitations of Section 1504.8. [~~Stone used as ballast shall comply with ASTM D 448.~~]

1507.14 Sprayed polyurethane foam roofing. The installation of sprayed polyurethane foam roofing shall comply with the provisions of this section.

1507.14.1 Slope. Sprayed polyurethane foam roofs shall have a slope designed and built to provide positive roof drainage.

1507.14.2 Material standards. Spray-applied polyurethane foam insulation shall comply with Type III or IV as defined in ASTM C 1029.

1507.14.3 Application. Foamed-in-place roof insulation shall be installed in accordance with the manufacturer’s instructions. A liquid-applied protective coating that complies with [~~Section 1507.15~~] Table 1507.14.3 shall be applied no less than 2 hours nor more than 72 hours following the application of the foam.

**TABLE 1507.14.3
PROTECTIVE COATING MATERIAL STANDARDS**

<u>MATERIAL</u>	<u>STANDARD</u>
Acrylic coating	ASTM D 6083
Silicone coating	ASTM D 6694
Moisture-cured polyurethane coating	ASTM D 6947

1507.14.4 Foam plastics. Foam plastic materials and installation shall comply with Chapter 26.

1507.15 Liquid-applied roofing. The installation of liquid-applied roofing shall comply with the provisions of this section.

1507.15.1 Slope. Liquid-applied roofing shall have a slope designed and built to provide positive roof drainage.

1507.15.2 Material standards. Liquid-applied roofing shall comply with ASTM C 836, ASTM C 957, ASTM D 1227~~[5]~~ or ASTM D 3468, ASTM D 6083, ASTM D 6694 or ASTM D 6947.

1507.16 ~~[Green roof systems]~~ Vegetative roofs, roof gardens and landscaped roofs. ~~[The green roof system]~~ Vegetative roofs, roof gardens and landscaped roofs shall comply with the provisions of this section and New York City Fire Code.

1507.16.1 Design standards. ~~[Green roof systems]~~ Vegetative roofs, roof gardens and landscaped roofs shall comply with ANSI/SPRI RP-14 and ANSI/SPRI VF-1, or with FM DS 1-35.

Exceptions:

1. The aggregate area of landscaping materials or growth media or both on any single roof level of a building or structure is 250 square feet (23.2 m²) or less.
2. The roof area is 22 feet (~~[6706]~~ 6705.6 mm) or less from grade.
3. The ~~[green]~~ vegetative roof system is a container garden.

1507.16.2 Roof structure. The roof structure shall comply with Chapter 16 for the design of the ~~[green roofs system]~~ vegetative roofs, roof gardens and landscaped roofs.

1507.16.3 Roof covering. Roof covering shall comply with Section 1507.10, 1507.11, 1507.12, 1507.13~~[7]~~ or 1507.15.

1507.16.4 Slope. The roofing membrane shall have a design slope in accordance with the roof covering utilized. Overburden shall be installed to prevent slippage tested as an assembly.

1507.16.5 Structural fire resistance. The structural frame and roof construction supporting the load imposed upon the roof by the vegetative roof, roof gardens or landscaped roofs shall comply with the requirements of Table 601.

1507.17 Photovoltaic shingles. The installation of photovoltaic shingles shall comply with the provisions of this section.

1507.17.1 Deck requirements. Photovoltaic shingles shall be applied to a solid or closely fitted deck, except where the shingles are specifically designed to be applied over spaced sheathing.

1507.17.2 Deck slope. Photovoltaic shingles shall not be installed on roof slopes less than three units vertical in 12 units horizontal (25-percent slope).

1507.17.3 Underlayment. Unless otherwise noted, required underlayment shall conform to ASTM D 226, ASTM D 4869 or ASTM D 6757.

1507.17.4 Underlayment application. Underlayment shall be applied shingle fashion, parallel to and starting from the eave, lapped 2 inches (50.8 mm) and fastened sufficiently to hold in place.

1507.17.4.1 High wind attachment. Underlayment applied in areas subject to high winds (V_{asd} greater than 110 mph (49.1 m/s) as determined in accordance with Section 1609.3.1) shall be applied with corrosion-resistant fasteners in accordance with the manufacturer's instructions. Fasteners shall be applied along the overlap at not more than 36 inches (914.4 mm) on center. Underlayment installed where V_{asd} is not less than 120 mph (53.6 m/s) shall comply with ASTM D 226, Type II, ASTM D 4869, Type IV or ASTM D 6757. The underlayment shall be attached in a grid pattern of 12 inches (304.8 mm) between side laps with a 6-inch (152.4 mm) spacing at the side laps. Underlayment shall be applied in accordance with Section 1507.2.8 except all laps shall be a minimum of 4 inches (101.6 mm). Underlayment shall be attached using metal or plastic cap nails with a head diameter of not less than 1 inch (25.4 mm) with a thickness of not less than 32-gage (0.0134 inch (0.34 mm)) sheet metal. The cap nail shank shall be a minimum of 12 gage (0.105 inch (2.67 mm)) with a length to penetrate through the roof sheathing or a minimum of ¾ inch (19.1 mm) into the roof sheathing.

Exception: As an alternative, adhered underlayment complying with ASTM D 1970 shall be permitted.

1507.17.4.2 Ice barrier. An ice barrier that consists of at least two layers of underlayment cemented together or of a self-adhering polymer modified bitumen sheet shall be used instead of normal underlayment and extend from the lowest edges of all roof surfaces to a point not less than 24 inches (609.6 mm) inside the exterior wall line of the building.

Exception: Detached accessory structures that contain no conditioned floor area.

1507.17.5 Fasteners. Fasteners for photovoltaic shingles shall be galvanized, stainless steel, aluminum or copper roofing nails, minimum 12-gage (0.105 inch (2.67 mm)) shank with a minimum ⅜-inch (9.5 mm) diameter head, of a length to penetrate through the roofing materials and a minimum of ¾ inch (19.1 mm) into the roof sheathing. Where the roof sheathing is less than ¾ inch (19.1 mm) thick, the nails shall penetrate through the sheathing. Fasteners shall comply with ASTM F 1667.

1507.17.6 Material standards. Photovoltaic shingles shall be listed and labeled in accordance with UL 1703.

1507.17.7 Attachment. Photovoltaic shingles shall be attached in accordance with the manufacturer's instructions.

1507.17.8 Wind resistance. Photovoltaic shingles shall be tested in accordance with procedures and acceptance criteria in ASTM D 3161. Photovoltaic shingles shall comply with the classification requirements of Table 1504.1.1 of this code for the appropriate maximum nominal

design wind speed. Photovoltaic shingle packaging shall bear a label to indicate compliance with the procedures in ASTM D 3161 and the required classification from Table 1504.1.1 of this code.

SECTION BC 1508 ROOF INSULATION

1508.1 General. The use of above-deck thermal insulation shall be permitted provided such insulation is covered with an approved roof covering and passes the tests of [~~FM 4450~~] NFPA 276 or UL 1256 when tested as an assembly.

Exceptions:

1. Foam plastic roof insulation shall conform to the material and installation requirements of Chapter 26 of this code.
2. Where a concrete roof deck is used and the above-deck thermal insulation is covered with an approved roof covering.

1508.1.1 Cellulosic fiberboard. Cellulosic fiberboard roof insulation shall conform to the material and installation requirements of Chapter 23.

1508.2 Material standards. Above-deck thermal insulation board shall comply with the standards in Table 1508.2.

**TABLE 1508.2
MATERIAL STANDARDS FOR ROOF INSULATION**

<u>MATERIAL</u>	<u>STANDARD</u>
Cellular glass board	ASTM C 552
Composite boards	ASTM C 1289, Type III, IV, V or VI
Expanded polystyrene	ASTM C 578
Extruded polystyrene [board]	ASTM C 578
Fiber-reinforced gypsum board	ASTM C 1278
Glass-faced gypsum board	ASTM C 1177
Mineral fiber insulation board	ASTM C 726
Perlite board	ASTM C 728
Polyisocyanurate board	ASTM C 1289, Type I or [Type] II
Wood fiberboard	ASTM C 208

**SECTION BC 1509
RADIANT BARRIERS INSTALLED ABOVE DECK**

1509.1 General. A radiant barrier installed above a deck shall comply with Sections 1509.2 through 1509.4.

1509.2 Fire testing. Radiant barriers shall be permitted for use above decks where the radiant barrier is covered with an approved roof covering and the system consisting of the radiant barrier and the roof covering complies with the requirements of either FM 4550 or UL 1256.

1509.3 Installation. The low emittance surface of the radiant barrier shall face the continuous airspace between the radiant barrier and the roof covering.

1509.4 Material standards. A radiant barrier installed above a deck shall comply with ASTM C 1313/1313M.

**SECTION BC 1510
ROOFTOP STRUCTURES**

[1509.1] 1510.1 General. The provisions of this section shall govern the construction of rooftop structures. All rooftop structures shall be subject to the roof area coverage limitations and building height requirements of Chapter 5. Rooftop structures shall be constructed with materials as required for the building, except as provided for in this section.

[1509.2] 1510.2 Bulkheads and penthouses. Bulkheads and penthouses shall comply with the construction requirements of this Section[1509.2].

[1509.2.1] 1510.2.1 Type of construction. Bulkheads and penthouses shall be constructed with walls, floors and roof as required for the building.

Exceptions: Where the total aggregate area of all rooftop structures does not exceed 33 percent of the area of the roof of the building upon which they are erected[1510.2.1], the following shall apply:

1. Bulkheads on buildings of Type I and II construction. The exterior walls and roofs of such bulkheads with a fire separation distance of more than 5 feet (1524 mm) and less than 30 feet (9144 mm) shall be of at least 1-hour fire-resistance-rated noncombustible construction. Walls and roofs with a fire separation distance of 30 feet (9144 mm) or greater shall be of noncombustible construction. Interior framing and walls shall be of noncombustible construction.
2. Bulkheads on buildings of Type III, IV and V construction. The exterior walls of such bulkheads with a fire separation distance of more than 5 feet (1524 mm) and less than 30 feet (9144 mm) shall be at least 1-hour fire-resistance-rated construction. Walls with a fire separation distance of 30 feet (9144 mm) or greater from a common property line shall be of Type IV construction, or noncombustible construction. Roofs shall be constructed of materials and fire-resistance rated as required in Table 601 ~~[and Section 603, Item 25.3]~~. Interior framing and walls shall be Type IV or noncombustible or fire-retardant-treated wood construction

~~[3. On one-story buildings, combustible unroofed mechanical equipment screens, fences or similar enclosures are permitted where located with a fire separation distance of at least 20 feet (6096 mm) from adjacent property lines and where not exceeding 4 feet (1219 mm) in height above the roof surface.]~~

~~[1509.2.2]~~ **1510.2.2 Penthouses.** Enclosed walls of penthouses shall comply with the requirements for exterior walls as per Tables 601 and 602 for the construction class of the building on which they are erected. Roofs of penthouses shall comply with the requirements for roof construction of Table 601 and Chapter 15.

~~[1509.2.3]~~ **1510.2.3 Bulkheads.** An enclosed rooftop structure not intended for human occupancy shall not be used for purposes other than shelter of mechanical equipment or shelter of vertical shaft openings in the roof. Provisions, such as louvers, louver blades or flashing, shall be made to protect the mechanical equipment and the building interior from the elements.

~~[1509.3 Tank Supports]~~ **1510.3 Tanks.** Tanks having a capacity of more than 500 gallons [~~(2 m³)~~ placed in or on] (1892.7 L) located on the roof deck of a building shall be supported on masonry, reinforced concrete, steel or Type IV construction provided that, where such supports are located in the building above the lowest story, the support shall be fire-resistance rated as required for Type IA construction.

~~[1509.3.1]~~ **1510.3.1 Valve and drain.** ~~[Such tanks shall have in]~~ On the bottom or on the side near the bottom of the tank, a pipe or outlet, fitted with a suitable ~~[quick opening]~~ quick-opening valve for discharging the contents into a drain in an emergency ~~[through an adequate drain]~~ shall be provided.

~~[1509.3.2]~~ **1510.3.2 Location.** ~~[Such tanks]~~ Tanks shall not be placed over or near a ~~[line of stairs]~~ stairway or an elevator shaft, unless there is a solid roof or floor underneath the tank.

~~[1509.3.3]~~ **1510.3.3 Tank cover.** Unenclosed roof tanks shall have covers sloping toward the ~~[outer edges]~~ perimeter of the tanks.

[1509.4] 1510.4 Cooling towers. [~~Cooling towers in excess of 250 square feet (23.2 m²) in base area or in excess of 15 feet (4572 mm) high where located on building roofs more than 50 feet (15 240 mm) high shall be of noncombustible construction.~~] Cooling towers shall be of noncombustible construction.

Exceptions:

1. [~~Drip boards and the enclosing construction of wood not less than 1 inch (25 mm) nominal thickness, provided the wood is covered on the exterior of the tower with noncombustible material.~~] Fill and drift eliminators of limited combustible materials may be considered noncombustible if the cooling towers are provided with automatic sprinkler protection complying with Section 903.
2. [~~Fill and drift eliminators may be of combustible material if the towers are provided with automatic sprinkler protection complying with Section 903 of this code.~~]
- [3] Fill and drift eliminators that comply with Section 908 of the *New York City Mechanical Code*.

[1509.5] 1510.5 Steeples, minarets, spires, domes and cupolas. [~~Any steeple, minaret, spire, dome or cupola shall be of a type of construction not less in fire-resistance rating than required for the building to which it is attached except that any such steeple, minaret, spire, dome or cupola that exceeds 85 feet (25 908 mm) in height above grade plane, exceeds 200 square feet (18.6 m²) in horizontal area or is used for any purpose other than a belfry or an architectural embellishment shall be constructed of and supported on Type I or II construction.~~] Steeples, minarets, spires, domes, cupolas and other similar architectural elements not used for occupancy or storage, shall be constructed of materials consistent with the required type of construction of the building and shall be of a type of construction having fire-resistance ratings not less than required for the building on top of which such steeple, minaret, spire, dome or cupola is built.

[1509.5.1] 1510.5.1 Noncombustible construction required. [~~Any steeple, minaret, spire, dome or cupola that exceeds 60 feet (18 288 mm) in height above the highest point at which it comes in contact with the roof, or that exceeds 200 square feet (18.6 m²) in area at any horizontal section, or which is intended to be used for any purpose other than a belfry or architectural embellishment, shall be entirely constructed of and supported by noncombustible materials. Such structures shall be separated from the building below by construction having a fire-resistance rating of not less than 1.5 hours with openings protected with a minimum 1.5-hour fire-protection rating. Such structures placed above the roof of any building more than 50 feet (15 240 mm) in height, shall be of noncombustible material and shall be supported by construction of noncombustible material.~~] Steeples, minarets, spires, domes and cupolas greater than 60 feet (18 288 mm) in height above the highest point at which such structure contacts the roof as measured to the highest point on such structure, or that exceeds 200 square feet (18.6 m²) in area at any horizontal section, or which is intended to be used for any purpose other than as a belfry or architectural embellishment, or is located on the top of a building greater than 50 feet (1524 mm) in building height shall be constructed of and supported by noncombustible materials and shall be separated from the building below by construction having a fire-resistance rating of not less than 1.5 hours with openings protected in accordance with Section 712. Such structures located

on the top of a building greater than 50 feet (15 240 mm) in building height, shall be supported by noncombustible construction.

~~[1509.5.2 Steeple, minarets and spires]~~ **1510.5.2 Steeple, minarets and spires.** Steeple, minarets, and spires ~~[where enclosed]~~ shall have exterior walls constructed as required for the building [to] on top of which [they] such steeple, minarets and spires are [attached] built. The roof covering of spires shall be ~~[of a]~~ not less than the same class of roof covering [as required for the main roof of the rest of the structure.] required for the building on top of which the spire is located.

~~[1509.6]~~ **1510.6 Dormers.** Dormers shall have exterior walls as required for the building to which they are attached. The roof covering of dormers shall be of a class of roof covering as required for the main roof of the rest of the structure.

~~[1509.7]~~ **1510.7 Greenhouses.** Greenhouses used for the cultivation of plants, on the roofs of buildings other than buildings of Type V construction, shall be constructed of noncombustible framework and shall be glazed with plain or wire glass, or light transmitting plastic glazing complying with the requirements of Section 2606. The floors of greenhouses shall be constructed to be at least equal to the requirements for roof construction on Table 601 for the construction class of the building on which it is located.

~~[1509.8]~~ **1510.8 Protective guards.** Buildings greater than 22 feet (6706 mm) in height with roof slopes less than 2.4 units vertical in 12 units horizontal (20-percent slope) shall be provided with a parapet, ~~[railing]~~ guards, fence, or combination thereof, not less than 42 inches (1067 mm) in height. ~~[Railings]~~ Guards or fences may be located inward from the face of the exterior wall a distance not exceeding 6 feet (~~[1829]~~ 1828.8 mm). ~~[Railings]~~ Guards or fences shall be of noncombustible material, except on buildings of Type V construction. ~~[Railings]~~ Guards shall be constructed to comply with the requirements of Sections ~~[4012]~~ 1015 and ~~[1607.7]~~ 1607.8.

~~[1509.8.1]~~ **1510.8.1 Fences on roofs used for recreational purposes.** Rooftops used for recreational purposes shall be provided with wire fencing at least 10 feet (3048 mm) in height. Openings in the fence shall not permit the passage of a 4-inch~~[diameter]~~ (~~[102]~~ 101.6 mm) diameter sphere. Where ball games are played on rooftops the wire fencing shall be extended to provide an overhead closure.

~~[1509.9]~~ **1510.9 Miscellaneous combustible roof structures.** The following roof structures may be constructed of combustible material if less than 12 feet (~~[1658]~~ 3657.6 mm) high above the roof: antenna supports; flagpoles; clothes drying frames; duckboarding~~[-]~~; decking or platforms that do not cover more than 20 percent of the contiguous roof area at that level.

1510.10 Mechanical equipment screens. Mechanical equipment screens shall be constructed of the materials specified for the exterior walls in accordance with the type of construction of the building.

1510.10.1 Type V construction. The height of mechanical equipment screens located on the roof decks of buildings of Type V construction, as measured from grade plane to the highest point on the mechanical equipment screen, shall be permitted to exceed the maximum building height allowed for the building by other provisions of this code where complying with any one of the following limitations, provided the fire separation distance is greater than 5 feet (1524 mm):

1. Where the fire separation distance is not less than 20 feet (6096 mm), the height above grade plane of the mechanical equipment screen shall not exceed 4 feet (1220 mm) more than the maximum building height allowed;
2. The mechanical equipment screen shall be constructed of noncombustible materials;
3. The mechanical equipment screen shall be constructed of fire-retardant-treated wood complying with Section 2303.2 for exterior installation; or
4. Where the fire separation distance is not less than 20 feet (6096 mm), the mechanical equipment screen shall be constructed of materials having a flame spread index of 25 or less when tested in the minimum and maximum thicknesses intended for use with each face tested independently in accordance with ASTM E 84 or UL 723.

[1509.10] 1510.11 Photovoltaic systems. Rooftop mounted photovoltaic systems shall be designed in accordance with this section.

[1509.10.1] 1510.11.1 Wind resistance. Rooftop mounted photovoltaic systems shall be designed for wind loads for component and cladding in accordance with Chapter 16 using an effective wind area based on the dimensions of a single unit frame.

[1509.10.2] 1510.11.2 Fire classification. Rooftop mounted photovoltaic ~~[systems]~~ panels and modules shall have the ~~[same]~~ fire classification ~~[as the roof assembly required by]~~ in accordance with Section [1505] 1505.9.

[1509.10.3] 1510.11.3 Installation. Rooftop mounted photovoltaic ~~[systems]~~ panels and modules shall be installed in accordance with the manufacturer's ~~[installation]~~ instructions.

[1509.10.4] 1510.11.4 Photovoltaic panels and modules. Photovoltaic panels and modules Rooftop mounted on top of a roof shall be listed and labeled in accordance with UL 1703 and shall be installed in accordance with the manufacturer's ~~[installation]~~ instructions.

SECTION BC ~~[1510]~~ 1511 REROOFING

[1510.1] 1511.1 General. Materials and methods of application used for recovering or replacing an existing roof covering shall comply with the requirements of Chapter 15.

[Exception] Exceptions:

1. Section 1504.9 shall not apply if the area to be recovered or replaced is less than 50 percent of the roof area and less than 500 square feet (~~[46]~~ 46.5 m²).
2. Recovering or replacing an existing roof covering shall not be required to meet the requirement for secondary (emergency overflow) drains or scuppers in Section 1503.4 for roofs that provide for positive roof drainage. For the purposes of this exception, existing secondary drainage or scupper systems required in accordance with this code shall not be removed unless they are replaced by secondary drains or scuppers designed and installed in accordance with Section 1503.4.

~~[1510.1.1]~~ **1511.1.1 Slope.** Reroofs shall provide positive drainage.

~~[1510.2]~~ **1511.2 Structural and construction loads.** Structural roof components shall be capable of supporting the roof-covering system and the material and equipment loads that will be encountered during installation of the system.

~~[1510.3 Recovering versus replacement.~~ New roof coverings shall not be installed without first removing all existing layers of roof coverings down to the roof deck where any of the following conditions occur:]

~~[1. Where the existing roof or roof covering is water soaked or has deteriorated to the point that the existing roof or roof covering is not adequate as a base for additional roofing.]~~

~~[2. Where the existing roof covering is wood shake, slate, clay, cement or asbestos-cement tile.]~~

~~[3. Where the existing roof has two or more applications of any type of roof covering.]~~

1511.3 Roof replacement. Roof replacement shall include the removal of all existing layers of roof coverings down to the roof deck.

Exception: Where the existing roof assembly includes an ice barrier membrane that is adhered to the roof deck, the existing ice barrier membrane shall be permitted to remain in place and covered with an additional layer of ice barrier membrane in accordance with Section 1507.

1511.3.1 Roof recover. The installation of a new roof covering over an existing roof covering shall be permitted where any of the following conditions occur:

[Exceptions:]

1. Where the new roof covering is installed in accordance with the roof covering manufacturer's instructions.

~~[1.]~~ 2. Complete and separate roofing systems, such as standing-seam metal roof panel systems, that are designed to transmit the roof loads directly to the building's structural system and that do not rely on existing roofs and roof coverings for support, shall not require the removal of existing roof coverings.

~~[2.]~~ 3. Metal panel, metal shingle [;] and concrete and clay tile roof coverings shall be permitted to be installed over existing wood shake roofs when applied in accordance with Section [1510.4] 1511.4.

~~[3.]~~ 4. The application of a new protective coating over an existing spray polyurethane foam roofing system shall be permitted without tear-off of existing roof coverings.

1511.3.1.1 Exceptions. A roof recover shall not be permitted where any of the following conditions occur:

1. Where the existing roof or roof covering is water soaked or has deteriorated to the point that the existing roof or roof covering is not adequate as a base for additional roofing.
2. Where the existing roof covering is slate, clay, cement or asbestos-cement tile.
3. Where the existing roof has two or more applications of any type of roof covering.

[1510.4] 1511.4 Roof recovering. Where the application of a new roof covering over wood shingle or shake roofs creates a combustible concealed space, the entire existing surface shall be covered with gypsum board, mineral fiber, glass fiber or other approved materials securely fastened in place.

[1510.5] 1511.5 Reinstallation of materials. Existing slate, clay or cement tile shall be permitted for reinstallation, except that damaged, cracked or broken slate or tile shall not be reinstalled. Existing vent flashing, metal edgings, drain outlets, collars and metal counterflashings shall not be reinstalled where rusted, damaged or deteriorated. Aggregate surfacing materials shall not be reinstalled.

[1510.6] 1511.6 Flashings. Flashings shall be reconstructed in accordance with [approved] manufacturer's [installation] instructions. Metal flashing to which bituminous materials are to be adhered shall be primed prior to installation.

1511.7 Roof assembly. Roof assembly shall be designed and constructed to meet the requirements of the *New York City Energy Conservation Code*.

SECTION BC ~~[1511]~~ 1512 SOLAR PHOTOVOLTAIC PANELS/MODULES AND REQUIRED SUSTAINABLE ROOFING ZONES

~~[1511.1]~~ 1512.1 Solar photovoltaic panels/modules. Solar photovoltaic panels/modules installed upon a roof or as an integral part of a roof assembly shall comply with the requirements of this code and the *New York City Fire Code*.

~~[1511.1.1]~~ 1512.1.1 Structural fire resistance. The structural frame and roof construction supporting the load imposed upon the roof by the photovoltaic panels/modules shall comply with the requirements of Table 601 of this code.

~~[1511.2]~~ 1512.2 Sustainable roofing zone. A sustainable roofing zone shall be required on 100 percent of the roof. For such sustainable roofing zone:

1. A contiguous area of a sustainable roofing zone measuring less than 200 square feet (18.5 m²), or in the case of a building five stories or less in height where the main use or dominant occupancy is classified as Group R, such an area measuring less than 100 square feet (~~[9.20]~~ 9.3 m²), shall be equipped with at least a solar photovoltaic electricity generating system if such system would accommodate at least 5.44 hp (4kW) of solar photovoltaic electricity generating capacity, as determined by the department; and
2. A sustainable roofing zone with a slope less than or equal to two units vertical in 12 units horizontal (17-percent) that would accommodate less than 5.44 hp (4kW) of solar photovoltaic

electricity generating capacity, as determined by the department, shall be equipped with at least a green roof system.

Exceptions:

1. Areas required to be set aside for setbacks or access pursuant to the *New York City Fire Code*, the *New York City Construction Codes*, or the *Zoning Resolution of the City of New York*.
2. Areas occupied by rooftop structures, mechanical equipment, towers, parapets, guardrails, solar thermal systems, and appurtenances.
- [2-] 3. Areas occupied by obstructions related to stormwater management practices including, but not limited to, cisterns, or reuse systems that are installed to comply with site connection or stormwater construction permits issued by the department of environmental protection.
- [3-] 4. Terraces on setbacks comprising less than 25 percent of the area of the largest floor plate in the building.
- [4-] 5. Recreational spaces that are principal to the use of the building on which the rooftop is located.
- [5-] 6. A roof assembly with a slope greater than two units vertical in 12 units horizontal (17- percent) that would accommodate less than 4kW of solar photovoltaic electricity generating capacity.
- [6-] 7. Areas where site conditions are determined by the department to be unfavorable to either a solar photovoltaic electricity generating system or a green roof system.

§ 17. Chapter 16 of the New York city building code, as amended by local law number 141 for the year 2013, is amended to read as follows:

**CHAPTER 16
STRUCTURAL DESIGN**

**SECTION BC 1601
GENERAL**

1601.1 Scope. The provisions of this chapter shall govern the structural design of buildings, structures and portions thereof regulated by this code. [~~Note: Where the text in this Code refers to ASCE 7, the 2005 edition shall be used; and where the text in this Code refers to ASCE 7-10, the 2010 edition shall be used.~~]

1601.1.1 Referenced standards. Where this code makes reference to the nationally recognized standard ASCE 7, such standard shall be as modified for New York City in accordance with this chapter.

1601.2 Special provisions for prior code buildings. The provisions of Sections 1601.2.1 through 1601.2.4 shall apply to structural work on prior code buildings.

1601.2.1 Use of this code. Notwithstanding the applicant's election to use the 1968 Building Code or prior code, the structural calculations shall be permitted to be performed in accordance with this code provided that the structural safety of the prior code building is not reduced. Notwithstanding the provisions of Section 28-101.4.4 of the [~~Administrative Code~~] *Administrative Code*, the use of Load and Resistance Factor Design (LRFD) engineering calculations shall not be deemed to reduce structural safety provided the properties of the existing materials are determined using accepted engineering principles.

1601.2.2 Live loads. Loads indicated in the applicable prior code shall be permitted for structural calculations using engineering formulas from this code provided that the structural safety of the prior code building is not reduced.

1601.2.3 Seismic loads. The determination as to whether seismic requirements apply to an alteration shall be made in accordance with the 1968 Building Code and interpretations by the department relating to such determinations. Any applicable seismic loads and requirements, including for the bracing of architectural, mechanical, plumbing, fuel gas, fire suppression and electrical systems and equipment, shall be permitted to be determined in accordance with this chapter or the 1968 Building Code and reference standard RS 9-6 of such code.

1601.2.4 Wind loads. All alterations, minor alterations, and ordinary repairs, to the extent of such work, shall be permitted to be performed in accordance with the wind load requirements set forth in the 1968 Building Code, or where the 1968 Building Code so authorizes, the code in effect prior to December 6, 1968.

Exceptions:

1. Equipment, appliances and supports that are exposed to wind shall be designed and installed to resist the wind pressures determined in accordance with Section 1609.
2. Wind loads on glass shall not be permitted to be calculated in accordance with the code in effect prior to December 6, 1968.
3. When the wind surface area of a prior code building or structure is increased by more than 5 percent in any direction or there is a permanent decrease of the lateral force capacity by more than 20 percent in any direction, the entire building or structure shall be designed to resist the design wind load as calculated pursuant to the applicable code, but not less than 5 psf (0.24k N/m²).

**SECTION BC 1602
DEFINITIONS AND NOTATIONS**

1602.1 Definitions. The following [~~words and terms shall, for the purposes of this code, have the meanings shown herein.~~] terms are defined in Chapter 2:

ALLOWABLE STRESS DESIGN.~~[A method of proportioning structural members, such that elastically computed stresses produced in the members by nominal loads do not exceed specified allowable stresses (also called “working stress design”).]~~

BALCONY, EXTERIOR.~~[See ASCE 7.]~~

DEAD [LOADS] LOAD.~~[The weight of materials of construction incorporated into the building, including but not limited to walls, floors, roofs, ceilings, stairways, built-in partitions, finishes, cladding and other similarly incorporated architectural and structural items, and the weight of fixed service equipment, such as cranes, plumbing stacks and risers, electrical feeders, heating, ventilating and air conditioning systems and automatic sprinkler systems.]~~

DECK.~~[See ASCE 7.]~~

DESIGN STRENGTH.~~[The product of the nominal strength and a resistance factor (or strength reduction factor).]~~

DIAPHRAGM.~~[A horizontal or sloped system acting to transmit lateral forces to the vertical-resisting elements. When the term “diaphragm” is used, it shall include horizontal bracing systems.]~~

Diaphragm, blocked.~~[In light frame construction, a diaphragm in which all sheathing edges not occurring on a framing member are supported on and fastened to blocking.]~~

Diaphragm boundary.~~[In light frame construction, a location where shear is transferred into or out of the diaphragm sheathing. Transfer is either to a boundary element or to another force-resisting element.]~~

Diaphragm chord.~~[A diaphragm boundary element perpendicular to the applied load that is assumed to take axial stresses due to the diaphragm moment.]~~

[Diaphragm, flexible. A diaphragm is flexible for the purpose of distribution of story shear and torsional moment where so indicated in ~~Section 12.3.1 of ASCE 7-10.~~]

[Diaphragm, rigid. A diaphragm is rigid for the purpose of distribution of story shear and torsional moment when the lateral deformation of the diaphragm is less than or equal to two times the average story drift.]

[DURATION OF LOAD. The period of continuous application of a given load, or the aggregate of periods of intermittent applications of the same load.]

ESSENTIAL FACILITIES.~~[Buildings and other structures that are intended to remain operational in the event of extreme environmental loading from flood, wind, snow or earthquakes.]~~

FABRIC PARTITION.~~[A partition consisting of a finished surface made of fabric, without a continuous rigid backing, that is directly attached to a framing system in which the vertical framing members are spaced greater than 4 feet (1219 mm) on-center.]~~

FACTORED LOAD.~~[The product of a nominal load and a load factor.]~~

[**GUARD.** See Section 1002.1.]

HELIPAD.

ICE-SENSITIVE STRUCTURE.

IMPACT LOAD.[The load resulting from moving machinery, elevators, craneways, vehicles and other similar forces and kinetic loads, pressure and possible surcharge from fixed or moving loads.]

LIMIT STATE.[A condition beyond which a structure or member becomes unfit for service and is judged to be no longer useful for its intended function (serviceability limit state) or to be unsafe (strength limit state).]

LIVE [LOADS] LOAD.[Those loads produced by the use and occupancy of the building or other structure and do not include construction or environmental loads such as wind load, snow load, rain load, earthquake load, flood load or dead load.]

LIVE [LOADS] LOAD (ROOF).[Those loads produced (1) during maintenance by workers, equipment and materials; and (2) during the life of the structure by movable objects such as planters and by people.]

LOAD AND RESISTANCE FACTOR DESIGN (LRFD). [A method of proportioning structural members and their connections using load and resistance factors such that no applicable limit state is reached when the structure is subjected to appropriate load combinations. The term “LRFD” is used in the design of steel and wood structures.]

LOAD EFFECTS.[Forces and deformations produced in structural members by the applied loads.]

LOAD FACTOR.[A factor that accounts for deviations of the actual load from the nominal load, for uncertainties in the analysis that transforms the load into a load effect, and for the probability that more than one extreme load will occur simultaneously.]

LOADS.[Forces or other actions that result from the weight of building materials, occupants and their possessions, environmental effects, differential movement and restrained dimensional changes. Permanent loads are those loads in which variations over time are rare or of small magnitude, such as dead loads. All other loads are variable loads (see also “Nominal loads”).]

NOMINAL LOADS.[The magnitudes of the loads specified in this chapter (dead, live, soil, wind, snow, rain, flood and earthquake).]

[NOTATIONS.]

[D = Dead load.]

[E = Combined effect of horizontal and vertical earthquake induced forces as defined in Section 12.4.2 of ASCE 7-10.]

[F = Load due to fluids with well defined pressures and maximum heights.]

[~~F_w~~ = Flood load in accordance with Chapter 5 of ASCE 7.]

[~~H~~ = Load due to lateral earth pressures, ground water pressure or pressure of bulk materials.]

[~~L~~ = Live load, except roof live load, including any permitted live load reduction.]

[~~L_r~~ = Roof live load including any permitted live load reduction.]

[~~plf~~ = pounds per linear foot.]

[~~psig~~ = pounds per square inch gauge.]

[~~R~~ = Rain load.]

[~~S~~ = Snow load.]

[~~T~~ = Self straining force arising from contraction or expansion resulting from temperature change, shrinkage, moisture change, creep in component materials, movement due to differential settlement or combinations thereof.]

[~~W~~ = Load due to wind pressure.]

OTHER STRUCTURES. [~~Structures, other than buildings, for which loads are specified in this chapter.~~]

PANEL (PART OF A STRUCTURE). [~~The section of a floor, wall or roof comprised between the supporting frame of two adjacent rows of columns and girders or column bands of floor or roof construction.~~]

RESISTANCE FACTOR. [~~A factor that accounts for deviations of the actual strength from the nominal strength and the manner and consequences of failure (also called “strength reduction factor”).~~]

RISK CATEGORY. [See definition for “Structural Occupancy Category.”]

STRENGTH, NOMINAL. [~~The capacity of a structure or member to resist the effects of loads, as determined by computations using specified material strengths and dimensions and equations derived from accepted principles of structural mechanics or by field tests or laboratory tests of scaled models, allowing for modeling effects and differences between laboratory and field conditions.~~]

STRENGTH, REQUIRED. [~~Strength of a member, cross section or connection required to resist factored loads or related internal moments and forces in such combinations as stipulated by these provisions.~~]

STRENGTH DESIGN. [~~A method of proportioning structural members such that the computed forces produced in the members by factored loads do not exceed the member design strength. The term “strength design” is used in the design of concrete and masonry structural elements.~~]

~~[STRUCTURAL OCCUPANCY CATEGORY. A category used to determine structural requirements based on occupancy.]~~

SUSCEPTIBLE BAY.

~~VEHICLE BARRIER. [SYSTEM. A system of building components near open sides of a garage floor or ramp or building walls that act as restraints for vehicles.]~~

NOTATIONS.

D	≡	<u>Dead load.</u>
D_i	≡	<u>Weight of ice in accordance with Chapter 10 of ASCE 7.</u>
E	≡	<u>Combined effect of horizontal and vertical earthquake induced forces as defined in Section 12.4.2 of ASCE 7.</u>
F	≡	<u>Load due to fluids with well-defined pressures and maximum heights.</u>
F_a	≡	<u>Flood load in accordance with Chapter 5 of ASCE 7.</u>
H	≡	<u>Load due to lateral earth pressures, ground water pressure or pressure of bulk materials.</u>
L	≡	<u>Roof live load greater than 20 psf (0.96 kN/m²) and floor live load.</u>
L_r	≡	<u>Roof live load of 20 psf (0.96 kN/m²) or less.</u>
R	≡	<u>Rain load.</u>
S	≡	<u>Snow load.</u>
T	≡	<u>Cumulative effects of self-straining load forces and effects.</u>
V_{asd}	≡	<u>Allowable stress design wind speed, miles per hour (mph) (km/hr) where applicable.</u>
V	≡	<u>Basic design wind speeds, miles per hour (mph) (km/hr) determined from Table 1609.3 of this code.</u>
W	≡	<u>Load due to wind pressure.</u>
W_i	≡	<u>Wind-on-ice in accordance with Chapter 10 of ASCE 7.</u>

SECTION BC 1603 CONSTRUCTION DOCUMENTS

1603.1 General. Construction documents shall include drawings that show the sizes, sections and relative locations of structural members with floor levels, column centers and offsets fully dimensioned. The design loads and other information pertinent to the structural design required by Sections 1603.1.1 through ~~[1603.1.9]~~ 1603.1.10 shall be clearly indicated on ~~[the]~~ such drawings of parts of the building or structure.

Exception: In lieu of the requirements of Sections 1603.1.1 through 1603.1.10, construction documents for buildings constructed in accordance with the conventional light-frame construction

provisions of Section 2308 shall include drawings that indicate the following structural design information:

1. Floor and roof dead and live loads.
2. Ground snow load, P_g .
3. Basic design wind speed [~~(3-second gust)~~], V , miles per hour (mph) (km/hr) and allowable stress design wind speed, V_{asd} , as determined in accordance with Section 1609.3.1 and wind exposure.
4. Seismic design category and site class.
5. Flood design data, if located in flood hazard areas [~~established in Section G102.2 of Appendix G~~].
6. Design load-bearing values of soils or rock under shallow foundations and/or the design load capacity of deep foundations.

1603.1.1 Floor live load. The uniformly distributed, concentrated and impact floor live load used in the design shall be indicated for floor areas. [~~Live~~] Use of live load reduction [of the uniformly distributed floor live loads, if used] in [the design,] accordance with Section 1607.11 shall be indicated for each type of live load used in the design.

1603.1.2 Partition loads. The equivalent uniform partition loads or, in lieu of these, a statement to the effect that the design was predicated on actual partition loads.

1603.1.3 Roof live load. The roof live load used in the design shall be indicated for roof areas [~~(Section 1607.11)~~] (Section 1607.13).

1603.1.4 Roof snow load data. The ground snow load, P_g , shall be indicated. The following additional information shall also be provided, regardless of whether snow loads govern the design of the roof:

1. Flat-roof snow load, P_f .
2. Snow exposure factor, C_e .
3. Snow load importance factor, I_s .
4. Thermal factor, C_t .
5. Slope factor(s), C_s .
6. Drift surcharge load(s), P_d , where the sum of P_d and P_f exceeds 20 psf (0.96 kN/m²).
7. Width of snow drift(s), w .

1603.1.5 Wind design data. The following information related to wind loads shall be shown, regardless of whether wind loads govern the design of the [~~lateral force-resisting~~] lateral force-resisting system of the [~~building~~] structure:

1. Basic design wind speed [~~(3-second gust)~~], V , miles per hour (km/hr) and/or allowable stress design wind speed, V_{asd} , as determined in accordance with Section 1609.3 and 1609.3.1.
2. [~~Wind importance factor, I , and structural occupancy~~] Risk category.
3. Wind exposure. [~~Where~~] Applicable wind direction if more than one wind exposure is utilized [~~, the wind exposure and applicable wind direction shall be indicated~~].
4. [~~The applicable~~] Applicable internal pressure coefficient.
5. [~~Components and cladding. The design~~] Design wind pressures [~~in terms of psf (kN/m²)~~] to be used for [~~the design of~~] exterior component and cladding materials not specifically designed by the registered design professional responsible for the design of the structure, psf (kN/m²).
6. Design base shear.

1603.1.6 Earthquake design data. The following information related to seismic loads shall be shown, regardless of whether seismic loads govern the design of the [~~lateral force-resisting~~] lateral force-resisting system of the [~~building~~] structure:

1. Risk category.
- [1-] 2. Seismic importance factor, [~~I , and structural occupancy category~~] I_e .
- [2-] 3. Mapped spectral response [~~accelerations~~] acceleration parameters, S_s and S_l .
- [3-] 4. Site class.
- [4-] 5. [~~Spectral~~] Design spectral response [~~coefficients~~] acceleration parameters, S_{DS} and S_{DI} .
- [5-] 6. Seismic design category.
- [6-] 7. Basic [~~seismic force-resisting~~] seismic force-resisting system(s).
- [7-] 8. Design base shear(s).
- [8-] 9. Seismic response coefficient(s), CS.
- [9-] 10. Response modification [~~factor~~] coefficient(s), R.
- [10-] 11. Analysis procedure used.

1603.1.7 Geotechnical information. The design load-bearing values of soils or rock under shallow foundations and/or the design load capacity of deep foundations shall be shown on the construction ~~[drawings]~~ documents.

1603.1.8 Flood ~~[load. Buildings]~~ hazard areas. Construction documents for buildings and other structures located in [areas of special] flood hazard areas shall [meet the design requirements of Section 5.3 of ASCE 7. The structural design shall be based on the design loads stated in Section 5.4 of ASCE 7.] comply with provisions of Section G104.2.1.

1603.1.9 Special loads. Special loads that are applicable to the design of the building, structure or portions thereof ~~[shall be indicated along with the specified section of this code that addresses the special loading condition],~~ including but not limited to the loads of machinery or equipment, and that are greater than the specified floor and roof loads shall be specified by their descriptions and locations.

1603.1.9.1 Photovoltaic panel systems. The dead load of rooftop-mounted photovoltaic panel systems, including rack support systems, shall be indicated on the construction documents.

1603.1.10 Superimposed dead loads. The uniformly distributed superimposed dead loads used in the design shall be indicated for floor and roof areas.

~~[1603.1.11 Other loads. Other loads used in the design, including but not limited to the loads of machinery or equipment, which are of greater magnitude than the loads defined in the specified floor and roof loads shall be indicated by their descriptions and locations.]~~

SECTION BC 1604 GENERAL DESIGN REQUIREMENTS

1604.1 General. Building, structures and parts thereof shall be designed and constructed in accordance with strength design, load and resistance factor design, allowable stress design, empirical design or conventional construction methods, as permitted by the applicable material chapters and referenced standards.

1604.2 Strength. Buildings and other structures, and parts thereof, shall be designed and constructed to support safely the factored loads in load combinations defined in this code without exceeding the appropriate strength limit states for the materials of construction. Alternatively, buildings and other structures, and parts thereof, shall be designed and constructed to support safely the nominal loads in load combinations defined in this code without exceeding the appropriate specified allowable stresses for the materials of construction. Loads and forces for occupancies or uses not covered in this chapter shall be subject to the approval of the commissioner.

1604.3 Serviceability. Structural systems and members thereof shall be designed to have adequate stiffness to limit deflections ~~[and lateral drift. See Section 12.12.1 of ASCE 7-10 for drift limits applicable to earthquake loading.]~~ as indicated in Table 1604.3 of this code. Drift limits applicable to earthquake loading shall be in accordance with ASCE 7 Chapter 12, 13, 15 or 16, as applicable.

TABLE 1604.3
DEFLECTION LIMITS^{a,b,c,h,i}

CONSTRUCTION	L or L_c	S or W^f	$D + L^{d,g}$
Roof members: ^e			
Supporting plaster or stucco ceiling	$l/360$	$l/360$	$l/240$
Supporting nonplaster ceiling	$l/240$	$l/240$	$l/180$
Not supporting ceiling	$l/180$	$l/180$	$l/120$
Floor members	$l/360$	—	$l/240$
Exterior walls [and interior partitions]:			
With plaster or stucco finishes	=	$l/360$	=
With <u>other</u> brittle finishes	—	$l/120$ $l/240$	—
With flexible finishes	—	$l/120$	—
Interior partitions: ^b			
With plaster or stucco finishes	$l/360$	=	=
With <u>other</u> brittle finishes	$l/240$	=	=
With flexible finishes	$l/120$	=	=
Farm buildings	—	—	$l/180$
Greenhouses	—	—	$l/120$

For SI: 1 foot = 304.8 mm.

- a. For structural roofing and siding made of formed metal sheets, the total load deflection shall not exceed $l/60$. For secondary roof structural members supporting formed metal roofing, the live load deflection shall not exceed $l/150$. For secondary wall members supporting formed metal siding, the design wind load deflection shall not exceed $l/90$. For roofs, this exception only applies when the metal sheets have no roof covering.
- b. [~~Interior partitions not exceeding 6 feet in height and flexible~~] Flexible, folding and portable partitions are not governed by the provisions of this section. The deflection criterion for interior partitions is based on the horizontal load defined in Section [~~1607.13~~] 1607.15.
- c. See Section 2403 for glass supports.
- d. [~~For wood structural members having a moisture content of less than 16 percent at time of installation and used under dry conditions, the deflection resulting from $L + 0.5D$ is permitted to be substituted for the deflection resulting from $L + D$.] The deflection limit for the $D+(L+L_c)$ load combination only applies to the deflection due to the creep component of long-term dead load deflection plus the short-term live load deflection. For lumber, structural glued laminated timber, prefabricated wood I-joists and structural composite lumber members that are dry at time of installation and used under dry conditions in accordance with the ANSI/AWC NDS, the creep component of the long-term deflection shall be permitted to be estimated as the immediate dead load deflection resulting from $0.5D$. For lumber and glued laminated timber members installed or used at all other moisture conditions or cross laminated timber and wood structural panels that are dry at time of installation and used under dry conditions in accordance with ANSI/AWC NDS, the creep component of the long-term deflection is permitted to be estimated as the immediate dead load deflection resulting from D . The value of $0.5D$ shall not be used in combination with ANSI/AWC NDS provisions for long-term loading.~~
- e. The [~~above~~] preceding deflections do not ensure against ponding. Roofs that do not have sufficient slope or camber to [~~assure~~] ensure adequate drainage shall be investigated for ponding. See [Section 1611 for rain and ponding requirements and Section 1503.4 for roof drainage requirements] Chapter 8 of ASCE 7.
- f. The wind load [~~is~~] shall be permitted to be taken as [~~0.7~~] 0.42 times the "component and cladding" loads or directly calculated using the 10-year mean return interval wind speed for the purpose of determining deflection limits [~~herein~~] in Table 1604.3. Where framing members support glass, the deflection limit therein shall not exceed that specified in Section 1604.3.7.
- g. For steel structural members, the deflection due to creep component of long-term dead load shall be permitted to be taken as zero.
- h. For aluminum structural members or aluminum panels used in skylights and sloped glazing framing, roofs or walls of sunroom additions or patio covers[;] not supporting edge of glass or aluminum sandwich panels, the total load deflection shall not exceed $l/60$. For continuous aluminum structural members supporting edge of glass, the total load deflection shall not exceed $l/175$ for each glass lite or $l/60$ for the entire length of the member, whichever is more stringent. For aluminum sandwich panels used in roofs or walls of sunroom additions or patio covers, the total load deflection shall not exceed $l/120$.
- i. l = Length of the member between supports. For cantilever members, l shall be taken as twice the length of the cantilever.

1604.3.1 Deflections. The deflections of structural members shall not exceed the more restrictive of the limitations of Sections 1604.3.2 through 1604.3.5 or that permitted by Table 1604.3.

1604.3.2 Reinforced concrete. The deflection of reinforced concrete structural members shall not exceed that permitted by ACI 318.

1604.3.3 Steel. The deflection of steel structural members shall not exceed that permitted by AISC 360, AISI [~~HSS S 100, ASCE 3~~] S100, ASCE 8, and SJI CJ 1.0 SJI JG 1.1, SJI K 1.1 or SJI LH/DLH 1.1] SJI 100 or SJI 200, as applicable.

1604.3.4 Masonry. The deflection of masonry structural members shall not exceed that permitted by TMS 402 [~~ACI 530/ASCE 5~~], as modified by Chapter 21 of this code.

1604.3.5 Aluminum. The deflection of aluminum structural members shall not exceed that permitted by AA ADM1.

1604.3.6 Limits. [~~For limits on the deflection of structural members, refer to the relevant material design standards. Should a design standard not provide for deflection limits, deflection of structural members over span, l, shall not exceed that permitted by Table 1604.3.~~] The deflection limits of Section 1604.3.1 shall be used unless more restrictive deflection limits are required by a referenced standard for the element or finish material.

1604.3.7 Framing supporting glass. The deflection of framing members supporting glass subjected to 0.6 times the “component and cladding” wind loads shall not exceed either of the following:

1. $1/175$ of the length of span of the framing member, for framing members having a length not more than 13 feet 6 inches (4115 mm).
2. $1/240$ of the length of span of the framing member + $1/4$ inch (6.4 mm), for framing members having a length greater than 13 feet 6 inches (4114.8 mm).

1604.4 Analysis. Load effects on structural members and their connections shall be determined by methods of structural analysis that take into account equilibrium, general stability, geometric compatibility and both short- and long-term material properties.

Members that tend to accumulate residual deformations under repeated service loads shall have included in their analysis the [~~added eccentricities~~] effects of added deformations expected to occur during their service life. Secondary stresses in trusses shall be considered and, where of significant magnitude, their effects shall be provided for in the design.

Any system or method of construction to be used shall be based on a rational analysis in accordance with well-established principles of mechanics. Such analysis shall result in a system that provides a complete load path capable of transferring loads from their point of origin to the load-resisting elements.

The total lateral force shall be distributed to the various vertical elements of the [~~lateral force-resisting~~] lateral force-resisting system in proportion to their rigidities, considering the rigidity of the horizontal bracing system or diaphragm. Rigid elements [~~that are~~] assumed not to be a part of the [~~lateral force-resisting~~] lateral force-resisting system [~~shall be~~] are permitted to be incorporated into buildings provided that their effect on the action of the system is considered and provided for in the design. [~~Except where diaphragms are flexible, or are permitted to be analyzed as flexible~~] A diaphragm is rigid for the purpose of distribution of story shear and torsional moment when the lateral deformation of the diaphragm is less than or equal to two times the average story drift. Where required

by ASCE 7, provisions shall be made for the increased forces induced on resisting elements of the structural system resulting from torsion due to eccentricity between the center of application of the lateral forces and the center of rigidity of the ~~[lateral force resisting]~~ lateral force-resisting system.

Every structure shall be designed to resist the effects caused by the forces specified in this chapter including overturning ~~[effects caused by the lateral forces specified in this chapter]~~, uplift and sliding. ~~[See Section 1609 for wind loads, Section 1610 for lateral soil loads and Section 1613 for earthquake loads.]~~ Where sliding is used to isolate the elements, the effects of friction between sliding elements shall be included as a force.

1604.5 [Structural occupancy] Risk category. Each building and structure shall be assigned a ~~[structural occupancy]~~ risk category in accordance with Table 1604.5 of this code. Where a referenced standard specifies an occupancy category, the risk category shall not be taken as lower than the occupancy category specified therein. Where a referenced standard specifies that the assignment of a risk category be in accordance with ASCE 7, Table 1.5-1, Table 1604.5 of this code shall be used in lieu of ASCE 7, Table 1.5-1.

**TABLE 1604.5
[STRUCTURAL OCCUPANCY/] RISK CATEGORY OF BUILDINGS AND [IMPORTANCE FACTORS] OTHER
STRUCTURES**

[STRUCTURAL STRUCTURAL OCCUPANCY/] RISK CATEGORY ^(a)	NATURE OF OCCUPANCY/[RISK]
I	Buildings and other structures that represent a low hazard to human life in the event of failure, including [-] but not limited to: <ol style="list-style-type: none"> 1. Agricultural facilities, 2. Certain temporary facilities, 3. Minor storage facilities,
II	Buildings and other structures except those listed in [Structural-Structural-Occupancy/] Risk Categories I, III and IV.
III	Buildings and other structures that represent a substantial hazard to human life in the event of failure, including [-] but not limited to: <ol style="list-style-type: none"> 1. Buildings and other structures whose primary occupancy is [public assembly] Places of Assembly with an occupant load greater than 300. 2. Buildings and other structures containing [elementary school, secondary school or day care facilities] a Group E occupancy with an occupant load greater than 250. 3. Buildings and other structures containing [adult education facilities, such as colleges and universities] educational occupancies for students above the 12th grade with an occupant load greater than 500. 4. Group I-2 occupancies with an occupant load of 50 or more resident [patients] care recipients but not having surgery or emergency treatment facilities. 5. Group I-3 occupancies. 6. Any other occupancy with an occupant load greater than 5,000^a. 7. Power-generating stations, water treatment facilities for potable water, waste[-] water treatment facilities and other public utility facilities not included in [Structural-Structural-Occupancy/] Risk Category IV. 8. Buildings and other structures not included in [Structural-Structural-Occupancy/] Risk Category IV containing [sufficient] quantities of toxic or explosive [substances to be dangerous to the public if released.] materials that: <u>Exceed maximum allowable quantities per control area as given in Table 307.1(1) or 307.1(2), or per outdoor control area in accordance with the New York City Fire Code; and</u> <u>Are sufficient to pose a threat to the public if released.^b</u>

TABLE 1604.5
[STRUCTURAL OCCUPANCY/] RISK CATEGORY OF BUILDINGS AND [IMPORTANCE FACTORS] OTHER STRUCTURES

[STRUCTURAL OCCUPANCY/] RISK CATEGORY ^(a)	NATURE OF OCCUPANCY/[RISK]
IV	Buildings and other structures designed as essential facilities, including[-] but not limited to: <ol style="list-style-type: none"> 1. Group I-2 occupancies having surgery or emergency treatment facilities. 2. Fire, rescue, ambulance and police stations and emergency vehicle garages. 3. Designated earthquake, hurricane or other emergency shelters. 4. Designated emergency preparedness, [eommunication;-] <u>communications</u> and [operation] <u>operations</u> centers and other facilities required for emergency response. 5. Power-generating stations and other public utility facilities required as emergency backup facilities for [Structural Occupancy/] Risk Category IV structures. 6. [Structures] <u>Buildings and other structures</u> containing quantities of highly toxic materials [as defined by Section 307 where the quantity of the material exceeds the maximum allowable quantities of Table 307.7(2)-] <u>that:</u> <u>Exceed maximum allowable quantities per control area as given in Table 307.1(2) or per outdoor control area in accordance with the New York City Fire Code; and</u> <u>Are sufficient to pose a threat to the public if released^b</u> 7. Aviation control towers, air traffic control centers and emergency aircraft hangars. 8. Buildings and other structures having critical national defense functions. 9. Water storage facilities and pump structures required to maintain water pressure for fire suppression.

- a. [For the purpose of Section 1616.2, Structural Occupancy Categories I and II are considered Seismic Use Group I, Structural Occupancy Category III is considered Seismic Use Group II and Structural Occupancy Category IV is equivalent to Seismic Use Group III.] For purposes of occupant load calculation, occupancies required by Table 1004.1.3 to use gross floor area calculations shall be permitted to use net floor areas to determine the total occupant load.
- b. Where approved by the commissioner, the classification of buildings and other structures as Risk Category III or IV based on their quantities of toxic, highly toxic or explosive materials is permitted to be reduced to Risk Category II, provided it can be demonstrated by a hazard assessment in accordance with Section 1.5.3 of ASCE 7 that a release of the toxic, highly toxic or explosive materials is not sufficient to pose a threat to the public.

1604.5.1 Multiple occupancies. Where a building or structure is occupied by two or more occupancies not included in the same [structural occupancy] risk category, it shall be assigned the classification of the highest [structural occupancy] risk category corresponding to the various occupancies. Where buildings or structures have two or more portions that are structurally separated, each portion shall be separately classified. Where a separated portion of a building or structure provides required access to, required egress from or shares life safety components with another portion having a higher [structural occupancy] risk category, both portions shall be assigned to the higher [structural occupancy] risk category.

Exception: Where a storm shelter designed and constructed in accordance with ICC 500 is provided in a building, structure or portion thereof normally occupied for other purposes, the risk category for the normal occupancy of the building shall apply unless the storm shelter is a designated emergency shelter in accordance with Table 1604.5 of this code.

1604.5.2 Importance factors. Importance factors for snow, ice, wind and seismic loads shall be determined in accordance with ASCE 7, Table [1604.5.2] 1.5-2 based on the [Structural Occupancy Category or] risk category assigned in accordance with Table 1604.5 of this code.

[TABLE 1604.5.2
IMPORTANCE FACTORS]

[Structural Occupancy/Risk Category]	[Snow Importance Factor, I]	[Wind Importance Factor, I]	[Seismic Importance Factor, I]
[I]	[0.80]	[0.87]	[1.00]

[II]	[1-00]	[1-00]	[1-00]
[III]	[1-10]	[1-15]	[1-25]
[IV]	[1-20]	[1-15]	[1-50]

1604.6 In-situ load tests. The commissioner is authorized to require an engineering analysis or a load test, or both, of any construction whenever there is reason to question the safety of the construction for the intended occupancy. Engineering analysis and load tests shall be conducted in accordance with Section ~~[1714]~~ 1708.

1604.7 Preconstruction load tests. Materials and methods of construction that are not capable of being designed by ~~[recognized]~~ approved engineering analysis or that do not comply with the applicable ~~[material design]~~ referenced standards [listed in Chapter 35], or alternative test procedures in accordance with Section ~~[1712]~~ 1709, shall be load tested in accordance with Section ~~[1715]~~ 1710.

1604.8 Anchorage. Buildings and other structures, and portions thereof, shall be provided with anchorage in accordance with Sections 1604.8.1 through 1604.8.4, as applicable.

1604.8.1 General. Anchorage of the roof to walls and columns, and of walls and columns to foundations, shall be provided to resist the uplift and sliding forces that result from the application of the prescribed loads and load combinations.

~~[1604.8.2 Walls. Walls shall be anchored to floors, roofs and other structural elements that provide lateral support for the wall. Such anchorage shall provide a positive direct connection capable of resisting the horizontal forces specified in this chapter but not less than the minimum strength design horizontal force specified in Section 11.7.3 of ASCE 7, substituted for “E” in the load combinations of Section 1605.2 or 1605.3. Concrete and masonry walls shall be designed to resist bending between anchors where the anchor spacing exceeds 4 feet (1219 mm). Required anchors in masonry walls of hollow units or cavity walls shall be embedded in a reinforced grouted structural element of the wall. See Section 1609 for wind design requirements and Section 1613 for and earthquake design requirements.]~~

1604.8.2 Structural walls. Walls that provide vertical load-bearing resistance or lateral shear resistance for a portion of the structure shall be anchored to the roof and to all floors and members that provide lateral support for the wall or that are supported by the wall. The connections shall be capable of resisting the horizontal forces specified in Section 1.4.4 of ASCE 7 for walls of structures assigned to Seismic Design Category A and to Section 12.11 of ASCE 7 for walls of structures assigned to all other seismic design categories. Required anchors in masonry walls of hollow units or cavity walls shall be embedded in a reinforced grouted structural element of the wall. See Sections 1609 of this code for wind design requirements and Section 1613 of this code for earthquake design requirements.

1604.8.3 Decks. Where supported by attachment to an exterior wall, decks shall be positively anchored to the primary structure and designed for both vertical and lateral loads as applicable.

Such attachment shall not be accomplished by the use of toenails or nails subject to withdrawal. Where positive connection to the primary building structure cannot be verified during inspection, decks shall be self-supporting. Connections of decks with cantilevered framing members to exterior walls or other framing members shall be designed for both of the following: [-]

1. The reactions resulting from the dead load and live load specified in Table 1607.1, or the snow load specified in Section 1608, in accordance with Section 1605, acting on all portions of the deck.
2. The reactions resulting from the dead load and live load specified in Table 1607.1, or the snow load specified in Section 1608, in accordance with Section 1605, acting on the cantilevered portion of the deck, and no live load or snow load on the remaining portion of the deck.

1604.8.4 Non-structural walls and partitions. Walls not meeting the requirements of Section 1604.8.2 and partitions shall be laterally supported with sufficient mechanical anchorage to resist the loads imposed per this code, including but not limited to live loads, wind loads, and earthquake loads.

~~[1604.9 Counteracting structural actions. Structural members, systems, components and cladding shall be designed to resist forces due to earthquake and wind, with consideration of overturning, sliding and uplift. Continuous load paths shall be provided for transmitting these forces to the foundation. Where sliding is used to isolate the elements, the effects of friction between sliding elements shall be included as a force.]~~

[1604.10] 1604.9 Wind and seismic detailing. ~~[Lateral force-resisting]~~ Lateral force-resisting systems shall meet seismic detailing requirements and limitations prescribed in this code and ASCE 7[-10, excluding ASCE 7-10 Chapter 14 and ASCE 7-10 Appendix 11A,] Chapters 11, 12, 13, 15, 17 and 18 of this code as applicable, even when wind load effects are greater than seismic load effects. Where ASCE 7 references Chapter 14 of ASCE 7 those references shall not apply, except as specifically required in this code.

1604.10 Loads on storm shelters. Loads and load combinations on storm shelters shall be determined in accordance with ICC 500.

SECTION BC 1605 LOAD COMBINATIONS

1605.1 General. Buildings and other structures and portions thereof shall be designed to resist: [-]

1. The load combinations specified in Section 1605.2 or 1605.3;
2. The load combinations specified in Chapters 18 through 23; and
3. The seismic load ~~[combinations with]~~ effects including overstrength ~~[factors specified]~~ factor in accordance with ~~[Section 12.4.3.2]~~ Sections 2.3.6 and 2.4.5 of ASCE 7[-10,] where required by ~~[Section 12.2.5.2, 12.3.3.3 or 12.10.2.1 of ASCE 7-10]~~ Chapters 12, 13, and 15 of ASCE

7. With the simplified procedure of ~~[ASCE 7-10]~~ Section 12.14 of ASCE 7, the seismic load ~~[combinations with]~~ effects including overstrength ~~[factors specified]~~ factor in accordance with Section 12.14.3.2 and Chapter 2 of ASCE 7~~[-10]~~ shall be used.

Applicable loads shall be considered, including both earthquake and wind, in accordance with the specified load combinations. Each load combination shall also be investigated with one or more of the variable loads set to zero.

Where the load combinations with overstrength factor in ~~[Section 12.4.3.2]~~ Sections 2.3.6 and 2.4.5 of ASCE 7~~[-10]~~ apply, they shall be used as follows:

1. The basic combinations for strength design with overstrength factor in lieu of Equations 16-5 and 16-7 in Section ~~[1605.2.1]~~ 1605.2.
2. The basic combinations for allowable stress design with overstrength factor in lieu of Equations 16-12, ~~[16-13]~~ 16-14 and ~~[16-15]~~ 16-16 in Section 1605.3.1.

1605.1.1 Stability. Regardless of which load combinations are used to design for strength, where overall structure stability (such as stability against overturning, sliding, or buoyancy) is being verified, use of the load combinations specified in Section 1605.2 or 1605.3 shall be permitted. Where the load combinations specified in Section 1605.2 are used, strength reduction factors applicable to soil resistance shall be provided by a registered design professional. The stability of retaining walls shall be verified in accordance with Section ~~[1806.2]~~ 1807.2.

1605.2 Load combinations using strength design or load and resistance factor design.

~~[1605.2.1 Basic load combinations.]~~ Where strength design or load and resistance factor design is used, buildings and other structures, and portions thereof, shall be designed to resist the most critical effects resulting from the following combinations of factored loads:

$$1.4(D + F) \tag{Equation 16-1}$$

$$\begin{aligned} &[\cancel{1.2(D + F) + T + 1.6(L + H) + 0.5(L_r \text{ or } S \text{ or } R)}] \\ &\underline{1.2(D + F) + 1.6(L + H) + 0.5(L_r \text{ or } S \text{ or } R)} \end{aligned} \tag{Equation 16-2}$$

$$\begin{aligned} &[\cancel{1.2D + 1.6(L_r \text{ or } S \text{ or } R) + (f_1 L \text{ or } 0.8W)}] \\ &\underline{1.2(D + F) + 1.6(L_r \text{ or } S \text{ or } R) + 1.6H + (f_1 L \text{ or } 0.5W)} \end{aligned} \tag{Equation 16-3}$$

$$\begin{aligned} &[\cancel{1.2D + 1.6W + f_1 L + 0.5(L_r \text{ or } S \text{ or } R)}] \\ &\underline{1.2(D + F) + 1.0W + f_1 L + 1.6H + 0.5(L_r \text{ or } S \text{ or } R)} \end{aligned} \tag{Equation 16-4}$$

$$\begin{aligned} &[\cancel{1.2D + 1.0E + f_1 L + f_2 S}] \\ &\underline{1.2(D + F) + 1.0E + f_1 L + 1.6H + f_2 S} \end{aligned} \tag{Equation 16-5}$$

$$\begin{aligned} &[\cancel{0.9D + 1.6W + 1.6H}] \\ &\underline{0.9D + 1.0W + 1.6H} \end{aligned} \tag{Equation 16-6}$$

$$\frac{[0.9D + 1.0E + 1.6H]}{0.9(D + F) + 1.0E + 1.6H}$$

(Equation 16-7)

where:

$f_1 =$ ~~[1.0]~~ 1 for ~~[floors in]~~ places of public assembly ~~[, for]~~ live loads in excess of 100 pounds per square foot (4.79 kN/m²), and ~~[for]~~ parking ~~[garage live load,]~~ garages; and
~~[=—]~~ 0.5 for other live loads.

$f_2 =$ 0.7 for roof configurations (such as saw tooth) that do not shed snow off the structure, and

~~[=—]~~ 0.2 for other roof configurations.

[Exception:] Exceptions:

1. Where other factored load combinations are specifically required by ~~the~~ other provisions of this code, such combinations shall take precedence.
2. Where the effect of H resists the primary variable load effect, a load factor of 0.9 shall be included with H where H is permanent and H shall be set to zero for all other conditions.

[1605.2.2] 1605.2.1 Other loads. Where a structure is located in a V zone or Coastal A zone and F_a is to be considered in design, in addition to the load combinations of Equations 16-1 through 16-7, the structure and portions thereof shall resist the most critical effects of the load combinations of Equations 16-8 and 16-10. Where a structure is located in an A zone and F_a is to be considered in design, in addition to the load combinations of Equations 16-1 through 16-7, structures and portions thereof shall resist the most critical effects of the load combinations of Equation 16-9 and 16-11. Where ice loads are to be considered in design, the load combinations of Section ~~[2.3.4]~~ 2.3.3 of ASCE 7 shall be used. Refer to the following sections for other load combinations:

Flood Load Combinations:

$$\frac{[1.2D + 1.6W + 2.0F_a + f_1L + 0.5(L_r \text{ or } S \text{ or } R)]}{1.2(D + F) + 1.0W + 2.0F_a + f_1L + 1.6H + 0.5(L_r \text{ or } S \text{ or } R)}$$

$$1.2(D + F) + 1.0W + 2.0F_a + f_1L + 1.6H + 0.5(L_r \text{ or } S \text{ or } R)$$

(Equation 16-8)

$$\frac{[1.2D + .8W + 1.0F_a + f_1L + 0.5(L_r \text{ or } S \text{ or } R)]}{1.2(D + F) + 0.5W + 1.0F_a + f_1L + 1.6H + 0.5(L_r \text{ or } S \text{ or } R)}$$

$$1.2(D + F) + 0.5W + 1.0F_a + f_1L + 1.6H + 0.5(L_r \text{ or } S \text{ or } R)$$

(Equation 16-9)

$$\frac{[0.9D + 1.6W + 2.0F_a + 1.6H]}{0.9D + 1.0W + 2.0F_a + 1.6H}$$

$$0.9D + 1.0W + 2.0F_a + 1.6H$$

(Equation 16-10)

$$\frac{[0.9D + 0.8W + 1.0F_a + 1.6H]}{0.9D + 0.5W + 1.0F_a + 1.6H}$$

$$0.9D + 0.5W + 1.0F_a + 1.6H$$

(Equation 16-11)

1605.3 Load combinations using allowable stress design. Load combinations for allowable stress design shall be in accordance with Section 1605.3.1 or 1605.4.

1605.3.1 Basic load combinations. Where allowable stress design (working stress design), as permitted by this code, is used, structures and portions thereof shall resist the most critical effects resulting from the following combinations of loads:

$$D + F \quad \text{(Equation 16-12)}$$

$$\frac{[D + H + F + L + T]}{D + H + F + L} \quad \text{(Equation 16-13)}$$

$$D + H + F + (L_r \text{ or } S \text{ or } R) \quad \text{(Equation 16-14)}$$

$$\frac{[D + H + F + 0.75(L + T) + 0.75(L_r \text{ or } S \text{ or } R)]}{D + H + F + 0.75(L) + 0.75(L_r \text{ or } S \text{ or } R)} \quad \text{(Equation 16-15)}$$

$$\frac{[D + F + H + (W \text{ or } 0.7E)]}{D + H + F + (0.6W \text{ or } 0.7E)} \quad \text{(Equation 16-16)}$$

$$\frac{[D + H + F + 0.75(W \text{ or } 0.7E) + 0.75L + 0.75(L_r \text{ or } S \text{ or } R)]}{D + H + F + 0.75(0.6W) + 0.75L + 0.75(L_r \text{ or } S \text{ or } R)} \quad \text{(Equation 16-17)}$$

$$\frac{[0.6 + W + H]}{D + H + F + 0.75(0.7E) + 0.75L + 0.75S} \quad \text{(Equation 16-18)}$$

$$\frac{[0.6 + 0.7E + H]}{0.6D + 0.6W + H} \quad \text{(Equation 16-19)}$$

$$\frac{0.6(D + F) + 0.7E + H}{\quad} \quad \text{(Equation 16-20)}$$

Exceptions:

1. Crane hook loads need not be combined with roof live load or with more than three-fourths of the snow load or one-half of the wind load.
2. Flat roof snow loads of 30 psf (1.44 kN/m²) or less and roof live loads of 30 psf (1.44 kN/m²) or less need not be combined with seismic loads. Where flat roof snow loads exceed 30 psf (1.44 kN/m²), 20 percent shall be combined with seismic loads.
3. Where the effect of H resists the primary variable load effect, a load factor of 0.6 shall be included with H where H is permanent and H shall be set to zero for all other conditions.

4. In Equation 16-19, the wind load, W, is permitted to be reduced in accordance with Exception 2 of Section 2.4.1 of ASCE 7.
5. In Equation 16-20, 0.6 D is permitted to be increased to 0.9 D for the design of special reinforced masonry shear walls complying with Chapter 21.

1605.3.1.1 Stress increases. Increases in allowable stresses specified in the appropriate material chapter or the referenced standards shall not be used with the load combinations of Section 1605.3.1, except that increases shall be permitted in accordance with Chapter 23.

1605.3.1.2 Other loads. Where a structure is located in a V zone or Coastal A zone and F_a is to be considered in design, in addition to load combinations of Equations 16-12 through ~~[16-19]~~ 16-20, structures and portions thereof shall resist the most critical effects of load combinations of Equations ~~[16-20]~~ 16-21, ~~[16-22]~~ 16-23 and ~~[16-24]~~ 16-25. Where a structure is located in ~~[a]~~ an A zone and F_a is to be considered in design, in addition to load combinations of Equations 16-12 through ~~[16-19]~~ 16-20, structures and portions thereof shall resist the most critical effects of load combinations of Equations ~~[16-21]~~ 16-22, ~~[16-23]~~ 16-24 and ~~[16-25]~~ 16-26. Where ice loads are to be considered in design, the load combinations of Section 2.4.3 of ASCE 7 shall be used. ~~[Refer to the following sections for other loads:]~~

Flood Load Combinations:

$$[\cancel{D + H + F + 1.5F_a + W}] \quad [(\text{Equation 16-20})]$$

$$\underline{D + H + F + 0.6W + 1.5F_a} \quad \underline{\text{(Equation 16-21)}}$$

$$[\cancel{D + H + F + 0.75F_a + W}] \quad [(\text{Equation 16-21})]$$

$$\underline{D + H + F + 0.6W + 0.75F_a} \quad \underline{\text{(Equation 16-22)}}$$

$$[\cancel{D + H + F + 0.75W + 0.75L + 0.75(L_r \text{ or } S \text{ or } R) + 1.5F_a}] \quad [(\text{Equation 16-22})]$$

$$\underline{D + H + F + 0.75(0.6W) + 0.75L + 0.75(L_r \text{ or } S \text{ or } R) + 1.5F_a} \quad \underline{\text{(Equation 16-23)}}$$

$$[\cancel{D + H + F + 0.75W + 0.75L + 0.75(L_r \text{ or } S \text{ or } R) + 0.75F_a}] \quad [(\text{Equation 16-23})]$$

$$\underline{D + H + F + 0.75(0.6W) + 0.75L + 0.75(L_r \text{ or } S \text{ or } R) + 0.75F_a} \quad \underline{\text{(Equation 16-24)}}$$

$$[\cancel{0.6D + W + H + 1.5F_a}] \quad [(\text{Equation 16-24})]$$

$$\underline{0.6D + 0.6W + H + 1.5F_a} \quad \underline{\text{(Equation 16-25)}}$$

$$[\cancel{0.6D + W + H + 0.75F_a}] \quad [(\text{Equation 16-25})]$$

$$\underline{0.6D + 0.6W + H + 0.75F_a} \quad \underline{\text{(Equation 16-26)}}$$

1605.4 [~~Heliports and helistops.~~ Heliport and helistop landing areas shall be designed for the following loads, combined in accordance with Section 1605:]

[1. ~~Dead load, D, plus the gross weight of the helicopter, D_h , plus snow load, S.~~]

[2. ~~Dead load, D, plus two single concentrated impact loads, L, approximately 8 feet (2438 mm) apart applied anywhere on the touchdown pad (representing each of the helicopter's two main landing gear, whether skid type or wheeled type), having a magnitude of 0.75 times the gross weight of the helicopter. Both loads acting together total 1.5 times the gross weight of the helicopter.~~]

[3. ~~Dead load, D, plus a uniform live load, L, of 100 psf (4.79 kN/m²).~~]

[Exception: Landing areas designed for helicopters with gross weights not exceeding 3,000 pounds (13.34 kN) in accordance with Items 1 and 2 shall be permitted to be designed using a 40 psf (1.92 kN/m²) uniform live load in Item 3, provided the landing area shall be identified with a 3,000-pound (13.34 kN) weight limitation and the 40 psf (1.92 kN/m²) uniform live load shall not be reduced. The landing area weight limitation shall be indicated by the numeral “3” (kips) located in the bottom right corner of the landing area as viewed from the primary approach path. The indication for the landing area weight limitation shall be a minimum 5 feet (1524 mm) in height.]

[1605.5] Structural integrity load combinations—alternate load path method. Where specifically required by Sections [~~1614~~1624] 1615 through [~~1616~~] 1617, elements and components shall be designed to resist the forces calculated using the following combination of factored loads:

$$D + f_1L + f_2W \qquad \qquad \qquad \text{[(~~Equation 16-26~~)] Equation 16-27}$$

where:

$f_1 = 0.25$ for buildings in [~~Structural Occupaney~~] Risk Category II.

$f_1 = 0.5$ for buildings in [~~Structural Occupaney~~] Risk Category III or IV.

$f_2 = 0$ for buildings in [~~Structural Occupaney~~] Risk Category II.

$f_2 = 0.33$ for buildings in [~~Structural Occupaney~~] Risk Category III or IV.

The live load component f_1L need not be greater than the reduced live load.

[1605.6] 1605.5 Structural integrity load combinations—vehicular impact and gas explosions. Where specifically required by Sections [~~1615.5~~] 1616.4 and [~~1615.6~~] 1616.5, elements and components shall be designed to resist the forces calculated using the following combination of factored loads:

$$1.2D + A_k + (0.5L \text{ or } 0.2S) \qquad \qquad \qquad \text{[(~~Equation 16-27~~)] Equation 16-28}$$

$$0.9D + A_k + 0.2W \qquad \qquad \qquad \text{[(~~Equation 16-28~~)] Equation 16-29}$$

Where A_k is the load effect of the vehicular impact or gas explosion.

~~[1605.7]~~ **1605.6 Structural integrity load combinations—specific local resistance method.** Where the specific local resistance method is used in a key element analysis, the specified local loads shall be used as specified in Section ~~[1616.7]~~ **1617.6.**

**SECTION BC 1606
DEAD LOADS**

1606.1 General. Dead loads are those loads defined in ~~[Section 1602.1]~~ Chapter 2 of this code. Dead loads shall be considered permanent loads.

1606.2 Design dead load. For purposes of design, the actual weights of materials of construction and fixed service equipment shall be used. In the absence of definite information, values used shall be subject to the approval of the commissioner.

**SECTION BC 1607
LIVE LOADS**

1607.1 General. Live loads are those loads defined in ~~[Section 1602.1]~~ Chapter 2 of this code.

**TABLE 1607.1
MINIMUM UNIFORMLY DISTRIBUTED LIVE LOADS, L_o , AND MINIMUM
CONCENTRATED LIVE LOADS $[F+1]C$**

OCCUPANCY OR USE	UNIFORM (psf)	CONCENTRATED [(Abs.)] (pounds)
1. Apartments (see residential)	—	—
2. Access floor systems		
Office use	50	2,000
Computer use	100	2,000
3. Armories and drill rooms	150 ^m	—
4. Assembly areas [and theaters]		
Fixed seats (fastened to floor)	60 ^m	
Follow spot, projections and control rooms	50	
Lobbies	100 ^m	
Movable seats	100 ^m	—
Private assembly spaces, including conference rooms	50	
[Stages and platforms] Stage floors	[125] 150 ⁿ	
[Follow spot, projections and control rooms]	[50]	
Platforms (assembly)	100 ^m	
[Catwalks]	[40]	
Other assembly spaces	[Note h] 100 ^m	
5. Balconies [(exterior)] and Decks ^{lslh}	1.5 times the live load for the occupancy served. Not required to exceed 100 psf	—
6. [Bowling alleys] Catwalks	[75] 40	[-] 300
7. Cornices	60	—
8. Corridors [- except as otherwise indicated]		
First floor	100	—
Other floors	Same as occupancy served except as indicated	
[9. Dance halls and ballrooms]	[100]	[-]
[10.] 9. Dining rooms and restaurants	100 ^m	—
[11.] 10. Dwellings (see residential)	—	—
[12.] 11. Elevator machine room and control room grating (on area of [4 in.²] 2 inches by 2 inches)	—	300
[13.] 12. Equipment rooms, including pump rooms, generator rooms, transformer vaults, and areas for switch gear, ventilating, air conditioning, and similar electrical and mechanical equipment	75	[-]
[14.] 13. Finish light floor plate construction (on area of [4 in.²] 1 inch by 1 inch)	—	200

OCCUPANCY OR USE	UNIFORM (psf)	CONCENTRATED [(lbs.)] (pounds)
[15.] 14. Fire escapes (exterior) On single- [and multiple] family dwellings only	100 40	—
[16.] 15. Garages (passenger vehicles only) Trucks and buses	40 ^e	Note a
	See Section [1607.6] 1607.7	
[17.] Grandstands (see stadium and arena bleachers)	[-]	[-]
[18.] Gymnasiums, main floors and balconies	[400]	[-]
[19.] 16. Handrails, guards and grab bars		See Section [1607.7] 1607.8
17. Helipads		See Section 1607.6
[20.] 18. Hospitals Corridors above first floor Operating rooms, laboratories Patient Rooms Private rooms Wards Corridors above first floor	80 60 40 [40] [40] [80]	1,000 1,000 1,000 [4,000] [4,000] [4,000]
[21.] 19. Hotels (see residential)	—	—
[22.] 20. Libraries Corridors above first floor Reading rooms Stack rooms Corridors above first floor	80 60 150 ^{b,d} [80]	1,000 1,000 1,000 [4,000]
[23.] 21. Manufacturing Heavy Light Heavy	250 ^e 125 ^a [250]	3,000 2,000 [3,000]
[24.] 22. Marquees, except one- and two-family dwellings	75	—
[25.] 23. Office buildings Corridors above first floor File and computer rooms shall be designed for heavier loads based on anticipated occupancy Lobbies and first-floor corridors Offices Corridors above first floor	80 — 100 50 [80]	2,000 — 2,000 2,000 [2,000]
[26.] 24. Penal institutions Cell blocks Corridors	40 100	—
25. Recreational uses: Bowling alleys, poolrooms and similar uses Dance halls and ballrooms Gymnasiums Ice skating rink Reviewing stands, grandstands and bleachers Roller skating rink Stadiums and arenas with fixed seats (fastened to floor)	75 ^m 100 ^m 100 ^m 250 ^e 100 ^{c,m} 100 ^m 60 ^{c,m}	—
[27.] 26. Residential One- and two-family dwellings Uninhabitable attics without storage ⁱ Uninhabitable attics with storage ^{i,j,k} Habitable attics and sleeping areas ^k Canopies, including marquees All other areas [except balconies and decks] Hotels and multifamily dwellings Private rooms and corridors serving them Public rooms ^m and corridors serving them	10 20 30 20 40 40 100	—
[28.] Reviewing stands, grandstands and bleachers	[Note e]	[-]
[29.] 27. Roofs All roof surfaces subject to maintenance workers Awnings and canopies: Fabric construction supported by a [lightweight rigid] skeleton structure All other construction, except one- and two-family dwellings Ordinary flat, pitched, and curved roofs (that are not occupiable) Primary roof members ^[7] exposed to a work floor Single panel point of lower chord of roof trusses or any point along primary structural members supporting roofs over manufacturing, storage warehouses, and repair garages All other [occupancies] primary roof members Roofs used for other special purposes	5 ^m [Nonreducible] 20 20	300 2,000 300 [Note i]

OCCUPANCY OR USE	UNIFORM (psf)	CONCENTRATED [(lbs.)] (pounds)
[Roofs used for promenade purposes] [Roofs used for roof gardens or assembly purposes] Occupiable roofs: Roof gardens Assembly areas All other similar areas	[Note j] [60] [400] 100 100 ^m Note l	Note l
[30.] 28. Schools Classrooms Corridors above the first floor First-floor corridors	40 80 100	1,000 1,000 1,000
[34.] 29. Scuttles, skylight ribs and accessible ceilings	—	200
[32.] 30. Sidewalks, vehicular driveways and yards, subject to trucking	300 ^{d,m}	8,000 ^{d,e} or 20,000 ^d
[33. Plaza areas (open) accessible to the public (including landscaped portions)]	[400]	[—]
[34. Skating rinks]	[400]	[—]
[35. Stadiums and arenas Bleachers Fixed seats (fastened to floor)]	[400] ^e [60] ^e	[—]
[36.] 31. Stairs and exits One- and two-family dwellings All other	[400] 40 100	[Note e] 300 ^f 300 ^f
[37.] 32. Storage warehouses (shall be designed for heavier loads if required for anticipated storage) Heavy Light [Heavy]	250 ⁿ 125 ⁿ [250]	—
[38.] 33. Stores Retail First floor Upper floors Wholesale, all floors	100 75 125 ⁿ	1,000 1,000 1,000
[39.] 34. Vehicle barriers	See Section [4607.7] 1607.9	
[40.] 35. Walkways and elevated platforms (other than exitways)	60	—
[44.] 36. Yards and terraces, pedestrians	100 ^m	—

[Notes to Table 1607.1]

For SI:

1 inch = 25.4 mm, 1 square inch = 645.16 mm²,

1 square [inch] foot = [645.16 mm²] 0.0929m²,

1 pound per square foot = 0.0479 kN/m²,

1 pound = 0.004448 kN,

1 pound per cubic foot = 16 kg/m³.

- a. Floors in garages or portions of buildings used for the storage of motor vehicles shall be designed for the uniformly distributed live loads of this Table [4607.4] or the following concentrated loads: (1) for garages restricted to passenger vehicles accommodating not more than nine passengers, 3,000 pounds acting on an area of [4.5] 4½ inches by [4.5] 4½ inches; (2) for mechanical parking structures without slab or deck which are used for storing passenger vehicles only, 2,250 pounds per wheel.
- b. The loading applies to stack room floors that support nonmobile, double-faced library [bookstacks] book stacks, subject to the following limitations:
1. The nominal [bookstack] book stack unit height shall not exceed 90 inches;
 2. The nominal shelf depth shall not exceed 12 inches for each face; and
 3. Parallel rows of double-faced [bookstacks] book stacks shall be separated by aisles not less than 36 inches wide.
- c. Design in accordance with [the ICC Standard on Bleachers, Folding and Telescopic Seating and Grandstands] Section 1029.1.
- d. The concentrated wheel load of 20,000 pounds shall be applied as follows: 8,000 pounds on an area of 20 square inches, 20,000 pounds on a 20 inch by 10 inch area.
- e. [The concentrated wheel load shall be applied on an area of 20 square inches.] The concentrated wheel load shall be applied on an area of 4.5 inches by 4.5 inches.
- [f.] [Minimum concentrated load on stair treads (on area of 4 square inches) is 300 pounds.]
- [g-]l. [Where snow loads occur that are in excess of the design conditions, the structure shall be designed to support the loads due to the increased loads caused by drift buildup or a greater snow design determined by the commissioner (see Section 1608). For special purpose roofs, see Section 1607.11.2.2.] The minimum concentrated load on stair treads shall be applied on an area of 2 inches by 2 inches. This load need not be assumed to act concurrently with the uniform load.
- [h-]g. [See Section 1604.8.3 for decks attached to exterior walls.] Where snow loads occur that are in excess of the design conditions, the structure shall be designed to support the loads due to the increased loads caused by drift buildup or a greater snow design determined by the department (see Section 1608).
- [i-]h. [Live loads for assembly spaces other than those described in this table shall be determined from the occupant load requirements as established by Section 1004 of this code using the formula 1,000/(net floor area per occupant) but shall not be less than 50 psf nor more than 100 psf.] See Section 1604.8.3 for decks attached to exterior walls.
- [j-]l. [For establishing live loads for occupancies not specifically listed herein, refer to Referenced Standard ASCE 7 for guidance.] Uninhabitable attics without storage are those where the maximum clear height between the joists and rafters is less than 42 inches, or where there are not two or more adjacent trusses with web configurations capable of accommodating an assumed rectangle 42 inches in height by 24 inches in width, or greater, within the plane of the trusses. This live load need not be assumed to act concurrently with any other live load requirements.
- i. [Roofs used for other special purposes shall be designed for appropriate loads as approved by the commissioner.] Uninhabitable attics with storage are those where the maximum clear height between the joists and rafters is 42 inches or greater, or where there are two or more adjacent trusses with web configurations capable of accommodating an assumed rectangle 42 inches in height by 24 inches in width, or greater, within the plane of the trusses.

The live load need only be applied to those portions of the joists of truss bottom chords where both of the following conditions are met:

- i. The attic area is accessible from an opening not less than 20 inches in width by 30 inches in length that is located where the clear height in the attic is a minimum of 30 inches; and
- ii. The slopes of the joists or truss bottom chords are no greater than two units vertical in 12 units horizontal.

The remaining portions of the joists or truss bottom chords shall be designed for a uniformly distributed concurrent live load of not less than 10 pounds per square foot.

- k. Attic spaces served by stairways other than the pull-down type shall be designed to support the minimum live load specified for habitable attics and sleeping rooms.
- l. Areas of occupiable roofs, other than roof gardens and assembly areas, shall be designed for appropriate loads as approved by the department. Unoccupied landscaped areas of roofs shall be designed in accordance with Section 1607.13.3.
- m. Live load reduction is not permitted.
- n. Live Load reduction is only permitted in accordance with Section 1607.11.1.2 or Item 1 of Section 1607.11.2.
- o. Live Load reduction is only permitted in accordance with Section 1607.11.1.3 or Item 2 of Section 1607.11.2.

1607.2 Loads not specified. For occupancies or uses not designated in Table 1607.1, the live load shall be determined in accordance with a method approved by the commissioner.

1607.2.1 Stage areas using scenery or scenic elements. Scenery battens and suspension systems shall be designed for a load of 30 pounds per linear foot (437.7 N/m) of batten length. Loft block and head block beams shall be designed to support vertical and horizontal loads corresponding to a 4-inch (~~1402~~ 101.6 mm) spacing of battens for the entire depth of the gridiron. Direction and magnitude of total forces shall be determined from the geometry of the rigging system including load concentrations from spot line rigging. Locking rails shall be designed for a uniform uplift of 500 psf (3447 kN/m²) with a 1,000 pound (454 kg) concentration. Impact factor for batten design shall be 75 percent and for loft and head block beams shall be 25 percent. A plan drawn to a scale not less than ¼ inch (6.4 mm) equals 1 foot (~~305~~ 304.8 mm) shall be displayed in the stage area indicating the framing plan of the rigging loft and the design loads for all members used to support scenery or rigging. Gridirons over stages shall be designed to support a uniformly distributed live load of 50 psf (2.40 kN/m²) in addition to the rigging loads indicated.

1607.3 Uniform live loads. The live loads used in the design of buildings and other structures shall be the maximum loads expected by the intended use or occupancy but shall in no case be less than the minimum uniformly distributed ~~[unit]~~ live loads ~~[required by]~~ given in Table 1607.1.

1607.4 Concentrated live loads. Floors, roofs and other similar surfaces shall be designed to support the uniformly distributed live loads prescribed in Section 1607.3 or the concentrated ~~[load, in pounds (kilonewtons),]~~ live loads, given in Table 1607.1, whichever produces the greater load effects. Unless otherwise specified, the indicated concentration shall be assumed to be uniformly distributed over an area ~~[2.5]~~ of 2½ feet by ~~[2.5]~~ 2½ feet (~~[762 mm × 762 mm]~~ 762 mm by 762 mm) and shall be located so as to produce the maximum load effects in the structural members.

1607.5 Partition loads. In office buildings and in other buildings where partition locations are subject to change, provisions for partition weight shall be made, whether or not partitions are shown on the construction documents, unless the specified live load is 80 psf (3.83 kN/m²) or greater. Weights of all partitions shall be considered, using either actual weights at locations shown on the plans or the equivalent uniform load given in Section 1607.5.2. Partition loads shall be taken as superimposed dead loads.

1607.5.1 Actual loads. Where actual partition weights are used, the uniform design live load may be omitted from the strip of floor area under each partition.

1607.5.2 Equivalent uniform load. The equivalent uniform partition loads in Table 1607.5 may be used in lieu of actual partition weights except for bearing partitions or partitions in toilet room

areas (other than in one- and two-family dwellings), at stairs and elevators, and similar areas where partitions are concentrated. In such cases, actual partition weights shall be used in design. ~~[Except as otherwise exempted, equivalent uniform partition loads shall be used in areas where partitions are not definitely located on the plans, or in areas where partitions are subject to rearrangement or relocation.]~~

**TABLE 1607.5
EQUIVALENT UNIFORM PARTITION LOADS**

PARTITION WEIGHT (plf)	EQUIVALENT UNIFORM LOAD (psf) (to be added to floor dead and live loads)
50 or less	0
51 to 100	6
101 to 200	12
201 to 350	20
Greater than 350	20 plus a concentrated live load of the weight in excess of 350 plf.

For SI: 1 pound per linear foot = 0.01459 kN/m², 1 pound per square foot = 0.0479 kN/m².

[1607.6 Garages.]

~~**[1607.6.1 Passenger vehicle garages.** Areas used for, and restricted by physical limitations of clearance to, the transit or parking of passenger vehicles shall be designed for the uniformly distributed and concentrated loads for parking areas for such vehicles as provided in Table 1607.1 applied without impact. An exception is made for members or constructions which, because of physical limitations, cannot be subjected to direct load from the vehicle or from a jack or hoist used to raise or suspend the vehicle. Such members or constructions shall be designed for the loads corresponding to the actual usage.]~~

**[TABLE 1607.6
UNIFORM AND CONCENTRATED LOADS**

LOADING CLASS ^a	UNIFORM LOAD (pounds/linear foot of lane)	CONCENTRATED LOAD (pounds) ^b	
		For moment design	For shear design
H20-44 and HS20-44	640	18,000	26,000
H15-44 and HS15-44	480	13,500	19,500

For SI: 1 pound per linear foot = 0.01459 kN/m, 1 pound = 0.004448 kN, 1 ton = 8.90kN.

a. An H loading class designates a two-axle truck with a semitrailer. An HS loading class designates a tractor truck with a semitrailer. The numbers following the letter classification indicate the gross weight in tons of the standard truck and the year the loadings were instituted.

b. See Section 1607.6.1 for the loading of multiple spans.

~~**[1607.6.2 Truck and bus garages.** Minimum live loads for garages having trucks or buses shall be as specified in Table 1607.6, but shall not be less than 50 psf (2.40 kN/m²), unless other loads are specifically justified and approved by the commissioner. Actual loads shall be used where they are greater than the loads specified in the table.]~~

~~**[1607.6.2.1 Truck and bus garage live load application.** The concentrated load and uniform load shall be uniformly distributed over a 10-foot (3048 mm) width on a line normal to the centerline of the lane placed within a 12-foot wide (3658 mm) lane. The loads shall be placed within their individual lanes so as to produce the maximum stress in each structural member.~~

~~Vertical impact shall be taken as 10 percent of the vertical load. Single spans shall be designed for the uniform load in Table 1607.6 and one simultaneous concentrated load positioned to produce the maximum effect. Multiple spans shall be designed for the uniform load in Table 1607.6 on the spans and two simultaneous concentrated loads in two spans positioned to produce the maximum negative moment effect. Multiple span design loads, for other effects, shall be the same as for single spans.]~~

1607.6 Helipads. Helipads shall be designed for the following live loads:

1. A uniform live load, L, as specified in Items 1.1 and 1.2. This load shall not be reduced.
 - 1.1. 40 psf (1.92 kN/m²) where the design basis helicopter has a maximum take-off weight of 3,000 pounds (13.35 kN) or less.
 - 1.2. 60 psf (2.87 kN/m²) where the design basis helicopter has a maximum take-off weight greater than 3,000 pounds (13.35 kN).
2. A single concentrated live load, L, of 3,000 pounds (13.35 kN) applied over an area of 4.5 inches by 4.5 inches (114.3 mm by 114.3 mm) and located so as to produce the maximum load effects on the structural elements under consideration. The concentrated load is not required to act concurrently with other uniform or concentrated live loads.
3. Two single concentrated live loads, L, 8 feet (2438.4 mm) apart applied on the landing pad (representing the helicopter's two main landing gear, whether skid type or wheeled type), each having a magnitude of 0.75 times the maximum take-off weight of the helicopter, and located so as to produce the maximum load effects on the structural elements under consideration. The concentrated loads shall be applied over an area of 8 inches by 8 inches (203.2 mm by 203.2 mm) and are not required to act concurrently with other uniform or concentrated live loads.

Landing areas designed for a design basis helicopter with maximum take-off weight of 3,000-pounds (13.35 kN) shall be identified with a 3,000 pound (13.34 kN) weight limitation. The landing area weight limitation shall be indicated by the numeral "3" (kips) located in the bottom right corner of the landing area as viewed from the primary approach path. The indication for the landing area weight limitation shall be a minimum 5 feet (1524 mm) in height.

1607.7 Heavy Vehicle loads. Floors and other surfaces that are intended to support vehicle loads greater than a 10,000-pound (4535.9 kg) gross vehicle weight rating shall comply with Sections 1607.7.1 through 1607.7.5.

1607.7.1 Loads. Where any structure does not restrict access for vehicles that exceed a 10,000-pound (4535.9 kg) gross vehicle weight rating, those portions of the structure subject to such loads shall be designed using the vehicular live loads, including consideration of impact and fatigue, in accordance with the NYSDOT Bridge Manual and the NYSDOT LRFD Bridge Design Specifications.

Alternatively, it shall be acceptable to utilize the design live loads for sidewalks as shown in Table 1607.1.

1607.7.2 Fire truck and emergency vehicles. Where a structure or portions of a structure are designated as fire access roads as defined in Chapter 5 of the *New York City Fire Code*, the structure shall be designed for the live loading specified in Section 1607.7.1 of this code or those identified in Chapter 5 of the *New York City Fire Code*, whichever produces the greater load effects.

1607.7.3 Heavy vehicle garages. Garages designed to accommodate vehicles that exceed a 10,000-pound (4535.9 kg) gross vehicle weight rating, shall be designed using the live loading specified by Section 1607.7.1. Vertical impact shall be taken as 10 percent of the vertical load.

Exception: The vehicular live loads and load placement are allowed to be determined using the actual vehicle weights for the vehicles allowed onto the garage floors, provided such loads and placement are based on rational engineering principles and are approved by the department, but shall not be less than 50 psf (2.9 kN/m²). This live load shall not be reduced.

1607.7.4 Forklifts and movable equipment. Where a structure is intended to have forklifts or other movable equipment present, the structure shall be designed for the total vehicle or equipment load and the individual wheel loads for the anticipated vehicles as specified by the owner of the facility. These loads shall be posted in accordance with Section 1607.7.5.

1607.7.4.1 Impact and fatigue. Impact loads and fatigue loading shall be considered in the design of the supporting structure. For the purposes of design, the vehicle and wheel loads shall be increased by 30 percent to account for impact.

1607.7.5 Posting. The maximum weight of vehicles allowed into or on a garage or other structure shall be posted by the owner or the owner's authorized agent in accordance with Article 118 of Chapter 1 of Title 28 of the *Administrative Code*.

[1607.7] 1607.8 Loads on handrails, guards, grab bars, and seats [and vehicle barrier systems]. Handrails[;] and guards[;] shall be designed and constructed for the structural loading conditions set forth in Section 1607.8.1. [grab] Grab bars, [accessible seats,] shower seats and accessible benches [and vehicle barrier systems] shall be designed and constructed [to] for the structural loading conditions set forth in [this section] Section 1607.8.2.

[1607.7.1] 1607.8.1 [Handrail assemblies] Handrails and guards. [Handrail assemblies] Handrails and guards shall be designed to resist a linear load of 50 [plf] pounds per linear foot (plf) (0.73 kN/m) [applied in any direction at the top and to transfer this load through the supports to the structure] in accordance with Section 4.5.1.1 of ASCE 7. Glass handrail assemblies and guards shall also comply with Section 2407.

Exceptions:

1. For one- and two-family dwellings, only the single~~[,]~~ concentrated load required by Section ~~[1607.7.1.1]~~ 1607.8.1.1 shall be applied.
2. In Group I-3, F, H~~[,]~~ and S occupancies, for areas that are not accessible to the general public and that have an occupant load no greater than 50, the minimum load shall be 20 pounds per foot (0.29 kN/m).

~~[1607.7.1.1]~~ **1607.8.1.1 Concentrated load.** ~~[Handrail]~~ Handrails and guards shall be ~~[able]~~ designed to resist a ~~[single]~~ concentrated load of 200 pounds (0.89 kN) ~~[, applied in any direction at any point, and have attachment devices and supporting structure to transfer this loading to appropriate structural elements of the building. This load need not be assumed to act concurrently with the loads specified in the preceding paragraph]~~ in accordance with Section 4.5.1.1 of ASCE 7.

~~[1607.7.1.2]~~ **1607.8.1.2 [Components] Intermediate rails.** Intermediate rails (all those except the handrail), balusters and panel fillers shall be designed to ~~[withstand a horizontally applied normal]~~ resist a concentrated load of 50 pounds (0.22 kN) ~~[on an area equal to 1 square foot (0.093 m²), including openings and space between rails]~~ in accordance with Section 4.5.1.1 of ASCE 7, a vertically downward load of 50 pounds per foot (0.73 kN/m), and a concentrated upward load of 50 pounds (0.22 kN) applied at the most critical location. Reactions due to this loading are not required to be applied simultaneously with one another, and are not required to be superimposed with those of Section ~~[1607.7.1]~~ 1607.8.1 or ~~[1607.7.1.1]~~ 1607.8.1.1. The railings, balusters and components shall be designed separately for the effect of wind when the total wind load on the panel or component exceeds 50 pounds (0.22 kN). The wind load need not be combined with any other live load.

~~[1607.7.2]~~ **1607.8.2 Grab bars, shower seats and dressing room bench seats.** Grab bars, shower seats and dressing room bench ~~[seat systems]~~ seats shall be designed to resist a single concentrated load of 250 pounds (1.11 kN) applied in any direction at any point on the grab bar or seat so as to produce the maximum load effects.

~~[1607.7.3]~~ **1607.9 Vehicle [barrier systems] barriers.** Vehicle ~~[barrier systems]~~ barriers for passenger vehicles shall be designed to resist a ~~[single]~~ concentrated load of 6,000 pounds (26.70 kN) ~~[applied horizontally in any direction to the barrier system and shall have anchorage or attachment capable of transmitting this load to the structure. For design of the system, two loading conditions shall be analyzed. The first condition shall apply the load at a height of 1 foot, 6 inches (457 mm) above the floor or ramp surface]~~ in accordance with Section 4.5.3 of ASCE 7.

~~[The second loading condition shall apply the load at 2 feet, 3 inches (686 mm) above the floor or ramp surface. The more severe load condition shall govern the design of the barrier restraint system. The load shall be assumed to act on an area not to exceed 1 square foot (0.0929 m²), and is not required to be assumed to act concurrently with any handrail or guard loadings specified in Section 1607.7.1.]~~ Garages accommodating trucks and buses shall be designed in accordance with ~~[a recognized]~~ an approved method ~~[acceptable to the commissioner]~~ that contains ~~[provision]~~ provisions for traffic railings.

~~[1607.7.3.1]~~ **1607.9.1 Columns in parking areas.** Unless specially protected, columns in parking areas subject to impact of moving vehicles shall be designed to resist the lateral load due

to impact ~~[and this load shall be considered a variable load]~~. For passenger vehicles, this lateral load shall be taken as a minimum service live load of 6,000 pounds (26.70 kN) applied at least 1 foot 6 inches (~~[457]~~ 457.2 mm)~~;~~ above the roadway, and acting simultaneously with other design loads. In addition, columns in parking areas shall meet the requirements of Section ~~[1615]~~ 1616 for structural integrity. Vehicle barrier systems in garages accommodating trucks and buses shall be designed in accordance with NYSDOT Bridge Manual and the NYSDOT LRFD Bridge Design Specifications.

[1607.8] 1607.10 Impact loads. The live loads specified in ~~[Section]~~ Sections 1607.3 through 1607.9 shall be assumed to include adequate allowance for impact conditions. Provisions shall be made in the structural design for uses and loads that involve unusual vibration and impact forces.

[1607.8.1] 1607.10.1 Elevators. Elevator Members, elements and components subject to dynamic loads ~~[shall be increased by 100 percent for impact and the structural supports]~~ from elevators shall be designed ~~[within the limits of stress]~~ for impact loads and deflection limits prescribed by ASME A17.1, as modified by Appendix K of this code.

[1607.8.2] 1607.10.2 Machinery. For the purpose of design, the weight of machinery and moving loads shall be increased as follows to allow for impact: ~~(1)~~ ~~i~~ ~~[elevator machinery, 100 percent;~~ ~~(2)]~~ light machinery, shaft- or motor-driven, 20 percent; ~~(3)]~~ and ~~(ii)~~ reciprocating machinery or power-driven units, 50 ~~[percent;~~ ~~(4)]~~ hangers for floors or balconies, 33 percent. Percentages shall be increased where specified by the manufacturer.

1607.10.3 Elements supporting building maintenance equipment. In addition to any other applicable live loads, structural elements that support hoists for façade access and building maintenance equipment shall be designed for a live load of 2.5 times the rated load of the hoist or the stall load of the hoist, whichever is greater.

Equipment installed temporarily to facilitate construction, demolition, alteration, or inspection shall be subject to the requirements of Chapter 33.

1607.10.4 Fall arrest and lifeline anchorages. In addition to any other applicable live loads, lifeline anchorages and structural elements that support lifeline anchorages shall be designed for a live load of at least 3,100 pounds (13.8 kN) for each attached lifeline, in every direction that a fall arrest load may be applied.

[1607.8.3] 1607.10.5 Railroad equipment. Minimum loads (including vertical, lateral, longitudinal, and impact) and the distribution thereof shall meet the applicable requirements of Chapter 15 of the AREMA Manual for Railway Engineering.

[1607.8.4] 1607.10.6 Assembly structures. Seating areas in grandstands, stadiums, and similar assembly structures shall be designed to resist the simultaneous application of a horizontal swaying load of at least 24 plf (36 kg/m) of seats applied in a direction parallel to the row of the seats, and of at least 10 plf (15 kg/m) of seats in a direction perpendicular to the row of the seats. When this load is used in combination with wind for outdoor structures, the wind load shall be one-half of the design wind load.

[1607.9] 1607.11 Reduction in uniform live loads. Except for uniform live loads at roofs, all other minimum uniformly distributed live loads, L_o , in Table 1607.1 are permitted to be reduced in accordance with Section [1607.9.1] 1607.11.1 or [1607.9.2] 1607.11.2. ~~[Roof uniform]~~ Uniform live loads ~~[-, other than special purpose roofs of Section 1607.11.2.2,]~~ at roofs are permitted to be reduced in accordance with Section [1607.11.2] 1607.13.2. ~~[Roof uniform live loads of special purpose roofs are permitted to be reduced in accordance with Section 1607.9.1 or 1607.9.2.]~~

[1607.9.1] 1607.11.1 [General] Basic uniform live load reduction. Subject to the limitations of Sections [1607.9.1.1] 1607.11.1.1 through [1607.9.1.4] 1607.11.1.4 and Table 1607.1, members for which a value of $K_{LL}A_T$ is 400 square feet (37.16 m²) or more are permitted to be designed for a reduced uniformly distributed live load, L , in accordance with the following equation:

$$L = L_o \left(0.25 + \frac{15}{\sqrt{K_{LL}A_T}} \right) \quad \text{[~~(Equation 16-29)~~] (Equation 16-30)}$$

For SI: $L = L_o \left(0.25 + \frac{4.57}{\sqrt{K_{LL}A_T}} \right)$

where:

- L = Reduced design live load per square foot [~~(square meter)~~] (m²) of area supported by the member.
- L_o = Unreduced design live load per square foot [~~(square meter)~~] (m²) of area supported by the member (see Table 1607.1).
- K_{LL} = Live load element factor (see Table [1607.9.1] 1607.11.1).
- A_T = Tributary area, in square feet [~~(square meter)~~] (m²).

L shall not be less than $0.50L_o$ for members supporting one floor and L shall not be less than $0.40L_o$ for members supporting two or more floors.

**TABLE [1607.9.1] 1607.11.1
LIVE LOAD ELEMENT FACTOR, K_{LL}**

ELEMENT	K_{LL}
Interior columns	4
Exterior columns without cantilever slabs	4
Edge columns with cantilever slabs	3
Corner columns with cantilever slabs	2
Edge beams without cantilever slabs	2
Interior beams	2
All other members not identified above including: Edge beams with cantilever slabs Cantilever beams One-way slabs Two-way slabs Members without provisions for continuous shear transfer normal to their span	1

[1607.9.1.1] 1607.11.1.1 One-way slabs. The tributary area, A_T , for use in Equation [16-22] 16-23 for one-way slabs shall not exceed an area defined by the slab span times a width normal

to the span of 1.5 times the slab span.

~~[1607.9.1.2]~~ **1607.11.1.2 Heavy live loads.** Live loads that exceed 100 psf (4.79 kN/m²) shall not be reduced.

Exceptions:

1. The live loads for members supporting two or more floors are permitted to be reduced by a maximum of 20 percent, but the live load shall be not ~~[be]~~ less than L as calculated in Section ~~[1607.9.1]~~ 1607.11.1.
2. For uses other than storage, where approved, additional live load reductions shall be permitted where shown by the registered design professional that a rational approach has been used and that such reductions are warranted.

~~[1607.9.1.3]~~ **1607.11.1.3 Passenger vehicle garages.** The live loads shall not be reduced in passenger vehicle garages.

Exception: ~~[the]~~ The live loads for members supporting two or more floors are permitted to be reduced by a maximum of 20 percent, but the live load shall not be less than L as calculated in Section ~~[1607.9.1]~~ 1607.11.1.

~~[1607.9.1.4]~~ **Special occupancies.** Live loads of 100 psf (4.79 kN/m²) or less ~~at areas where fixed seats are located shall not be reduced in public assembly occupancies or in areas used for retail or wholesale sales.~~

~~[1607.9.1.5]~~ **1607.11.1.4 ~~[Special structural elements]~~ Flat Slab and Flat Plate Construction.** ~~[Live loads shall not be reduced for one-way slabs except as permitted in Section 1607.9.1.1.]~~ Live loads shall not be reduced for calculating shear stresses at the heads of columns in flat slab or flat plate construction.

~~[1607.9.1.6]~~ **Roof members.** Live loads of 100 psf (4.79 kN/m²) or less ~~shall not be reduced for roof members except as specified in Section 1607.11.2.]~~

~~[1607.9.2]~~ **1607.11.2 ~~[Alternate floor]~~ Alternative uniform live load reduction.** As an alternative to Section ~~[1607.9.1]~~ 1607.11.1 ~~[, floor]~~ and subject to the limitations of Table 1607.1, uniformly distributed live loads are permitted to be reduced in accordance with the following provisions. Such reductions shall apply to slab systems, beams, girders, columns, piers, walls and foundations.

~~[1. A reduction shall not be permitted in Group A occupancies.]~~

~~[2.]~~ 1. A reduction shall not be permitted where the live load exceeds 100 psf (4.79 kN/m²) except that the design live load for members supporting two or more floors is permitted to be reduced by a maximum of 20 percent.

Exception: For uses other than storage, where approved, additional live load reductions shall be permitted where shown by the registered design professional that a rational approach has been used and that such reductions are warranted.

~~[3.]~~ 2. A reduction shall not be permitted in passenger vehicle parking garages except that the live loads for members supporting two or more floors are permitted to be reduced by a maximum of 20 percent.

~~[4.]~~ 3. For live loads not exceeding 100 psf (4.79 kN/m²), the design live load for any structural member supporting 150 square feet (13.94 m²) or more is permitted to be reduced in accordance with Equation ~~[16-27]~~ 16-31.

~~[5.]~~ 4. For one-way slabs, the area, A, for use in Equation ~~[16-27]~~ 16-31 shall not exceed the product of the slab span and a width normal to the span of 0.5 times the slab span.

$$R = 0.08 (A - 150) \quad [(\text{Equation 16-30})] \text{ (Equation 16-31)}$$

For SI: $R = 0.861(A - 13.94)$

Such reduction shall not exceed the smallest of:

1. 40 percent for ~~[horizontal members]~~ members supporting one floor;
2. 60 percent for ~~[vertical members]~~ members supporting two or more floors; or
3. R as determined by the following equation~~[-]~~:

$$R = 23.1 (1 + D/L_o) \quad [(\text{Equation 16-31})] \text{ (Equation 16-32)}$$

where:

- A = Area of floor or roof supported by the member, square feet (m²).
- D = Dead load per square foot (m²) of area supported.
- L_o = Unreduced live load per square foot (m²) of area supported.
- R = Reduction in percent.

~~[1607.10]~~ **1607.12 Distribution of floor loads.** Where uniform floor live loads are involved in the design of structural members arranged so as to create continuity, the minimum applied loads shall be the full dead loads on all spans in combination with the floor live loads on spans selected to produce the greatest load effect at each location under consideration. ~~[It shall be]~~ Floor live loads are permitted to ~~[reduce floor live loads]~~ be reduced in accordance with Section ~~[1607.9]~~ 1607.11.

~~[1607.11]~~ **1607.13 Roof loads.** The structural supports of roofs and marquees shall be designed to resist wind and, where applicable, snow and earthquake loads, in addition to the dead load of construction and the appropriate live loads as prescribed in this section, or as set forth in Table 1607.1. The live loads acting on a sloping surface shall be assumed to act vertically on the horizontal projection of that surface.

~~[1607.11.1]~~ **1607.13.1 Distribution of roof loads.** Where uniform roof live loads are reduced to less than 20 psf (0.96 kN/m²) in accordance with Section ~~[1607.11.2.1]~~ 1607.13.2.1 and are applied to the design of structural members arranged so as to create continuity, the reduced roof live ~~[loads]~~ load shall be applied to adjacent spans or to alternate spans, whichever produces the most unfavorable load effect. See Section ~~[1607.11.2]~~ 1607.13.2 for reductions in minimum roof live loads and Section 7.5 of ASCE 7 for partial snow loading.

[1607.11.1.1] 1607.13.1.1 Arches and gabled frames. The following simplification is permissible:

1. Live load placed on one-half of the span adjacent to one support.
2. Live load placed on the center one-fourth of the span.
3. Live load placed on $\frac{3}{8}$ of the span adjacent to each support.

[1607.11.2 Reduction in roof live loads] 1607.13.2 General. The minimum uniformly distributed live loads of roofs and marquees, L_o , in Table 1607.1 are permitted to be reduced in accordance with Section ~~[1607.11.2.1 or 1607.11.2.2]~~ 1607.13.2.1.

[1607.11.2.1] 1607.13.2.1 [Flat, pitched and curved] Ordinary roofs, awnings and canopies. Ordinary flat, pitched and curved roofs, and awnings and canopies other than of fabric construction supported by ~~[light weight rigid]~~ a skeleton ~~[structures]~~ structure, are permitted to be designed for a reduced uniformly distributed roof live load, L_r , as specified in the following equations or other controlling combinations of loads as specified in Section 1605, whichever produces the greater load effect.

In structures such as greenhouses, where special scaffolding is used as a work surface for workers and materials during maintenance and repair operations, a lower roof load than specified in the following equations shall not be used unless approved by the commissioner. ~~[Greenhouses]~~ Such structures shall be designed for a minimum roof live load of 12 psf (0.58 kN/m²).

$$L_r = L_o R_1 R_2 \quad \text{[~~(Equation 16-32)~~] (Equation 16-33)}$$

where:

$$12 \leq L_r \leq 20$$

$$\text{For SI: } L_r = L_o R_1 R_2$$

where:

$$0.58 \leq L_r \leq .96$$

$L_o =$ Unreduced roof live load per square foot (m²) of horizontal projection supported by the member (see Table 1607.1).

$L_r =$ Reduced live load per square foot (m²) of horizontal projection [in pounds per square foot (kN/m²)] supported by the member.

The reduction factors R_1 and R_2 shall be determined as follows:

$$R_1 = 1 \text{ for } A_t \leq 200 \text{ square feet (18.58 m}^2\text{)} \quad \text{[~~(Equation 16-33)~~] (Equation 16-34)}$$

$$R_1 = 1.2 - 0.001A_t \text{ for } 200 \text{ square feet} < A_t < 600 \text{ square feet} \text{ [(Equation 16-34)]}$$

(Equation 16-35)

For SI: $1.2 - 0.011A_t$ for 18.58 square meters $< A_t < 55.74$ square meters

$$R_1 = 0.6 \text{ for } A_t \geq 600 \text{ square feet (55.74m}^2\text{)} \quad \text{[(Equation 16-35)] **(Equation 16-36)**}$$

where:

A_t = Tributary area (span length multiplied by effective width) in square feet (m^2) supported by any structural member, and

~~F = for a sloped roof, the number of inches of rise per foot (for SI: $F = 0.12 \times \text{slope}$, with slope expressed percentage or for an arch or dome, the rise to span ratio multiplied by 32.)~~

$$R_2 = 1 \text{ for } F \leq 4 \quad \text{[(Equation 16-36)] **(Equation 16-37)**}$$

$$R_2 = 1.2 - 0.05F \text{ for } 4 < F < 12 \quad \text{[(Equation 16-37)] **(Equation 16-38)**}$$

$$R_2 = 0.6 \text{ for } F \geq 12 \quad \text{[(Equation 16-38)] **(Equation 16-39)**}$$

where:

F = For a sloped roof, the number of inches of rise per foot (for SI: $F = 0.12 \times \text{slope}$, with slope expressed as a percentage), or for an arch or dome, the rise-to-span ratio multiplied by 32.

~~**[1607.11.2.2] 1607.13.3 [Special-purpose] Occupiable roofs.** [Roofs] Areas of roofs that are occupiable, such as vegetative roofs, roof gardens[, marquees, and roofs used for used] or for [promenade,] assembly or other [special] similar purposes [shall be designed for a minimum live load, L_o , as specified in Table 1607.1. Such live loads], and marquees are permitted to [be] have their uniformly distributed live loads reduced in accordance with Section [1607.9] 1607.11. [Live loads of 100 psf (4.79 kN/m²) or more at areas or roofs classified as Group A occupancies shall not be reduced.]~~

~~**[1607.11.3 Green roofs.** Where roofs utilize a green roof system and are not intended for human occupancy, the uniform design live load in the area covered by the green roof shall be 20 psf (0.958 kN/m²). The weight of the landscaping materials shall be considered as dead load and shall be computed on the basis of saturation of the soil. Where roofs utilize a green roof system and are used for human occupancy, the minimum live load shall be as specified in Table 1607.1 or Section 1607.11.2.2, whichever is greater.]~~

1607.13.3.1 Vegetative and landscaped roofs. The weight of all landscaping materials shall be considered as dead load and shall be computed on the basis of saturation of the soil as determined in accordance with Section 3.1.4, of ASCE 7. The uniform design live load in unoccupied landscaped areas on roofs shall be 20 psf (0.958 kN/m²). The uniform design live

load for occupied landscaped areas on roofs shall be determined in accordance with Table 1607.1 of this code.

[1607.11.4] 1607.13.4 Awnings, [s] canopies, and sun control devices. Awnings, canopies, and sun control devices shall be designed for uniform live loads as required in Table 1607.1 as well as for snow loads and wind loads as specified in Sections 1608 and 1609.

~~**[1607.11.5 Hanging loads.** Girders and roof trusses (other than joists) over garage areas regularly utilized for the repair of vehicles and over manufacturing floors or storage floors used for commercial purposes shall be capable of supporting, in addition to the specified live and wind loads, a concentrated live load of 2,000 pounds (908 kg) applied at any lower chord panel point for trusses, and at any point of the lower flange for girders.]~~

1607.13.5 Photovoltaic panel systems. Roof structures that provide support for photovoltaic panel systems shall be designed in accordance with Sections 1607.13.5.1 through 1607.13.5.4, as applicable.

1607.13.5.1 Roof live load. Roof structures that support photovoltaic panel systems shall be designed to resist each of the following conditions:

1. Applicable uniform and concentrated roof loads with the photovoltaic panel system dead loads.

Exception: Roof live loads need not be applied to the area covered by photovoltaic panels where the clear space between the panels and the roof surface is 24 inches (609.6 mm) or less.

2. Applicable uniform and concentrated roof loads without the photovoltaic panel system present.

1607.13.5.2 Photovoltaic panels or modules. The structure of a roof that supports solar photovoltaic panels or modules shall be designed to accommodate the full solar photovoltaic panels or modules and ballast dead load, including concentrated loads from support frames in combination with the loads from Section 1607.13.5.1 and other applicable loads. Where applicable, snow drift loads created by the photovoltaic panels or modules shall be included.

1607.13.5.3 Photovoltaic panels or modules installed as an independent structure. Solar photovoltaic panels or modules that are independent structures and do not have accessible/occupied space underneath are not required to accommodate a roof photovoltaic live load, provided the area under the structure is restricted to keep the public away. All other loads and combinations in accordance with Section 1605 shall be accommodated.

Solar photovoltaic panels or modules that are designed to be the roof, span to structural supports, and have accessible/occupied space underneath shall have the panels or modules and all supporting structures designed to support a roof photovoltaic live load, as defined in Section 1607.13.5.1 in combination with other applicable loads. Solar photovoltaic panels or modules in this application are not permitted to be classified as “not accessible” in accordance with Section 1607.13.5.1.

1607.13.5.4 Ballasted photovoltaic panel systems. Roof structures that provide support for ballasted photovoltaic panel systems shall be designed, or analyzed, in accordance with Section 1604.4; checked in accordance with Section 1604.3.6 for deflections; and checked in accordance with Section 1611 for ponding.

1607.13.6 Hanging loads. Girders and roof trusses (other than joists) over garage areas regularly utilized for the repair of vehicles and over manufacturing floors or storage floors used for commercial purposes shall be capable of supporting, in addition to the specified live and wind loads, a concentrated live load of 2,000 pounds (907.2 kg) applied at any lower chord panel point for trusses, and at any point of the lower flange for girders.

[1607.12] 1607.14 Crane loads. The crane live load shall be the rated capacity of the crane. Design loads for the runway beams, including connections and support brackets, of moving bridge cranes and monorail cranes shall include the maximum wheel loads of the crane and the vertical impact, lateral and longitudinal forces induced by the moving crane.

[1607.12.1] 1607.14.1 Maximum wheel load. The maximum wheel loads shall be the wheel loads produced by the weight of the bridge, as applicable, plus the sum of the rated capacity and the weight of the trolley with the trolley positioned on its runway at the location where the resulting load effect is maximum.

[1607.12.2] 1607.14.2 Vertical impact force. The maximum wheel loads of the crane shall be increased by the percentages shown below to determine the induced vertical impact or vibration force:

Monorail cranes (powered)	25 percent
Cab-operated or remotely operated bridge cranes (powered)	25 percent
Pendant-operated bridge cranes (powered)	10 percent
Bridge cranes or monorail cranes with hand-gearred bridge, trolley and hoist	0 percent

[1607.12.3] 1607.14.3 Lateral force. The lateral force on crane runway beams with electrically powered trolleys shall be calculated as 20 percent of the sum of the rated capacity of the crane and the weight of the hoist and trolley. The lateral force shall be assumed to act horizontally at the traction surface of a runway beam, in either direction perpendicular to the beam, and shall be distributed according to the lateral stiffness of the runway beam and supporting structure.

[1607.12.4] 1607.14.4 Longitudinal force. The longitudinal force on crane runway beams, except for bridge cranes with hand-gearred bridges, shall be calculated as 10 percent of the maximum wheel loads of the crane. The longitudinal force shall be assumed to act horizontally at the traction surface of a runway beam, in either direction parallel to the beam.

[1607.13] 1607.15 Interior walls and partitions. Interior walls and partitions that exceed 6 feet (~~1829~~ 1828.8 mm) in height, including their finish materials, shall have adequate strength and

stiffness to resist the loads to which they are subjected but not less than a horizontal load of 5 psf (0.240 kN/m²).

~~[Exception: Fabric partitions complying with Section 1607.13.1 shall not be required to resist the minimum horizontal load of 5 psf (0.24 kN/m²).]~~

~~[1607.13.1]~~ **1607.15.1 Fabric partitions.** Fabric partitions that exceed 6 feet ([1829] 1828.8 mm) in height, including their finish materials, shall have adequate strength and stiffness to resist the following load conditions:

1. ~~[A]~~ The horizontal distributed load [~~of 5 psf (0.24 kN/m²)~~] need only be applied to the partition framing. The total area used to determine the distributed load shall be the area of the fabric face between the framing members to which the fabric is attached. The total distributed load shall be uniformly applied to such framing members in proportion to the length of each member.
2. A concentrated load of 40 pounds (0.176 kN) applied to an 8-inch diameter ([203] 203.2 mm) area of the fabric face at a height of 54 inches ([1372] 1371.6 mm) above the floor.

1607.15.2 Fire Walls. In order to meet the structural stability requirements of Section 706.2 where the structure on either side of the wall has collapsed, fire walls and their supports shall be designed to withstand a minimum horizontal allowable stress load of 5 psf (0.240 kN/m²).

SECTION BC 1608 SNOW LOADS

1608.1 General. Design snow loads shall be determined in accordance with Chapter 7 of ASCE 7, but the design roof load shall not be less than that determined by Section 1607.

1608.2 Ground snow loads. The ground snow [~~load, P_g~~] loads to be used in determining the design snow loads for roofs is 25 psf (1.2 kN/m²).

~~[1608.3 Flat roof snow loads. The flat roof snow load, ρ_f, on a roof with a slope equal to or less than 5 degrees (0.09 rad) (1 inch per foot = 4.76 degrees) shall be calculated in accordance with Section 7.3 of ASCE 7.]~~

~~[1608.3.1 Exposure factor. The value for the snow exposure factor, C_e, used in the calculation of ρ_f shall be determined from Table 1608.3.1.]~~

~~[TABLE 1608.3.1
SNOW EXPOSURE FACTOR, C_E~~

TERRAIN CATEGORY*	EXPOSURE OF ROOF ^{a,b}		
	Fully exposed ^c	Partially exposed	Sheltered
A (see Section 1609.4)	N/A	1.1	1.3
B (see Section 1609.4)	0.9	1.0	1.2
C (see Section 1609.4)	0.9	1.0	1.1

For SI: 1 mile = 1609 m.

a. The terrain category and roof exposure condition chosen shall be representative of the anticipated conditions during the life of the structure. An exposure factor

- shall be determined for each roof of a structure.
- b. Definitions of roof exposure are as follows:
1. Fully exposed shall mean roofs exposed on all sides with no shelter afforded by terrain, higher structures or trees. Roofs that contain several large pieces of mechanical equipment, parapets which extend above the height of the balanced snow load, h_s , or other obstructions are not in this category.
 2. Partially exposed shall include all roofs except those designated as "fully exposed" or "sheltered."
 3. Sheltered roofs shall mean those roofs located tight in among conifers that qualify as "obstructions."
- c. Obstructions within a distance of $10h_o$ provide "shelter," where h_o is the height of the obstruction above the roof level. If the only obstructions are a few deciduous trees that are leafless in winter, the "fully exposed" category shall be used except for terrain category "A." Note that these are heights above the roof. Heights used to establish the terrain category in Section 1609.4 are heights above the ground.]

[1608.3.2 Thermal factor. The value for the thermal factor, C_t , used in the calculation of ρ_f shall be determined from Table 1608.3.2.]

**TABLE 1608.3.2
THERMAL FACTOR, C_t**

THERMAL CONDITION*	C_t
All structures except as indicated below	1.0
Structures kept just above freezing and others with cold, ventilated roofs in which the thermal resistance (R value) between the ventilated space and the heated space exceeds $25h - ft^2 - ^\circ F/Btu$	1.1
Unheated structures	1.2
Continuously heated greenhouses ^b with a roof having a thermal resistance (R value) less than $2.0h - ft^2 - ^\circ F/Btu$	0.85

For SI: $1 h - ft^2 - ^\circ F/Btu = 0.176 m^2 \cdot K/W$.

- a. The thermal condition shall be representative of the anticipated conditions during winters for the life of the structure.
- b. A continuously heated greenhouse shall mean a greenhouse with a constantly maintained interior temperature of 50°F or more during winter months. Such greenhouse shall also have a maintenance attendant on duty at all times or a temperature alarm system to provide warning in the event of a heating system failure.

[1608.3.3 Snow load importance factor. The value for the snow load importance factor, I_s , used in the calculation of ρ_f shall be determined in accordance with Table 1604.5.2 based on the Structural Occupancy Category determined in accordance with Table 1604.5. Greenhouses that are occupied for growing plants on production or research basis, without public access, shall be included in Structural Occupancy Category I.]

[1608.3.4 Reserved.]

[1608.3.5] 1608.3 Ponding instability. [For roofs with a slope less than 1/4 inch per foot (1.19 degrees), the design calculations shall include verification of the prevention of] Susceptible bays of roofs shall be evaluated for ponding instability in accordance with [Section 7.11] Chapters 7 and 8 of ASCE 7.

[1608.3.6 Ice. For ice loads to be used in the design of ice sensitive structures, such as open framed or guyed towers, refer to Chapter 10 of ASCE 7.]

[1608.4 Sloped roof snow loads. The snow load, p_s , on a roof with a slope greater than 5 degrees (0.09 rad) (1 inch per foot = 4.76 degrees) shall be calculated in accordance with Section 7.4 of ASCE 7.]

[1608.5 Partial loading. The effect of not having the balanced snow load over the entire loaded roof area shall be analyzed in accordance with Section 7.5 of ASCE 7.]

[1608.6 Unbalanced snow loads. Unbalanced roof snow loads shall be determined in accordance with Section 7.6 of ASCE 7. Winds from all directions shall be accounted for when establishing unbalanced snow loads.]

~~[1608.7 Drifts on lower roofs. In areas where the ground snow load, P_g , as determined by Section 1608.2, is equal to or greater than 5 psf (0.240 kN/ m²), roofs shall be designed to sustain localized loads from snowdrifts in accordance with Section 7.7 of ASCE 7.]~~

~~[1608.8 Roof projections. Drift loads due to mechanical equipment, penthouses, parapets and other projections above the roof shall be determined in accordance with Section 7.8 of ASCE 7.]~~

~~[1608.9 Sliding snow. The extra load caused by snow sliding off a sloped roof onto a lower roof shall be determined in accordance with Section 7.9 of ASCE 7.]~~

SECTION BC 1609 WIND LOADS

1609.1 Applications. Buildings, structures and parts thereof shall be designed to withstand the minimum wind loads prescribed herein. Decreases in wind loads shall not be made for the effect of shielding by other structures.

1609.1.1 Determination of wind loads. Wind loads on every building or structure shall be determined in accordance with ~~[Chapter 6]~~ Chapters 26 to 31 of ASCE 7 ~~[with the basic]~~. The type of opening protection required, the basic design wind speed, V , and the exposure category for a site is permitted to be determined in accordance with [Sections 1609.3 through 1609.4] Section 1609.[-]. ~~[Wind loads may also be determined using provisions of the alternate methods described in Section 1609.6.]~~ Wind shall be assumed to come from any horizontal direction and wind pressures shall be assumed to act normal to the surface considered.

Exceptions:

1. ~~[Reserved]~~ Subject to the limitations of Section 1609.1.1.1, the provisions of ICC 600 shall be permitted for applicable Group R-2 and R-3 buildings.
2. Subject to the limitations of Section 1609.1.1.1, residential structures using the provisions of ~~[the AF&PA]~~ AWC WFCM.
3. Subject to the limitations of Section 1609.1.1.1, residential structures using the provisions of AISI S230.
4. Designs using NAAMM FP 1001 ~~[Guide Specification for Design of Metal Flagpoles]~~.
5. Designs using ~~[TIA/EIA-222]~~ TIA-222 for antenna-supporting structures and antennas.
6. Wind tunnel tests in accordance with ~~[Section 6.6]~~ ASCE 49 and Sections 31.4 and 31.5 of ASCE 7 ~~[, subject to the limitations in Section 1609.1.1.2].~~

The wind speeds in Section 1609.3 are basic design wind speeds, V , and shall be converted in accordance with Section 1609.3.1 to allowable stress design wind speeds, V_{asd} , when the provisions of the standards referenced in Exceptions 4 and 5 are used.

1609.1.1.1 Applicability. The provisions of ICC 600[~~–AF&PA~~] are applicable only to buildings located within Exposure B or C as defined in Section 1609.4. The provisions of ICC 600, AWC WFCM and AISI S230 shall not apply to buildings sited on the upper half of an isolated hill, ridge or escarpment meeting the following conditions:

1. The hill, ridge or escarpment is 60 feet (18 288 mm) or higher if located in Exposure B or 30 feet (9144 mm) or higher if located in Exposure C;
2. The maximum average slope of the hill exceeds 10 percent; and
3. The hill, ridge or escarpment is unobstructed upwind by other such topographic features for a distance from the high point of 50 times the height of the hill or [~~1 mile (1.61 km)~~] 2 miles (3.22 km), whichever is greater.

~~[1609.1.1.2 Wind tunnel test limitations. The lower limit on pressures for main wind force-resisting systems and components and cladding shall be in accordance with Sections 1609.1.1.2.1 and 1609.1.1.2.2.]~~

~~[1609.1.1.2.1 Lower limits on main wind force-resisting system. Base overturning moments determined from wind tunnel testing shall be limited to not less than 80 percent of the design base overturning moments determined in accordance with Section 6.5 of ASCE 7, unless specific testing is performed that demonstrates that lower values result from the aerodynamic coefficient of the building, rather than shielding from other structures. The 80 percent limit shall be permitted to be adjusted by the ratio of the frame load at critical wind directions as determined from wind tunnel testing without specific adjacent buildings, but including appropriate upwind roughness, to that determined in Section 6.5 of ASCE 7. In no case shall the limiting value be less than 50 percent of the design base overturning moments determined in accordance with Section 6.5 of ASCE 7.]~~

~~[1609.1.1.2.2 Lower limits on components and cladding. The design pressures for components and cladding on walls or roofs shall be selected as the greater of: (i) the wind tunnel test results; or (ii) 80 percent of the pressure obtained for Zone 4 for walls and Zone 1 for roofs, as determined in Section 6.5 of ASCE 7, unless specific testing is performed that demonstrates that lower values result from the aerodynamic coefficient of the building rather than shielding from nearby structures. Alternatively, limited tests at a few wind directions without specific adjacent buildings, but in the presence of an appropriate upwind roughness, shall be permitted to be used to demonstrate that the lower pressures are due to the shape of the building and not to shielding. In no case shall the limiting value be less than 65 percent of the pressure obtained for Zone 4 for walls and Zone 1 for roofs, as determined in Section 6.5 of ASCE 7.]~~

~~[1609.1.2 Protection from wind borne debris. The following buildings shall be protected with an impact resistant covering or glazing in accordance with the Missile Levels and Wind Zones specified in ASTM E 1886 and ASTM E 1996 or other approved test methods and performance criteria:]~~

- ~~[1. Buildings in Structural Occupancy Category IV, as defined in Table 1604.5, located in Exposure C or D, as defined in Section 1609.4;]~~

- [2. Buildings in Structural Occupancy Category III, as defined in Table 1604.5, located in Exposure D, as defined in Section 1609.4, where the glazing of such building encloses places of assembly for 300 or more persons or areas of in-place shelter.]

[Exception: Glazing protection in accordance with Section 1609.1.2 shall not be required if the glazing is located more than 60 feet (18 288 mm) above the ground and more than 30 feet (9144 mm) above aggregate surfaced roofs, including roofs with gravel or stone ballast located within 1,500 feet (457.2 m) of the building.]

1609.1.2 Protection of openings. In wind-borne debris regions, glazing in buildings shall be impact resistant or protected with an impact-resistant covering meeting the requirements of an approved impact-resistant standard or ASTM E1996 and ASTM E1886 referenced herein as follows:

1. Glazed openings located within 30 feet (9144 mm) of grade shall meet the requirements of the large missile test of ASTM E1996.
2. Glazed openings located more than 30 feet (9144 mm) above grade shall meet the provisions of the small missile test of ASTM E1996.

Exceptions:

1. Wood structural panels with a minimum thickness of $\frac{7}{16}$ inch (11.1 mm) and maximum panel span of 8 feet (2438.4 mm) shall be permitted for opening protection in buildings with a mean roof height of 33 feet (10 058 mm) or less that are classified as a Group R-3 or R-4 occupancy. Panels shall be precut so that they shall be attached to the framing surrounding the opening containing the product with the glazed opening. Panels shall be predrilled as required for the anchorage method and shall be secured with the attachment hardware provided. Attachments shall be designed to resist the components and cladding loads determined in accordance with the provisions of ASCE 7, with corrosion-resistant attachment hardware provided and anchors permanently installed on the building. Attachment in accordance with Table 1609.1.2 of this code with corrosion-resistant attachment hardware provided and anchors permanently installed on the building is permitted for buildings with a mean roof height of 45 feet (13 716 mm) or less where V_{asd} determined in accordance with Section 1609.3.1 of this code does not exceed 140 mph (63 m/s).
2. Glazing in Risk Category I or II buildings, including greenhouses that are occupied for growing plants on a production or research basis, without public access shall be permitted to be unprotected.
3. Glazing in Risk Category III or IV buildings located over 60 feet (18 288 mm) above the ground.

TABLE 1609.1.2
WIND-BORNE DEBRIS PROTECTION FASTENING SCHEDULE FOR WOOD STRUCTURAL
PANELS^{A,B,C,D}

FASTENER TYPE	FASTENER SPACING (inches)		
	Panel Span ≤ 4 feet	4 feet < Panel Span ≤ 6 feet	6 feet < Panel Span ≤ 8 feet
No. 8 wood-screw-based anchor with 2-inch embedment length	16	10	8
No. 10 wood-screw-based anchor with 2-inch embedment length	16	12	9
¼-inch diameter lag-screw-based anchor with 2-inch embedment length	16	16	16

For SI: 1 inch = 25.4 mm, 1 foot = 304.8 mm, 1 pound = 4.448 N, 1 mile per hour = 0.447 m/s.

- a. This table is based on 140 mph wind speeds and a 45-foot mean roof height.
- b. Fasteners shall be installed at opposing ends of the wood structural panel. Fasteners shall be located a minimum of 1 inch from the edge of the panel.
- c. Anchors shall penetrate through the exterior wall covering with an embedment length of 2 inches minimum into the building frame. Fasteners shall be located a minimum of 2½ inches from the edge of concrete block or concrete.
- d. Where panels are attached to masonry or masonry/stucco, they shall be attached using vibration-resistant anchors having a minimum ultimate withdrawal capacity of 1,500 pounds.

1609.1.2.1 Louvers. Louvers protecting intake and exhaust ventilation ducts not assumed to be open that are located within 30 feet (9144 mm) of grade shall meet the requirements of [an approved impact-resisting standard or the large missile test of ASTM E 1996] AMCA 540.

1609.1.2.2 Application of ASTM E1996. The text of Section 6.2.2 of ASTM E1996 shall be substituted as follows:

6.2.2 Unless otherwise specified, select the wind zone based on the strength design wind speed, V, as follows:

6.2.2.1 Wind Zone 1—130 mph < basic design wind speed, V < 140 mph.

6.2.2.2 Delete.

6.2.2.3 Delete.

6.2.2.4 Delete.

[~~1609.1.2.2~~] **1609.1.2.3 Garage doors.** Garage door glazed opening protection for wind-borne debris shall meet the requirements of an approved impact-resisting standard or ANSI/DASMA 115.

1609.1.3 Minimum wind loads. The design wind [loads] pressure, p, used in the design of the main wind-force-resisting system shall not be less than [~~10 psf (0.479 kN/m²)~~] 16 psf (0.766 kN/m²) multiplied by the area of the building or structure projected on a vertical plane normal to the wind direction. In the calculation of design wind [~~loads for~~] pressure, p, used in the design of components and cladding for buildings, the algebraic sum of the pressures acting on opposite faces shall be taken into account. The design pressure for components and cladding of buildings shall not be less than [~~20 psf (0.958 kN/m²)~~] 32 psf (1.533 kN/m²) acting in either direction normal to the surface. The design force for open buildings and other structures shall not be less than [~~10 psf (0.479 kN/m²)~~] 16 psf (0.766 kN/m²) multiplied by the area A_f.

1609.1.4 Anchorage against overturning, uplift and sliding. Structural members and systems and components and cladding in a building or structure shall be anchored to resist wind-induced

overturning, uplift and sliding and to provide continuous load paths for these forces to the foundation.

Where a portion of the resistance to these forces is provided by dead load, the dead load, including the weight of soils and foundations, shall be taken as the minimum dead load likely to be in place during a design wind event.

1609.1.5 Wind and seismic detailing. Lateral-force-resisting systems shall meet seismic detailing requirements and limitations prescribed in this code, even when wind code prescribed load effects are greater than seismic load effects.

1609.1.6 Wind tunnel test limitations. The lower limit on pressures for main wind-force-resisting systems and components and cladding shall be in accordance with this section.

1609.1.6.1 Lower limits on main wind-force-resisting system. Base overturning moments determined from wind tunnel testing shall be limited to not less than 80 percent of the design base overturning moments determined in accordance with Section 27.2 of ASCE 7 unless the wind tunnel results and testing procedure are peer reviewed by an independent wind tunnel laboratory. In no case shall the limiting value be less than 70 percent of the design base overturning moments determined in accordance with Section 27.2 of ASCE 7.

1609.1.6.2 Lower limits on components and cladding. The design pressures for components and cladding on walls or roofs shall be selected as the greater of: (i) the wind tunnel test results; or (ii) 80 percent of the pressure obtained for Zone 4 for walls and Zone 1 for roofs, as determined in Section 30.5 of ASCE 7, unless the wind tunnel results and testing procedure are peer reviewed by an independent wind tunnel laboratory. In no case shall the limiting value be less than 70 percent of the pressure obtained for Zone 4 for walls and Zone 1 for roofs, as determined in Section 30.5 of ASCE 7.

1609.1.6.3 Scope of peer review by independent wind tunnel laboratory. When applicable, the peer reviewer of the wind tunnel test shall:

1. Be retained by or on behalf of the owner and shall be independent from the wind tunnel laboratory that performed the tests and the report shall bear no conflict of interest.
2. Have a minimum of 10 years of technical expertise in the application of wind tunnel studies on buildings comparable to that being reviewed.
3. Have experience in performing or evaluating boundary layer wind tunnel studies and shall be familiar with the technical issues and regulations governing the wind tunnel procedure in ASCE 49.
4. Review the wind tunnel report, including but not limited to wind climate data and modeling, data analysis, boundary layer modeling, building modeling, significant influential buildings, resulting wind loads and other relevant issues identified by the reviewer.

5. Review the wind tunnel report for cladding and envelope pressures, if applicable.
6. Submit a report to the department summarizing the results of their review, and shall state whether the wind tunnel test and the results meet the industry standard, the New York City Building Code and are appropriate for the project.

1609.2 Definitions. [~~The following words and terms shall, for~~ For the purposes of Section 1609[; have the meanings shown herein.] and as used elsewhere in the code, the following terms are defined in Chapter 2:

BUILDINGS AND OTHER STRUCTURES, FLEXIBLE. [~~Buildings and other structures that have a fundamental natural frequency less than 1 Hz.~~]

BUILDING, ENCLOSED. [~~A building that does not comply with the requirements for open or partially enclosed buildings.~~]

BUILDING, LOW-RISE. [~~Enclosed or partially enclosed buildings that comply with the following conditions:~~]

[~~1. Mean roof height, h , less than or equal to 60 feet (18 288 mm).~~]

[~~2. Mean roof height, h , does not exceed least horizontal dimension.~~]

BUILDING, OPEN. [~~A building having each wall at least 80 percent open. This condition is expressed for each wall by the equation:~~]

$$[A_o \geq 0.8A_g] \quad \text{[(Equation 16-39)]}$$

[where:]

[~~A_o = Total area of openings in a wall that receives positive external pressure, in square feet (m^2).~~]

[~~A_g = The gross area of that wall in which A_o is identified, in square feet (m^2).~~]

BUILDING, PARTIALLY ENCLOSED. [~~A building that complies with both of the following conditions:~~]

[~~1. The total area of openings in a wall that receives positive external pressure exceeds the sum of the areas of openings in the balance of the building envelope (walls and roof) by more than 10 percent; and]~~

[~~2. The total area of openings in a wall that receives positive external pressure exceeds 4 square feet ($0.37 m^2$) or 1 percent of the area of that wall, whichever is smaller, and the percentage of openings in the balance of the building envelope does not exceed 20 percent. These conditions are expressed by the following equations:]~~

$$[A_o > 1.10A_{ot}] \quad \text{[(Equation 16-40)]}$$

$$[A_o > 4 \text{ square feet } (0.37 m^2) \text{ or } > 0.01A_g, \text{ whichever is smaller, and } A_{ot}/A_{gt} \leq 0.20]$$

$$\text{[(Equation 16-41)]}$$

[where:]

[A_o , A_g are as defined for an open building.]

[A_{ot} = The sum of the areas of openings in the building envelope (walls and roof) not including A_o , in square feet (m^2).]

[A_{gt} = The sum of the gross surface areas of the building envelope (walls and roof) not including A_g , in square feet (m^2).]

BUILDING, SIMPLE DIAPHRAGM. [A building in which wind loads are transmitted through floor and roof diaphragms to the vertical lateral force resisting systems.]

COMPONENTS AND CLADDING. [Elements of the building envelope that do not qualify as part of the main wind force resisting system.]

EAVE HEIGHT, h [':]. [The distance from the ground surface adjacent to the building to the roof eave line at the particular wall. If the distance of the eave varies along the wall, the average distance shall be used.]

EFFECTIVE WIND AREA. [The area used to determine G_Cp . For component and cladding elements, the effective wind area in Tables 1609.6.2.1(2) and 1609.6.2.1(3) is the span length multiplied by an effective width that need not be less than one third the span length. For cladding fasteners, the effective wind area shall not be greater than the area that is tributary to an individual fastener.]

HURRICANE-PRONE REGIONS. [New York City is within the hurricane-prone region.]

IMPORTANCE FACTOR, I . [A factor that accounts for the degree of hazard to human life and damage to property.]

MAIN WIND FORCE-RESISTING SYSTEM. [An assemblage of structural elements assigned to provide support and stability for the overall structure. The system generally receives wind loading from more than one surface.]

MEAN ROOF HEIGHT. [The average of the roof eave height and the height to the highest point on the roof surface, except that eave height shall be used for roof angle of less than or equal to 10 degrees (0.1745 rad).]

[WIND-BORNE DEBRIS REGION. [New York City is not in the wind borne debris region.]]

WIND SPEED, V (BASIC).

WIND SPEED, V_{asd} (ALLOWABLE STRESS DESIGN).

WIND-BORNE DEBRIS REGION. [New York City is not in the wind borne debris region.]

1609.3 Basic design wind speed. The basic design wind speed, V , in mph, for [New York City is 98 mph (43.8m/s). The basic wind speed is measured at 33 feet (10 058 mm) above ground in Exposure C as a 3-second gust speed. This wind speed is based on local wind climate with a nominal annual

probability of 0.02 (nominal 50-year mean recurrence interval) which is obtained by dividing the 700-year mean recurrence wind speed by $\sqrt{1.6}$.] determining wind speed shall be that of Table 1609.3.

**TABLE 1609.3
BASIC DESIGN WIND SPEED**

<u>Risk Category</u>	<u>Basic Design Wind Speed, mph</u> <u>(3-sec gust, 33 ft. for Exposure Category C)</u>	<u>Mean Recurrence Interval,</u> <u>years</u>	<u>Probability of Exceedance</u> <u>in 50 years, %</u>
I	110	300	15
II	117	700	7
III	127	1700	3
IV	132	3000	1.6

Note: Values are ultimate design 3-second gust wind speeds in miles per hour at 33 feet (10 058 mm) above ground for Exposure Category C.

1609.3.1 Wind speed conversion. [~~When required, the 3-second gust wind speed, V_{3S} , can be converted to a fastest-mile wind speed, V_{fm} , using Equation 16-42 below.~~] Where required, the basic design wind speed, V , of Table 1609.3 shall be converted to allowable stress design wind speed, V_{asd} , using Equation 16-40.

$$[V_{fm} = (V_{3S} - 10.5) / 1.05] \quad \text{[(Equation 16-42)]}$$

$$V_{asd} = 0.79V \quad \text{[(Equation 16-40)]}$$

1609.3.2 Wind speed for serviceability design. Table 1609.3.2 presents 3-second gust wind speeds for mean recurrence intervals (MRI) of 10, 25, 50 and 100 years. These wind speeds may be used for serviceability applications such as drift and habitability.

**TABLE 1609.3.2
SERVICEABILITY DESIGN WIND SPEED**

<u>Mean Recurrence Interval (years)</u>	<u>Serviceability Design Wind Speed, mph</u> <u>(3-sec gust, 33 ft. for Exposure Category C)</u>
10	80
25	87
50	93
100	100

Note: Values are 3-second gust wind speeds in miles per hour at 33 feet (10 058 mm) above ground for Exposure Category C.

1609.4 Exposure category. For each wind direction considered, an exposure category that adequately reflects the characteristics of ground surface irregularities shall be determined for the site at which the building or structure is to be constructed. [~~For a site located in the transition zone between categories, the category resulting in the largest wind forces shall apply.~~]

Account shall be taken of variations in ground surface roughness that arise from natural topography and vegetation as well as from constructed features. [~~When applying the simplified wind load method of Section 1609.6, a single exposure category shall be used based upon the most restrictive for any given wind direction.~~]

1609.4.1 Wind directions and sectors. For each selected wind direction at which the wind loads are to be evaluated, the exposure of the building or structure shall be determined for the two upwind sectors extending 45 degrees (0.79 rad) either side of the selected wind direction. The

exposures in these two sectors shall be determined in accordance with Sections 1609.4.2 and 1609.4.3 and the exposure resulting in the highest wind loads shall be used to represent winds from that direction.

1609.4.2 Surface roughness categories. A ground surface roughness within each 45-degree (0.79 rad) sector shall be determined for a distance upwind of the site as defined in Section 1609.4.3 from the categories defined below, for the purpose of assigning an exposure category as defined in Section 1609.4.3.

Surface Roughness B. Urban and suburban areas, wooded areas or other terrain with numerous closely spaced obstructions having the size of single-family dwellings or larger.

Surface Roughness C. Open terrain with scattered obstructions having heights generally less than 30 feet (9144 mm). This category includes flat open country, grasslands, and limited water surfaces per Figure 1609.4.3.

Surface Roughness D. Flat, unobstructed areas and water surfaces~~[, including areas in hurricane-prone regions]~~. This category includes smooth mud flats, salt flats and unbroken ice.

1609.4.3 Exposure categories. An exposure category shall be determined in accordance with the following:

Figure 1609.4.3 provides the exposure categories at the shore lines for wind directions approaching over the water within the city boundaries.

Exposure B. For buildings with a mean roof height of less than or equal to 30 feet (9144 mm), Exposure B shall apply where the ground surface roughness [condition], as defined by Surface Roughness B, prevails in the upwind direction for a distance of at least 1,500 feet (457.2 m). For buildings with a mean roof height greater than 30 feet (9144 mm), Exposure B shall apply where Surface Roughness B prevails in the upwind direction for a distance of at least 2,600 feet ([792] 792.5 m) or 20 times the height of the building, whichever is greater.

~~**[Exception:** For buildings whose mean roof height is less than or equal to 30 feet (9144 mm), the upwind distance is permitted to be reduced to 1,500 feet (457 m).]~~

Exposure C. Exposure C shall apply where it is shown in Figure 1609.4.3 or for all cases where ~~[Exposures]~~ Exposure B or D does not apply.

Exposure D. Exposure D shall apply where the ground surface roughness, as defined by Surface Roughness D, prevails in the upwind direction for a distance of at least 5,000 feet (1524 m) or 20 times the height of the building, whichever is greater. Exposure D shall ~~[extend inland from]~~ also apply where the [shoreline for] ground surface roughness immediately upwind of the site is B or C, and the site is within a distance of 600 feet ([183] 182.9 m) or 20 times the [height of the] building height, whichever is greater, from an Exposure D condition as defined in the previous sentence.



Figure 1609.4.3 (1)
NEW YORK CITY WIND EXPOSURE: MANHATTAN SHORELINE

- Notes:
- ■ ■ ■ Exposure C: Buildings within a distance of 2,600 feet from shoreline.
 - ▬ Exposure C: Buildings within a distance of 2,600 feet or 20 times building height from the shoreline, whichever is greater.
 - ▬▬▬ Exposure D: Coastal zone, see Section 1609.4.

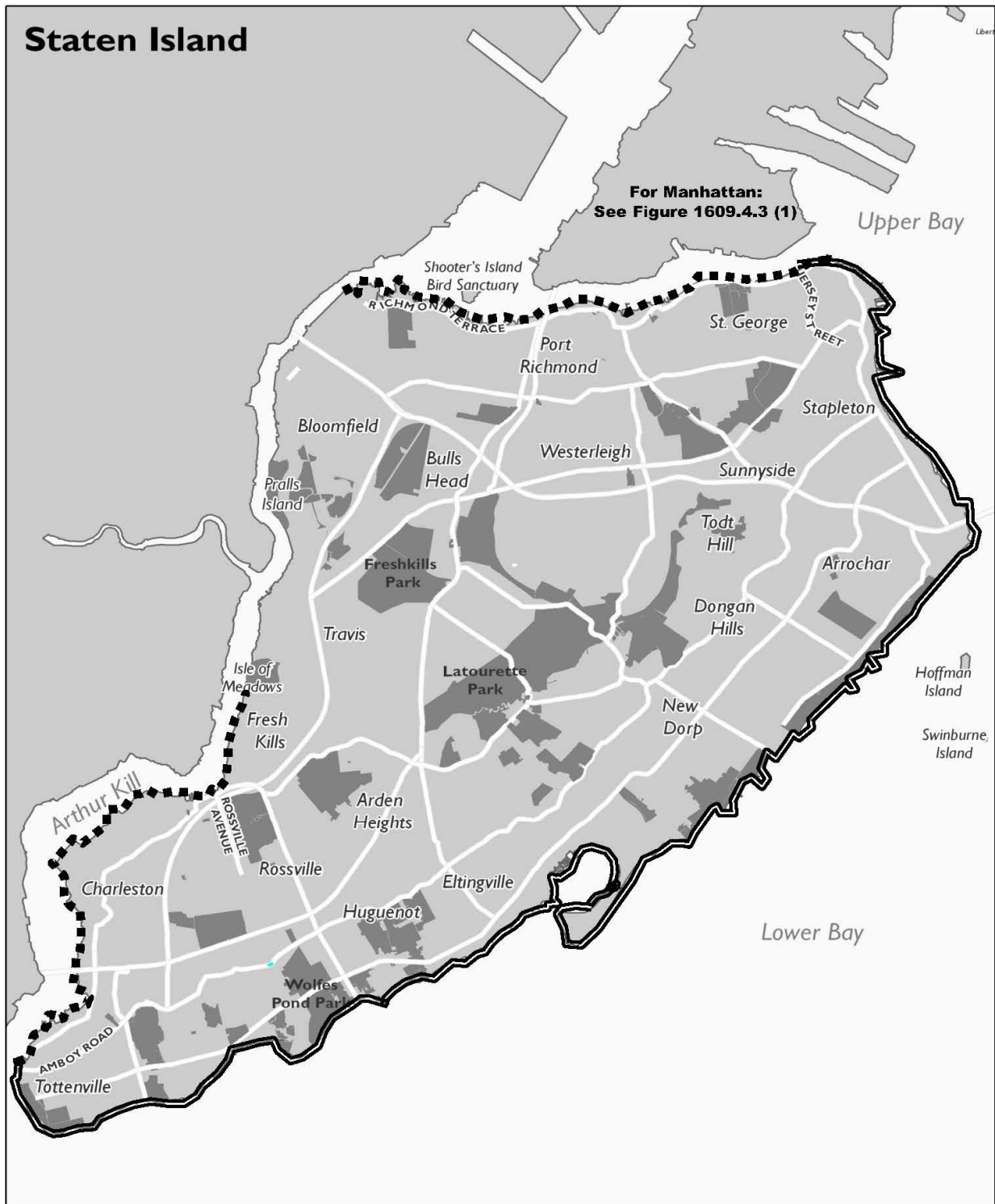

**Figure 1609.4.3 (5)
NEW YORK CITY WIND EXPOSURE: STATEN ISLAND SHORELINE**

Notes:

- ■ ■ ■ Exposure C: Buildings within a distance of 2,600 feet from shoreline.
- Exposure C: Buildings within a distance of 2,600 feet or 20 times building height from the shoreline, whichever is greater.
- == Exposure D: Coastal zone, see Section 1609.4.

factor, I, in accordance with Table 1604.5.2 based on the Structural Occupancy Category determined by Table 1604.5.]

[1609.6 Simplified wind load methods.]

[1609.6.1 Scope. The procedures in Section 1609.6 shall be permitted to be used for determining and applying wind pressures in the design of enclosed buildings as listed below:]

- [1. For buildings with flat, gabled or hipped roofs having a mean roof height not exceeding the least horizontal dimension or 60 feet (18 288 mm), whichever is less, the use of Section 1609.6.2, Simplified Procedure I, is permitted.]
- [2. For buildings located within any Borough with a mean roof height of not more than 200 feet (60 960 mm) not located in Exposure C or D in accordance with Section 1609.4, the use of Section 1609.6.3, Simplified Procedure II, is permitted.]
- [3. For buildings located within the Borough of Manhattan with a mean roof height of not more than 300 feet (91 440 mm) and not located in Exposure C or D in accordance with Section 1609.4, the use of Section 1609.6.3, Simplified Procedure II, is permitted.]

[1609.6.2 Simplified Design Procedure I (for low-rise buildings).]

- [1. The wind shall be assumed to come from any horizontal direction.]
- [2. An importance factor I shall be determined in accordance with Section 1609.5.]
- [3. An exposure category shall be determined in accordance with Section 1609.4.]
- [4. A height and exposure adjustment coefficient, λ , shall be determined from Table 1609.6.2.1(4).]

[1609.6.2.1 Main wind force-resisting system. Simplified design wind pressures, p_s , for the main wind force-resisting systems represent the net pressures (sum of internal and external) to be applied to the horizontal and vertical projections of building surfaces as shown in Figure 1609.6.2.1. For the horizontal pressures (Zones A, B, C, D), p_s is the combination of the windward and leeward net pressures. p_s shall be determined from Equation 16-43.)]

$$[p_s = \lambda I W P_{s30}] \qquad \qquad \qquad \text{[(Equation 16-43)]}$$

[where:]

- [λ = Adjustments factor for building height and exposure from Table 1609.6.2.1(4).]
- [I = Importance factor as defined in Section 1609.5.]
- [P_{s30} = Simplified design wind pressure for Exposure B, at $h = 30$ feet (9144 mm), and for $I = 1.0$, from Table 1609.6.2.1(1).]

[

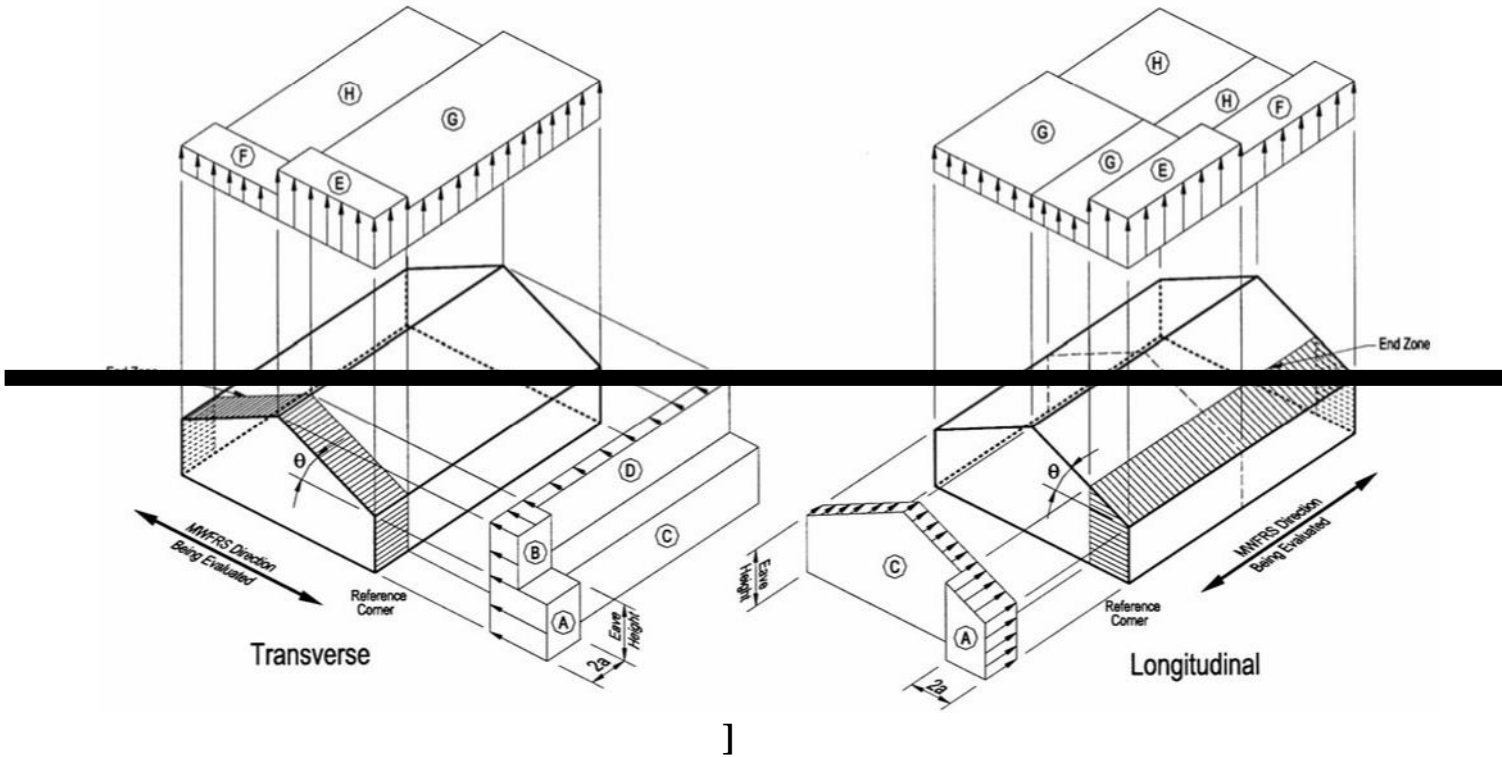

[FIGURE 1609.6.2.1
MAIN WINDFORCE LOADING DIAGRAM

For SI: 1 foot = 304.8 mm, 1 degree = 0.0174 rad.

Notes:

1. Pressures are applied to the horizontal and vertical projections for Exposure B, at $h = 30$ feet, for $I = 1.0$. Adjust to other exposures and heights with adjustment factor λ .
2. The load patterns shown shall be applied to each corner of the building in turn as the reference corner.
3. For the design of the longitudinal MWFRS, use $\theta = 0^\circ$, and locate the Zone E/F, G/H boundary at the mid-length of the building.
4. Load Cases 1 and 2 must be checked for $25^\circ < \theta \leq 45^\circ$. Load Case 2 at 25° is provided only for interpolation between 25° to 30° .
5. Plus and minus signs signify pressures acting toward and away from the projected surfaces, respectively.
6. For roof slopes other than those shown, linear interpolation is permitted.
7. The total horizontal load shall not be less than that determined by assuming $PS = 0$ in Zones B and D.
8. The zone pressures represent the following:
 - Horizontal pressure zones — Sum of the windward and leeward net (sum of internal and external) pressures on vertical projection of:
 - A — End zone of wall
 - B — End zone of roof
 - C — Interior zone of wall
 - D — Interior zone of roof
 - Vertical pressure zones — Net (sum of internal and external) pressures on horizontal projection of:
 - E — End zone of windward roof
 - F — End zone of leeward roof
 - G — Interior zone of windward roof
 - H — Interior zone of leeward roof
9. Where Zone E or G falls on a roof overhang on the windward side of the building, use E_{OH} and G_{OH} for the pressure on the horizontal projection of the overhang. Overhangs on the leeward and side edges shall have the basic zone pressure applied.
10. Notation:
 - a : 10 percent of least horizontal dimension or $0.4h$, whichever is smaller, but not less than either 4 percent of least horizontal dimension or 3 feet.
 - h : Mean roof height, in feet (meters), except that eave height shall be used for roof angles $< 10^\circ$.
 - θ : Angle of plane of roof from horizontal, in degrees.

[TABLE 1609.6.2.1(1)
SIMPLIFIED DESIGN WIND PRESSURE (MAIN WINDFORCE RESISTING SYSTEM), $p_{s,30}$ (Exposure B at $h = 30$ feet with $I = 1.0$) (psf)

ROOF ANGLE (degrees)	ROOF RISE IN 12	LOAD CASE	ZONES									
			Horizontal Pressures				Vertical Pressures				Overhangs	
			A	B	C	D	E	F	G	H	E_{OH}	G_{OH}
0 to 5°	Flat	1	12.0	-6.0	8.0	-4.0	-14.0	-8.0	-10.0	-6.0	-20.0	-15.0

10°	2	1	22.0	-9.0	15.0	-5.0	-23.0	-14.0	-16.0	-11.0	-33.0	-26.0
15°	3	1	24.0	-8.0	16.0	-5.0	-23.0	-15.0	16.0	-12.0	-33.0	-26.0
20°	4	1	27.0	-7.0	18.0	-4.0	-23.0	-16.0	16.0	-12.0	-33.0	-26.0
25°	6	1	24.0	4.0	18.0	4.0	-11.0	-15.0	-8.0	-12.0	-20.0	-17.0
		2	—	—	—	—	-4.0	-8.0	-1.0	-5.0	—	—
30° to 45°	7 to 12	1	22.0	15.0	17.0	12.0	2.0	-13.0	1.0	-12.0	-8.0	-9.0
		2	22.0	15.0	17.0	12.0	9.0	-7.0	7.0	-5.0	-4.0	-9.0

For SI: 1 inch = 25.4 mm, 1 foot = 304.8 mm, 1 degree = 0.0174 rad, 1 mile per hour = 0.44 m/s, 1 pound per square foot = 47.9 N/m².]

[TABLE 1609.6.2.1(2)
NET DESIGN WIND PRESSURE (COMPONENT AND CLADDING), p_{net30}
(Exposure B at $h = 30$ feet with $I = 1.0$ and $kzt=1$ and 98 mph 3 sec. gust basic wind speed) (psf)

	ZONE	EFFECTIVE WIND AREA	PRESSURE / SUCTION	
Roof 0 to 7.7 degrees	1	10	7.0	-17.0
	1	20	7.0	-16.0
	1	50	6.0	-16.0
	1	100	6.0	-15.0
	2	10	7.0	-28.0
	2	20	7.0	-25.0
	2	50	6.0	-21.0
	2	100	6.0	-18.0
	3	10	7.0	-42.0
	3	20	7.0	-35.0
	3	50	6.0	-26.0
	3	100	6.0	-18.0
Roof > 7 to 27 degrees	1	10	10.0	-15.0
	1	20	9.0	-15.0
	1	50	8.0	-14.0
	1	100	7.0	-14.0
	2	10	10.0	-27.0
	2	20	9.0	-25.0
	2	50	8.0	-22.0
	2	100	7.0	-20.0
	3	10	10.0	-39.0
	3	20	9.0	-37.0
	3	50	8.0	-33.0
	3	100	7.0	-31.0
Roof > 27 to 45 degrees	1	10	15.0	-17.0
	1	20	15.0	-16.0
	1	50	14.0	-15.0
	1	100	14.0	-14.0
	2	10	15.0	-20.0
	2	20	15.0	-19.0
	2	50	14.0	-18.0
	2	100	14.0	-17.0
	3	10	15.0	-20.0
	3	20	15.0	-19.0
	3	50	14.0	-18.0

	ZONE	EFFECTIVE WIND AREA	PRESSURE / SUCTION	
	3	100	14.0	-17.0
W_{wh}	4	10	17.0	-18.0
	4	20	16.0	-18.0
	4	50	15.0	-17.0
	4	100	14.0	-16.0
	4	500	13.0	-14.0
	5	10	17.0	-22.0
	5	20	16.0	-21.0
	5	50	15.0	-19.0
	5	100	14.0	-18.0
	5	500	13.0	-14.0

For SI: 1 foot = 304.8 mm, 1 degree = 0.0174 rad, 1 mile per hour = 0.447 m/s, 1 pound per square foot = 47.9 N/m².

Note: For effective areas between those given above, the load is permitted to be interpolated, otherwise use the load associated with the lower effective area.]

[TABLE 1609.6.2.1(3)

ROOF OVERHANG NET DESIGN WIND PRESSURE (COMPONENT AND CLADDING), *p_{net}* 30
(Exposure B at *h* = 30 feet with *I_w* = 1.0 and 98 mph 3 sec. gust basic wind speed) (psf)

	ZONE	EFFECTIVE	PRESSURE/ SUCTION
		WIND AREA	
		(sq. ft.)	
Roof 0 to 7 degrees	2	10	-24.0
	2	20	-24.0
	2	50	-23.0
	2	100	-23.0
	3	10	-40.0
	3	20	-31.0
	3	50	-20.0
	3	100	-12.0
Roof > 7 to 27 degrees	2	10	-31.0
	2	20	-31.0
	2	50	-31.0
	2	100	-31.0
	3	10	-52.0
	3	20	-47.0
	3	50	-41.0
	3	100	-35.0
Roof > 27 to 45 degrees	2	10	-28.0
	2	20	-28.0
	2	50	-26.0
	2	100	-26.0
	3	10	-28.0
	3	20	-28.0
	3	50	-26.0
	3	100	-26.0

For SI: 1 foot = 304.8 mm, 1 degree = 0.0174 rad, 1 mile per hour = 0.447 m/s, 1 pound per square foot = 47.9 N/m².

Note: For effective areas between those given above, the load is permitted to be interpolated, otherwise use the load associated with the lower effective area.]

**[TABLE 1609.6.2.1(4)
ADJUSTMENT FACTOR FOR BUILDING HEIGHT AND EXPOSURE, (λ)**

MEAN ROOF HEIGHT	EXPOSURE		
	(feet)	B	C/C1
15	1.00	1.21	1.47
20	1.00	1.29	1.55
25	1.00	1.35	1.61
30	1.00	1.40	1.66
35	1.05	1.45	1.70
40	1.09	1.49	1.74
45	1.12	1.53	1.78
50	1.16	1.56	1.81
55	1.19	1.59	1.84
60	1.22	1.62	1.87

For SI: 1 foot = 304.8 mm.

a. All table values shall be adjusted for other exposures and heights by multiplying by the above coefficients.]

[1609.6.2.1.1 Minimum pressures. The load effects of the design wind pressures from Section 1609.6.2.1 shall not be less than assuming the pressures, p_s , for Zones A, B, C and D all equal to + 20 psf (0.96 kN/m²), while assuming Zones E, F, G, and H all equal to 0 psf.]

[1609.6.2.2 Components and cladding. Net design wind pressures, p_{net} , for the components and cladding of buildings represent the net pressures (sum of internal and external) to be applied normal to each building surface as shown in Figure 1609.6.2.2. The net design wind pressure, p_{net} , shall be determined from Equation 16-44:]

$$[p_{net} = \lambda I p_{net,30}] \quad \text{[(Equation 16-44)]}$$

[where:]

[λ = Adjustments factor for building height and exposure from Table 1609.6.2.1(4).]

[I = Importance factor as defined in Section 1609.5.]

[$p_{net,30}$ = Net design wind pressure for Exposure B, at $h = 30$ feet (9144 mm), and for $I_w = 1.0$, from Tables 1609.6.2.1(2) and 1609.6.2.1(3).]

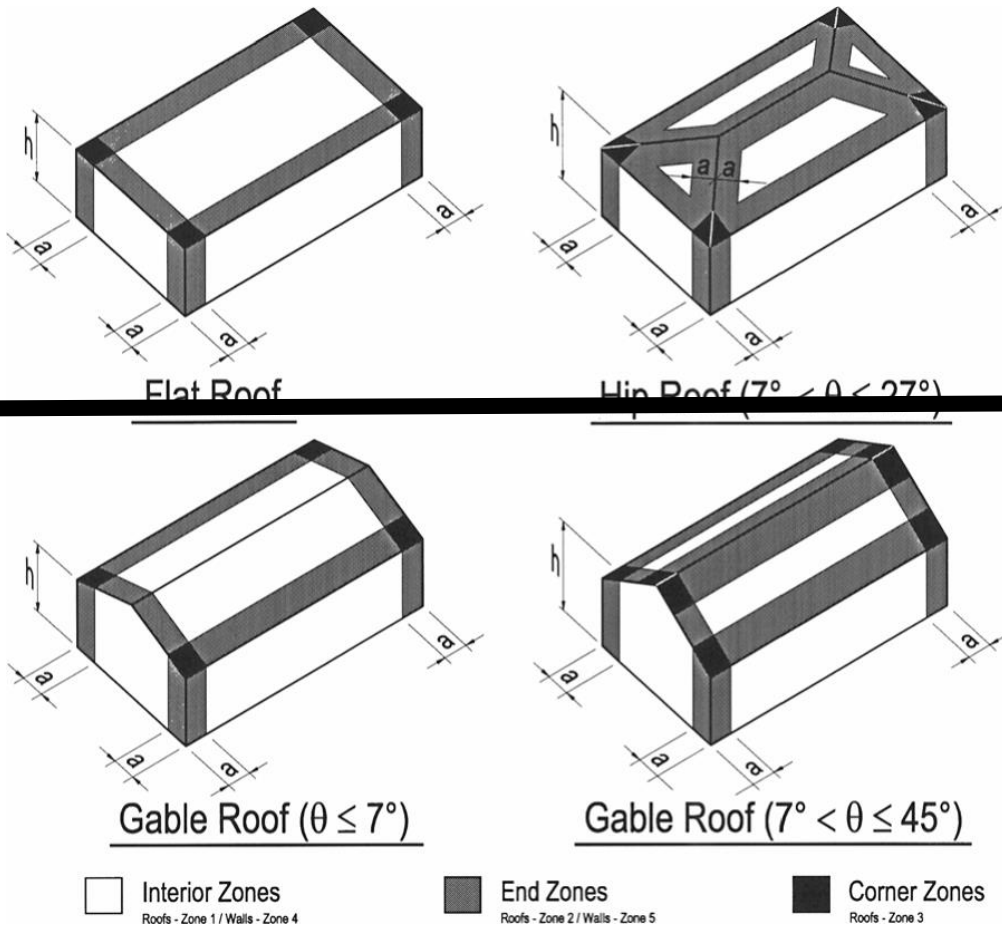

**FIGURE 1609.6.2.2
COMPONENT AND CLADDING PRESSURE**

]

[For SI: 1 foot = 304.8 mm, 1 degree = 0.0174 rad.]

Notes:

1. Pressures are applied normal to the surface for Exposure B, at $h = 30$ feet, for $I_w = 1.0$. Adjust to other exposures and heights with adjustment factor λ .
2. Plus and minus signs signify pressures acting toward and away from the surfaces, respectively.
3. For hip roofs with $0 \leq 25^\circ$, Zone 3 shall be treated as Zone 2.
4. For effective areas between those given, the value is permitted to be interpolated, otherwise use the value associated with the lower effective area.
5. Notation:
 a : 10 percent of least horizontal dimension or $0.4h$, whichever is smaller, but not less than either 4 percent of least horizontal dimension or 3 feet.
 h : Mean roof height, in feet (meters), except that eave height shall be used for roof angles $< 10^\circ$.
 θ : Angle of plane of roof from horizontal, in degrees.]

[1609.6.2.2.1 Minimum pressures. The positive design wind pressures, p_{net} , from Section 1609.6.2.2 shall not be less than + 20 psf (1.44 kN/m²), and the negative design wind pressures, p_{net} , from Section 1609.6.2.2 shall not be less than - 20 psf (-1.44 kN/m²).]

[1609.6.2.3 Load case. Members that act as both part of the main wind force-resisting system and as components and cladding shall be designed for each separate load case.]

[1609.6.3 Simplified Design Procedure II.]

[1609.6.3.1 Main wind force-resisting system. Main wind force-resisting systems shall comply with the following:]

~~[1. The building shall be designed for the following net lateral wind pressure to be applied to the horizontal projection of the building surfaces:]~~

~~[1.1. From 0 to 100 feet (0 to 30 480 mm) elevation 20 psf (0.96 kN/m²).]~~

~~[1.2. From 100 to 300 feet (30 480 to 91 440 mm) elevation 25 psf (1.2 kN/m²).]~~

~~[2. An importance factor, I, shall be determined in accordance with Section 1609.5 and shall be applied to the pressures indicated above.]~~

~~**[1609.6.3.2 Design wind load cases.** The main wind force resisting system of buildings, whose wind loads have been determined pursuant to Section 1609.6.3, shall be designed for wind load cases as defined below:]~~

~~[**Case 1.** Full design wind pressure acting on the projected area perpendicular to each principal axis of the structure, considered separately along each principal axis.]~~

~~[**Case 2.** Seventy five percent of the design wind pressure acting on the projected area perpendicular to each principal axis of the structure to be applied eccentric to the center of the exposure with eccentricity equal to 15 percent of the exposure width, considered separately for each principal direction.]~~

~~[**Case 3.** Wind loading as defined in Case 1 for each orthogonal direction, but considered to act simultaneously at 75 percent of the specified value.]~~

~~**[1609.6.3.3 Components and cladding, cladding.** Net Net design wind positive and negative pressures (pressure and suction) for the components and cladding of buildings represent the net (sum of internal and external) to be applied normal to each building surface. The net design wind positive and negative shall not be less than 30 psf (1.44 kN/m²), except at the corners of the building with a width equivalent to 10 percent of the building's width at its side; the net design wind negative pressure for the components and cladding shall not be less than: (i) 45 psf (2.16 kN/m²) for the portion of the building between 200 feet (60.76 meters) to 300 feet (91.14 meters) height above ground and (ii) 40 psf (1.92 kN/m²) for the portion of the building between 100 feet (30.38 meters) to 199 feet (60.66 meters) in height above ground.]~~

~~**[1609.6.3.4 Roof.** The design pressure and suction acting over the entire roof including purlins, roofing, and other roof elements (including their fastenings) shall not be less than 30 psf (1.44 kN/m²).]~~

~~**[1609.6.3.5 Other building elements.** The following building elements of buildings whose wind loads have been determined under the provisions of Section 1609.6.3 shall be designed for wind pressures shown in Section 1609.6.3.1 multiplied by the following shape factors given in Table 1609.6.3.5.]~~

**TABLE 1609.6.3.5
OTHER BUILDING ELEMENTS**

CONSTRUCTION SHAPE FACTOR	
Signs (and their supports), or portions thereof, having 70 percent or more of solid surface	1.5
Signs (and their supports), or portions thereof, having less than 70 percent of solid surface	2.0
Tanks, cooling towers, and similar constructions	1.5
Square and rectangular chimneys	1.5

~~[1609.6.3.5.1 Eaves and cornices. Eaves, cornices, and overhanging elements of the buildings shall be designed for upward pressures twice the values given in Section 1609.6.3.1.]~~

[1609.7] 1609.5 Roof systems. Roof systems shall be designed and constructed in accordance with Sections 1609.5.1 through 1609.5.3, as applicable.

~~[1609.7.1] 1609.5.1 Roof deck. The roof deck shall be designed to withstand the wind pressures determined [under either the provisions of Section 1609.6 for buildings satisfying the height and other requirements of the simplified methods or] in accordance with Section 1609.1.1 for buildings of any height.~~

~~[1609.7.2] 1609.5.2 Roof coverings. Roof coverings shall comply with [the requirements for roof decks pursuant to] Section [1609.7.1] 1609.5.1.~~

Exceptions:

1. Rigid tile roof coverings that are air permeable and installed over a roof deck complying with Section ~~[1609.7.1]~~ 1609.5.1 are permitted to be designed in accordance with Section ~~[1609.7.3]~~ 1609.5.3.
2. Asphalt shingles installed over a roof deck complying with Section ~~[1609.7.1]~~ 1609.5.1 shall comply with the wind-resistance requirements of Section ~~[1507.2.7.1]~~ 1504.1.1.

~~[1609.7.3] 1609.5.3 Rigid tile. Wind loads on rigid tile roof coverings shall be determined in accordance with the following equation:~~

$$M_a = q_h C_L b L L_a (1.0 - G C_p) \quad \text{[(Equation 16-45)] (Equation 16-41)}$$

For SI: $M_a = q_h C_L b L L_a (1.0 - G C_p) / 1,000$

where:

b = Exposed width, feet (mm) of the roof tile.

C_L = Lift coefficient. The lift coefficient for concrete and clay tile shall be 0.2 or shall be determined by test in accordance with Section ~~[1716.2]~~ 1711.2.

$G C_p$ = Roof pressure coefficient for each applicable roof zone determined from Chapter ~~[6]~~ 30 of ASCE 7. Roof coefficients shall not be adjusted for internal pressure.

L = Length, feet (mm) of the roof tile.

L_a = Moment arm, feet (mm) from the axis of rotation to the point of uplift on the roof tile. The point of uplift shall be taken at $0.76L$ from the head of the tile and the middle of the exposed width. For roof tiles with nails or screws (with or without a tail clip), the axis of rotation shall be taken as the head of the tile for direct deck application or as the top edge of the batten for battened applications. For roof tiles fastened only by a nail or screw along the side of the tile, the axis of rotation shall be determined by testing. For roof tiles installed with battens and fastened only by a clip near the tail of the tile, the moment arm shall be determined about the top edge of the batten with consideration given for the point of rotation of the tiles based on straight bond or broken bond and the tile profile.

M_a = Aerodynamic uplift moment, feet-pounds (N-mm) acting to raise the tail of the tile.

q_h = Wind velocity pressure, psf (kN/m^2) determined from Section ~~[6.5.10]~~ 26.10.2 of ASCE 7.

Concrete and clay roof tiles complying with the following limitations shall be designed to withstand the aerodynamic uplift moment as determined by this section.

1. The roof tiles shall be either loose laid on battens, mechanically fastened, mortar set or adhesive set.
2. The roof tiles shall be installed on solid sheathing ~~[which]~~ that has been designed as components and cladding.
3. An underlayment shall be installed in accordance with Chapter 15.
4. The tile shall be single lapped interlocking with a minimum head lap of not less than 2 inches (~~[54]~~ 50.8 mm).
5. The length of the tile shall be between ~~[1.0]~~ 1 and 1.75 feet (~~[305]~~ 304.8 mm and ~~[533]~~ 533.4 mm).
6. The exposed width of the tile shall be between 0.67 and 1.25 feet (~~[204]~~ 204.2 mm and 381 mm).
7. The maximum thickness of the tail of the tile shall not exceed 1.3 inches (33 mm).
8. Roof tiles using mortar set or adhesive set systems shall have at least two-thirds of the tile's area free of mortar or adhesive contact.

~~[1609.8 Wind on temporary structures. Wind on temporary structures shall be permitted to be designed for reduced wind loading in accordance with the requirements of Section 1618.]~~

1609.6 Simplified design procedure. Use of the simplified design procedure shall comply with Sections 1609.6.1 through 1609.6.5.

1609.6.1 Scope. The procedures in Section 1609.6 shall be permitted to be used for determining and applying wind pressures in the design of enclosed buildings in Risk Category I and II as listed below:

1. For buildings located within any borough with a mean roof height of not more than 200 feet (60 960 mm) and not located in Exposure C or D in accordance with Section 1609.4, the use of Section 1609.6 shall be permitted.
2. For buildings located within the Borough of Manhattan with a mean roof height of not more than 300 feet (91 440 mm) and not located in Exposure C or D in accordance with Section 1609.4, the use of Section 1609.6 shall be permitted.

1609.6.2 Main windforce-resisting systems. Main windforce-resisting systems shall comply with the following:

1. The building shall be designed for the following net lateral wind pressure to be applied to the horizontal projection of the building surfaces:
 - 1.1. From 0 to 100 feet (0 to 30 480 mm) elevation 32 psf (1.54 kN/m²).
 - 1.2. From 100 to 300 feet (30 480 to 91 440 mm) elevation 40 psf (1.92 kN/m²).

1609.6.3 Design wind load cases. The main windforce-resisting system of buildings, whose wind loads have been determined pursuant to Section 1609.6.1, shall be designed for wind load cases as defined below:

Case 1. Full design wind pressure acting on the projected area perpendicular to each principal axis of the structure, considered separately along each principal axis.

Case 2. Seventy-five percent of the design wind pressure acting on the projected area perpendicular to each principal axis of the structure to be applied eccentric to the center of the exposure with eccentricity equal to 15 percent of the exposure width, considered separately for each principal direction.

Case 3. Wind loading as defined in Case 1 for each orthogonal direction, but considered to act simultaneously at 75 percent of the specified value.

1609.6.4 Components and cladding. Net design wind positive and negative pressures (pressure and suction) for the components and cladding of buildings represent the net pressures (sum of internal and external) to be applied normal to each building surface. The net design wind positive and negative pressures shall not be less than 48 psf (12.30 kN/m²), except at the corners of the building with a width equivalent to 10 percent of the building's width at its side, the net design wind negative pressure for the components and cladding shall not be less than: (i) 72 psf (3.46 kN/m²) for the portion of the building between 200 feet (60 960 mm) to 300 feet (91 440 mm) height above ground and (ii) 64 psf (3.07 kN/m²) for the portion of the building between 100 feet (30 480 mm) to 199 feet (60 656 mm) in height above ground.

1609.6.5 Roof. The design pressure and suction acting over the entire roof including purlins, roofing, and other roof elements (including their fastenings) shall be not less than 48 psf (2.30 kN/m²).

1609.7 Attached canopies on buildings. Canopies attached to buildings shall comply with Section 1609.7.1 or 1609.7.2, as applicable.

TABLE 1609.7
NET PRESSURE COEFFICIENT, (GC_{pn}) FOR ATTACHED CANOPIES ON BUILDINGS
WITH $H > 60$ FT

Net Pressure Coefficient (GC_{pn})	h/h_c						
	<u>2</u>	<u>3</u>	<u>6</u>	<u>12</u>	<u>18</u>	<u>24</u>	<u>30</u>
Upward	<u>-0.60</u>	<u>-0.70</u>	<u>-0.95</u>	<u>-1.04</u>	<u>-1.16</u>	<u>-1.3</u>	<u>-1.3</u>
Downward	<u>0.90</u>	<u>0.90</u>	<u>0.90</u>	<u>0.90</u>	<u>0.90</u>	<u>0.90</u>	<u>0.90</u>

For SI: 1 foot = 304.8 mm.

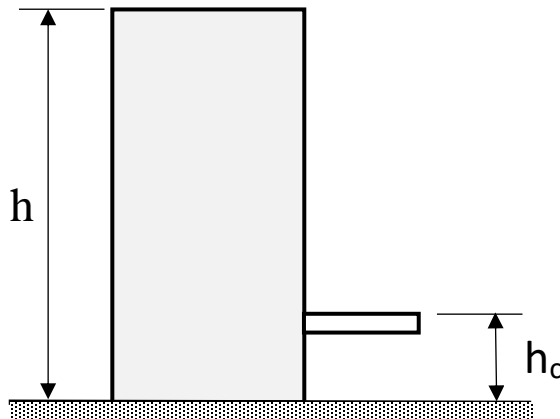

Figure 1609.7 Schematic of attached canopy on buildings with $h > 60$ ft.

1609.7.1 Buildings with $h \leq 60$ ft. The design wind pressure for canopies attached to walls of buildings with $h \leq 60$ ft. shall follow Chapter 30 of ASCE 7.

1609.7.2 Buildings with $h > 60$ ft. The design wind pressure for canopies attached to walls of buildings with $h > 60$ ft. and $h_c/h < 0.5$, as shown on Figure 1609.7, shall be from the following equation:

$$P = q_h(GC_{pn}) \text{ (lb/ft}^2\text{)} \quad \text{(Equation 16-42)}$$

Where:

q_h = velocity pressure at mean roof height h per Chapter 26 of ASCE 7.

GC_{pn} = net pressure coefficient for attached canopies given in Table 1609.7.

1609.8 Wind load on structures during construction. Structures during construction shall comply with Sections 1609.8.1 and 1609.8.2.

1609.8.1 Design wind speed. Design wind speed during construction for a construction period of less than 5 years may be reduced as follows:

Unless otherwise directed by the commissioner, the basic design wind speed may be reduced to 110 mph for all risk categories, corresponding to 1.7 percent probability of exceedance in 5 years. The basic design wind speed refers to the ultimate design 3-second gust wind speed at 33 feet (10 058.4 mm) above ground for Exposure Category C, as defined in Section 1609.3.

1609.8.2 Frameworks without cladding. For unenclosed frames and elements, the appropriate drag factors and wind effect on successive elements shall be accounted for per recognized standards and references, or in accordance with suitable wind tunnel testing.

**SECTION BC 1610
SOIL LATERAL [~~LOAD~~] LOADS**

1610.1 General. Foundation walls and retaining walls shall be designed to resist lateral soil [~~and hydrostatic~~] loads. [~~The soil~~] Soil loads specified in Table 1610.1 shall be used as the minimum design lateral soil loads unless [~~specified~~] determined otherwise [~~in~~] by a geotechnical investigation [~~report prepared~~] in accordance with Section [~~1802~~] 1803. Foundation walls and other walls in which horizontal movement is restricted at the top shall be designed for at-rest pressure. Retaining walls free to move and rotate at the top [~~are~~] shall be permitted to be designed for active pressure. Design lateral pressure from [~~hydrostatic, dynamic, or~~] surcharge loads shall be added to the lateral earth pressure load [~~, as applicable. For hydrostatic lateral pressure, see Section 1806.2~~]. Design lateral pressure shall be increased if soils at the site are expansive. Foundation walls shall be designed to support the weight of the full hydrostatic pressure of undrained backfill unless a drainage system is installed in accordance with Sections 1805.4.2 and 1805.4.3.

Exception: Foundation walls extending not more than 8 feet (~~2438~~) 2438.4 mm) below grade and laterally supported at the top by flexible diaphragms shall be permitted to be designed for active pressure.

**TABLE 1610.1
[~~SOIL~~] LATERAL SOIL LOAD**

DESCRIPTION OF BACKFILL MATERIAL ^c	UNIFIED SOIL CLASSIFICATION	DESIGN LATERAL SOIL LOAD ^a (pound per square foot per foot of depth)	
		Active pressure	At-rest pressure
Well-graded, clean gravels; gravel-sand mixes	GW	30	60
Poorly graded clean gravels; gravel-sand mixes	GP	30	60
Silty gravels, poorly graded gravel-sand mixes	GM	40	60

Clayey gravels, poorly graded gravel-and-clay mixes	GC	45	60
Well-graded, clean sands; gravelly sand mixes	SW	30	60
Poorly graded clean sands; sand-gravel mixes	SP	30	60
Silty sands, poorly graded sand-silt mixes	SM	45	60
Sand-silt clay mix with plastic fines	SM-SC	45	100
Clayey sands, poorly graded sand-clay mixes	SC	60	100
Inorganic silts and clayey silts	ML	45	100
Mixture of inorganic silt and clay	ML-CL	60	100
Inorganic clays of low to medium plasticity	CL	60	100
Organic silts and silt clays, low plasticity	OL	Note b	Note b
Inorganic clayey silts, elastic silts	MH	Note b	Note b
Inorganic clays of high plasticity	CH	Note b	Note b
Organic clays and silty clays	OH	Note b	Note b

For SI: 1 pound per square foot per foot of depth = 0.157 kPa/m, 1 foot = 304.8 mm.

- Design lateral soil loads are given for moist conditions for the specified soils at their optimum densities. Actual field conditions shall govern. Submerged or saturated soil pressures shall include the weight of the buoyant soil plus the hydrostatic loads.
- Unsuitable as backfill material.
- The definition and classification of soil materials shall be in accordance with ASTM D 2487.

SECTION BC 1611 RAIN LOADS

1611.1 Design rain loads. Each portion of a roof shall be designed to sustain the load of rainwater that will accumulate on it if the primary drainage system for that portion is blocked plus the uniform load caused by water that rises above the inlet of the secondary drainage system at its design flow.

$$R = 5.2 (d_s + d_h) \quad \text{[(Equation 16-46)] (Equation 16-43)}$$

$$\text{[For SI: } R = 0.0098(d_s + d_h)\text{]}$$

$$\text{For SI: } R = 0.0098 (d_s + d_h)$$

where:

d_h = Additional depth of water on the undeflected roof above the inlet of secondary drainage system at its design flow (i.e., the hydraulic head), in inches (mm).

d_s = Depth of water on the undeflected roof up to the inlet of secondary drainage system when the primary drainage system is blocked (i.e., the static head), in inches (mm).

R = Rain load on the undeflected roof, in psf (kN/m²). When the phrase “undeflected roof” is used, deflections from loads (including dead loads) shall not be considered when determining the amount of rain on the roof.

1611.2 Ponding instability. ~~[For roofs with a slope less than ¼ inch per foot [(1.19 degrees (0.0208 rad))], the design calculations shall include verification of adequate stiffness to preclude progressive deflection in accordance with Section 8.4 of ASCE 7.]~~ Susceptible bays of roofs shall be evaluated for ponding instability in accordance with Section 8.4 ASCE 7.

1611.3 Controlled drainage. Roofs equipped with hardware to control the rate of drainage shall be equipped with a secondary drainage system at a higher elevation that limits accumulation of water on the roof above that elevation. Such roofs shall be designed to sustain the load of rainwater that will accumulate on them to the elevation of the secondary drainage system plus the uniform load caused by water that rises above the inlet of the secondary drainage system at its design flow determined from Section 1611.1. Such roofs shall also be checked for ponding instability in accordance with Section 1611.2.

SECTION BC 1612 FLOOD LOADS

1612.1 General. ~~[The requirements for flood loads shall be as specified in Appendix G of this code.]~~ Buildings and other structures located in whole or in part in flood hazard areas shall meet the requirements of Section 5.3 of ASCE 7 and Appendix G of this code. The structural design shall be based on the design loads stated in Section 5.4 of ASCE 7, the load combinations of Section 1605, and Appendix G of this code.

1612.2 Reserved.

1612.3 Reserved.

1612.4 Reserved.

1612.5 Reserved.

SECTION BC 1613 EARTHQUAKE LOADS

1613.1 Scope. Every structure, and portion thereof, including nonstructural components that are permanently attached to structures and their supports and attachments, shall be designed and constructed to resist the effects of earthquake motions in accordance with ASCE 7[-10], excluding Chapter 14 and Appendix 11A. The seismic design category for a structure shall be determined in accordance with either Section 1613 or ASCE 7[-10].

Exceptions:

1. One- and two-family dwellings three stories or less in height.
2. The ~~[seismic force-resisting]~~ seismic force-resisting system of wood-frame buildings that conform to the provisions of Section 2308 are not required to be analyzed as specified in this section.
3. Agricultural storage structures intended only for incidental human occupancy.
4. Structures that require special consideration of their response characteristics and environment that are not addressed by this code or ASCE 7[-10] and for which other regulations provide seismic criteria, such as vehicular bridges, electrical transmission towers, hydraulic structures, buried utility lines and their appurtenances and nuclear reactors.

~~[1613.1.1 Seismic importance factor. The value for the seismic load importance factor, I, used in the calculation of E shall be determined in accordance with Table 1604.5.2 based on the Risk Category determined in accordance with Table 1604.5.]~~

~~[1613.1] 1613.2 Definitions. The following [words and terms shall, for the purposes of this section, have the meanings shown herein.] terms are defined in Chapter 2:~~

~~DESIGN EARTHQUAKE GROUND MOTION. [The earthquake ground motion that buildings and structures are specifically proportioned to resist in Section 1613.]~~

~~MAXIMUM CONSIDERED EARTHQUAKE (MCE) GROUND MOTION. [The most severe earthquake effects considered by this standard more specifically defined in the following two terms.]~~

~~MAXIMUM CONSIDERED EARTHQUAKE GEOMETRIC MEAN (MCE_G) PEAK GROUND [ACCELERATIONS] ACCELERATION. [The most severe earthquake effects considered by this standard determined for geometric mean peak ground acceleration and without adjustment for targeted risk. The MCE_G peak ground acceleration adjusted for site effects (PGA_M) is used in this standard for evaluation of liquefaction, lateral spreading, seismic settlements, and other soil-related issues. The PGA_M values adjusted for site effects are provided in Table 1813.2.1 or can be derived from the site-specific procedures provided in Section 21.5 of ASCE 7-10.]~~

~~[RISK-TARGETED MAXIMUM CONSIDERED EARTHQUAKE (MCE_R) GROUND MOTION RESPONSE ACCELERATIONS. The most severe earthquake effects considered by this standard determined for the orientation that results in the largest maximum response for horizontal ground motions and with adjustment for targeted risk. The MCE_R Ground Motion values can be determined from general procedure in Section 1613.5.3 or can be derived from the site-specific procedures provided in Sections 21.1 and 21.2 of ASCE 7-10.]~~

~~MECHANICAL SYSTEMS. [For the purposes of determining seismic loads in ASCE 7-10, mechanical systems shall also include fire protection, plumbing and fuel gas systems as specified therein.]~~

~~ORTHOGONAL. [To be in two horizontal directions, at 90 degrees (1.57 rad) to each other.]~~

~~RISK-TARGETED MAXIMUM CONSIDERED EARTHQUAKE (MCE_R) GROUND MOTION RESPONSE ACCELERATIONS.~~

~~SEISMIC DESIGN CATEGORY.[A classification assigned to a structure based on its risk category and the severity of the design earthquake ground motion at the site.]~~

~~[SEISMIC FORCE-RESISTING] SEISMIC FORCE-RESISTING SYSTEM.[The part of the structural system that has been considered in the design to provide the required resistance to the prescribed seismic forces.]~~

~~SITE CLASS. [A classification assigned to a site based on the types of soils present and their engineering properties as defined in Section 1613.5.2.]~~

~~SITE COEFFICIENTS.[The values of, F_a, and, F_v, indicated in Tables 1613.5.3(1) and 1613.5.3(2), respectively.]~~

[1613.3 Reserved.]

[1613.4 Reserved.]

[1613.5] **1613.3 Seismic ground motion values.** Seismic ground motion values shall be determined in accordance with this section.

[1613.5.1] **1613.3.1 Mapped acceleration parameters.** The mapped maximum considered earthquake spectral response acceleration at short periods (S_s) shall be ~~[0.284]~~ 0.296 g and at ~~[1-second]~~ 1-s period (S_1) shall be ~~[0.073]~~ 0.061 g. The mapped long-period transition period (T_L) shall be ~~[6]~~ 6.0 seconds. Alternatively, electronic values of mapped acceleration parameters S_s and S_1 and other seismic design parameters provided at the U.S. Geological Survey (USGS) website at <https://doi.org/10.5066/F7NK3C76> may be used as per the guidelines of ASCE 7, Section 11.4.

[1613.5.2] **1613.3.2 Site class definitions.** Based on the site soil properties, the site shall be classified as ~~[either]~~ Site Class A, B, C, D, E or F in accordance with ~~[Table 1613.5.2]~~ Chapter 20 of ASCE 7, and this code. Where the soil properties are not known in sufficient detail to determine the site class, Site Class D shall be used unless the commissioner or geotechnical data determines ~~[that]~~ Site Class E or F ~~[soil is]~~ soils are present at the site.

**TABLE 1613.5.2
SITE CLASS DEFINITIONS**

SITE CLASS	SOIL PROFILE NAME	AVERAGE PROPERTIES IN TOP 100 feet, SEE SECTION 1613.5.5		
		Soil shear wave velocity, \bar{v}_s (ft/s)	Standard penetration resistance, \bar{N}	Soil undrained shear strength, \bar{s}_{ur} (psf)
A	Hard rock	$\bar{v}_s > 5,000$	N/A	N/A
B	Rock	$2,500 < \bar{v}_s \leq 5,000$	N/A	N/A
C	Very dense soil and soft rock	$1,200 < \bar{v}_s \leq 2,500$	$\bar{N} > 50$	$\bar{s}_{ur} \geq 2,000$
D	Stiff soil profile	$600 \leq \bar{v}_s \leq 1,200$	$15 \leq \bar{N} \leq 15$	$1,000 \leq \bar{s}_{ur} \leq 2,000$
E	Soft soil profile	$\bar{v}_s < 600$	$\bar{N} < 15$	$\bar{s}_{ur} < 1,000$
E	—	Any profile with more than 10 feet of soil having the following characteristics: 1. Plasticity index $PI > 20$, 2. Moisture content $w \geq 40\%$, and 3. Undrained shear strength $s_{ur} < 500$ psf		
F	—	Any profile containing soils having one or more of the following characteristics: 1. Soils vulnerable to potential failure or collapse under seismic loading such as liquefiable soils, quick and highly sensitive clays, collapsible weakly cemented soils. 2. Peats and/or highly organic clay ($H > 10$ feet of peat and/or highly organic clay		

		where H = thickness of soil) 3. Very high plasticity clays ($H > 25$ feet with plasticity index $PI > 75$) 4. Very thick soft/medium stiff clays ($H > 120$ feet)
--	--	--

For SI: 1 foot = 304.8 mm, 1 square foot = 0.0929m², 1 pound per square foot = 0.0479 kPa. N/A = Not applicable]

[1613.5.3] 1613.3.3 Site coefficients and [risk-targeted] adjusted maximum considered earthquake [MCE_R] spectral response acceleration parameters. The [MCE_R] maximum considered earthquake spectral response acceleration [parameters] for short periods, S_{MS} , and at 1-second period, S_{M1} , adjusted for site class effects shall be determined by Equations [16-47] 16-44 and [16-48] 16-45, respectively:

$$S_{MS} = F_a S_s \quad \text{[(Equation 16-47)] (Equation 16-44)}$$

$$S_{M1} = F_v S_1 \quad \text{[(Equation 16-48)] (Equation 16-45)}$$

where:

F_a = Site coefficient defined in Table [1613.5.3(1)] 1613.3.3(1).

F_v = Site coefficient defined in Table [1613.5.3(2)] 1613.3.3(2).

S_s = The mapped MCER spectral accelerations for short periods as determined in Section [1613.5.1] 1613.3.1.

S_1 = The mapped MCER spectral accelerations for a 1-s period as determined in Section [1613.5.1] 1613.3.1.

Exception: When electronic values of mapped acceleration parameters are used as per Section 1613.3.1 of this code, the site coefficients, F_a and F_v , cannot be taken from Tables 1613.3.3(1) and 1613.3.3(2) of this code. Rather, general procedures in Chapter 11 of ASCE 7 shall be followed to determine F_a and F_v .

TABLE [1613.5.3(1)] 1613.3.3(1)
VALUES OF SITE COEFFICIENT F_a AS A FUNCTION OF SITE CLASS AND MAPPED SPECTRAL RESPONSE ACCELERATION AT SHORT PERIODS (S_S)^a

SITE CLASS	F_a
A	0.80
<u>B (V_s measured)</u>	<u>0.90</u>
B (V_s unmeasured)	1.00
C	[1-29] <u>1.30</u>
D	1.57
E	[2-37] <u>2.28</u>
F	Note a

a. Site-specific geotechnical investigation and dynamic site response analyses shall be performed to determine appropriate values, except that for structures with periods of vibration equal or less than 0.5 second, values of F_a for liquefiable soils are permitted to be taken equal to the values for the site class determined without regard to liquefaction in Section [1613.5.5] 1613.3.4.1.

**TABLE ~~[1613.5.3(2)] 1613.3.3(2)~~
VALUES OF SITE COEFFICIENT F_v AS A FUNCTION OF SITE CLASS AND MAPPED SPECTRAL RESPONSE ACCELERATION AT 1-SECOND PERIOD (S_I)^a**

SITE CLASS	F_v
A	0.80
<u>B (V_s measured)</u>	<u>0.90</u>
B (V_s unmeasured)	1.00
C	[1.70] <u>1.50</u>
D	2.40
E	[3.50] <u>4.20</u>
F	Note a

- a. Site-specific geotechnical investigation and dynamic site response analyses shall be performed to determine appropriate values, except that for structures with periods of vibration equal or less than 0.5 second, values of F_v for liquefiable soils are permitted to be taken equal to the values for the site class determined without regard to liquefaction in Section ~~[1613.5.5]~~ 1613.3.4.1.

~~[1613.5.4] 1613.3.4~~ Design spectral response acceleration parameters. Five-percent damped design spectral response acceleration at short periods, S_{DS} , and at ~~[1-second]~~ 1-s period, S_{D1} , shall be determined from ~~[Equation 16-49]~~ Equations 16-46 and ~~[16-50]~~ 16-47, respectively:

$$S_{DS} = \frac{2}{3} S_{MS} \quad \text{[~~(Equation 16-49)] (Equation 16-46)~~}$$

$$S_{D1} = \frac{2}{3} S_{M1} \quad \text{[~~(Equation 16-50)] (Equation 16-47)~~}$$

S_{ms} = The MCE_R spectral response accelerations for short periods as determined in Section ~~[1613.5.3]~~ 1613.3.3.

S_{m1} = The MCE_R spectral response accelerations for a 1-second period as determined in Section ~~[1613.5.3]~~ 1613.3.3.

~~[1613.5.5] 1613.3.4.1~~ Site classification for seismic design. Site classification for Site Class C, D or E shall be determined from Table ~~[1613.5.5]~~ 1613.3.4.1. The notations presented below apply to only materials encountered above rock meeting Class 1a, 1b, or 1c as defined in Section ~~[1804]~~ 1803 or rock with shear wave velocity greater than ~~[2500]~~ 2,500 feet per second (762 meters per second) to a maximum depth of 100 feet (30 480 mm). Profiles containing distinctly different soil and rock layers shall be subdivided into those layers designated by a number that ranges from 1 to n at the bottom where there is a total of n distinct layers in the upper 100 feet (30 480 mm). The symbol i then refers to any one of the layers between 1 and n. For situations in which site investigations, performed in accordance with Chapter 20 of ASCE 7, reveal rock conditions consistent with Site Class B, but site-specific velocity measurements are not made, the site coefficients F_a , F_v , and F_{PGA} shall be taken as unity (1.0).

where:

v_{si} = The shear wave velocity in feet per second (m/s).

d_i = The thickness of any layer between 0 and 100 feet (30 480 mm).

[(Equation 16-51)] (Equation 16-48)

$$v_s = \frac{\sum_{i=1}^n d_i}{\sum_{i=1}^n v_{si}}$$

$$\sum_{i=1}^n d_i = 100 \text{ feet (30 480 mm)}$$

where:

N_i is the Standard Penetration Resistance (ASTM D1586) not to exceed 100 blows/foot (328 blows/m) as directly measured in the field without corrections. When refusal is met for a rock layer of Class 1d, N_i shall be less than or equal to 100 blows/foot (328 blows/m) provided that the extent of the Class 1d material is confirmed by a boring to a depth where Class 1c or better rock is determined, not to exceed 100 feet (30 480 mm). Alternatively, if this boring is not performed, site classification should be based on all soil material that is above the Class 1d layer.

[(Equation 16-52)] (Equation 16-49)

$$\bar{N} = \frac{\sum_{i=1}^n d_i}{\sum_{i=1}^n \frac{d_i}{N_i}}$$

[(Equation 16-53)] (Equation 16-50)

$$\bar{N}_{ch} = \frac{d_s}{\sum_{i=1}^m \frac{d_i}{N_i}}$$

where:

$$\sum_{i=1}^m d_i = d_s$$

Use d_i and N_i for cohesionless soil layers only in Equation [16-42] 16-50.

d_s = The total thickness of cohesionless soil layers in the top 100 feet (30 480 mm).

m = The number of cohesionless soil layers in the top 100 feet (30 480 mm).

S_{ui} = The undrained shear strength in psf (kPa), not to exceed 5,000 psf (240 kPa), ASTM D 2166 or ASTM D 2850.

$$\bar{S}_u = \frac{d_c}{\sum_{i=1}^k \frac{d_i}{S_{ui}}}$$

where:

$$\sum_{i=1}^k d_i = d_c$$

d_c = The total thickness (100- d_s) (For SI: 30 480- d_s) of cohesive soil layers in the top 100 feet (30 480 mm).

k = The number of cohesive soil layers in the top 100 feet (30 480 mm).

PI = The plasticity index, ASTM D 4318.

w = The moisture content in percent, ASTM D 2216.

Where a site does not qualify under the criteria for Site Class F and there is a total thickness of soft clay greater than 10 feet (3048 mm) where a soft clay layer is defined by $s_u < 500$ psf (24 kPa), $w \geq 40$ percent, and $PI > 20$, it shall be classified as Site Class E. The shear wave velocity for rock, Site Class B, shall be either measured on site or estimated by a geotechnical engineer or engineering geologist/seismologist for competent rock with moderate fracturing and weathering. Softer and more highly fractured and weathered rock shall either be measured on site for shear wave velocity or classified as Site Class C. The hard rock category, Site Class A, shall be supported by shear wave velocity measurements either on site or on profiles of the same rock type in the same formation with an equal or greater degree of weathering and fracturing. Where hard rock conditions are known to be continuous to a depth of 100 feet (30 480 mm), surficial shear wave velocity measurements are permitted to be extrapolated to assess v_s . The rock categories, Site Classes A and B, shall not be used if there is more than 10 feet (3048 mm) of soil between the rock surface and the bottom of the spread footing or mat foundation.

**TABLE [1613.5.5] 1613.3.4.1
SITE CLASSIFICATION^A**

SITE CLASS	\bar{v}_s	\bar{N} or \bar{N}_{ch}	\bar{s}_v
E	< 600 ft/s	< 15	< 1,000 psf
D	600 to 1,200 ft/s	15 to 50	1,000 to 2,000 psf
C	1,200 to 2,500 ft/s	> 50	> 2,000

For SI: 1 foot per second = 304.8 mm per second, 1 pound per square foot = 0.0479 kN/m².

a. If the s_v method is used and the N_{ch} and s_v criteria differ, select the category with the softer soils (for example, use Site Class E instead of D).

[1613.5.5.1] 1613.3.4.1.1 Steps for classifying a site. The following steps shall be performed during the classification of a site:

1. Check for the four categories of Site Class F requiring site-specific evaluation. If the site corresponds to any of these categories, classify the site as Site Class F and conduct a site-specific evaluation according to ASCE 7[10] and the requirements of Section [1813] 1815.
2. Check for the existence of a total thickness of soft clay > 10 feet (3048 mm) where a soft clay layer is defined by: $s_u < 500$ psf (24 kPa), $w \geq 40$ percent and $PI > 20$. If these criteria are satisfied, classify the site as Site Class E.
3. Categorize the site using one of the following three methods with v_s , N , [and] or s_u and computed in all cases as specified.

- 3.1. v_s for the top 100 feet (30 480 mm) (v_s method).
- 3.2. N for the top 100 feet (30 480 mm) (N method).
- 3.3. N_{ch} for cohesionless soil layers ($PI < 20$) in the top 100 feet (30 480 mm) and average, s_u , for cohesive soil layers ($PI > 20$) in the top 100 feet (30 480 mm) (s_u method).

[1613.5.6] 1613.3.5 Determination of seismic design category. All structures shall be assigned [to] a seismic design category based on their risk category [~~determined in accordance with Table 1604.5~~] and the design spectral response acceleration parameters, S_{DS} and S_{D1} , determined in accordance with Section [1613.5.4] 1613.3.4 of this code or the site-specific procedures of ASCE 7 [-10]. Each building and structure shall be assigned to the [more severe] seismic design category in accordance with Table [1613.5.6(1) or 1613.5.6(2)] 1613.3.5 of this code, irrespective of the fundamental period of vibration of the structure, T.

Exception: When electronic values of mapped acceleration parameters are used as per Section 1613.3.1, the seismic design category for Risk Category IV structures shall not differ from the values in Table 1613.3.5.

[TABLE 1613.5.6(1)]
SEISMIC DESIGN CATEGORY BASED ON
SHORT PERIOD (0.2 SECOND) RESPONSE ACCELERATIONS

VALUE OF S_{DS}	RISK CATEGORY ^a		
	I & H	III	IV
$S_{DS} < 0.167g$	A	A	A
$0.167g < S_{DS} < 0.33g$	B	B	C
$0.33g < S_{DS} < 0.50g$	C	C	D
$0.50g < S_{DS}$	D*	D*	D*

a. Requirements for Seismic Design Categories E and F have been eliminated from the *New York City Building Code* as such categories do not apply in New York City. References to these Seismic Design Categories can be found in ASCE 7-10.

[TABLE 1613.5.6(2)]
SEISMIC DESIGN CATEGORY BASED ON
1-SECOND PERIOD RESPONSE ACCELERATION

VALUE OF S_{D1}	RISK CATEGORY ^a		
	I & H	III	IV
$S_{D1} < 0.067g$	A	A	A
$0.067g < S_{D1} < 0.133g$	B	B	C
$0.133g < S_{D1} < 0.20g$	C	C	D

$0.20g \leq S_{DL}$	D*	D*	D*
---------------------	----	----	----

- a. Requirements for Seismic Design Categories E and F have been eliminated from the *New York City Building Code* as such categories do not apply in New York City. References to these Seismic Design Categories can be found in ASCE 7-10.]

TABLE 1613.3.5
SEISMIC DESIGN CATEGORY

<u>Risk Category</u>	<u>Site Class</u>		
	<u>A</u>	<u>B /C /D</u>	<u>E</u>
<u>I/II/III</u>	<u>A</u>	<u>B</u>	<u>C</u>
<u>IV</u>	<u>A</u>	<u>C</u>	<u>D</u>

[1613.5.6.1] 1613.3.5.1 Alternative seismic design category determination. The seismic design category is permitted to be determined from Table [1613.5.6(1)] 11.6-1 of ASCE 7 alone, except for Risk Category IV structures for which Table 1613.3.5 of this code shall be used, when all of the following apply:

1. In each of the two orthogonal directions, the approximate fundamental period of the structure, T_a , [as] in each of the two orthogonal directions determined in accordance with Section 12.8.2.1 of ASCE 7[-10], is less than $0.8 T_{s[-as]}$ determined in accordance with Section [11.4.5] 11.4.6 of ASCE 7[-10].
2. In each of the two orthogonal directions, the fundamental period of the structure used to calculate the story drift is less than T_s .
3. Equation 12.8-2 of ASCE 7[-10] is used to determine the seismic response coefficient, C_s .
4. The diaphragms are rigid[;] or are permitted to be idealized as [defined] rigid in accordance with Section 12.3.1 of ASCE 7[-10] or, for diaphragms [that are] permitted to be idealized as flexible in accordance with Section 12.3.1 of ASCE 7, the distances between [the] vertical elements of the [seismic force resisting] seismic force-resisting system do not exceed 40 feet (12 192 mm).

[1613.5.6.2] 1613.3.5.2 Simplified design procedure. Where the alternate simplified design procedure of ASCE 7[-10] is used, the seismic design category shall be determined in accordance with ASCE 7[-10].

[1613.6 Alternatives to ASCE 7-10. The provisions of Section 1613.6 shall be permitted as alternatives to the relevant provisions of ASCE 7-10.]

[1613.6.1 Additional seismic force resisting systems for seismically isolated structures. Add the following exception to the end of Section 17.5.4.2 of ASCE 7-10:]

[Exception: For isolated structures designed in accordance with this standard, the Structural System Limitations and the Structural Height Limits in Table 1613.8 for ordinary steel

concentrically braced frames (OCBFs) as defined in Chapter 11 of ASCE 7-10 and ordinary moment frames (OMFs) as defined in Chapter 11 of ASCE 7-10 are permitted to be taken as 160 feet (48 768 mm) for structures assigned to Seismic Design Category D, provided that the following conditions are satisfied:]

[1. The value of R_+ as defined in Chapter 17 of ASCE 7-10 is taken as 1.]

[2. For OMFs and OCBFs, design is in accordance with AISC 341.]

[1613.7] 1613.4 Structural separations. All structures shall be separated from adjacent structures. When a structure adjoins a property line not common to a public way (typically side or rear lot lines), that structure shall also be set back from the property line by at least 1 inch ([25] 25.4 mm) for each 50 feet (15 240 mm) of height and a minimum of 1 inch ([25] 25.4 mm) for structures with heights less than 50 feet (15 240 mm). For structures in Seismic Design Category D, refer to ASCE 7[40] for additional requirements.

Exception: Smaller separations or property line setbacks shall be permitted when justified by rational analysis based on maximum expected ground motions with a minimum separation of 1 inch ([25] 25.4 mm) along the full height of the structure.

[1613.7.1] 1613.4.1 Masonry structures. For structures adjacent to existing unreinforced masonry bearing wall structures, the structural separation shall be filled with a material with a minimum compressive strength of 25 psi (172.37 kPa) and a maximum compressive strength of 100 psi (689.74 kPa). Additionally, when the adjacent wall is a party wall, the party wall shall be made secure by the party responsible for the new construction as per Chapter 33.

[1613.7.2] 1613.4.2 Covers. The infill material shall be covered on all sides and shall meet the appropriate provisions of Chapter 26. The covering must be of adequate strength to resist the wind loads for cladding as specified in Chapter 16 and shall conform to all applicable provisions in Chapter 14.

[1613.7.3] 1613.4.3 Covers wider than 5 inches (127 mm). When a building separation wider than 5 inches (127 mm) is created pursuant to Section [1613.7] 1613.4, such separation, at the roof level of the proposed new building, or at the roof level of an existing adjoining building where if that building is lower than the proposed new building, shall have a horizontal cover/closure that conforms with the following:

1. The cover/closure material shall be noncombustible; and

Exception: The cover/closure material used shall be permitted to be combustible material in accordance with Section [1509.9] 1510.9 if all the material on the appropriate roof conforms to the limitations therein, there are no masonry openings in either wall abutting the building separation, and both buildings are noncombustible.

2. The cover/closure shall be capable of withstanding the roof live load of 30 psf (1.43 kPa), securely fastened to the new building, and be of a type that would be capable of preventing unauthorized or accidental access to the space.

[1613.8] **1613.5** ASCE 7[-10], Table 12.2-1. Modify ASCE 7[-10], Table 12.2-1 as follows:

TABLE [1613.8] 1613.5
DESIGN COEFFICIENT AND FACTORS FOR BASIC SEISMIC C-FORCE-RESISTING SYSTEMS

					Structural System Limitations Including Structural Height, h_n (ft), Limits ^c		
Seismic Force-Resisting System	ASCE 7[-10] Section Where Detailing Requirements Are Specified	Response Modification Coefficient	Overstrength Factor	Deflection Amplification Factor	Seismic Design Category		
A. BEARING WALL SYSTEMS		R^a	Ω_0^g	C_d^b	B	C	D^d
1. Special reinforced concrete shear walls ^{1,m}	14.2	5	2.5	5	NL	NL	[NL] 160
2. Ordinary reinforced concrete shear walls ¹	14.2	4	2.5	4	NL	NL	NP
3. Detailed plain concrete shear walls ¹	14.2	2	2.5	2	NL	NP	NP
4. Ordinary plain concrete shear walls ¹	14.2	1.5	2.5	1.5	NL	NP	NP
5. Intermediate precast shear walls ¹	14.2	4	2.5	4	NL	NL	40 ^k
6. Ordinary precast shear walls ¹	14.2	3	2.5	3	NL	NP	NP
7. Special reinforced masonry shear walls	14.4	5	2.5	3.5	NL	NL	[NL] 160
8. Intermediate reinforced masonry shear walls	14.4	3.5	2.5	2.25	NL	NL	NP
9. Ordinary reinforced masonry shear walls	14.4	2	2.5	1.75	NL	[NL] 160	NP
10. Detailed plain masonry shear walls	14.4	2	2.5	1.75	NL	NP	NP
11. Ordinary plain masonry shear walls	14.4	1.5	2.5	1.25	NL	NP	NP
12. Prestressed masonry shear walls	14.4	1.5	2.5	1.75	NL	NP	NP

13. Ordinary reinforced Autoclaved Aerated Concrete (AAC) masonry shear walls	14.4	2	2.5	2	NL	35	NP
14. Ordinary plain (unreinforced) Autoclaved Aerated Concrete (AAC) masonry shear walls	14.4	1.5	2.5	1.5	NL	NP	NP
15. Light-frame (wood) walls sheathed with wood structural panels rated for shear resistance or steel sheets	14.1 and 14.5	6.5	3	4	NL	NL	65
16. Light-frame (cold-formed steel) walls sheathed with wood structural panels rated for shear resistance or steel sheets	14.1	6.5	3	4	NL	NL	65
17. Light-frame walls with shear panels of all other materials	14.1 and 14.5	2	2.5	2	NL	NL	35
18. Light-frame (cold-formed steel) wall systems using flat strap bracing	14.1	4	2	3.5	NL	NL	65
B. BUILDING FRAME SYSTEMS		R^a	Ω_0^g	C_d^b	B	C	D^d
1. Steel eccentrically braced frames	14.1	8	2	4	NL	NL	[NL] 160
2. Steel special concentrically braced frames	14.1	6	2	5	NL	NL	[NL] 160
3. Steel ordinary concentrically braced frames	14.1	3.25	2	3.25	NL	NL	35 ^j
4. Special reinforced concrete shear walls ^{l,m}	14.2	6	2.5	5	NL	NL	[NL] 160
5. Ordinary reinforced concrete shear walls ^l	14.2	5	2.5	4.5	NL	NL	NP
6. Detailed plain concrete shear walls ^l	14.2 and [14.2.2.8] 14.2.2.7	2	2.5	2	NL	NP	NP
7. Ordinary plain concrete shear walls ^l	14.2	1.5	2.5	1.5	NL	NP	NP
8. Intermediate precast shear walls ^l	14.2	5	2.5	4.5	NL	NL	40 ^k
9. Ordinary precast shear walls ^l	14.2	4	2.5	4	NL	NP	NP
10. Steel and concrete composite eccentrically braced frames	14.3	8	[2] 2.5	4	NL	NL	[NL] 160
11. Steel and concrete composite special concentrically braced frames	14.3	5	2	4.5	NL	NL	[NL] 160
12. Steel and concrete composite ordinary braced frames	14.3	3	2	3	NL	NL	NP
13. Steel and concrete composite plate shear walls	14.3	6.5	2.5	5.5	NL	NL	[NL] 160
14. Steel and concrete composite special shear walls	14.3	6	2.5	5	NL	NL	[NL] 160

15. Steel and concrete composite ordinary shear walls	14.3	5	2.5	4.5	NL	NL	NP
16. Special reinforced masonry shear walls	14.4	5.5	2.5	4	NL	NL	[NL] 160
17. Intermediate reinforced masonry shear walls	14.4	4	2.5	4	NL	NL	NP
18. Ordinary reinforced masonry shear walls	14.4	2	2.5	2	NL	[NL] 160	NP
19. Detailed plain masonry shear walls	14.4	2	2.5	2	NL	NP	NP
20. Ordinary plain masonry shear walls	14.4	1.5	2.5	1.25	NL	NP	NP
21. Prestressed masonry shear walls	14.4	1.5	2.5	1.75	NL	NP	NP
22. Light-frame (wood) walls sheathed with wood structural panels rated for shear resistance	14.5	7	2.5	4.5	NL	NL	65
23. Light-frame (cold-formed steel) walls sheathed with wood structural panels rated for shear resistance or steel sheets	14.1	7	2.5	4.5	NL	NL	65
24. Light-frame walls with shear panels of all other materials	14.1 and 14.5	2.5	2.5	2.5	NL	NL	35
25. Steel buckling-restrained braced frames	14.1	8	2.5	5	NL	NL	[NL] 160
26. Steel special plate shear walls	14.1	7	2	6	NL	NL	[NL] 160
C. MOMENT-RESISTING FRAME SYSTEMS		R^a	Ω_0^g	C_d^b	B	C	D^d
1. Steel special moment frames	14.1 and 12.2.5.5	8	3	5.5	NL	NL	NL
2. Steel special truss moment frames	14.1	7	3	5.5	NL	NL	[NL] 160
3. Steel intermediate moment frames	14.1 and 12.2.5.7	4.5	3	4	NL	NL	35 ^h
4. Steel ordinary steel moment frames	14.1 and 12.2.5.6	3.5	3	3	NL	NL	NP ⁱ
5. Special reinforced concrete moment frames ⁿ	14.2 and 12.2.5.5	8	3	5.5	NL	NL	NL
6. Intermediate reinforced concrete moment frames	14.2	5	3	4.5	NL	NL	NP
7. Ordinary reinforced concrete moment frames	14.2	3	3	2.5	NL	NP	NP
8. Steel and concrete composite special moment frames	14.3 and 12.2.5.5	8	3	5.5	NL	NL	NL
9. Steel and concrete composite intermediate moment frames	14.3	5	3	4.5	NL	NL	NP
10. Steel and concrete composite partially restrained moment frames	14.3	6	3	5.5	[NL] 160	[NL] 160	100
11. Steel and concrete composite ordinary moment frames	14.3	3	3	2.5	NL	NP	NP
12. Cold-formed steel—special bolted moment frame ^p	14.1	3.5	3 ^o	3.5	35	35	35

D. DUAL SYSTEMS WITH SPECIAL MOMENT FRAMES CAPABLE OF RESISTING AT LEAST 25% OF PRESCRIBED SEISMIC FORCES	12.2.5.1	R^a	Ω_0^g	C_d^b	B	C	D^d
1. Steel eccentrically braced frames	14.1	8	2.5	4	NL	NL	NL
2. Steel special concentrically braced frames	14.1	7	2.5	5.5	NL	NL	NL
3. Special reinforced concrete shear walls ^l	14.2	7	2.5	5.5	NL	NL	NL
4. Ordinary reinforced concrete shear walls ^l	14.2	6	2.5	5	NL	NL	NP
5. Steel and concrete composite eccentrically braced frames	14.3	8	2.5	4	NL	NL	NL
6. Steel and concrete composite special concentrically braced frames	14.3	6	2.5	5	NL	NL	NL
7. Steel and concrete composite plate shear walls	14.3	7.5	2.5	6	NL	NL	NL
8. Steel and concrete composite special shear walls	14.3	7	2.5	6	NL	NL	NL
9. Steel and concrete composite ordinary shear walls	14.3	6	2.5	5	NL	NL	NP
10. Special reinforced masonry shear walls	14.4	5.5	3	5	NL	NL	NL
11. Intermediate reinforced masonry shear walls	14.4	4	3	3.5	NL	NL	NP
12. Steel buckling-restrained braced frames	14.1	8	2.5	5	NL	NL	NL
13. Steel special plate shear walls	14.1	8	2.5	6.5	NL	NL	NL
E. DUAL SYSTEMS WITH INTERMEDIATE MOMENT FRAMES CAPABLE OF RESISTING AT LEAST 25% OF PRESCRIBED SEISMIC FORCES	12.2.5.1	R^a	Ω_0^g	C_d^b	B	C	D^d
1. Steel special concentrically braced frames ^f	14.1	6	2.5	5	NL	NL	35
2. Special reinforced concrete shear walls ^l	14.2	6.5	2.5	5	NL	NL	NL 160
3. Ordinary reinforced masonry shear walls	14.4	3	3	2.5	NL	NL 160	NP
4. Intermediate reinforced masonry shear walls	14.4	3.5	3	3	NL	NL	NP
5. Steel and concrete composite special concentrically braced frames	14.3	5.5	2.5	4.5	NL	NL	NL
6. Steel and concrete composite ordinary braced frames	14.3	3.5	2.5	3	NL	NL	NP

7. Steel and concrete composite ordinary shear walls	14.3	5	3	4.5	NL	NL	NP
8. Ordinary reinforced concrete shear walls ^l	14.2	5.5	2.5	4.5	NL	NL	NP
F. SHEAR WALL-FRAME INTERACTIVE SYSTEM WITH ORDINARY REINFORCED CONCRETE MOMENT FRAMES AND ORDINARY REINFORCED CONCRETE SHEAR WALLS^l	14.2 and 12.2.5.8	4.5	2.5	4	NL	NP	NP
G. CANTILEVERED COLUMN SYSTEMS DETAILED TO CONFORM TO THE REQUIREMENTS FOR:	12.2.5.2	R^a	Ω_0^g	C_d^b	B	C	D^d
1. Steel special cantilever column systems	14.1	2.5	1.25	2.5	35	35	35
2. Steel ordinary cantilever column systems	14.1	1.25	1.25	1.25	35	35	NP ⁱ
3. Special reinforced concrete moment frames ⁿ	14.2 and 12.2.5.5	2.5	1.25	2.5	35	35	35
4. Intermediate reinforced concrete moment frames	14.2	1.5	1.25	1.5	35	35	NP
5. Ordinary reinforced concrete moment frames	14.2	1	1.25	1	35	NP	NP
6. Timber frames	14.5	1.5	1.5	1.5	35	35	35
H. STEEL SYSTEMS NOT SPECIFICALLY DETAILED FOR SEISMIC RESISTANCE, EXCLUDING CANTILEVER COLUMN SYSTEMS	14.1	3	3	3	NL	NL	NP

- a. Response modification coefficient, R , for use throughout the standard. Note R reduces forces to a strength level, not an allowable stress level.
- b. Deflection amplification factor, C_d , for use in Sections 12.8.6, 12.8.7, and [12.9.2] 12.9.1.2 of ASCE 7[-40].
- c. NL = Not Limited and NP = Not Permitted. For metric units use 30.5 m for 100 ft and use 48.8 m for 160 ft.
- d. See Section 12.2.5.4 of ASCE 7[-40] for a description of seismic force-resisting systems limited to buildings with a structural height, h_n , of 240 ft (73.2 m) or less.
- e. See Section 12.2.5.4 of ASCE 7[-40] for seismic force-resisting systems limited to buildings with a structural height, h_n , of 160 ft (48.8 m) or less.
- f. Ordinary moment frame is permitted to be used in lieu of intermediate moment frame for Seismic Design Categories B or C.
- g. Where the tabulated value of the overstrength factor, Ω_0 , is greater than or equal to $2\frac{1}{2}$, Ω_0 is permitted to be reduced by subtracting the value of $1/2$ for structures with flexible diaphragms.
- h. See Section 12.2.5.7 of ASCE 7[-40] for limitations in structures assigned to Seismic Design Category D.
- i. See Section 12.2.5.6 of ASCE 7[-40] for limitations in structures assigned to Seismic Design Category D.
- j. Steel ordinary concentrically braced frames are permitted in single-story buildings up to a structural height, h_n , of 60 ft (18.3 m) where the dead load of the roof does not exceed 20 psf (0.96 kN/m²) and in penthouse structures.
- k. An increase in structural height, h_n , to 45 ft (13.7 m) is permitted for single story storage warehouse facilities.
- l. In Section [2-2] 2.3 of ACI 318. A shear wall is defined as a structural wall.
- m. In Section [2-2] 2.3 of ACI 318. The definition of "special structural wall" includes precast and cast-in-place construction.
- n. In Section [2-2] 2.3 of ACI 318. The definition of "special moment frame" includes precast and cast-in-place construction.
- o. Alternately, the seismic load effect with overstrength, E_{mb} , is permitted to be based on the expected strength determined in accordance with AISI [S440] S400.
- p. Cold-formed steel – special bolted moment frames shall be limited to one-story in height in accordance with AISI [S440] S400.

1613.6 Ballasted photovoltaic panel systems. Ballasted, roof-mounted photovoltaic panel systems need not be rigidly attached to the roof or supporting structure. Ballasted non-penetrating systems shall be designed and installed only on roofs with slopes not more than one unit vertical in 12 units horizontal. Ballasted nonpenetrating systems shall be designed to resist sliding and uplift resulting from lateral and vertical forces as required by Section 1605 of this code, using a coefficient of friction

determined by acceptable engineering principles. In structures assigned to Seismic Design Category C or D, ballasted nonpenetrating systems shall be designed to accommodate seismic displacement determined by nonlinear response-history analysis or shake-table testing, using input motions consistent with ASCE 7 lateral and vertical seismic forces for nonstructural components on roofs.

SECTION BC 1614 **ATMOSPHERIC ICE LOADS**

1614.1 General. Ice-sensitive structures shall be designed for atmospheric ice loads in accordance with Chapter 10 of ASCE 7.

SECTION BC [1614] 1615 **STRUCTURAL INTEGRITY DEFINITIONS**

[1614.1] 1615.1 Definitions. The following [~~words and terms shall, for the purposes of this section, have the meanings shown herein.~~] terms are defined in Chapter 2:

ALTERNATE LOAD PATH. [~~A secondary or redundant load path capable of transferring the load from one structural element to other structural elements.~~]

ALTERNATE LOAD PATH METHOD. [~~A design approach that accounts for an extreme event by providing alternate load paths for elements that are no longer able to carry load. In an alternate load path design, key elements are considered notionally removed, one at a time, and the structure is designed to transfer the loads from the removed element to other structural elements, as required by Section 1616.~~]

ASPECT RATIO. [~~The height of any portion of a building divided by its least dimension at the elevation from which the height is being measured.~~]

COLLAPSE (STRUCTURAL). [~~Failure of a structural element to the extent that it can no longer support any load.~~]

ELEMENT (STRUCTURAL). [~~A structural member or structural assembly.~~]

KEY ELEMENT. [~~An element of the structural system, including its connections, that meets one or more of the following criteria:~~]

~~[1. An element which when lost, results in more than local collapse.]~~

~~[2. An element that braces a key element, the failure of which results in failure of the key element (further secondary elements need not be considered key elements).]~~

~~[3. An element whose tributary area exceeds 3,000 square feet (279 square meters) on a single level.]~~

LOCAL COLLAPSE. [~~Failure of a structural element that results in the collapse of areas being directly supported by that element and not extending vertically more than three stories.~~]

RESPONSE RATIO. [~~The ratio of an ultimate response quantity (e.g., deflection) to its value at yield.~~]

ROTATION. [~~The angle, measured at the ends of a member, whose tangent is equal to the deflection of the member at midspan divided by half the length of the member.~~]

SPECIFIC LOCAL LOAD. [~~A load applied to a structural element or structural system as specified in Section 1616.7.~~]

SPECIFIC LOCAL RESISTANCE METHOD. [~~A design approach that accounts for extreme event loads by providing sufficient strength for elements that may fail. In a specific local resistance design, key elements are designed for specific local loads as required by Section 1616.~~]

SECTION BC ~~[1615]~~ 1616 **STRUCTURAL INTEGRITY—PRESCRIPTIVE REQUIREMENTS**

~~[1615.1]~~ 1616.1 Scope. The intent of these provisions is to enhance structural performance under extreme event scenarios by providing additional overall system redundancy and local robustness. All structures shall be designed to satisfy the prescriptive requirements of this section.

Exception: Structures in [~~Structural Occupancy~~] Risk Category I of Table 1604.5 and structures in Occupancy Group R-3 are exempt from the requirements of Sections [~~1614~~] 1615 through [~~1616~~] 1617.

~~[1615.2]~~ 1616.2 Continuity and ties. All structural elements shall have a minimum degree of continuity and shall be tied together horizontally and vertically as specified in Chapters 19, 21[~~7~~] and 22 for concrete, masonry and steel, respectively.

~~[1615.3]~~ 1616.3 Lateral bracing. Floor and roof diaphragms or other horizontal elements shall be tied to the lateral load-resisting system.

~~[1615.4] Reserved.~~

~~[1615.5]~~ 1616.4 Vehicular impact. Structural columns that are directly exposed to vehicular traffic shall be designed for vehicular impact. Structural columns that are adequately protected by bollards, guard walls, vehicle arrest devices or other elements do not need to be designed for vehicular impact. The load combinations for vehicular impact shall be as specified in Section [~~1605.6~~] 1605.5.

Specific loads for vehicular impact shall be as follows:

1. Exterior corner columns shall be designed for a concentrated load of 40 kips applied horizontally in any direction from which a vehicle can approach at a height of either 18 inches (~~[457]~~ 457.2 mm) or 36 inches (~~[914]~~ 914.4 mm) above the finished driving surface, whichever creates the worst effect.
2. All other exterior columns exposed to vehicular traffic, and columns within loading docks, and columns in parking garages along the driving lane shall be designed for a

concentrated load of 20 kips applied horizontally in any direction from which a vehicle can approach at a height of either 18 inches (~~[457]~~ 457.2 mm) or 36 inches (~~[914]~~ 914.4 mm) above the finished driving surface, whichever creates the worst effect.

~~[1615.6]~~ **1616.5 Gas explosions.** In buildings with gas piping operating at pressures in excess of 15 psig (~~[103]~~ 193.4 kPa gauge), all key elements and their connections within 15 feet (4572 mm) of such piping shall be designed to resist a potential gas explosion. The structure shall be designed to account for the potential loss of the affected key elements one at a time by the alternate load path ~~[Alternative Load Path]~~ method. Load combinations for the alternate load path ~~[Alternative Load Path]~~ shall be as specified in Section ~~[1605.5]~~ 1605.4. In lieu of the alternate load path ~~[Alternative Load Path]~~ method, the affected key elements shall be designed to withstand a load of 430 psf (20.6 kPa) applied using the load combinations specified in Section ~~[1605.6]~~ 1605.5. The load shall be applied along the entire length of the element, and shall be applied in the manner and direction that produces the most damaging effect.

Exceptions:

1. If a structural enclosure designed to resist the specified pressure is provided around the high-pressure gas piping, only the key elements within the structural enclosure need to comply with this section.
2. A reduced pressure for gas explosions can be used based on an engineering analysis approved by the commissioner.

~~[1615.6.1]~~ **1616.5.1 Explosion prevention and deflagration venting.** The structural design and installation of explosion prevention systems and deflagration venting shall be in accordance with the requirements of Appendices E and G of the *New York City Fuel Gas Code*, as well as the *New York City Fire Code*, and the rules and regulations of the department.

SECTION BC ~~[1616]~~ 1617
STRUCTURAL INTEGRITY—KEY ELEMENT ANALYSIS

~~[1616.1]~~ **1617.1 Scope.** A key element analysis shall be performed for the following buildings:

1. Buildings included in ~~[Structural Occupancy]~~ Risk Category IV as defined in this chapter.
2. Buildings with the aspect ratios of seven or greater.
3. Buildings greater than 600 feet (~~[183]~~ 182.9 m) in height or more than 1,000,000 square feet (92 903 m²) in gross floor area.
4. Buildings taller than seven stories where any element, except for walls greater than 10 feet (~~[3.048]~~ 3.1 m) in length, supports in aggregate more than 15 percent of the building area.

5. Buildings designed for areas with 3,000 or more occupants in one area in close proximity, including fixed seating and grandstand areas.

6. When specifically ordered by the commissioner.

[1616.2] 1617.2 Load combinations. Where specifically required by Section ~~[1616.1]~~ 1617.1, elements and components shall be designed to resist the forces calculated using the combination specified in Section ~~[1605.5]~~ 1605.4 or ~~[1605.7]~~ 1605.6 as applicable.

[1616.3 Reserved.]

[1616.4] 1617.3 Seismic and wind. When the code-prescribed seismic or wind design produces greater effects, the seismic or wind design shall govern, but the detailing requirements and limitations prescribed in this and referenced sections shall also be followed.

[1616.5] 1617.4 Joints. Where a structure is divided by joints that allow for movement, each portion of the structure between joints shall be considered as a separate structure.

[1616.6] 1617.5 Key element analysis. Where key elements are present in a structure, the structure shall be designed to account for their potential loss one at a time by the alternate load path method or by the specific local resistance method as specified in Section ~~[1616.7]~~ 1617.6.

[1616.7] 1617.6 The specific local resistance method. Where the specific local resistance method is used, key elements shall be designed using specific local loads as follows:

1. Each compression element shall be designed for a concentrated load equal to 2 percent of its axial load but not less than 15 kips, applied at midspan in any direction, perpendicular to its longitudinal axis. This load shall be applied in combination with the full dead load and 50 percent of the live load in the compression element.
2. Each bending element shall be designed for the combination of the principal acting moments plus an additional moment, equal to 10 percent of the principal acting moment applied in the perpendicular plane.
3. Connections of each tension element shall be designed to develop the smaller of the ultimate tension capacity of the member or three times the force in the member.
4. All structural elements shall be designed for a reversal of load. The reversed load shall be equal to 10 percent of the design load used in sizing the member.

[1616.8] 1617.7 Design criteria. Alternate load path method and/or specific local resistance method for key elements shall conform to the appropriate design criteria as determined from Sections ~~[1616.9, 1616.10 and]~~ 1617.8 through ~~[1616.11]~~ 1617.10. ~~[Load combinations for the alternate load path method shall be as specified in Section 1605.5.]~~

[1616.9] 1617.8 Analysis procedures. All structural analysis for specific local loads or alternate load paths shall be made by one of the following methods:

[1616.9.1] 1617.8.1 Static elastic analysis. For analysis of this type, dynamic effects of member loss or dynamic effects of specific local loads need not be considered. The structural demand is obtained from linear static analysis. However, structural member capacity is based on ultimate capacity of the entire cross section. The demand/capacity ratio of structural elements shall not exceed one.

[1616.9.2] 1617.8.2 Dynamic inelastic analysis. For analysis of this type, dynamic effects of member loss or specific local loads shall be considered. The structure does not need to remain elastic; however, the response ratio and rotation limits obtained from Table [1616.9.3] 1617.8.3 shall not be exceeded.

1617.8.3 Energy methods. Static inelastic analysis using energy equilibrium may also be used. The structure does not need to remain elastic; however, the response ratio and rotation limits obtained from Table [1616.9.3] 1617.8.3 shall not be exceeded.

**TABLE [1616.9.3] 1617.8.3
RESPONSE RATIO AND ROTATION LIMITS**

ELEMENT	RESPONSE RATIO	ROTATION
Concrete slabs	$\mu < 10$	$\theta < 4^\circ$
Post-tensioned beams	$\mu < 2$	$\theta < 1.5^\circ$
Concrete beams	$\mu < 20$	$\theta < 6^\circ$
Concrete columns	$\mu < 2$	$\theta < 6^\circ$
Long span acoustical deck	$\mu < 2$	$\theta < 3^\circ$
Open web steel joists	$\mu < 2$	$\theta < 6^\circ$
Steel beams	$\mu < 20$	$\theta < 10^\circ$
Steel columns	$\mu < 5$	$\theta < 6^\circ$

For SI: 1 degree = 0.01745 rad.

Note: Table [1616.9.3] 1617.8.3 is intended for SDOF and simplified MDOF response calculations and a low level of protection. Table [1616.9.3] 1617.8.3 does not apply for explicit finite element methods that calculate the performance of the structural elements in response to the specified loading intensity. Steel joists: downward loading 6 degrees, upward loading ductility of 2.

[1616.10] 1617.9 Minimum response. Structural response of elements determined using a dynamic inelastic analysis shall not be less than 80 percent of the structural response determined using a static elastic analysis.

[1616.11] 1617.10 Strength reduction factors. For structural design for specific local loads or alternate load paths, all strength reduction factors may be [~~taken as one~~] multiplied by 1.1.

BC [1617] 1618 STRUCTURAL PEER REVIEW

[1617.1] 1618.1 General. The provisions of this section specify where structural peer review is required, how and by whom it is to be performed.

[1617.2] 1618.2 Where required. A structural peer review of the primary structure shall be performed and a report provided for the following buildings:

1. Buildings included in [~~Structural Occupancy~~] Risk Category IV as defined in this chapter and more than 50,000 square feet (~~[4645]~~ 4645.2 m²) of framed area.
2. Buildings with aspect ratios of seven or greater.
3. Buildings greater than 600 feet (183 m) in height or more than 1,000,000 square feet (92 903 m²) in gross floor area. Rooftop structures may be excluded from building height in accordance with Section 504.3.
4. Buildings taller than seven stories where any element, except for walls greater than 10 feet (3.048 meters) in length, supports in aggregate more than 15 percent of the building area.
5. Buildings designed using nonlinear time history analysis or with special seismic energy dissipation systems.
6. Buildings designed for areas with 3,000 or more occupants in one area in close proximity, including fixed seating and grandstand areas.
7. Buildings where a structural peer review is requested by the commissioner.
8. Buildings designed by performance-based methods.

[1617.3] 1618.3 Structural peer review. It shall be verified that the structural design is in general conformance with the requirements of this code.

[1617.4] 1618.4 Geotechnical peer review. Geotechnical peer reviews are required to be performed in accordance with Section d.

1618.5 Structural peer reviewer. The structural peer review shall be performed by a qualified independent structural engineer who has been retained by or on behalf of the owner. A structural peer reviewer shall meet the requirements of the rules of the department.

1618.5.1 Independence. In order to satisfy the requirement that the peer reviewer be independent, the department requires that the peer reviewer must not engage in any activities that may conflict with their objective judgment and integrity, including but not limited to having a financial and/or other interest in the design, construction, installation, manufacture or maintenance of structures or components that they are reviewing.

[1617.5] 1618.6 Extent of the structural peer review. The structural peer review shall comply with Sections 1618.6.1 and 1618.6.2.

[1617.5.1] 1618.6.1 Scope. The structural peer reviewer shall review the plans and specifications submitted with the permit application for general compliance with the structural and foundation

design provisions of this code. The reviewing engineer shall perform the following tasks at a minimum:

1. Confirm that the design loads conform to this code.
2. Confirm that other structural design criteria and design assumptions conform to this code and are in accordance with generally accepted engineering practice.
3. Review geotechnical and other engineering investigations that are related to the foundation and structural design and confirm that the design properly incorporates the results and recommendations of the investigations.
4. Review the structural frame and the load supporting parts of floors, roofs, walls, shallow foundation elements, deep foundation caps, connection of deep foundation elements to deep foundation caps, and permanent rock or soil anchor connection to the structural elements [~~foundations~~]. Cladding, cladding framing, stairs, equipment supports, ceiling supports, non-loadbearing partitions, railings and guards, and other secondary structural items shall be excluded.
5. Confirm that the structure has a complete load path.
6. Perform independent calculations for a representative fraction of systems, members, and details to check their adequacy. The number of representative systems, members, and details verified shall be sufficient to form a basis for the reviewer's conclusions.
7. Verify that performance-specified structural components (such as certain precast concrete elements) have been appropriately specified and coordinated with the primary building structure.
8. Verify that the design engineer of record complied with the structural integrity provisions of the code.
9. Review the structural and architectural plans for the building. Confirm that the structural plans are in general conformance with the architectural plans regarding loads and other conditions that may affect the structural design.
10. Confirm that major mechanical items are accommodated in the structural plans.
11. Attest to the general completeness of the structural plans and specifications.
12. Review performance based design.

[1617.5.2] 1618.6.2 Structural design criteria. If the design criteria and design assumptions are not shown on the drawings or in the computations, the structural engineer of record shall provide a statement of these criteria and assumptions for the reviewer. In addition, the design engineer shall provide information and/or calculations, if requested by the peer reviewer.

[1617.6] 1618.7 Structural peer review report. The structural peer review report shall comply with Sections 1618.7.1 through 1618.7.3.

~~[1617.6.1]~~ **1618.7.1 General.** The reviewing engineer shall submit a report to the department stating whether or not the structural design shown on the plans and specifications generally conforms to the structural and foundation requirements of this code.

~~[1617.6.2]~~ **1618.7.2 Contents.** The report shall demonstrate, at a minimum, compliance with Items 1 through ~~[44]~~ 12 of Section ~~[4617.5.4]~~ 1618.6.1. In addition, the report shall also include the following:

1. A list of construction documents, including the latest revision dates submitted to the department for approval, as well as geotechnical reports, wind tunnel studies and other reports utilized in the design.
2. The codes and standards used in the structural design of the project.
- ~~[2-]~~ 3. The structural design criteria, including loads and performance requirements.
- ~~[3-]~~ 4. The basis for design criteria that are not specified directly in applicable codes and standards. This should include reports by specialty consultants such as wind tunnel study reports and geotechnical reports. Generally, the report should confirm that existing conditions at the site have been investigated as appropriate and that the design of the proposed structure is in general conformance with these conditions.
5. The basis of performance-based design and its appropriateness of use.
6. A statement that the qualification and independence of the peer reviewer is in accordance with Section 1618.5.
7. Peer review reports shall provide an unconditional statement that must be either an acceptance or rejection of code compliance of the structural design required to be reviewed by this section.
8. The structural peer review reports shall contain a statement that geotechnical peer review reports and/or wind tunnel peer review reports, when required, have been received with an unconditional statement of acceptance by the authors of those reports.

~~[1617.6.3]~~ **1618.7.3 Phased submission.** If an application is submitted for a permit for the construction of foundations or any other part of a building before the construction documents for the whole building have been submitted, then the structural peer review and report shall be phased. The structural peer reviewer shall be provided with sufficient information on which to make a structural peer review of the phased submission. In addition to the requirements of this section, phased submission of the report shall include any changes made to the initial structural peer review evaluation. The geotechnical peer review report need not be submitted concurrently with the structural peer review report.

~~[1617.7]~~ **1618.8 Responsibility.** The responsibilities of the engineer of record and peer reviewer shall be as laid out in Sections 1618.8.1 through 1618.8.4.

~~[1617.7.1]~~ **1618.8.1 Structural engineer of record.** The structural engineer of record shall retain sole responsibility for the structural design. The activities and reports of the structural peer reviewer shall not relieve the structural engineer of record of this responsibility.

~~[1617.7.2]~~ **1618.8.2 Structural peer reviewer.** The structural peer reviewer's report states his or her opinion regarding the design by the engineer of record. The standard of care to which the structural peer reviewer shall be held in the performance of the structural peer review and report is that level of skill and care ~~[are]~~ consistent with structural peer review services performed by professional engineers licensed in the State of New York for similar type projects. The structural peer reviewer shall not be responsible for the conclusions of the wind and geotechnical peer review reports.

1618.8.3 Revisions of design. The structural engineer of record shall identify that a new review is required based upon changes to the design documents relevant to the scope of the peer review. The structural peer reviewer shall review the items that have been affected and shall revise the structural peer review report.

1618.8.4 Disputes. When a dispute arises between the applicant of record and the peer reviewer regarding compliance with Section 1618 that cannot be resolved by these parties, such dispute shall be reported to the department in the form of a letter from the applicant of record. The department may make a final decision or may accept a change of the peer reviewer.

1618.9 Change to peer reviewer. The peer reviewer cannot be changed without the express consent of the department. The current peer reviewer must submit both a written letter to the borough commissioner detailing the reason for the withdrawal request and a report of the structural peer review findings to date. If a change of peer reviewer is approved, a revised submission indicating the replacement peer reviewer shall be filed with the department.

SECTION ~~[1618]~~ 1619

~~[LOADS ON]~~ TEMPORARY STRUCTURES AND TEMPORARY CONSTRUCTION INSTALLATIONS

~~[1618.1 General. Installations governed by this code shall be defined as temporary when such installations are intended to be taken apart or removed after a limited period following their installation, including, but not limited to, tents, scaffolds, sidewalk sheds, cranes, and run back structures. Temporary installations shall comply with all the provisions of this code, except as described in Sections 1618.1.1 through 1618.3.2.]~~

~~[1618.1.1 Duration. Such limited period shall not exceed one year for temporary installations used in construction operations covered by Chapter 33. For temporary installations covered by Section 3103, the limited period shall not exceed ninety days. The limited period shall be counted from the date the temporary installation is substantially installed.]~~

~~[1618.1.1.1 Extension of time. Subject to the approval of the commissioner, a request to extend the time for a temporary installation, subject to the limits in Section 1618.1.1, shall be accompanied by the submission of a report from a registered design professional that certifies the following:]~~

~~[1. Such registered design professional performed an inspection within the last 30 days to confirm that the installation complies with the requirements of the approved construction documents for the temporary installation; and]~~

~~[2. The action plan required by Section 1618.3:]~~

~~[2.1. Is still in effect;]~~

~~[2.2. Has been revised to reflect the current conditions of the installation; or]~~

~~[2.3. Is no longer required, as the installation has been retrofitted to comply with the loads for new construction without any reduction, pursuant to Section 1618.2.]~~

~~**[1618.1.2 Construction documents.** Any temporary installation utilizing the exemptions and load reductions in the structural design shall be prominently indicated on drawings as temporary, and all reduced loads shall be indicated on the drawings. The environmental load mitigations shall be indicated on the construction documents. The construction documents shall be maintained at the site of the temporary installation and be available to the department upon request.]~~

~~**[1618.2 Loads.** Temporary installations shall be designed and constructed to resist the loads required by Chapter 16 of this code for new construction.]~~

~~**[Exception:** Temporary installations that are accompanied by an action plan in accordance with Section 1618.3 shall be permitted to reduce the design environmental loads required by Chapter 16 of this code as follows:]~~

~~[1. Seismic. Temporary installations shall be permitted to use 2 percent of the design dead and live load in lieu of the seismic forces required by Section 1614 in load combinations including seismic forces. This load shall be distributed in proportion to the design loads, shall be applied in any horizontal direction and need not be combined with other environmental loads.]~~

~~[2. Wind. The wind design for temporary installations shall be computed as required by Section 1609. The basic wind speed used to design the structure shall be permitted to be reduced by applying a factor of 0.8.]~~

~~[3. Other environmental forces. Other environmental forces, including, but not limited to, snow, flood ice, and temperature differential effects, shall be permitted to be reduced as appropriate for the limited exposure of the installation.]~~

~~**[1618.3 Action plan.** All temporary installations reducing the design environmental loads in accordance with Section 1618.2 shall include environmental load mitigation measures as part of an action plan. The action plan measures shall be indicated on the drawings.]~~

~~**[1618.3.1 Implementation.** The action plan shall be such that it may be reliably implemented in one day's notice or less as appropriate for the actions.]~~

~~**[1618.3.2 Components.** The action plan shall, at a minimum, include the following:]~~

- [1. ~~Threshold of predicted environmental loads;~~]
- [2. ~~Method of monitoring environmental loads;~~]
- [3. ~~Party responsible for monitoring loads and determining implementation of action plan;~~]
- [4. ~~Party responsible for effectuating the action plan;~~]
- [5. ~~Evacuation procedures;~~]
- [6. ~~Safety zone, standoff distance or standoff perimeter as appropriate. Safety zone, standoff distance or standoff perimeter shall not extend beyond the property line;~~]
- [7. ~~Any other activities, such as the addition or removal of structural and/or nonstructural elements, removal of loads or creating sacrificial elements so that the structure may resist unreduced forces as required for permanent structures;~~]
- [8. ~~Plan to prevent wind-born debris; and~~]
- [9. ~~Verification that the design and procedures shall not adversely impact other structures.~~]

1619.1 General. Temporary construction installations that are required by this code to be designed by a registered design professional, and all temporary structures, shall comply with all the provisions of this code, except as described in Sections 1619.3 and 1619.4.

1619.2 Definitions. The following terms are defined in Chapter 2:

TEMPORARY CONSTRUCTION INSTALLATIONS.

TEMPORARY STRUCTURES.

1619.3 Temporary construction installations. Temporary construction installations shall be subject to the requirements of this section and Chapter 33.

1619.3.1 Design drawings for temporary construction installations. Design loads, including location and intensity of live loads, shall be indicated on the design drawings for temporary construction installations. Drawings for multilevel temporary construction installations shall indicate the maximum number of levels to be loaded simultaneously and the maximum design loads. Any temporary construction installation utilizing authorized exemptions and load reductions in the structural design shall be indicated on drawings as temporary, and all reduced loads shall be indicated on the drawings. The environmental load mitigations shall be indicated on the design drawings. The design drawings shall be maintained at the site of the temporary construction installation and be made available to the department upon request.

1619.3.2 Loads for temporary construction installations. Temporary construction installations shall be designed and constructed to resist the loads and load combinations required by this chapter for permanent construction and Chapter 33 of the building code. Live loads shall not be less than the code prescribed value or the maximum loads for the use of a temporary construction installation as noted on the design drawings.

Exceptions:

1. Load reductions may be utilized where permitted by Section 1619.3.3.
2. Derricks not permanently mounted to a building shall not be subject to the loads and load combinations of this chapter. Such derricks shall instead be subject to the requirements of Section 3319 and rules promulgated by the commissioner. However, temporary construction installations used to support such derricks shall be subject to the loads and load combinations of this chapter.
3. Mobile cranes shall not be subject to the loads and load combinations of this chapter. Mobile cranes shall instead be subject to the requirements of Section 3319 and rules promulgated by the commissioner. However, temporary construction installations used to support mobile cranes shall be subject to the loads and load combinations of this chapter.

1619.3.3 Load reductions for temporary construction installations. Temporary construction installations shall be permitted to reduce the design environmental loads required by this chapter in accordance with the specifications below. An action plan for load reductions shall be required in accordance with Section 1619.5.

1. Seismic resistance. Temporary construction installations do not need to consider seismic design. These installations, other than supports of excavation, shall be designed for a minimum of 2 percent of the dead and live load as a service level lateral force. This load shall be used in lieu of seismic forces required by Section 1613 in load combinations including seismic forces. This load shall be distributed in proportion to the design loads, applied in any horizontal direction, and need not be combined with other environmental loads.
2. Wind. The wind design for temporary construction installations shall be computed as required by Section 1609. The basic wind speed used to design the temporary construction installation shall be permitted to be reduced by applying a factor of 0.8.

Exceptions: The following are exceptions to item 2 concerning load reductions for wind design:

1. Mast climbers shall not be permitted to reduce wind loads.
2. Suspended scaffolds shall be designed for an out of service wind speed of at least 45 mph (72.4 kph), or a lower speed when so specified by the scaffold manufacturer.
3. Other environmental forces. Other environmental forces, including but not limited to snow, flood, ice, and temperature differential effects, shall be permitted to be reduced as appropriate for the limited seasonal exposure of the temporary construction installation.

1619.3.4 Permit renewal for temporary construction installations that utilize an action plan. Where a temporary construction installation requires an action plan in accordance with Section

1619.5, the application to renew the permit for such temporary construction installation shall be accompanied by the submission of a report from a registered design professional certifying, based on an inspection of the temporary construction installation performed by the registered design professional within 30 days prior to the submittal of the permit renewal application, that the action plan:

1. Is still in effect;
2. Has been revised to reflect the current conditions of the temporary structure; or
3. Is no longer required, as the temporary structure has been retrofitted to comply with the loads for new construction without any reduction, pursuant to Section 1619.3.2.

1619.4 Temporary structures. Temporary structures shall be subject to the requirements of Section 3103.1 and this section.

1619.4.1 Design drawings for temporary structures. Design loads, including location and intensity of live loads, shall be indicated on the design drawings for temporary structures. Drawings for multilevel temporary structures shall indicate the maximum number of levels to be loaded simultaneously and the maximum design loads. Any temporary structure utilizing authorized exemptions and load reductions in the structural design shall be indicated on drawings as temporary, and all reduced loads shall be indicated on the drawings. The environmental load mitigations shall be indicated on the design drawings. The design drawings shall be maintained at the site of the temporary structure and be made available to the department upon request.

1619.4.2 Loads for temporary structures. Temporary structures shall be designed and constructed to resist the loads and load combinations required by this chapter. Live loads shall not be less than the code prescribed value or the maximum loads for the use of a temporary structure as noted on the design drawings.

Exception: Load reductions may be utilized where permitted by Section 1619.4.3.

1619.4.3 Load reductions for temporary structures. Temporary structures shall be permitted to reduce the design environmental loads required by this chapter in accordance with the specifications below. An action plan for load reductions shall be required in accordance with Section 1619.5.

1. Seismic resistance. Temporary structures do not need to consider seismic design. Temporary structures shall be designed for a minimum of 2 percent of the dead and live load as a service level lateral force. This load shall be used in lieu of seismic forces required by Section 1613 in load combinations including seismic forces. This load shall be distributed in proportion to the design loads, applied in any horizontal direction, and need not be combined with other environmental loads.
2. Wind. The wind design for temporary structures shall be computed as required by Section 1609. The basic wind speed used to design the structure shall be permitted to be reduced by applying a factor of 0.8.

Exception: In lieu of applying a factor of 0.8, temporary structures may be removed from service at the environmental conditions determined by the manufacturer of the temporary structure. The threshold for removal of service shall be indicated on the design drawings required by Section 1619.4.1 as well as the action plan required by Section 1619.5.

3. Other environmental forces. Other environmental forces, including but not limited to snow, flood, ice, and temperature differential effects, shall be permitted to be reduced as appropriate for the limited seasonal exposure of the temporary structure.

1619.4.4 Duration of time for temporary structures. Temporary structures shall be erected for a limited period not exceeding ninety days in accordance with Article 111 of Title 28 of the Administrative Code. Such limited period shall be counted from the date the temporary structure is substantially completed.

Exception: Where the commissioner has approved a request to extend the duration of time for a temporary structure in accordance with Section 1619.4.5.

1619.4.5 Extension of time for temporary structures. Subject to the approval of the commissioner, the duration of time for a temporary structure may be extended by increments not to exceed ninety days. Each request to extend the time for a temporary structure shall be accompanied by the submission of a report from a registered design professional certifying the following:

1. Such registered design professional performed an inspection within the last 30 days to confirm that the temporary structure complies with the requirements of the approved construction documents for the temporary structure; and
2. Where an action plan is utilized in accordance with Section 1619.5:
 - 2.1. It is still in effect;
 - 2.2. It has been revised to reflect the current conditions of the temporary structure; or
 - 2.3. It is no longer required, as the temporary structure has been retrofitted to comply with the loads for new construction without any reduction, pursuant to Section 1619.4.2.

1619.5 Action plan. All temporary structures or temporary construction installations with reduced design environmental loads in accordance with Sections 1619.3.3 or 1619.4.3 shall include environmental load mitigation measures as part of an action plan to protect the public. The action plan measures shall be indicated on the design drawings required by Sections 1619.3.1 or 1619.4.1.

Exception: An action plan is not required for:

1. Derricks not permanently mounted to a building. Derricks not permanently mounted to a building shall be secured in accordance with a wind action plan as specified in rules promulgated by the commissioner.

2. Mobile cranes. Mobile cranes shall be secured in accordance with a wind action plan as specified in rules promulgated by the commissioner.
3. A suspended scaffold. Suspended scaffolds shall be secured in accordance with the requirements of Section 3314; requirements for securing suspended scaffolds shall be indicated on design drawings when required by Section 3314.

1619.5.1 Implementation. The action plan shall be such that it can be reliably implemented within one day of notice or less as appropriate for the actions.

1619.5.2 Components. The action plan shall, at a minimum, include the following:

1. Threshold of predicted environmental loads;
2. Method of monitoring environmental loads;
3. Name of party responsible for monitoring loads and determining implementation of action plan;
4. Name of party responsible for implementing the action plan;
5. Evacuation procedures;
6. Safety zone, standoff distance or standoff perimeter as appropriate. Safety zone, standoff distance or standoff perimeter shall not extend beyond the property line;
7. Any other activities, such as the addition or removal of structural and/or nonstructural elements, removal of loads or creating sacrificial elements so that the structure may resist unreduced forces as required for permanent structures;
8. Plan to prevent wind-born debris; and
9. Verification that the design and procedures shall not adversely impact other structures.

§ 18. Chapter 17 of the New York city building code, as amended by local law number 141 for the year 2013, table 1704.3 as amended by local law number 51 for the year 2014, section 1704.33 as amended by local law number 116 for the year 2019, is amended to read as follows:

CHAPTER 17
[~~STRUCTURAL TESTS AND~~] SPECIAL INSPECTIONS AND TESTS

SECTION BC 1701
GENERAL

1701.1 Scope. The provisions of this chapter shall govern the inspection of quality, workmanship and requirements for construction. Materials, inspection and testing shall conform to the applicable standards listed in this code or in the rules of the department. See Chapter 1 of Title 28 of the *Administrative Code* for additional provisions relating to materials, testing and inspections.

1701.2 New materials. See Chapter 1 of Title 28 of the *Administrative Code* for additional provisions.

1701.3 Used materials. See Chapter 1 of Title 28 of the *Administrative Code*.

SECTION BC 1702
DEFINITIONS

1702.1 ~~[General. The following words and terms shall, for the purposes of this chapter and as used elsewhere in this code, have the meanings shown herein.]~~ **Definitions.** The following terms are defined in Chapter 2:

APPROVED AGENCY. [~~See Chapter 1 of Title 28 of the *Administrative Code*.~~]

APPROVED FABRICATOR. [~~An established and qualified person, firm or corporation approved by the commissioner to custom manufacture or build products or assemblies regulated by this code.~~]

CERTIFICATE OF COMPLIANCE. [~~A certificate stating that materials meet specified standards, that work was done in compliance with approved construction documents and other applicable provisions of law, or with respect to specified service equipment, a certificate issued by the department authorizing the operation of such equipment.~~]

FABRICATED ITEM. [~~Products and assemblies regulated by this code that are custom manufactured, or built prior to their incorporation into the work at the job site. Fabricated items shall not include listed, labeled or approved products or assemblies.~~]

INSPECTION CERTIFICATE. [~~An identification applied on a product by an approved agency containing the name of the manufacturer, the function and performance characteristics, and the name and identification of the approved agency that indicates that the product or material has been inspected and evaluated by such approved agency. An inspection certificate shall also mean a certificate issued by the department upon satisfactory completion of an inspection or test.~~]

INTUMESCENT FIRE-RESISTANT COATINGS. [~~Thin film liquid mixture applied to substrates which expands into a protective foamed layer to provide fire-resistant protection of the substrates when exposed to flame or intense heat.~~]

LABEL. [~~An identification applied on a product by the manufacturer that contains the name of the manufacturer, the function and performance characteristics of the product or material, and the name~~]

~~and identification of an approved agency and that indicates that a representative sample of the product or material has been tested and evaluated by an approved agency for compliance with nationally recognized standards or tests to determine suitable usage in a specified manner.]~~

~~**MANUFACTURER'S DESIGNATION.** [An identification applied on a product by the manufacturer indicating that a product or material complies with a specified standard or set of rules.]~~

~~**MARK.** [An identification applied on a product by the manufacturer indicating the name of the manufacturer and the function of a product or material.]~~

~~**MASTIC FIRE-RESISTANT COATINGS.** [Liquid mixture applied to a substrate that provides fire resistant protection of a substrate when exposed to flame or intense heat.]~~

~~**SPECIAL INSPECTION.** [Inspection of selected materials, equipment, installation, fabrication, erection or placement of components and connections, to ensure compliance with approved construction documents and referenced standards as required by this chapter or elsewhere in this code or its referenced standards.]~~

~~**SPECIAL INSPECTION, CONTINUOUS.** [The full time observation of work requiring special inspection by a special inspector who is continuously present in the area where the work is being performed.]~~

~~**SPECIAL INSPECTION, PERIODIC.** [The intermittent observation of work requiring special inspection by a special inspector who is present in the area where the work has been or is being performed and at the completion of the work. All work requiring special inspection shall remain accessible and exposed until approved by the special inspector.]~~

~~**SPECIAL INSPECTOR.** [See Chapter 1 of Title 28 of the *Administrative Code*.]~~

~~**SPRAYED FIRE-RESISTANT MATERIALS.** [Cementitious or fibrous materials that are sprayed to provide fire resistant protection of the substrates.]~~

~~**SUPERINTENDENT OF CONSTRUCTION.** [See Chapter 1 of Title 28 of the *Administrative Code*.]~~

SECTION BC 1703 APPROVALS

See Chapter 1 of Title 28 of the *Administrative Code*.

SECTION BC 1704 RESPONSIBILITIES FOR SPECIAL INSPECTIONS AND TESTS

1704.1 General. Where application is made for construction as described in this section, one or more special inspection agencies meeting the requirements of Sections 28-114.1 and 28-115.1 of the *Administrative Code* shall be retained by the owner to provide inspections during construction on the types of work listed under Section [1704] 1705 and elsewhere in this code. These inspections are in addition to the other inspections required by Section 110, elsewhere in this code, and Section 28-116

of the *Administrative Code*. The special inspector shall be acceptable to the registered design professional of record.

Exception: Special inspections are not required for building components unless the design involves the practice of professional engineering or architecture as defined by the *Education Law of the State of New York* and applicable regulations governing the professional registration and certification of engineers or architects.

1704.1.1 Responsibilities. Special inspection responsibilities of registered design professionals of record, special inspection agencies, and permit holders shall meet the applicable requirements of this section.

1704.1.1.1 Responsibilities of the registered design professional of record. The registered design professional of record shall have the following duties and responsibilities:

1. ~~[Construction document requirements]~~ **Identification of required special inspections.** The registered design professional of record shall identify the materials, equipment, installation, fabrication, erection or placement of components and connections, or construction operations for the work indicated on the construction documents that are subject to special inspections on the construction documents and ~~[on forms supplied]~~ in any other form supplied or manner required by the department prior to the approval of the construction documents.
2. **Respond to field discrepancies.** The registered design professional of record shall respond to special inspector reports of uncorrected discrepancies and shall approve remedial measures.
3. **Review of shop drawings and other submittals.** Where shop or working drawings, and other submittals have been provided, the registered design professional of record shall review such shop drawings for conformance with the approved design. The registered design professional shall acknowledge conformance with the approved design on such documents.
4. **Deviations from approved construction documents.** The registered design professional of record shall submit to the department and the special inspection agency written documentation of the professional's approval of deviations from the approved construction documents. All such deviations approved by the registered design professional of record shall be filed with the department on amended construction documents in accordance with Section 28-104.3 of the *Administrative Code*.

~~[1704.1.2]~~ **1704.1.1.2 Responsibilities of the special inspection agency.** The special inspection agency shall have the following duties and responsibilities:

1. **Independence.** The special inspection agency shall be independent of the contractors responsible for the work being inspected. The registered design professional of record is permitted to act as the approved special inspection agency and such agency's

personnel are permitted to act as special inspectors for the work designed by the registered design professional of record, provided those personnel meet the qualification requirements of this section to the satisfaction of the department.

2. Qualifications. The special inspection agency shall ensure that qualified special inspectors are provided to perform special inspections in accordance with the rules of the department. Upon request of the registered design professional of record, the special inspection agency shall provide proof of inspector's and agency's qualifications, certifications, and other documents demonstrating compliance with department rules and regulations.

~~[2.]~~ **3. Construction documents.** The special inspection agency shall examine all approved construction documents that relate to the work that is the subject of the special inspections to confirm that the documents are sufficient to enable the proper performance of the special inspection. The special inspection agency shall confirm that any shop drawings or sketches have been accepted by the registered design professional of record. Acceptance shall be demonstrated in writing by the registered design professional of record on the documents. All approved shop drawings, submittals and/or sketches are to be located on site and accessible to the special inspector at time of inspection.

~~[3.]~~ **4. Inspection.** The special inspection agency shall observe work subject to special inspection to confirm that the work that is the subject of the special inspection is in compliance with the approved construction documents; with the approved shop drawings, where provided; and with the special inspection requirements of this code and department rules and regulations.

5. Tests. Where specifically required by this code, the performance of testing shall be by qualified special inspectors working for the special inspection agency. In all other instances, the special inspection agency shall observe testing to confirm that testing activities that are subject to special inspection are in compliance with the prescribed testing procedures.

~~[4.]~~ **6. Reports.** The special inspection agency shall prepare reports of its inspections and tests, and such reports shall indicate that work inspected was or was not performed in conformance with approved construction documents.

~~[4.1]~~ **6.1. Format.** Special inspection reports and records of special inspections shall be in the form and format supplied by the commissioner.

~~[4.2]~~ **6.2. Discrepancies.** Discrepancies shall be brought to the immediate attention of the contractor and, when applicable, to the attention of the superintendent of construction, for correction. ~~[If the discrepancies are not corrected, the]~~ The discrepancies shall also be brought to the attention of the owner, and the registered design professional of record ~~[prior to the completion of that phase of the work]~~ in a timely manner to allow for correction of the discrepancies.

[4.3] 6.3. Hazardous conditions. The special inspector shall report conditions noted as hazardous to life, safety or health that are not immediately corrected to the immediate attention of the commissioner.

[4.4] 6.4. Final report. Prior to issuance of a certificate of occupancy or letter of completion, a final report documenting the required special inspections, including any required performance or witnessing of tests, and correction of all discrepancies noted in the inspections shall be submitted to the department. [~~certifying~~] Such report shall certify compliance with approved construction documents, deviations approved by the registered design professional of record in accordance with Section 1704.1.1.1 Item 4 of this code, and the administrative and procedural requirements of this code.

[4.5] 6.5 Approval of partially completed work. Reports of partially completed work shall be accepted when such reports indicate that the inspected work has been completed in accordance with the construction documents, and indicate the extent and the condition of the remaining work.

[4.6] 6.6 Maintain records. The special inspection agency shall [~~keep~~] maintain records of inspections for a period of 6 years from the date of [~~project sign-off~~] the special inspection agency's final submittal or report of completed inspection. Such records shall be supplied to the commissioner upon request. The commissioner may require that special inspection reports be filed with the department and/or that such reports be otherwise made accessible for review.

[1704.1.3] 1704.1.1.3 Responsibilities of the permit holder. The permit holder shall have the following duties and responsibilities:

- 1. Statement of special inspections.** The application for permit shall include a statement of relevant special inspections as a condition for permit issuance on forms supplied by the department. This statement shall include:
 - 1.1. A complete list of materials and work included in the permit application requiring special inspections by this section and elsewhere in this code and the inspections to be performed on such work and materials; and
 - 1.2. A list of the special inspection agencies retained by the owner for conducting the special inspections listed on the approved plans. Within each category of work, multiple special inspectors or special inspection agencies may be employed.
- 2. Identification of registered design professionals providing design documents for certain construction operations.** The registered design professionals responsible for the production of design, sequence of construction operations or shop drawings for projects that require design pursuant to Chapter 33, shall file documentation of their intent to perform those duties on forms supplied by the department. The registered design professionals preparing such documents shall also be subject to the

responsibilities of a registered design professional of record required by Section 1704.1.1.1 for the scope of work covered in the design, sequence of construction operations or shop drawings for which they are responsible.

3. **Required notification to special inspection agencies.** The holder of a permit covering work requiring a special inspection shall notify the relevant special inspectors or special inspection agencies in writing at least 72 hours before the commencement of any work requiring special inspection. The permit holder shall make available the most current approved construction documents to the special inspection agency.
4. **Access for special inspection.** The construction or work for which special inspection is required shall remain accessible and exposed for special inspection purposes until completion of the required special inspections.
5. **[Deficiencies] Resolution of discrepancies.** The permit holder shall be responsible for the ~~[correction]~~ resolution of identified ~~[deficiencies]~~ discrepancies. A satisfactory inspection by a special inspection agency or the acceptance by the department of a satisfactory report of an inspection by a special inspection agency shall not be construed to be an approval by the department of a violation of the provisions of this code or of any other provision of law.

1704.2 Inspection of fabricators. Where fabrication of structural members, and other regulated products is performed on the premises of a fabricator's shop, special inspection and progress inspection of the fabricated items shall be required by this section, the *New York City Construction Codes*, and ~~[it]~~ Chapter 1 of Title 28 of the *Administrative Code*.

1704.2.1 Fabrication and implementation procedures. The special inspector shall verify that the fabricator maintains detailed fabrication and quality control procedures that provide a basis for inspection control of the workmanship and the fabricator's ability to conform to approved construction documents and referenced standards. The special inspector shall review the procedures for completeness and adequacy relative to the code requirements for the fabricator's scope of work.

Exception: Special inspections and progress inspections as required by Section 1704.2 shall not be required where the fabricator is approved in accordance with ~~[Section 1704.2.2 and with]~~ Chapter 1 of Title 28 of the *Administrative Code*, except as required by Section 1704.2.2 of this code.

1704.2.2 Fabricator approval. Work that is subject to special inspection and performed on the approved fabricator's premises shall be inspected by the special inspection agency in accordance with Section 1704.2.2.3. Approval of fabricators shall be based upon review of the fabricator's written procedural and quality control manuals and periodic auditing of fabrication practices by an approved agency.

1704.2.2.1 Certificate of intent to fabricate. For all work where approval is sought based upon Section 1704.2.2, the approved fabricator shall submit a certificate of intent to fabricate such work to the department identifying the work to be performed as an approved fabricator, and that such work shall be performed in accordance with the approved construction documents, referenced standards and applicable provisions of law and for which site the work is being fabricated prior to fabricating any items for such project.

1704.2.2.2 Fabricator's certificate of compliance. For all fabricated items, the approved fabricator shall submit a certificate of compliance to the department stating that the work was performed in accordance with the approved construction documents, referenced standards and applicable provisions of law.

1704.2.2.3 In-plant special inspections. The owner shall engage an approved [a] special inspection agency to perform special inspections for the portion of the work performed in the approved fabricator's premises. These inspections shall at a minimum include: (i) one visit to the fabricator's premises during the course of the subject work to verify the fabricator's compliance with the written and procedural quality control manuals; and (ii) inspection of 5 percent of the subject work to verify compliance with the approved construction documents. [~~Such inspection is permitted to be performed in either the fabricator's premises or at the construction site.~~]

SECTION BC 1705 **REQUIRED SPECIAL INSPECTIONS AND TESTS**

1705.1 General. Special inspections and tests of structural elements and nonstructural components of buildings and structures shall meet the applicable requirements of this section.

1705.1.1 Special cases. Special inspections shall be required for proposed work that is, in the opinion of the commissioner, unusual in its nature, including, but not limited to:

1. Construction materials and systems that are alternatives to materials and systems prescribed by this code.
2. Unusual design applications of materials described in this code.
3. Materials and systems required to be installed in accordance with manufacturer's instructions that prescribe additional requirements not contained in this code or in standards referenced by this code.

1705.1.1.1 Qualifications. Where special inspections are required for proposed work in accordance with Section 1705.1.1, the special inspection shall be performed by special inspectors qualified to inspect the work to be inspected. The qualifications of the special inspector shall be acceptable to the commissioner.

~~[1704.3]~~ **1705.2 Steel construction.** The special inspections of new installations and alterations to existing installations of steel elements in buildings and structures shall be as required by [~~Section~~

[1704.3] this section and Table [1704.3] 1705.2. Where required, special inspection of steel shall also comply with Section [1716] 1711.

Exceptions:

1. Special inspection of the steel fabrication process shall not be required where the fabricator does not perform any welding, thermal cutting or heating operation of any kind as part of the fabrication process. In such cases, the fabricator shall be required to submit a detailed procedure for material control that demonstrates the fabricator’s ability to maintain suitable records and procedures such that, at any time during the fabrication process, the material specification, grade and mill test reports for the main stress-carrying elements are capable of being determined.
2. ~~[The]~~ When specified by the registered design professional, the special inspector ~~[need not be continuously present]~~ shall have the option to perform periodic inspections during welding of the following items, provided the materials, welding procedures and qualifications of welders are verified prior to the start of the work; periodic inspections are made of the work in progress and a visual inspection of all welds is made prior to completion or prior to shipment of shop welding.
 - 2.1. Single-pass fillet welds not exceeding $5/16$ inch (7.9 mm) in size.
 - 2.2. Floor and roof deck welding.
 - 2.3. Welded studs when used for structural diaphragm.
 - 2.4. Welded sheet steel for cold-formed steel members.
 - 2.5. Welding of stairs and railing systems.

**[TABLE 1704.3
REQUIRED VERIFICATION AND INSPECTION OF STEEL CONSTRUCTION**

VERIFICATION AND INSPECTION	CONTINUOUS	PERIODIC	REFERENCED STANDARD*	BC REFERENCE
1. Material verification of high strength bolts, nuts and washers:				
a. Identification markings to conform to ASTM standards specified in the approved construction documents.	—	X	Applicable ASTM material specifications; AISC 335, Section A3.4; AISC LRFD, Section A3.3	—
b. Manufacturer’s certificate of compliance required.	—	X	—	—
2. Inspection of high strength bolting:				
a. Bearing type connections.	—	X Note b	AISC LRFD Section M2.5	1704.3.3
b. Slip critical connections.	X	X		
3. Material verification of structural steel:				
a. Identification markings to conform to ASTM standards specified in the approved construction documents.	—	—	ASTM A 6 or ASTM A 568	1708.4

VERIFICATION AND INSPECTION	CONTINUOUS	PERIODIC	REFERENCED STANDARD*	BC REFERENCE
b. Manufacturers' certified mill test reports.	—	—	ASTM A 6 or ASTM A 568	
4. Material verification of weld filler materials:				
a. Identification markings to conform to AWS specification in the approved construction documents.	—	—	AISC, ASD, Section A3.6; AISC-LRFD, Section A3.5	—
b. Manufacturer's certificate of compliance required.	—	—	—	—
5. Inspection of welding:	—	—		
a. Structural steel:				
1) Complete and partial penetration groove welds.	X	—	AWS D1.1	1704.3.1
2) Multipass fillet welds.	X	—		
3) Single pass fillet welds > 5/16"	X	—		
4) Single pass fillet welds ≤ 5/16"	—	X		
5) Floor and roof deck welds.	—	X	AWS D1.3	—
b. Reinforcing steel:	—	—	AWS D1.4 ACI 318: 3.5.2	1903.5.2
1) Verification of weldability of reinforcing steel other than ASTM A 706.	—	X		
2) Reinforcing steel resisting flexural and axial forces in intermediate and special moment frames, and boundary elements of special reinforced concrete shear walls and	X	—		
3) Shear reinforcement.	X Note a	—		
4) Other reinforcing steel.	—	X		
6. Inspection of steel frame joint details for compliance with approved construction documents:				
a. Details such as bracing and stiffening.	—	X	—	1704.3.2
b. Member locations.	—	—		
c. Application of joint details at each connection.	—	—		

For SI: 1 inch = 25.4 mm.

a. A minimum of 10 percent of shear studs shall be verified for strength of welded connection. If failure is evident on one or more, then the strength of all shear studs shall be verified.

b. Turn of the nut bolting shall be continuously inspected. Exception: Periodic inspection shall be acceptable when the contractor's procedures have been established and verified for compliance by the special inspector.]

2.6. Welding of connections where the calculated connection strength is at least twice the required strength of the connection. Such connections shall be specifically indicated on the approved construction documents.

TABLE 1705.2
REQUIRED SPECIAL INSPECTION OF STEEL CONSTRUCTION

<u>TYPE</u>	<u>CONTINUOUS SPECIAL INSPECTION</u>	<u>PERIODIC SPECIAL INSPECTION</u>	<u>REFERENCED STANDARD^a</u>	<u>BC REFERENCE</u>
<u>1. Material verification of high-strength bolts, nuts and washers:</u>				
<u>a. Identification markings to conform to ASTM standards specified in the approved construction documents.</u>	=	X	<u>AISC 360, Section A3.3; applicable ASTM material specifications; and RCSC Specification for Structural Joints Using High-Strength Bolts Section 2</u>	=
<u>b. Manufacturer's certificate of compliance required.</u>	=	X	<u>RCSC Specification for Structural Joints Using High-Strength Bolts Section 2.1</u>	=
<u>2. Inspection of high-strength bolting:</u>				
<u>a. Snug-tight joints.</u>	=	X	<u>AISC 360 Section M2.5; and RCSC Specification for Structural Joints Using High-Strength Bolts Section 9</u>	1705.2.3
<u>b. Pre-tensioned and slip-critical joints using turn-of-nut with matchmarking, twist-off bolt or direct tension indicator methods of installation.</u>	=	X		
<u>c. Pre-tensioned and slip-critical joints using turn-of-nut without matchmarking or calibrated wrench methods of installation.</u>	X	=		
<u>d. Pre-installation verification testing.</u>	X	=	<u>Specification for Structural Joints Using High-Strength Bolts Section 8.2</u>	1705.2.3.1
<u>3. Material verification of structural steel and cold formed steel deck:</u>				
<u>a. For structural steel, identification markings to conform to AISC 360.</u>	=	X	<u>AISC 360 Sections A3.1, N2.1, N3.2 (a) and (k)(1)</u>	=
<u>b. For other steel, identification markings to conform to ASTM standards specified in the approved construction documents.</u>	=	=	<u>Applicable ASTM Standards</u>	=
<u>c. Manufacturers' certified mill test reports.</u>	=	X	<u>Applicable ASTM material standards</u>	=
<u>4. Material verification of weld filler materials:</u>				

<u>TYPE</u>	<u>CONTINUOUS SPECIAL INSPECTION</u>	<u>PERIODIC SPECIAL INSPECTION</u>	<u>REFERENCED STANDARD^a</u>	<u>BC REFERENCE</u>
a. <u>Identification markings to conform to AWS specification in the approved construction documents.</u>	=	=	<u>AISC 360 Section A3.5 and N3.2(e), and applicable AWS A5 D1.1 5.3.1 and approved contract documents</u>	=
b. <u>Manufacturer's certificate of compliance required.</u>	=	=	<u>AISC 360 Section A3.5</u>	=
5. Inspection of welding:				
a. <u>Structural steel:</u>	=	=	=	=
1) <u>Complete and partial penetration groove welds.</u>	X	=	<u>AWS D1.1</u>	<u>1705.2.1</u>
2) <u>Multipass fillet welds.</u>	X	=		
3) <u>Single-pass fillet welds > 5/16".</u>	X	=		
4) <u>Plug and slot welds.</u>	X	=		
5) <u>Single-pass fillet welds < 5/16".</u>	=	X		
6) <u>Floor and roof deck welds.</u>	=	X	<u>AWS D1.3</u>	=
7) <u>Cold-formed steel welds.</u>	=	X	<u>AWS D1.3</u>	=
b. <u>Reinforcing steel:</u>	=	=	<u>AWS D1.4</u>	<u>1903.6.2</u>
1) <u>Pre-welding verification of base metal.</u>	—	X		
2) <u>Reinforcing steel-resisting flexural and axial forces in intermediate and special moment frames, and boundary elements of special reinforced concrete shear walls and shear reinforcement.</u>	X	=		
3) <u>Shear reinforcement.</u>	X Note a	=		
4) <u>Other reinforcing steel.</u>	=	X Note b		
6. Inspection of steel frame joint details for compliance with approved construction documents:				
a. <u>Details such as bracing and stiffening.</u>	=	X	=	<u>1705.2.2</u>

<u>TYPE</u>	<u>CONTINUOUS SPECIAL INSPECTION</u>	<u>PERIODIC SPECIAL INSPECTION</u>	<u>REFERENCED STANDARD^a</u>	<u>BC REFERENCE</u>
b. <u>Member locations.</u>	=	X		
c. <u>Application of joint details at each connection.</u>	=	X		

For SI: 1 inch = 25.4 mm.

- a. A minimum of 10 % of shear studs shall be verified for strength of welded connection. If failure is evident on one or more, then the strength of all shear studs shall be verified.
- b. Welding of indirect and direct butt joints shall be continuously inspected.

[1704.3.1] 1705.2.1 Welding. Welding inspection and welding inspector qualification shall be in compliance with this section and the rules of the department.

[1704.3.1.1] 1705.2.1.1 Structural steel. Welding inspection and welding inspector qualification for structural steel shall be in accordance with AWS D1.1.

[1704.3.1.2] 1705.2.1.2 Cold-formed steel deck. Welding inspection and welding inspector qualification for cold-formed steel floor and roof decks shall be in accordance with [AWS D1.3] SDI QA/QC.

[1704.3.1.3] 1705.2.1.3 Reinforcing steel. Welding inspection and welding inspector qualification for reinforcing steel shall be in accordance with AWS D1.4[and ACI 318].

[1704.3.2] 1705.2.2 Details. The special inspector shall perform an inspection of the steel frame to verify compliance with the details shown on the approved construction documents, such as bracing, stiffening, member locations and proper application of joint details at each connection, including connections designed for seismic effects.

[1704.3.3] 1705.2.3 High-strength bolts. Installation of high-strength bolts shall be inspected in accordance with this section and AISC 360.

Exception: Installation of high strength bolts in bearing type connections where the calculated connection strength is at least twice the required strength of the connection. Inspection of such connections shall be made under Section [1704.3.2] 1705.2.2. Such connections shall be clearly indicated on the approved construction documents.

[1704.3.3.1] 1705.2.3.1 General. While the work is in progress, the special inspector shall determine that the requirements for bolts, nuts, washers and paint; bolted parts and installation and tightening in such standards are met. For bolts requiring pretensioning, the special inspector shall observe the preinstallation testing and calibration procedures when such procedures are required by the [installation] installation method or by project plans or specifications; determine that all plies of connected materials have been drawn together and properly snugged and monitor the installation of bolts to verify that the selected procedure for installation is properly used to tighten bolts. For joints required to be tightened only to the snug-tight condition, the special inspector need only verify that the connected materials have been drawn together and properly snugged.

[1704.3.3.2] 1705.2.3.2 Periodic inspection. Inspection of bolt installation for pretensioning is permitted to be performed on a periodic basis when using the turn-of-nut method with matchmarking techniques, the direct tension indicator method or the alternate design fastener (twist-off bolt) method. Joints designated as snug tight need be inspected only on a periodic basis.

[1704.3.3.3] 1705.2.3.3 Continuous inspection. Inspection of bolt installation for pretensioning using the calibrated wrench method or the turn-of-nut method without matchmarking shall be performed on a continuous basis.

1705.2.4 Special inspection for seismic resistance. In addition to the other special inspection requirements of this code, special inspections of structural steel seismic force resisting systems and structural steel elements shall be performed in accordance with Section 1705.2.4.1 and 1705.2.4.2.

1705.2.4.1 Seismic force-resisting systems. Special inspections of structural steel in the seismic force-resisting systems of buildings and structures assigned to Seismic Design Category B, C or D shall be performed in accordance with the quality assurance requirements of AISC 341.

Exception: Special inspections per Section 1705.2.4.1 are not required in the seismic force-resisting systems of buildings and structures assigned to Seismic Design Category B or C that are not specifically detailed for seismic resistance, with a response modification coefficient, R, of 3 or less, excluding cantilever column systems.

1705.2.4.2 Structural steel elements. Special inspections of structural steel elements in the seismic force-resisting systems of buildings and structures assigned to Seismic Design Category B, C or D other than those covered in Section 1705.2.4.1 of this code, including struts, collectors, chords and foundation elements, shall be performed in accordance with the quality assurance requirements of AISC 341.

Exception: Special inspections of structural steel elements per Section 1705.2.4.2 are not required in the seismic force-resisting systems of buildings and structures assigned to Seismic Design Category B or C with a response modification coefficient, R, of 3 or less.

1705.2.5 Testing for seismic resistance of structural steel. Nondestructive testing for seismic resistance shall be in accordance with Section 1705.2.5.1 or 1705.2.5.2, as applicable.

1705.2.5.1 Seismic force-resisting systems. Nondestructive testing of structural steel in the seismic force-resisting systems of buildings and structures assigned to Seismic Design Category B, C, or D shall be performed in accordance with the quality assurance requirements of AISC 341.

Exception: Nondestructive testing is not required in the seismic force-resisting systems of buildings and structures assigned to Seismic Design Category B or C that are not specifically detailed for seismic resistance, with a response modification coefficient, R, of 3 or less, excluding cantilever column systems.

1705.2.5.2 Structural steel elements. Nondestructive testing of structural steel elements in the seismic force-resisting systems of buildings and structures assigned to Seismic Design Category B, C or D other than those covered in Section 1705.2.5.1, including struts, collectors, chords and foundation elements, shall be performed in accordance with the quality assurance requirements of AISC 341.

Exception: Nondestructive testing of structural steel elements is not required in the seismic force-resisting systems of buildings and structures assigned to Seismic Design Category B or C with a response modification coefficient, R, of 3 or less.

[1704.3.4] 1705.2.6 Cold-formed steel construction. Special inspections for prefabricated and site built cold-formed steel [light frame] construction and assemblies used structurally shall be as required by this section and Table [1704.3.4] 1705.2.6. [The special inspector shall verify the size, quality, framing, erection, and both temporary and permanent bracing.]

**TABLE 1705.2.6
REQUIRED SPECIAL INSPECTION OF COLD-FORMED STEEL CONSTRUCTION**

<u>TYPE</u>	<u>CONTINUOUS SPECIAL INSPECTION</u>	<u>PERIODIC SPECIAL INSPECTION</u>	<u>REFERENCED STANDARD</u>	<u>BC REFERENCE</u>
<u>1. Material Verification:</u>				
a. <u>Verify that identification markings conform to AISI S240 and as specified in the approved construction documents.</u>	<u>X</u>		<u>AISI S240, Section D6.5</u>	
b. <u>Verify that material is clean, straight and undamaged.</u>		<u>X</u>		
<u>2. Inspection of general framing:</u>				
a. <u>Verify that member sizes conform to the approved construction documents.</u>		<u>X</u>	<u>AISI S240 Section C</u>	
b. <u>Verify that member layout conforms to the approved construction documents.</u>		<u>X</u>		
c. <u>Verify that proper bearing lengths are provided in accordance with approved construction documents.</u>		<u>X</u>		

**TABLE 1705.2.6
REQUIRED SPECIAL INSPECTION OF COLD-FORMED STEEL CONSTRUCTION**

<u>TYPE</u>	<u>CONTINUOUS SPECIAL INSPECTION</u>	<u>PERIODIC SPECIAL INSPECTION</u>	<u>REFERENCED STANDARD</u>	<u>BC REFERENCE</u>
d. <u>Verify that punched holes and sheared or flame cut edges of material in members are clean and free from notches and burred edges.</u>		<u>X</u>		
3. <u>Inspection of framing connections and anchorages:</u>				
a. <u>Verify that screws, bolts, and other fasteners conform to approved construction document requirements for diameter, length, quantity, spacing, edge distance, and location.</u>		<u>X</u>	<u>AISI S240, Section D6.7</u>	
b. <u>Verify that manufactured connectors, such as joist hangers, caps, straps, clips, ties, hold-downs, and anchors conform to approved construction document requirements for manufacturer, type, gauge, and fastener requirements.</u>		<u>X</u>	<u>AISI S240 Section B1.5 and Section C4</u>	
c. <u>Post-installed connections to concrete.</u>	<u>X</u>		<u>AISI S240 Section D6.9</u>	
4. <u>Inspection of welding:</u>				
a. <u>Inspect welds in accordance with S240 Section D6.6.</u>		<u>X</u>	<u>AWS D1.3, AISI S240 Section D6.6</u>	
b. <u>Additional requirements for welds performed as a part of a lateral force-resisting system</u>	<u>X</u> <u>Note a</u>		<u>AISI S240 Section D6.9</u>	
5. <u>Bracing:</u>				
a. <u>Verify that temporary bracing, shoring, jacks, etc., are installed, and not removed until no longer necessary, in accordance with the approved construction</u>		<u>X</u>	<u>AISI S240 Section E6</u>	

**TABLE 1705.2.6
REQUIRED SPECIAL INSPECTION OF COLD-FORMED STEEL CONSTRUCTION**

<u>TYPE</u>	<u>CONTINUOUS SPECIAL INSPECTION</u>	<u>PERIODIC SPECIAL INSPECTION</u>	<u>REFERENCED STANDARD</u>	<u>BC REFERENCE</u>
documents and approved erection drawings.				
b. <u>Verify that permanent bracing, web stiffeners, bridging, blocking, wind bracing, etc. are installed in accordance with the approved construction documents and approved erection drawings.</u>		X		
c. <u>Where a cold-formed steel truss clear span is 60 feet (18 288 mm) or greater, the special inspector shall verify that the temporary installation restraint/bracing and the permanent individual truss member restraint/bracing are installed in accordance with the approved truss submittal package.</u>		X		<u>2211.1.3.2</u>
6. <u>Pre-installation Document Submittals</u>		X	<u>AISI S240, Section D3</u>	
7. <u>Lateral Force-Resisting System Additional Requirements</u>		X	<u>AISI S240 Section D6.9</u>	

Note a: In accordance with AISI S240 Section D6.9.1, continuous special inspection of weld fit-up in lateral force-resisting systems may be reduced to periodic special inspection upon fulfillment of the conditions of Section D6.9.1.

1705.2.7 Open-web steel joists and joist girders. Special inspections of open web steel joists and joist girders in buildings, structures, and portions thereof shall be in accordance with Table 1705.2.7.

**TABLE 1705.2.7
REQUIRED SPECIAL INSPECTIONS OF OPEN-WEB STEEL JOISTS AND JOIST GIRDERS**

<u>TYPE</u>	<u>CONTINUOUS SPECIAL INSPECTION</u>	<u>PERIODIC SPECIAL INSPECTION</u>	<u>REFERENCED STANDARD</u>	<u>BC REFERENCE</u>
<u>1. Inspection of member sizes and locations.</u>	---	X		

TABLE 1705.2.7
REQUIRED SPECIAL INSPECTIONS OF OPEN-WEB STEEL JOISTS AND JOIST GIRDERS

<u>TYPE</u>	<u>CONTINUOUS SPECIAL INSPECTION</u>	<u>PERIODIC SPECIAL INSPECTION</u>	<u>REFERENCED STANDARD</u>	<u>BC REFERENCE</u>
2. <u>Inspection of end connections – welded or bolted</u>	----	X	<u>SJI Specifications</u>	<u>2207.1</u>
3. <u>Inspection of standard bridging, horizontal or diagonal</u>	----	X	<u>SJI Specifications</u>	<u>2207.1</u>
4. <u>Inspection of bridging, horizontal or diagonal, that differs from the SJI specifications listed in Section 2207.1</u>	----	X	<u>SJI Specifications</u>	

[1704.4] 1705.3 Concrete construction. The special inspections and verifications for concrete construction shall be as required by this section and Table [1704.4] 1705.3.

Exceptions:

1. Special inspection shall not be required when specifically indicated as not required on the approved construction documents for:

~~[1.1. Nonstructural concrete slabs supported directly on the ground, including prestressed slabs on grade, where the effective prestress in the concrete is less than 150 psi (1.03 Mpa).]~~

~~[1.2. Concrete foundation(s) for lightweight fences and recreational equipment.]~~

~~[1.3. Concrete patios, site furnishings, garden walls, driveways, sidewalks and similar construction.]~~

1.1. Nonstructural concrete slabs supported directly on the ground, including prestressed slabs on grade, where the effective prestress in the concrete is less than 150 psi (1.03 Mpa).

1.2. Concrete foundation(s) for lightweight fences and recreational equipment.

1.3. Concrete patios, site furnishings, garden walls, driveways, sidewalks and similar construction.

2. Testing required by Table [1704.4.1] 1705.3, Item 6, may be waived by the registered design professional who prepared the approved structural construction documents when such waiver is specifically indicated on such construction documents in the following cases:

2.1. Where the total concrete placement on a given project is less than 50 cubic yards (~~[38]~~ 38.2 m³).

- 2.2. Isolated spread concrete footings of R-3 buildings three stories or less above grade plan that are fully supported on earth or rock.
- 2.3. Continuous concrete footings supporting walls of R-3 buildings three stories or less above grade plan that are fully supported on earth or rock where the structural design of the footing is based on a specified compressive strength, f'_c , no greater than 2,500 pounds per square inch (psi) (17.2 Mpa), and the compressive strength used in the footing construction is at least 4,000 psi (27.6 Mpa).

**[TABLE 1704.4
REQUIRED VERIFICATION AND INSPECTION OF CONCRETE CONSTRUCTION**

VERIFICATION AND INSPECTION	CONTINUOUS	PERIODIC	REFERENCED STANDARD	BC REFERENCE
1. Inspection of reinforcing steel, including prestressing tendons and placement.	=	X	ACI 318:3.5, 7.1-7.7	1903.5, 1907.1, 1907.7, 1914.4
2. Inspection of reinforcing steel welding in accordance with Table 1704.3, Item 5b.	=	=	AWS D1.4	
3. Inspect bolts to be installed in concrete prior to and during placement of concrete where allowable loads have been increased.	ACI 318:3.5.2	1903.5.2		
4. Verifying use of required design mix.	X	=	=	1912.5
5. At the time fresh concrete is sampled to fabricate specimens for strength tests, perform slump and air content tests, and determine the temperature of the concrete.	=	X	ACI 318: Ch. 4, 5.2-5.4	1904, 1905.2-1905.4,
6. Inspection of concrete and shotcrete placement for proper application techniques.	1914.2, 1914.3			
7. Inspection for maintenance of specified curing temperature and techniques.	X	=	ASTM C 172 ASTM C 31	
8. Inspection of prestressed concrete: A. Application of prestressing forces. B. Grouting of bonded prestressing tendons in the seismic force-resisting system.	ACI 318: 5.6,5.8			
9. Erection of precast concrete members.	(Note a, b)	1905.6, 1914.10		
10. Verification of in situ concrete strength, prior to stressing of tendons in post-tensioned concrete and prior to removal of shores and forms from beams and structural slabs.	X	=	ACI 318: 5.9, 5.10	1905.9, 1905.10,

a. Standard sampling rate shall be in accordance with Section 1905.6.2.

b. Four inch by 8 inch cylinders may be accepted in lieu of 6 inch by 12 inch cylinders at the option of the engineer of record.]

TABLE 1705.3
REQUIRED SPECIAL INSPECTIONS AND TESTS OF CONCRETE CONSTRUCTION

<u>TYPE</u>	<u>CONTINUOUS SPECIAL INSPECTION</u>	<u>PERIODIC SPECIAL INSPECTION</u>	<u>REFERENCED STANDARD</u>	<u>BC REFERENCE</u>	<u>Concrete Special Inspector (Cast-In-Place, Precast, & Prestressed)</u>	<u>Licensed Concrete Testing Laboratory</u>
1. Inspect reinforcement, including prestressing tendons and verify placement.	=	X	<u>ACI 318: 3.5, 7.1 – 7.7</u>	<u>1903.6, 1907.1, 1907.7, 1911.4</u>	X	
2. Inspection of reinforcing steel welding in accordance with Table 1705.2, Item 5b.	=	=	<u>AWS D1.4</u> <u>ACI 318: 3.5.2</u>	<u>1903.6.2</u>		
3. Inspect anchors cast in concrete.	X	=	<u>ACI 318: 17.8.2</u>	<u>1901.3</u>	X	
4. Inspect anchors post-installed in hardened concrete members ^c . a. Adhesive anchors installed in horizontally or upwardly inclined orientations to resist sustained tension loads. b. Mechanical anchors and adhesive anchors not defined in 4a.	X	X	<u>ACI 318: 17.8</u>		X	
5. Verifying use of required design mix.	=	=	<u>ACI 318: Ch. 4, 5.2-5.4</u>	<u>1904, 1905.2-1905.4, 1911.3</u>		X
6. Prior to concrete placement, fabricate specimens for strength tests, perform slump and air content tests, and determine the temperature of the concrete. Determine water content when required.	=	=	<u>ASTM C 172</u> <u>ASTM C 31</u> <u>ACI 318: 5.6, 5.8</u> (Note a, b)	<u>1905.6, 1911.10</u>		X
7. a. Inspect concrete and shotcrete placement for proper application techniques. b. For concrete pumped through a placement boom: Following the lubrication of the concrete placement boom and prior to Contractor's commencement of the concrete pour, observe and document as part of the special inspection of the concrete placement whether the material exiting the hose is concrete exhibiting a uniform matrix of aggregate.	X	=	<u>ACI 318: 5.9, 5.10</u>	<u>1905.9, 1905.10, 1911.6, 1911.7, 1911.8</u>	X	
8. Verify maintenance of specified curing temperature and techniques. Monitoring of in-place temperatures per thermal protection plan when required.	=	X	<u>ACI 318: 5.11-5.13</u>	<u>1905.11, 1905.13, 1911.9</u>	X	
9. Inspect prestressed concrete for: A. Application of prestressing forces; and B. Grouting of bonded prestressing tendons.	X X	=	<u>ACI 318: 18.20</u> <u>ACI 318: 18.18.4</u>	=	X	
10. Inspect erection of precast concrete members.	=	X	<u>ACI 318: Ch. 16</u>	=	X	
11. Verify in-situ concrete strength, prior to stressing of tendons in post-	=	X	<u>ACI 318: 6.2</u>	<u>1906.2</u>	=	X

<u>tensioned concrete and prior to removal of shores and forms from beams and structural slabs.</u>						
<u>12. Inspect formwork for shape, location, and dimensions of the concrete member being formed.</u>	=	X	<u>ACI 318: 6.1.1</u>	<u>1906.2</u>	X	

- a. Standard sampling rate shall be in accordance with Section 1905.6.2.
- b. Four-inch by 8-inch cylinders may be accepted in lieu of 6-inch by 12-inch cylinders at the option of the engineer of record.
- c. Specific requirements for special inspection shall be included in the research report for the anchor issued by an approved source in accordance with 17.8.2 in ACI 318, or other qualification procedures. Where specific requirements are not provided, special inspection requirements shall be specified by the registered design professional and shall be approved by the commissioner prior to the commencement of the work.

[1704.4.1] 1705.3.1 Materials. In the absence of sufficient data or documentation providing evidence of conformance to quality standards for materials in Chapter 3 of ACI 318, the commissioner shall require testing of materials in accordance with the appropriate standards and criteria for the material in Chapters [3] 19 and 20 of ACI 318. Weldability of reinforcement, except that which conforms to ASTM A 706, shall be determined in accordance with the requirements of Section [~~1903.5.2~~] 1903.6.2 of this code.

[1704.4.2] 1705.3.2 Concrete construction. When the specified compressive strength of concrete in a column is greater than 1.4 times that specified for a floor system, the special inspections for concrete construction shall also comply with the requirements of Section [~~1908.2.1~~] 1908.1.4.

[1704.5] 1705.4 Masonry construction. Masonry construction shall be inspected and verified in accordance with the requirements of Sections [~~1704.5.1~~] 1705.4.1 through [~~1704.5.3~~] 1705.4.3, depending on the [~~structural occupancy~~] risk category of the building or structure.

Exception: Special inspections shall not be required for:

1. [~~2.~~] Masonry fireplaces, masonry heaters or masonry chimneys installed or constructed in accordance with Section 2111, 2112, or 2113, respectively.
2. Alterations to existing masonry, where the quantity of replaced masonry is less than 10 square feet (0.93 m²) in any 100 square feet (9.3 m²) of wall area, when specifically exempted on the approved construction documents.

**[TABLE 1704.3
REQUIRED VERIFICATION AND INSPECTION OF STEEL CONSTRUCTION**

VERIFICATION AND INSPECTION	CONTINUOUS	PERIODIC	REFERENCED STANDARD*	BC REFERENCE
1. Material verification of high-strength bolts, nuts and washers:				
a. Identification markings to conform to ASTM standards specified in the approved construction documents.	—	X	AISC 360, Section A3.3 and applicable ASTM material specifications	—
b. Manufacturer's certificate of compliance required.	—	X		—
2. Inspection of high-strength bolting:				
a. Snug-tight joints.	—	X Note b	AISC 360 Section M2.5	1704.3.3
b. Pre-tensioned and slip-critical joints using turn-of-nut with matchmarking, twist-off bolt or direct tension indicator methods of installation.	—	X		
e. Pre-tensioned and slip-critical joints using turn-of-nut without matchmarking or calibrated-wrench methods of installation.	X	—		
3. Material verification of structural steel and cold-formed steel deck:				
a. For structural steel, identification markings to conform to AISC 360.	—	X	AISC 360, Section M5.5	—
b. For other steel, identification markings to conform to ASTM standards specified in the approved construction documents.	—	—	Applicable ASTM Standards	—
e. Manufacturers' certified mill test reports.	—	X	Applicable ASTM material standards	
4. Material verification of weld filler materials				

VERIFICATION AND INSPECTION	CONTINUOUS	PERIODIC	REFERENCED STANDARD*	BC REFERENCE
a. Identification markings to conform to AWS specification in the approved construction documents.	—	—	AISC 360, Section A3.5 and applicable AWS A5 documents	—
b. Manufacturer's certificate of compliance required.	—	—		—
5. Inspection of welding:				
a. Structural steel, cold-formed steel and cold-formed steel deck:	—	—	—	—
1) Complete and partial penetration	X	—	AWS D1.1	1704.3.1
2) Multipass fillet welds.	X	—		
3) Single pass fillet welds $\geq \frac{5}{16}$ "	X	—		
4) Plug and slot welds.	X	—		
5) Single pass fillet welds $\leq \frac{5}{16}$ "	—	X		
6) Floor and roof deck welds.	—	X	AWS D1.3	—
7) Cold-formed steel welds.	—	X	AWS D1.3	—
b. Reinforcing steel:	—	—		
1) Verification of weldability of reinforcing steel other than ASTM A 706	—	X		
2) Reinforcing steel-resisting flexural and axial forces in intermediate and special moment frames, and boundary elements of special reinforced concrete shear walls and shear reinforcement.	X	—	AWS D1.4 ACI 318: 3.5.2	1903.5.2
3) Shear reinforcement.	X Note a	—		
4) Other reinforcing steel.	—	X		

VERIFICATION AND INSPECTION	CONTINUOUS	PERIODIC	REFERENCED STANDARD*	BC REFERENCE
6. Inspection of steel frame joint details for compliance with approved construction documents:				
a. Details such as bracing and stiffening.	—	X	—	1704.3.2
b. Member locations.	—	X		
e. Application of joint details at each connection.	—	X		

For SI: 1 inch = 25.4 mm.

- a. A minimum of 10 % of shear studs shall be verified for strength of welded connection. If failure is evident on one or more, then the strength of all shear studs shall be verified.
- b. Turn of the nut bolting shall be continuously inspected.
Exception: Periodic inspection shall be acceptable when the contractor's procedures have been established and verified for compliance by the special inspector.]

**[TABLE 1704.3.4
REQUIRED VERIFICATION AND INSPECTION OF COLD-FORMED STEEL LIGHT FRAME
CONSTRUCTION]**

[Verification and inspection]	[Continuous]	[Periodic]	[Referenced Standard]	[Code Reference]
[1. Material Verification:]				
[a. Verify that identification markings conform to AISI S200 and as specified in the approved construction documents.]		[X]	[AISI 200, Section A5.4]	
[b. Verify that material is clean, straight and undamaged.]		[X]		
[2. Inspection of general framing:]				
[a. Verify that member sizes conform to the approved construction documents.]		[X]		
[b. Verify that member layout conforms to the approved construction documents.]		[X]		
[c. Verify that proper bearing lengths are provided in accordance with approved construction documents.]		[X]		
[d. Verify that punched holes and sheared or flame cut edges of material in members are clean and free from notches and burred edges.]		[X]		
[3. Inspection of framing connections and anchorages:]				
[a. Verify that screws, bolts, and other fasteners conform to approved construction document requirements for diameter, length, quantity, spacing, edge distance, and location.]		[X]	[AISI S200, Section D]	
[b. Verify that manufactured connectors, such as joist hangers, caps, straps, clips, ties, hold-downs, and anchors conform to approved construction document requirements for manufacturer, type, gauge, and fastener requirements.]		[X]	[AISI S200, Section D]	
[4. Inspection of welding:]				
[a. Inspect welds in accordance with Table 1704.3.]		[X]	[AWS D1.3]	

[5. Bracing:]				
[a. Verify that temporary bracing, shoring, jacks, etc., are installed, and not removed until no longer necessary, in accordance with the approved construction documents and approved erection drawings.]		[X]		
[b. Verify that permanent bracing, web stiffeners, bridging, blocking, wind bracing, etc., are installed in accordance with the approved construction documents and approved erection drawings.]		[X]		
[c. Where a cold formed steel truss clear span is 60 feet (18 288 mm) or greater, the special inspector shall verify that the temporary installation restraint/bracing and the permanent individual truss member restraint/bracing are installed in accordance with the approved truss submittal package.]		[X]		[2210.3.4]

**[TABLE 1704.4
REQUIRED VERIFICATION AND INSPECTION OF CONCRETE CONSTRUCTION**

VERIFICATION AND INSPECTION	CONTINUOUS	PERIODIC	REFERENCED STANDARD	BC REFERENCE
1. Inspection of reinforcing steel, including prestressing tendons and placement.	=	X	ACI 318: 3.5, 7.1 — 7.7	1903.5, 1907.1, 1907.7, 1913.4
2. Inspection of reinforcing steel welding in accordance with Table 1704.3, Item 5b.	=	=	AWS D1.4 ACI 318: 3.5.2	1903.5.2
3. Inspection of bolts to be installed in concrete prior to and during placement of concrete where allowable loads have been increased or where strength design is used.	X	=	ACI 318: 8.1.3, 21.2.8	1911.5, 1912.1
4. Inspection of anchors installed in hardened concrete members ^a .	—	X	ACI 318: 3.8.6, 8.1.3, 21.2.8	1912.1
5. Verifying use of required design mix.	=	X	ACI 318: Ch. 4, 5.2-5.4	1904, 1905.2-1905.4, 1913.3
6. At the time fresh concrete is sampled to fabricate specimens for strength tests, perform slump, unit weight, and air content tests, and determine the temperature of the concrete. Determine water content when required.	X	=	ASTM C 172 ASTM C 31 ACI 318: 5.6, 5.8 (Note a, b)	1905.6, 1913.10
7. Inspection of concrete and shotcrete placement for proper application techniques.	X	=	ACI 318: 5.9, 5.10	1905.9, 1905.10, 1913.6, 1913.7, 1913.8
8. Inspection for maintenance of specified curing temperature and techniques. Monitoring of in-place temperatures per thermal protection plan when required.	=	X	ACI 318: 5.11-5.13	1905.11, 1905.13, 1913.9
9. Inspection of prestressed concrete: A. Application of prestressing forces B. Grouting of bonded prestressing tendons in the seismic force resisting system.	X X	=	ACI 318: 18.20 ACI 318: 18.18.4	=
10. Erection of precast concrete members.	=	X	ACI 318: Ch. 16	=
11. Verification of in-situ concrete strength, prior to stressing of tendons in post-tensioned concrete and prior to removal of shores and forms from beams and structural slabs.	=	X	ACI 318: 6.2	1906.2
12. Inspection of formwork for shape, location, and dimensions of the concrete member being formed.	=	X	ACI 318: 6.1.1	1906.2

a. Standard sampling rate shall be in accordance with Section 1905.6.2.

b. Four-inch by 8-inch cylinders may be accepted in lieu of 6-inch by 12-inch cylinders at the option of the engineer of record.

[1704.5.1] 1705.4.1 Empirically designed masonry, glass unit masonry and masonry veneer in buildings in [structural occupancy] Risk [category] Category IV. The minimum inspection program for empirically designed masonry, glass unit masonry and masonry veneer designed [by] in accordance with Section 2109, 2110, or Chapter 14 of this code, respectively, or by Chapter 5, 6 or 7 of TMS 402[ACI 530/ASCE 5] as modified by Chapter 21 of this code, in structures classified as [structural occupancy] Risk [category] Category IV, in accordance with Table 1604.5, shall comply with Table [1704.5.1] 1705.4.1 of this code.

**TABLE 1704.5.1
LEVEL 1 SPECIAL INSPECTION**

INSPECTION TASK	FREQUENCY OF INSPECTION		REFERENCE FOR CRITERIA		
	Continuous during task listed	Periodically during task listed	IBC section	ACI 530/ASCE 5/TMS 402*	ACI 530.1/ASCE 6/FMS 602*
1. As masonry construction begins, the following shall be verified to ensure compliance:					
a. Proportions of site prepared mortar.		X			Art. 2.6A
b. Construction of mortar joints.		X			Art. 3.3B
c. Location of reinforcement, connectors, prestressing tendons and anchorage.	—	X	—	—	Art. 3.4, 3.6A
d. Prestressing technique.	—	X	—	—	Art. 3.6B
e. Grade and size of prestressing tendons and anchorages.	—	X	—	—	Art. 2.4B, 2.4H
2. The inspection program shall verify:					
a. Size and location of structural elements.	—	X	—	—	Art. 3.3G
b. Type, size and location of anchors, including other details of anchorage of masonry to structural members, frames or other construction.	—	X	—	Sec. 4.3.1.6, 2.1.4, 3.1.6	—
c. Specified size, grade and type of reinforcement.	—	X	—	Sec. 1.12	Art. 2.4, 3.4
d. Welding of reinforcing bars.	X	—	—	Sec. 2.1.10.6.2, 3.2.3.4(b)	—
e. Protection of masonry during cold weather (temperature below 40°F) or hot weather (temperature above 90°F).	—	X	Sec. 2104.3, 2104.4	—	Art. 1.8C, 1.8D
f. Application and measurement of prestressing force.	—	X	—	—	Art. 3.6B
3. Prior to grouting, the following shall be verified to ensure compliance:					
a. Grout space is clean.		X		—	Art. 3.2D
b. Placement of reinforcement and connectors and prestressing tendons and anchorages.		X		Sec. 1.12	Art. 3.4
c. Proportions of site prepared grout and prestressing grout for bonded tendons.	—	X	—	—	Art. 2.6B
d. Construction of mortar joints.		X		—	Art. 3.3B
4. Grout placement shall be verified to ensure compliance with code and construction document provisions:	X	—	—	—	Art. 3.5
a. Grouting of prestressing bonded tendons.	X	—	—	—	Art. 3.6C
5. Preparation of any required grout specimens, mortar specimens and/or prisms shall be observed.	X	—	Sec. 2105.2.2, 2105.3	—	Art. 1.4

INSPECTION TASK	FREQUENCY OF INSPECTION		REFERENCE FOR CRITERIA		
	Continuous during task listed	Periodically during task listed	IBC section	ACI 530/ASCE 5/TMS 402 ^a	ACI 530.1/ASCE 6/TMS 602 ^a
6. Compliance with required inspection provisions of the construction documents and the approved submittals shall be verified.	—	X	—	—	Art. 1.5

For SI: °C = (°F - 32)/1.8.

a. The specific standards referenced are those listed in Chapter 35.

**TABLE 1705.4.1
LEVEL B REQUIRED SPECIAL INSPECTIONS AND TESTS OF MASONRY CONSTRUCTION**

<u>MINIMUM TESTS</u>					
Verification of Slump flow and Visual Stability Index (VSI) as delivered to the project site in accordance with TMS 602 Article 1.5.B.1.b.3 for self-Consolidating grout.					
Verification of f'_m and f'_{AAC} in accordance with TMS 602 Article 1.4 B prior to construction, except where specifically exempted by this Code.					
<u>MINIMUM SPECIAL INSPECTION</u>					
<u>TYPE</u>	<u>FREQUENCY</u>		<u>REFERENCE FOR CRITERIA</u>		
	<u>CONTINUOUS SPECIAL INSPECTION</u>	<u>PERIODIC SPECIAL INSPECTION</u>	<u>BC SECTION</u>	<u>TMS 402</u>	<u>TMS 602</u>
1. <u>Verify compliance with required inspection provisions of the construction documents and the approved submittals.</u>	=	X	=	=	<u>Art. 1.5</u>
2. <u>As masonry construction begins, the following shall be verified to ensure compliance:</u>					
a. <u>Proportions of site-prepared mortar.</u>	=	X	=	=	<u>Art. 2.6A</u>
b. <u>Construction of mortar joints.</u>	=	X	=	=	<u>Art. 3.3B</u>
c. <u>Grade and size of prestressing tendons and anchorages.</u>	=	X	=	=	<u>Art. 2.4B, 2.4H</u>
d. <u>Location of reinforcement, connectors, prestressing tendons and anchorages.</u>	=	X	=	=	<u>Art. 3.4, 3.6A</u>
e. <u>Prestressing technique.</u>	=	X	=	=	<u>Art. 3.6B</u>
3. <u>Prior to grouting, the following shall be verified to ensure compliance:</u>					
a. <u>Grout space.</u>	=	X	=	=	<u>Art. 3.2D</u>
b. <u>Grade, type, and size of reinforcement and anchor bolts, and prestressing tendons and anchorages.</u>	=	X	=	=	=
c. <u>Placement of reinforcement, connectors, and prestressing tendons and anchorages.</u>	=	X	=	<u>Sec. 1.13</u>	<u>Art. 3.4</u>

**TABLE 1705.4.1
LEVEL B REQUIRED SPECIAL INSPECTIONS AND TESTS OF MASONRY CONSTRUCTION**

MINIMUM TESTS					
Verification of Slump flow and Visual Stability Index (VSI) as delivered to the project site in accordance with TMS 602 Article 1.5.B.1.b.3 for self-Consolidating grout.					
Verification of f'_m and f'_{AAC} in accordance with TMS 602 Article 1.4 B prior to construction, except where specifically exempted by this Code.					
MINIMUM SPECIAL INSPECTION					
TYPE	FREQUENCY		REFERENCE FOR CRITERIA		
	CONTINUOUS SPECIAL INSPECTION	PERIODIC SPECIAL INSPECTION	BC SECTION	TMS 402	TMS 602
d. Proportions of site-prepared grout and prestressing grout for bonded tendons.	=	X	=	=	Art. 2.6B
e. Construction of mortar joints.	=	X	=	=	Art. 3.3B
4. Verify during construction:					
a. Size and location of structural elements.	=	X	=	=	Art. 3.3F
b. Type, size and location of anchors, including other details of anchorage of masonry to structural members, frames or other	=	X	=	Sec. 1.2.1(e), 14.4.3	=
c. Welding of reinforcement.	X	=	=	Sec. 1.2.1(g), 6.1.6.1.2, 6.1.7.3, 13.7	=
d. Preparation, construction and protection of masonry during cold weather (temperature below 40°F) or hot weather (temperature above 90°F).	=	X	Sec. 2104.2, 2104.3.	Sec 3.1.3	Art. 1.8C, 1.8D
e. Preparation of any required grout specimens, mortar specimens and/or prisms shall be observed.	=	X	=	Art. 3.1.3	Art. 1.4
f. Application and measurement of prestressing force.	X	=	=	=	Art. 3.6B
g. Placement of grout and prestressing grout for bonded tendons is in compliance.	X	=	=	=	Art. 3.5, 3.6 C
h. Placement of AAC masonry units and construction of thin-bed mortar joints.	X ^b	X ^c	=	=	Art. 3.3 B.9, 3.3 F.1.b
i. Grout space is clean.	=	X	=	=	Art. 3.2D
j. Placement of reinforcement and connectors, and prestressing tendons and	=	X	=	Sec. 6.1.3 and 10.8	Art. 3.4

TABLE 1705.4.1
LEVEL B REQUIRED SPECIAL INSPECTIONS AND TESTS OF MASONRY CONSTRUCTION

MINIMUM TESTS					
Verification of Slump flow and Visual Stability Index (VSI) as delivered to the project site in accordance with TMS 602 Article 1.5.B.1.b.3 for self-Consolidating grout.					
Verification of f'_m and f'_{AAC} in accordance with TMS 602 Article 1.4 B prior to construction, except where specifically exempted by this Code.					
MINIMUM SPECIAL INSPECTION					
TYPE	FREQUENCY		REFERENCE FOR CRITERIA		
	CONTINUOUS SPECIAL INSPECTION	PERIODIC SPECIAL INSPECTION	BC SECTION	TMS 402	TMS 602
k. Proportions of site-prepared grout and prestressing grout for bonded tendons.	=	X	=	=	Art. 2.6B
l. Construction of mortar joints.	=	X	=	=	Art. 3.3B
5. Observe preparation of grout specimen, mortar specimen, and/or prisms.	=	X	=	=	Art: 1.4B2a3, 1.4B2b3, 1.4B2c3, 1.4B3, 1.4B4, 2.1A

For SI: °C = [(°F) - 32]/1.8.

- a. The specific standards referenced are those listed in Chapter 35.
- b. Required for the first 5,000 square feet of AAC masonry.
- c. Required after the first 5,000 square feet of AAC masonry.

[1704.5.2] 1705.4.2 Masonry in buildings [less than] three stories or less in height in [structural occupancy] Risk [category] Categories I, II, or III. The minimum special inspection program for structures classified as [risk categories] Risk Categories I, II, or III, in accordance with Table 1604.5, which are three stories or less in height, shall comply with Table [1704.5.1] 1705.4.1.

TABLE 1704.5.1
LEVEL 1 REQUIRED VERIFICATION AND INSPECTION OF MASONRY CONSTRUCTION

[VERIFICATION AND INSPECTION]	[FREQUENCY OF INSPECTION]		[REFERENCE FOR CRITERIA]		
	[Continuous]	[Periodic]	[BC Section]	[TMS 402/ACI 530/ASCE 5^a]	[TMS 602/ACI 530.1/ASCE 6^a]
[1. Compliance with required inspection provisions of the construction documents and the approved submittals shall be verified.]	[—]	[X]	[—]	[—]	[Art. 1.5]
[2. Verification of f'_m and f'_{AAC} prior to construction except where specifically exempted by this code.]	[—]	[X]	[—]	[—]	[Art. 1.4B]
[3. Verification of slump flow and VSI as delivered to the site for self-	[X]	[—]	[—]	[—]	[Art. 1.5B.1.b.3]

TABLE 1704.5.1

LEVEL 1 REQUIRED VERIFICATION AND INSPECTION OF MASONRY CONSTRUCTION

[VERIFICATION AND INSPECTION]	[FREQUENCY OF INSPECTION]		[REFERENCE FOR CRITERIA]		
	[Continuous]	[Periodic]	[BC Section]	[TMS 402/ACI 530/ASCE 5 ^a]	[TMS 602/ACI 530.1/ASCE 6 ^a]
consolidating grout.]					
[4. As masonry construction begins, the following shall be verified to ensure compliance:]					
[a. Proportions of site prepared mortar.]	[—]	[X]	[—]	[—]	[Art. 2.6A]
[b. Construction of mortar joints.]	[—]	[X]	[—]	[—]	[Art. 3.3B]
[c. Location of reinforcement, connectors, prestressing tendons and anchorages.]	[—]	[X]	[—]	[—]	[Art. 3.4, 3.6A]
[d. Prestressing technique.]	[—]	[X]	[—]	[—]	[Art. 3.6B]
[e. Grade and size of prestressing tendons and anchorages.]	[—]	[X]	[—]	[—]	[Art. 2.4B, 2.4H]
[5. During construction the inspection program shall verify:]					
[a. Size and location of structural elements.]	[—]	[X]	[—]	[—]	[Art. 3.3F]
[b. Type, size and location of anchors, including other details of anchorage of masonry to structural members, frames or other construction.]	[—]	[X]	[—]	[Sec. 1.2.2(e), 1.16.1]	[—]
[c. Specified size, grade and type of reinforcement, anchor bolts, prestressing tendons and anchorages.]	[—]	[X]	[—]	[Sec. 1.15]	[Art. 2.4, 3.4]
[d. Welding of reinforcing bars.]	[X]	[—]	[—]	[Sec. 2.1.9.7.2, 3.3.3.4(b)]	[—]
[e. Preparation, construction and protection of masonry during cold weather (temperature below 40°F) or hot weather (temperature above 90°F).]	[—]	[X]	[Sec. 2104.3, 2104.4]	[—]	[Art. 1.8C, 1.8D]
[f. Application and measurement of prestressing force.]	[X]	[—]	[—]	[—]	[Art. 3.6B]
[6. Prior to grouting, the following shall be verified to ensure compliance:]					
[a. Grout space is clean.]	[—]	[X]	[—]	[—]	[Art. 3.2D]
[b. Placement of reinforcement and connectors, and prestressing tendons and anchorages.]	[—]	[X]	[—]	[Sec. 1.13]	[Art. 3.4]
[c. Proportions of site prepared grout and prestressing grout for bonded tendons.]	[—]	[X]	[—]	[—]	[Art. 2.6B]
[d. Construction of mortar joints.]	[—]	[X]	[—]	[—]	[Art. 3.3B]
[7. Grout placement shall be verified to ensure compliance:]	[X]	[—]	[—]	[—]	[Art. 3.5]
[a. Grouting of prestressing bonded tendons.]	[X]	[—]	[—]	[—]	[Art. 3.6C]
[8. Preparation of any required grout specimens, mortar specimens and/or prisms shall be observed.]	[—]	[X]	[Sec. 2105.2.2, 2105.3]	[—]	[Art. 1.4]

[For SI: °C = (°F - 32)/1.8.]

[a. The specific standards referenced are those listed in Chapter 35.]

[1704.5.3] 1705.4.3 Masonry in buildings greater than three stories [~~or more~~] in height, and engineered masonry in [~~structural occupancy~~] Risk [category] Category IV. The minimum special inspection program for masonry designed [~~by~~] in accordance with Section 2107 or 2108, or by chapters other than Chapters 5, 6 or 7 of TMS 402[~~/ACI 530/ASCE 5~~] as modified by Chapter 21 of this code, in structures classified as [~~structural occupancy~~] Risk [category] Category IV, in

accordance with Table 1604.5 of this code, and masonry in buildings [more] greater than three stories in height, shall comply with Table [1704.5.3] 1705.4.3 of this code.

Exception: Alterations to existing masonry walls where the quantity of masonry involved in any one given location does not exceed 50 contiguous square feet (4.64 m²) shall be permitted to be subject to level 1 special inspection in accordance with Table [1704.5.1] 1705.4.1 when specifically identified as such on the approved construction documents by the registered design professional of record.

**[TABLE 1704.5.3
LEVEL 2 SPECIAL INSPECTION**

INSPECTION TASK	FREQUENCY OF INSPECTION		REFERENCE FOR CRITERIA		
	Continuous during task listed	Periodically during task listed	BC section	ACI 530/ASCE 5/TMS 402	ACI 530.1/ASCE 6/TMS 602
1. From the beginning of masonry construction, the following shall be verified to ensure compliance:					
a. Proportions of site prepared mortar, grout and prestressing grout for bonded tendons.	—	X	—	—	Art. 2.6A
b. Placement of masonry units and construction of mortar joints.	—	X	—	—	Art. 3.3B
c. Placement of reinforcement, connectors and prestressing tendons and anchorages.	—	X	—	Sec. 1.12	Art. 3.4, 3.6A
d. Grout space prior to grouting.	X	—	—	—	Art. 3.2D
e. Placement of grout.	X	—	—	—	Art. 3.5
f. Placement of prestressing grout.	X	—	—	—	Art. 3.6C
2. The inspection program shall verify:					
a. Size and location of structural elements.	—	X	—	—	Art. 3.3G
b. Type, size and location of anchors, including other details of anchorage of masonry to structural members, frames or other construction.	X	—	—	Sec. 1.2.2(e), 2.1.4, 3.1.6	—
c. Specified size, grade and type of reinforcement.		X	—	Sec. 1.12	Art. 2.4, 3.4
d. Welding reinforcement.	X	—	—	Sec. 2.1.10.6.2, 3.2.3.4(b)	—
e. Protection of masonry during cold weather (temperature below 40°F) or hot weather (temperature above 90°F).	—	X	Sec. 2104.3, 2104.4	—	
f. Application and measurement of prestressing force.	X	—	—	—	Art. 3.6B
3. Preparation of any required grout specimens, mortar specimens and/or prisms shall be observed.	X	—	Sec. 2105.2.2, 2105.3	—	Art. 1.4

**[TABLE 1704.5.3
LEVEL 2 SPECIAL INSPECTION**

INSPECTION TASK	FREQUENCY OF INSPECTION		REFERENCE FOR CRITERIA		
	Continuous during task listed	Periodically during task listed	BC section	ACI 530/ASCE 5/TMS 402	ACI 530.1/ASCE 6/TMS 602
4. Compliance with required inspection provisions of the construction documents and the approved submittals shall be verified.	—	X	—	—	Art 1.5]

**TABLE 1705.4.3
LEVEL C REQUIRED SPECIAL INSPECTIONS AND TESTS OF MASONRY CONSTRUCTION**

<u>MINIMUM TESTS</u>					
Verification of f_m and f_{AAC} in accordance with TMS 602 Article 1.4 B prior to construction and every 5,000 sq. ft. during construction.					
Verification of proportions of materials in premixed or preblended mortar, prestressing grout, and grout other than self-consolidating grout, as delivered to the project site in accordance with TMS 602 Article 1.5B.					
Verification of Slump flow and Visual Stability Index (VSI) as delivered to the project site in accordance with TMS 602 Article 1.5.B.1.b.3 for self-consolidating grout.					
<u>MINIMUM SPECIAL INSPECTION</u>					
TYPE	Continuous Special Inspection	Periodic Special Inspection	REFERENCE FOR CRITERIA		
			BC Section	TMS 402	TMS 602 ^a
1. Verify compliance with required inspection provisions of the construction documents and the approved submittals.	=	X	=	=	Art. 1.5
2. Verify that the following are in compliance:					
a. Proportions of site-prepared mortar, grout and prestressing grout for bonded tendons	=	X	=	=	Art. 2.6 A
b. Grade, type, and size of reinforcement and anchor bolts, and prestressing grout for bonded tendons.	=			Sec. 6.1.2, 10.8	Art. 2.4, 3.4
c. Placement of masonry units and construction of mortar	X	X	=	=	Art. 3.3 B
d. Placement of reinforcement, connectors and prestressing tendons and anchorages.	=	X	=	Sec. 6.1.2, 10.8	Art. 3.4, 3.6 A
e. Grout space prior to grouting.	X	=	=	=	Art. 3.2 D
f. Placement of grout and prestressing grout for bonded tendons.	X	=	=	=	Art. 3.5
g. Placement of prestressing grout.	X	=	=	=	Art. 3.6 C
h. Size and location of structural elements.	=	X	=	=	Art. 3.3 F

**[TABLE 1704.5.3
LEVEL 2 SPECIAL INSPECTION**

INSPECTION TASK	FREQUENCY OF INSPECTION		REFERENCE FOR CRITERIA		
	Continuous during task listed	Periodically during task listed	BC section	ACI 530/ASCE 5/TMS 402	ACI 530.1/ASCE 6/TMS 602
i. <u>Type, size and location of anchors, including other details of anchorage of masonry to structural members, frames or other</u>	X	=	=	<u>Sec. 1.2.1(e), 14.4.3</u>	=
j. <u>Welding of reinforcement.</u>	X	=	=	<u>Sec. 1.2.1(g), 6.1.6.1.2, 6.1.7.3, 13.7</u>	=
k. <u>Preparation, construction and protection of masonry during cold weather (temperature below 40°F) or hot weather</u>	=	X	<u>Sec. 2104.2, 2104.3</u>	=	<u>Art. 1.8 C, 1.8 D</u>
l. <u>Application and measurement of prestressing force.</u>	X	=	=	=	<u>Art. 3.6 B</u>
m. <u>Placement of AAC masonry units and construction of thin-bed mortar joints.</u>	X	=	=	=	<u>Art. 3.3 B.9, 3.3 F.1.b</u>
n. <u>Properties of thin-bed mortar for AAC masonry.</u>	X	=	=	=	<u>Art. 2.1 C.1</u>
6. <u>Observe preparation of grout specimens, mortar specimens, and/or prisms.</u>	X	=	=	<u>Sec. 3.1.3</u>	<u>Art. 1.4</u>

For SI: °C = [(°F) - 32]/1.8, 1 square foot = 0.0929 m².

a. The specific standards referenced are those listed in Chapter 35.

[1704.6] 1705.5 Wood construction. Special inspections of site-built assemblies shall be in accordance with Sections 1705.5.1 through 1705.5.4. Special inspections of the fabrication process of prefabricated wood structural elements and assemblies shall be in accordance with Section [1704.2] 1705.10. [~~Special inspections of site-built assemblies shall be in accordance with Section 1704.1.~~]

[1704.6.1] 1705.5.1 High-load diaphragms. High-load diaphragms designed in accordance with Table [2306.2.1(2)] 2306.2(2) shall be [~~installed with~~] subject to special inspections as indicated in Section 1704.1. The special inspector shall inspect the wood structural panel sheathing to ascertain whether it is of the grade and thickness shown on the approved construction documents. Additionally, the special inspector must verify the nominal size of framing members at adjoining panel edges, the nail or staple diameter and length, the number of fastener lines and that the spacing between fasteners in each line and at edge margins agrees with the approved construction documents.

[1704.6.2] 1705.5.2 Metal-plate-connected wood trusses. In addition to the requirements of Section 1704.1, metal-plate-connected wood trusses shall be subject to special inspection in accordance with [Section] Sections [1704.6.2.1] 1705.5.2.1 and [1704.6.2.2] 1705.5.2.2.

**[TABLE 1704.5.3
LEVEL 2 REQUIRED VERIFICATION AND INSPECTION OF MASONRY CONSTRUCTION]**

[VERIFICATION AND INSPECTION]	[Continuous]	[Periodic]	[REFERENCE FOR CRITERIA]		
			[BC Section]	[TMS 402/ACI 530/ASCE 5 ^a]	[TMS 602/ACI 530.1/ASCE 6 ^a]
[1. Compliance with required inspection provisions of the construction documents and the approved submittals.]	[—]	[X]	[—]	[—]	[Art. 1.5]
[2. Verification of f'_m and f'_{AAC} prior to construction and for every 5,000 square feet during construction.]	[—]	[X]	[—]	[—]	[Art. 1.4B]
[3. Verification of proportions of materials in premixed or preblended mortar and grout as delivered to the site.]	[—]	[X]	[—]	[—]	[Art. 1.5B]
[4. Verification of slump flow and VSI as delivered to the site for self-consolidating grout.]	[X]	[—]	[—]	[—]	[Art. 1.5B.1.b.3]
[5. The following shall be verified to ensure compliance:]					
[a. Proportions of site prepared mortar, grout and prestressing grout for bonded tendons.]	[—]	[X]	[—]	[—]	[Art. 2.6A]
[b. Placement of masonry units and construction of mortar joints.]	[—]	[X]	[—]	[—]	[Art. 3.3B]
[c. Placement of reinforcement, connectors and prestressing tendons and anchorages.]	[—]	[X]	[—]	[Sec. 1.15]	[Art. 3.4, 3.6A]
[d. Grout space prior to grout.]	[X]	[—]	[—]	[—]	[Art. 3.2D]
[e. Placement of grout.]	[X]	[—]	[—]	[—]	[Art. 3.5]
[f. Placement of prestressing grout.]	[X]	[—]	[—]	[—]	[Art. 3.6C]
[g. Size and location of structural elements.]	[—]	[X]	[—]	[—]	[Art. 3.3F]
[h. Type, size and location of anchors, including other details of anchorage of masonry to structural members, frames or other construction.]	[X]	[—]	[—]	[Sec. 1.2.2(e), 1.16.1]	[—]
[i. Specified size, grade and type of reinforcement, anchor bolts, prestressing tendons and anchorages.]	[—]	[X]	[—]	[Sec. 1.15]	[Art. 2.4, 3.4]
[j. Welding of reinforcing bars.]	[X]	[—]	[—]	[Sec. 2.1.9.7.2, 3.3.3.4 (b)]	[—]

**[TABLE 1704.5.3
LEVEL 2 REQUIRED VERIFICATION AND INSPECTION OF MASONRY CONSTRUCTION]**

[VERIFICATION AND INSPECTION]	[Continuous]	[Periodic]	[REFERENCE FOR CRITERIA]		
			[BC Section]	[TMS 402/ACI 530/ASCE 5 ^a]	[TMS 602/ACI 530.1/ASCE 6 ^a]
[k. Preparation, construction and protection of masonry during cold weather (temperature below 40°F) or hot weather (temperature above 90°F).]	[—]	[X]	[Sec. 2104.3, 2104.4]	[—]	[Art. 1.8C, 1.8D]
[l. Application and measurement of prestressing force.]	[X]	[—]	[—]	[—]	[Art. 3.6B]
[6. Preparation of any required grout specimens and/or prisms shall be observed.]	[X]	[—]	[Sec. 2105.2.2, 2105.3]	[—]	[Art. 1.4]

[For SI: °C = [(°F) - 32]/1.8, 1 square foot = 0.0929m².]

[a. The specific standards referenced are those listed in Chapter 35.]

[1704.6.2.1] 1705.5.2.1 Erection. The use of all metal-plate-connected wood trusses shall be subject to special inspection for compliance with the approved construction documents, the requirements of Sections 1704.1, and the following:

1. All installed materials shall be clean, straight and otherwise undamaged. Members and parts shall not be stretched, bent, or otherwise distorted unless such forming is in the integral part of the design. The special inspector shall ensure that damaged members are not used for construction.
2. Profiles of members used structurally shall conform to the dimensions specified in the approved construction documents. The installation shall be inspected for compliance with the approved construction documents regarding locations, positions, beam separators, bearing surfaces, fasteners, screws, bolts and bracing, as applicable.
3. Temporary bracing, shoring, jacks, etc., shall not be removed until the special inspector determines that ~~[they are no longer needed]~~ the construction conforms with the approved construction document.
4. Where prefabricated metal-plate-connected wood trusses are utilized, such prefabricated wood structural elements and assemblies shall also comply with Section [1704.2] 1705.10. Where any metal-plate connectors are utilized in site-built assemblies, such connections and assemblies shall be subject to special inspection for compliance with the requirements of the approved construction documents and manufacturers' instructions.

[1704.6.2.2] 1705.5.2.2 Metal-plate-connected wood trusses spanning 60 feet or greater. Where a truss clear span is 60 feet (18 288 mm) or greater, the special inspector shall verify that the temporary installation restraint/bracing and the permanent individual truss member restraint/bracing are installed in accordance with the approved truss submittal package.

[1704.6.3] 1705.5.3 Prefabricated wood I-joists. The fabrication of prefabricated wood I-joists shall be subject to special inspections in accordance with Section 1704.2 and the requirements of Section 2303.1.2.

[1704.6.3.1] 1705.5.3.1 Erection. The erection of prefabricated wood I-joists shall be subject to special inspection for compliance with the approved construction documents, the requirements of Sections 1704.1, and the following:

1. All installed materials shall be clean, straight and otherwise undamaged. Members and parts shall not be stretched, bent, or otherwise distorted unless such forming is in the integral part of the design. The special inspector shall ensure that damaged members are not used for construction.
2. Profiles of members used structurally shall conform to the dimensions specified in the approved construction documents. The installation shall be inspected for compliance with the approved construction documents regarding locations, positions, beam separators, bearing surfaces, fasteners, screws, bolts and bracing, as applicable.
3. The size, location, and number of penetrations shall be inspected for compliance with the approved construction documents and manufacturers' instructions.
4. Temporary bracing, shoring, jacks, etc., shall not be removed until the special inspector determines that they are no longer needed.

[1704.6.4] 1705.5.4 Other structural wood construction. All other structural wood construction shall be subject to progress inspections for the structural frame to the extent required by Section 110.3.3.

1705.5.5 Special inspection for seismic resistance. For the seismic force-resisting systems of structures assigned to Seismic Design Category C or D:

1. Continuous special inspection shall be required during field gluing operations of elements of the seismic force resisting system.
2. Periodic special inspection shall be required for nailing, bolting, anchoring and of other elements of the seismic force-resisting system, including wood shear walls, wood diaphragms, drag struts, braces, shear panels and hold-downs.

Exception:

1. Special inspections are not required for wood shear walls, shear panels and diaphragms, including nailing, bolting, anchoring and other fastening to other elements of the seismic force-resisting system, where the fastener spacing of the sheathing is more than 4 inches (101.6 mm) on center.
2. Where adhesive anchors require continuous special inspection elsewhere in this code, continuous special inspection shall be provided.

1705.5.6 Type IV construction. Special inspections of Type IV construction utilizing cross-laminated timber or structural composite lumber elements shall be in accordance with Table 1705.5.6.

**TABLE 1705.5.6
REQUIRED SPECIAL INSPECTIONS OF TYPE IV CONSTRUCTION UTILIZING
CROSS-LAMINATED TIMBER OR STRUCTURAL COMPOSITE LUMBER**

<u>Type</u>	<u>Continuous Special Inspection</u>	<u>Periodic Special Inspection</u>	<u>Referenced Standard</u>	<u>Code References</u>
<u>1. Inspection of anchorage and connections of mass timber construction to timber deep foundation systems</u>	=	X		<u>1705.7, 2308.3, 2304.10</u>
<u>2. Inspect erection of mass timber, including material verification</u>	=	X	<u>PRG-320, ASTM D5456</u>	<u>2303.1.4, 2303.1.10</u>
<u>3. Inspection of connections where installation methods are required to meet design loads</u>				
<u>3.1. Threaded fasteners</u>				
<u>3.1.1. Verify use of proper installation equipment</u>				
<u>3.1.2. Verify use of pre-drilled holes where required</u>	=	X	<u>NDS 11-14 ANSI/ASME Standard B18.2.1, B18.6.1 As per connection manufacturer's installation instructions</u>	<u>2304.10, 2304.11.1.1 to 2304.11.4</u>
<u>3.1.3. Inspect screws, including diameter, length, head type, spacing, installation angle, and depth</u>				
<u>3.2. Adhesive anchors installed in horizontal or upwardly inclined orientation to resist sustained tension loads</u>	X	=		
<u>3.3. Adhesive anchors not defined in 3.2</u>	=	X		
<u>3.4. Bolted connections</u>	=	X		
<u>3.5. Concealed connections</u>	=	X		
<u>3.6. Other fastener types</u>	=	X		
<u>4. Inspection of connections where installation methods are required to meet the fire resistance design in 2304.10.8</u>	=	X	<u>NDS 16.3</u>	

[1704.7] 1705.6 Subsurface conditions. The special inspections for existing subsurface conditions, fill placement ~~[and]~~, load-bearing requirements, subsurface investigations, borings and test pits shall be performed in accordance with ~~[Sections 1704.7.1 through 1704.7.3]~~ this section and Table 1705.6 of this code. The approved geotechnical report ~~[required by Section 1802.2,]~~ and construction

documents, as applicable, shall be used to determine compliance. Special inspection reports of borings and/or test pits shall be in accordance with ASTM D 1586, ASTM D 1587 and Section 1803.5 of this code.

**TABLE 1705.6
REQUIRED SPECIAL INSPECTIONS OF SUBSURFACE CONDITIONS**

<u>TYPE</u>	<u>CONTINUOUS SPECIAL INSPECTION</u>	<u>PERIODIC SPECIAL INSPECTION</u>
<p>1. <u>Special inspection of subsurface investigations, borings and test pits.</u> Boring and test pit operations, and alternative investigation methods, shall be subject to continuous special inspection to verify compliance with Section 1803. Soil sample recovery operations for test pits shall be subject to continuous special inspection to verify compliance with Section 1803.</p> <p><u>Exceptions:</u></p> <p>1. <u>Cone penetrometer testing used as an alternative investigation method per 1803.5.2 shall be subject to periodic special inspection.</u></p> <p>2. <u>Existing boring, test pit and alternative investigation records that have been deemed acceptable to the commissioner in accordance with Section 1803.4.2 are not subject to special inspection.</u></p>	X	=
<p>2. <u>During fill placement.</u> During placement and compaction of the fill material, the special inspector shall determine that the material being used and the maximum lift thickness comply with the approved geotechnical report, as specified in Section 1804.5.</p>	X	=
<p>3. <u>Evaluation of in-place density.</u> The special inspector shall determine that the in-place dry density of the compacted fill complies with the approved construction documents.</p>	X	=
<p>4. <u>Subgrade inspection.</u> Immediately prior to placement of each and every footing, foundation, fill or other supporting materials, the special inspector shall determine that the site has been prepared and is in accordance with the approved geotechnical report.</p>	=	X

~~[1704.7.1 Subgrade inspection. Immediately prior to placement of the footings, foundations, fill or other supporting materials the special inspector shall determine that the site has been prepared and is in accordance with the approved geotechnical report.]~~

~~[1704.7.2 During fill placement. During placement and compaction of the fill material, the special inspector shall determine that the material being used and the maximum lift thickness comply with the approved geotechnical report, as specified in Section 1803.5.]~~

~~[1704.7.3 Evaluation of in-place density. The special inspector shall determine, at the approved frequency, that the in-place dry density of the compacted fill complies with the approved geotechnical report.]~~

~~[1704.7.4 Special inspection of subsurface investigations, borings and test pits. Boring and test pit operations shall be subject to continuous special inspection to verify compliance with Section 1802. Soil sample recovery operations for test pits shall be subject to continuous special inspection to verify compliance with Section 1802.]~~

~~[Exception: Existing boring, test pit and subsurface investigation records that have been deemed acceptable to the commissioner in accordance with Section 1802.4.2 are not subject to special inspection.]~~

~~[1704.7.4.1 Boring and/or test pit report. The special inspector shall prepare a written report that includes statements attesting to the following: that borings were performed in accordance with the procedures established in Section 1802.5, that 100 percent of the borings and test pits were witnessed directly by the designated special inspection agency, the identification of those borings, the name of the individual special inspectors that witnessed the borings and/or test pits; confirmation that the borings and/or test pits were made and carried to the depths indicated; that to the best of the special inspector's knowledge and belief, the description and classification of the soils are a true description of the samples recovered from the respective borings and/or test pits; that such samples were recovered at the levels indicated; and that the boring and/or test pit work progressed in such manner that the samples recovered are reasonably representative of the subsurface conditions.]~~

~~[1704.8] 1705.7 Deep foundation elements. [The installation] Installation and testing of deep foundation elements shall be subject to special inspections as specified in Table 1705.7. The approved geotechnical report and construction documents prepared by the registered design professionals shall be used to determine compliance. A special inspector shall be present [continuously] during the installation and testing of each deep foundation element [; and also shall be present continuously for all required testing of deep foundation elements. The special inspection agency shall submit to the commissioner records of the installation of each deep foundation element, and where testing is required, the special inspection agency shall also submit records of the testing. The frequency shall be in accordance with the frequency specified in Tables 1705.7, 1705.7.1, 1705.7.2 and 1705.7.3, as applicable. Submittal of records of special inspections required by this section shall be in accordance with Section 1705.7.5.~~

TABLE 1705.7
REQUIRED SPECIAL INSPECTIONS AND TESTS OF DEEP FOUNDATION ELEMENTS

<u>INSTALLATION</u>	<u>CONTINUOUS SPECIAL INSPECTION</u>	<u>PERIODIC SPECIAL INSPECTION</u>
1. <u>Verify the identifying designation of the deep foundation element and record the date of</u>	X	=

<u>installation, including the start and end times.</u>		
2. <u>Verify the size, material, and allowable capacity as specified in the construction documents.</u>	X	=
3. <u>Record the elevation of the minimum required depth of penetration and record the final tip elevation and butt elevation.</u>	X	=
4. <u>Record the elevation of splices and note whether or not the splices were installed and located in compliance with the construction documents.</u>	X	=
<u>LOAD TEST</u>		
5. <u>For load test requiring a load or reaction frame, inspect the construction of the load or reaction frame. Record the results of the inspection and note whether or not the frame complies with the construction documents prepared by the registered design professional.</u>	=	X
6. <u>Record the identifying designation for the element being tested, and the date of the testing, including the start and end time.</u>	X	=
7. <u>Record the method of performing the test, including the equipment being used, as well as the test results, noting whether or not the method of testing and the test results comply with the requirements of Sections 1810, 1811, and 1812 and the construction documents.</u>	X	=

[1704.8.1] 1705.7.1 [Records of] Driven and vibrated deep foundation [element installation] elements. The ~~[record of]~~ installation ~~[of each]~~ and testing of driven and vibrated deep foundation ~~[element]~~ elements shall ~~[include, but not be limited to, the following:]~~ be subject to special inspections as specified in Table 1705.7 and Table 1705.7.1.

**TABLE 1705.7.1
REQUIRED SPECIAL INSPECTIONS OF DRIVEN AND VIBRATED DEEP FOUNDATION ELEMENTS**

<u>INSTALLATION</u>	<u>CONTINUOUS SPECIAL INSPECTION</u>	<u>PERIODIC SPECIAL INSPECTION</u>
1. <u>For driven deep foundation elements, record the type and size of hammer and record the number of blows per foot of penetration from the start of driving until the final blow count required by the construction documents is reached.</u>	X	=
2. <u>For vibrated deep foundation elements, record the equipment and method used for installation and record the time for each foot of penetration from the start of installation until completion.</u>	X	=

1705.7.2 Drilled deep foundation elements. The installation and testing of drilled deep foundation elements shall be subject to special inspections as specified in Table 1705.7 and Table 1705.7.2.

**TABLE 1705.7.2
REQUIRED SPECIAL INSPECTIONS OF DRILLED DEEP FOUNDATION ELEMENTS**

<u>INSTALLATION</u>	<u>CONTINUOUS SPECIAL INSPECTION</u>	<u>PERIODIC SPECIAL INSPECTION</u>
<u>1. Record the equipment and method used for installation and record the time for each foot of penetration from the start of installation until completion.</u>	<u>X</u>	<u>=</u>
<u>2. For deep foundation elements requiring a rock socket:</u> <u>2.1. Record the equipment and method of drilling the rock socket. Record the top elevation and bottom elevation of rock socket, as well as the time for each foot of drilling the rock socket.</u> <u>2.2. Inspect the rock socket to verify rock quality as required by Section 1812 and the construction documents. Record the results of the inspection and note whether or not the rock socket complies with the requirements of Section 1812.</u>	<u>X</u>	<u>=</u>

- ~~[1. The identifying designation of the deep foundation element and the date of installation, including the start and end times.]~~
- ~~[2. The size, material, and allowable capacity as specified in the contract drawings.]~~
- ~~[3. The elevation of the minimum required depth of penetration, and the final tip elevation and butt elevation.]~~
- ~~[4. For driven piles, record the type and size of hammer and record the number of blows per foot of penetration from the start of driving until the final blow count required by the contract drawings is reached.]~~
- ~~[5. For driven or drilled piles filled with concrete or grout:]~~
 - ~~[5.1. Prior to placing concrete, inspect the inside of the pile for alignment and damage. Record the results of the inspection, noting whether or not the pile is in compliance with Sections 1808, 1809, and 1810, and contract requirements.]~~
 - ~~[5.2. Witness the placement of concrete or grout inside the deep foundation element, and record the volume placed. Note the date and time of placement, and whether~~

~~or not the concrete or grout was placed in compliance with Sections 1808, 1809, and 1810, and contract requirements.]~~

~~[6. For drilled or vibrated deep foundation elements, record the equipment and method used for installation and record the time for each foot of penetration from the start of installation until completion.]~~

~~[7. For deep foundation elements requiring a rock socket:]~~

~~[7.1. Record the equipment and method of drilling the rock socket. Record the top elevation and bottom elevation of the rock socket, as well as the time for each foot of drilling the rock socket.]~~

~~[7.2. Inspect the rock socket as required by contract drawings. Record the results of the inspection and note whether or not the rock socket complies with the requirements of Sections 1808, 1809, and 1810, and the contract requirements.]~~

~~[8. Record the elevation of splices and note whether or not the splices were installed and located in compliance with the requirements of Sections 1808, 1809, and 1810, and the contract requirements.]~~

~~[9. For methods of deep foundation element installation not covered by Items 1 through 8 above, perform additional inspection as required by the contract drawings and record the results noting whether or not the deep foundation elements comply with the requirements of Sections 1808, 1809, and 1810, and the contract requirements.]~~

~~**[1704.8.2 Records of testing of deep foundations elements.** The records of testing of deep foundation elements shall include but not be limited to the following:]~~

~~[1. For load test requiring a load or reaction frame, inspect the construction of the load or reaction frame. Record the results of the inspection and note whether or not the frame complies with the design drawings for the frame signed and sealed by a registered design professional.]~~

~~[2. The identifying designation for the element being tested, and the date of the testing, including the start and end time.]~~

~~[3. Record the method of performing the test, including the equipment being used, as well as the test results, noting whether or not the method of testing and the test results comply with the requirements of Sections 1808, 1809, and 1810, and the contract requirements.]~~

1705.7.3 Cast-in-place deep foundation elements. The installation and testing of driven or drilled cast-in-place deep foundation elements shall be subject to special inspections as specified in Tables 1705.7, 1705.7.1, 1705.7.2 and 1705.7.3, as applicable.

**TABLE 1705.7.3
REQUIRED SPECIAL INSPECTIONS OF DRIVEN OR DRILLED CAST-IN-PLACE DEEP
FOUNDATION ELEMENTS**

<u>INSTALLATION</u>	<u>CONTINUOUS SPECIAL INSPECTION</u>	<u>PERIODIC SPECIAL INSPECTION</u>
1. <u>Prior to placing concrete, inspect the inside of the pile for alignment and damage. Record the results of the inspection, noting whether or not the pile is in compliance with Section 1812 and the construction documents.</u>	X	=
2. <u>Witness the placement of concrete or grout inside the deep foundation element, and record the volume placed. Note the date and time of placement, and whether or not the concrete or grout was placed in compliance with Section 1812 and the construction documents.</u>	X	=

[1704.8.3] 1705.7.4 Additional inspection. For methods of deep foundation element installation not covered in Section 1705.7, perform an additional inspection as required by the approved construction documents and record the results noting whether or not the deep foundation element installation complies with the requirements of Sections 1810, 1811, and 1812, and the construction documents. For steel deep foundation elements, perform an additional ~~[inspections]~~ inspection in accordance with Section ~~[1704.3.4]~~ 1705.2. For concrete or grout deep foundation elements, and concrete or grout-filled deep foundation elements, perform an additional inspection in accordance with Section ~~[1704.4.1]~~ 1705.3. For concrete or grout, and concrete or grout filled deep foundation elements, perform an additional inspection in accordance with Section ~~[1704.4.1]~~ 1705.3.

[1704.8.4] 1705.7.5 Submittal of records of ~~[installation and testing]~~ special inspections. The special ~~[inspector's submittal of installation]~~ inspection agency shall submit to the commissioner records ~~[for]~~ of the inspection of the installation of each deep foundation element~~[, and]~~. The special inspection agency shall also submit records of testing ~~[records when required,]~~ of deep foundation elements at the request of the commissioner. The submittal shall include the following:

1. A location plan showing the designation identifying each deep foundation element, and the ~~[location]~~ locations of required testing, where applicable.
2. A written summary of the installation and testing performed, signed by the special inspector, including a statement verifying that all installation and testing ~~[complied with the comply]~~ complies with the requirements of Sections ~~[1808, 1809, and 1810]~~ 1810, 1811 and 1812, and the ~~[contract requirements]~~ construction documents. The special inspector shall document the type and results of tests, and information of the technician and testing agency performing the test.

1705.8 Prestressed rock and soil anchors installation and testing and grout inspection. Special inspection for the installation and testing of permanent prestressed rock and soil anchors shall be performed in accordance with Section 1705.8.1 and Table 1705.8.1. Special inspection for the installation and testing of grout inspection shall be performed in accordance with Section 1705.8.2.

1705.8.1 Prestressed rock and soil anchors. The installation and testing of permanent prestressed rock and soil anchors shall be subject to special inspections. A special inspector shall be present during the installation of each anchor, including all drilling, grouting, tendon splicing (including corrosion protection) and placement, and installation of any accessories such as trumpets and bearing plates. The special inspector shall also be present for all required load testing and shall create a report containing a log for each element installed and for each load test performed. The special inspection agency shall submit to the commissioner records of the installation of each rock anchor, and where testing is required, the special inspection agency shall also submit records of the testing. The special inspection agency shall submit to the commissioner records of the installation and testing of each anchor.

**TABLE 1705.8.1
REQUIRED SPECIAL INSPECTIONS OF PRESTRESSED SOIL AND ROCK ANCHORS**

<u>INSTALLATION</u>	<u>CONTINUOUS SPECIAL INSPECTION</u>	<u>PERIODIC SPECIAL INSPECTION</u>
1. Special inspection of Casing Installation. Special inspector shall observe casing installation and confirm that anchors are installed through a fully cased borehole or installed through stable rock in an open hole drill hole.	X	=
2. Special inspection of Anchor Materials. Special inspector shall confirm that the materials used in prestressed rock and soil anchors conform Section 1815.3 and approved construction documents. Inspector shall confirm that bar tendons conform to ASTM A722 and that strand tendons conform to ASTM A416 or A882.	X	=
3. Special inspection of Anchor Installation. Special inspector shall confirm the preparation and installation of each anchor, including placement, type, size and location of anchors, accessories, corrosion protection and grout conforms to PTI DC35.1-4 and the approved construction documents.	X	=
4. Special inspection of Grout. At the time of grout placement, special inspector shall prepare 3" diameter grout cylinders at the intervals specified in Section 1812.1.1.2.1. Cylinders shall be prepared in accordance with ASTM C31/C31M.	X	=
5. Special inspection of Grout. At the time of grout placement, special inspector shall determine the specific gravity of grout in accordance with American Petroleum Institute (API) Recommended Practice 13B-1 or in accordance with ASTM C138.	X	=
6. Special inspection of Grout. The compressive strength of grout cylinders shall be verified using 3" diameter cylinders tested in accordance with ASTM C39 and Section 1812.1.1.2.2.	X	=
7. Special inspection of Load Test. The special inspector shall observe load testing of each anchor and confirm that the test is accordance with PTI DC35.1-14 (Sections 8.1 - 8.9) and Section 1815.5. Inspector shall confirm that testing lock-off, and test loads comply with approved construction documents and PTI DC35.1-14 (Sections 8.1 —8.9).	X	=

1705.8.1.1 Records of anchor element installation. The record of installation of each anchor element shall include, but not be limited to, the following:

1. The identifying designation of the anchor element and the date of installation, including the start and end times.
2. The size, material, details of corrosion protection, and allowable capacity as specified in the contract drawings.
3. Unbonded and bonded lengths of tendons, including strata for the bond zone.
4. The date and time of the witnessing of the placement of grout inside the anchor element, the volume placed, and whether or not the grout was placed in compliance with Section 1815 and contract requirements.

5. Equipment and method used for installation and record the time for penetration from the start of installation until completion.

1705.8.1.2 Records of testing of anchor elements. The records of testing of anchor elements shall include, but not be limited to, the following:

1. The results of the inspection and note the lock-off load.
2. The identifying designation for the element being tested, and the date of the testing, including the start and end time.
3. The method of performing the test, including the equipment being used, as well as the test results, noting whether or not the method of testing and the test results comply with the requirements of Section 1815.

1705.8.2 Grout inspection. Grout inspection shall be in accordance with Sections 1705.3 and 1815.8.

~~[1704.9 Vertical masonry foundation elements. Special inspection shall be performed in accordance with Section 1704.5 for vertical masonry foundation elements.]~~

~~[Exception: Piers for support of lightweight fences, recreational equipment, site furnishings and similar construction, unless special inspection is specifically noted as required on the approved construction documents.]~~

~~[1704.10 Wall panels, curtain walls and veneers. Special inspection is required for exterior architectural wall panels and the anchoring of veneers designed for installation on buildings above a height of 40 feet (12 192 mm). Special inspection of masonry veneer on such structures shall be in accordance with Section 1704.5.]~~

~~[Exceptions: Special inspection of wall panels, curtain walls and veneers is not applicable to:]~~

- ~~[1. Repairs and replacement in kind of gaskets or seals; or]~~
- ~~[2. Reglazing other than 4-sided structural silicone glazing.]~~

~~[1704.10.1 Design and installation documents. The special inspector shall become familiar with and retain a copy of the approved construction documents, and the following items, as applicable, approved by the registered design professional of record:]~~

- ~~[1. Shop drawings,]~~
- ~~[2. Instructions for the sequence of component installation]~~
- ~~[3. Samples and/or mock-ups, if supplied.]~~

~~[1704.10.2 Inspection program. The special inspector shall field check the site conditions at the time the structure is prepared for component installation, and periodically during component~~

installation, to verify the following work is performed in compliance with the approved construction documents, including that:]

- ~~[1. The supporting structure for components being installed is aligned and within specified tolerances required for the components;]~~
- ~~[2. Required inserts are installed;]~~
- ~~[3. Framing components are, installed and aligned as specified, and without structural defects or weakness;]~~
- ~~[4. Anchors are placed, welded, bolted and finished as specified, as applicable;]~~
- ~~[5. Weeps, flashings and tubes are installed as specified and functioning;]~~
- ~~[6. Joinery and end dams are sealed as specified;]~~
- ~~[7. Sealing materials with specified adhesive and movement capabilities are installed;]~~
- ~~[8. Gaskets, tapes, seals, insulation, flashing and other materials that are barriers to air and water movement, vapor drive, and heat loss are installed as specified;]~~
- ~~[9. Joint filler materials that accommodate specified horizontal and vertical movement are installed in accordance with the manufacturers' instructions; and]~~
- ~~[10. —Any other observations pertinent to safety of performance of the wall system.]~~

1705.9 Helical pile foundations. Special inspections shall be performed continuously during installation of helical pile foundations. The information recorded shall include installation equipment used, pile dimensions, tip elevations, final depth, final installation torque and other pertinent installation data as required by the registered design professional of record. The approved geotechnical report and the construction documents prepared by the registered design professional and standards established by the commissioner pursuant to Section 28-113.2.2 of the *Administrative Code* shall be used to determine compliance. The special inspection agency shall submit to the department records of the inspection of the installation of helical piles on forms provided by the department.

1705.10 Reserved.

1705.11 Reserved.

1705.12 Special inspections for seismic resistance. Special inspections for seismic resistance shall be required as specified in Sections 1705.12.1 through 1705.12.5, unless exempted by the exceptions of Section 1704.2.

1705.12.1 Designated seismic systems. For structures assigned to Seismic Design Category C or D, the special inspector shall examine designated seismic systems requiring seismic qualification in accordance with Section 13.2.2 of ASCE 7 and verify that the label, anchorage and mounting conform to the certificate of compliance.

1705.12.2 Access floors. Periodic special inspection is required for the anchorage of access floors in structures assigned to Seismic Design Category D.

1705.12.3 Plumbing, mechanical, fuel gas, and electrical components. Periodic special inspection of plumbing, mechanical and electrical components shall be required for the following:

1. Anchorage of electrical equipment for emergency and standby power systems in structures assigned to Seismic Design Category C or D.
2. Installation and anchorage of piping systems designed to carry hazardous materials and their associated mechanical units in structures assigned to Seismic Design Category C or D.
3. Installation and anchorage of ductwork designed to carry hazardous materials in structures assigned to Seismic Design Category C or D.
4. Installation and anchorage of vibration isolation systems in structures assigned to Seismic Design Category C or D where the approved construction documents require a nominal clearance of ¼ inch (6.4 mm) or less between the equipment support frame and restraint.
5. Installation and anchorage of stainless steel flexible multiple leg hose assemblies in structures assigned to Seismic Design Category C or D.

1705.12.4 Storage racks. Periodic special inspection is required for the anchorage of storage racks that are 8 feet (2438.4 mm) or greater in height in structures assigned to Seismic Design Category D.

1705.12.5 Seismic isolation systems. Periodic special inspection shall be provided for seismic isolation systems in seismically isolated structures assigned to Seismic Design Category B, C or D during the fabrication and installation of isolator units and energy dissipation devices.

1705.13 Testing for seismic resistance. Testing for seismic resistance shall be required as specified in Sections 1705.13.1 through 1705.13.3, unless exempted from special inspections by the exceptions of Section 1704.2.

1705.13.1 Nonstructural components. For structures assigned to Seismic Design Category B, C, or D where the requirements of Section 13.2.1 of ASCE 7 for nonstructural components, supports or attachments are met by seismic qualification as specified in Item 2 therein, the registered design professional shall specify on the approved construction documents the requirements for seismic qualification by analysis, testing or experience data. Certificates of compliance for the seismic qualification shall be submitted to the commissioner.

1705.13.2 Designated seismic systems. For structures assigned to Seismic Design Category C or D and with designated seismic systems that are subject to the requirements of Section 13.2.2 of ASCE 7 for certification, the registered design professional shall specify on the approved construction documents the requirements to be met by analysis, testing or experience data as specified therein. Certificates of compliance documenting that the requirements are met shall be submitted to the commissioner.

1705.13.3 Seismic isolation systems. Seismic isolation systems in seismically isolated structures assigned to Seismic Design Category B, C, or D shall be tested in accordance with Section 17.8 of ASCE 7.

~~[1704.11]~~ **1705.14 Sprayed fire-resistant materials.** Special inspections for sprayed fire-resistant materials applied to floor, roof and wall assemblies and structural members shall be in accordance with Sections ~~[1704.11.1]~~ 1705.14.1 through ~~[1704.11.7]~~ 1705.14.7. Special inspections shall be based on the fire-resistance design as designated ~~[it]~~ by the approved construction documents. The tests set forth in this section shall be based on samplings from specific floor, roof and wall assemblies and structural members. Special inspections shall be performed after the rough installation of electrical, automatic sprinkler, mechanical and plumbing systems and suspension systems for ceilings, where applicable.

~~[1704.11.1]~~ **1705.14.1 Physical and visual tests.** The special inspections shall include the following tests and observations to demonstrate compliance with the listing and the fire-resistance rating:

1. Condition of substrates.
2. Thickness of application.
3. Density in pounds per cubic foot (kg/m³).
4. Bond strength adhesion/cohesion.
5. Condition of finished application.

~~[1704.11.1-1704.11.2]~~ **1705.14.2 Structural member surface conditions.** The surfaces shall be prepared in accordance with the approved fire-resistance design and the written instructions of approved manufacturers. The prepared surface of structural members to be sprayed shall be inspected before the application of the sprayed fire-resistant material.

~~[1704.11.3]~~ **1705.14.3 Application.** The substrate shall have a minimum ambient temperature before and after application as specified in the written instructions of approved manufacturers. The area for application shall be ventilated during and after application as required by the written instructions of approved manufacturers.

~~[1704.11.4 Thickness.~~ The thickness of the sprayed fire-resistant materials shall comply with the following:]

- ~~[1. No more than 10 percent of the thickness measurements of the sprayed fire-resistant materials applied to floor, roof and wall assemblies and structural members shall be less than the thickness required by the approved fire resistance design.;~~
- ~~[2. In no case shall the thickness be less than the minimum allowable thickness required by Section 1704.11.4.1.]~~

1705.14.4 Thickness. No more than 10 percent of the thickness measurements of the sprayed fire-resistant materials applied to floor, roof and wall assemblies and structural members

shall be less than the thickness required by the approved fire-resistance design, but in no case less than the minimum allowable thickness required by Section 1705.14.4.1.

[1704.11.4.1] 1705.14.4.1 Minimum allowable thickness. For design thicknesses 1 inch (~~[25]~~ 25.4 mm) or greater, the minimum allowable individual thickness shall be the design thickness minus ¼ inch (6.4 mm). For design thicknesses less than 1 inch (~~[25]~~ 25.4 mm), the minimum allowable individual thickness shall be the design thickness minus 25 percent. Thickness shall be determined in accordance with ASTM E 605. Samples of the sprayed fire-resistant materials shall be selected in accordance with Sections ~~[1704.11.4.2]~~ 1705.14.4.2 ~~[and 1704.11.4.3]~~ through 1705.14.4.9 of this code.

[1704.11.4.2] 1705.14.4.2 Floor, roof and wall assemblies. The thickness of the sprayed fire-resistant material applied to floor, roof and wall assemblies shall be determined in accordance with ASTM E 605, making not ~~[less]~~ fewer than four measurements for each 1,000 square feet (~~[93]~~ 92.9 m²) of the sprayed area in each story or portion thereof.

[1704.11.4.2.1] 1705.14.4.3 Cellular decks. Thickness measurements shall be selected from a square area, 12 inches by 12 inches (~~[305]~~ 304.8 mm by ~~[305]~~ 304.8 mm) in size. A minimum of four measurements shall be made, located symmetrically within the square area.

[1704.11.4.2.2] 1705.14.4.4 Fluted decks. Thickness measurements shall be selected from a square area, 12 inches by 12 inches (~~[305]~~ 304.8 mm by ~~[305]~~ 304.8 mm) in size. ~~[A minimum of]~~ Not fewer than four measurements shall be made, located symmetrically within the square area, including one each of the following: valley, crest and sides. The average of the measurements shall be reported.

[1704.11.4.3] 1705.14.4.5 Structural framing members. The thickness of the sprayed fire-resistant material applied to structural members shall be determined in accordance with ASTM E 605. Thickness testing shall be performed on not less than 25 percent of the structural members on each floor.

[1704.11.4.3.1] 1705.14.4.5.1 Beams and girders. At beams and girders thickness measurements shall be made at nine locations around the beam or girder at each end of ~~[a]~~ one 12-inch (~~[305]~~ 304.8 mm) length.

[1704.12.4.3.2] 1705.14.4.5.2 Joists and trusses. At joists and trusses, thickness measurements shall be made at seven locations around the joist or truss at each end of ~~[a]~~ one 12-inch (~~[305]~~ 304.8 mm) length.

[1704.11.4.3.3] 1705.14.4.5.3 Wide-flanged columns. At wide-flanged columns, thickness measurements shall be made at 12 locations around the column at each end of ~~[a]~~ one 12-inch (~~[305]~~ 304.8 mm) length.

[1704.11.4.3.4] 1705.14.4.5.4 Hollow structural section and pipe columns. At hollow structural section and pipe columns, thickness measurements shall be made at ~~[a minimum of]~~ not fewer than four locations around the column at each end of ~~[a]~~ one 12-inch (~~[305]~~ 304.8 mm) length.

[1704.11.5] 1705.14.5 Density. The density of the sprayed fire-resistant material shall not be less than the density specified in the approved fire-resistance design. Density of the sprayed fire-resistant material shall be determined in accordance with ASTM E 605. The test samples for determining the density of the sprayed fire-resistant materials shall be selected as follows:

1. From each floor, roof and wall assembly at the rate of not less than one sample for every 2,500 square feet (~~[232]~~ 232.3 m²) or portion thereof of the sprayed area in each story, samples shall be taken at a distance of no less than 50 LF from another sample or 10 LF from any starting edge of an application of a specific type of material.
2. From beams, girders, trusses and columns at the rate of not less than one sample for each type of structural member for each 2,500 square feet (~~[232]~~ 232.3 m²) of floor area or portion thereof in each story.

[1704.11.6] 1705.14.6 Bond strength. The cohesive/adhesive bond strength of the cured sprayed fire-resistant material applied to floor, roof and wall assemblies and structural members shall not be less than 150 pounds per square foot (psf) (7.18 kN/m²). The cohesive/adhesive bond strength shall be determined in accordance with the field test specified in ASTM E 736 by testing in-place samples of the sprayed fire-resistant material selected in accordance with Sections [~~1704.11.6.1~~] 1705.14.6.1 through [~~1704.11.6.3~~] 1705.14.6.3 of this code.

Exception: For high-rise buildings, as described in Section 403 of this code, refer to the requirements for minimum bond strength in Table 403.2.4 of this code.

[1704.11.6.1] 1705.14.6.1 Floor, roof and wall assemblies. The test samples for determining the cohesive/adhesive bond strength of the sprayed fire-resistant materials shall be selected from each floor, roof and wall assembly at the rate of not less than one sample for every 2,500 square feet (~~[232]~~ 232.3 m²) or part thereof of the sprayed area in each story. Samples shall be obtained from locations no less than 50 LF (15 240 mm) apart or 10 LF (3048 mm) from any starting edge of an application of a specific type of material.

[1704.11.6.2] 1705.14.6.2 Structural members. The test samples for determining the cohesive/adhesive bond strength of the sprayed fire-resistant materials shall be selected from beams, girders, joists, trusses, columns and other structural members at the rate of not less than one sample for each type of structural member for each 2,500 square feet (~~[232]~~ 232.3 m²) of floor area or portion thereof in each story.

[1704.11.6.3] 1705.14.6.3 Primer, paint and encapsulant bond tests. Bond tests to qualify a primer, paint or encapsulant shall be conducted when the sprayed fire-resistant material is applied to a primed, painted or encapsulated surface for which acceptable bond-strength performance between these coatings and the fire-resistant material has not been determined. A bonding agent approved by the SFRM manufacturer shall be applied to a primed, painted or encapsulated surface where the bond strengths are found to be less than required values.

[1704.11.7] 1705.14.7 Inspection of existing sprayed fire-resistant materials during alterations in office spaces and spaces classified in Occupancy Group B. In office spaces and spaces classified in Occupancy Group B, where an alteration exposes any required sprayed fire-resistant materials on structural members or where, pursuant to an alteration, persons are required

to enter or access areas in which such sprayed fire-resistant materials are capable of being observed, the existing required sprayed fire-resistant materials shall be subject to special inspection. ~~[Such inspection shall require a determination, based on visual inspection, (i) that the existing sprayed fire-resistant materials as originally applied or installed comply with the applicable requirements of this code, including those for installation methods, materials, thickness and coverage; and (ii) that, since their original application, the integrity of the existing sprayed fire-resistant materials has not been compromised, damaged or displaced by the current alteration or by any prior alteration or other event.]~~ Such inspection shall require the special inspector to perform a visual inspection and report the existing sprayed fire-resistant materials and conditions to the registered design professional.

[1704.12] 1705.15 Mastic and intumescent fire-resistant coatings. Special inspections and tests for mastic and intumescent fire-resistant coatings applied to structural elements and decks shall be in accordance with AWCI 12-B. Special inspections and tests shall be based on provisions of AWCI 12-B and the fire-resistance design as designated in the approved construction documents.

~~[1704.13 Exterior insulation and finish systems (EIFS)] 1705.16 Combustible exterior wall coverings.~~ Special inspections shall be required for all exterior wall coverings containing combustible materials installed more than 15 feet (4572 mm) above adjacent finished grades and alterations to existing exterior wall coverings containing combustible materials installed more than 15 feet (4572 mm) above adjacent finished grades. Exterior insulation and finish system (EIFS) applications, metal composite materials (MCM), high-pressure decorative exterior-grade compact laminates (HPL) and exterior wall covering containing combustible veneers, combustible framing, combustible water-resistive barriers and foam plastic insulation installed more than 15 feet (4572 mm) above adjacent finished grades and alterations to existing ~~[EIFS]~~ installations more than 15 feet (4572 mm) above adjacent finished grades shall be inspected in accordance with Section 1705.16.1.

Exceptions

1. Water-resistive barriers that are the only combustible component in the exterior wall covering satisfying the requirements of Exceptions 1 or 2 of Section 1403.5.1.
2. Type VB construction up to 40 feet (12 192 mm) or less in height above grade.

~~[1704.13.1] 1705.16.1 Inspection program.~~ The special inspection shall include verification of~~[:]~~ compliance with the approved construction documents for the following:~~[fœ]~~ attachment to structure~~[;]~~; component properties; thicknesses, orientation, cavity sizes and location of thermal barriers, fireblocking and cavity closures; installation of waterproofing membranes, weeps, drains, mold prevention features are as specified; and conformance with the manufacturers' installation ~~[guidelines]~~ instructions, and NFPA 285 tested assembly design documentation. The special inspector shall verify that individual components required to be labeled in accordance with this code do bear such labels.

~~[1704.13.2] 1705.16.2 Water-resistive barrier coating.~~ A water-resistive barrier coating complying with ASTM E 2570 requires special inspection of the water-resistive barrier coating when installed over a sheathing substrate. Inspection of water-resistive barrier coating must verify conformance with approved construction documents, manufacturer's installation instructions, and NFPA 285 tested assembly design documentation.

1705.16.3 Thermal barrier. The special inspector shall confirm the installation of the thermal barrier is in accordance with the approved construction documents, manufacturer's installation instructions, and NFPA 285 tested assembly design documentation.

Exception: Foam plastic insulation installation on one-story buildings not required to have thermal barrier complying with Section 2603.4.1.4 of this code.

1705.16.4 Fireblocking. The special inspector shall confirm the installation of fireblocking is in accordance with Chapter 7 of this code, the approved construction documents, manufacturer's installation instructions, and NFPA 285 tested assembly design documentation.

Exception: EIFS systems and exterior wall coverings not required to have fireblocking pursuant to Section 718.2.6.1 of this code.

~~[1704.14 Special cases. Special inspections shall be required for proposed work that is, in the opinion of the commissioner, unusual in its nature, such as, but not limited to, the following examples:]~~

~~[1. Construction materials and systems that are alternatives to materials and systems prescribed by this code.]~~

~~[2. Unusual design applications of materials described in this code.]~~

~~[3. Materials and systems required to be installed in accordance with additional manufacturer's instructions that prescribe requirements not contained in this code or in standards referenced by this code.]~~

~~[1704.14.1 Qualifications. Where special inspections are required for proposed work in accordance with Section 1704.14, the special inspection shall be performed by special inspectors qualified to inspect the work to be inspected. The qualifications of the special inspector shall be acceptable to the commissioner.]~~

1705.17 Fire-resistant penetrations and joints. Special inspections for through-penetrations, membrane penetration firestops, fire-resistant joint systems, and perimeter fire barrier systems that are tested and listed in accordance with Sections 714.3.1.2, 714.4.2, 715.3 and 715.4 shall comply with Sections 1705.17.1 and 1705.17.2.

1705.17.1 Penetration firestops. Inspections of penetration firestop systems that are tested and listed in accordance with Sections 714.3.1.2 and 714.4.2 of this code shall be conducted by an approved special inspection agency in accordance with ASTM E 2174.

1705.17.2 Joint systems. Inspection of fire-resistant joint systems that are tested and listed in accordance with Sections 715.3 and 715.4 of this code shall be conducted by an approved special inspection agency in accordance with ASTM E 2393.

~~[1704.15 Special inspection for smoke control. Smoke]~~ **1705.18 Testing for smoke control.** Testing of smoke control systems shall be ~~[tested]~~ witnessed in its entirety by a special inspector in accordance with Sections ~~[1704.15.1]~~ 1705.18.1 and 909.

Exception: Post-fire smoke purge systems that are not required to function as a smoke control system shall be permitted to be inspected pursuant to the special inspection requirements of Section ~~[1704.16]~~ 1705.21.

~~[1704.15.1]~~ **1705.18.1 Testing scope.** The test scope shall be as follows:

1. During erection of ductwork and prior to concealment for the purposes of leakage testing and recording of device location.
2. Prior to occupancy and after sufficient completion for the purposes of pressure difference testing, flow measurements and detection and control verification.

~~[1704.15.2 Qualifications. Special inspection agencies for smoke control shall have expertise in fire protection engineering and mechanical engineering and certification as air balancers.]~~

1705.19 Vertical masonry foundation elements. Special inspection shall be performed in accordance with Section 1705.4 for vertical masonry foundation elements.

Exception: Piers for support of lightweight fences, recreational equipment, site furnishings and similar construction, unless special inspection is specifically noted as required on the approved construction documents.

1705.20 Wall panels, curtain walls and veneers. Special inspection is required for exterior architectural wall panels, curtain walls and the anchoring of veneers for the full height of the installation when any portion of the wall panel, curtain wall and veneer installation exceeds an elevation of 40 feet (12 192 mm) above grade. Special inspection of masonry veneer on such structures shall be in accordance with Section 1705.4. Special inspection of combustible exterior wall covering shall be in accordance with Section 1705.16.

Exceptions: Special inspection of wall panels, curtain walls and the anchoring of veneers is not applicable to:

1. Repairs and replacement in kind of gaskets or seals; [Ø]
2. Reglazing other than 4-sided structural silicone glazing[-] for which a permit is required;
or
3. Where exempted by the rules of the department.

1705.20.1 Design and installation documents. The special inspector shall become familiar with and retain a copy of the approved construction documents, and the following items, as applicable, approved by the registered design professional of record:

1. Shop drawings.
2. Instructions for the sequence of component installation.
3. Samples and/or mock-ups, if supplied.

4. Required fire-resistance rating and performance standard listings, as applicable.

1705.20.2 Inspection program. The special inspector shall field check the site conditions at the time the structure is prepared for component installation, and periodically during component installation, to verify the following work is performed in compliance with the approved construction documents, including that:

1. The supporting structure for components being installed is aligned and within specified tolerances required for the components;
2. Required inserts are installed;
3. Framing components are installed and aligned as specified, and without structural defects or weakness;
4. Anchors are placed, welded, bolted and finished as specified, as applicable;
 - a. Inspection of welding of anchors shall be inspected in accordance with Section 1705.3. Inspection of bolting of anchors shall be in accordance with Section 1705.4. Inspection of the installation of post-installed anchors shall be in accordance Section 1705.37.
5. Weeps, flashings and tubes are installed as specified and functioning;
6. Joinery and end dams are sealed as specified;
7. Sealing materials with specified adhesive and movement capabilities are installed;
8. Gaskets, tapes, seals, insulation, flashing and other materials that are barriers to air and water movement, vapor drive, and heat loss are installed as specified;
9. Joint filler materials that accommodate specified horizontal and vertical movement are installed in accordance with the manufacturers' instructions; and
10. Fireblocking and thermal barrier within combustible exterior wall coverings are installed as specified.

~~[1704.16]~~ **1705.21 Special inspection for mechanical systems.** Mechanical systems ~~[regulated which]~~ that require a certificate of compliance in accordance with Section 28-116.4.1 of the *Administrative Code* shall be inspected for conformance with the approved construction documents.

~~[1704.16.1]~~ **1705.21.1 Tests for mechanical systems.** Tests of mechanical systems shall be performed in accordance with applicable sections of the code including Sections ~~[507.16]~~ 507.6, 1011, 1108 and 1208 of the *New York City Mechanical Code*. The special inspector shall witness all required tests.

~~[Exception:]~~ **1705.21.2 Factory built equipment.** Listed and labeled self-contained factory-built equipment and appliances deemed by the registered design professional to meet the design,

manufacture and factory test requirements of this code shall be field tested in accordance with the manufacturers' installation and operational test standards.

[1704.16.2] 1705.21.3 Special inspection of mechanical systems. Inspections of mechanical systems shall include the following as applicable to the system:

1. Visual certification that required components of such systems are complete in accordance with the manufacturers' installation guidelines and the approved construction documents;
2. Supports, hangers, [5] and vibration isolation equipment are properly spaced and anchored to supporting structure;
 - 2.1. Seismic bracing shall be inspected in accordance with Section 1705.12.
3. Installation of required signage and safety instructions;
4. Electrical components are installed and electrical sign-off issued;
5. Ventilation balancing report is complete and in accordance with design documents and the system is operating as designed;
6. Required labeling, operational instructions and safety signage properly posted;
7. All related special inspections for such systems are complete;
8. The installation of exterior mechanical equipment for compliance with the approved construction documents, including, as applicable:
 - 8.1. Equipment specified;
 - 8.2. Equipment location;
 - 8.3. Installation and attachment details;
 - 8.4. Vibration isolation installation; and
 - 8.5. Other items specified by the applicant of record for the mechanical equipment design necessary to verify compliance with Section [928.2.1] 313.2.1 of the *New York City Mechanical Code*.
9. [~~Required fire~~] Fire and smoke dampers are installed and functioning properly.

[1704.17] 1705.22 Special inspection for fuel storage and fuel-piping systems. Fuel-oil storage equipment, including tanks, pumps, valves, transfer, return, fill and vent piping, hangers and bracing, fill and vent terminals, and related systems regulated by Section [1308] 1305 of the *New York City Mechanical Code*, shall be inspected for conformance with the approved construction documents and the manufacturers' installation standards. Testing of fuel storage tanks and piping shall be performed in accordance with Section [1308] 1305 of the *New York City Mechanical Code*. Special

inspection of seismic bracing shall be performed in accordance with Section [~~1707.7~~] 1705.12 of this code.

Exceptions:

1. [~~Testing for listed~~] Listed fuel oil storage tanks 660 gallons (~~[2498]~~ 2498.4 L) or less in capacity, supplied with a label or manufacturer's certification attesting that the tank was factory tested to a testing standard indicated in Section 1308.1 of the *New York City Mechanical Code*.
2. Systems and equipment exempt from service equipment certificate of compliance in accordance with Section 28-116.4.1 of the *Administrative Code*.

[~~1704.18~~] 1705.23 High-pressure-steam piping and high temperature hot water piping. High-pressure-steam piping and high temperature hot water piping regulated by Section [~~1210~~] 1211 of the *New York City Mechanical Code*, shall be subject to special inspection in accordance with this section. Special inspection of seismic bracing shall be performed in accordance with Section [~~1707.7~~] 1705.12 of this code.

[~~1704.18.1~~] 1705.23.1 Welding. The special inspector shall verify the qualifications of the welder and the quality of the welding materials and equipment prior to welding operations. The special inspector shall review the proposed welding procedures for compliance with applicable standards listed in Section [~~1210.2.2~~] 1211.2.2 of the *New York City Mechanical Code*.

[~~1704.18.2~~] 1705.23.2 Welding operations. The special inspector shall perform periodic inspection of the pipe joining and welding operations in accordance with the above. Radiographic testing shall be applied to connections as indicated in Section [~~1210.2.2~~] 1211.2.2 of the *New York City Mechanical Code*. Unacceptable connections and installations shall be rejected.

[~~1704.18.3~~] 1705.23.3 Testing of high-pressure-steam systems and high temperature hot water piping systems. Hydrostatic testing shall be performed on the completed installation of new and altered systems in accordance with Section [~~1210.2.3~~] 1211.2.3 of the *New York City Mechanical Code*. The special inspector shall witness all required hydrostatic tests.

Exception: Testing requirements shall not apply to alteration or repairs to existing piping systems in which the integrity of the piping is not affected. Such alterations shall be visually inspected for compliance with the approved construction documents.

[~~1704.19~~] 1705.24 High-pressure-gas piping. High-pressure-gas piping regulated in Section 406 of the *New York City Fuel Gas Code* shall be subject to special inspection in accordance with this section. Special inspection of seismic bracing shall be performed in accordance with Section [~~1707.7~~] 1705.12 of this code.

[~~1704.19.1~~] 1705.24.1 Welding. The special inspector shall verify the qualifications of the welder, the quality of the welding materials and equipment prior to welding operations. The special inspector shall review the proposed welding procedures for compliance with applicable standards listed in Section 406 of the *New York City Fuel Gas Code*.

[1704.19.2] 1705.24.2 Welding operations. The special inspector shall perform periodic special inspection for the pipe joining and welding operations in accordance with the above. Radiographic testing shall be performed to the connections as indicated in Section [406.4] 406 of the *New York City Fuel Gas Code*.

[1704.19.3] 1705.24.3 Testing of high-pressure-gas piping. Pressure testing shall be performed on the completed installation of new and altered systems in accordance with Section [406.4] 406 of the *New York City Fuel Gas Code*. The special inspector shall witness all required pressure tests.

[1704.20] 1705.25 Structural stability. ~~[Special inspection for structural stability]~~ Special inspection for structural stability is an inspection of a structure to verify the ability of such structural system to remain in position, or revert to the original position or another stable equilibrium position acceptable by this code, without incurring damage to the structural system from the activity or load to which it had been subjected until the completion of construction. Such special inspection shall be required for construction work as specified in this section or elsewhere in this code. Structural materials and methods of construction utilized in temporary protections shall be subject to special inspection when such materials and methods of construction would be subject to special inspection as a permanent installation in accordance with the applicable sections of this chapter, including but not limited to special [inspection] inspections for concrete, [welding] structural steel, and [pile driving] deep foundation installation. The registered design professional responsible for plans for a new building, alteration, or other work requiring structural stability inspections shall identify those areas on the plans submitted to the department in accordance with Section 1704.1.1.1. The means and methods of implementing the structural stability measures shall be prepared by a registered design professional and filed with the department where required in this section and elsewhere in this code.

Exception: Alterations consisting of the replacement of existing exterior ~~[window or door]~~ lintels located less than 75 feet (22 860 mm) above curb level spanning less than 4 feet ([1219] 1220 mm) and existing interior headers spanning less than 4 feet ([1219] 1220 mm), provided the size of the existing span is not increased, shall be exempt from special inspection for structural stability.

~~[1704.20.1 Soil percolation tests. Soil percolation tests shall be performed at the site of a proposed individual on-site private sewage disposal system installation to determine the suitability of the soil and site. Such test shall be performed under the supervision of a special inspector. The results of the percolation tests shall be filed on forms provided by the department, stating the suitability of the site and the capacity of the subsoil for the proposed use. The registered design professional of record for the dry well system shall be notified immediately if the results of the percolation test demonstrate that the approved system may not function as designed.]~~

~~[1704.20.1 Structural stability of]~~ **1705.25.1 Alterations to existing [buildings] structures.** Alterations to existing structures in which loads are transferred from one structural system of structural elements to another, such as installation of columns or girders, replacement of existing bearing walls, the creation of openings or slots in existing walls, girders or floors, alteration of arches, rigid frames, trusses in frame buildings, where the stability or integrity of a structural system is to be temporarily diminished, or where otherwise required by the commissioner, shall be subject to special inspections in accordance with Sections [1704.20.6] 1705.25.7 through [1704.20.10] 1705.25.10.

~~[1704.20.1.1]~~ **1705.25.2 Construction operations influencing adjacent structures.** Where construction operations have the potential to affect structurally the condition or occupancy of the subject structure and/or an adjacent structure, the structural stability of ~~the~~ such structures shall be subject to special inspections in accordance with Sections ~~[1704.20.6]~~ 1705.25.7 through ~~[1704.20.10]~~ 1705.25.10.

~~[1704.20.2]~~ **1705.25.3 Excavations.** Methods employed to protect the sides of excavations meeting the requirements of ~~Item~~ exception 1 of Section 3304.4.1, and blasting for the purpose of excavation shall be subject to special inspections in accordance with Sections ~~[1704.20.6]~~ 1705.25.7 through ~~[1704.20.10]~~ 1705.25.10.

~~[1704.20.2.1]~~ **1705.25.3.1 Slurry.** The proportions and installation of slurry mixtures to protect the sides of excavations shall be subject to special inspection. Slurry mix proportions and installation procedures shall be provided by a registered design professional, and the special inspection agency shall verify compliance with the approved procedures.

1705.25.3.2 New foundations. In addition to the special inspection for structural stability, any new foundation elements installed as part of support of excavation operations shall be subject to special inspection as a permanent installation in accordance with the applicable sections of this chapter, including, but not limited to, special inspection for concrete, structural steel, and deep foundation installation.

1705.25.3.3 Effect of blasting. Adjoining properties shall be subject to special inspection for structural stability due to the effects of blasting when blasting is utilized for excavation.

~~[1704.20.3]~~ **1705.25.4 Underpinning and alternate methods of support of buildings and adjacent property.** Underpinning of structures and alternate methods of support of buildings and adjacent property shall be subject to special inspections in accordance with Sections ~~[1704.20.6]~~ 1705.25.7 through ~~[1704.20.10]~~ 1705.25.10.

~~[1704.20.3.1]~~ **1705.25.4.1 New foundations.** In addition to the special inspection for structural stability, any new foundation elements installed as part of underpinning operations shall be subject to special inspection as a permanent installation in accordance with the applicable sections of this chapter, including, but not limited to, special inspection for concrete, ~~welding~~ structural steel, and ~~pile driving~~ deep foundation installation.

~~[1704.20.4]~~ **1705.25.5 Demolition.** Demolition operations shall be subject to special inspection in accordance with Sections 1705.25.5.1 and 1705.25.5.2 as applicable to the operations.

1705.25.5.1 Mechanical means and methods of demolition. Where mechanical demolition equipment, other than handheld devices, is to be used in the full or partial demolition of a building from within the building, or is to be used within the building to remove debris or move material, such demolition operation shall be subject to special inspection in accordance with Sections ~~[1704.20.6]~~ 1705.25.7 through ~~[1704.20.10]~~ 1705.25.10. The special inspector shall visit the site a minimum of three times: before demolition operations start, during demolition, and at the conclusion of demolition. Additionally, the special inspector shall visit the site at minimum intervals identified in the design documents and set forth in Section 1705.25.8.2.

1705.25.5.2 Other means of demolition. Where full or partial demolition of a weakened structure as specified in Section 3306.7 or the demolition of a masonry wall with a height to thickness ratio of 16 or greater is proposed, or the demolition of a floor structure directly supported by such wall, such demolition operation shall be subject to special inspection in accordance with Sections 1705.25.7 through 1705.25.10. The special inspector shall visit the site a minimum of three times: before demolition operations start, during demolition, and at the conclusion of demolition. Additionally, the special inspector shall visit the site at minimum intervals identified in the design documents and set forth in Section 1705.25.8.2.

~~[1704.20.5]~~ **1705.25.6 Raising and moving of a building.** A periodic special inspection shall be required in accordance with Sections ~~[1704.20.6]~~ 1705.25.7 through ~~[1704.20.10]~~ 1705.25.10 where the lowest above-grade floor or the lowest subgrade floor of a building is to be raised, lifted, elevated or moved.

~~[1704.20.6]~~ **1705.25.7 Inspection program.** Prior to commencement of work requiring special inspection per Section 1705.25, the special inspector shall review the approved construction documents, related reports, and contractor's [proposed] sequence of operations and [determine the] confirm that all areas of work [that require] requiring special inspection per Section 1705.25 have design documents addressing the structural stability temporary protections and sequence. A written statement shall be ~~[prepared, mutually acceptable to the contractor and the special inspector]~~ included in the design documents prepared in accordance with Section 1705.25.8, indicating:

1. The portions of work requiring design documents in accordance with Section ~~[1704.20.7]~~ 1705.25.8.
2. The names and addresses of the licensed professionals that have been engaged to supply design documents for applicable work.
3. ~~[The approximate dates for delivery of]~~ Where filing of plans is required, the application and permit numbers for the design documents for the applicable work.
4. A schedule of ~~[periodic]~~ special inspections, at agreed intervals, including adequate frequency to assure the contractor's continued compliance with the proposed designs and sequence of construction operations. At a minimum, the site must be inspected twice, once at a pre-construction meeting with the contractor and once during construction operations.

~~[1704.20.7]~~ **1705.25.8 Design documents.** Design documents, including shop drawings, sketches and written descriptions of proposed work regarding structural stability in construction operations shall be prepared by a registered design professional in the employ of the owner or the contractor. ~~[Such]~~ Where required by this section or elsewhere in this code, the work associated with the structural stability protection methods shall be filed with the department. When filing of the design of protection methods is not required, such designs may be revised at any time by the registered design professional. Copies of the special inspection log book, the design documents and revisions thereof, shall be maintained at the job site, and at the office of the special inspector, available for use and review at all reasonable times, until the work subject to special inspection is complete. In the case of alteration to existing structures, the structural stability design documents shall be reviewed by the registered design professional of record.

[1704.20.7.1] 1705.25.8.1 Monitoring. The design documents for structural stability shall include any requirements for monitoring of the subject structure and/or adjacent structures, as determined by the registered design professional responsible for the design. The monitoring plan shall be specific to the buildings to be monitored and operations to be undertaken, and shall specify the scope and frequency of monitoring, acceptable tolerances, and reporting criteria for when tolerances are exceeded, including when the department is required to be notified. The monitoring plan shall include provisions for daily monitoring, at a minimum, until the structural stability protection methods are no longer necessary. Such monitoring can be accomplished by remote means, in-person monitoring or any combination thereof.

1705.25.8.1.1 Additional monitoring requirements for demolition. The design documents for structural stability shall identify and specify the monitoring required for the demolition operation and be specific to all phases of the demolition operation. These specifications must be part of the requirements identified for special inspection.

1705.25.8.2 Additional requirements for design documents for demolition. Design documents for demolition shall indicate a project-specific required minimum interval for special inspections. A written statement of what the special inspection must include shall be provided on the design documents. The minimum special inspection interval must be incorporated into the demolition sequence. Building components and phases of demolition deemed to be structurally critical must be identified for inspection. A monitoring protocol must be provided in accordance with the requirements of Section 1705.25.8.1.1.

1705.25.8.3 Additional requirements for design documents for underpinning and alternate methods of support of buildings and adjacent property. Design documents for underpinning and alternate methods of support of buildings and adjacent property shall comply with the requirements of Section 1817. Such drawings shall indicate a project-specific required minimum interval for special inspections. A written statement of what the special inspection must include shall be provided on the design documents. The minimum special inspection interval must be incorporated into the sequence of operations. Building components and phases of operations deemed to be structurally critical must be identified for inspection. A monitoring protocol must be provided in accordance with the requirements of Section 1705.25.8.1.1. At a minimum, underpinning shall be subject to continuous special inspection for structural stability of the structure being underpinned while work is occurring.

1705.25.8.4 Additional requirements for design documents for protection of the sides of excavations and blasting. Design documents for protection of the sides of excavations and blasting methods of support of buildings and adjacent property shall indicate a project-specific required minimum interval for special inspections. A written statement of what the special inspection must include shall be provided on the design documents. The minimum special inspection interval must be incorporated into the sequence of operations. Building components and phases of operations deemed to be structurally critical must be identified for inspection. A monitoring protocol must be provided in accordance with the requirements of Section 1705.25.8.1.1. At a minimum, protection of the sides of excavations and blasting work shall be subject to continuous special inspection for structural stability of the structure or adjacent property being affected while work is occurring.

[1704.20.8] 1705.25.9 Inspection during construction operations. The special inspector shall visit the jobsite at agreed intervals, assess the ongoing work and verify that operations conform with the design documents. Deficiencies shall be reported as required by Section 1704.1.2. In the event unsafe conditions are discovered, the commissioner and the registered design professional employed by the contractor shall be immediately notified by the special inspector.

[1704.20.9] 1705.25.10 Records of special inspections. The special inspection logbook shall be maintained at the special inspector's office and shall contain the following information:

1. Project identification, application number and address.
2. Date and time of each inspection.
3. Names of personnel who performed each inspection.
4. Dates of on-site and off-site meetings, names of the participants and a summary of the conversations.
5. Any significant observations or instructions given related to structural stability in any of the following:
 - 5.1. Deviations from the design documents.
 - 5.2. Anticipated field conditions.
 - 5.3. Proper execution of the work.
 - 5.4. Safe jobsite conditions.
 - 5.5. Precautions taken to maintain safe conditions, if work is stopped for any reason.

1705.26 Tenant protection plan compliance. When alteration, partial demolition, or construction operations are performed at occupied multiple dwellings, the special inspector shall periodically verify compliance with a tenant protection plan as provided for in Chapter 1 of Title 28 of the Administrative Code and Section 3303.10 of this code. Special inspections for compliance with the tenant protection plan shall comply with Sections 1705.26.1 and 1705.26.2 of this code.

Exceptions: Special inspection for tenant protection plan compliance is not required where the scope of the work is limited to:

1. A three-family home;
2. The interior of a single dwelling unit of an occupied multiple dwelling with no disruption to the essential services of other units, where such dwelling is owner-occupied. For a dwelling unit within a property that is owned by a condominium or held by a shareholder of a cooperative corporation under a proprietary lease, the unit must be occupied by the owners of record for such unit; or

3. The interior of a single dwelling unit of an occupied multiple dwelling three stories or less in height.

1705.26.1 Inspection frequency. Special inspections shall be performed throughout the duration of the tenant protection plan at sufficient periodic intervals to verify compliance with the tenant protection plan throughout the course of work. At a minimum, inspections shall be performed:

1. Prior to the start of construction and/or demolition to document conditions prior to work;
2. At the start of construction and/or demolition;
3. Once per week during construction and/or demolition;
4. After a tenant protection plan violation has been issued to verify that the violation was corrected;
5. When the location of the alteration or construction operations performed in conjunction with the tenant protection plan has moved to another location; and
6. Whenever construction or demolition operations have changed, requiring changes in methods of protection.

1705.26.2 Reporting. A written record of the special inspections performed for the tenant protection plan shall be maintained in a log prepared by the special inspector. The log shall include an entry for each inspection and shall indicate that the alteration or construction operation is being performed in accordance with the tenant protection plan. Copies of the special inspection log book shall be maintained at the job site, and at the office of the special inspector, and shall be available for use and review at all reasonable times, until the work subject to special inspection is complete.

[1704.21] 1705.27 Private on-site storm water disposal systems and detention facilities. Storm water detention and retention systems required to comply with Section 1114 of the *New York City Plumbing Code*, and roof detention facilities shall be inspected for compliance with the provisions of this [sections] section.

[1704.21.1] 1705.27.1 Subsurface investigation special inspection. Soil borings, testpits and soil percolation testing shall be subject to the special inspection requirements of this section.

[1704.21.1.1] 1705.27.1.1 Soil borings and testpits. Prior to the approval of construction documents, soil borings and testpits shall be performed in accordance with the provisions of Section 1114.2.1 of the *New York City Plumbing Code*. Soil borings and testpits shall be performed under the supervision of a special inspector. The results of the soil borings and testpits shall be filed on forms provided by the department.

[1704.21.1.2] 1705.27.1.2 Soil percolation tests. Prior to the approval of construction documents, soil percolation tests shall be performed in accordance with the provisions of Section 1114.2.2 of the *New York City Plumbing Code* at the site of a proposed on-site stormwater drainage and detention facility installation to determine the suitability of the soil and site. Such test shall be performed under the supervision of a special inspector. The results

of the percolation tests shall be filed on forms provided by the department, stating the suitability of the site and the capacity of the subsoil for the proposed use. The registered design professional of record for the dry-well system shall be notified immediately if the results of the percolation test demonstrate that the system may not function as designed.

[1704.21.2] 1705.27.2 Installation special inspection. Private on-site stormwater disposal systems and detention facilities shall be inspected for conformance with the approved construction documents. Minor variations, based on actual site conditions, shall be acceptable at the discretion of the registered design professional of record. Verification shall include:

1. Materials of construction.
2. ~~[Bedding]~~ Compliance of bedding, per Section 306 of the *New York City Plumbing Code*, of pipe and facilities.
3. Placement and installation of fill materials.
4. Volume of drywell and detention facilities.
5. Installation of volume flow control devices.
6. Workmanship and quality of installation.
7. Overall conformance with the approved construction documents.
8. Detention tanks, and roofs used for stormwater detention, shall be filled with water to demonstrate water tightness for a 2-hour duration or as specified by the registered design professional or the manufacturer's specifications.

[1704.22] 1705.28 Individual on-site private sewage disposal systems. Individual on-site private sewage disposal systems shall be inspected in accordance with the rules of the department.

[1704.23] 1705.29 Sprinkler system special inspection. New and altered sprinkler ~~[system]~~ systems shall be inspected in accordance with Sections 903 and ~~[1704.23.1]~~ 1705.29.1. The permit holder responsible for the sprinkler work shall perform all required acceptance tests, complete and sign the appropriate contractor's material and test certifications. The special inspector shall witness all required tests and shall verify that all installations of all materials, fittings, hangers, assemblies and signage are in accordance with the approved construction documents, that painting of the sprinkler system required by Section 903.6 of this code has been performed and that the contractor has transmitted required maintenance literature and instruction to the owner. The special inspector shall verify that the material and test certification forms have been transmitted to the Fire Department and the Department of Buildings. Seismic bracing shall be inspected in accordance with Section ~~[1707.7]~~ 1705.12.

Exception: ~~[The special inspection agency need not witness the hydrostatic pressure test when such test is witnessed by the department.]~~ If the department witnesses a hydrostatic pressure test, it need not be witnessed by the special inspection agency.

[1704.23.1] 1705.29.1 Hydrostatic pressure testing. All new or altered sprinkler systems in buildings shall undergo successful hydrostatic pressure testing by a licensed master plumber or licensed fire suppression piping contractor in accordance with the requirements of this code, including Section 901.5 of this code, and NFPA 13.

Exceptions: Modification of six or fewer sprinklers:

1. May be tested under working pressure in lieu of hydrostatic testing, or
2. Need not be witnessed by a special inspection when the hydrostatic test is performed by the licensed installing contractor.

[1704.24] 1705.30 Standpipe system special inspection. New and altered standpipe systems shall be inspected in accordance with Sections 905 and ~~[1704.24.1]~~ 1705.30.1. Fire pump tests associated with standpipe systems shall be tested in accordance with Section 1705.30.2. The permit holder responsible for the standpipe work shall perform all required acceptance tests, and complete and sign the appropriate contractor's material and test certifications. The special inspector shall witness all required tests, verify that installation of all materials, fittings, hangers, assemblies and signage are in accordance with the approved construction documents, that painting of the standpipe system required by Section 905.11 ~~[of this code]~~ has been performed and that the contractor has transmitted required maintenance literature and instruction to the owner. The special inspector shall verify that the material and test certification forms have been transmitted to the Fire Department and the Department of Buildings. Seismic bracing shall be inspected in accordance with Section ~~[1707.7]~~ 1705.12.

Exception: The special inspection agency need not witness the hydrostatic pressure test ~~[shall not be required]~~ when such test is witnessed by the department.

~~[1704.24.1]~~ 1705.30.1 Hydrostatic pressure testing. All new or altered standpipe systems in buildings shall undergo successful hydrostatic pressure testing by a licensed master plumber or licensed fire suppression piping contractor in accordance with the requirements of this code, including Section 901.5, Sections ~~[1.1]~~ ~~[1704.24.1.1]~~ 1705.30.1.1 through ~~[1.5]~~ ~~[1704.24.1.5]~~ 1705.30.1.5 and NFPA 14.

Exception: When the standpipe system is exposed to freezing conditions, a hydrostatic pressure test required by this section may be postponed until such conditions no longer exist, notwithstanding any requirement that the standpipe be maintained in a state of readiness, provided that the system undergoes an interim test with dry nitrogen or air using a compressor in accordance with NFPA 14. Any such air pressure tests shall be witnessed by the special inspector unless witnessed by the department.

~~[1704.24.1.1]~~ 1705.30.1.1 New buildings under construction. For standpipes required to comply with Section 3303.8 of this code, an initial hydrostatic pressure test of the entire system shall be performed when the building reaches a height of 75 feet (22 860 mm) and additional successful hydrostatic pressure tests of the entire system shall be performed at 175 feet (53 340 mm), and at every 100 feet (30 480 mm) in height thereafter. The permit holder shall perform a final acceptance test of the completed system in accordance with the requirements of Section 901.5 ~~[of this code]~~.

[1704.24.1.2] 1705.30.1.2 Enlargements or additions to existing system. Where there is an enlargement that triggers a new standpipe system or there is an addition to an existing standpipe system, hydrostatic pressure tests of the entire system shall be performed for every 75 feet (22 860 mm) of additional height added to the system. The permit holder shall perform a final acceptance test of the completed system in accordance with the requirements of Section 901.5~~[-of this code]~~.

[1704.24.1.3] 1705.30.1.3 Removal of stories, including full demolitions. Where stories are removed from a building served by an existing standpipe system, hydrostatic pressure tests of the entire system shall be performed prior to the commencement of work.

[1704.24.1.4] 1705.30.1.4 Alterations. For alterations not covered under Sections ~~[1704.24.1.2]~~ 1705.30.1.2 or ~~[1704.24.1.3]~~ 1705.30.1.3 above, the permit holder shall perform a final acceptance test of the completed system in accordance with the requirements of Section 901.5~~[-of this code]~~.

[1704.24.1.5] 1705.30.1.5 Readiness. No standpipe system shall be considered in readiness until there has been a successful hydrostatic pressure test.

1705.30.2 Fire pump tests. Fire pump tests associated with standpipe systems shall be tested in accordance with Section 913.5 of this code. The special inspector shall witness all required tests and shall verify that all installations comply with NFPA 20 and are in accordance with the approved construction documents.

[1704.25] 1705.31 Heating systems. Special inspection shall be required for new and altered boilers and heating systems. All boilers and heating systems, including chimney connectors, shall be inspected for compliance with the approved construction documents. New heating systems shall be tested in accordance with Section 1011 of the *New York City Mechanical Code*. Alterations to heating systems shall be subjected to applicable tests for the altered portions of the system and to verify its satisfactory operation within the existing system. Special inspection of seismic bracing shall be performed in accordance with Section ~~[1707.7]~~ 1705.12 of this code.

Exception: Tests and inspections need not duplicate any valid tests or inspections previously certified by the commissioner or a duly authorized insurance company.

[1704.26] 1705.32 Chimneys and vents. New and altered chimneys and vents, replacing an existing appliance in accordance with Section 503.5.6 of the *New York City Fuel Gas Code*, or change in appliance in accordance with Section 507 of the *New York City Fuel Gas Code* and Section 807 of the *New York City Mechanical Code* shall be subject to special inspection. The chimney or vent shall be inspected to verify compliance with the approved construction documents, and proper clearance or isolation from adjacent combustible construction. Testing of the chimney or vent shall be performed as applicable in accordance with Section 810 of the *New York City Mechanical Code* and Section 503.5.6 of the *New York City Fuel Gas Code*. Special inspection of seismic bracing shall be performed in accordance with Section ~~[1707.7]~~ 1705.12 of this code.

Exception: ~~[A pressurized smoke test need not be performed on an existing negative pressure chimney if the lining of such chimney is not affected by alterations and the registered design professional specifies on the approved construction documents that such test does not need to be~~

~~performed on such chimney. Refer to Section 810 of the *New York City Mechanical Code* and Section 503.5.6 of the *New York City Fuel Gas Code* for smoke test requirements.] A pressurized smoke test need not be performed on existing and new Listed Type B gas vents and Type L vents. Listed Type B gas vents and Type L vents shall be visually inspected for the presence of a continuous inner wall, proper installation, and no damage or deterioration via readily accessible areas of the vent system, such as the appliance, tee caps, cleanout openings, or termination. The vent system shall be inspected for proper clearances, protection and damage.~~

1705.32.1 Reuse of existing chimneys. When a new heating system appliance is installed, the special inspector shall verify the condition of the existing chimney lining and breaching. Deficiencies shall be reported as required by Section 1704.1.1.2.

~~[1704.27 **Fire-resistant penetrations and joints.** Special inspections for through penetrations, membrane penetration firestops, fire resistant joint systems, and perimeter fire barrier systems that are tested and listed in accordance with Sections 713.4.1.1.2, 713.4.1.2, 714.3 and 714.4 shall comply with Sections 1704.27.1 and 1704.27.2.]~~

~~[1704.27.1 **Penetration firestops.** Inspections of penetration firestop systems that are tested and listed in accordance with Sections 713.4.1.1.2 and 713.4.1.2 shall be conducted by an approved special inspection agency in accordance with ASTM E 2174.]~~

~~[1704.27.2 **Joint systems.** Inspection of fire resistant joint systems that are tested and listed in accordance with Sections 714.3 and 714.4 shall be conducted by an approved special inspection agency in accordance with ASTM E 2393.]~~

[1704.28] 1705.33 Aluminum construction. The special inspections for structural aluminum elements of buildings and structures shall be as required by Section ~~[1704.28.1]~~ 1705.33.1.

~~[1704.28.1]~~ **1705.33.1 Welding operations.** All welding operations of aluminum elements shall be subject to special inspection for compliance with this code, AA ADM~~F~~ and AWS D1.2.

Exception: Welding operations in connections where the calculated stresses in the welds are less than 50 percent of the basic allowable values. Such connections shall be specifically indicated on the approved construction documents.

[1704.29] 1705.34 Flood zone compliance. Special inspection for flood zone compliance shall be as required by Appendix G of this code.

~~[1704.30 **Photoluminescent]**~~ **1705.35 Luminous exit path markings.** The installation of ~~[photoluminescent egress]~~ luminous exit path markings shall be subject to special inspection in accordance with the requirements of Section 1025.8. The special inspector shall verify that approved ~~[photoluminescent egress]~~ luminous exit path markings were provided and installed in accordance with ~~[department rules and regulations]~~ Section 1704, the approved construction documents, and manufacturer's instructions.

[1704.31] 1705.36 Emergency and standby power systems (generators). The installation of generators as part of emergency and standby power systems shall be subject to special inspection. The special inspector shall: perform visual inspections; verify that the installations of all materials,

equipment and signage complies with the installation standards; and verify that the installation of the generator and associated connections complies with the approved construction documents. The special inspector shall witness tests that verify the automatic operation of the emergency or standby power system in accordance with NFPA 110 and NFPA 111 [~~as such standards may have been amended by the *New York City Electrical Code* or this code~~]. Deficient results shall be rejected, and deficiencies shall be corrected and successfully retested in the presence of the special inspector prior to sign-off of the emergency or standby power system special inspection. Special inspection of seismic bracing shall be performed in accordance with Section [~~1707.7~~] 1705.12 of this code.

[~~1704.32~~] 1705.37 Post-installed anchors. The installation of post-installed mechanical anchors, adhesive anchors, and screw anchors shall comply with Table [~~1704.32~~] 1705.37. The special inspection shall include the verification of compliance with approved construction documents and standards established by the commissioner pursuant to Section 28-113.2.2 of the *Administrative Code*.

**TABLE [1704.32] 1705.37
REQUIRED VERIFICATION AND INSPECTION OF POST-INSTALLED ANCHORS**

[VERIFICATION AND INSPECTION] TYPE	CONTINUOUS SPECIAL INSPECTION	PERIODIC SPECIAL INSPECTION	REFERENCED STANDARD	BC REFERENCE
1. Preparation, placement, type, size and location of anchors, including other details of anchors, installed in hardened concrete, and installed to hardened concrete and to another construction.	[—]	[X]	[ACI 318: 3.8.6, 8.1.3, 15.8.3, 21.1.8]	[1912.1, 1908.1.9] <u>1901.1</u>
a. <u>Adhesive anchors installed horizontally or upwardly inclined orientations to resist sustained tension loads.</u>	X	=	<u>ACI 318 17.8.2.4</u> <u>ACI 318-11 D.9.2.4</u>	<u>1901.1</u>
b. <u>Mechanical anchors and adhesive anchors not defined in 1.a.</u>	=	X	<u>ACI 318 17.9.2</u>	<u>1901.1</u>
2. Preparation, placement, type, size and location of anchors, including other details of anchors, installed in masonry, and installed to masonry and to another construction.	—	X	Manufacturer's specifications and installation instructions	<u>Applicable department procedures</u>
3. Preparation, placement, type, size and location of anchors, including other details of anchors, installed in stone, and installed to stone and to another construction.	—	X	Manufacturer's specifications and installation instructions	

~~[1704.33 Tenant protection plan. When alteration, partial demolition, or construction operations are performed at occupied multiple dwellings, the department shall periodically verify compliance with a tenant protection plan as provided for in Chapter 1 of Title 28 of the Administrative Code and Section 3303.10.]~~

1705.38 Special inspection for nonpotable water systems. Testing and inspection of nonpotable water systems shall be in accordance with Chapter 13 of the *New York City Plumbing Code*. The special inspector shall witness all required tests in accordance with Chapter 13 of the *New York City Plumbing Code*.

1705.38.1 Tests for nonpotable water systems. Tests of nonpotable water systems shall be performed in accordance with Sections 1705.38.1.1 through 1705.38.1.2 of this code.

1704.38.1.1 Water storage tanks. Water storage tanks shall be tested in accordance with Sections 1302.12.2 and 1303.15.4 of the *New York City Plumbing Code*.

1705.38.1.2 Roofwashers. Roofwashers shall be tested in accordance with Section 1303.15.2 of the *New York City Plumbing Code*.

1705.38.2 Special inspection of nonpotable water systems. Inspections of nonpotable water systems shall include the following as applicable to the system:

1705.38.2.1 Visual inspection that components of such systems are complete in accordance with the manufacturers' instructions and the approved construction documents;

1705.38.2.2 Required labeling, operational instructions and safety signage properly posted.

1705.38.2.3 Inspection of vermin and insect protection. Inlets and vents to the system shall be inspected in accordance with Sections 1302.12.5 and 1303.15.7 of the *New York City Plumbing Code*.

1705.39 Special inspection for exhaust and vent systems in plenums and ducts. Chimneys, vents, and exhaust systems under positive pressure that penetrate ducts or plenums installed in accordance with exceptions 1 and 2 of Section 601.4 of the *New York City Mechanical Code* shall be inspected for conformance with the approved construction documents.

1705.39.1 Visual inspection. Visual inspection shall confirm that joints, seams, and connections of covered mechanical systems are securely fastened and sealed with welds, gaskets, mastics (adhesives), mastic-plus-embedded-fabric systems, liquid sealants or tapes.

1705.39.2 Smoke test. The special inspection shall include witnessing the system smoke test performed in accordance with Section 810 of the *New York City Mechanical Code*.

[SECTION BC 1705]

[RESERVED]

[SECTION BC 1706]

[RESERVED]

[SECTION BC 1707]

[SPECIAL INSPECTIONS FOR SEISMIC RESISTANCE]

~~[1707.1 Reserved.]~~

~~[1707.2 Reserved.]~~

~~[1707.3 Reserved.]~~

~~[1707.4 Reserved.]~~

~~[1707.5 Reserved.]~~

~~[1707.6 Reserved.]~~

~~[1707.7 Mechanical, plumbing, fuel gas, and electrical components. Special inspection for mechanical, plumbing, fuel gas, and electrical systems and equipment shall be as follows:]~~

- ~~[1. Periodic special inspection is required during the anchorage of electrical equipment for emergency or standby power systems in structures assigned to Seismic Design Category C or D.]~~

~~[2. Periodic special inspection is required during the installation of piping systems intended to carry flammable, combustible or highly toxic contents and their associated mechanical units in structures assigned to Seismic Design Category C or D.]~~

~~[3. Periodic special inspection is required during the installation of HVAC ductwork that will contain hazardous materials in structures assigned to Seismic Design Category C or D.]~~

~~[1707.8 Seismic isolation system. There shall be periodic special inspection during the fabrication and installation of isolator units and energy dissipation devices if used as part of the seismic isolation system.]~~

~~[SECTION BC 1708]~~

~~[RESERVED]~~

~~[SECTION BC 1709]~~

~~[RESERVED]~~

~~[SECTION BC 1710]~~

~~[RESERVED]~~

SECTION BC ~~[1711]~~ 1706 DESIGN STRENGTHS OF MATERIALS

~~[1711.1] 1706.1 Conformance to standards.~~ The design strengths and permissible stresses of any structural material that are identified by a manufacturer's designation as to manufacture and grade by mill tests, or the strength and stress grade is otherwise confirmed to the satisfaction of the commissioner shall conform to the specifications and methods of design of accepted engineering practice or the rules of the department in the absence of applicable standards.

~~[1711.2] 1706.2 New materials.~~ For materials that are not specifically provided for in this code, the design strengths and permissible stresses shall be established by tests as provided for in Section ~~[1712]~~ 1707.

SECTION BC ~~[1712]~~ 1707 ALTERNATIVE TEST PROCEDURE

~~[1712.1] 1707.1 General.~~ In the absence of rules or other approved standards, and upon special application by a registered design professional the commissioner shall make, or cause to be made, the necessary tests and investigations; or the commissioner shall accept duly authenticated reports from approved agencies in respect to the quality and manner of use of new materials or assemblies as provided for in Article 113 of Chapter 1 of Title 28 of the *Administrative Code*. The cost of all tests and other investigations required under the provisions of this code shall be borne by the permit applicant.

~~[SECTION BC 1713]~~

~~[TEST SAFE LOAD]~~

~~[1713.1 Where required. Where proposed construction is not capable of being designed by approved engineering analysis, or where proposed construction design method does not comply with~~

~~the applicable material design standard, the system of construction or the structural unit and the connections shall be subjected to the tests prescribed in Section 1715. The commissioner shall accept certified reports of such tests conducted by an approved testing agency, provided that such tests meet the requirements of this code and approved procedures.]~~

SECTION BC [1714] 1708 IN-SITU LOAD TESTS

[1714.1] 1708.1 General. Whenever there is a reasonable doubt as to the stability or load-bearing capacity of a completed building, structure or portion thereof for the expected loads, an engineering assessment shall be required. The engineering assessment shall involve either a structural analysis or an in-situ load test, or both. The structural analysis shall be based on actual material properties and other as-built conditions that affect stability or load-bearing capacity, and shall be conducted in accordance with the applicable design standard. If the structural assessment determines that the load-bearing capacity is less than that required by the code, load tests shall be conducted in accordance with Section [1714.2] 1708.2. If the building, structure or portion thereof is found to have inadequate stability or load-bearing capacity for the expected loads, modifications to ensure structural adequacy or the removal of the inadequate construction shall be required.

[1714.2] 1708.2 Test standards. Structural components and assemblies shall be tested in accordance with the appropriate material standards listed in Chapter 35. In the absence of a standard that contains an applicable load test procedure, the test procedure shall be developed by a registered design professional and approved. The test procedure shall simulate loads and conditions of application that the completed structure or portion thereof will be subjected to in normal use.

[1714.3] 1708.3 In-situ load tests. In-situ load tests shall be conducted in accordance with Section [1714.3.1] 1708.3.1 or [1714.3.2] Section 1708.3.2 and shall be supervised by a registered design professional. The test shall simulate the applicable loading conditions specified in Chapter 16 as necessary to address the concerns regarding structural stability of the building, structure or portion thereof.

[1714.3.1] 1708.3.1 Load test procedure specified. Where a standard listed in Chapter 35 contains an applicable load test procedure and acceptance criteria, the test procedure and acceptance criteria in the standard shall apply. In the absence of specific load factors or acceptance criteria, the load factors and acceptance criteria in Section [1714] 1708.3.2 shall apply.

[1714.3.2] 1708.3.2 Load test procedure not specified. In the absence of applicable load test procedures contained within a standard referenced by this code or acceptance criteria for a specific material or method of construction, such existing structure shall be subjected to a test procedure developed by a registered design professional that simulates applicable loading and deformation conditions. For components that are not a part of the seismic-load-resisting system, the test load shall be equal to two times the unfactored design loads. The test load shall be left in place for a period of 24 hours. The structure shall be considered to have successfully met the test requirements where the following criteria are satisfied:

1. Under the design load, the deflection shall not exceed the limitations specified in Section 1604.3.

2. Within 24 hours after removal of the test load, the structure shall have recovered not less than 75 percent of the maximum deflection.
3. During and immediately after the test, the structure shall not show evidence of failure.

SECTION BC [1715] 1709
PRECONSTRUCTION LOAD TESTS

[1715.1] 1709.1 General. In evaluating the physical properties of materials and methods of construction that are not capable of being designed by approved engineering analysis or do not comply with applicable material design standards listed in Chapter 35, the structural adequacy shall be predetermined based on the load test criteria established in this section.

[1715.2] 1709.2 Load test procedures specified. Where specific load test procedures, load factors and acceptance criteria are included in the applicable design standards listed in Chapter 35, such test procedures, load factors and acceptance criteria shall apply. In the absence of specific test procedures, load factors or acceptance criteria, the corresponding provisions in Section [1715.3] 1709.3 shall apply.

[1715.3] 1709.3 Load test procedures not specified. Where load test procedures are not specified in the applicable design standards listed in Chapter 35, the load-bearing and deformation capacity of structural components and assemblies shall be determined on the basis of a test procedure developed by a registered design professional that simulates applicable loading and deformation conditions. For components and assemblies that are not a part of the seismic-load-resisting system, the test shall be as specified in Section [1715.3.1] 1709.3.1. Load tests shall simulate the applicable loading conditions specified in Chapter 16.

[1715.3.1] 1709.3.1 Test procedure. The test assembly shall be subjected to an increasing superimposed load equal to not less than two times the superimposed design load. The test load shall be left in place for a period of 24 hours. The tested assembly shall be considered to have successfully met the test requirements if the assembly recovers not less than 75 percent of the maximum deflection within 24 hours after the removal of the test load. The test assembly shall then be reloaded and subjected to an increasing superimposed load until either structural failure occurs or the superimposed load is equal to two and one-half times the load at which the deflection limitations specified in Section [1715.3.2] 1709.3.2 were reached, or the load is equal to two and one-half times the superimposed design load. In the case of structural components and assemblies for which deflection limitations are not specified in Section [1715.3.2] 1709.3.2, the test specimen shall be subjected to an increasing superimposed load until structural failure occurs or the load is equal to two and one-half times the desired superimposed design load. The allowable superimposed design load shall be taken as the lesser of:

1. The load at the deflection limitation given in Section [1715.3.2] 1709.3.2.
2. The failure load divided by 2.5.
3. The maximum load applied divided by 2.5.

[1715.3.2] 1709.3.2 Deflection. The deflection of structural members under the design load shall not exceed the limitations in Section 1604.3.

[1715.4] 1709.4 Wall and partition assemblies. Load-bearing wall and partition assemblies shall sustain the test load both with and without window framing. The test load shall include all design load components. Wall and partition assemblies shall be tested both with and without door and window framing.

[1715.5] 1709.5 Exterior window and door assemblies. The design pressure rating of exterior windows and doors in buildings shall be determined in accordance with Section ~~[1715.5.1]~~ 1709.5.1 or ~~[1715.5.2]~~ Section 1709.5.2.

Exception: Structural wind load design pressures for window units smaller than the size tested in accordance with Section ~~[1715.5.1]~~ 1709.5.1 or ~~[1715.5.2]~~ Section 1709.5.2 shall be permitted to be higher than the design value of the tested unit provided such higher pressures are determined by accepted engineering analysis. All components of the small unit shall be the same as the tested unit. Where such calculated design pressures are used, they shall be validated by an additional test of the window unit having the highest allowable design pressure.

~~[1715.5.1]~~ 1709.5.1 Exterior windows and doors. Exterior windows and doors shall be tested and labeled as conforming to AAMA/WDMA/CSA 101/I.S.2/A440. The label shall state the name of the manufacturer, the approved labeling agency and the product designation as specified in AAMA/WDMA/CSA 101/I.S.2/A440. Products tested and labeled as conforming to ~~[AAMA/NWDA 101/I.S.2]~~ AAMA/WDMA/CSA 101/I.S.2/A440 shall not be subject to the requirements of Sections 2403.2 and 2403.3.

~~[1715.5.2]~~ 1709.5.2 Exterior windows and door assemblies not provided for in Section ~~[1715.5.1]~~ 1709.5.1. Exterior window and door assemblies shall be tested in accordance with ASTM E 330. Structural performance of garage doors shall be determined in accordance with either ASTM E 330 or ANSI/DASMA 108, and shall meet the acceptance criteria of ANSI/DASMA 108. Exterior window and door assemblies containing glass shall comply with Section 2403 of this code. The design pressure for testing shall be calculated in accordance with Chapter 16 of this code. Each assembly shall be tested for 10 seconds at a load equal to 1.5 times the design pressure.

1709.6 Skylights and sloped glazing. Skylights and sloped glazing shall comply with the requirements of Chapter 24.

[1715.6] 1709.7 Test specimens. Test specimens and construction shall be representative of the materials, workmanship and details normally used in practice. The properties of the materials used to construct the test assembly shall be determined on the basis of tests on samples taken from the load assembly or on representative samples of the materials used to construct the load test assembly. Required tests shall be conducted or witnessed by an approved agency.

SECTION BC 1710
TEST SAFE LOAD

1710.1 Where required. Where proposed construction is not capable of being designed by approved engineering analysis, or where proposed construction design method does not comply with the applicable material design standard, the system of construction or the structural unit and the connections shall be subjected to the tests prescribed in Section 1711. The commissioner shall accept certified reports of such tests conducted by an approved testing agency, provided that such tests meet the requirements of this code and approved procedures.

SECTION BC ~~[4746]~~ 1711
MATERIAL AND TEST STANDARDS

~~[1716.1] 1711.1~~ Test standards for joist hangers and connectors. Test standards for joist handlers and connectors shall be in accordance with Sections 1711.1.1 through 1711.2.2.

~~[1716.1.1] 1711.1.1~~ Test standards for joist hangers. The vertical load-bearing capacity, torsional moment capacity and deflection characteristics of joist hangers shall be determined in accordance with ASTM D 1761, using lumber having a specific gravity of 0.49 or greater, but not greater than 0.55, as determined in accordance with AF&PA NDS for the joist and headers.

Exception: The joist length shall not be required to exceed 24 inches (~~[640]~~ 609.6 mm).

~~[1716.1.2] 1711.1.2~~ Vertical load capacity for joist hangers. The vertical load capacity for the joist hanger shall be determined by testing a minimum of three joist hanger assemblies as specified in ASTM D 1761. If the ultimate vertical load for any one of the tests varies more than 20 percent from the average ultimate vertical load, at least three additional tests shall be conducted. The allowable vertical load of the joist hanger shall be the lowest value determined from the following:

1. The lowest ultimate vertical load for a single hanger from any test divided by three (where three tests are conducted and each ultimate vertical load does not vary more than 20 percent from the average ultimate vertical load).
2. The average ultimate vertical load for a single hanger from all tests divided by six (where six or more tests are conducted).
3. The average from all tests of the vertical loads that produce a vertical movement of the joist with respect to the header is 0.125 inch (3.2 mm).
4. The sum of the allowable design loads for nails or other fasteners utilized to secure the joist hanger to the wood members and allowable bearing loads that contribute to the capacity of the hanger.
5. The allowable design load for the wood members forming the connection.

~~[1716.1.3] 1711.1.3~~ Torsional moment capacity for joist hangers. The torsional moment capacity for the joist hanger shall be determined by testing at least three joist hanger assemblies as specified in ASTM D 1761. The allowable torsional moment of the joist hanger shall be the

average torsional moment at which the lateral movement of the top or bottom of the joist with respect to the original position of the joist is 0.125 inch (3.2 mm).

[1716.1.4] 1711.1.4 Design value modifications for joist hangers. Allowable design values for joist hangers that are determined by Item 4 or 5 in Section [1716.1.2] 1711.1.2 shall be permitted to be modified by the appropriate duration of loading factors as specified in AF&PA NDS but shall not exceed the direct loads as determined by Item 1, 2 or 3 in Section [1716.1.2] 1711.1.2. Allowable design values determined by Item 1, 2 or 3 in Section [1716.1.2] 1711.1.2 shall not be modified by duration of loading factors.

[1716.2] 1711.2 Concrete and clay roof tiles. Concrete and clay roof tiles shall be tested in accordance with Sections 1711.2.1 and 1711.2.2.

[1716.2.1] 1711.2.1 Overturning resistance. Concrete and clay roof tiles shall be tested to determine their resistance to overturning due to wind in accordance with ICC SBCCI SSTD 11 and Chapter 15.

[1716.2.2] 1711.2.2 Wind tunnel testing. When roof tiles do not satisfy the limitations in Chapter 16 for rigid tile, a wind tunnel test shall be used to determine the wind characteristics of the concrete or clay tile roof covering in accordance with ICC SBCCI SSTD 11 and Chapter 15.

§ 19. Chapter 18 of the New York city building code as added by local law number

141 for the year 2013, is amended to read as follows:

CHAPTER 18 SOILS AND FOUNDATIONS

SECTION BC 1801 GENERAL [~~AND DEFINITIONS~~]

1801.1 Scope. The provisions of this chapter shall apply to building and foundation systems in those areas not subject to scour or water pressure by wind and wave action. Buildings and foundations subject to such scour or water pressure loads shall be designed in accordance with Chapter 16 and Appendix G. [(Note: Where the text in this Code refers to ASCE 7, the 2005 edition shall be used; and where the text in this Code refers to ASCE 7-10, the 2010 edition shall be used.)]

1801.2 Design. Allowable bearing pressures, allowable stresses and design formulas provided in this chapter shall be used with the allowable stress design load combinations specified in Section 1605.3. The quality and design of materials used structurally in excavations and foundations shall [~~conform to~~] comply with the requirements specified in Chapters 16, 19, 21, 22 and 23. Excavations and fills shall also comply with Chapter 33.

1801.2.1 Foundation design for seismic overturning. Where foundations are proportioned using the load combinations of Sections 1605.2 or 1605.3.1 and the computation of seismic overturning effects is by equivalent lateral force or modal analysis, the proportioning shall be in accordance with Section 12.13.4 of ASCE [~~7-10~~] 7.

SECTION BC 1802
DEFINITIONS

~~[1801.3 Definitions.] 1802.1 General.~~ The following terms ~~[shall, for the purposes of this chapter, have the meanings shown herein.]~~ are defined in Chapter 2:

AUGERED-CAST-IN-PLACE PILES. ~~[Augered cast in place piles are constructed by pumping grout into an augered hole during the withdrawal of the auger. The pile is reinforced with a single reinforcing bar, a reinforcing steel cage or a structural steel section.]~~

CAISSON PILES. ~~[Steel cased piles constructed by advancing a steel shell seated into rock and drilling of an uncased socket within the rock. The shell and socket are filled with a steel core section or steel reinforcing, and concrete or grout.]~~

COMPACTED CONCRETE PILES. ~~[Compacted concrete piles are constructed by filling a driven casing with low strength concrete and compacting the concrete as the casing is withdrawn.]~~

COMPOSITE PILES. ~~[Composite piles consist of two or more approved pile types joined together.]~~

CONCRETE-FILLED STEEL PIPE AND TUBE PILES. ~~[Concrete filled steel pipe and tube piles are constructed by driving a steel pipe or tube section into the soil and filling the pipe or tube section with concrete. The steel pipe or tube section is left in place during and after the deposition of the concrete. For the purposes of this code these piles shall be considered driven piles.]~~

DAMPPROOFING. ~~[Dampproofing is a protective measure applied to building foundation walls and slabs to prevent moisture from passing into interior spaces.]~~

DEEP FOUNDATIONS. ~~[Deep foundations are comprised of concrete, grout, wood or steel structural elements either driven, drilled or jacked into the ground or cast in place. Deep foundations are relatively slender in comparison to their length, with lengths exceeding 12 times the least horizontal dimension. Deep foundations derive their load carrying capacity through skin friction, end bearing, or a combination thereof.]~~

DRILLED DISPLACEMENT PILES.

DRIVEN UNCASSED PILES. ~~[Driven uncased piles are constructed by driving a steel shell into the soil to shore an unexcavated hole that is later filled with concrete. The steel casing is lifted out of the hole during the deposition of the concrete. Driven uncased piles are not permitted under the provisions of this code.]~~

ENLARGED BASE PILES. ~~[Enlarged base piles are cast in place concrete piles constructed with a base that is larger than the diameter of the remainder of the pile. The enlarged base is designed to increase the load bearing area of the pile in end bearing. Enlarged base piles include piles installed by driving a precast concrete tip or by compacting concrete into the base of the pile to form an enlarged base.]~~

[HELICAL PILES. Helical piles are manufactured deep foundation steel elements consisting of a shaft and one or more helical bearing plates (helices) screwed into the ground by application of

~~torque on the shaft. The various products marketed as screw piles, torque anchors, and helical piers are considered helical piles.]~~

~~[**H-PILES.** Steel H piles are constructed by driving a steel H shaped section into the ground.]~~

~~**FIXED HEADED PILE (DEEP FOUNDATION).** [A pile connected to a pile cap in a manner that prevents rotation of the pile head.]~~

~~**FREE HEADED PILE.** [A pile with a head that is free to rotate.]~~

~~**GEOTECHNICAL CAPACITY OF DEEP FOUNDATIONS.** [The load that can be supported by the soil or rock surrounding deep foundation as determined using a recognized method of analysis or as established by load tests. The geotechnical capacity can be developed through skin friction, end bearing, or a combination thereof.]~~

HELICAL PILES.

H-PILES.

~~**LIQUEFACTION.** [For granular soils, liquefaction is defined as the loss of shear strength in soils resulting from increased pore water pressure and reduced effective stress that may develop as a result of cyclic loading during earthquakes. For cohesive soils with a plasticity index of less than 20, liquefaction is defined as any transient softening and increased cyclic shear strains that may occur during earthquakes.]~~

~~**MICROPILE.** [A micropile is a drilled and grouted deep foundation element with a diameter that measures 5 inches (127 mm) to 14 inches (356 mm) that develops its load carrying capacity by means of a bond zone in soil (also commonly known as a minipile).]~~

PERMANENT PRESTRESSED ROCK AND SOIL ANCHORS.

~~**PIER FOUNDATION.** [A pier foundation is a shallow foundation element of masonry or cast-in-place concrete construction. Piers are relatively short in comparison to their width, with lengths less than or equal to 12 times the least horizontal dimension of the pier. Piers derive their load-carrying capacity from end bearing on soil or rock.]~~

~~**RETAINING WALL.** [A wall that resists lateral or other forces caused by soil, rock, water or other materials, thereby limiting lateral displacement and the movement of the supported materials. Basement walls and vault walls that are parts of buildings and underground structures, including but not limited to utility vault structures, tunnels and transit stations, are not considered retaining walls.]~~

~~**SHALLOW FOUNDATION.** [A shallow foundation is an individual or strip footing, a mat foundation, a slab on grade foundation or a similar foundation element.]~~

~~**UNDERPINNING.** [The alteration of an existing foundation to transfer loads to a lower bearing stratum using new piers, piles, or other structural support elements installed below the existing foundation.]~~

WATERPROOFING. [~~Waterproofing is a protective measure applied to building foundation walls and slabs to prevent moisture and liquid water from passing into interior spaces.~~]

SECTION BC [1802] 1803
GEOTECHNICAL INVESTIGATIONS AND MATERIAL CLASSIFICATIONS

~~[1802.1]~~ **1803.1 General.** Geotechnical investigations shall be subject to special inspections in accordance with Sections [~~1704.7, 1704.8 and 1704.9~~] 1705.6, 1705.7 and 1705.19 and be conducted in [~~conformance~~] accordance with Sections [~~1802.2~~] 1803.2 through [~~1802.7~~] 1803.7. An engineer shall scope, supervise and approve the subsurface investigation and the classification of the soil and rock encountered.

~~[1802.2]~~ **1803.2 Where required.** A geotechnical investigation shall be performed and report shall be prepared [~~conducted~~] for:

1. New structures;
2. Horizontal enlargements;
3. Vertical enlargements or alterations necessitating new foundations or resulting in additional loading that exceeds 5 percent of the existing foundation design capacity; or
4. As required by the commissioner or applicant of record.

The geotechnical investigation shall be performed in accordance with Sections [~~1802.4~~] 1803.4 through [~~1802.6~~] 1803.6. For structures in Seismic Design Category C or D, the requirements of Sections [~~1802.2.1~~] 1803.2.1 and [~~1802.2.2~~] 1803.2.2 shall also apply.

~~[1802.2.1]~~ **1803.2.1 Seismic Design Category C.** [~~Where a structure is determined to be in]~~ For structures assigned to Seismic Design Category C in accordance with Section 1613, the geotechnical investigation shall include an evaluation of the following potential geologic and seismic hazards [~~resulting from earthquake motions: slope instability, liquefaction and surface rupture due to faulting or lateral spreading. Peak ground acceleration for use in liquefaction analyses shall be determined in accordance with Section 1813.2.1.~~];

1. Slope instability.
2. Liquefaction. Peak ground accelerations for use in such analyses shall be determined in accordance with Section 1816.2.1.
3. Total and differential settlement.
4. Surface displacement due to faulting or seismically induced lateral spreading or lateral flow.

~~[1802.2.2]~~ **1803.2.2 Seismic Design Category D.** [~~Where a structure is determined to be in]~~ For structures assigned to Seismic Design Category D in accordance with Section 1613, the [~~requirements for Seismic Design Category C, given in]~~ geotechnical investigation shall meet the

requirements of Section [1802.2.1, shall be met. In addition, the following shall be conducted]
1803.2.1 and the following as applicable:

1. A determination of dynamic seismic lateral earth pressures on [basement, cellar,] foundation walls and retaining walls supporting more than 6 feet (1828.8 mm) of in situ soil or backfill height due to design earthquake ground motions. Peak ground acceleration for use in lateral pressure analyses shall be determined in accordance with Section [1813.2.1] 1816.2.1.
2. The potential for liquefaction and soil strength loss evaluated for site peak ground acceleration, earthquake magnitude and source characteristics consistent with the maximum considered earthquake ground motions. Peak ground accelerations for use in such analyses shall be determined in accordance with Section 1816.2.1.
3. An assessment of potential consequences of [any] liquefaction and soil strength loss[;] including [estimation of differential settlement, lateral movement or reduction in foundation soil bearing capacity. Mitigation measures shall be addressed. Such measures shall be given consideration in the design of the structure and shall include, but are not limited to, ground stabilization, selection of appropriate foundation type and depths, selection of appropriate structural systems to accommodate anticipated displacements or any combination of these measures.], but not limited to, the following:
 - 3.1. Estimation of differential settlement.
 - 3.2. Lateral soil movement.
 - 3.3. Lateral soil loads on foundations.
 - 3.4. Reduction in foundation soil-bearing capacity and lateral soil reaction
 - 3.5. Soil downdrag and reduction in axial and lateral soil reaction for pile foundations.
 - 3.6. Increases in soil lateral pressures on retaining walls.
 - 3.7. Flotation of buried structures.
4. Discussion of mitigation measures such as, but not limited to, the following:
 - 4.1. Selection of appropriate foundation type and depths.
 - 4.2. Selection of appropriate structural systems to accommodate anticipated displacements and forces.
 - 4.3. Ground stabilization.
 - 4.4. Any combination of these measures and how they shall be considered in the design of the structure.

~~[1802.3]~~ **1803.3 Material classification.** Soil and rock classification shall be based on materials disclosed by borings, test pits or other subsurface exploration methods. Soil classifications shall be determined in accordance with ASTM D2487 (refer to Table ~~[1802.3]~~ 1803.3) and the supplemental definitions contained herein. Rock classifications shall be determined in accordance with generally accepted engineering practice and the supplemental definitions contained herein. Laboratory tests shall be conducted to ascertain these classifications where deemed necessary by the engineer responsible for the geotechnical investigation or the commissioner.

BEDROCK.

1. **Hard sound rock (Class 1a).** Includes crystalline rocks, such as gneiss, granite, diabase and mica schist. Characteristics are as follows: the rock rings when struck with pick or bar; the rock does not disintegrate after exposure to air or water; the rock breaks with sharp fresh fracture; cracks are unweathered, less than 1/8-inch (3.2 mm) wide, and generally no closer than 3 feet (~~[914]~~ 914.4 mm) apart; and the RQD (rock quality designation) with a double tube, NX-size diamond core barrel is generally 85 percent or greater for each 5-foot (1524 mm) run; or core recovery with BX-size core is generally 85 percent or greater for each 5-foot (1524 mm) run.
2. **Medium hard rock (Class 1b).** Includes crystalline rocks of paragraph ~~[(1)1]~~ of this subdivision, plus marble and serpentinite. Characteristics are as follows: all those listed in paragraph ~~[(1)1]~~ of this subdivision, except that cracks may be 1/4-inch (6.4 mm) wide and slightly weathered, generally spaced no closer than 2 feet (~~[(610)]~~ 609.6 mm) apart; and the RQD with a double tube, NX-size diamond core barrel is generally between 50 and 85 percent for each 5-foot (1524 mm) run; or core recovery with BX-size core is generally 50 to 85 percent for each 5-foot (1524 mm) run.
3. **Intermediate rock (Class 1c).** Includes rocks described in paragraphs ~~[(1)1]~~ and ~~[(1)2]~~ of this subdivision, plus cemented shales and sandstone. Characteristics are as follows: the rock gives dull sound when struck with pick or bar; does not disintegrate after exposure to air or water; broken pieces may show moderately weathered surfaces; may contain fracture and moderately weathered zones up to 1 inch (~~[(25)]~~ 25.4 mm) wide spaced as close as 1 foot (~~[(305)]~~ 304.8 mm) apart; and the RQD with a double tube, NX-size diamond core barrel is generally 35 to 50 percent for each 5-foot (1524 mm) run; or a core recovery with BX-size core of generally 35 to 50 percent for each 5-foot (1524 mm) run.
4. **Soft rock (Class 1d).** Includes rocks described in paragraphs ~~[(1)1]~~, ~~[(1)2]~~, and ~~[(1)3]~~ of this subdivision in highly weathered condition, plus talc schist and poorly cemented shales and sandstones. Characteristics are: rock may soften on exposure to air or water; may contain highly weathered zones up to 3 inches (~~[(76)]~~ 76.2 mm) wide but filled with stiff soil; and either the RQD with a double tube, NX-size diamond core barrel is less than 35 percent for each 5-foot (1524 mm) run or core recovery with BX-size core of generally less than 35 percent for each 5-foot (1524 mm) run, or a ~~[standard penetration resistance more]~~ value of N_{60} greater than 50 blows per foot (0.3 meters).

SANDY GRAVEL AND GRAVELS. Consists of coarse-grained material with more than half of the coarse fraction larger than the #4 size sieve and contains little or no fines (GW and GP). The density of these materials shall be determined in accordance with the following:

Dense (Class 2a). These materials have [~~a standard penetration test N-value~~] a value of N_{60} greater than 30 blows per 1 foot (0.3 meter).

Medium (Class 2b). These materials have [~~a standard penetration test N-value~~] a value of N_{60} between 10 and 30 blows per 1 foot (0.3 meter).

Loose (Class 6). These materials have [~~a standard penetration test N-value~~] a value of N_{60} less than 10 blows per 1 foot (0.3 meter). These materials shall be considered nominally unsatisfactory bearing materials.

GRANULAR SOILS. These materials are coarse-grained soils consisting of gravel and/or sand with appreciable amounts of fines[~~;~~] and gravel. Soil types include GM, GC, SW, SP, SM[~~;~~] and SC. The density of granular materials shall be determined in accordance with the following:

Dense (Class 3a). These materials have [~~a standard penetration test N-value of~~] a value of N_{60} greater than 30 blows per 1 foot (0.3 meter).

Medium (Class 3b). These materials have [~~a standard penetration test N-value of~~] a value of N_{60} between 10 and 30 blows per 1 foot (0.3 meter).

Loose (Class 6). These materials have [~~standard penetration test N-value of fewer~~] a value of N_{60} less than 10 blows per 1 foot (0.3 meter). These materials shall be considered nominally unsatisfactory bearing materials.

CLAYS. For soil types SC, CL and CH in the absence of sufficient laboratory data, the consistency of clay materials shall be determined in accordance with the following:

Hard (Class 4a). Clay requiring picking for removal, a fresh sample of which cannot be molded by pressure of the fingers; or having an unconfined compressive strength in excess of 4 TSF (383 kPa); or having a [~~standard penetration test where the N-value is~~] value of N_{60} greater than 30 blows per 1 foot (0.3 meter).

Stiff (Class 4b). Clay that can be removed by spading, a fresh sample of which requires substantial pressure of the fingers to create an indentation; or having an unconfined compressive strength of between 1 TSF ([~~96~~] 95.8 kPa) and 4 TSF (383 kPa); or having a [~~standard penetration test where the N-value is~~] value of N_{60} between 8 and 30 blows per 1 foot (0.3 meter).

Medium (Class 4c). Clay that can be removed by spading, a fresh sample of which can be molded by substantial pressure of the fingers; or having an unconfined compressive strength of between 0.5 TSF ([~~48~~] 47.9 kPa) and 1 TSF ([~~96~~] 95.8 kPa); or having a [~~standard penetration test where the N-value is~~] value of N_{60} between 4 and 8 blows per 1 foot (0.3 meter).

Soft (Class 6). Clay, a fresh sample of which can be molded with slight pressure of the fingers; or having an unconfined compressive strength of less than 0.5 TSF ([~~48~~] 47.9 kPa); or having a [~~standard penetration test where the N-value is fewer~~] a value of N_{60} less than 4 blows per 1 foot (0.3 meter). This material shall be considered nominally unsatisfactory bearing material.

SILTS AND CLAYEY SILTS. For soil types ML and MH in the absence of sufficient laboratory data, the consistency of silt materials shall be determined in accordance with the following:

Dense (Class 5a). Silt with a standard penetration test where the ~~[N-value is]~~ value of N_{60} greater than 30 blows per 1 foot (0.3 meter).

Medium (Class 5b). Silt with a standard penetration test where the ~~[N-value is]~~ value of N_{60} between 10 and 30 blows per 1 foot (0.3 meter).

Loose (Class 6). Silt with a standard penetration test where the ~~[N-value is]~~ value of N_{60} fewer than 10 blows per 1 foot (0.3 meters). This material shall be considered nominally unsatisfactory bearing material.

TABLE [1802.3] 1803.3
UNIFIED SOIL CLASSIFICATION (Including Identification and Description)

MAJOR DIVISIONS		GROUP SYMBOLS	TYPICAL NAMES	FIELD IDENTIFICATION PROCEDURES (EXCLUDING PARTICLES LARGER THAN 3 IN. AND BASING FRACTIONS ON ESTIMATED WEIGHTS)			INFORMATION REQUIRED FOR DESCRIBING SOILS	LABORATORY CLASSIFICATION CRITERIA	
1	2	3	4	5			6	7	
Coarse-grained Soils More than half of material is larger than No. 200 sieve size. The No. 200 sieve size is about the smallest visible to the naked eye.	Gravels More than half of coarse fraction is larger than No. 4 sieve size. (For visual classification, the 1/4-in. size may be used as equivalent to the No. 4 sieve size.)	Clean Gravels (Little or no fines)	GW	Well-graded gravels, gravel-sand mixture, little or no fines.	Wide range in grain size and substantial amounts of all intermediate particle sizes.			For undisturbed soils add information on stratification, degree of compactness, cementation, moisture condition, and drainage characteristics. Give typical name; indicate approximate percentages of sand and gravel, maximum size; angularity, surface condition, and hardness of the coarse grains; local or geologic name and other pertinent descriptive information; and symbol in parentheses. Example: Silty sand, gravelly; about 20% hard, angular gravel particles 1/2-in. maximum size; rounded and subangular sand grains, coarse to fine; about 15% nonplastic fines with low dry strength; well compacted and moist in place; alluvial sand; (SM).	$C_u = \frac{D_{60}}{D_{10}}$ Greater than 4 $C_e = \frac{(D_{30})^2}{D_{10} \times D_{60}}$ Between 1 and 3 Not meeting all gradation requirements for GW Atterberg limits below "A" line or PI less than 4 Atterberg limits above "A" line with PI greater than 7 $C_u = \frac{D_{60}}{D_{10}}$ Greater than 6 $C_e = \frac{(D_{30})^2}{D_{10} \times D_{60}}$ Between 1 and 3 Not meeting all gradation requirements for SW Atterberg limits above "A" line or PI less than 4 Atterberg limits above "A" line with PI greater than 7
			GP	Poorly graded gravels or gravel-sand mixture, little or no fines.	Predominantly one size or a range of sizes with some intermediate sizes missing.				
		Gravels with Fines (Appreciable amount of fines)	GM	Silty gravels, gravel and silt mixtures.	Nonplastic fines or fines with low plasticity (for identification procedures see ML below).				
			GC	Clayey gravels, gravel and clay mixtures.	Plastic fines (for identification procedures see CL below).				
		Clean Sand (Little or no fines)	SW	Well-graded sands, gravelly sands, little or no fines.	Wide range in grain size and substantial amounts of all intermediate particle sizes.				
			SP	Poorly graded sands or gravelly sands, little or no fines.	Predominantly one size or a range of sizes with some intermediate sizes missing.				
	Sands More than half of coarse fraction is smaller than No. 4 sieve size. (For visual classification, the 1/4-in. size may be used as equivalent to the No. 4 sieve size.)	Sands with Fines (Appreciable amount of fines)	SM	Silty sands, sand-silt mixtures.	Nonplastic fines or fines with low plasticity (for identification procedures see ML below).				
			SC	Clayey sands, sand-clay mixtures.	Plastic fines (for identification procedures see CL below).				
		Identification Procedure on Fraction Smaller than No. 40 Sieve Size.			Dry Strength (Crushing Characteristics)	Dilatancy (Reaction to shaking)	Toughness (Consistency near PL)		
			Silts and Clays Liquid limit is less than 50	ML	Inorganic silts and very fine sands, rock flour, silty or clayey fine sands or clayey silts with slight plasticity.	None to slight	Quick to slow	None	
CL	Inorganic clays of low to medium plasticity, gravelly clays, sandy clays, silty clays, lean clays.	Medium to high		None to very slow	Medium				
Silts and Clays Liquid limit is greater than 50	OL	Organic silts and organic silty clays of low plasticity.	Slight to medium	Slow	Slight				
	MH	Inorganic silts, micaceous or diatomaceous fine sandy or silty soils, elastic silts.	Slight to medium	Slow to none	Slight to medium				
	CH	Inorganic clays of high plasticity, fat clays.	High to very high	None	High				
	OH	Organic clays of medium to high plasticity, organic silts.	Medium to high	None to very slow	Slight to medium				
Highly Organic Soils		Pt	Peat and other highly organic soils.	Readily identified by color, odor, spongy feel and frequently by fibrous texture					

1. Boundary classifications: Soils possessing characteristics of two groups are designed by combinations of group symbols. For example GM-GC, well-graded gravel-sand mixture with clay binder.

2. All sieve sizes on this chart are U.S. standard.

3. Adopted by Corps of Engineers and Bureau of Reclamation, January 1952.

LIQUID LIMIT PLASTICITY CHART
 For laboratory classification of fine-grained soils

Comparing Soils of Equal Liquid Limit
 Toughness and Dry Strength Increase
 with Increasing Plasticity Index.

032058C

[1802.4] 1803.4 Investigation. An engineer shall scope and supervise the geotechnical investigation. The geotechnical investigation shall be sufficient for evaluating soil and rock conditions including, but not limited to, material classification, stratigraphy, groundwater, slope stability, soil and rock strength, adequacy of load-bearing soils and rock, the effect of moisture variation on soil-bearing capacity, compressibility, liquefaction and expansiveness. The investigation shall comply with Sections ~~[1802.4.4]~~ 1803.4.1 through ~~[1802.4.4]~~ 1803.4.4.

[1802.4.1] 1803.4.1 Scope of investigation. The scope of the geotechnical investigation, including the number, types and depths of borings, the number of test pits or the number of alternative test methods; the equipment used to drill and sample; the in-situ testing; and the laboratory testing program shall be determined by the engineer responsible for the investigation, subject to the requirements of this chapter.

1. Borings shall be uniformly distributed under the structure or distributed in accordance with load patterns imposed by the structure.
2. ~~[As]~~ At a minimum, investigations for structures shall include:
 - 2.1. One exploratory boring for built-over areas up to and including 750 square feet (69.7 m²).
 - 2.2. Two exploratory borings for built-over areas greater than 750 square feet (69.7 m²) but less than 5,000 square feet (~~[465]~~ 464.5 m²), and at least one additional boring for each additional 2,500 square feet (~~[233]~~ 232.3 m²), or part thereof, of built-over areas up to 20,000 square feet (~~[(1860 m²)]~~) (1858.1 m²).
 - 2.3. At least one boring for each additional 5,000 square feet (~~[465]~~ 464.5 m²), or part thereof, of built-over areas in excess of 20,000 square feet (~~[(1860 m²)]~~) (1858.1 m²).
3. At a minimum, investigations for retaining walls greater than 10 feet (~~[(3.05 m)]~~) (3048 mm) in height shall include one exploratory boring for every 50 linear feet (~~[(15.24 m)]~~) (15 240 mm) of wall.
4. Borings shall be taken into bedrock, or to an adequate depth below the top of the load-bearing strata to demonstrate that the foundation loads have been sufficiently dissipated and to evaluate global stability of retaining walls.
5. For structures having an average area load (dead plus live) of 1,000 pounds per square foot (47.9 kN/m²) or more, at least one boring for every 10,000 square feet (~~[930]~~ 929 m²) of footprint area shall penetrate at least 100 feet (30 480 mm) below the curb grade or 5 feet (1524 mm) into bedrock of Class 1c or better, whichever is less.
6. At least one-half of the borings satisfying this requirement shall be located within the limits of the built-up area and the remainder shall be within 25 feet (7620 mm) of the built-up area limits.
7. For structures to be supported on deep foundations, the required number of borings shall be not less than two borings, and based on a minimum of one boring per 2,000 square feet

~~[(609.6 m²)] (184.8 m²)~~ for the first 20,000 square feet ~~[(1860 m²)] (1858.1 m²)~~ and one boring per every additional 4,000 square feet ~~[(609.6 m²)] (371.6 m²)~~ thereafter.

8. All boring, sampling, and in-situ testing operations shall be subject to special inspection in accordance with ~~[Section 1704.7.4]~~ Table 1705.6.

Exception: Test pits may be substituted for borings for one and two-story structures~~[-and may be used only to establish the top of rock, where practical, for taller structures. For taller structures, the engineer shall submit a test pit observation report to the commissioner; for one and two-story structures, the].~~ The registered design professional shall ~~[may]~~ submit a test pit observation report to the commissioner.

~~[1802.4.2]~~ **1803.4.2 Existing data.** ~~[At the request of the engineer responsible for the geotechnical investigation, the suitable]~~ Suitable borings, test pits, probings, and the logs and records that were obtained as part of earlier exploration programs by an engineer other than the engineer performing the geotechnical investigation and that meet the requirements of this section may only be used as partial fulfillment of the requirements of ~~[this section, subject to the approval of the commissioner]~~ Section 1803.4.1. ~~[Additional borings shall be made at the direction of the engineer responsible for the geotechnical investigation when uncertainty exists as to the accuracy of the available information or specific new project or loading conditions indicate the need for additional information.]~~ Additional boring(s) shall be made to fulfill the requirements of Section 1803.4.1, with a minimum of one additional boring required.

~~[1802.4.3]~~ **1803.4.3 Groundwater table.** The geotechnical investigation shall determine the existing groundwater table.

~~[1802.4.4]~~ **1803.4.4 Compressible soils.** In areas containing compressible soils, the geotechnical investigation shall determine the extent of these soils in the plan area of the structure and shall be subject to the requirements of Section ~~[1802.3]~~ 1803.3.

~~[1802.5]~~ **1803.5 Soil and rock sampling.** The soil boring and sampling procedures and apparatus shall be in accordance with ASTM D1586 and ASTM D1587 and generally accepted engineering practice. The rock coring, sampling procedure and apparatus shall be in accordance with ASTM D2113 and generally accepted engineering practice. Rock cores shall be obtained with a double-tube core barrel with a minimum outside diameter of 2⁷/₈ inches (73 mm). With the approval of the engineer responsible for the geotechnical investigation, smaller-diameter double-tube core barrels may be used under special circumstances such as telescoping casing to penetrate boulders, or space limitations requiring the use of drill rigs incapable of obtaining large-diameter cores.

~~[1802.5.1]~~ **1803.5.1 Bedrock support.** Where the foundation design relies on rock to support footings, ~~[piles]~~ deep foundations or caisson sockets, or permanent prestressed rock anchors, a sufficient number of rock corings shall ~~[extend at least 10 feet (3048 mm) below the lowest level of bearing to provide assurance of the rock soundness]~~ be drilled to sufficient depths to assess the competency of the rock and its load-bearing capacity, but no less than 10 feet (3048 mm) below the lowest level of bearing. ~~[Where foundations are to rest on bedrock and such rock is exposed over a part or all of the area of the building, borings are not required in those areas where rock is exposed, provided the following requirements are met:]~~

~~[1. The presence of defects or the inclination of bedding planes in the rock are of such size and location so as not to affect stability of the foundation.]~~

~~[2. The foundation is not designed for bearing pressures exceeding those permitted in Table 1802.3.]~~

~~[1802.5.2]~~ **1803.5.2 Alternative investigative methods.** The engineer responsible for the geotechnical investigation may engage specialized technicians to conduct alternative investigative methods such as cone penetrometer testing (CPT) performed in accordance with ASTM D3441 or ASTM D5778. Data from these investigations may be used to ~~[(+)]~~ (i) supplement soil boring and rock coring information, provided there is a demonstrated correlation between the findings, and ~~[(2)]~~ (ii) determine material properties for static and seismic or liquefaction analyses. ~~[Subject to the approval of the commissioner, alternate exploration methods]~~ CPTs may replace borings on a one ~~[and one half for]~~ to one basis, but in no case shall there be fewer than half the required standard borings as per Section ~~[1802.4.1]~~ 1803.4.1, and no less than two standard borings. The boring depth requirements of Section ~~[1802.4.1]~~ 1803.4.1 shall be accomplished with borings. The alternative investigative methods must be capable of extending to the depths of the required borings. Other in-situ testing methods, such as geophysical, vane shear, and ~~[pressure meter]~~ pressuremeter, may be used to determine engineering design parameters, but may not be used as a substitute for the required number of borings.

~~[1802.5.3]~~ **1803.5.3 Material disposition.** Soil and rock samples shall be maintained in an accessible location by the permit holder or owner and made available to the engineer responsible for the geotechnical investigation and to the department, until the foundation work has been completed and accepted, or until 1 year after the investigation is complete, whichever is longer.

[1802.6 Reports.]

~~[1802.6.1 Conditions requiring geotechnical reports.~~ The owner or applicant of record shall submit a written report to the commissioner for any of the following conditions:]

~~[1. Any load-bearing value greater than those in Section 1804 is claimed.]~~

~~[2. The structure is determined to be in Seismic Design Category C or D in accordance with Section 1613.]~~

~~[3. Test pits are implemented in lieu of borings as per Section 1802.4.1.]~~

~~[4. The structure will bear on or above compressible soils (see Section 1804.2.2), uncontrolled fill (see Section 1804.2.3), or artificially treated soils (see Section 1804.2.4).]~~

~~[5. As required by the commissioner.]~~

1803.6 Geotechnical reports. A geotechnical engineering report shall be prepared for all sites and submitted to the commissioner.

Exception: One- and two-family dwellings no more than three stories in height shall not require a geotechnical report except where any of the following exist:

1. Shallow foundations are used that bear on or above compressible soils (see Section 1803.4.4), uncontrolled fill (see Section 1806.2.3), or artificially treated soils (see Section 1806.2.4);
2. Underpinning is required;
3. The structure is within the special flood hazard area;
4. Dewatering is required;
5. Test pits are implemented in lieu of borings as per Section 1803.4.1; or
6. As required by the commissioner.

[1802.6.2] 1803.6.1 Information required in geotechnical reports. The geotechnical report shall be prepared by the engineer responsible for the geotechnical investigation and shall be signed and sealed. The geotechnical report submitted to the commissioner shall include the foundation system shown on the drawings submitted to the department. The report shall include, but need not be limited to, the following information:

1. A description of the planned structure.
2. A plot showing the location of test borings, excavations, probes, and/or other exploration techniques.
3. A complete record of the soil and/or rock sample descriptions.
4. A record of the soil and/or rock profile.
5. Elevation of the groundwater table[?] (if encountered), base flood elevation (if applicable), and design flood elevation.
6. Results of in-situ or geophysical testing.
7. Results of laboratory testing.
8. Recommendations for foundation type and design criteria, including but not limited to allowable bearing capacity of natural or compacted soil and/or rock; soil stiffness parameters required for design of the foundations; mitigation of the effects of liquefaction (if applicable); site class; Mapped MCE_R spectral acceleration parameters (SS and S1); design spectral response acceleration parameters (SDS and SD1); site adjusted peak ground acceleration (PGAM); differential settlement and varying soil and/or rock strength; and the effects of adjacent loads.
9. Design lateral earth pressures on foundation walls and other retaining walls.
10. Recommendations for the evaluation of adjacent properties potentially impacted by the proposed construction.

11. Where dewatering is required, recommendations for the maximum permissible drawdown outside the site.

[9.] 12. Expected total and differential settlement.

[10.] 13. Special design and construction provisions for footings or foundations founded on expansive soils, as necessary.

[11.] 14. Compacted fill material properties and testing in accordance with Section [1803.5] 1804.6.

[12.] 15. Controlled low-strength material properties and testing in accordance with Section [1803.6] 1804.7.

[13.] 16. A list of anticipated special inspections required for construction of earthwork and foundations.

[14.] 17. For deep foundations reports, the requirements outlined in Section [1808.2.2] 1810.2.2.

18. For permanent prestressed rock and soil anchor reports, the requirements outlined in Section 1815.2.

19. Soil and rock parameters to be used to determine the safe slope of temporary excavations pursuant to Section 3304.4.1.

[1802.7] **1803.7 Construction documents.** Construction documents shall be prepared in accordance with Section 106.7.1.

SECTION BC [1803] 1804 EXCAVATION, GRADING AND FILL

[1803.1] **1804.1 Excavations near foundations.** Excavations for any purpose shall not ~~remove~~ reduce vertical or lateral support ~~from~~ for any foundation without first evaluating if underpinning or protecting the foundation against ~~settlement or lateral translation~~ detrimental lateral or vertical movement, or both, is required. Where required, underpinning or shoring shall be provided in accordance with Section [1814] 1817.

[1803.2] **1804.2 Placement of backfill.** The excavation outside the foundation shall be backfilled with soil that is free of organic material, construction debris, or boulders. A controlled low-strength material (CLSM) can be used as backfill in lieu of soil. Soil backfill shall be placed in lifts and compacted in a manner that does not damage the foundation or the waterproofing or dampproofing material.

Exception: Controlled low-strength material need not be compacted.

1804.3 Surcharge. No fill or other surcharge loads shall be placed adjacent to any building or structure unless such building or structure is capable of withstanding the additional loads caused by the fill or the surcharge.

Exception: Grading for landscaping purposes shall be permitted where done with walk-behind equipment where the grade is not increased more than one foot (304.8 mm) from original design grade, or where approved by the commissioner.

[1803.3] 1804.4 Site grading. The ground immediately adjacent to the foundation shall be sloped away from the structure as needed, or an approved alternate method of diverting water away from the foundation shall be used, where surface water would detrimentally affect the foundation material (soil and/or rock). Grading shall not be detrimental to the bearing material of adjacent structures. Site grading shall also comply with Section 1101.11 of the *New York City Plumbing Code*.

[1803.3.1] 1804.4.1 Seepage. In an excavation where soil and groundwater conditions are such that an inward or upward seepage might be produced in materials intended to provide vertical or lateral support for foundation elements or for adjacent foundations, excavating methods shall control or prevent the inflow of ground water to prevent disturbance of the soil material in the excavation or beneath existing buildings. No foundation shall be placed on soil that has been disturbed by seepage unless remedial measures have been taken.

[1803.4] 1804.5 Grading and filling in flood hazard areas. Grading and/or filling in areas of special flood hazard shall not be permitted except as permitted in Appendix G.

[1803.5] 1804.6 Compacted fill material. Where foundations will bear on compacted fill material, the compacted fill shall comply with the provisions of a geotechnical report prepared, signed and sealed by the engineer, which shall contain the following:

1. Specifications for the preparation of the site prior to placement of compacted fill material.
2. Specifications for material to be used as compacted fill.
3. Test method(s) to be used to determine the maximum dry density and optimum moisture content of the material to be used as compacted fill.
4. Maximum allowable thickness of each lift of compacted fill material.
5. Field test method(s) for determining the in-place dry density of the compacted fill.
6. Minimum acceptable in-place dry density expressed as a percentage of the maximum dry density determined in accordance with Item 3.
7. Number and frequency of field tests required to determine compliance with Item 6.
8. Acceptable types of compaction equipment for the specified fill materials.

[1803.6] 1804.7 Controlled low-strength material (CLSM). Where footings will bear on controlled low-strength material (CLSM), the CLSM shall comply with the provisions of a geotechnical report prepared, signed and sealed by the engineer, which shall contain the following:

1. Specifications for the preparation of the site prior to placement of the CLSM.
2. Specifications for the CLSM.

3. Laboratory or field test method(s) to be used to determine the compressive strength or bearing capacity of the CLSM.
4. Test methods for determining the acceptance of the CLSM in the field.
5. Number and frequency of field tests required to determine compliance with Item 4.

SECTION BC 1805 **DAMPPROOFING AND WATERPROOFING**

1805.1 Where required. Walls or portions thereof that retain soil or rock and enclose interior spaces and floors below grade shall be waterproofed or dampproofed in accordance with this section, with the exception of those spaces containing occupancy groups other than residential and institutional where such omission is not detrimental to the building or occupancy. Ventilation for crawl spaces shall comply with Section 1203.3.

1805.1.1 Flood hazard areas. Buildings and structures in areas of special flood hazard shall comply with Appendix G.

1805.2 Dampproofing required. Where hydrostatic pressure will not occur as determined by Section 1803, floors and walls for other than wood foundation systems shall be dampproofed in accordance with this section. Wood foundation systems shall be constructed in accordance with AWC TR7.

1805.2.1 Floors. Dampproofing materials for floors shall be installed between: (i) the floor and (ii) the base course required by Section 1805.4.1 or the sub-floor. Subgrade for the dampproofing material shall be prepared in accordance with manufacturer's recommendations. Dampproofing material shall be installed in accordance with manufacturer's recommendations and protected after placement. Any damaged areas and punctures must be repaired prior to placement of slab. All penetrations shall be sealed as per manufacturer's recommendations.

1805.2.2 Walls. Dampproofing materials for walls shall be installed on the exterior surface of the wall, and shall extend from the top of the footing to above ground level as determined by the registered design professional and shall be installed in accordance with manufacturer's recommendations. Dampproofing at walls shall overlap or extend past the slab dampproofing such that there are no gaps or breaches in the dampproofing system.

1805.3 Waterproofing required. Where the geotechnical investigation required by Section 1803 indicates that a hydrostatic pressure condition exists, walls and floors shall be waterproofed in accordance with this section.

1805.3.1 Floors. Floors required to be waterproofed shall be designed and constructed to withstand the hydrostatic pressures to which the floors will be subjected. Waterproofing shall be accomplished by creating a continuous water seal below the floor using appropriate waterproofing materials. Joints, penetrations and other interruptions shall be sealed in accordance with manufacturer's recommendations. Floor waterproofing must be transitioned to accomplish a complete tie-in with the foundation wall waterproofing.

1805.3.2 Walls. Walls required to be waterproofed shall be designed and constructed to withstand the hydrostatic pressures and other lateral loads to which the walls will be subjected. Waterproofing shall be applied from the bottom of the wall to not less than 12 inches (304.8 mm) above the maximum elevation of the groundwater table or as directed by the registered design professional. The remainder of the wall shall be dampproofed in accordance with Section 1805.2.2. Joints, penetrations and other interruptions shall be sealed in accordance with manufacturer's recommendations.

1805.3.3 Joints and penetrations. Joints in or between walls and floors, and penetrations of walls and floors shall be sealed utilizing methods and materials approved by the registered design professional. Joints, penetrations and other interruptions shall be sealed in accordance with the manufacturer's recommendations.

1805.4 Subsoil drainage system. Where it is determined that there is a potential for infiltration or seepage, a subsoil drainage system shall be permitted to be used to control this inflow, provided that:

1. The below ground space is waterproofed or dampproofed per Sections 1805.2 and 1805.3; and
2. The estimated discharge from the drainage system is less than or equal to the amount allowed by the agency having jurisdiction.

1805.4.1 Drainage course. A drainage course shall consist of washed gravel, crushed natural stone or other suitable drainage medium acceptable to the engineer. Recycled concrete aggregate is not acceptable for use in a drainage course where a subsoil drainage system is used.

1805.4.2 Foundation drain. A foundation drain shall be installed where required by the registered design professional. The foundation drain, including layout, materials, and cleanouts, shall be designed by the registered design professional.

1805.4.3 Drainage discharge. The drainage course and foundation drain shall discharge by gravity or mechanical means into an approved drainage system that complies with the *New York City Plumbing Code* and any other laws or requirements of agencies having jurisdiction.

1805.5 In situ walls. In situ walls (such as slurry walls, tangent pile walls, and secant pile walls) with joints sealed by grouting or other methods acceptable to the engineer shall not require waterproofing or dampproofing unless required by the engineer.

SECTION BC [1804] 1806
ALLOWABLE LOAD-BEARING VALUES OF SOILS AND ROCK

[1804.1] 1806.1 Design. The allowable bearing pressures provided in Table [1804.1] 1806.1 shall be used with the allowable stress design load combinations specified in Section 1605.3.

TABLE [1804.1] 1806.1
ALLOWABLE BEARING PRESSURES

CLASS OF MATERIALS (Notes 1 and 3)	MAXIMUM ALLOWABLE BEARING PRESSURE (TSF)	MAXIMUM ALLOWABLE BEARING PRESSURE (kPa)
1. Bedrock (Notes 2 and 7)		
1a Hard sound rock	60	5,746
1b Medium rock	40	3,830
1c Intermediate rock	20	1,915
1d Soft rock	8	766
2. Sandy gravel and gravel (GW, GP) (Notes [3-] 4, 8, and 9)		
2a Dense	10	958
2b Medium	6	575
3. Granular soils (GC, GM, SW, SP, SM, and SC) (Notes 4, 5, 8, and 9)		
3a Dense	6	575
3b Medium	3	287
4. Clays (SC, CL, and CH) (Notes 4, 6, 8, and 9)		
4a Hard	5	479
4b Stiff	3	287
4c Medium	2	192
5. Silts and silty soils (ML and MH) (Notes 4, 8, and 9)		
5a Dense	3	287
5b Medium	1.5	144
6.[?] Nominally Unsatisfactory Bearing Materials: Loose granular soils Soft clay soils Loose silt [•] All organic silts, organic clay, peats, soft clays, granular soils and varved silts	See [1804.2.1 1806.2.1	See [1804.2.1 1806.2.1
7. Controlled and uncontrolled fills	See [1804.2.2 or 1804.2.3] 1806.2.2 or 1806.2.3	See [1804.2.2 or 1804.2.3] 1806.2.2 or 1806.2.3

Notes:

1. Where there is doubt as to the applicable classification of a soil or rock stratum, the allowable bearing pressure applicable to the lower class of material to which the given stratum might conform shall apply.
2. The tabulated values of allowable bearing pressures apply only for massive rocks, or for sedimentary or foliated rocks where the strata are level or nearly so, and then only if the area has ample lateral support. The allowable bearing pressure for tilted strata and their relation to nearby slopes or excavations shall be evaluated by the engineer responsible for the geotechnical investigation. The tabulated values for Class 1a materials (hard sound rock) may be increased by 25 percent provided the engineer performs additional tests and/or analyses substantiating the increase.
3. For intermediate conditions, values of allowable bearing pressure shall be estimated by interpolation between indicated extremes.
4. Footing embedment in soils shall be in accordance with Section [1805.3] 1809.3 and the width of the loaded area shall not be less than 18 inches ([457] 457.2 mm), unless analysis demonstrates that the proposed construction will have a minimum factor of safety of 2.0 against shear failure of the soil.
5. Estimates of settlements shall govern the allowable bearing pressure, subject to the maximums given in this table, and as provided in Section [1804.2] 1806.2.
6. Allowable bearing pressure of clay soils shall be established on the basis of the strength of such soils as determined by field or laboratory tests and shall provide a factor of safety against failure of the soil of not less than 2.0 computed on the basis of a recognized procedure of soils analysis, shall account for probable settlements of the building and shall not exceed the tabulated maximum values.
7. Allowable bearing pressure may be increased due to embedment of the foundation. The allowable bearing pressure for intermediate rock (1c), medium hard rock (1b), and hard sound rock (1a) shall apply where the loaded area is on the rock surface. Where the loaded area is below the rock surface and is fully confined by the adjacent rock mass and provided that the adjacent rock mass above the bearing surface is of [the same] rock class 1c or better, and the rock mass has not been shattered by blasting or otherwise is or has been rendered unsound, the allowable bearing pressure may be increased 10 percent of the base value for each 1 foot (0.3 meters) of embedment below the surface of the adjacent rock surface in excess of 1 foot (0.3 meters), but shall not exceed 200 percent of the values.

8. The allowable bearing pressure for soils of Classes 2, 3, 4, and 5 determined in accordance with Notes 3, 4, and 5 above, shall apply where the loaded area is embedded 4 feet (~~1219~~ 1220 mm) or less in the bearing stratum. Where the loaded area is embedded more than 4 feet (~~1219~~ 1220 mm) below the adjacent surface of the bearing stratum, and is fully confined by the weight of the adjacent soil, the allowable bearing pressure may be increased 5 percent of the base value for each 1-foot (~~305~~ 304.8 mm) additional embedment, but shall not exceed twice the values. Increases in allowable bearing pressure due to embedment shall not apply to soft rock, clays, silts and soils of Classes 6 and 7.
9. The allowable bearing pressure for soils of Classes 2, 3, 4, and 5 determined in accordance with this table and the notes thereto, may be increased up to ½ where the density of the bearing stratum below the bottom of the footings increases with depth and is not underlain by materials of a lower allowable bearing pressure. Such allowable bearing pressure shall be demonstrated by a recognized means of analysis that the probable settlement of the foundation due to compression, and/or consolidation does not exceed acceptable limits for the proposed building.
10. The maximum toe pressure for eccentrically loaded footings may exceed the allowable bearing pressure by up to 25 percent if it is demonstrated that the heel of the footing is not subjected to tension.

[1804.2] 1806.2 Allowable bearing pressure. The allowable bearing pressure for supporting soil and rock [~~at or near the surface~~] shall not exceed the values specified in Table [~~1804.1~~] 1806.1, unless data to substantiate the use of a higher value are developed and contained in the engineer's geotechnical report, and the commissioner approves such value. Allowable bearing pressure shall be considered to be the pressure at the base of a foundation in excess of the [~~stabilized overburden pressure~~] effective stress existing at the same level prior to construction operations.

[1804.2.1] 1806.2.1 Nominally unsatisfactory bearing material. Organic silts, organic clays, peats, soft clays, loose granular soils, loose silts, and varved silts shall be considered nominally unsatisfactory bearing material. The allowable bearing pressure shall be determined independently of Table [~~1804.1~~] 1806.1 subject to the following:

1. For varved silts, the soil bearing pressure produced by the proposed building shall not exceed 2 tons per square foot (~~192~~ 191.5 kPa), except that for desiccated or over consolidated soils, higher bearing pressures are allowed subject to approval by the commissioner.
2. For organic silts or clays, peats, soft clays, loose granular soils, or loose silts, the engineer responsible for the geotechnical investigation shall establish the allowable soil bearing pressure based upon the soil's specific engineering properties. This may require that the soils be preconsolidated, artificially treated or compacted.
3. A report prepared, signed and sealed by the engineer is required to be filed with the department to substantiate the design soil pressures to be used on soil materials and shall contain, at a minimum:
 - 3.1. Sufficient laboratory test data on the compressible material to indicate the soil strength and the preconsolidation pressure, coefficient of consolidation, coefficient of compressibility, permeability, secondary compression characteristics, and Atterberg limits.
 - 3.2. Where the design contemplates improvement of the natural bearing capacity and/or reduction in settlements by virtue of preloading, cross sections showing the amount of fill and surcharge to be placed, design details showing the required time for surcharging, and computations showing the amount of settlement to be expected during surcharging and the estimated amount and rate of settlement expected to occur after the structure has been completed, including the influence of dead and live loads of the structure.

- 3.3. A detailed analysis showing that the anticipated future settlement will not adversely affect the performance of the structure.
- 3.4. Where strip drains, sand drains, or stone columns are to be used, computations showing the diameter, spacing, and anticipated method of installation of such drains.
- 3.5. Records of settlement plate elevations and pore pressure readings, before, during, and after surcharging.

[1804.2.2] 1806.2.2 Controlled fills. Fills shall be considered as satisfactory bearing material of the applicable class when placed in accordance with the following procedures and subject to the special inspection provisions of Chapter 17:

1. Area to be filled shall be stripped of all organic materials, rubbish and debris.
2. Fill shall not be placed when frozen or on frozen or saturated subgrade.
3. The special inspection agency shall approve the subgrade prior to fill placement.
4. Fill material shall consist of gravel, crushed rock, recycled concrete aggregate, well-graded sand or a mixture of these, or equivalent materials with a maximum particle size of 3 inches (76.2 mm) and a maximum of 10 percent passing the #200 sieve.
5. Fill shall be placed and compacted in lifts, not exceeding 12 inches (~~[305]~~ 304.8 mm), at its optimum moisture content, plus or minus 2 percent, and to not less than a density of 95 percent of the optimum density as determined by ASTM D1557.
6. Fill density shall be verified by in-place tests made on each lift.

[1804.2.2.1] 1806.2.2.1 Allowable bearing pressure of controlled fills. Provided the capacity of the underlying soil is not exceeded, the allowable bearing pressure of controlled fill shall be limited to:

1. 6 tons per square foot [~~(766 kPa)~~] (574.6 kPa) for gravel and crushed rock.
2. 3 tons per square foot [~~(383 kPa)~~] (287.3 kPa) for recycled concrete aggregate and well-graded sand.

[1804.2.3] 1806.2.3 Uncontrolled fills. Fills other than controlled fill may be considered as satisfactory bearing material of applicable class, subject to the following:

1. Where spread footings will be used, the soil within the built-up area shall be explored using test pits at every column. All test pits shall extend to depths equal to the smaller width of the footing and at least one test pit shall penetrate at least 8 feet (~~[2438]~~ 2438.4 mm) below the level of the bottom of the proposed footings. All test pits shall be backfilled with properly compacted fill. Borings may be used in lieu of test pits, provided that continuous samples of at least 3 inches (~~[76]~~ 76.2 mm) in diameter are recovered. Where mat foundations will be used, one test pit or minimum 3 inch (~~[76]~~ 76.2 mm) diameter sampler boring shall be provided for every 1,000 square feet [~~(232.3 m²)~~] (92.9 m²) of

building footprint area. For continuous concrete footings, one test pit or minimum 3 inch (~~[76]~~ 76.2 mm) diameter sampler boring shall be provided for every 25 linear feet (~~[7.62~~ m)] (7620 mm).

2. The building area shall be additionally explored using one standard boring for every 2,500 square foot (232.3 m²) of building footprint area. These borings shall be carried to a depth sufficient to penetrate into natural ground, but not less than 20 feet (6096 mm) below grade.
3. The fill shall be composed of material that is free of voids and free of extensive inclusions of mud and organic materials such as paper, wood, garbage, cans, or metallic objects and debris.
4. The allowable soil bearing pressure on satisfactory uncontrolled fill material shall not exceed 2 tons per square foot (~~[192]~~ 191.5 kPa). One and two-family dwellings may be founded on satisfactory uncontrolled fill provided the dwelling site has been explored using at least one test pit, penetrating at least 8 feet (~~[2438]~~ 2438.4 mm) below the level of the bottom of the proposed footings, and the fill has been found to be composed of material that is free of voids and generally free of mud and organic materials, such as paper, garbage, cans, or metallic objects, and debris. Test pits shall be backfilled with properly compacted fill.

~~[1804.2.4]~~ **1806.2.4 Artificially treated soils.** Nominally unsatisfactory soil materials that are artificially compacted, cemented, or preconsolidated may be used for the support of buildings, and nominally satisfactory soil materials that are similarly treated may be used to resist soil bearing pressures in excess of those indicated in Table ~~[1804.1]~~ 1806.1. The engineer shall develop treatment plans and procedures and post-treatment performance and testing requirements, and submit such plans, procedures, and requirements to the commissioner for approval. After treatment, a sufficient amount of sampling and/or in-situ tests shall be performed in the treated soil to demonstrate the efficacy of the treatment for the increased bearing pressure.

~~[1804.3 Reserved.]~~

SECTION BC 1807 **RETAINING WALLS AND OTHER RETAINING STRUCTURES**

1807.1 General. Retaining walls shall be designed in accordance with Section 1807.2.

1807.2 Design. Retaining walls shall be designed to ensure stability against overturning, sliding, excessive foundation pressure and the effects of water pressure, including uplift. Where a keyway is extended below the wall base with the intent to engage passive pressure and enhance sliding stability, lateral soil pressures on both sides of the keyway shall be considered in the sliding analysis.

1807.2.1 Design lateral soil loads. Retaining walls shall be designed for the lateral soil loads set forth in Section 1605.

Exception: Where the structural design of a retaining wall is based on load factor design, the load factors in Section 1605.2 may be modified as follows: where water can freely flow over

the top of the wall, the wall may be designed for a water pressure equal to that caused by a groundwater table elevation at the top of the wall. For this condition, the load factor for the groundwater pressure may be reduced to 1.2. The load factor for the lateral earth pressure shall remain at 1.6.

1807.2.2 Safety factor. Retaining walls shall be designed to resist the lateral action of soil to produce sliding and overturning with a minimum safety factor of 1.5 in each case. The load combinations of Section 1605 shall not apply to this requirement. Instead, design shall be based on 0.7 times nominal earthquake loads, 1.0 times other nominal loads, and investigation with one or more of the variable loads set to zero. The safety factor against lateral sliding shall be taken as the available soil resistance at the base of the retaining wall foundation divided by the net lateral force applied to the retaining wall.

Exception: Where earthquake loads are included, the minimum safety factor for retaining wall sliding and overturning shall be 1.1.

1807.3 Temporary retaining structures. Structural members for temporary retaining structures may be designed with a 20 percent increase in the allowable bending stress only.

SECTION BC 1808
RESERVED

SECTION BC [1805] 1809
SHALLOW FOUNDATIONS

[1805.1] 1809.1 General. Shallow foundations shall be designed and constructed in accordance with Sections [1805.1] 1809.1 through [1805.9] 1809.6. Shallow foundations shall be constructed on suitable bearing materials established in accordance with the requirements of Sections [1803] 1804 and [1804] 1806.

[1805.2] 1809.2 Stepped footings. The top surface of footings shall be level. The bottom surface of footings [is] shall be permitted to have a slope not exceeding one unit vertical in 10 units horizontal (10-percent slope). Footings shall be stepped where necessary to change the elevation of the top surface of the footing or where the surface of the ground slopes more than one unit vertical in 10 units horizontal (10-percent slope).

[1805.3] 1809.3 Depth of footings. The minimum depth of shallow foundations below the undisturbed ground surface shall be 12 inches ([305] 304.8 mm). Where applicable, the depth of shallow foundations shall also conform to Section [1805.3.1] 1809.3.1.

[1805.3.1] 1809.3.1 Frost protection. Except where otherwise protected from frost, shallow foundations, pile caps, and other permanent supports of buildings and structures shall be protected from frost by one or more of the following methods:

1. Extending a minimum of 4 feet ([1219] 1220 mm) below the lowest adjacent permanent exposed grade;

Exception: Grade beams shall be embedded a minimum of 18 inches (457.2 mm) below the lowest adjacent permanent exposed grade.

2. Constructing in accordance with [~~ASCE 32~~] ASCE 32; or
3. Erecting on solid rock.

Exception: Free-standing buildings meeting all of the following conditions [~~are not~~] shall not be required to be frost protected:

1. Classified in Structural Occupancy Category I (see Table 1604.5);
2. Area of 400 square feet (~~[37]~~ 37.1 m²) or less; and
3. Eave height of 10 feet (3048 mm) or less.

[1805.3.2] 1809.3.2 Foundations on frozen soil. Shallow foundations shall not bear on frozen soil.

Exception: Temporary structures may bear on frozen soil if the soil is maintained in a frozen condition throughout the service life of the temporary structures being supported. The method of maintaining the soil in a frozen condition shall be approved by the commissioner.

[1805.4] 1809.4 Shallow foundations at different levels. Where shallow foundations are supported at different levels, or are at different levels from the shallow foundations of adjacent structures, the influence of the pressures under the higher foundation on the stability of the lower foundations shall be considered in the design. The design shall consider the requirements for lateral support of the material supporting the higher foundation, the additional load imposed on the lower foundations, and assessment of the effects of dragdown on [~~piles~~] deep foundations supporting adjacent buildings or compression of soils supporting adjacent buildings.

[1805.5] 1809.5 Shallow foundations. Shallow foundations shall be designed and constructed in accordance with Sections [~~1805.5.1~~] 1809.5.1 through [~~1805.5.6~~] 1809.5.8.

[1805.5.1] 1809.5.1 Design. Shallow foundations shall be designed so that the allowable bearing capacity of the soil is not exceeded, and that differential settlements are within the allowable limits for the structure. The minimum width of shallow foundations shall be 18 inches (~~[457]~~ 457.2 mm).

[1805.5.1.1] 1809.5.1.1 Design loads. Shallow foundations shall be designed for the most unfavorable effects due to the combinations of loads specified in Section 1605.3. The dead load shall include the weight of shallow foundations and overlying fill. Reduced live loads, as specified in Section [~~1607.9~~] 1607.11, are permitted to be used in the design of shallow foundations.

[1805.5.1.2] 1809.5.1.2 Vibratory loads. Where machinery operations or other vibrations are transmitted through the shallow foundations, consideration shall be given in the shallow foundation design to prevent detrimental disturbances of the soil.

[1805.5.1.3] 1809.5.1.3 Shifting or moving soils. When the possibility of shifting or moving soil exists, the short and long term impact of such soils shall be considered in the design of shallow foundations.

[1805.5.2] 1809.5.2 Concrete shallow foundations. The design, materials and construction of concrete shallow foundations shall comply with Sections ~~[1805.5.2.1]~~ 1809.5.2.1 through ~~[1805.5.2.5]~~ 1809.5.2.5 and the provisions of Chapter 19.

[1805.5.2.1] 1809.5.2.1 Concrete strength. Concrete in shallow foundations shall have a specified compressive strength (f'_c) of not less than 2,500 pounds per square inch (psi) [~~17~~ 237 kPa] (17.24 MPa) at 28 days.

[1805.5.2.2] 1809.5.2.2 Footing seismic ties. Where a structure is assigned to Seismic Design Category D in accordance with Section 1613, individual spread footings founded on soil defined in Section ~~[1613.5.2]~~ 1613.3.2 as Site Class E or F shall be interconnected by ties. Ties shall be capable of carrying, in tension or compression, a force equal to the product of the larger footing load times the seismic coefficient SDS divided by 10 unless it is demonstrated that equivalent restraint is provided by reinforced concrete beams within slabs on grade or reinforced concrete slabs on grade.

[1805.5.2.3] 1809.5.2.3 Plain concrete footings. The thickness of plain concrete footings supporting walls of other than light-frame construction shall not be less than 8 inches (~~[203]~~ 203.2 mm) where placed on soil.

Exception: For plain concrete footings supporting Group R-3 occupancies, the thickness is permitted to be 6 inches (~~[152]~~ 152.4 mm), provided that the footing does not extend beyond a distance greater than the thickness of the footing on either side of the supported wall.

[1805.5.2.4] 1809.5.2.4 Placement of concrete. Concrete shallow foundations shall not be placed through water unless a tremie or other method approved by the commissioner is used. Where placed under or in the presence of water, the concrete shall be deposited by approved means to ensure minimum segregation of the mix and negligible turbulence of the water.

[1805.5.2.5] 1809.5.2.5 Protection of concrete. No shallow foundation shall be placed on frozen soils unless the soils are maintained in frozen condition throughout the service life of the structure being supported. No foundation shall be placed in freezing weather unless provision is made to maintain the underlying soil free of frost. Concrete shallow foundations shall be protected from freezing during depositing and for a period of not less than five days thereafter. Water shall not be allowed to flow through the deposited concrete.

[1805.5.3] 1809.5.3 Masonry-unit footings. The design, materials and construction of masonry-unit footings shall comply with the provisions of Chapter 21.

[1805.5.4] 1809.5.4 Steel grillage footings. Grillage footings of structural steel [~~shapes~~] elements shall be separated with approved steel spacers and be entirely encased in concrete with at least 6 inches (~~[152]~~ 152.4 mm) on the bottom and at least 4 inches (~~[102]~~ 101.6 mm) at all other points. The spaces between the [~~shapes~~] elements shall be completely filled with concrete or cement grout.

[1805.5.5] 1809.5.5 Timber footings. Refer to Chapter 23.

[1805.5.6] 1809.5.6 Wood foundations. Refer to Chapter 23.

[1805.5.7] 1809.5.7 Pier foundations. The design, materials, and construction of pier foundations shall conform to the requirements of Sections ~~[1805.5.2]~~ 1809.5.2, ~~[1805.5.3]~~ 1809.5.3, and ~~[1805.5.7.1]~~ 1809.5.7.1 through ~~[1805.5.7.6]~~ 1809.5.7.6.

Exception: Piers shall be load tested as a deep foundation in accordance with the applicable portions of Section ~~[1808]~~ 1810 when the bearing stratum is not physically available for inspection during construction as required by Chapter 17.

[1805.5.7.1] 1809.5.7.1 Dimensions and height. The minimum horizontal dimension of piers shall be 2 feet (~~[640]~~ 609.6 mm), and the height shall not exceed 12 times the least horizontal dimension.

[1805.5.7.2] 1809.5.7.2 Concrete design. Where adequate lateral support is furnished by the surrounding materials defined in Section ~~[1808.7]~~ 1810.7 of this code, piers may be constructed of plain or reinforced concrete and the requirements of ACI 318 shall apply.

Exception: Where adequate lateral support is not provided, and the ratio of unsupported height to least horizontal dimension does not exceed three, piers of plain concrete shall be designed and constructed as pedestals in accordance with ACI 318. Where the unsupported height to least horizontal dimension exceeds three, piers shall be constructed of reinforced concrete, and shall conform to the requirements for columns in ACI 318.

[1805.5.7.3] 1809.5.7.3 Reinforcement placement. Reinforcement shall be tied and placed as a unit in the pier prior to placement of concrete.

Exception: Steel dowels embedded 5 feet (1524 mm) or less in the pier may be placed individually. Reinforcement is permitted to be wet set and the concrete cover that is otherwise required to measure a minimum of 2½ inches (~~[64]~~ 63.5 mm) may be reduced to 2 inches (~~[54]~~ 50.8 mm) for Groups R-3 and U occupancies not exceeding two stories of light-frame construction, provided the construction method is approved by the commissioner.

[1805.5.7.4] 1809.5.7.4 Concrete placement. Concrete shall be placed in such a manner as to ensure the exclusion of any foreign matter and to fill the full lateral dimensions of each pier. Concrete shall not be placed through water except where a tremie or other approved method is used. When depositing concrete from the top of the pier, the concrete shall not be chuted directly into the pier but shall be poured in a rapid and continuous operation through a funnel hopper centered at the top of the pier.

~~[1805.5.7.5]~~ **1809.5.7.5 Steel shell.** Where concrete piers are entirely encased within a circular steel shell, and the area of the shell steel is considered reinforcing steel, the steel shall be protected under the conditions specified in Section ~~[1808.2.12]~~ 1810.2.12. Horizontal joints in the shell shall be spliced to comply with Section ~~[1808.2.11]~~ 1810.2.11.

~~[1805.5.7.6]~~ **1809.5.7.6 Dewatering.** Where piers are carried to depths below the groundwater level, the piers shall be constructed by a method that will provide accurate preparation and inspection of the subgrade in dry conditions.

~~[1805.5.8]~~ **1809.5.8 Foundation walls.** Concrete and masonry foundation walls shall be designed in accordance with Chapter 19 or 21, respectively.

~~[1805.5.8.1]~~ **1809.5.8.1 Foundation wall thickness.** The minimum thickness of concrete and masonry foundation walls shall comply with Section ~~[1805.5.8.1.1]~~ 1809.5.8.1.1.

~~[1805.5.8.1.1]~~ **1809.5.8.1.1 Thickness based on walls supported.** The thickness of foundation walls shall not be less than the thickness of the wall supported, except that foundation walls of at least 8 inch (~~[203]~~ 203.2 mm) nominal width are permitted to support brick-veneered frame walls and 10 inch wide (254 mm) cavity walls.

~~[1805.5.8.2]~~ **1809.5.8.2 Foundation wall drainage.** Foundation walls shall be designed to support the weight of the full hydrostatic pressure of undrained backfill unless a drainage system is installed in accordance with Sections ~~[1807.4.2]~~ 1805.4.2 and ~~[1807.4.3]~~ 1805.4.3.

~~[1805.5.8.3 Reserved.]~~

~~[1805.6 Reserved.]~~

~~[1805.7 Reserved.]~~

~~[1805.8 Reserved.]~~

~~[1805.9]~~ **1809.6 Seismic requirements.** For structures assigned to Seismic Design Category C or D, provisions of ACI 318 ~~[Section 21.12]~~ 18.13, as modified by Section ~~[1805]~~ 1908 of this code, shall apply when not in conflict with the provisions of Section ~~[1805]~~ 1809 of this code. Concrete shall have a specified compressive strength of not less than 3,000 psi (20.68 MPa) at 28 days.

Exceptions:

1. Group R or U occupancies of light-framed construction and two stories or fewer in height are permitted to use concrete with a specified compressive strength of not less than 2,500 psi (17.2 MPa) at 28 days.
2. One and two-family dwellings not more than three stories in height are not required to comply with the provisions of ACI 318, ~~[Sections 21.10.1 through 21.10.3]~~ Section 18.11, as modified by Section 1908 of this code.

[SECTION BC 1806]

[RETAINING WALLS AND OTHER RETAINING STRUCTURES]

~~[1806.1 General. Retaining walls shall be designed in accordance with Sections 1806.2.]~~

~~[1806.2 Design. Retaining walls shall be designed to ensure stability against overturning, sliding, excessive foundation pressure and water uplift. Where a keyway is extended below the wall base with the intent to engage passive pressure and enhance sliding stability, lateral soil pressures on both sides of the keyway shall be considered in the sliding analysis.]~~

~~[1806.2.1 Design lateral soil loads. Retaining walls shall be designed for the lateral soil loads set forth in Section 1605.]~~

~~[Exception: Where the structural design of a retaining wall is based on load factor design, the load factors in Section 1605.2 may be modified as follows: where water can freely flow over the top of the wall, the wall may be designed for a water pressure equal to that caused by a groundwater table elevation at the top of the wall. For this condition, the load factor for the groundwater pressure may be reduced to 1.2. The load factor for the lateral earth pressure shall remain at 1.6.]~~

~~[1806.2.2 Safety factor. Retaining walls shall be designed to resist the lateral action of soil to produce sliding and overturning with a minimum safety factor of 1.5 in each case. The load combinations of Section 1605 shall not apply to this requirement. Instead, design shall be based on 0.7 times nominal earthquake loads, 1.0 times other nominal loads, and investigation with one or more of the variable loads set to zero. The safety factor against lateral sliding shall be taken as the available soil resistance at the base of the retaining wall foundation divided by the net lateral force applied to the retaining wall.]~~

~~[Exception: Where earthquake loads are included, the minimum safety factor for retaining wall sliding and overturning shall be 1.1.]~~

~~[1806.3 Temporary retaining structures. Structural members for temporary retaining structures may be designed with a 20 percent decrease in the computed bending moment only.]~~

[SECTION BC 1807]

[DAMPPOOFING AND WATERPROOFING]

~~[1807.1 Where required. Walls or portions thereof that retain soil or rock and enclose interior spaces and floors below grade shall be waterproofed or dampproofed in accordance with this section, with the exception of those spaces containing occupancy groups other than residential and institutional where such omission is not detrimental to the building or occupancy. Ventilation for crawl spaces shall comply with Section 1203.3.]~~

~~[1807.1.1 Flood hazard areas. Buildings and structures in areas of special flood hazard shall comply with Appendix G.]~~

~~[1807.2 Dampproofing required. Where hydrostatic pressure will not occur as determined by Section 1802, floors and walls for other than wood foundation systems shall be dampproofed in accordance with this section. Wood foundation systems shall be constructed in accordance with AF&PA TR7.]~~

~~[1807.2.1 Floors. Dampproofing materials for floors shall be installed between: (i) the floor and (ii) the base course required by Section 1807.4.1 or the sub floor. Subgrade for the dampproofing material shall be prepared in accordance with manufacturer's recommendations. Dampproofing material shall be installed in accordance with manufacturer's recommendations, and protected after placement. Any damaged areas and punctures must be repaired prior to placement of slab. All penetrations shall be sealed as per manufacturer's recommendations.]~~

~~[1807.2.2 Walls. Dampproofing materials for walls shall be installed on the exterior surface of the wall, and shall extend from the top of the footing to above ground level as determined by the registered design professional and shall be installed in accordance with manufacturer's recommendations. Dampproofing at walls shall overlap or extend past the slab dampproofing such that there are no gaps or breaches in the dampproofing system.]~~

~~[1807.3 Waterproofing required. Where the geotechnical investigation required by Section 1802 indicates that a hydrostatic pressure condition exists, walls and floors shall be waterproofed in accordance with this section.]~~

~~[1807.3.1 Floors. Floors required to be waterproofed shall be designed and constructed to withstand the hydrostatic pressures to which the floors will be subjected. Waterproofing shall be accomplished by creating a continuous water seal below the floor using appropriate waterproofing materials. Joints, penetrations and other interruptions shall be sealed in accordance with manufacturer's recommendations. Floor waterproofing must be transitioned to accomplish a complete tie-in with the foundation wall waterproofing.]~~

~~[1807.3.2 Walls. Walls required to be waterproofed shall be designed and constructed to withstand the hydrostatic pressures and other lateral loads to which the walls will be subjected. Waterproofing shall be applied from the bottom of the wall to not less than 12 inches (305 mm) above the maximum elevation of the groundwater table or as directed by the registered design professional. The remainder of the wall shall be dampproofed in accordance with Section 1807.2.2. Joints, penetrations and other interruptions shall be sealed in accordance with manufacturer's recommendations.]~~

~~[1807.3.3 Joints and penetrations. Joints in or between walls and floors, and penetrations of walls and floors shall be sealed utilizing methods and materials approved by the registered design professional. Joints, penetrations and other interruptions shall be sealed in accordance with the manufacturer's recommendations.]~~

~~[1807.4 Subsoil drainage system. Where it is determined that there is a potential for infiltration or seepage, a subsoil drainage system shall be permitted to be used to control this inflow, provided that:]~~

- ~~[1. The below ground space is waterproofed or dampproofed per Sections 1807.2 and 1807.3; and]~~
- ~~[2. The estimated discharge from the drainage system is less than or equal to the amount allowed by the agency having jurisdiction.]~~

~~[1807.4.1 Drainage course. A drainage course shall consist of washed gravel, crushed natural stone or other suitable drainage medium acceptable to the engineer. Recycled Concrete Aggregate is not acceptable for use in a drainage course where a subsoil drainage system is used.]~~

~~[1807.4.2 Foundation drain. A foundation drain shall be installed where required by the registered design professional. The foundation drain, including layout, materials, and cleanouts, shall be designed by the registered design professional.]~~

~~[1807.4.3 Drainage discharge. The drainage course and foundation drain shall discharge by gravity or mechanical means into an approved drainage system that complies with the *New York City Plumbing Code* and any other laws or requirements of agencies having jurisdiction.]~~

~~[1807.5 In situ walls. In situ walls (such as slurry walls, tangent pile walls, and secant pile walls) with joints sealed by grouting or other methods acceptable to the engineer shall not require waterproofing or dampproofing unless required by the engineer.]~~

SECTION BC ~~[1808]~~ 1810 DEEP FOUNDATIONS

~~[1808.1] **1810.1 Scope.** Deep foundation elements, including but not limited to timber piles, precast concrete piles, structural steel piles, cast-in-place concrete piles, caisson piles, drilled displacement piles, composite piles, and helical piles, shall comply with Section ~~[1808. In addition,]~~ 1810; driven piles shall comply with Section ~~[1809]~~ 1811; cast-in-place concrete piles shall comply with Section ~~[1810]~~ 1812; composite piles shall comply with Section ~~[1811]~~ 1813; and helical piles shall comply with Section ~~[1812]~~ 1814.~~

~~[1808.2 Piles]~~ **1810.2 Deep foundations—general requirements.**

~~[1808.2.1] **1810.2.1 General.** [Piles] Deep foundations shall be designed and installed in accordance with the requirements of the geotechnical investigation and report required by Section ~~[1802]~~ 1803 and Sections ~~[1808]~~ 1810 through ~~[1812]~~ 1814.~~

~~[1808.2.2] **1810.2.2 Additional geotechnical investigation and report requirements.** Where [pile] deep foundations are used, the geotechnical investigation and report provisions of Section ~~[1802]~~ 1803 shall be expanded to include, but not be limited to, consideration of the following:~~

1. ~~[Suitable pile]~~ Recommended deep foundation types and [installed] their capacities.
2. Designation of bearing stratum or strata.
3. Suitable center-to-center spacing of deep foundation elements.
- ~~[3. Driving criteria.]~~
4. Reductions for group action, where necessary.
5. Load test requirements.
6. Durability of pile materials.

~~[4.]~~ 7. Installation procedures.

8. Protection of adjacent structures due to installation.

~~[5.]~~ 9. Field inspection and reporting procedures (to include procedures for verification of the installed bearing capacity where required).

~~[6. Pile load test requirements.]~~

~~[7. Durability of pile materials.]~~

~~[8. Designation of bearing stratum or strata.]~~

~~[9. Reductions for group action, where necessary.]~~

~~[1808.2.3]~~ **1810.2.3 Special inspection.** Special inspections for deep foundations shall be performed by an engineer in accordance with Sections ~~[1704.8]~~ 1705.7 and ~~[1704.9]~~ 1705.19.

~~[1808.2.4]~~ **1810.2.4 Pile caps.** Pile caps shall be of reinforced concrete, and shall include all elements to which ~~[piles]~~ deep foundations are connected, including grade beams and mats. The soil immediately below the pile cap shall not be considered as carrying any vertical load. The tops of ~~[piles]~~ deep foundations shall be embedded not fewer than 3 inches (~~[76]~~ 76.2 mm) into pile caps and the caps shall extend at least 4 inches (~~[102]~~ 101.6 mm) beyond the outermost edges of ~~[piles]~~ the deep foundation elements. The tops of ~~[piles]~~ deep foundations shall be cut back to sound material before capping. Pile caps shall be protected from the effects of frost in accordance with Section ~~[1805.3.1]~~ 1809.3.1.

~~[1808.2.5]~~ **1810.2.5 More than one [pile] type, [pile] capacity or method of [pile] installation for deep foundations.** In the conditions described below, the several parts of the building supported on the different ~~[pile]~~ types or different ~~[pile]~~ capacities~~[-]~~ of deep foundations shall be separated by suitable joints providing for differential movement, or analysis shall be prepared by the engineer, establishing to the satisfaction of the commissioner that the proposed construction is adequate and safe, and showing that the probable settlements and differential settlements to be expected will be tolerable to the structure and not result in instability of the building.

The load test requirements of Section ~~[1808.4]~~ 1810.4 shall apply separately and distinctly to each ~~[different]~~ deep foundation type, ~~[or]~~ capacity ~~[of piling or equipment used]~~, or method of installation, except where analysis of the probable, comparative behavior of the different type or capacity of the ~~[piling]~~ deep foundation or the method of installation indicates that data on one type or capacity of ~~[piling]~~ deep foundation permit a reliable extrapolation of the probable behavior of ~~[the piling of]~~ other types or capacities of deep foundations. The requirements of this section apply to the following proposed conditions:

1. Construction of a foundation for a building incorporating ~~[utilizing piles of]~~ more than one type or capacity of deep foundations;
2. Modification of an existing foundation by the addition of ~~[piles of a]~~ deep foundations differing from the type or capacity ~~[other than those of]~~ used in the existing [piling] foundation;

3. Construction or modification of a foundation utilizing different methods or more than one method of installation, or using different types or capacities of equipment (such as different types of hammers having markedly different striking energies or speeds); or
4. Support of part of a building on [~~piles~~] deep foundations and part on [~~footings~~] shallow foundations.

[1808.2.6] 1810.2.6 Settlement analysis. The settlement of an individual [~~piles~~] deep foundation or groups of [~~piles~~] deep foundations shall be estimated based on approved methods of analysis. The predicted settlement shall cause neither harmful distortion of, nor instability in, the structure, nor cause any stresses to exceed allowable values.

[1808.2.7] 1810.2.7 Use of existing [~~piles~~] deep foundations. [~~Piles~~] Deep foundations left in place where a structure has been demolished shall not be used for the support of new construction unless the [~~piles~~] existing deep foundations are load tested in accordance with Section 1810.4, original installation and testing records of the existing deep foundations are available, or the new loads are no more than half the calculated previous loads on the [~~piles~~] existing deep foundations. The engineer shall determine and certify that the [~~piles~~] existing deep foundations are sound and meet the requirements of this code.

[1808.2.8] 1810.2.8 Special types of [~~piles~~] deep foundations. The use of types of [~~piles~~] deep foundations not specifically mentioned herein is permitted, subject to the approval of the commissioner, upon the submission of acceptable test data, calculations and other information relating to the structural properties and load capacity of such [~~piles~~] deep foundations. The allowable stresses shall not in any case exceed the limitations specified herein.

[1808.2.9] 1810.2.9 Minimum spacing of [~~piles~~] deep foundations. Minimum spacing of [~~piles~~] deep foundations shall: (i) provide for adequate distribution of the load on the [~~pile~~] deep foundation group into the supporting soil or rock, (ii) account for installation effects, and (iii) be in accordance with the recommendations of Section [1808.2.2] 1810.2.2.

[1808.2.10 Piles] 1810.2.10 Deep foundations located near a lot line. [~~Piles~~] Deep foundations located near a lot line shall be designed on the assumption that the adjacent lot will be excavated to a depth of 10 feet (3048 mm) below the nearest legally established curb level. Where such excavation would reduce the embedded length of the [~~pile~~] deep foundation, the portion of the [~~pile~~] deep foundation exposed shall be deemed to provide no lateral or vertical support, and the load-carrying determination shall discount the resistance offered by the soil that is subject to potential excavation.

[1808.2.11] 1810.2.11 Splices. Splices shall be constructed so as to provide and maintain true alignment and position of the component parts of the [~~pile~~] deep foundation element during installation and thereafter and shall be of adequate strength to transmit the vertical and lateral loads (including tensions) and the moments occurring in the [~~pile~~] deep foundation section at the location of the splice without exceeding the allowable stresses for such materials as established in Table [~~1808.8~~] 1810.8. In all cases, splices shall develop at least 50 percent of the bending capacity of the [~~pile in bending~~] deep foundation. In all cases, [~~pile~~] splices situated in the upper 10 feet (3048 mm) of the [~~pile~~] deep foundation shall be capable of resisting (at allowable working stresses) the applied moments and shears. For individual [~~piles~~] deep foundation elements or

groups comprised of two ~~[piles]~~ deep foundation elements, splices in the upper 10 feet (3048 mm) also shall be capable of resisting the moment and shear that would result from an assumed eccentricity of the ~~[pile]~~ load on the deep foundation of 3 inches (~~[76]~~ 76.2 mm). For ~~[piles]~~ deep foundations located near a lot line, the applied moment and shears of such ~~[piles]~~ deep foundations shall be determined on the basis that the adjacent site will be excavated to a depth of 10 feet (3048 mm) below the nearest established curb level as required in Section ~~[1808.2.10]~~ 1810.2.10.

Exception: For caissons core beams, the splice shall develop the lesser of 50 percent of the capacity of the core in bending or twice the design bending moment carried by the core at the location of the splice, provided that the core splice is not within two caisson diameters of any splice in the casing.

~~[1808.2.12]~~ 1810.2.12 Protective treatment of ~~[pile]~~ deep foundation materials. Where boring records or site conditions indicate possible deleterious action on ~~[pile materials]~~ deep foundation elements because of soil constituents or other aggressive environmental factors (such as chemical seepage, the presence of salt water, electrical current, changing water levels or other factors), the ~~[pile materials]~~ deep foundation elements shall be adequately protected by materials, methods or processes approved by the engineer. Protective materials shall be applied to the ~~[piles]~~ deep foundations so as not to be rendered ineffective by driving. The effectiveness of such protective measures for the particular purpose shall have been thoroughly established by satisfactory service records or other evidence.

~~[Piles]~~ Deep foundations installed in ash, garbage, or cinder fills; ~~[piles]~~ deep foundations that are free-standing in or near a seawater environment; ~~[piles]~~ deep foundations used for the support of chemical plants or coal storage; ~~[piles]~~ deep foundations under similar conditions of chemical seepage or aggressive action; and ~~[piles]~~ deep foundations that are used for support of electrical generating plants, shall be investigated regarding the need for special protective treatment. Where special protective treatment is indicated by the engineer, such ~~[piles]~~ deep foundations shall be protected against deterioration by encasement, coating or other device acceptable to the engineer.

~~[1808.2.13]~~ 1810.2.13 Minimum concrete cover. The minimum concrete cover for cast-in-place and precast concrete piles shall be as shown in Table ~~[1808.2.13]~~ 1810.2.13.

**TABLE [1808.2.13] 1810.2.13
MINIMUM CONCRETE COVER FOR CAST IN PLACE AND PRECAST CONCRETE PILES^a**

FOUNDATION ELEMENT OR CONDITION	MINIMUM COVER
1. Precast nonprestressed deep foundation elements Exposed to seawater Not manufactured under plant conditions Manufactured under plant control conditions	3 inches 2 inches In accordance with Section [7.7.3] 20.6.1.3.3 of ACI 318
2. Precast prestressed deep foundation elements Exposed to seawater Other	2.5 inches In accordance with Section [7.7.3] 20.6.1.3.3 of ACI 318
3. Cast-in-place deep foundation elements not enclosed by a steel pipe, tube or permanent casing	2.5 inches
4. Cast-in-place deep foundation elements enclosed by a steel pipe, tube or permanent casing	1 inch
5. Structural steel core within a steel pipe, tube or permanent casing	2 inches
6. Cast-in-place drilled shafts enclosed by a stable rock socket	1.5 inches

For SI: 1 inch = 25.4 mm.

a. The concrete cover provided for prestressed and nonprestressed reinforcement in foundations shall be no less than the largest applicable value specified in Table [1808.2.13] 1810.2.13. Longitudinal bars spaced less than 1½ inches ([38] 38.1 mm) clear distance apart shall be considered bundled bars for which the concrete cover provided shall also be no less than that required by Section [7.7.4] 20.6.1.3.4 of ACI 318. Concrete cover shall be measured from the concrete surface to the outermost surface of the steel to which the cover requirement applies. Where concrete is placed in a temporary or permanent casing or a mandrel, the inside face of the casing or mandrel shall be considered the concrete surface.

[1808.3] 1810.3 Allowable [pile] deep foundation loads. Allowable [pile] deep foundation loads shall be determined in accordance with Sections [1808.3.1] 1810.3.1 through [1808.3.5] 1810.3.5.

[1808.3.1] 1810.3.1 Determination of allowable individual axial compressive loads. The allowable individual axial compressive loads on [piles] deep foundations shall be the lesser of the allowable structural capacity of the element [and] or the allowable geotechnical capacity of the element. This allowable load shall be determined by an engineer experienced in geotechnical engineering and shall be approved by the commissioner as described below:

1. The allowable structural capacity of the [pile] deep foundation shall be determined in accordance with Sections [1808] 1810 through [1813 of this code] 1816.
2. The allowable geotechnical capacity of the [pile] deep foundation shall be calculated using a recognized method of analysis[-] and a minimum factor of safety of 2 with respect to failure.
3. The allowable geotechnical capacity shall be demonstrated by load tests.

Exceptions:

1. Allowable loads for [piles] deep foundations installed by jacking shall be determined in accordance with Section [1808.3.2] 1810.3.2.
2. [Caissons] Caisson piles socketed into Class 1a through 1c material as defined in Table [1804.1] 1806.1.
3. Driven [piles] deep foundations with allowable loads less than or equal to 40 tons (392.7 kN) (30 tons (294.2 kN) for timber piles).
4. Micropiles with allowable loads less than or equal to 20 tons (196.1 kN), provided all of the following criteria are satisfied:

- 4.1. The maximum allowable bond stress between the soil and the grout is less than or equal to 4 psi (27.6 kPa).
- 4.2. The minimum bond zone diameter is greater than or equal to 9 inches (228.6 mm).
- 4.3. The bond zone is formed entirely in Class 3b or better soils.

[1808.3.1.1] 1810.3.1.1 Group effects. The allowable load determined in Section [~~1808.3.1~~] 1810.3.1 shall account for [~~pile~~] group effects on deep foundations. The analysis of group effects shall be performed by an engineer experienced in geotechnical engineering and calculated using recognized methods of analysis. This analysis shall include a bearing capacity and settlement analysis of the anticipated [~~pile groups~~] group(s) of deep foundations and shall consider the presence of weaker soil strata that may be present below the deep foundation element.

[1808.3.1.2] 1810.3.1.2 Down-drag. Where [~~piles~~] deep foundations are installed through subsiding fills or other subsiding strata and derive support from underlying firmer materials, consideration shall be given to the downward frictional forces that may be imposed on the [~~piles~~] deep foundations by the subsiding upper strata.

[1808.3.1.3] 1810.3.1.3 Bearing stratum. The plans for the proposed work shall establish, in accordance with the requirements relating to allowable bearing pressure, the bearing stratum to which the [~~piles~~] deep foundations in the various sections of the building must penetrate and the approximate elevations of the top of such bearing stratum. Where penetration of a given distance into the bearing strata is required for adequate distribution of the loads, such penetration shall be shown on the plans. The indicated elevations of the top of the bearing strata shall be modified by such additional data as may be obtained during construction. All [~~piles~~] deep foundations shall penetrate to or into the designated bearing stratum.

[1808.3.2 Piles] 1810.3.2 Deep foundations installed by jacking or other static forces. The allowable capacity of a [~~pile~~] deep foundation installed by jacking or other static forces shall be not more than 50 percent of the load or force used to install the [~~pile~~] deep foundation to the required penetration, except for [~~piles~~] deep foundations jacked into position for underpinning. The allowable capacity of each deep foundation used for permanent underpinning [~~pile~~] shall not exceed the larger of the following values: $\frac{2}{3}$ of the total jacking force used to obtain the required penetration if the load is held constant for 7 hours without measurable settlement; or $\frac{1}{2}$ of the total jacking force at final penetration if the load is held for a period of 1 hour without measurable settlement. The jacking resistance used to determine the working load shall not include the resistance offered by nonbearing soils, soils which are to be excavated or soils where support will dissipate with time.

[1808.3.3] 1810.3.3 Helical piles. The allowable axial compressive load for helical piles shall be in accordance with the requirements of Section [~~1812~~] 1814.

[1808.3.4] 1810.3.4 Allowable uplift load. Where required by the design, the allowable uplift load for a single [~~pile~~] deep foundation shall be determined in accordance with accepted engineering practices based on a minimum factor of safety of three or by uplift load tests

performed in accordance with Section ~~[1808.4.2.1]~~ 1810.4.2.1. Where uplift load tests are performed, the maximum allowable uplift load shall not exceed the ultimate load capacity divided by a factor of safety of two. The allowable uplift load for a ~~[pile]~~ deep foundation group shall not exceed the sum of the allowable uplift loads of the individual ~~[piles]~~ deep foundations in the group, nor the uplift capacity calculating the group action of the ~~[pile]~~ deep foundation in accordance with accepted engineering practice where the calculated ultimate group capacity is divided by a safety factor of 2.5.

~~[1808.3.5]~~ 1810.3.5 Allowable lateral load. The allowable lateral load of a single ~~[pile]~~ deep foundation element or a ~~[pile]~~ group thereof shall be determined by an approved method of analysis in accordance with accepted engineering practice. The maximum allowable lateral load of a ~~[pile]~~ deep foundation shall be 1 ton (8.9 kN), unless verified by lateral load test. Load testing, where required, shall be in accordance with Section ~~[1808.4.3]~~ 1810.4.3. See Sections ~~[1808.4.3.1]~~ 1810.4.3.1 and ~~[1808.4.3.2]~~ 1810.4.3.2 for determining the allowable lateral load from the results of lateral load tests.

~~[1808.3.5.1]~~ 1810.3.5.1 Group effects. Lateral capacities for ~~[pile]~~ deep foundation groups shall be modified to account for group effects in accordance with accepted engineering practice.

~~[1808.4]~~ 1810.4 Load tests. Where required, ~~[piles]~~ deep foundations shall be load tested in accordance with the requirements of Sections ~~[1808.4.1]~~ 1810.4.1 through ~~[1808.4.3]~~ 1810.4.3.

~~[1808.4.1]~~ 1810.4.1 Compressive load tests. Where load tests are required per Section ~~[1808.3]~~ 1810.3 or ~~[1808.4.1.1.1]~~ 1810.4.1.1.1, the ~~[piles]~~ deep foundations shall be load tested in accordance with the applicable section.

~~[1808.4.1.1]~~ 1810.4.1.1 Required number of load tests. Where load tests are required, at least one test shall be performed in each area of the foundation site within which the subsurface soil conditions are “substantially similar” in character, as determined by the engineer, and at least one test shall be performed for each ~~[pile]~~ deep foundation type for the entire foundation installation of the building or group of buildings on a site occupying a total area of 5,000 square feet (~~[465]~~ 464.5 m²) or less. Where load tests are required, at least two load tests shall be performed for a site having a footprint between 5,000 square feet (~~[465]~~ 464.5 m²) and 30,000 square feet (~~[2787]~~ 2787.1 m²), and one additional load test shall be performed for each 20,000 square feet (~~[1860]~~ 1868.1 m²) of added footprint area. For conditions where multiple ~~[pile]~~ deep foundation types or capacities are used, refer to Section ~~[1808.2.5]~~ 1810.2.5.

~~[1808.4.1.1.1]~~ 1810.4.1.1.1 Additional load tests. Where ~~[installed pile]~~ load bearing capacities of the installed deep foundations are in doubt, ~~[the piles]~~ are considered non-conforming by the engineer, or ~~[as]~~ where required by the commissioner, additional ~~[piles]~~ deep foundation elements shall be load tested to establish the allowable capacity. For friction-based deep foundations ~~[piles]~~ where the actual production ~~[pile]~~ deep foundation lengths vary more than 25 percent from that of the ~~[test pile]~~ deep foundations initially installed and load tested, the engineer shall determine if additional load tests are required to establish the allowable ~~[pile]~~ capacity of the deep foundation. The number of additional load tests shall be determined by the engineer or commissioner.

[1808.4.1.2] 1810.4.1.2 Load test apparatus and inspection requirements. The apparatus and structure to be used in making the load test shall be designed by an engineer. Load tests shall be performed under the observation of the special inspector. A complete record of such tests shall be filed with the commissioner.

[1808.4.1.3] 1810.4.1.3 Compressive load test procedures. Compressive load tests shall be conducted in accordance with ASTM D1143 standard procedures and the following conditions:

1. Dial extensometer gages shall provide readings to the nearest 0.001 inch (0.025 mm). Electrical transducers may be used to make settlement observations, provided that backup measurements are made utilizing dial extensometers as described herein at sufficient times to validate the transducer readings.
2. If the allowable axial compressive load is less than or equal to the Basic Maximum Allowable ~~[Pile Load]~~ Loads on Deep Foundations in Table ~~[1808.4.1.3]~~ 1810.4.1.3, the total test load shall remain in place for a minimum of 12 hours, and shall be held until the average rate of settlement as measured over a 12-hour period does not exceed 0.001 inches (0.025 mm) per hour.[-] The total load shall be removed in decrements not exceeding 25 percent of the total load at 1 hour intervals or longer. For cases where the allowable ~~[pile]~~ load on the deep foundation is greater than the values prescribed in Table ~~[1808.4.1.3]~~ 1810.4.1.3, refer to Section ~~[1808.4.1.5]~~ 1810.4.1.5.
3. In addition to observations required by ASTM D1143, settlement observations shall be performed 24 hours after the entire test load has been removed.

Exception: A static load test for drilled ~~[piles]~~ deep foundations using an embedding load transfer mechanism shall be considered acceptable, provided that the test is performed in general accordance with ASTM D1143 – Quick Load Test Method. The ~~[pile]~~ deep foundation shall be suitably instrumented to evaluate the load transfer through soil or rock at multiple locations along the shaft.

4. Any temporary supporting capacity that the soil might provide to the ~~[pile]~~ deep foundation during a load test, but which would be dissipated with time, shall be eliminated by casing off or by other suitable means, such as increasing the total test load to account for such temporary capacity.

**TABLE [1808.4.1.3] 1810.4.1.3
BASIC MAXIMUM ALLOWABLE PILE LOADS**

TYPE OF PILE	MAXIMUM ALLOWABLE PILE LOAD (TONS)	
Caisson Piles	No upper limit	
Open-end pipe (or tube) piles bearing on rock of Class 1a, 1b, or 1c	18-in O.D. and greater	250
	14-in to 18-in O.D.	200
	12-in to 14-in O.D.	150
	10-in to 12-in O.D.	100
	8-in to 10-in O.D.	60
Closed-end pipe (or tube) piles, H-piles, cast-in-place concrete, enlarged base piles, and precast concrete piles bearing on rock of Class 1a, 1b, or 1c	150	
Piles (other than timber or helical piles) bearing on soft rock of Class 1d	80	
Piles (other than timber or helical piles) that receive their principal support other than by direct bearing on rock of Class 1a through 1d	75	
Timber piles bearing on rock of Class 1a through 1d	25	
Timber piles bearing in suitable soils	40 tons maximum permissible with load test, 30 tons maximum without load test.	
Helical piles	30 tons maximum permissible	

For SI: 1 ton = 907.18 kg.

[1808.4.1.4] 1810.4.1.4 High strain, dynamic compressive test methods. High strain, dynamic compressive test methods performed in accordance with ASTM D4945 shall be permitted to be used where ~~three~~ two or more load tests are required and subject to the approval of the commissioner. In such case, at least one high strain dynamic test shall be performed as a calibration on a static load tested [pile] deep foundation or nearby [pile] deep foundation driven to comparable resistance. No more than one-half of the required number of load tests may be performed by high strain dynamic methods. High strain dynamic tests shall be performed under the supervision of an engineer experienced in the methods used. The number of high strain dynamic tests shall be at least twice the number of replaced static load tests.

[1808.4.1.5] 1810.4.1.5 Acceptance criteria. The allowable [pile] load of a deep foundation shall be the lesser of the two values computed as follows:

1. Fifty percent of the applied load causing a net settlement of the [pile] tested deep foundation of not more than $\frac{1}{100}$ of 1 inch per ton (0.25 mm per 8.9 kN) of applied load. Net settlement in this paragraph is defined as gross settlement due to the total test load minus the rebound after removing 100 percent of the test load.
2. Fifty percent of the applied load causing a net settlement of the [pile] tested deep foundation of $\frac{3}{4}$ inch (~~19~~ 19.1 mm). Net settlement in this paragraph is defined as the gross settlement due to the total test load less the amount of elastic shortening in the [pile] deep foundation section due to total test load. The elastic shortening shall be calculated as if the [pile] deep foundation is designed ~~as an~~ for end-bearing [pile] or

[as a] friction [pile]. Alternatively, the net settlement may be measured directly using a telltale or other suitable instrumentation.

[1808.4.1.5.1] 1810.4.1.5.1 Substantiation of higher allowable loads. The basic maximum allowable [pile] loads of deep foundations tabulated in Table [1808.4.1.3] 1810.4.1.3 may be exceeded where a higher value can be substantiated on the basis of load tests and analysis, except for the loads for timber and helical piles. The provisions of Section [1808.4.1] 1810.4.1 shall be supplemented, as follows: the final load increment shall remain in place for a total of not less than 24 hours; single [test piles] tested deep foundations shall be subjected to cyclical loading in accordance with ASTM D1143 or suitably instrumented with telltales and strain gauges so that the movements of the [pile] tip and butt of the deep foundation may be independently determined and load transfer to the soil evaluated. A complete record demonstrating satisfactory performance of the test shall be submitted to the commissioner.

[1808.4.2] 1810.4.2 Uplift load test. Where uplift load tests are required, one uplift load test shall be conducted in each area of substantially similar subsurface conditions up to 5,000 square feet (465 m²) of building footprint where [piles] deep foundations are subjected to uplift, and not less than two uplift load tests shall be conducted for each area of building footprint where [piles] deep foundations are subjected to uplift between 5,000 square feet (465 m²) and 30,000 square feet ([2787] 2787.1 m²) and for such area one additional [upload] uplift load test shall be conducted for each 20,000 square feet ([1860] 1858.1 m²) of additional area of building footprint where [piles] deep foundations are subject to uplift. For conditions where multiple [pile] types or capacities of deep foundations are used, refer to Section [1808.2.5] 1810.2.5.

[1808.4.2.1] 1810.4.2.1 Uplift load test procedures. Uplift load tests shall be conducted in accordance with ASTM D3689 standard procedures and the following conditions:

1. Dial extensometer gages shall provide readings to the nearest 0.001 inch (0.025 mm). Electrical transducers may be used to make settlement observations provided that backup measurements are made utilizing dial extensometers as described 5herein at sufficient times to validate the transducer readings.
2. Any temporary supporting capacity that the soil might provide to the [pile] deep foundation during a load test, but which would be dissipated with time, shall be eliminated by casing off or by other suitable means, such as increasing the total test load to account for such temporary capacity.

[1808.4.2.2] 1810.4.2.2 Uplift load test apparatus and inspection requirements. The apparatus and structure to be used in making the load test shall be designed by an engineer. Load tests shall be performed under the observation of the special inspector. A complete record of such tests shall be filed with the commissioner.

[1808.4.3] 1810.4.3 Lateral load tests. Where testing is required, lateral load tests shall be performed in accordance with ASTM D3966. A minimum of two [piles] deep foundations shall be tested for every area of similar subsurface conditions. For conditions where multiple [pile] types or capacities of deep foundations are used, refer to Section [1808.2.5] 1810.2.5.

[1808.4.3.1] 1810.4.3.1 Free headed [piles] deep foundations. For [piles] deep foundations whose heads are to be designed to be free to rotate in the final structure, the maximum test load shall be at least twice the proposed design working load. In the absence of specific project requirements as determined by the engineer, the resulting allowable load shall not be more than one-half of that test load that produces a gross lateral movement of 1 inch (~~[25]~~ 25.4 mm) of the deep foundation at the ground surface.

[1808.4.3.2] 1810.4.3.2 Fixed headed [piles] deep foundations. For [piles] deep foundations whose heads are designed to be fixed in the final structure, the results of the load test shall be used to verify the input parameters used in the lateral load analysis. In the absence of specific project requirements as determined by the engineer, the allowable load shall be the load that produces a gross lateral movement of $\frac{3}{8}$ [~~of an~~] inch (9.5 mm) of the deep foundation at the ground surface in the lateral load analysis.

[1808.4.3.3] 1810.4.3.3 Lateral load test procedures. Lateral load tests shall be conducted in accordance with ASTM D3966 standard procedures. In addition, dial extensometer gages shall provide readings to the nearest 0.001 inch (0.025 mm). Electrical transducers may be used to make deflection observations, provided that backup measurements are made utilizing dial extensometers as described herein at sufficient times to validate the transducer readings.

[1808.4.3.4] 1810.4.3.4 Load test apparatus and inspection requirements. The apparatus and structure to be used in making the load test shall be designed by an engineer. Lateral load tests shall be performed under the observation of the special inspector. A complete record of such tests shall be filed with the commissioner.

[1808.5] 1810.5 Installation. Installation of [piles] deep foundations shall be subject to the requirements of Sections [~~1808.5.4]~~ 1810.5.1 through [~~1808.5.8]~~ 1810.5.8.

[1808.5.1] 1810.5.1 Protection of [piles] deep foundations during installation. [Piling] Deep foundations shall be handled and installed to the required penetration and resistance by methods that leave the [piles'] deep foundations' strength unimpaired and that develop and retain the [piles'] deep foundations' required load-bearing resistance. Any damaged [pile] deep foundation shall be satisfactorily repaired or the [pile] deep foundation shall be rejected. As an alternative and subject to the approval by the commissioner, deep foundations that are damaged [~~or~~], misaligned [~~piles or piles~~], or do not [~~reaching~~] reach their design tip elevation may be used at a reduced fraction of the design load based on an analysis by the engineer.

[1808.5.2] 1810.5.2 Equipment. Equipment and methods of installation shall be such that [piles] deep foundations are installed in their proper position and alignment[;] without damage. Equipment shall be maintained in good working order.

[1808.5.3] 1810.5.3 Preexcavation. The use of jetting, augering or other methods of preexcavation shall be subject to the approval of the commissioner. Where permitted, preexcavation shall be carried out in the same manner as used for [piles] deep foundation elements subject to load tests and in such a manner that will not impair the carrying capacity of the [piles] deep foundation elements already in place or damage adjacent structures. [Pile] The element tips of deep foundations shall be [~~driven~~] advanced below the preexcavated depth until the required resistance or penetration is obtained.

[1808.5.4] 1810.5.4 Minimum ~~[pile penetrations]~~ penetration of deep foundations. ~~[Piles]~~ Deep foundations shall penetrate the minimum distance required to develop the required load capacity of the ~~[pile]~~ deep foundation as established by the required penetration resistance and load tests as applicable.

[1808.5.5] 1810.5.5 Damage to adjacent structures or ~~[piles]~~ deep foundations. ~~[Piles]~~ Deep foundations shall be installed in such a manner and sequence as to prevent distortion or damage that affects the structural integrity of the ~~[piles]~~ deep foundations being installed, or previously installed adjacent ~~[piles]~~ deep foundations. The sequence of the installation shall avoid compacting the surrounding soil to the extent that other ~~[piles]~~ deep foundations cannot be installed properly, and shall prevent ground movements that are capable of damaging adjacent structures. ~~[Piles]~~ Deep foundations shall be installed with adequate provision for the protection of adjacent buildings and property.

[1808.5.6] 1810.5.6 Identification. All ~~[pile materials]~~ deep foundation elements shipped or delivered to the job site shall be identified for conformity to the specified grade and this identification shall be maintained continuously from the point of manufacture to the point of installation. Such shipment or delivery shall be accompanied by a certification from the material supplier or manufacturer indicating conformance with the construction documents. Such certification shall be made available to the engineer of record and the department. In the absence of adequate data, ~~[pile materials]~~ deep foundation elements shall be tested by an approved agency to determine conformity ~~[to]~~ to the specified grade. The approved agency shall furnish a certification of compliance to the engineer of record, or upon request to the commissioner.

[1808.5.7 Pile] 1810.5.7 Deep foundation location plan. A plan showing the location and designation of ~~[piles]~~ deep foundations by an identification system shall be filed with the commissioner prior to installation of such ~~[piles]~~ deep foundations. Detailed records for individual ~~[piles]~~ deep foundations shall bear an identification corresponding to that shown on the plan.

[1808.5.8] 1810.5.8 Installation of ~~[piles]~~ deep foundations. ~~[Piles]~~ Deep foundations within the area of influence of a given, satisfactorily tested ~~[pile]~~ deep foundation shall be installed to the same installation criteria as the ~~[successful test pile]~~ satisfactorily tested deep foundation. The same equipment that was used to install the ~~[test pile]~~ satisfactorily tested deep foundation, identically operated in all aspects, shall be used to install the ~~[piles]~~ deep foundation. All ~~[piles]~~ deep foundation shall be of the same type, size and shape as the ~~[test pile]~~ satisfactorily tested deep foundation. All ~~[piles]~~ deep foundations within the area of influence as represented by a given satisfactorily tested ~~[test pile]~~ deep foundation shall bear in, or on, the same bearing stratum as the ~~[test pile]~~ satisfactorily tested deep foundation.

[1808.6] 1810.6 Tolerances. Tolerances for ~~[piles]~~ deep foundations shall be in accordance with the requirements of Sections ~~[1808.6.1] 1810.6.1~~ through ~~[1808.6.4] 1810.6.4~~.

[1808.6.1] 1810.6.1 Tolerance in the location of the head of the ~~[pile]~~ deep foundation. A tolerance of 3 inches (~~[76]~~ 76.2 mm) from the designed location shall be permitted in the installation of each ~~[pile]~~ deep foundation as measured from ~~[the pile]~~ its head, without reduction in load capacity of the ~~[pile]~~ deep foundation group unless otherwise noted on the foundation plans. When ~~[piles]~~ deep foundations are installed outside of this tolerance, the true loading on such ~~[piles]~~ deep foundations shall be analytically determined from a survey that defines the

actual location of the [piles] deep foundations as installed and using the actual eccentricity in the [pile] deep foundation group with respect to the line of action of the applied load.

[1808.6.2] 1810.6.2 Out of plumb tolerance. If the axis of any [pile] deep foundation is installed out of plumb or deviates from the specified batter by more than 4 percent, the design of the foundation shall be modified to resist the resulting vertical and lateral forces. In types of [piles] deep foundations for which subsurface inspection is not possible, this determination shall be made on the exposed section of the [pile] deep foundation, which ~~[section,~~ at the time of checking axial alignment, shall not be less than 2 feet (~~[640]~~ 609.6 mm) in length. In [pile] deep foundations that can be checked for axial alignment below the ground surface, the sweep of the [pile] deep foundation axis shall not exceed 4 percent of the embedded length.

[1808.6.3] 1810.6.3 [Bent piles] Deep foundations that are bent during installation. The load-bearing capacity of [piles] deep foundations discovered to have a sharp or sweeping bend shall be determined using an approved method of analysis by the engineer responsible for the [pile] deep foundation design in accordance with accepted engineering practice or by load testing a representative [pile] deep foundation.

[1808.6.4] 1810.6.4 [Mislocated piles] Deep foundations that are mislocated during installation. The maximum compressive load on any [pile] deep foundation due to mislocation shall not exceed 110 percent of the allowable design load. If the total load on any [pile] deep foundation, so determined, is in excess of 110 percent of the allowable load-bearing capacity, correction shall be made by installing additional [piles] deep foundations or by other methods of load distribution as required to reduce the maximum [pile] load to 110 percent of the allowable [pile] deep foundation capacity.

[1808.7] 1810.7 Lateral support. Lateral support for [piles] deep foundation elements shall be in accordance with the requirements of Sections ~~[1808.7.1]~~ 1810.7.1 through ~~[1808.7.4]~~ 1810.7.4.

[1808.7.1] 1810.7.1 Buckling of [piles] deep foundations. Any soil other than soil with no shear strength shall be deemed to afford sufficient lateral support to the [pile] deep foundation to prevent buckling and to permit the design of the [pile] deep foundation in accordance with accepted engineering practice and the applicable provisions of this code.

[1808.7.2] 1810.7.2 Unbraced [piles] deep foundations. [Piles] Deep foundation elements standing unbraced in air, water or soils with no shear strength shall be designed as columns in accordance with the provisions of this code. Such [piles] deep foundations driven into firm ground can be considered fixed and laterally supported at 5 feet (1524 mm) below the ground surface and in soft material at 10 feet (3048 mm) below the ground surface unless otherwise prescribed by the engineer.

[1808.7.3] 1810.7.3 Bracing at tops of [piles] deep foundations. [Piles] Deep foundations shall be braced to provide lateral stability and resist eccentric loads and moments in all directions. Three or more [piles] deep foundations connected by a rigid cap shall be considered braced, provided that the [pile] deep foundations are located in radial directions from the centroid of the group not less than 60 degrees (1 rad) apart. A ~~[two-pile]~~ group of two deep foundation elements in a rigid cap shall be considered to be braced along the axis connecting the two [piles] deep foundations.

Methods used to brace ~~[piles]~~ deep foundations shall be subject to the approval of the commissioner.

~~[Piles]~~ Deep foundations supporting walls shall be driven alternately in lines spaced at least 1 foot (~~[305]~~ 304.8 mm) apart and located symmetrically under the center of gravity of the wall load carried, unless effective measures are taken to provide for eccentricity and moments due to lateral forces, or the ~~[wall-piles]~~ deep foundations supporting the wall are adequately braced. A single row of ~~[piles]~~ deep foundations without bracing is permitted for one and two-family dwellings and lightweight construction not exceeding two stories or 35 feet (10 668 mm) in height, provided the centers of the ~~[piles]~~ deep foundations are located within the width of the wall.

~~[1808.7.4]~~ **1810.7.4 Bracing of short ~~[piles]~~ deep foundations.** All pile caps supported by ~~[piles]~~ deep foundations that penetrate less than ~~[ten-feet]~~ 10 feet (3048 mm) below cutoff level or less than ~~[ten-feet]~~ 10 feet (3048 mm) below ground level shall be braced against lateral movement. Such bracing may consist of connection to other pile caps that encompass ~~[piles]~~ deep foundations embedded more than ~~[ten-feet]~~ 10 feet (3048 mm) below those levels. The heads of the ~~[piles]~~ deep foundations shall be fixed in the cap. In no case shall more than fifty percent of the ~~[piles]~~ deep foundations in the foundation of any building penetrate less than ~~[ten-feet]~~ 10 feet (3048 mm) below cut-off level or less than ~~[ten-feet]~~ 10 feet (3048 mm) below ground level.

Exception: The requirements of this section shall not apply to caisson piles.

~~[1808.7.4.1 Piles]~~ **1810.7.4.1 Deep foundations located near a lot line.** Where the embedded length of ~~[piles]~~ deep foundations located near a lot line would be reduced to less than ~~[ten-feet]~~ 10 feet (3048 mm) by excavation of the adjacent site to a depth of ~~[ten-feet]~~ 10 feet (3048 mm) below the nearest established curb level, the provisions of Section ~~[1808.7.4]~~ 1810.7.4 shall apply.

~~[1808.8]~~ **1810.8 Allowable stresses.** Allowable stresses for ~~[piles]~~ deep foundations shall be as listed in Table ~~[1808.8]~~ 1810.8.

~~[1808.8.1 Allowable stresses for piles.]~~ Allowable stresses for designing piles shall be as specified in Table ~~1808.8.~~

Exception: Allowable stresses greater than those specified in Table ~~[1808.8]~~ 1810.8 in Sections ~~[1809]~~ 1811 and ~~[1810]~~ 1812 shall be permitted where supporting data justifying such higher stresses are filed and approved by the commissioner.

**TABLE [1808.8] 1810.8
ALLOWABLE AXIAL STRESSES FOR MATERIALS USED IN [PILES] DEEP FOUNDATION
ELEMENTS^a**

MATERIAL TYPE AND CONDITION	MAXIMUM ALLOWABLE STRESS ^{[a]b}
1. Concrete or grout in compression ^{[b]c} Cast-in-place with a permanent casing in accordance with Section [1810.5.2] 1812.5.2 Cast-in-place in a pipe, tube, other permanent casing or rock Cast-in-place without a permanent casing Precast nonprestressed Precast prestressed	$0.4 f'_c$ $0.33 f'_c$ $0.3 f'_c$ $0.33 f'_c$ $0.33 f'_c - 0.27 f_{pc}$
2. Nonprestressed reinforcement in compression	$0.4 f_y \leq 30,000$ psi
3. Structural steel in compression Cores within concrete-filled pipes or tubes Pipes, tubes or H-piles, where justified in accordance with Section [1808.2.10] 1810.4.1.5.1 Pipes or tubes for micropiles or caissons less than 14 inches in diameter Other pipes, tubes or H-piles Helical piles	$0.5 F_y \leq 32,000$ psi $0.5 F_y \leq 32,000$ psi $0.4 F_y \leq 32,000$ psi $0.35 F_y \leq 16,000$ psi $0.6 F_y \leq 0.5 F_u$
4. Nonprestressed reinforcement in tension Within micropiles or caissons less than 14 inches in diameter Other conditions	$0.6 f_y$ $0.5 f_y \leq 24,000$ psi
5. [Structural steel] Steel in tension Structural steel cores in caisson piles Pipes, tubes or H-piles, where justified in accordance with Section [1808.2.10] 1810.4.1.5.1 Other pipes, tubes or H-piles Helical piles	$0.5 F_y \leq 32,000$ psi $0.5 F_y \leq 32,000$ psi $0.35 F_y \leq 16,000$ psi $0.6 F_y \leq 0.5 F_u$
6. Timber	See Section [1809.5.4] 1811.5.4

For SI: 1 pound per square inch = 6.895 kPa.

a. For combined stresses, the structural capacity shall be computed in accordance with AISC 360 for steel piles and ACI 318 for concrete piles.

[a]b. f'_c is the specified compressive strength of the concrete or grout; f_{pc} is the compressive stress on the gross concrete section due to effective prestress forces only; f_y is the specified yield strength of reinforcement; F_y is the specified minimum yield stress of [structural] steel; F_u is the specified minimum tensile stress of [structural] steel.

[b]c. The stresses specified apply to the gross cross-sectional area [within the concrete surface.] for precast concrete piles. The stresses specified shall apply to the concrete cross-sectional area for all other deep foundation elements. Where a temporary or permanent casing is used, the inside face of the casing shall be considered the concrete surface.

[1808.9 Seismic Design Categories C & D.]

[1808.9.1] 1810.9 Seismic design of [piles] deep foundations. Seismic design of [piles] deep foundation elements for structures assigned to Seismic Design Categories C & D shall be performed in accordance with Sections [1808.9.1 through 1808.9.3] 1810.9.1 and 1810.9.2.

[1808.9.2] 1810.9.1 Seismic Design Category C. Where a structure is assigned to Seismic Design Category C in accordance with Section 1613, individual pile caps or ~~[piles]~~ deep foundations shall be interconnected by ties. Ties shall be capable of carrying, in tension and compression, a force equal to the lesser of: (i) the product of the larger of the pile cap or column design gravity load times the seismic coefficient, S_{DS} , divided by 10, or (ii) 25 percent of the smaller of the ~~[pile]~~ deep foundation or column design gravity load, unless it can be demonstrated that equivalent restraint is provided by reinforced concrete beams within slabs on grade, reinforced concrete slabs on grade, or confinement by competent rock, hard cohesive soils or very dense granular soils.

[1808.9.2.1] 1810.9.1.1 Connection to pile cap. For structures assigned to Seismic Design Category C or D in accordance with Section 1613, ~~[concrete]~~ deep foundation elements consisting of concrete shall be connected to the pile cap by embedding the element reinforcement or field-placed dowels anchored in the element into the pile cap for a distance equal to their development length in accordance with ACI 318. It shall be permitted to connect precast, prestressed ~~[piles]~~ deep foundations to the pile cap by developing the element prestressing strands into the pile cap, provided the connection is ductile. For deformed bars, the development length is the full development length for compression, or tension in the case of uplift, without reduction for excess reinforcement in accordance with Section 25.4.10 of ACI 318. Alternative measures for laterally confining concrete and maintaining toughness and ductile-like behavior at the top of the element shall be permitted, provided the design is such that any hinging occurs in the confined region. The minimum transverse steel ratio for confinement shall not be less than one-half of that required for columns.

For resistance to uplift forces, anchorage of steel pipes, tubes or H-piles to the pile cap shall be made by means other than concrete bond to the bare steel section. Concrete-filled steel pipes or tubes shall have reinforcement of not less than 0.01 times the cross sectional area of the concrete fill, developed into the cap and extending into the concrete fill a length equal to two times the required cap embedment, but not less than the development length in tension of the reinforcement.

Exception: Anchorage of concrete-filled steel pipe piles is permitted to be accomplished using deformed bars developed into the concrete portion of the ~~[pile]~~ deep foundation. Splices of ~~[pile]~~ deep foundation segments shall develop the full strength of the ~~[pile]~~ deep foundation, but the splice need not develop the nominal strength of the ~~[pile]~~ deep foundation in tension, shear and bending when the splice has been designed to resist axial and shear forces and moments from the load combinations of Section 12.4 of ASCE 7[-10].

[1808.9.2.2] 1810.9.1.2 Design details. ~~[Pile moments]~~ Moments, shears and lateral deflections used for design of deep foundations shall be established considering the nonlinear interaction of the shaft and soil, as recommended by the engineer. Where the ratio of the depth of embedment of the ~~[pile to pile]~~ center-to-center diameter or width of deep foundations is less than or equal to six, the ~~[pile]~~ deep foundation may be assumed to be rigid. ~~[Pile group]~~ Group effects from soil on lateral ~~[pile]~~ deep foundation nominal strength shall be included where ~~[pile]~~ deep foundation center-to-center spacing in the direction of lateral force is less than eight ~~[pile]~~ diameters. ~~[Pile group]~~ Group effects on vertical nominal strength of deep foundations shall be included where ~~[pile]~~ deep foundation center-to-center spacing is less than three ~~[pile]~~ diameters. The ~~[pile]~~ uplift soil nominal strength of deep foundations shall

be taken as the ~~[pile]~~ uplift strength as limited by the frictional force developed between the soil and the ~~[pile]~~ deep foundation.

Where a minimum length for reinforcement or the extent of closely spaced confinement reinforcement is specified at the top of the ~~[pile]~~ deep foundation, provisions shall be made so that those specified lengths or extents are maintained after ~~[pile]~~ deep foundation cutoff.

~~[1808.9.3]~~ **1810.9.2 Seismic Design Category D.** Where a structure is assigned to Seismic Design Category D in accordance with Section 1613, the requirements for Seismic Design Category C given in Section ~~[1808.9.2]~~ 1810.9.1 shall be met. Provisions of ACI 318, Section ~~[21.12.4]~~ 18.13.4, shall also apply when not in conflict with the provisions of Sections ~~[1808]~~ 1810 through ~~[1813]~~ 1816. Concrete shall have a specified compressive strength of not less than 3,000 psi (20.68 MPa) at 28 days.

Exceptions:

1. Group R or U occupancies of light-framed construction and two stories or less in height are permitted to use concrete with a specified compressive strength of not less than 2,500 psi (17.2 MPa) at 28 days.
2. Detached one and two-family dwellings of light-frame construction and two stories or less in height are not required to comply with the provisions of ACI 318, Section ~~[21.12.4]~~ 18.13.4.
3. Section ~~[21.12.4.4(a)]~~ 18.13.4.4(a) of ACI 318 shall not apply to concrete piles.

~~[1808.9.3.1]~~ **1810.9.2.1 Design details for ~~[piles]~~ deep foundations and grade beams.** Design details for deep foundations and grade beams shall comply with the following:

- ~~[Piles]~~ 1. Deep foundations shall be designed and constructed to withstand maximum imposed curvatures from earthquake ground motions and structure response. Curvatures shall include free-field soil strains modified for soil-pile-structure interaction coupled with ~~[pile]~~ deformations of deep foundations induced by lateral ~~[pile]~~ resistance of deep foundations to structure seismic forces.
2. Concrete piles on Site Class E or F sites, as determined in Section ~~[1613.5.2]~~ 1613.3.2 of this code, shall be designed and detailed in accordance with Sections ~~[21.12.4.1, 21.12.4.2 and 21.12.4.3]~~ 1813.4.1 and 1813.4.2 of ACI 318 within a distance of ~~[seven]~~ 7 ~~[pile]~~ diameters of the deep foundation element of the pile cap and the interfaces of soft to medium stiff clay or liquefiable strata. For precast prestressed concrete piles, detailing provisions as given in Sections ~~[1809.6.3.2.1]~~ 1811.6.3.2 and ~~[1809.6.3.2.2]~~ 1811.6.3.2.2 of this code shall apply.
3. Grade beams shall be designed as beams in accordance with ACI 318, Chapter ~~[21]~~ 18. When grade beams have the capacity to resist the forces from the load combinations in Section 1605.4 of this code, they need not conform to ACI 318, Chapter ~~[21]~~ 18.

[1808.9.3.2] 1810.9.2.2 Connection to pile cap. For [piles] deep foundations required to resist uplift forces or provide rotational restraint, design of anchorage of [piles] deep foundations into the pile cap shall be provided considering the combined effect of axial forces due to uplift and bending moments due to fixity to the pile cap. Anchorage into the pile cap shall be capable of developing the following:

1. In the case of uplift, the lesser of the nominal tensile strength of the longitudinal reinforcement in a concrete pile, or the nominal tensile strength of a steel pile, or the [pile] deep foundation uplift soil nominal strength factored by 1.3 or the axial tension force resulting from the load combinations of Section 12.4 of ASCE 7[-10].
2. In the case of rotational restraint, the lesser of the axial and shear forces, and moments resulting from the load combinations of Section 12.4 of ASCE 7[-10] or development of the full axial, bending and shear nominal strength of the [pile] deep foundation.

[1808.9.3.3] 1810.9.2.3 Flexural strength. Where the vertical, lateral-force-resisting elements are columns, the grade beam or pile cap flexural strengths shall exceed the column flexural strength.

[1808.9.3.4] 1810.9.2.4 [~~Batter piles~~] Battered deep foundations. The connection between [batter piles] deep foundations that are battered and grade beams or pile caps shall be designed to resist the nominal strength of the [pile] deep foundation acting as a short column. [Batter piles] Battered deep foundations and their connections shall be capable of resisting forces and moments from the load combinations of Section 12.4 of ASCE 7[-10].

SECTION BC ~~[1809]~~ 1811 DRIVEN ~~[PILES]~~ DEEP FOUNDATIONS

[1809.1] 1811.1 General. Driven [piles] deep foundations shall be designed and installed in accordance with Sections ~~[1808]~~ 1810 and ~~[1809.2]~~ 1811.2 through ~~[1809.7]~~ 1811.7. Driven deep foundation elements shall be designed and manufactured in accordance with accepted engineering practice to resist all stresses induced by handling, driving and service loads.

[1809.2] 1811.2 Equipment. Equipment and methods of installation shall be such that [piles] deep foundations are installed in their proper position and alignment, without damage. Equipment shall be maintained in good working order.

~~[1809.2.1 Pile driving]~~ 1811.2.1 Driving hammer for deep foundations. The hammer to be used to drive [piles] deep foundations shall deliver a maximum energy consistent with the size, strength and weight of the driven [piles] deep foundations. The ~~[pile driving]~~ hammer shall travel freely in the leads. The hammer shall deliver its rated energy, and measurements shall be made of the fall of the ram or other suitable data shall be obtained at intervals necessary to verify the actual energy delivered during the final 20 blows of the hammer.

[1809.2.2] 1811.2.2 Cushion or cap block. The cushion or cap block shall be a solid block of hardwood with its grains parallel to the axis of the [pile] deep foundation and enclosed in a tight-fitting steel housing, or other accepted equivalent assembly. If laminated materials are used, their type and construction shall be such that their strength is equal to or greater than hardwood. Wood

chips, pieces of rope, hose, shavings, automobile tires or similar materials shall not be used. Cap block cushions shall be replaced if burned, crushed, or otherwise damaged. Other cushion materials may be used subject to the approval of the engineer. The introduction of fresh hammer cushion or ~~[pile]~~ pile-driving cushion material just prior to final penetration is not permitted.

~~[1809.2.3]~~ **1811.2.3 Followers.** Followers shall not be used unless permitted in writing by the engineer responsible for the ~~[pile]~~ driving operation of the deep foundation. The required driving resistance shall account for the losses of driving energy transmitted to the ~~[pile]~~ deep foundation because of the follower. The follower shall be a single length section, be provided with a socket or hood carefully fitted to the top of the ~~[pile]~~ deep foundation to minimize loss of energy and to prevent damage to the ~~[pile]~~ deep foundation, and have sufficient rigidity to prevent “whip” during driving.

~~[1809.3]~~ **1811.3 Driving criteria.** The allowable compressive load on steel and concrete piles, where determined solely by the application of an approved wave equation analyses approved by the engineer, shall not exceed 40 tons (~~[356]~~ 392.3 kN). The allowable compressive loads on timber piles, where determined solely by the wave equation analyses approved by the engineer, shall not exceed 30 tons (~~[267]~~ 294.2 kN). For allowable loads greater than these values, the wave equation method of analysis may be used to establish initial driving criteria, but final driving criteria and the allowable load shall be verified by load tests in accordance with Section ~~[1808.4]~~ 1810.4. Minimum driving resistance and hammer energy may be determined in accordance with Tables ~~[1809.3(a)]~~ 1811.3(a) and ~~[1809.3(b)]~~ 1811.3(b).

TABLE [1809.3(a)] 1811.3(a)
MINIMUM DRIVING RESISTANCE AND MINIMUM HAMMER ENERGY FOR
STEEL H-PILES, PIPE PILES, PRECAST AND CAST-IN-PLACE CONCRETE PILES AND COMPOSITE PILES
(other than timber)

MINIMUM DRIVING RESISTANCE ^{a, c, d, e}					
Pile Capacity (tons)	Hammer Energy ^b (ft. lbs.)	Friction Piles (blows/ft.)	Piles Bearing on Soft Rock (Class 1d) (blows/ft.)	Piles Bearing on Rock (Class 1a, 1b, and 1c)	
Up to 20	15,000	19	48	5 Blows per ¼ inch (Minimum hammer energy of 15,000 ft. lbs.)	
	19,000	15	27		
	24,000	11	16		
30	15,000	30	72		
	19,000	23	40		
	24,000	18	26		
40	15,000	44	96		
	19,000	32	53		
	24,000	24	34		
> 40	AS PER SECTION [1809.3] 1811.3				

For SI: 1 foot = 304.8 mm, 1 ton = 907.18 kg.

- Final driving resistance shall be the sum of tabulated values plus resistance exerted by nonbearing materials. The driving resistance of nonbearing materials shall be taken as the resistance experienced by the pile during driving, but which will be dissipated with time and may be approximated as described in Section [1809.3] 1811.3.
- The hammer energy indicated is the rated energy.
- Sustained driving resistance. Where piles are to bear in soft rock, the minimum driving resistance shall be maintained for the last 6 inches, unless a higher sustained driving resistance requirement is established by load test. Where piles are to bear in soil Classes 2 through 5, the minimum driving resistance shall be maintained for the last twelve inches unless load testing demonstrates a requirement for higher sustained driving resistance. No pile needs to be driven to a resistance that penetrates in blows per inch (blows per [25] 25.4 mm) more than twice the resistance indicated in this table, nor beyond the point at which there is no measurable net penetration under the hammer blow.
- The tabulated values assume that the ratio of total weight of pile to weight of striking part of the hammer does not exceed 3.5. If a larger ratio is to be used, or for other conditions for which no values are tabulated, the driving resistance shall be as approved by the commissioner.
- For intermediate values of pile capacity, minimum requirements for driving resistance may be determined by straight line interpolation.

TABLE [1809.3(b)] 1811.3(b)
MINIMUM DRIVING RESISTANCE AND HAMMER ENERGY FOR TIMBER PILES

PILE CAPACITY (TONS)	MINIMUM DRIVING RESISTANCE (BLOWS/IN.) TO BE ADDED TO DRIVING RESISTANCE EXERTED BY NONBEARING MATERIALS (NOTES 1, 3, 4)	HAMMER ENERGY (ft./lbs.) (Note 2)
Up to 20	Formula in Note 4 shall apply	7,500-12,000
Over 20 to 25		9,000-12,000
		14,000-16,000
Over 25 to 30		12,000-16,000 (single-acting hammers)

**TABLE ~~[1809.3(b)] 1811.3(b)~~
MINIMUM DRIVING RESISTANCE AND HAMMER ENERGY FOR TIMBER PILES**

PILE CAPACITY (TONS)	MINIMUM DRIVING RESISTANCE (BLOWS/IN.) TO BE ADDED TO DRIVING RESISTANCE EXERTED BY NONBEARING MATERIALS (NOTES 1, 3, 4)	HAMMER ENERGY (ft./lbs.) (Note 2)
Greater than 30		15,000-20,000 (double-acting hammers)

For SI: 1 ton = 907.18 kg, 1 inch = 25.4 mm.

Notes:

1. The driving resistance exerted by nonbearing materials is the resistance experienced by the pile during driving, but which will be dissipated with time and may be approximated as described in Section ~~[1809.3] 1811.3~~.
2. The hammer energy indicated is the rated energy.
3. Sustained driving resistance. Where piles are to bear in soft rock, the minimum driving resistance shall be maintained for the last 6 inches (152.4 mm), unless a higher sustained driving resistance requirement is established by load test. Where piles are to bear in soil Classes 2 through 5, the minimum driving resistance measured in blows per inch (blows per ~~[25] 25.4~~ mm) shall be maintained for the last 12 inches unless load testing demonstrates a requirement for higher sustained driving resistance. No pile need be driven to a resistance that penetrates in blows per inch (blows per ~~[25] 25.4~~ mm) more than twice the resistance indicated in this table nor beyond the point at which there is no measurable net penetration under the hammer blow.

4. The minimum driving resistance shall be determined by the following formula:

$$P = \frac{2W_h H}{(S+0.1)} \text{ or } P = \frac{2E}{(S+0.1)}$$

where:

P = Allowable pile load in pounds.

W_p = Weight of pile in pounds.

W_h = Weight of striking part of hammer in pounds.

H = Actual height of fall of striking part of hammer in feet.

E = Rated energy delivered by the hammer per blow in foot/lbs.

S = Penetration of pile per blow, in inches, after the pile has been driven to a depth where successive blows produce approximately equal net penetration.

The value of W_p shall not exceed three times W_h .

~~[1809.3.1] 1811.3.1 Capacity as indicated by resistance to penetration.~~ Where subsurface investigation and general experience in the area indicate that the soil that must be penetrated by the ~~[pile] deep foundation~~ consists of glacial deposits containing boulders, or fills containing rip-rap, excavated detritus, masonry, concrete or other obstructions in sufficient numbers to present a hazard to the installation of the ~~[piles] deep foundations~~, the selection of type of ~~[pile] deep foundation~~ and penetration criteria shall be subject to the approval of the commissioner, but in no case shall the minimum penetration resistance be less than that stated in Tables ~~[1809.3(a)] 1811.3(a)~~ and ~~[1809.3(b)] 1811.3(b)~~.

~~[1809.4] 1811.4 Installation of driven [piles] deep foundations.~~ Driven ~~[pile] deep foundations~~ shall be installed in accordance with Section ~~[1808.2.6] 1810.2~~ and Sections ~~[1809.4.1] 1811.4.1~~ through ~~[1809.4.3] 1811.4.3~~.

~~[1809.4.1] 1811.4.1 Driving near fresh concrete.~~ ~~[Piles] Deep foundations~~ shall not be driven adjacent to fresh concrete that is less than 3 days old without approval by the engineer.

~~[1809.4.2] 1811.4.2 Heaved [piles] deep foundations.~~ ~~[Piles] Deep foundations~~ that have heaved during the driving of adjacent ~~[piles] deep foundations~~ shall be redriven as necessary to develop the required capacity and penetration, or the capacity of the ~~[pile] deep foundation~~ shall be verified by load tests in accordance with Section ~~[1808.4] 1810.4~~.

~~[1809.4.3] 1811.4.3 Use of vibratory drivers.~~ Vibratory drivers shall only be used to install ~~[piles] deep foundation elements~~ where the ~~[pile] deep foundation~~ is subsequently seated by an

impact hammer to the final driving criteria established in accordance with Section ~~[1809.3]~~ 1811.3.

~~[1809.5]~~ **1811.5 Timber piles.** Timber piles shall be designed in accordance with the ~~[AF&PA NDS]~~ AWC NDS.

~~[1809.5.1]~~ **1811.5.1 Materials.** Round timber piles shall conform to ASTM D 25. Sawn timber piles shall conform to DOC PS-20.

~~[1809.5.2]~~ **1811.5.2 Preservative treatment.** Timber piles used to support permanent structures shall be treated in accordance with this section unless it is established that the tops of the untreated timber piles will be below the lowest groundwater level assumed to exist during the life of the structure as specified in Section ~~[1808.2.12]~~ 1810.2.12. Preservative and minimum final retention shall be in accordance with AWP A ~~[C3]~~ U1 (Commodity Specification E, Use Category 4C) for round timber piles and AWP A ~~[C24]~~ U1 (Commodity Specification A, Use Category 4B) for sawn timber piles. Preservative-treated timber piles shall be subject to a quality control program administered by an approved agency. ~~[Pile cuts]~~ Cuts to timber piles shall be treated in accordance with AWP A M4.

~~[1809.5.3]~~ **1811.5.3 Defective timber piles.** Any sudden decrease in driving resistance of a timber pile shall be investigated ~~[with regard to the possibility of]~~ for possible damage. If the sudden decrease in driving resistance cannot be correlated to load-bearing data, the timber pile shall be removed for inspection~~[;]~~ or rejected.

~~[1809.5.4]~~ **1811.5.4 Sizes of timber piles.** ~~[Piles]~~ Timber piles shall be of adequate size to resist the applied loads without creating stresses in the timber pile material in excess of 1,200 psi (8.27 MPa) for piles of southern pine, Douglas fir, oak, or other wood of comparable strength; or 800 psi (5.52 MPa) for timber piles of cedar, Norway pine, spruce or other wood of comparable strength. ~~[Piles]~~ Timber piles of 25 tons (222.5 kN) of capacity or more shall have a minimum 8-inch tip (~~[203]~~ 203.2 mm) with uniform taper. ~~[Piles]~~ Timber piles of less than 25 tons (222.5 kN) of capacity shall have a minimum 6-inch (~~[152]~~ 152.4 mm) tip with uniform taper. All timber piles, regardless of capacity, driven to end bearing on bedrock of Classes 1a to 1d and compact gravels and sands of Class 2a shall have a minimum 8-inch (~~[203]~~ 203.2 mm) tip and a uniform taper. Any species of wood may be used for timber piles that conforms to ASTM D 25 and that will stand the driving stresses.

~~[1809.5.5]~~ **1811.5.5 Lagged or inverted timber piles.** The use of lagged or inverted timber piles is permitted. Double lagging shall be adequately connected to the basic timber pile material to transfer the full ~~[pile]~~ load from the basic timber pile material to the lagging without exceeding values of allowable stress as established in Chapter 23. The connection for single lagging shall be proportioned for half the timber pile load. The diameter of any inverted timber pile at any section shall be adequate to resist the applied load without exceeding the stresses specified in Section ~~[1809.5.4]~~ 1811.5.4, but in no case shall it be less than 8 inches (~~[203]~~ 203.2 mm).

~~[1809.6]~~ **1811.6 Precast concrete piles.**

~~[1809.6.1]~~ **1811.6.1 General.** The materials, reinforcement and installation of precast concrete piles shall conform to Sections ~~[1809.6.1.1]~~ 1811.6.1.1 through ~~[1809.6.1.4]~~ 1811.6.1.3.

~~[1809.6.1.1] Design and manufacture.~~ Piles shall be designed and manufactured in accordance with accepted engineering practice to resist all stresses induced by handling, driving and service loads.].

~~[1809.6.1.2]~~ **1811.6.1.1 Minimum dimension.** The minimum horizontal dimension shall be 8 inches (~~[203]~~ 203.2 mm). Corners of square precast concrete piles shall be chamfered.

~~[1809.6.1.3]~~ **1811.6.1.2 Reinforcement.** Longitudinal steel shall be arranged in a symmetrical pattern and be laterally tied with steel ties or wire spiral spaced not more than 4 inches (~~[102]~~ 101.6 mm) apart, center to center, for a distance of 2 feet (~~[610]~~ 609.6 mm) from the ends of the precast concrete pile; and not more than 6 inches (~~[152]~~ 152.4 mm) elsewhere except that at the ends of each precast concrete pile, the first five ties or spirals shall be spaced 1 inch (~~[25]~~ 25.4 mm) center to center. The gage of ties and spirals shall be as follows:

1. For precast concrete piles having a least horizontal dimension of 16 inches (~~[406]~~ 406.4 mm) or less, wire shall not be smaller than 0.22 inch (5.6 mm) (No. 5 gage).
2. For precast concrete piles having a least horizontal dimension of more than 16 inches (~~[406]~~ 406.4 mm) and less than 20 inches (508 mm), wire shall not be smaller than 0.238 inch (6 mm) (No. 4 gage).
3. For precast concrete piles having a least horizontal dimension of 20 inches (508 mm) and larger, wire shall not be smaller than ¼ inch (6.4 mm) round or 0.259 inch (6.6 mm) (No. 3 gage).

~~[1809.6.1.4]~~ **1811.6.1.3 Installation.** ~~[Piles]~~ Precast concrete piles shall be handled and driven so as not to cause injury or overstressing in a manner that affects durability or strength. A precast concrete pile shall not be driven before the concrete has attained a compressive strength of at least 75 percent of the 28-day specified compressive strength (f'_c), and not less than the strength sufficient to withstand handling and driving forces.

~~[1809.6.2]~~ **1811.6.2 Precast nonprestressed concrete piles.** Precast nonprestressed concrete piles shall conform to Sections ~~[1809.6.2.1]~~ 1811.6.2.1 through ~~[1809.6.2.4]~~ 1811.6.2.4.

~~[1809.6.2.1]~~ **1811.6.2.1 Materials.** Concrete shall have a 28-day specified compressive strength (f'_c) of not less than 3,000 psi (20.68 MPa).

~~[1809.6.2.2]~~ **1811.6.2.2 Minimum reinforcement.** The minimum amount of longitudinal reinforcement shall be 0.8 percent of the concrete section and consist of at least four bars.

[1809.6.2.2.1] 1811.6.2.2.1 Seismic reinforcement in Seismic Design Category C. Where a structure is assigned to Seismic Design Category C in accordance with Section 1613, longitudinal reinforcement with a minimum steel ratio of 0.01 shall be provided throughout the length of precast concrete piles. Within ~~three pile diameters~~ a distance equivalent to three times the diameter of the deep foundation element of the bottom of the pile cap, the longitudinal reinforcement shall be confined with closed ties or spirals of a minimum $\frac{3}{8}$ -inch (9.5 mm) diameter. Ties or spirals shall be provided at a maximum spacing of eight times the diameter of the smallest longitudinal bar, not to exceed 6 inches (~~152~~ 152.4 mm). Throughout the remainder of the precast nonprestressed concrete pile, the closed ties or spirals shall have a maximum spacing of 16 times the smallest longitudinal-bar diameter, not to exceed 6 inches (~~152~~ 152.4 mm).

[1809.6.2.2.2] 1811.6.2.2.2 Seismic reinforcement in Seismic Design Category D. Where a structure is assigned to Seismic Design Category D in accordance with Section 1613, the requirements of Seismic Design Category C shall apply, except that transverse reinforcement shall comply with requirements of Section ~~1810.1.2.5~~ 1812.1.2.5.

[1809.6.2.3] 1811.6.2.3 Allowable stresses. For allowable stresses, see Table ~~1808.8~~ 1810.8.

[1809.6.2.4] 1811.6.2.4 Concrete cover. For concrete cover requirements, see Table ~~1808.2.13~~ 1810.2.13.

[1809.6.3] 1811.6.3 Precast prestressed concrete piles. Precast prestressed concrete piles shall conform to the requirements of Sections ~~1809.6.3.1~~ 1811.6.3.1 through ~~1809.6.3.4~~ 1811.6.3.4.

[1809.6.3.1] 1811.6.3.1 Materials. Prestressing steel shall conform to ASTM A 416. Concrete shall have a 28-day specified compressive strength (f'_c) of not less than 5,000 psi (34.48 MPa).

[1809.6.3.2] 1811.6.3.2 Design. Precast prestressed concrete piles shall be designed to resist stresses induced by handling and driving as well as by loads. The effective prestress ~~in the pile~~ shall not be less than 400 psi (2.76 MPa) for precast prestressed concrete piles less than 30 feet (9144 mm) in length, 550 psi (3.79 MPa) for precast prestressed concrete piles between 30 and 50 feet (9144 mm and 15 240 mm) in length and 700 psi (4.83 MPa) for precast prestressed concrete piles greater than 50 feet (15 240 mm) in length. Effective prestress shall be based on an assumed loss of 30,000 psi (207 MPa) in the prestressing steel. The tensile stress in the prestressing steel shall not exceed the values specified in ACI 318.

[1809.6.3.2.1] 1811.6.3.2.1 Design in Seismic Design Category C. Where a structure is assigned to Seismic Design Category C in accordance with Section 1613, precast prestressed concrete piles shall have transverse reinforcement in accordance with this section. The minimum volumetric ratio of spiral reinforcement shall not be less than the amount required by the following formula for the upper 20 feet (6096 mm) of the precast prestressed concrete pile.

$$[\rho_s = 0.12 \frac{f'_c}{f_{yh}} \frac{f'_t}{\epsilon}]$$

$$\rho_s = 0.04 \left(\frac{f'_c}{f_{yh}} \right) \left(2.8 + 2.34 \left(\frac{P}{f'_c A_g} \right) \right) \quad [(\text{Equation 18-4})] \quad (\text{Equation 18-1})$$

where:

A_g = Pile cross-sectional area square inches (mm^2).

f'_c = Specified compressive strength of concrete, psi (MPa).

f_{yh} = Yield strength of spiral reinforcement $\leq 85,000$ psi (586 MPa).

P = Axial load on pile, pounds (kN), as determined from Equations 16-5 and 16-7.

ρ_s = Spiral reinforcement index (vol. spiral/vol. core).

[At least] Not less than one-half the volumetric ratio required by Equation [18-4] 18-1 shall be provided below the upper 20 feet (6096 mm) of the pile.

[The pile cap connection by means of dowels as indicated in Section 1808.9 is permitted. Pile cap connection by means of developing pile reinforcing strand is permitted provided that the pile reinforcing strand results in a ductile connection.]

Exception: The minimum spiral reinforcement index required by Equation 18-1 shall not apply in cases where the design includes full consideration of load combinations specified in ASCE 7, Section 2.3.6 and the applicable overstrength factor, Ω_0 . In such cases, minimum spiral reinforcement index shall be as specified in Section 1811.6.1.2 of this code.

~~[1809.6.3.2.2]~~ **1811.6.3.2.2 Design in Seismic Design Category D.** Where a structure is assigned to Seismic Design Category D in accordance with Section ~~[1613.5.6]~~ 1613.3.5, the requirements for Seismic Design Category C in Section ~~[1809.6.3.2.1]~~ 1811.6.3.2.1 shall be met, in addition to the following:

1. Requirements in ACI 318, Chapter ~~[24]~~ 18, do not apply, unless specifically referenced.
2. Where the total ~~[pile]~~ length of the deep foundation in the soil is 35 feet (10 668 mm) or less, the lateral transverse reinforcement in the ductile region shall occur through the length of the precast prestressed concrete pile. Where the precast prestressed concrete pile length exceeds 35 feet (10 668 mm), the ductile ~~[pile]~~ region of the deep foundation shall be taken as the greater of 35 feet (10 668 mm) or the distance from the underside of the pile cap to the point of zero curvature plus three times the least ~~[pile]~~ dimension of the precast prestressed concrete pile.
3. In the ductile region, the center-to-center spacing of the spirals or hoop reinforcement shall not exceed one-fifth of the least ~~[pile]~~ dimension of the deep foundation element, six times the diameter of the longitudinal strand[, or 8 inches (~~[203]~~ 203.2 mm), whichever is smaller.

4. Circular spiral reinforcement shall be spliced by lapping one full turn and bending the end of the spiral to a 90-degree (1.6-rad) hook or by use of a mechanical or welded splice complying with Section 25.5.7 of ACI 318.
5. Where the transverse reinforcement consists of circular spirals, the volumetric ratio of spiral transverse reinforcement in the ductile region shall comply with the following:

$$\rho_s = 0.25 \left(\frac{f'_c}{f_{yh}} \right) \left(\frac{A_g}{A_{ch=1.0}} \right) \quad \text{[(Equation 18-5)]}$$

$$\left[\left(0.5 + \left(\frac{1.4P}{f'_c A_g} \right) \right) \right]$$

[but not less than:]

$$\rho_s = 0.06 \left(\frac{f'_c}{f_{yh}} \right) \left(2.8 + 2.34 \left(\frac{P}{f'_c A_g} \right) \right) \quad \text{[(Equation 18-2)]}$$

$$\rho_s = 0.12 \left(\frac{f'_c}{f_{yh}} \right) \left(0.5 + \left(\frac{1.4P}{f'_c A_g} \right) \right) \quad \text{[(Equation 18-6)]}$$

$$[\geq 0.12 f'_c / f_{yh}]$$

[and need] but not exceed:

$$\rho_s = 0.021 \quad \text{[(Equation 18-7)] [(Equation 18-3)]}$$

where:

A_g = Pile cross-sectional area, square inches (mm²).

~~A_{ch} = Core area defined by spiral outside diameter, square inches (mm²).~~

f'_c = Specified compressive strength of concrete, psi (MPa)

f_{yh} = Yield strength of spiral reinforcement \leq 85,000 psi (586 MPa).

P = Axial load on pile, pounds (kN), as determined from Equations 16-5 and 16-7.

ρ_s = Volumetric ratio (vol. spiral/ vol. core).

This required amount of spiral reinforcement is permitted to be obtained by providing an inner and outer spiral.

Exception: The minimum spiral reinforcement required by Equation 18-2 shall not apply in cases where the design includes full consideration of load combinations specified in ASCE 7, Section 2.3.6 and the applicable overstrength factor, Ω_0 . In such cases, minimum spiral reinforcement index shall be as specified in Section 1811.6.1.2.

6. When transverse reinforcement consists of rectangular hoops and cross ties, the total cross-sectional area of lateral transverse reinforcement in the ductile region with ~~spacings~~ spacing, s , and perpendicular to dimension, h_c , shall conform to:

$$A_{sh} = 0.3s h_c \left(\frac{f'_c}{f_{yh}} \right) \left(\frac{A_g}{A_{ch}} - 1.0 \right) \left(0.5 + \frac{1.4P}{f'_c A_g} \right) \quad \text{[(Equation 18-8)] (Equation 18-4)}$$

but not less than:

$$A_{sh} = 0.12s h_c \left(\frac{f'_c}{f_{yh}} \right) \left(0.5 + \frac{1.4P}{f'_c A_g} \right) \quad \text{[(Equation 18-9)] (Equation 18-5)}$$

where:

f_{yh} = Yield strength of transverse reinforcement ≤ 70,000 psi (483 MPa).

h_c = Cross-sectional dimension of pile core measured center to center of hoop reinforcement, inch (mm).

s = Spacing of transverse reinforcement measured along length of pile, inch (mm).

A_{sh} = Cross-sectional area of transverse reinforcement, square inches (mm²).

f'_c = Specified compressive strength of concrete, psi (MPa).

The hoops and cross ties shall be equivalent to deformed bars not less than No. 3 in size. Rectangular hoop ends shall terminate at a corner with seismic hooks.

Outside of the length of the pile requiring transverse confinement reinforcing, the spiral or hoop reinforcing with a volumetric ratio not less than one-half of that required for transverse confinement reinforcing shall be provided.

[1809.6.3.3] 1811.6.3.3 Allowable stresses. For allowable stresses, see Table [1808.8] 1810.8.

[1809.6.3.4] 1811.6.3.4 Concrete cover. For concrete cover requirements, see Table [1808.2.13] 1810.2.13.

[1809.7] 1811.7 Structural steel piles. Structural steel piles shall conform to the requirements of Sections [1809.7.1] 1811.7.1 through [1809.7.4] 1811.7.6.

[1809.7.1] 1811.7.1 Materials. Structural steel [~~piles, steel pipe and fully welded~~] H-piles and structural steel sheet piling shall conform to the material requirements in ASTM A6. Steel pipe piles shall conform to the material requirements in ASTM A252. Welded built-up steel piles shall be fabricated from plates [shall] that conform to the material requirements in ASTM A 36, [ASTM A 252,] ASTM A283, ASTM A572, ASTM A588[~~], or ASTM A690 [ASTM A 913 or ASTM A 992].~~

1811.7.1.1 Structural steel pipe piles to be welded. Structural steel pipe piles to be fabricated or spliced by welding shall be subject to qualification requirements of AWS D1.1 for unlisted base metals. Structural steel pipe piles to be welded shall have a carbon equivalency (CE) not exceeding 0.45 as defined by AWS D1.1 and a sulfur content not exceeding 0.05%. Carbon equivalency and sulfur content shall be determined by mill certificates or by chemical analysis, for a minimum of two samples per 1,000 linear feet (304 800 mm) of pipe or part thereof, where mill certificates are unavailable.

1811.7.1.2 High strength pipe. High strength pipe meeting the strength requirements of API 5L (N80) and API 5CT (N80) shall be permitted for use as structural steel pipe piles. All such pipe and casing shall meet the minimum tensile requirements of ASTM A252, Grade 3 with a minimum elongation of 15 percent, except that the yield strength shall be a minimum of 80 ksi (551.6 MPa). The following requirements shall also apply:

1. Mill certificates shall be provided.
2. Where mill certificates are not available, a minimum of two coupon tests per 1,000 linear feet (304 800 mm) of pipe or part thereof shall be performed. Testing procedures shall meet the requirements set forth in Section 18 of ASTM A252.
3. Welding shall be in accordance with Section 1811.7.1.1. In addition, welded seams and splices shall be complete joint penetration welds. Reinforcing steel shall not be welded to high strength pipe.

~~[1809.7.2]~~ **1811.7.2 Allowable stresses.** For the allowable stresses for materials used in structural steel piles see Table ~~[1808.8]~~ 1810.8.

~~[1809.7.3]~~ **1811.7.3 Dimensions of Structural Steel H-piles.** Sections of structural steel H-piles shall comply with the requirements for HP shapes in ASTM A6 or the following:

1. The flange projections shall not exceed 14 times the minimum thickness of metal in either the flange or the web and the flange widths shall not be less than 80 percent of the depth of the section.
2. The nominal depth in the direction of the web shall not be less than 8 inches (~~[203]~~ 203.2 mm).
3. Flanges and web shall have a minimum nominal thickness of $\frac{3}{8}$ inch (9.5 mm).

~~[1809.7.4]~~ **1811.7.4 Dimensions of structural steel pipe piles.** ~~[Steel]~~ Structural steel pipe piles driven open ended shall have a nominal outside diameter of not less than 8 inches (~~[203]~~ 203.2 mm). The pipe shall have a minimum of 0.34 square ~~inch~~ inches (~~[219]~~ 219.4 mm²) of steel in cross section to resist each 1,000 foot-pounds (1356 N×m) of ~~[pile hammer]~~ energy from the hammer used to install deep foundation elements or the equivalent strength for steels having a yield strength greater than 35,000 psi (~~[241]~~ 241.3 MPa), or the wave equation analysis shall be permitted to be used to assess compression stresses induced by driving to evaluate if the structural steel pipe pile section is appropriate for the selected hammer. Where pipe wall thickness less than 0.188 inch (4.8 mm) is driven open ended, a suitable cutting shoe shall be provided.

1811.7.5 Built-up structural steel piles fabricated from plates. Built-up sections of steel piles fabricated from welded plates shall comply with the following:

1. The flange projections shall not exceed 14 times the minimum thickness of metal in either the flange or the web and the flange widths shall not be less than 80 percent of the depth of the section.
2. The nominal depth in the direction of the web shall not be less than 8 inches (203.2 mm).
3. Flanges and web shall have a minimum nominal thickness of 3/8 inch (9.5 mm).

1811.7.6 Structural steel sheet piling. Individual sections of structural steel sheet piling shall conform to the profile indicated by the manufacturer, and shall conform to the general requirements specified by ASTM A6.

SECTION BC ~~[1810]~~ 1812 CAST-IN-PLACE CONCRETE PILES

[1810.1] 1812.1 General. The materials, reinforcement and installation of cast-in-place concrete piles shall conform to Sections ~~[1810.1.1]~~ 1812.1.1 through ~~[1810.1.3]~~ 1812.1.3.

[1810.1.1] 1812.1.1 Materials. Concrete or grout shall have a 28-day specified compressive strength (f'_c) of not less than 2,500 psi (17.24 MPa), except in micropiles and caisson piles where the minimum compressive strength shall be 4,000 psi [~~(27 580 kPa)~~] (27.58 MPa). Where concrete is placed through a funnel hopper at the top of the cast-in-place concrete pile, the concrete mix shall be designed and proportioned so as to produce a cohesive workable mix having a slump of not less than 4 inches (~~[102]~~ 101.6 mm) and not more than 6 inches (~~[152]~~ 152.4 mm). Where concrete ~~[or grout]~~ is to be pumped, the mix design shall be such that material produced is suitable for pumping.

Grout shall consist of a pumpable mixture of portland cement, water, and any required fine aggregate, supplemental cementitious materials, or admixtures as permitted by Chapter 19 of this code. Grout proportioning shall be determined from trial mixes or on the basis of field experience using documented test results provided that such test results are not older than 24 months. The water to cement ratio of grout shall not exceed 0.45. The required average compressive strength of grout shall be determined in a manner consistent with the procedures outlined in ACI 301 as utilized for concrete. The evaluation of grout compressive strength shall be in accordance with procedures established for concrete in Chapter 19 of this code. All grout mix design shall be submitted for review and approval of the registered design professional of record. Copies of the grout mix design shall be submitted to the department.

1812.1.1.1 Concrete sampling and testing. Sampling and testing of concrete shall be in accordance with Chapter 19.

1812.1.1.2 Grout sampling and testing. Sampling and testing of grout shall be in accordance with Sections 1812.1.1.2.1 through 1812.1.1.2.3.

1812.1.1.2.1 Interval. Grout samples shall be collected and testing shall be performed for the lesser of the following conditions:

1. each element installed;
2. each batch of site-mixed grout; or
3. each load of ready-mixed grout used.

1812.1.1.2.2 Compressive strength. Compressive strength tests shall be performed using cylinders having a maximum diameter of 3 inches (72.3 mm). Grout shall be tested in accordance with ASTM C39. A minimum of six (6) samples shall be prepared for each test group.

1812.1.1.2.3 Specific gravity. Specific gravity testing shall be performed using the American Petroleum Institute (API) Recommended Practice 13B-1 or in accordance with ASTM C138.

[1810.1.2] 1812.1.2 Placement of reinforcement. Reinforcement, where required, shall be placed in accordance with Section ~~[1810.3.4]~~ 1812.3.4 and shall be assembled, tied together, and placed in the cast-in-place concrete pile as a unit before concrete or grout is placed.

Exceptions: Where approved by the engineer, reinforcement may be placed after the cast-in-place concrete piles are filled with concrete or grout under the following situations:

1. Tied reinforcement in augered uncased cast-in-place concrete piles, while the concrete or grout is still in a semifluid state.
2. Tied reinforcement in cast-in-place concrete piles filled with grout, while the grout is in a semifluid state.
3. Steel dowels embedded 5 feet (1524 mm) or less in the cast-in-place concrete pile while the concrete or grout is still in a semifluid state.

[1810.1.2.1] 1812.1.2.1 Design cracking moment. The design cracking moment (ϕM_n) for a cast-in-place deep foundation element not enclosed by a structural steel pipe or tube shall be determined using the following equation:

$$\phi M_n = 3\sqrt{f'_c x S_m} \qquad \text{[(~~Equation 18-11~~)] (Equation 18-6)}$$

For SI: $\phi M_n = 0.25\sqrt{f'_c x S_m}$

where:

f'_c = Specified compressive strength of concrete or grout, psi

S_m = Elastic section modulus, neglecting reinforcement and casing, cubic inches

[1810.1.2.2] 1812.1.2.2 Required reinforcement. Where subject to uplift, or where the required moment strength determined using the load combinations of Section 1605.2 exceeds the design cracking moment determined in accordance with Section ~~[1810.1.2.1]~~ 1812.1.2.1, cast-in-place concrete piles not enclosed by a structural steel pipe or tube shall be reinforced.

[1810.1.2.3] 1812.1.2.3 Reinforcement in Seismic Design Categories C & D. Where a structure is assigned to Seismic Design Category C in accordance with Section 1613, reinforcement shall be provided in accordance with Section ~~[1810.1.2.4]~~ 1812.1.2.4. Where a structure is assigned to Seismic Design Category D, reinforcement shall be provided in accordance with Section ~~[1810.1.2.5]~~ 1812.1.2.5.

[1810.1.2.4] 1812.1.2.4 Seismic reinforcement in Seismic Design Category C. For structures assigned to Seismic Design Category C in accordance with Section 1613, cast-in-place ~~[deep foundation]~~ concrete pile elements shall be reinforced as specified in this section. Reinforcement shall be provided where required by analysis. A minimum of four longitudinal bars, with a minimum longitudinal reinforcement ratio of 0.0025, shall be provided throughout the minimum reinforced length of the element as defined below starting at the top of the element. The minimum reinforced length of the element shall be the greatest of the following:

1. One-third of the element length;
2. A distance of 10 feet (3048 mm);
3. Three times the least element dimension; or
4. The distance from the top of the element to the point where the design cracking moment determined in accordance with Section ~~[1810.1.2.1]~~ 1812.1.2.1 exceeds the required moment strength determined using the load combinations of Section 1605.2.

Transverse reinforcement shall consist of closed ties or spirals with a minimum diameter of $\frac{3}{8}$ inch (9.5 mm). Spacing of transverse reinforcement shall not exceed the smaller of 6 inches (~~[152]~~ 152.4 mm) or 8-longitudinal-bar diameters, within a distance of three times the least element dimension from the bottom of the pile cap. Spacing of transverse reinforcement shall not exceed 16 longitudinal bar diameters throughout the remainder of the reinforced length.

Exceptions:

1. The requirements of this section shall not apply to concrete cast in structural steel pipes or tubes.
2. A spiral-welded metal casing of a thickness not less than manufacturer's standard No. 14 gage (0.068 inch) (1.73 mm) is permitted to provide concrete confinement in lieu of the closed ties or spirals. Where used as such, the metal casing shall be protected against possible deleterious action due to soil constituents, changing water levels or other factors indicated by boring records of site conditions.

[1810.1.2.5] 1812.1.2.5 Seismic reinforcement in Seismic Design Category D. For structures assigned to Seismic Design Category D in accordance with Section 1613, cast-in-place ~~[deep foundation]~~ concrete pile elements shall be reinforced as specified in this section. Reinforcement shall be provided where required by analysis. A minimum of four longitudinal

bars, with a minimum longitudinal reinforcement ratio of 0.005, shall be provided throughout the minimum reinforced length of the element as defined below starting at the top of the element.

The minimum reinforced length of the element shall be the greatest of the following:

1. One-half of the element length;
2. A distance of 10 feet (3048 mm);
3. Three times the least element dimension; or
4. The distance from the top of the element to the point where the design cracking moment determined in accordance with Section [~~1810.3.9.1~~] 1812.1.2.1 exceeds the required moment strength determined using the load combinations of Section 1605.2.

Transverse reinforcement shall consist of closed ties or spirals no smaller than No. 3 bars for elements with a least dimension of up to 20 inches (508 mm), and No. 4 bars for larger elements. Throughout the remainder of the reinforced length outside the regions with transverse confinement reinforcement, as specified in Section [~~1810.1.2.5.1~~] 1812.1.2.5.1 or [~~1810.1.2.5.2~~] 1812.1.2.5.2, the spacing of transverse reinforcement shall not exceed the least of the following:

1. 12 longitudinal bar diameters;
2. One-half the least dimension of the element; or
3. 12 inches (~~[305]~~ 304.8 mm).

Exceptions:

1. The requirements of this section shall not apply to concrete cast in structural steel pipes or tubes.
2. A spiral-welded metal casing of a thickness not less than manufacturer's standard [~~gage~~] No. 14 gage (0.068 inch) (1.73 mm) is permitted to provide concrete confinement in lieu of the closed ties or spirals. Where used as such, the metal casing shall be protected against possible deleterious action due to soil constituents, changing water levels or other factors indicated by boring records of site conditions.

[~~1810.1.2.5.1~~] 1812.1.2.5.1 Site Classes A through D. For Site Class A, B, C and D, transverse confinement reinforcement shall be provided in the element in accordance with Sections [~~21.6.4.2~~] 18.7.5.2, through [~~21.6.4.4~~] 18.7.5.4 of ACI 318 within three times the least element dimension of the bottom of the pile cap. A transverse spiral reinforcement ratio of not less than one-half of that required in Section [~~21.6.4.4(a)~~] 18.7.5.4(a) of ACI 318 shall be permitted.

[1810.1.2.5.2] 1812.1.2.5.2 Site Classes E and F. For Site Class E or F, transverse confinement reinforcement shall be provided in the element in accordance with Sections ~~[21.6.4.2]~~ 18.7.5.2 through ~~[21.6.4.4]~~ 18.7.5.4 of ACI 318 within seven times the least element dimension of the pile cap and within seven times the least element dimension of the interfaces of strata of Class 4b or better and strata that are liquefiable or are composed of material meeting Class 4c or 6.

[1810.1.3] 1812.1.3 Concrete or grout placement. Concrete or grout shall be placed in such a manner as to ensure the exclusion of any foreign matter and to secure a full-sized shaft. Concrete or grout shall not be placed through water except where a tremie or other approved method is used. When depositing concrete from the top of the cast-in-place concrete pile, the concrete shall not be chuted directly into the cast-in-place concrete pile but shall be poured in a rapid and continuous operation through a funnel hopper centered at the top of the cast-in-place concrete pile. Grout for auger cast piles shall be pumped through a hollow stem auger and shall be maintained as fluid throughout placement.

[1810.2] 1812.2 Enlarged base piles. Enlarged base piles shall conform to the requirements of Sections ~~[1810.2.1]~~ 1812.2.1 through ~~[1810.2.5]~~ 1812.2.5.

[1810.2.1] 1812.2.1 Materials. The maximum size of coarse aggregate for concrete shall be $\frac{3}{4}$ inch (19.1 mm). Concrete to be compacted shall have a zero slump.

[1810.2.2] 1812.2.2 Allowable stresses. For allowable stresses, see Table ~~[1808.8]~~ 1810.8.

[1810.2.3] 1812.2.3 Installation. Enlarged bases formed either by compacting concrete or driving a precast base shall be formed in or driven into granular soils. ~~[Piles]~~ Enlarged base piles shall be constructed in the same manner as successful ~~[prototype test piles driven]~~ enlarged base test piles installed for the project. ~~[Pile]~~ Enlarged base pile shafts extending through peat or other organic soil shall be encased in a permanent steel casing. Where a cased shaft is used, the shaft shall be adequately reinforced to resist column action or the annular space around the enlarged base pile shaft shall be filled sufficiently to re-establish lateral support by the soil. Where ~~[pile]~~ heave of an enlarged base pile or other deep foundation occurs, the enlarged base pile or other deep foundation, shall be replaced unless it is demonstrated that the enlarged base pile or other deep foundation is undamaged and capable of carrying twice its design load.

[1810.2.4] 1812.2.4 Load-bearing capacity. ~~[Pile]~~ The load-bearing capacity of enlarged base piles shall be verified by load tests in accordance with Section ~~[1808.4]~~ 1810.4.

[1810.2.5] 1812.2.5 Concrete and grout cover. For minimum concrete and grout cover requirements, see Table ~~[1802.13]~~ 1803.13.

[1810.3] 1812.3 Drilled, drilled displacement, or augered uncased piles. Drilled, drilled displacement, or augered uncased piles shall conform to Sections ~~[1810.3.1]~~ 1812.3.1 through ~~[1810.3.5]~~ 1812.3.5.

[1810.3.1] 1812.3.1 Allowable stresses. For allowable stresses, see Table ~~[1808.8]~~ 1810.8.

[1810.3.2] 1812.3.2 Dimensions. The minimum diameter of drilled or drilled displacement piles shall be 8 inches (203.2 mm). The minimum diameter of augered uncased piles shall be 12 inches (~~[305]~~ 304.8 mm).

[1810.3.3] 1812.3.3 Installation. Where [~~pile~~] shafts for drilled piles are formed through unstable soils and concrete is placed in an open-drilled hole, a steel liner shall be inserted in the hole prior to placing the concrete. Where the steel liner is withdrawn during concreting, the level of concrete shall be maintained above the bottom of the liner at a sufficient height to offset any hydrostatic or lateral soil pressure.

Where drilled displacement piles are used, the auger segments shall be installed into the ground with both a vertical force and a torque such that the soil is displaced laterally within the ground. The void created after installation shall be filled with grout or concrete.

Where grout is placed by pumping through a hollow-stem auger, the auger shall be permitted to rotate in a clockwise direction during withdrawal. An initial head of grout shall be established and maintained on the auger flights before withdrawal. The auger shall be withdrawn in a continuous manner in increments of about 12 inches (~~[305]~~ 304.8 mm) each. Grout pumping pressures shall be measured and maintained high enough at all times to offset hydrostatic and lateral earth pressures. Grout volumes shall be measured to ensure that the volume of grout placed in each drilled pile is equal to or greater than the theoretical volume of the hole created by the auger. Where the installation process of any drilled pile is interrupted or a loss of grout pressure occurs, the drilled pile shall be re-drilled to 5 feet (1524 mm) below the elevation of the tip of the auger when the installation was interrupted or grout pressure was lost and reformed.

Augered cast-in-place piles shall not be installed within [~~six pile diameters center to center of a~~] a distance equivalent to the center-to-center spacing equivalent to six times the diameter of a drilled pile filled with concrete or grout less than 12 hours old, unless approved by the engineer. The level at which return of the grout occurs during withdrawal shall be recorded. If the grout level in any completed drilled pile drops during installation of an adjacent drilled pile, the drilled pile shall be replaced. The installation shall be performed under the direct supervision of the engineer. The engineer shall certify to the commissioner that the drilled piles were installed in compliance with the approved construction documents.

[1810.3.4] 1812.3.4 Reinforcement. For drilled piles installed with a hollow-stem auger, where full-length longitudinal steel reinforcement is placed without lateral ties, the reinforcement shall be placed through ducts in the auger prior to filling the drilled pile with concrete. Concrete cover for [~~pile~~] reinforcement of the drilled pile shall be in accordance with Table [~~1808.2.13~~] 1810.2.13.

Exception: Where physical constraints do not allow the placement of the longitudinal reinforcement prior to filling the drilled pile with concrete or where partial-length longitudinal reinforcement is placed without lateral ties, the reinforcement is allowed to be placed after the drilled piles are completely concreted but while concrete is still in a semifluid state.

[1810.3.5] 1812.3.5 Reinforcement in Seismic Design Category C or D. Where a structure is assigned to Seismic Design Category C or D in accordance with Section 1613, the corresponding requirements of Sections ~~[1810.1.2.3]~~ 1812.1.2.3 through ~~[1810.1.2.5]~~ 1812.1.2.5 shall be met.

[1810.4] 1812.4 Driven uncased piles. Driven uncased piles shall not be permitted.

[1810.5] 1812.5 Steel-cased piles. Steel-cased piles shall comply with the requirements of Sections ~~[1810.5.1]~~ 1812.5.1 through ~~[1810.5.4]~~ 1812.5.4.

[1810.5.1] 1812.5.1 Materials. ~~[Pile shells]~~ Shells or casings for steel cased piles shall be of steel and be sufficiently strong to resist collapse and sufficiently water tight to exclude any foreign materials during the placing of concrete. Steel shells shall have a sealed tip with a diameter of not less than 8 inches (~~[203]~~ 203.2 mm).

[1810.5.2] 1812.5.2 Allowable stresses. For allowable stresses, see Table ~~[1808.8]~~ 1810.8.

[1810.5.2.1] 1812.5.2.1 Shell thickness. The thickness of the steel shell shall not be less than manufacturer's standard No. 14 gage (0.068 inch) (1.75 mm) minimum.

[1810.5.2.2] 1812.5.2.2 Shell type. The shell shall be seamless or provided with seams of strength equal to the basic material and be of a configuration that will provide confinement to the cast-in-place concrete.

[1810.5.2.3] 1812.5.2.3 Strength. The ratio of steel yield strength (f_y) to 28-day specified compressive strength (f'_c) shall not be less than six.

[1810.5.2.4] 1812.5.2.4 Diameter. The nominal ~~[pile]~~ diameter of steel cased piles shall not be greater than 16 inches (~~[406]~~ 406.4 mm).

[1810.5.3] 1812.5.3 Installation. Steel shells shall be mandrel driven for their full length in contact with the surrounding soil. The steel shells shall be driven in such order and with such pacing as to ensure against distortion of or injury to steel cased piles already in place. A steel cased pile shall not be driven within four and one-half average ~~[pile]~~ diameters of a steel cased pile filled with concrete less than 24 hours old unless approved by the commissioner. Concrete shall not be placed in steel shells within heave range of driving.

[1810.5.4] 1812.5.4 Reinforcement. Reinforcing shall be required for unsupported ~~[pile]~~ lengths of steel cased piles or where the steel cased pile is designed to resist uplift or unbalanced lateral loads. For minimum concrete cover requirements, see Table ~~[1808.2.13]~~ 1810.2.13.

[1810.5.4.1] 1812.5.4.1 Seismic reinforcement. Where a structure is assigned to Seismic Design Category C or D in accordance with Section 1613, the reinforcement requirements of Sections ~~[1810.1.2.3]~~ 1812.1.2.3 through ~~[1810.2.5]~~ 1812.1.2.5 shall be met.

[1810.6] 1812.6 Concrete-filled steel pipe and tube piles. Concrete-filled steel pipe and tube piles shall conform to the requirements of Sections ~~[1810.6.1]~~ 1812.6.1 through ~~[1810.6.5]~~ 1812.6.5.

[1810.6.1] 1812.6.1 Materials. Steel pipe and tube sections used for concrete-filled steel pipe and tube piles shall conform to ASTM A252 or ASTM A283. Concrete shall conform to Section ~~[1810.1.1]~~ 1812.1.1. The maximum coarse aggregate size shall be ¾ inch (19.1 mm).

[1810.6.2] 1812.6.2 Allowable stresses. For allowable stresses, see Table ~~[1808.8]~~ 1810.8.

[1810.6.3] 1812.6.3 Minimum dimensions. ~~[Piles]~~ Concrete-filled steel pipe and tube piles shall have a nominal outside diameter of not less than 8 inches (~~[203]~~ 203.2 mm) and a minimum wall thickness in accordance with Section ~~[1809.3.4]~~ 1811.7.4. For ~~[mandrel driven pipe piles]~~ concrete-filled steel pipe and tube piles driven with a mandrel, the minimum wall thickness shall be 1/10 inch (2.5 mm).

[1810.6.4] 1812.6.4 Reinforcement. Reinforcement steel shall conform to Section ~~[1810.1.2]~~ 1812.1.2. For minimum concrete cover requirements see Table ~~[1808.2.13]~~ 1810.2.13.

[1810.6.4.1] 1812.6.4.1 Seismic reinforcement. Where a structure is assigned to Seismic Design Category C or D in accordance with Section 1613, minimum reinforcement no less than 0.01 times the cross-sectional area of the ~~[pile]~~ concrete within the concrete-filled steel pipe and tube piles shall be provided in the top of the ~~[pile]~~ concrete-filled steel pipe and tube piles with an embedment length equal to two times the required cap embedment anchorage into the pile cap, but not less than the tension development length of the reinforcement. The wall thickness of the steel pipe shall not be less than ³/₁₆ inch (~~[5]~~ 4.8 mm).

[1810.6.5] 1812.6.5 Placing concrete. The placement of concrete shall conform to Section ~~[1810.1.3]~~ 1812.1.3.

[1810.7] 1812.7 Caisson piles. Caisson piles shall conform to the requirements of Sections ~~[1810.7.1]~~ 1812.7.1 through ~~[1810.7.7]~~ 1812.7.7.

[1810.7.1] 1812.7.1 Construction. Caisson piles shall consist of a shaft section of concrete or grout-filled pipe, extending to bedrock, with an uncased socket drilled into bedrock of Class 1c or better and filled with concrete or grout. The caisson pile shall have a full-length structural steel core, full length steel reinforcing, or a stub core or steel reinforcing installed in the rock socket and extending into the pipe portion a distance equal to the socket depth. The minimum outside diameter of the caisson pile shall be 7 inches (~~[194]~~ 177.8 mm), and the diameter of the rock socket shall be approximately equal to the inside diameter of the caisson pile.

1812.7.1.1 Drilling with air. Where existing structures may be affected by subsurface disturbances, air drilling shall be prohibited.

[1810.7.2] 1812.7.2 Materials. Pipe and steel cores for caisson piles shall conform to the material requirements in Section ~~[1809.3]~~ 1811.7. Pipes shall have a minimum wall thickness of ⅜ inch (9.5 mm) and shall be fitted with a suitable steel-driving shoe or cutting teeth welded to the bottom

of the pipe. Concrete or grout shall have a 28-day specified compressive strength (f'_c) of not less than 4,000 psi (27.58 MPa).

[1810.7.2.1] 1812.7.2.1 Reinforcing bars. For the purposes of Section [1810.7] 1812.7, threaded bars conforming to ASTM A615 and ASTM A722 shall be considered the same as deformed reinforcing bars.

[1810.7.3] 1812.7.3 Rock socket design. The depth of the rock socket in Class 1c rock or better shall be sufficient to develop the full load-bearing capacity of the caisson pile based upon the sum of the allowable bearing pressure on the bottom of the socket in accordance with Table [1804.1] 1806.1 plus an allowable bond stress of 200 psi (1379 kPa) on the sides of the socket. The depth of the socket in Class 1c rock or better below the bottom of the pipe shall not be less than 3 feet ([914] 914.4 mm) [øf] or the outside diameter of the pipe.

[1810.7.3.1] 1812.7.3.1 Increased allowable bond stress. Load tests, with instrumentation in the rock socket to demonstrate the transfer of force to the rock, shall be performed to justify the use of bond stresses above 200 psi (1379 kPa). [~~The number of load tests shall be in accordance with the requirements of Section 1808.4.1.1.~~] A minimum factor of safety of 2 shall be applied to the ultimate test load where an increase in allowable bond stress is sought. A report summarizing the methods and results of the load test shall be submitted to the commissioner for approval.

1812.7.3.2 Minimum number of load tests. In each area of the foundation site within which the subsurface soil and rock conditions are “substantially similar” in character, as determined by the engineer, at least one load test shall be performed for the largest caisson pile diameter used on a site occupying a total area of 80,000 square feet (7432.2 m²) or less. For sites greater than 80,000 square feet (7432.2 m²), an additional load test shall be performed for every 80,000 square feet (7432.2 m²) of added footprint area.

[1810.7.4] 1812.7.4 Structural core and steel reinforcing. The gross cross-sectional area of the structural steel core or bundled center reinforcing shall not exceed 30 percent of the gross area of the caisson pile. For reinforcing placed at the perimeter of the caisson pile, the area of the reinforcing shall not exceed 8 percent of the area inside the casing. Minimum concrete cover shall be in accordance with Table [1808.2.13] 1810.2.13.

[1810.7.4.1] 1812.7.4.1 Splicing of steel reinforcing. Steel reinforcing shall be spliced in accordance with the requirements of ACI 318.

[1810.7.4.2] 1812.7.4.2 Seismic reinforcement. Where a structure is assigned to Seismic Design Category C or D in accordance with Section 1613, the reinforcement requirements of Section [1810.6.4.1] 1812.6.4.1 shall be met.

[1810.7.5] 1812.7.5 Allowable stresses. For allowable stresses, see Table [1808.8] 1810.8.

~~[1810.7.6]~~ **1812.7.6 Installation.** The rock socket and ~~[pile]~~ steel pipe shall be thoroughly cleaned of foreign materials before filling with concrete or grout. Steel cores shall be set within 6 inches (~~[125]~~ 152.4 mm) above the base of the rock socket. Concrete shall not be placed through water except where a tremie or other method approved by the commissioner is used.

1812.7.6.1 Drilling with air. Where existing structures may be affected by subsurface disturbances, air drilling shall be prohibited.

~~[1810.7.7]~~ **1812.7.7 Rock socket inspection.** Caisson pile rock sockets shall be subject to special inspection in accordance with Section ~~[1704.9]~~ 1705.19. All caisson pile rock sockets shall be inspected to verify rock quality. Inspection may be accomplished by direct observation, by video methods or by a core boring performed prior to the drilling of the socket.

~~[1810.8]~~ **1812.8 Micropiles.** Micropiles shall conform to Sections ~~[1810.8.1]~~ 1812.8.1 through ~~[1810.8.6]~~ 1812.8.6.

~~[1810.8.1]~~ **1812.8.1 Materials.** Reinforcement shall consist of deformed reinforcing bars in accordance with ASTM A615 Grade 60 or 75 or ASTM A722 Grade 150. The steel pipe or casing shall have a minimum yield strength of 45,000 psi (~~[340]~~ 310.3 MPa) and a minimum elongation of 15 percent as shown by mill certifications or two coupon test samples per 40,000 pounds (~~[18460]~~ 18 143.7 kg) of pipe or casing.

~~[1810.8.2]~~ **1812.8.2 Dimensions.** Micropiles shall have an outside diameter of between 5 and 14 inches (127 and ~~[356]~~ 355.6 mm). ~~[The minimum diameter set forth elsewhere in Section 1810.3.5 shall not apply to micropiles.]~~ The steel pipe shall have a minimum wall thickness of $\frac{3}{16}$ inch (4.8 mm).

~~[1810.8.3]~~ **1812.8.3 Design.** Micropiles shall develop their load-carrying capacity by means of a bond zone in soil. The design of micropiles shall not consider end bearing. Micropiles shall be grouted and have either a steel pipe or steel reinforcement at every section along the length. It shall be permitted to transition compression loads from the steel pipe to the deformed reinforcing bars by extending the bars into the pipe section by at least their development length in tension, in accordance with ACI 318.

~~[1810.8.3.1]~~ **1812.8.3.1 Reinforcement.** For micropiles or portions thereof grouted inside a temporary or permanent casing or a hole drilled with grout, the steel pipe or steel reinforcement shall be designed to carry at least 40 percent of the design compression load. Micropiles or portions thereof grouted in an open hole in soil without temporary or permanent casing and without suitable means of verifying the hole diameter during grouting shall be designed to carry the entire compression load in the reinforcing steel. Where a steel pipe is used for reinforcement, the portion of the grout enclosed within the pipe is permitted to be included in the determination of the allowable stress in the grout.

~~[1810.8.3.2]~~ **1812.8.3.2 Seismic reinforcement.** For structures assigned to Seismic Design Category C, a permanent steel casing shall be provided from the top of the micropile down to

the point of zero curvature. For structures assigned to Seismic Design Category D, the micropile shall be approved by the commissioner in accordance with Section 28-113.2 of the [~~New York City~~] *Administrative Code*. The alternative system design, supporting documentation and test data shall be submitted to the commissioner for review and approval.

[1810.8.4] 1812.8.4 Splices. Splices in reinforcing bars shall be made in accordance with ACI 318. Splices in the steel pipe or casing shall be made by use of flush threaded joints, or by welded joints. Reductions for the structural capacity of the threaded joint casing at splice locations shall be accounted for in the design.

[1810.8.5] 1812.8.5 Installation. Micropile [~~deep foundation~~] elements shall be permitted to be formed in holes advanced by rotary or percussive drilling methods, with or without casing. The elements shall be grouted with a fluid cement grout. The grout shall be pumped through a tremie pipe extending to the bottom of the element until grout of suitable quality returns at the top of the element. The following requirements apply to specific installation methods:

1. For micropiles grouted inside a temporary casing, the reinforcing bars shall be inserted prior to withdrawal of the casing. The casing shall be withdrawn in a controlled manner with the grout level maintained at the top of the element to ensure that the grout completely fills the drill hole.

~~[2. For a micropile or portion thereof grouted in an open drill hole in soil without a temporary casing, the minimum design diameter of the drill hole shall be verified by a suitable device prior to grouting.]~~

~~[3.]~~ 2. Subsequent micropiles shall not be drilled near elements that have been grouted until the grout has had sufficient time to harden.

~~[4.]~~ 3. Micropiles shall be grouted as soon as possible after drilling is completed.

~~[5.]~~ 4. For micropiles designed with a full-length casing, the casing shall be pulled back to the top of the bond zone and reinserted or some other suitable means employed to assure grout coverage outside the casing.

[1810.8.5.1] 1812.8.5.1 Drilling with air. Where existing structures may be affected by subsurface disturbances, air drilling shall be prohibited.

[1810.8.6] 1812.8.6 Pressure grouted bond zone. Micropiles shall be installed with a pressure grouted bond zone. The bond zone shall be formed entirely in soil of Class 4 or better and the grout shall be placed under pressure exceeding 1.5 times the existing total [~~overburden pressure~~] stress at the midpoint of the bond zone. The bond zone shall be formed by extending the casing to the bottom of the bond zone and withdrawing the casing while the grout is being pumped under pressure. The casing above the bond zone shall remain in place permanently. Reinforcing to the bond zone shall be placed in the casing to the depth of the bond zone prior to placing grout.

SECTION BC ~~[1811]~~ 1813 COMPOSITE PILES

~~[1811.1]~~ **1813.1 General.** Composite piles shall conform to the requirements of Sections ~~[1811.2]~~ 1813.2 through ~~[1811.5]~~ 1813.5.

~~[1811.2]~~ **1813.2 Design.** Composite piles consisting of two or more approved ~~[pile]~~ types of deep foundations shall be designed to meet the conditions of installation.

~~[1811.3]~~ **1813.3 Limitation of load.** The maximum allowable load shall be limited by the capacity of the weakest section incorporated in the composite pile.

~~[1811.4]~~ **1813.4 Splices.** Splices between concrete and steel or wood sections shall be designed to prevent separation both before and after the concrete portion has set, and to ensure the alignment and transmission of the total ~~[pile]~~ load on the composite pile. Splices shall be designed to resist uplift caused by upheaval during driving of adjacent ~~[piles]~~ deep foundations, and shall develop the full compressive strength and not less than 50 percent of the tension and bending strength of the weaker section.

~~[1811.5]~~ **1813.5 Seismic reinforcement.** Where a structure is assigned to Seismic Design Category C or D, in accordance with Section 1613 and where concrete and steel are used as part of the composite pile assembly, the concrete reinforcement shall comply with Sections ~~[1810.1.2.3]~~ 1812.1.2.3 and ~~[1810.1.2.5]~~ 1812.1.2.5 and the steel section shall comply with Section ~~[1809.7.4]~~ 1811.7.4 or Section ~~[1810.6.4.1]~~ 1812.6.4.1.

SECTION BC ~~[1812]~~ 1814 HELICAL PILES

~~[1812.1]~~ **1814.1 General.** Helical piles may be used to support axial compression, or resist axial tension and lateral loads. All helical pile foundation systems shall be approved by the commissioner in accordance with Section 28-113.2 of the *Administrative Code*.

~~[1812.2]~~ **1814.2 Design.** Design of helical pile foundations shall be based on a geotechnical investigation in accordance with Sections ~~[1802]~~ 1803 and ~~[1808.2]~~ 1810.2 with the following additional conditions stated in Sections ~~[1812.2.1]~~ 1814.2.1 and ~~[1812.2.2]~~ 1814.2.2.

Exception: For the repair of residential porches, stoops and slab on grades, helical test probes may be used to substitute for test borings, provided the helical pile has a torque to capacity ratio approved in accordance with Section 28-113.2.1 of the *Administrative Code*.

~~[1812.2.1]~~ **1814.2.1 Corrosion testing requirements.** Tests shall be performed in each soil layer for soil resistivity, soil pH, organic content and sulphate concentration. The device or system shall not be used in conditions that are indicative of a potential helical pile corrosion situation, as defined by soil resistivity less than 1,000 ohm-cm, pH less than 5.5, soils with high organic content, sulfate concentrations greater than 1,000 ppm, landfills, or mine waste.

[1812.2.2] 1814.2.2 Protective treatment. In addition to the protective treatment requirements of Section ~~[1808.2.12]~~ 1810.2.12, helical pile design shall consider the abrasive action inherent in the installation process when protective exterior treatment is specified as helical pile protection.

[1812.3] 1814.3 Determination of allowable loads. The allowable load of helical piles shall be in accordance with the applicable provisions of Section ~~[1808.3]~~ 1810.3. In addition, the requirements of this section shall apply.

[1812.3.1] 1814.3.1 Allowable axial tension and compression. The allowable axial tension and compression load shall not exceed 30 tons (267 kN).

[1812.3.2] 1814.3.2 Allowable lateral load. The allowable lateral load resisted by a helical pile shall not exceed 3 tons (29.4 kN).

[1812.4] 1814.4 Load tests. Load tests shall be in accordance with Sections ~~[1808.4]~~ 1810.4 and ~~[1812.4.1]~~ 1814.4.1 through ~~[1812.4.4]~~ 1814.4.4.

[1812.4.1] 1814.4.1 Compression load test procedures. The allowable axial compression load of a helical pile shall be verified by load tests in accordance with the requirements of Section ~~[1808.4]~~ 1810.4, except that ASTM D1143 may be conducted using the Quick Load Test Loading Procedure. Following each compression load test, the ~~[test]~~ helical pile being tested shall be removed by unscrewing and inspected for any deformations to the helices~~[s]~~ to verify the structural integrity of the shaft and its connections.

[1812.4.1.1] 1814.4.1.1 Required number of axial compression load tests. The number of axial compression load tests shall satisfy Section ~~[1808.4]~~ 1810.4.

Exception: ~~[Pile load]~~ Load tests on helical piles shall not be required, provided the following conditions are satisfied:

1. The helical pile has a torque to capacity ratio approved in accordance with Section 28-113.2.1 of the *Administrative Code*;
2. The torque correlation shall demonstrate a factor of safety (FS) of 2.5 on the allowable load; and
3. The maximum allowable axial compression load on the helical pile shall be 10 tons (98 kN).

[1812.4.1.2] 1814.4.1.2 Acceptance criteria. The allowable ~~[pile load]~~ load on the helical pile shall be computed in accordance with Section ~~[1808.4.1.5]~~ 1810.4.1.5.

[1812.4.2] 1814.4.2 Axial tension load test procedures. The allowable axial tension load of a helical pile shall be verified by load testing in accordance with Section ~~[1808.4]~~ 1810.4 of this code; however, it shall be permitted to use the Quick Load Test Loading Procedure of ASTM D3689. Following the tension load test, the helical pile shall be removed by unscrewing, and shall be inspected for any deformations to the helices and to verify the structural integrity of the shaft and connections.

[1812.4.2.1] 1814.4.2.1 Required number of axial tension load tests. The number of axial tension load tests shall satisfy Section [1808.4] 1810.4, but with a minimum of one test.

[1812.4.3] 1814.4.3 Lateral load test procedures. The allowable lateral load of a helical pile shall be verified with load testing in accordance with Section [1808.4] 1810.4. Following the lateral load test, the helical pile shall be removed by unscrewing and inspected for any deformations to the helices[] to verify the structural integrity of the shaft and connections.

[1812.4.3.1] 1814.4.3.1 Required number of lateral load tests. The number of lateral load tests shall satisfy Section [1808.4] 1810.4, but shall not be fewer than one test.

[1812.4.3.2] 1814.4.3.2 Acceptance criteria. The allowable lateral [pile] load on the helical pile shall be computed in accordance with Sections [1808.4.3.1] 1810.4.3.1 and [1808.4.3.2] 1810.4.3.2.

[1812.4.4] 1814.4.4 Additional load tests. Additional axial compression, axial tension and lateral load tests shall be performed for questionable construction as required by Section [1808.4.1.1.1] 1810.4.1.1.1.

[1812.5] 1814.5 Minimum installation torque. Where load tests are required, the [test pile] helical pile being tested shall be used to determine the minimum required site-specific torque for installation of production helical piles. For each helical pile, the special inspector shall measure and log the installation torque for each foot of depth and the final torque in the helice's soil-bearing zone. The shaft advancement shall equal or exceed 85 percent of helix pitch per revolution at time of final torque measurement. Where load tests are not required, installation torque shall be in accordance with the exception defined under Section [1812.4.3] 1814.4.3.

[1812.6 ~~Pile internal~~] 1814.6 Internal stability of helical piles to resist overturning and translation. Where bracket assemblies or structural eccentric forces cause bending, the resulting moment [pile] design of the helical pile shall ensure stability in accordance with Section [1808.2.5] 1810.2.5 and general engineering practice. Where side-mount brackets are used and a stability analysis indicates that there is insufficient internal stability to resist overturning and translation, helical piles shall be installed staggered or other means shall be designed to provide stability and prevent rotation of the foundation.

[1812.7] 1814.7 Buckling. When helical piles are embedded in soils of Classes 6 and 7, a buckling analysis shall be performed by a recognized method. The allowable axial compressive load shall be not more than two-thirds of the calculated load-causing buckling. The additional bending moments due to bracket assemblies, structural eccentric forces and coupling rigidity shall be appropriately included in the buckling analysis.

[1812.8] 1814.8 Shaft flexural capacity. Where a moment is transmitted to a single helical pile, a structural analysis shall be conducted to verify that the shaft is capable of resisting the moment with acceptable deflection.

[1812.9] 1814.9 Side-mount bracket assembly test. Where side-mount brackets are used, each bracket assembly shall be proof-tested to a minimum 110 percent of allowable load to demonstrate

that the bracket assembly is capable of transferring the loads to the helical pile. The load shall be applied in six equal increments. The 110 percent test load shall be held for a minimum 30 minutes without bracket assembly distortion or deformation. Side-mount brackets for permanent applications shall be encased in concrete with a minimum embedment of 3 inches (76.2 mm). Concrete used to encase side-mount brackets shall meet the requirements of Sections 1903, 1904, 1905 and 1906.

~~[1812.10]~~ **1814.10 Minimum spacing of helical piles.** Minimum spacing between the center lines of helical piles shall be four times the largest helix plate diameter.

~~[1812.11]~~ **1814.11 Installation.** Equipment used for the installation of helical piles shall be as recommended by the helical pile manufacturer.

~~[1812.12]~~ **1814.12 Special inspection.** The installation of helical piles shall be subject to the special inspection requirements in Section ~~[1704.8]~~ 1705.7 and the following requirements:

1. The special inspector shall prepare a report of special inspections of helical piles~~[,]~~ and submit such report to the department in a manner acceptable to the commissioner. In addition to the requirements of Section ~~[1704.8]~~ 1705.7, this report shall also include, at a minimum, the following:
 - 1.1. Helical pile type and product specification sheet for ~~the~~ each helical pile installed as published by the manufacturer.
 - 1.2. Make and model of the equipment used for installation.
 - 1.3. Make and model number of the torque indicator used to measure installation torque.
 - 1.4. Calibration records for the torque indicators used to install the helical piles.
 - 1.5. The installation speed (rpm) of the helical pile.
 - 1.6. From axial load tests and the site specific torque to capacity relationship, the minimum torque required to achieve the allowable ~~[pile]~~ load of the helical pile in tension or compression.
 - 1.7. For each helical pile, the installation torque for each foot of depth and the final torque in the helice's soil-bearing zone. The shaft advancement shall equal or exceed 85 percent of helix pitch per revolution at time of final torque measurement.
2. Field welds performed in the installation of a helical pile foundation system shall additionally be subject to the special inspection requirements of Section ~~[1704.3]~~ 1705.2.

SECTION BC 1815 **PERMANENT PRESTRESSED ROCK AND SOIL ANCHORS**

1815.1 General. Rock and soil anchors discussed in this document are cement grouted, prestressed tendons (bars or strands) that are installed in soil or rock. Permanent prestressed rock and soil anchors shall be designed and constructed in accordance with Sections 1815.2 through 1815.8 and PTI DC35.1.

1815.2 Additional geotechnical investigation and report requirements. Where prestressed rock and soil anchors are used, the geotechnical investigation and report provisions of Section 1803.6 shall be expanded to include, but not be limited to, consideration of the following:

1. Recommended anchor types and capacities.
2. Suitable center-to-center spacing of anchor elements.
3. Minimum unbonded and bonded lengths of tendons, including appropriate rock or soil stratum or strata for the bond zone.
4. The effects of groundwater or voids including grout loss and reduced grout to ground bond.
5. Installation procedures.
6. Durability of anchor materials and minimum corrosion protection requirements.
7. Lock-off load and lift-off load requirements.
8. Reductions for group action, where necessary.
9. Protection of adjacent structures due to anchor installation.

1815.3 Materials. Materials used in prestressed rock and soil anchors shall conform to the following:

1. Bar tendons. Bar tendons shall conform to the requirements of ASTM A722 or shall be comprised of tested materials not covered by ASTM A722 but have mechanical properties meeting or exceeding those specified by ASTM A722 and which have been cold stressed and stress relieved.
2. Strand tendons. Strand tendons shall conform to the requirements of ASTM A416 or ASTM A882.
3. Grout. Grout shall consist of a pumpable mixture of portland cement, water, and any required fine aggregate, supplemental cementitious materials, or admixtures as permitted by Chapter 19. Grout shall have a minimum unconfined compressive strength (f'_c) equal to 4,000 psi (27 579 kpa).
4. Corrosion protection. All anchors shall meet PTI DC35.1 requirements for Class I protection (Encapsulated Tendons).

1815.4 Design. Anchors shall be designed in accordance with Sections 1815.4.1 through 1815.4.5.

1815.4.1 Ultimate bond strength. The average ultimate bond strength along the interface between anchor grout and the ground shall be determined by a generally accepted means of analysis and confirmed by load testing performed in accordance with Section 1815.5.

1815.4.2 Applicable strata. The bonded zone of anchors shall not be formed in soils designated as Class 6 or Class 7.

1815.4.3 Bonded zone. The bonded zone of anchors shall be fully located within materials of similar character and strength.

1815.4.4 Group capacity. Group capacity of anchors shall be determined by a generally accepted means of analysis and shall:

1. Ignore any contribution from soil or rock materials located beyond the property limits of the proposed structure.
2. Not exceed that of the sum of all individual anchor loads.

1815.4.5 Structural aspects.

1. Anchors design loads shall be based upon the load combinations specified in Section 1605.3.
2. Anchor design, lock-off, and test loads shall be in accordance with PTI DC35.1.
3. The cross section of the anchor tendons shall not be considered to contribute to the sliding or lateral resistance of any foundation element by means of shear friction.
4. Anchor design and lock-off loads shall consider the effects of long-term creep or changes in prestress resulting from deformation.

1815.5 Load testing. Load testing shall be in accordance with PTI DC35.1. Extended creep tests shall be performed for any anchors designed with bonded zones located within materials designated as Class 1d, Class 4 or Class 5.

1815.6 Installation. Installation procedures shall comply with the following:

1. Anchors shall be installed through fully cased boreholes. Open hole drilling shall only be permitted through stable bedrock.
2. Anchors having bond zones formed in soil shall be pressure grouted to at least 1.5 times the total stress at the midpoint of the bond zone.

1815.7 Grout sampling and testing. Sampling and testing of grout shall be performed in accordance with Section 1812.1.1.2.

1815.8 Special inspection. The installation and testing of prestressed rock and soil anchors shall be subject to special inspection in accordance with the requirements of Section 1705.19.

SECTION BC [1813] 1816
LIQUEFACTION ANALYSIS

[1813.1] 1816.1 General. An assessment of the liquefaction potential shall be determined for each building site except Structural Occupancy/Risk Category I structures. The evaluation of liquefaction potential shall include the following considerations:

1. Noncohesive granular soils below groundwater table and less than 50 feet (15 240 mm) below the ground surface shall be considered to have potential for liquefaction.
2. The potential for liquefaction on level ground shall be determined on the basis of the risk categories associated with the ~~[standard penetration resistance normalized to an energy of 60 percent efficiency (N_{60})]~~ values of N_{60} at the site, as defined in Figure [1813.1] 1816.1, or a site-specific analysis performed by a geotechnical engineer.
3. Clays, silts and clayey silts below the groundwater table and less than 50 feet (15 240 mm) below the ground surface with a plasticity index less than 20 shall be considered to have potential for liquefaction. The susceptibility of the fine grained soils shall be evaluated in accordance with generally accepted engineering practice or a site-specific analysis performed by a geotechnical engineer.

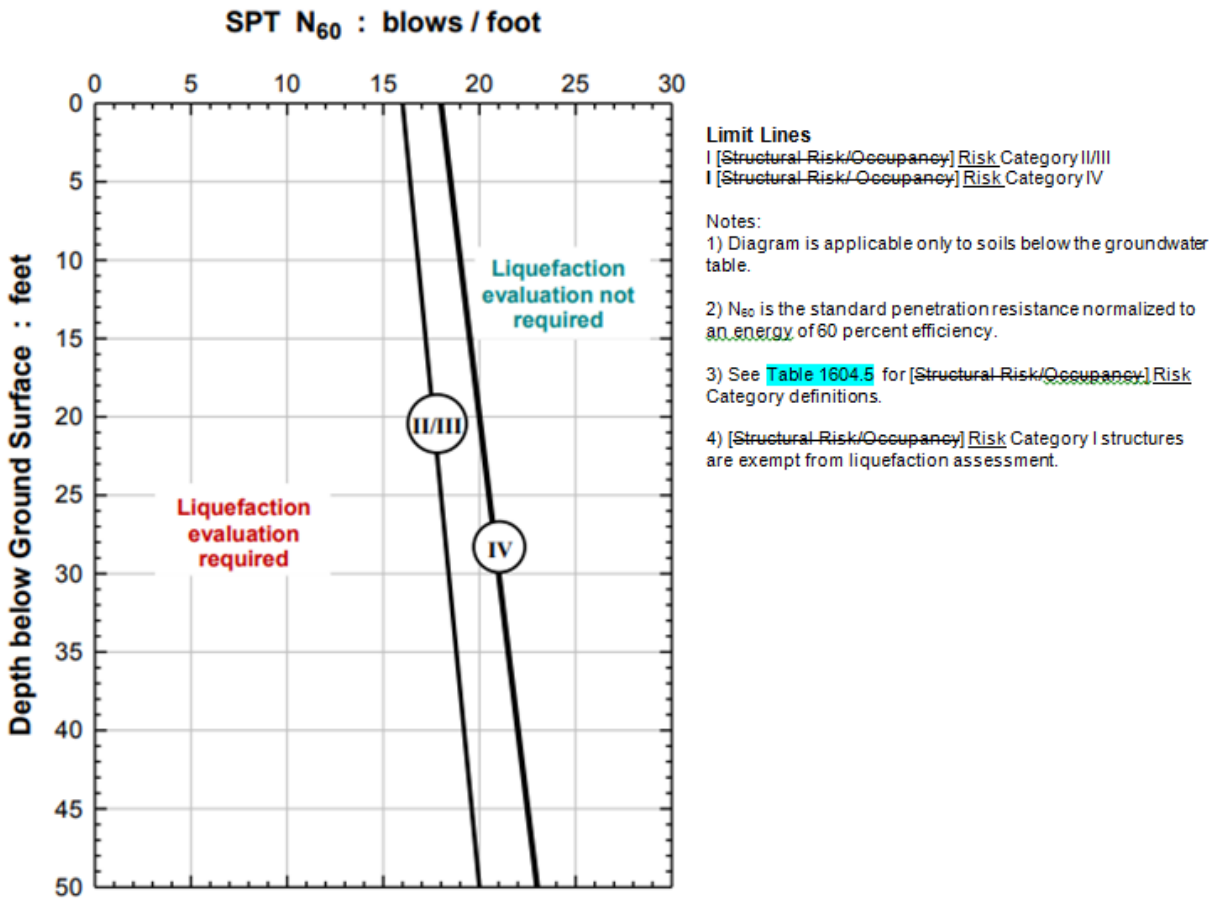

**FIGURE [1813.4] 1816.1
LIQUEFACTION ASSESSMENT DIAGRAM**

[1813.2] 1816.2 Site-specific analyses. In evaluating liquefaction potential, the analysis shall consider the following parameters: peak ground acceleration, earthquake magnitude, magnitude scaling factor, effective [~~overburden pressure~~] stress, hammer energy, cone penetration resistance (where applicable), and fines content. If a site response analysis is conducted, bedrock acceleration time histories and a shear wave velocity profile based on in-situ measurements may be utilized. These analyses may consider the results of laboratory cyclic shear tests. Where borings are drilled for the purpose of site-specific analyses and for the purpose of evaluating liquefaction potential, the drilling and sampling procedures and apparatus shall be in accordance with ASTM D6066.

[1813.2.1] 1816.2.1 Peak ground acceleration. Peak ground acceleration shall be determined based on either [(+)] (i) a site-specific study taking into account soil amplification effects as specified in Section [11.4.7] 11.4.8 of ASCE 7[-10] or [(2)] (ii) the Maximum Considered Geometric Mean peak ground acceleration adjusted for [~~Site Class~~] site class effects $PG_{M(g)}$ as provided in Table [1813.2.1] 1816.2.1 without adjustment for targeted risk.

**TABLE [1813.2.1] 1816.2.1
VALUES OF MAXIMUM CONSIDERED
EARTHQUAKE MEAN (MCE_G) PEAK
GROUND ACCELERATIONS ADJUSTED
FOR SITE CLASS EFFECTS, $PG_{M(g)}$**

Site Class	$PG_{M(g)}$
A	[0.14] 0.15
B (m)	0.17
B (un-m)	0.18
C	[0.20] 0.22
D	[0.24] 0.26
E	[0.33] 0.36

[1813.3] 1816.3 Foundation design analysis. The foundation design analysis shall consider an assessment of the potential consequences of any liquefaction and soil strength loss, including an estimation of total and differential settlement, lateral movement or reduction in foundation soil-bearing capacity, and may incorporate the potential benefits of any proposed mitigation measures. Such measures may be given consideration in the design of the structure and may include, but are not limited to, ground improvement, pore pressure dissipation, selection of appropriate foundation type and depths, selection of appropriate structural systems to accommodate anticipated displacements, or any combination of these measures.

In evaluating the potential for liquefaction, the effect of settlements induced by seismic motions and loss of soil strength shall be considered. The analysis performed shall incorporate the effects of the maximum considered earthquake (MCE) peak ground acceleration, appropriate earthquake magnitudes and duration consistent with the design earthquake ground motions as well as uncertainty and variability of soil properties across the site. The MCE peak ground acceleration, seismically induced cyclic stress ratios and pore pressure development may be determined from a site-specific study taking into account soil amplification effects and design ground motions appropriate for the seismic hazard. Other recognized methods of analysis may be used in the evaluation process subject

to the approval of the commissioner. Effects of liquefaction shall be considered in the design except when the following conditions exist:

1. Structures classified as Risk Category I.
2. When the calculated cyclic resistance ratio (CRR) is greater than or equal to the calculated cyclic stress ratio (CSR) for Risk Category II and III structures.
3. When the calculated CRR is greater than 1.2 times the calculated CSR for Risk Category IV structures.

[1813.4] 1816.4 Design considerations. Where liquefaction is determined to be probable, the following considerations shall be addressed in the design:

1. Liquefiable soils shall be considered to have no passive (lateral) resistance or bearing capacity value for the design earthquake, unless shown otherwise by accepted methods of analysis. The engineer shall submit an analysis for review and approval by the commissioner, demonstrating that the proposed construction is safe against the effects of soil liquefaction.
2. Where liquefiable soils are present in sloped ground or over sloped nonliquefiable substrata and where lateral displacement is possible, the engineer shall submit a stability analysis for review and approval by the commissioner, demonstrating that the proposed construction is safe against failure of the soil and that the effects of potential lateral displacements are acceptable.

SECTION BC [1814] 1817
UNDERPINNING AND ALTERNATE METHODS OF SUPPORT OF BUILDINGS AND
ADJACENT PROPERTY

[1814.1] 1817.1 General. Where the ~~[protection and/or support of a structure or property adjacent to an excavation is required, an engineer shall prepare a preconstruction report summarizing the condition of the structure or property. The preconstruction report shall be prepared based on an examination of the structure or property, the review of available documents and, if necessary, the excavation of test pits. The engineer shall determine the requirements for underpinning or other protection and prepare site and structure specific plans, including details and sequence of work for submission to the commissioner. Such protection may be provided by underpinning, sheeting, and bracing, or by other means acceptable to the commissioner.]~~ proposed work may disturb, displace or otherwise affect the lateral or vertical support of property or buildings, an engineer shall evaluate the need for and methods to maintain the stability and integrity of the building(s), utilities or soil adjacent to such activity.

[1814.1.1 Underpinning and bracing. Underpinning piers, walls, piles and footings shall be designed as permanent structural elements and installed in accordance with provisions of this chapter and Chapter 33 and shall be inspected in accordance with the provisions of Chapter 17. Underpinning shall be designed and installed in such manner so as to limit the lateral and vertical displacement of the adjacent structure to permissible values as established in accordance with Section 1814.3. The sequence of installation and the requirements for sheeting, preloading, wedging with steel wedges, jacking or dry packing shall be identified in the design. The design

~~shall take in account the effects on foundation and structure produced by the lateral earth pressure exerted on the underpinning. Lateral support for underpinning, if needed, shall be accounted for during the design of the new construction. The design and construction sequence of temporary lateral supports used prior to the installation of the foundation walls shall be included on the design drawings.]~~

1817.2 Minimum requirements for undeveloped adjacent property. The minimum requirements for construction documents for support of adjacent property which does not contain a building, such as, but not limited to, empty lots, court yards, front yards, or rear yards, shall include the following information:

1. Existing grade of the adjacent property.
2. Plans, cross-sections, and elevations as necessary, to illustrate all unique conditions of the support of excavation, including the depth of the proposed excavation, the subsurface conditions, surcharge loading, the proposed method of support, sequence of construction, required material properties, and additional details as required by Section 3304.
3. Details and criteria for monitoring, including but not limited to criteria and thresholds for movements, and dewatering as specified in Chapters 17, 18 and 33.
4. The elevation of the water table, need for dewatering as noted in the Geotechnical Report, and the maximum permissible drawdown outside of the project site.

1817.3 Evaluation of adjacent buildings for suitable method of support. At the time of foundation plan approval, an engineer shall submit an evaluation report to the department assessing the condition of the existing building and the subsurface conditions of the construction site and adjacent property. The report shall also identify acceptable method(s) of support, including underpinning or alternate methods of support, for the building. This evaluation shall be performed in accordance with the requirements of Section 1817.3.1 through 1817.3.6.

1817.3.1 Assessment of the building and the subsurface conditions: The engineer shall assess the condition of the existing building, and the subsurface conditions of the construction site and adjacent property, to an extent sufficient for determining acceptable method(s) of support, including underpinning or alternate methods of support. As necessary, the assessment shall be based on visual observations, calculations, review of the geotechnical report prepared for the project in accordance with Section 1803.6 and review of other available documentation. The investigation shall include, as necessary, but need not be limited to, the following items:

1. An evaluation of the vertical load path of the building as it relates to the location of the proposed underpinning or alternate method of support.
2. An evaluation of the lateral load path of the building as it relates to the location of the proposed underpinning or alternate method of support.
3. Calculations of the vertical and lateral loads at the foundations to be underpinned or supported by an alternate method of support.

4. A determination of the type and condition of the above grade elements to be supported or potentially affected by the work.
5. A survey of deviations from plumb or horizontal position of the building.
6. Identification of conspicuous structural defects, including but not limited to: bowing, significant cracking, structural degradation or unusual slenderness. A detailed description of such items shall be provided, with photographs and mapping if possible.
7. A determination of acceptable thresholds for maximum vertical and lateral movement, maximum permissible vibrations, the required monitoring and the protocols for exceedances.
8. A determination of the type and condition of the foundation elements to be supported or potentially affected by the work.
9. A test pit at each substantial change in foundation type or building geometry. Records of the test pits shall include the following:
 - a. A description of the construction materials and condition of the footing, foundation wall and/or foundation system.
 - b. The bottom elevation of the wall(s) and/or footing(s).
 - c. The classification of the soil or rock the foundation bears upon.
 - d. Photographs and sketches of the test pit.
10. An assessment of the allowable bearing pressure of the soils supporting the existing foundation(s) per Section 1806.
11. An assessment of potential reductions to the allowable bearing pressure due to the proposed excavation.
12. The lateral earth, surcharge, and water pressures that will be present on the elements of the proposed underpinning or alternate method of support.
13. An analysis of the subsurface conditions and their potential impacts on the underpinning or alternate method of support work such as, but not limited to: high water table and need for dewatering, loose soils, potentially running soils, presence of boulders, or other factors that could impact the design or construction of the underpinning or alternate method of support.
14. An assessment of the allowable bearing pressure of the soils supporting the underpinning or alternate method of support during the installation sequence and in the permanent condition.
15. An assessment of the anticipated settlement during the underpinning or alternate method of support, and soil and foundation work.

16. Any additional information requested by the commissioner.

1817.3.2 Additional requirements for buildings with rubble foundation elements. For buildings with rubble foundation elements, an assessment of the condition of the rubble element shall be performed. If the rubble foundation elements are in poor condition, recommendations for addressing the poor conditions shall be provided.

1817.3.3 Additional requirements for unreinforced masonry buildings. Where the building being supported is of unreinforced masonry construction, the lateral stability of the masonry walls and their ability to resist the loads imposed shall be verified.

Exception: If it is not possible to verify the lateral stability of the masonry walls, lateral support shall be provided at the floor levels of the adjacent building prior to installation of the underpinning or alternate method of support. Such lateral support shall be shown on the construction documents.

1817.3.4 Additional requirements for use of rock support. Where in situ Class 1a, 1b, or 1c rock is proposed for use in place of constructed methods of support, a subsurface investigation shall be conducted to assess the properties of the rock. Site-specific data shall be obtained to determine the predominant strike and dip of the joints, foliation, and/or other discontinuities in the rock. Recommendations for any rock stabilization necessary for the proposed work shall be provided.

1817.3.5 Evaluation report. The evaluation report shall include the following items:

1. The address of the property.
2. A description of the acceptable method(s) of support, including underpinning or alternate methods of support, that were evaluated and found to be feasible.
3. A description of any required modifications to reinforce the existing building prior to the start of the underpinning or alternate method of support work.
4. A summary of the assessment required by Sections 1817.3.1 through 1817.3.4, including all test pit records, where performed, and any additional items deemed necessary by the engineer.
5. A list of all assumptions made in preparation of the evaluation report and a detailed plan for the verification of such assumptions.
6. If the engineer determined that specific items listed in Sections 1817.3.1 through 1817.3.4 were not required, a statement shall be included explaining the basis for that determination for each item that was not included.

1817.3.6 Responsibility for the report. If more than one engineer participates in performing the required assessments of the building and subsurface conditions, and the author of the evaluation report is relying on the work of these additional engineer(s) in preparing the evaluation report, the findings of the additional engineer(s) shall be included as signed and sealed appendices to the evaluation report.

1817.4 Suitable Methods of Support. Where a method of support for an existing building is required, such underpinning or alternate method of support shall be designed as a permanent structural element specific to the building using the methods described in Sections 1817.4.1 through 1817.4.3. The underpinning or alternate method of support shall be installed in accordance with provisions of this chapter and Chapter 33 and shall be inspected in accordance with the provisions of Chapter 17.

1817.4.1 Underpinning. If the foundation loads are to be transferred to a lower bearing level, underpinning consisting of concrete piers, drilled piles, jacked piles, bracket piles, or similar engineered systems to transfer the existing building loads below the bottom of the proposed excavation shall be installed.

The bearing pressure at the base of the underpinning shall be computed accounting for all vertical loads and any overturning moments present due to lateral earth and water pressures, and shall be less than or equal to the allowable bearing pressure of the bearing stratum.

1817.4.2 Alternate methods of support. In lieu of underpinning, an excavation support system and/or lateral bracing designed to restrict the movements of the adjacent buildings within the established threshold levels may be installed. Such excavation support systems may consist of secant piles, slurry walls, tangent pile walls, jet grouting, pressed-in continuous sheeting, or similar engineered system.

~~[1814.2] **1817.4.3 Use of rock support.** Existing structures founded at a level above the level of adjacent new construction may be supported on Class 1a, ~~[and] 1b, and 1c~~ rock in lieu of underpinning, ~~[sheeting and bracing or retaining walls,]~~ provided ~~[that a report by the engineer substantiates the safety of the proposed construction. The engineer shall also certify that the he or she has inspected the exposed rock and the jointing therein and has determined whether supplemental support of the rock face is required.]~~ the requirements of Section 1817.3.4 are satisfied.~~

1817.5 Design requirements. The underpinning or alternate method of support for adjacent buildings shall be designed by an engineer and plans filed with the department for approval prior to the commencement of the work.

1817.5.1 New construction. Materials and design shall be in accordance with the requirements of this code for new construction.

1817.5.2 Incorporation of the evaluation report. The design shall incorporate the findings of the evaluation report and any additional evaluation and investigation deemed necessary by the engineer performing the design. If the evaluation report did not conclusively demonstrate the suitability of an underpinning or alternate method of support, such method of support shall not be used.

1817.5.3 Deviations from the evaluation report. The engineer designing the method of support may be an engineer other than the engineer who submitted the evaluation report. If the engineer designing the method of support does not accept the evaluation report or finds it insufficient, a new evaluation report shall be submitted to the department. Similarly, if a method of support other than one(s) determined to be suitable in the evaluation report is proposed for use, an additional evaluation report shall be submitted to the department justifying the suitability of the method of

support now proposed. The revised report may be submitted along with the construction documents for the design of the method of support. Alternatively, minor exceptions to the report may be incorporated into the design documents if explicitly indicated on the design documents along with the engineer's reason for override.

1817.5.4 Design loads and load combinations. Underpinning, alternate methods of support and any associated lateral support system, shall be designed for the loads and load combinations listed in Sections 1817.5.4.1 and 1817.5.4.2.

1817.5.4.1 Loads from the existing building. A computation shall be performed to establish the vertical and lateral loads on the elements of the method of support from the existing building. Loads and load combinations shall be computed in accordance with the requirements of Chapter 16 or where permitted for loads of prior codes for prior code buildings.

1817.5.4.1.1 Unconfirmed load path. Where the evaluation of Section 1817.3 is unable to visually confirm the load path from the existing building, pit-pier underpinning where all horizontal loads are transferred directly to a raker or tension anchor bracing system that braces every pit-pier is permissible.

Exception: Raker bracing or tension anchors need not be installed where it is demonstrated by calculation, according to data provided by the investigation per Section 1817.3.1, that the underpinning system, analyzed independently as a retaining wall that supports the soil and water behind it, calculated both (i) with and (ii) without accounting for vertical loads from the structure above, has satisfactory bearing pressures and is stable with a 1.5 factor of safety against overturning and sliding. This exception shall not be utilized in unreinforced masonry buildings in which access to verify the lateral stability of masonry walls is not possible as per Section 1817.3.3.

1817.5.4.2 Soil and water pressures. The design shall include at rest soil pressures, water pressures, and any surcharge pressures that arise from the adjacent portions of the building being underpinned or supported by an alternate method of support.

1817.5.5 Anticipated deflection. A calculation shall be performed for the anticipated deflection of the method of support system and its effect on the supported building.

1817.5.6 Factor of safety. Methods of support shall be designed to provide a minimum factor of safety of 1.5 for sliding and overturning for all loads and all anticipated interim conditions.

1817.5.7 Sequence. The design of the method of support shall account for the means and methods of installation, sequence of operations, and all the load transfers and associated support conditions for all phases of the work.

1817.6 Minimum requirements for construction documents. Construction documents for methods of support of adjacent buildings shall include the following information:

1. Indicate the type of adjacent foundation, including type of material.

2. The bearing elevation(s) of the adjacent building foundation and its soil classification.
3. For deep foundations, type and location including top and bottom elevations of deep foundation elements.
4. The elevations of all floor levels at grade and below in the adjacent building.
5. Plans, cross-sections, and elevations views as necessary, to illustrate all conditions of the adjacent building relevant to the operation, including the below grade portions and the depth of the proposed excavation.
6. Details and criteria for monitoring the building or wall being supported, including but not limited to criteria and thresholds for movements as specified in Section 1817.9 and Chapters 17 and 33.
7. A fully detailed design of the method of support including any required bracing.
 - a. For pit-pier underpinning, a detailed design for the timber shoring of the pit excavations shall also be provided.
8. A step by step procedure describing the installation of the elements of the method of support.
 - a. For pit-pier underpinning, the procedure shall include a diagram indicating the sequence of the pit installation and a detailed procedure of the installation of the shoring for the pit excavations.
9. The elevation of the water table, need for dewatering as noted in the evaluation report, and the maximum permissible drawdown.
10. References alerting the contractor and the special inspector to review the evaluation report of the adjacent building prior to the start of work.
11. Plans, sections, and elevation views of all methods of support.
12. Soil classification of the required bearing stratum for the elements of the method of support.
 - a. For pit-pier underpinning, also include the required allowable bearing pressure below the pier.
13. A load table or diagram shall be provided to indicate the following:
 - a. Total gravity load in underpinning pier or alternate method of support.
 - b. Total lateral load in underpinning piers or alternate method of support.

1817.7 Additional requirements for pit-pier underpinning. When the method of support selected is pit-pier underpinning, the design shall meet the following minimum criteria:

1. After installation of each pit-pier, the approach pit shall be back filled.

2. In no case shall the general site excavation expose more than one third of the total height of a pit-pier, unless:
 - 2.1. A pit-pier bracing system designed by the engineer is installed or;
 - 2.2. The calculated capacity of the individual pit-pier to resist lateral loading at a greater depth is identified on the drawings.
3. Pit-piers shall be preloaded by wedging, use of permanent jacks, or by other means designed by the engineer.
4. Any voids between the bottom of the foundation and the top of the pit-pier shall be filled with dry-pack or equivalent. Dry-pack shall be composed of nonshrink material and be no more than 3 inches in thickness.
5. The need for jacking and all associated jacking requirements shall be determined by the engineer responsible for the underpinning design.
6. The width of pit-piers shall not exceed 4 feet unless the calculations determine that a wider pit-pier is acceptable.
7. Shear transfer shall be designed and installed between adjacent pit-piers.
8. The bottom of pit-pier elevation shall be a minimum of one foot below the bottom of the future adjacent excavation.

1817.7.1 Pit-pier excavation. Pit-pier excavation shall be subject to the requirements of Section 1817.7.1.1 through 1817.7.1.8.

1817.7.1.1 Excavation Methods. Pit-pier excavations shall be performed using hand held tools. Excavation using backhoes or other mechanical means to excavate the pit-piers is prohibited.

1817.7.1.2 Clear distance between open pits. Clear distance between open pits shall be determined by the evaluation report and shall not be less than 12 feet (3657.6 mm).

1817.7.1.3 Pit Excavation below the lowest installed lagging board. Lagging boards shall be installed as the excavation proceeds to limit soil loss. In no case shall excavation proceed more than 2 feet (609.6 mm) below the lowest installed lagging board. At completion of pit excavation, the pit shall be fully lagged.

1817.7.1.4 Backpacking. Backpacking of any voids shall be performed at each excavation lift.

1817.7.1.5 Excavation below the water table. Pit excavation shall not proceed below the water table. If the depth of the underpinning requires excavation below the existing water

table, a dewatering system shall be installed prior to the start of the excavation. The dewatering system shall be tested via test pit or piezometer to confirm that the water table has been sufficiently drawn down prior to the start of the pit underpinning work.

1817.7.1.6 Variable depth pits. Where construction requires adjacent pits to be excavated to differing depths, the deeper pit-pier shall be constructed first.

1817.7.1.7 Multi-tier pit-pier underpinning. Where multi-tier pit-pier underpinning is utilized, the upper piers shall be braced prior to the excavation of the lower pier and the installation of upper and lower piers staggered, unless the design per Section 1817.5 and drawings include explicit methods that will ensure that the installation of lower tiers shall not displace the tiers above.

1817.7.1.8 Use of tension anchors. When tension anchors are utilized, the effects of vertical and horizontal force components shall be accounted for including any potential additional displacements.

1817.8 Additional requirements for deep foundation elements used in underpinning. Where the method of support includes deep foundation systems such as pile supported underpinning or tie anchors, the requirements of Chapter 18 and Sections 1817.8.1 through 1817.8.5 shall be met.

1817.8.1 Pile design. Piles used for underpinning shall be designed in accordance with Sections 1810.3 and 1810.4.

1817.8.2 Load testing of underpinning piles. Piles used for underpinning are subject to the load testing criteria of Section 1810.4.

1817.8.3 Eccentric pile loads. Piles used for underpinning shall be designed to sustain all moments that are generated due to any eccentricities of the load on the pile.

1817.8.4 Spanning between piles. Unless new grade beams are provided, calculations shall be performed to confirm that the existing foundation can support the required loads spanning between the pile supports.

1817.8.5 Piles used as excavation support elements. If underpinning piles are to be used as excavation support elements, a calculation of the anticipated pile deflection shall be performed and its impacts on the supported building shall be assessed by the engineer.

[1814.3] 1817.9 Monitoring. When excavation, foundation construction, [Ø] underpinning, or an alternate method of support is required, adjacent structures and properties shall be monitored in accordance with a plan prepared by the engineer. The engineer shall develop the scope of the monitoring program, including location and type of instruments, frequency and duration of readings, frequency of reporting, maximum allowable time to report readings (timely reporting), reporting requirements, and permissible movement and vibration criteria. This scope shall take into account the [structures] buildings or property to be monitored and the conditions thereof. The monitoring program shall include necessary actions to address exceedances. These actions shall include notification of the commissioner. Monitoring of historic and landmarked structures shall be subject

to special requirements as determined by the department. Where the building to be monitored is subject to underpinning or alternate methods of support, the monitoring plan shall be determined by the engineer designing such work.

1817.10 Special Inspection. Special inspection shall be conducted in accordance with Chapter 17.

SECTION BC 1818 **GEOTECHNICAL PEER REVIEW**

1818.1 General. The provisions of this section specify where geotechnical peer review is required, how and by whom it is to be performed.

1818.2 Where required. A geotechnical peer review shall be performed and a report shall be required in the following instances:

1. Where structural peer review is required pursuant to Section 1618.
2. For structures of Risk Category III or IV where the seismic site class is Site Class F.
3. Where performance based foundation design is utilized.
4. As required by the commissioner.

1818.3 Geotechnical peer review qualifications: The geotechnical peer review shall be performed by a qualified independent geotechnical engineer who has been retained by or on behalf of the owner. A geotechnical peer reviewer shall meet the requirements of the rules of the department.

1818.3.1 Independence. In order to satisfy the requirement that the peer reviewer be independent, the department requires that the peer reviewer must not engage in any activities that may conflict with their objective judgment and integrity, including but not limited to having a financial and/or other interest in the design, construction, installation, manufacture or maintenance of structures or components that they are reviewing.

1818.4 Extent of Geotechnical Peer Review. The extent of the geotechnical peer review shall be performed in accordance with Section 1818.4.1.

1818.4.1 Scope. The geotechnical peer reviewer shall review the plans and specifications submitted with the permit application for general compliance with the foundation design provisions of this code. The reviewing engineer shall perform the following tasks at a minimum:

1. Confirm that the subsurface investigation meets the requirements of this code
2. Confirm that the geotechnical report and supplemental reports, including foundation recommendations and testing, meet the requirements of this code.
3. Provide independent check on foundation capacities. This check must include the structural and geotechnical capacity of the foundation element, if not covered by the structural peer review.

4. Where uplift resistance is required, provide independent check on prestressed anchor or pile design.
5. Perform independent settlement calculations.
6. Confirm the design assumptions made by the geotechnical and structural engineers pertaining to the soil-foundation structure interaction are coordinated and consistent.
7. Confirm that potential impacts on adjacent structures due to foundation construction have been addressed in accordance with this code.
8. Review seismic analysis including any site-specific analysis, associated mitigation methods, and analyses pertaining to liquefaction for conformance with codes.

1818.5 Geotechnical peer review report. The geotechnical peer review report shall comply with Section 1818.5.1 through 1818.5.3.

1818.5.1 General. The reviewing engineer shall submit a report to the department stating whether or not the geotechnical design shown on the plans, reports and specifications generally conforms to the requirements of this code.

1818.5.2 Contents. The report shall demonstrate, at a minimum, compliance with Items 1 through 8 of Section 1818.4.1. In addition, the report shall also include the following:

1. The codes and standards used in the geotechnical design of the project.
2. The basis for design criteria that are not specified directly in applicable codes and standards. This should include reports by consultants such as geotechnical reports and site specific seismic studies. Generally, the report should confirm that existing conditions at the site have been investigated appropriately and that the design of the proposed foundations is in general conformance with these conditions.
3. Basis of performance based design and its appropriateness of use.
4. A statement that the qualification and independence of the peer reviewer is in accordance with Section 1818.3.
5. Peer review reports shall provide an unconditional statement that must be either an acceptance or rejection of code compliance of the geotechnical design required to be reviewed by this section.

1818.5.3 Phased submission. If an application is submitted for a permit for the construction of foundations or any other part of a building before the construction documents for the whole building have been submitted, then the geotechnical peer review and report shall be phased. The geotechnical peer reviewer shall be provided with sufficient information on which to make a geotechnical peer review of the phased submission. In addition to the requirements of this section, phased submission of the report shall include any changes made to the initial geotechnical peer review evaluation. The geotechnical peer review report need not be submitted concurrently with the structural peer review report.

1818.6 Responsibility. Responsibility shall be as provided for in Section 1818.6.1 through 1818.6.4.

1818.6.1 Engineer of record. The engineer of record for the foundation design shall retain sole responsibility for the geotechnical design. The activities and reports of the geotechnical peer reviewer shall not relieve the engineer of record for the foundation design of this responsibility.

1818.6.2 Geotechnical peer reviewer. The geotechnical peer reviewer's report states his or her opinion regarding the design by the engineer of record for the foundation design. The standard of care to which the geotechnical peer reviewer shall be held in the performance of the geotechnical peer review and report is that level of skill and care are consistent with geotechnical peer review services performed by professional engineers licensed in the State of New York for similar type projects. The geotechnical peer reviewer shall not be responsible for the accuracy of the subsurface investigation data or the conclusions of the structural peer review reports.

1818.6.3 Revisions of design. The engineer of record for the foundation design shall identify that a new review is required based upon changes to the design documents relevant to the scope of the peer review. The geotechnical peer reviewer shall review the items that have been affected and shall revise the geotechnical peer review report.

1818.6.4 Disputes. When a dispute arises between the applicant of record and the peer reviewer regarding compliance with Section 1818 that cannot be resolved by these parties, such dispute shall be reported to the department in the form of a letter from the applicant of record. The department may make a final decision or may accept a change of the peer reviewer.

1818.7 Change to peer reviewer. The peer reviewer cannot be changed without the express consent of the department. The current peer reviewer must submit both a written letter to the borough commissioner detailing the reason for the withdrawal request and a report of the geotechnical peer review findings to date. If a change of peer reviewer is approved, a revised PW1 must be submitted indicating the replacement peer reviewer.

§ 20. Chapter 19 of the New York city building code, as amended by local law number

141 for the year 2013, is amended to read as follows:a

**CHAPTER 19
CONCRETE**

**SECTION BC 1901
GENERAL**

1901.1 Scope. The provisions of this chapter shall govern the materials, quality control, design and construction of concrete used in structures.

1901.1.1 Referenced standards. Where this code makes reference to the nationally recognized standard ACI 318, such standard shall be as modified for New York City in accordance with Section 1908 of this code. Where sections within ACI 318 are referenced in other chapters and appendices of ACI 318, the provisions of this chapter shall apply.

1901.2 Plain and reinforced concrete. Structural concrete shall be designed and constructed in accordance with the requirements of this chapter and ACI 318 as amended in Section 1908 of this code. Except for the provisions of Sections 1904 and 1910, the design and construction of slabs on grade shall not be governed by this chapter unless they transmit vertical loads or lateral forces from other parts of the structure to the soil. Precast concrete diaphragms in buildings assigned to Seismic Design Category C or D shall be designed in accordance with the requirements of ASCE 7, Section 14.2.4.

~~[1901.3 Source and applicability. Sections 1902 through 1907 of this chapter are derived from the provisions for structural concrete in ACI 318. Where sections within Chapters 2 through 7 of ACI 318 are referenced in other chapters and appendices of ACI 318, the provisions of Sections 1902 through 1907 of this code shall apply.]~~

1901.3 Anchoring to concrete. Anchoring to concrete shall be in accordance with ACI 318 as amended in Section 1908, and applies to cast-in (headed bolts, headed studs and hooked J- or L-bolts), post-installed expansion (torque-controlled and displacement-controlled), undercut and adhesive anchors.

1901.4 Composite structural steel and concrete structures. Systems of structural steel acting compositely with reinforced concrete shall be designed in accordance with Section 2206.

~~[1901.4]~~ **1901.5 Construction documents.** The construction documents for structural concrete construction shall include:

1. ~~[Specified]~~ The specified compressive strength of concrete at the stated ages or stages of construction for which each concrete element is designed.
2. ~~[Specified]~~ The specified strength or grade of reinforcement.
3. ~~[Size]~~ The size and location of structural elements, reinforcement[,] and anchors.
4. Provision for dimensional changes resulting from creep, shrinkage and temperature.
5. ~~[Magnitude]~~ The magnitude and location of prestressing forces.
6. Anchorage length of reinforcement and location and length of lap splices.
7. Type and location of mechanical and welded splices of reinforcement.
8. Details and location of contraction or isolation joints specified for plain concrete.
9. Minimum concrete compressive strength at time of posttensioning.
10. Stressing sequence for posttensioning tendons.
11. For structures assigned to Seismic Design Category D, a statement if slab on grade is designed as a structural diaphragm [~~(see Section 2112.3.4 of ACI 318)~~].

12. Exposure classes per ACI 318, Section 19.3.1, and Section 1904.2 of this code [~~chapter and Section 4.2 of ACI 318~~].

13. Areas of mass-concrete where a thermal control plan is required.

~~[1901.5]~~ **1901.6 Special [~~inspection~~] inspections and tests.** [~~The special inspection~~] Special inspections and tests of concrete elements of buildings and structures, and concreting operations, shall be [~~in accordance with~~] as required by Chapter 17.

SECTION BC 1902 DEFINITIONS

1902.1 [General] Definitions. The [~~words and terms~~] following term is defined in [~~this section and ACI 318 shall, for the purposes of this chapter and as used elsewhere in this code for concrete construction, have the meanings shown herein and in ACI 318, as modified by Section 1908.1.1 of this chapter.~~] Chapter 2:

MASS CONCRETE. [~~Any volume of concrete with dimensions large enough to require that measures be taken to cope with generation of heat from hydration of the cement and attendant volume change to minimize cracking, reduction of compressive strength, and/or delayed ettringite formation.~~]

SECTION BC 1903 SPECIFICATIONS FOR TESTS AND MATERIALS

1903.1 General. Materials used to produce concrete, concrete itself and testing thereof shall comply with the applicable standards listed in ACI 318 and this section. [~~Where required, special inspections and tests shall be in accordance with Chapter 17.~~]

1903.2 [~~Cementitious materials.~~ Cementitious materials used to produce concrete shall comply with ACI 318, Section 3.2.] Special inspections. Where required, special inspections and tests shall be in accordance with Chapter 17.

1903.3 [~~Aggregates.~~ Aggregates used in concrete shall comply with ACI 318, Section 3.3.]

Glass fiber-reinforced concrete. Glass fiber-reinforced concrete (GFRC) and the materials used in such concrete shall be in accordance with the PCI MNL 128 standard.

1903.4 Flat wall insulating concrete form (ICF) systems. Insulating concrete form material used for forming flat concrete walls shall conform to ASTM E 2634.

1903.5 Water. Water used in mixing concrete shall be clean and free from injurious amounts of oils, acids, alkalis, salts, organic materials or other substances that are deleterious to concrete or steel reinforcement and shall comply with ACI 318, Section [~~3.4~~] 26.4.1.3.

~~[1903.5]~~ **1903.6 Steel reinforcement.** Reinforcement and welding of reinforcement to be placed in concrete construction shall conform to the requirements of ACI 318, [~~Section 3.5~~] Chapter 20, and this section.

~~[1903.5.1]~~ **1903.6.1 Reinforcement type.** Steel reinforcement used in concrete construction shall comply with ACI 318, ~~[Section 3.5]~~ Chapter 20.

~~[1903.5.2]~~ **1903.6.2 Welding.** Welding of reinforcing bars shall conform to AWS D1.4 and ACI 318, Section ~~[3.5.2]~~ 26.6.4. Type and location of welded splices and other required welding of reinforcing bars shall be indicated on the construction documents or in the project specifications. The ASTM reinforcing bar specifications, except for ASTM A 706, shall be supplemented to require a report of material properties necessary to conform to the requirements in AWS D1.4. A written welding procedure shall be provided to the registered design professional of record for approval prior to any welding. All welding shall be subject to special inspection by a special inspection agency.

~~[1903.6]~~ **1903.7 Admixtures.** Admixtures to be used in concrete shall be subject to prior approval by the registered design professional of record and shall comply with ACI 318, Section [3.6] 26.4.1.4. Admixtures shall be included in the concrete design mix submittals.

~~[1903.7]~~ **1903.8 Storage of materials.** The storage of materials for use in concrete shall comply with ACI 318, Section ~~[3.7]~~ 26.5.1, and the provisions of Sections ~~[1903.7.1]~~ 1903.8.1 and ~~[1903.7.2]~~ 1903.8.2 of this chapter.

~~[1903.7.1]~~ **1903.8.1 Manner of storage.** Cementitious materials and aggregates shall be stored in such a manner as to prevent deterioration or intrusion of foreign matter.

~~[1903.7.2]~~ **1903.8.2 Unacceptable material.** Any material that has deteriorated or has been contaminated shall not be used for concrete.

~~[1903.8 Glass fiber reinforced concrete.~~ Glass fiber reinforced concrete (GFRC) and the materials used in such concrete shall be in accordance with the ~~PCI MNL 128 standard.]~~

~~[1903.9 Flat wall insulating concrete form (ICF) systems.~~ Insulating concrete form material used for forming flat concrete walls shall conform to ~~ASTM E 2634.]~~

SECTION BC 1904 DURABILITY REQUIREMENTS

1904.1 General. Concrete shall be designed and proportioned to comply with the durability, strength, exposure, and other requirements as specified in ~~[Section 4.1 of]~~ ACI 318 and Sections 1904.2 through 1904.5 of this chapter.

1904.2 Exposure categories and classes. Concrete shall be assigned to exposure classes in accordance with ACI 318, Section ~~[4.2]~~ 19.3.1, based on:

1. Exposure to freezing and thawing in a moist condition or exposure to deicing chemicals;
2. Exposure to sulfates in water or soil;
3. Exposure to water where the concrete is intended to have low permeability; and

4. Exposure to chlorides from deicing chemicals, salt, saltwater, brackish water, seawater or spray from these sources, where the concrete has steel reinforcement.

1904.3 Concrete properties. Concrete mixtures shall conform to the most restrictive [~~maximum water cementitious materials ratios and minimum specified concrete compressive strength~~] requirements of ACI 318, Section [4.3] 19.3.2, based on the exposure classes assigned in Section 1904.2 of this chapter.

Exception: For occupancies and appurtenances thereto in Group R occupancies that are in buildings less than four stories above grade plane, normal-weight aggregate concrete is permitted to comply with the requirements of Table 1904.3 of this chapter in lieu of the requirements of ACI 318, Table [4.3.1] 19.3.2.1.

**TABLE 1904.3
MINIMUM SPECIFIED COMPRESSIVE STRENGTH (f'_c)**

TYPE OR LOCATION OF CONCRETE CONSTRUCTION	MINIMUM SPECIFIED COMPRESSIVE STRENGTH (f'_c at 28 days, psi)
Basement walls , foundation walls, exterior walls and other vertical concrete surfaces, basement slabs, interior slabs on grade except for garage floor slabs, and foundations not exposed to the weather	3,000 ^a
Driveways, curbs, walks, patios, porches, carport slabs, steps and other flatwork exposed to the weather, and garage floor slabs	3,500 ^b
Structural concrete exposed to weather	4,500

For SI: 1 pound per square inch = 0.00689 MPa.

- a. Concrete in these locations that can be subjected to freezing and thawing during construction shall be of air-entrained concrete in accordance with Section 1904.2.
- b. Concrete shall be air entrained in accordance with Section 1904.4.1.

1904.4 Freezing and thawing exposures. Concrete that will be exposed to freezing and thawing, in the presence of moisture, with or without deicing chemicals being present, shall comply with ACI 318, Section 19.3.3, and Sections 1904.4.1 and 1904.4.2 of this code.

1904.4.1 Air entrainment. Concrete exposed to freezing and thawing while moist shall be air entrained in accordance with ACI 318, [~~Section 4.4.1~~] Sections 19.3.3.1 and 19.3.3.3.

1904.4.2 Deicing chemicals. For concrete exposed to freezing and thawing in the presence of moisture and deicing chemicals, the maximum weight of fly ash, other pozzolans, silica fume or slag that is included in the concrete shall not exceed the percentages of the total weight of cementitious materials permitted by Table 1904.4.2.

**TABLE 1904.4.2
REQUIREMENTS FOR CONCRETE EXPOSED TO DEICING CHEMICALS**

CEMENTITIOUS MATERIALS	MAXIMUM PERCENT OF TOTAL CEMENTITIOUS MATERIALS BY WEIGHT ^{a,b}
Fly ash or other pozzolans conforming to ASTM C 618	25 ^d
Slag conforming to ASTM C 989	50
Silica fume conforming to ASTM C 1240	10

Total of fly ash or other pozzolans, slag and silica fume	50 ^e
Total of fly ash or other pozzolans and silica fume	35 ^e

- a. The total cementitious material also includes ASTM C 150, ASTM C 595, ASTM C 845 and ASTM C 1157 cement.
- b. The maximum percentages shall include:
1. Fly ash or other pozzolans present in Type IP or I (PM) blended cement, ASTM C 595, or ASTM C 1157.
 2. Slag used in the manufacture of an IS or I (SM) blended cement, ASTM C 595, or ASTM C 1157.
 3. Silica fume, ASTM C 1240, present in a blended cement.
- c. Fly ash or other pozzolans and silica fume shall constitute no more than 25 and 10 percent, respectively, of the total weight of the cementitious materials. The amount of fly ash or other pozzolans conforming to ASTM C 618 shall be permitted to be increased in accordance with footnote d, provided the maximum percentage of supplemental cementitious materials does not exceed the maximum values stated in Table 1904.4.2 when combining multiple types of supplemental cementitious materials.
- d. Amount of fly ash or other pozzolans conforming to ASTM C 618 in a given concrete mixture can be increased to 35% provided that the concrete is not placed during cold weather as defined by ACI 306 or that the concrete is membrane cured and protected from freezing until the concrete has attained 3,500 psi.

1904.5 Alternative cementitious materials for sulfate exposure. Combinations of cementitious materials for use in sulfate-resistant concrete that are alternative to those listed in ACI 318, [Table 4.3.4] Table 19.3.2.1, shall be permitted in accordance with ACI 318, Section [4.5.4] 26.4.2.2.

SECTION BC 1905 CONCRETE QUALITY, MIXING AND PLACING

1905.1 General. The required strength and durability of concrete shall be governed by compliance with the proportioning, testing, mixing and placing provisions of Sections 1905.1.1 through 1905.13 of this code and ACI 318.

1905.1.1 Strength. Concrete shall be proportioned to provide an average compressive strength in accordance with Section 1905.3, and shall satisfy the durability criteria of Section 1904. Concrete shall be produced to minimize the frequency of strengths below f'_c in compliance with Section 1905.6.3.3. For concrete designed and constructed in accordance with this chapter, f'_c shall not be less than 2,500 psi (17.22 MPa). No maximum specified compressive strength shall apply unless restricted by a specific provision of this code or ACI 318.

1905.1.2 Cylinder tests. Requirements for f'_c shall be based on tests of cylinders made and tested in accordance with Section 1905.6.3.

1905.1.3 Basis of f'_c . Unless otherwise specified, f'_c shall be based on 28-day tests. If other than 28 days, test age for f'_c shall be as indicated in construction documents. If at any time during the concrete operations, the concrete is not in conformance with ASTM C 94 or is otherwise compromised, it shall be rejected. If it is placed, the location of the load shall be recorded and a pair of cylinders shall be molded from the load per ASTM C 31 and included in the average f'_c .

1905.1.4 Lightweight aggregate concrete. Where design criteria in ACI 318, [Sections 8.6.1, 9.5.2.3, 11.2, 12.2.4, and 22.2.4, provide] Section 19.2.4, provides for use of a splitting tensile strength value of concrete (f'_{ct}), laboratory tests shall be made in accordance with ASTM C 330 to establish the value of f'_{ct} corresponding to the specified value of f'_c .

1905.1.5 Field acceptance. Splitting tensile strength tests shall not be used as a basis for field acceptance of concrete.

1905.2 Selection of concrete proportions. Concrete proportions shall be determined in accordance with ACI 318 and the provisions of Sections 1905.2.1 through 1905.2.4 of this code.

1905.2.1 General. Proportions of materials for concrete shall be established to provide:

1. Workability and consistency to permit concrete to be worked readily into forms and around reinforcement under the conditions of placement to be employed, without segregation or excessive bleeding.
2. Resistance to special exposures as required by Section 1904.
3. Conformance with the strength test requirements of Section 1905.6.

1905.2.2 Different materials. Where different materials are to be used for different portions of proposed work, each combination shall be evaluated.

1905.2.3 Basis of proportions. Concrete proportions shall be established in accordance with Section 1905.3 or Section 1905.4, and shall comply with the applicable requirements of Section 1904.

1905.2.4 Mass concrete. For areas of high-strength mass concrete, including but not limited to, 8,000 psi (55 158 kPa) or greater and the least dimension being equal to or greater than 36 inches (914 mm), as indicated on the construction documents, a thermal control plan complying with ACI 301, Section 8.1 and acceptable to the registered design professional of record shall be submitted by the contractor.

1905.3 Proportioning on the basis of field experience and/or trial mixtures. Concrete proportioning determined on the basis of field experience or trial mixtures shall be done in accordance with ACI 318, [~~Section 5.3~~] Sections 26.4.3 and 26.4.4, and Sections 1905.3.1 through 1905.3.5 of this chapter. [~~If the required f'_e is obtained for trial batch mixes prior to the date specified, the trial mix design may be approved. All mixes shall be approved by the registered design professional of record, prior to construction.~~]

1905.3.1 Required Strength. If the required [~~f'_{eff}~~] f'_{cr} is obtained for trial batch mixes prior to the date specified, the trial mix design may be approved by the registered design professional of record for the structural design.

1905.3.2 Performance and approval. Concrete mix designs shall be performed by an approved agency or by a concrete producer [~~who is~~] approved by the department as an approved fabricator [~~authorized~~] in accordance with Section 1704.2.2, and approved in accordance with the requirements of Sections 1905.3.2.1 through 1905.3.2.3.

1905.3.2.1 Certification. All mix designs submitted for review and approval in accordance with Section 1905.3.2.2 shall be certified by the director of the approved agency or the quality control manager of the approved [~~fabricator~~] concrete producer that performed the tests used to substantiate the mix design. In addition, all mix designs shall be signed by an owner or officer of the concrete production facility.

1905.3.2.2 Review and approval. All mixes shall be approved by the registered design professional of record and filed with the department prior to use in construction.

1905.3.2.3 Distribution. Copies of the approved mix design(s) shall be maintained at the construction site by the contractor and made available to the department upon request. A copy of the approved mix design(s) shall be provided by the contractor to the licensed concrete testing laboratory performing the acceptance testing of the concrete at the construction site.

1905.3.3. Test records and trial mixtures. Field strength test records or trial mixtures used to determine f'_{cr} shall not be more than 24 months old measured from the date of batching, provided the materials are the same as those proposed for use and the concrete producer provides a written statement confirming the materials are the same as those proposed for use.

Exceptions:

1. Coarse aggregates may be acquired from an alternative source provided the nominal maximum size and the volume of coarse aggregate used remain unchanged.
2. Fine aggregates may be acquired from an alternative source provided the volume of fine aggregate used remains unchanged.

1905.3.4 Materials. The type and source of the materials used in the concrete shall be identified in the proposed concrete mix design. In order for materials in field strength test records or trial mixtures to be considered the same as those proposed for use, the materials shall, at a minimum, comply with the following:

1. Cementitious materials. Cementitious materials shall be used in the same quantities for each individual component and shall be of the same type and shall be from the same source and mill. Upon request, the concrete producer shall provide mill certificates for the cementitious materials proposed for use and cementitious materials represented by the field strength test records or trial mixtures to the registered design professional of record and the department.
2. Aggregates. Coarse and fine aggregates shall be the same nominal maximum size and shall be used in the same volume for each individual component. The aggregate supplier shall attest that the aggregates proposed are not alkali-silica reactive. The aggregate supplier is permitted to rely on New York State Department of Transportation approval of the supplier's aggregate source.
3. Admixtures. Admixtures shall meet the requirements of the same admixture type in accordance with ASTM C 494 or ASTM C 260 and there shall be no change in air content or water content from the previously specified mix.

Exception: Addition or removal of retarding or accelerating admixtures as described in Section 1905.3.5 is acceptable.

4. Additional testing. Differences or changes in materials that are proposed for use, not meeting the requirements of Items 1 through 3 above, shall require new testing demonstrated by either field strength test records or trial mixtures.

Exception: Field changes to concrete proportions specified in Section 1905.3.5.

1905.3.5 Field changes to concrete proportions. Based on test data and observations during the course of construction, the following changes described in Sections 1905.3.5.1 and 1905.3.5.2 are permitted without requiring additional trial mixtures or field strength test records, provided:

1. There are no changes to the type and source of materials described in ~~[Section]~~ Sections 1905.3.3 and 1905.3.4, except as permitted in Sections 1905.3.5.1 and 1905.3.5.2;
2. Documentation of these changes are maintained by the concrete producer and the concrete contractor;
3. The changes described in Section 1905.3.5 cannot be used for the submission of an initial mix design to demonstrate that a previously prepared mix design meets strength or air content requirements that differ from the required concrete properties without new field strength test records or new trial mix designs;
4. Where required in Section 1905.3.5, documentation of these changes shall be submitted for acceptance to the registered design professional of record for the structural design by the concrete producer prior to use;
5. Copies of the revised mixtures shall be maintained at the construction site and provided to the licensed concrete testing laboratory performing the acceptance testing of concrete in accordance with Item 4 of Table ~~[4704.4]~~ 1705.3 of this code; and
6. The documentation required by Items 2 and 5 above shall be made available to the commissioner upon request.

1905.3.5.1 Changes that do not require prior approval of the registered design professional of record for the structure. The following admixture modifications to concrete proportions can be made without requiring prior acceptance by the registered design professional of record:

1. Air-entraining admixtures. Air-entraining admixture dosages can be increased or decreased as needed to obtain the air content specified in the construction documents.
2. Water reducing admixtures. Water reducing admixture dosages can be increased or decreased to produce the specified workability, provided that the design water is not exceeded and the changes do not segregate the concrete mix.

1905.3.5.2 Changes that require prior approval of the registered design professional of record for the structure. The following modifications to concrete proportions can be made only with prior acceptance by the registered design professional of record. Any added materials and the final mix proportions shall be indicated in a revised mix design submitted to the registered design professional of record prior to use:

1. Retarding and accelerating admixtures. Retarding and accelerating admixtures may be added to concrete mixtures or the dosage may be modified as needed to maintain practical set times.

2. Pigment. Pigment dosage may be adjusted to maintain uniform concrete color.
3. Fibers. Synthetic, glass or natural fibers may be added to the mix within the manufacturer recommended range. Any loss in workability shall be compensated with a water reducer.

Exception: Steel fibers may not be added to a concrete mixture without the performance of a new mix design.

4. Corrosion inhibitor. Corrosion inhibiting admixtures may be added, provided the corresponding adjustment of mix water remains within the limits of the required water/cementitious material ratio. The added materials and the revised design mix shall be submitted for review by the registered design professional of record for the structure prior to use.
5. Cementitious content and [~~water-cementitious~~] water-cementitious material ratio (w/cm). The cementitious content may be increased by a maximum of 12 percent, or the w/cm ratio may be decreased while maintaining the same cementitious content, but the w/cm and air content shall not be increased. Aggregate quantities shall be adjusted, as required, to maintain the mix proportion and yield.

6. Hydration control. Admixture may be added for the purpose of delaying hydration and maintaining a workable mix.

7. Source of aggregate. Change to the source of aggregate may be approved by the registered design professional of record without providing additional test data only when the original aggregate source is no longer producing the required aggregates or the quality of the aggregates produced no longer meets the requirements of ASTM C 33 or the New York State Department of Transportation, provided:

7.1. The new aggregate source is approved by the New York State Department of Transportation;

7.2. A modulus of elasticity is not specified;

7.3. The volume of both the fine and coarse aggregates remains the same and the nominal maximum size of coarse aggregates is unchanged;

7.4. Lightweight aggregate shall not be substituted for dense, nor dense aggregate for lightweight, where lightweight aggregates are defined as having a specific gravity less than 2.5; and

7.5. The registered design professional of record is informed of the reason necessitating the change of aggregate.

8. Cementitious materials. Any change to cementitious materials shall require an additional laboratory testing trial batch. The new cementitious material shall maintain the same air and water cementitious ratio (w/cm) as the original mix and meet the strength requirements of ACI 301, Table 4.2.3.3 b. Approval of the registered design

professional of record and submittal of data from either a three- or seven-day compressive strength test shall be required prior to the placement of concrete.

1905.4 Proportioning without field experience or trial mixtures. Concrete proportioning determined without field experience or trial mixtures shall be done in accordance with ACI 318, Section ~~[5.4]~~ 26.4.4.1(b). This method of proportioning shall not be permitted for:

1. Load-carrying structural concrete where the total volume of concrete on a given project exceeds 50 cubic yards (38 m³); or
2. Structural or non-structural concrete mix proportions that will be exposed to exposure classes S1, P1, or C2.

1905.5 Average strength reduction. As data ~~[become]~~ becomes available during construction, it is permissible to reduce the amount by which the average compressive strength (f'_c) is required to exceed the specified value of f'_c in accordance with ACI 318, Section ~~[5.5]~~ 26.4.4.1(c). A new mix design shall be submitted to the registered design professional of record for approval prior to use.

1905.6 Evaluation and acceptance of concrete. The criteria for evaluation and acceptance of concrete shall be as specified in ACI 318, Sections 26.12 and 26.13, and Sections ~~[1905.6.2]~~ 1905.6.1 through ~~[1905.6.5.5]~~ 1905.6.5 of this code.

1905.6.1 Acceptance testing. Concrete shall be tested in accordance with the requirements in Sections 1905.6.2 through 1905.6.5. Concrete sampling and testing for acceptance shall be deemed a special inspection performed by a licensed concrete testing laboratory as an approved agency. An approved agency shall perform tests on fresh concrete at the job site, prepare specimens required for curing under field conditions, prepare specimens required for testing in the laboratory and record the temperature of the fresh concrete when preparing specimens for strength tests. All field sampling and testing, including the testing of aggregates, concrete mixes, and strength testing of specimens, shall be subject to special inspection by an approved agency. All testing laboratories shall be approved agencies and shall employ qualified special inspectors to perform all required field and laboratory tests. Test results shall be promptly distributed by the testing laboratory to the registered design professional of record, concrete producer, owner and contractor to allow for corrective action where the concrete is found to be noncompliant with the mix design or noncompliant with the requirements otherwise specified in this code. Unless more prompt action is required, test results shall be reported no ~~[less]~~ more than 7 business days after the date the respective tests were performed.

1905.6.2 Frequency of testing. The frequency of conducting strength tests of concrete shall be as specified in Sections 1905.6.2.1 through 1905.6.2.4.

1905.6.2.1 Minimum frequency. For the first 250 cubic yards of each class of concrete placed each day, samples for strength tests of each such class shall be taken: (i) not less than once a day; (ii) not less than once for each 50 cubic yards (38 m³) of concrete; and (iii) not less than once for each 5,000 square feet (465 m²) of surface area for slabs or walls. After the first 250 cubic yards (191 m³), samples for strength tests of each class of concrete placed each day shall be taken once for each additional 150 cubic yards (115 m³). For structural concrete exposed to exposure class C2, additional field testing of the concrete for water

content per AASHTO T 318 shall be required. At the discretion of the registered design professional of record, the frequency of testing may be reduced, but not less than once for each 150 cubic yards (115 m³).

1905.6.2.2 Minimum number. On a given project, if the total volume of concrete is such that the frequency of testing required by Section 1905.6.2.1 would provide less than five strength tests for a given class of concrete, tests shall be made from at least five randomly selected batches or from each batch if fewer than five batches are used.

1905.6.2.3 Small volume. When the total volume of concrete is less than 50 cubic yards (38 m³) on a given project, testing may be waived by the registered design professional of record.

1905.6.2.4 Strength test. A strength test shall be the average of the strengths of two 6 inch by 12 inch (152 mm by 3048 mm) or two 4 inch by 8 inch (102 mm by 203mm) cylinders made from the same sample of concrete and tested at 28 days or at the test age designated for the determination of f'_c . Consideration shall be given specifying an f'_c at 56 days or later for concrete utilizing pozzolans in the mix proportions. At the discretion of the registered design professional of record or the approved agency performing the testing, additional pairs of test cylinders may be taken at the time of sampling for testing at a later date. The additional cylinders may be tested at a later date should the strength at the specified date not meet the required f'_c .

1905.6.3 Standard-cured specimens. Standard-cured specimens shall comply with the provisions of Sections 1905.6.3.1 through 1905.6.3.9.

1905.6.3.1 Mix Design. The special inspector shall verify that the proportions indicated on the batch ticket for the concrete delivered to the construction site are as per the approved concrete mix design prior to concrete placement (see Table [1704.4] 1705.3 of this code). Concrete that does not meet the requirements of the approved concrete mix design shall be rejected.

1905.6.3.2 Sampling. Samples for strength tests shall be taken in accordance with ASTM C 172.

1905.6.3.3 Cylinders. Cylinders for strength tests shall be molded and standard-cured in accordance with ASTM C 31.

1905.6.3.3.1 On-site curing. The [~~Contractor~~] contractor shall be responsible for providing the specified field storage curing facility and for monitoring the temperature of the cylinders as defined in ASTM C 31.

1905.6.3.3.2 Final curing. Cylinders shall be placed in final curing conditions meeting the requirements of ASTM C 511. Cylinders shall be transported to final curing conditions by the licensed concrete testing laboratory within 48 hours of casting the cylinders.

1905.6.3.3.3 Compressive strength testing. The cylinders shall be tested in accordance with ASTM C 39.

1905.6.3.4 Evaluation of results. The strength level of an individual class of concrete shall be considered satisfactory if both of the following requirements are met:

1. Every arithmetic average of any three consecutive strength tests equals or exceeds f'_c .
2. No individual strength test (average of two cylinders) falls below f'_c by more than 500 psi (3.45 MPa) when f'_c is 5,000 psi (34.50 MPa) or less, or by more than 0.10 f'_c when f'_c is more than 5,000 psi (34.50 MPa).

1905.6.3.5 Correction. If either of the requirements of Section ~~[1905.6.3.3]~~ 1905.6.3.4 is not met, steps shall be taken to increase the average of subsequent strength test results. The requirements of Section 1905.6.5 shall govern if the requirement of Section ~~[1905.6.3.6]~~ 1905.6.3.4, Item 2, is not met.

1905.6.3.6 Field testing. Each time concrete is sampled for strength testing, the tests set forth in Items 1 through 5 shall be performed by the approved agency:

1. Temperature in accordance with ASTM C 1064.
2. Slump in accordance with ASTM C 143.
3. Unit weight in accordance with ASTM C 138.
4. Air content in accordance with ASTM C 173 or C 231. Testing in accordance with ASTM C 173 must be used for concretes made with lightweight aggregates, and other instances where ASTM C 231 is not applicable.
5. Water content per AASHTO T 318 when required by Section 1905.6.2.1 of this code.

1905.6.3.7 Mass concrete. For mass concrete sections identified as requiring monitoring, install temperature devices that are capable of measuring the temperature of the concrete continuously and record temperature data in increments that do not exceed 30 minutes for a minimum period of seven days per ACI 301, Section 8.3 or as otherwise directed by the registered design professional of record. In lieu of monitoring a concrete placement for core and outside face temperatures, a computer simulated thermal study may be substituted, if approved by the registered design professional of record. The computer simulated thermal study shall be of the largest section placed for a specific concrete mix proportion and reflect the thermal properties for the specific cementitious materials and quantities in the mix. The thermal study shall include the maximum temperature at which concrete may be placed and the ambient temperature range for concrete placement.

1905.6.3.8 Results of field tests. The approved agency shall immediately report the results of field tests performed to the contractor and concrete truck driver, or other representative of the concrete producer. If at any time during the concrete operations, the concrete is not in conformance with ASTM C 94, this code, or is otherwise compromised, it shall be rejected. If it is placed, the location of the load shall be recorded and a pair of cylinders shall be molded from the load per ASTM C 31 and included in the average f'_c . The approved agency shall keep

a written record of all field tests at the construction site and make the records available upon request. These results need not be used in calculating the arithmetic average of consecutive test results required by Section 1905.6.3.4.

1905.6.3.9 Reporting requirements. Field sampling and testing shall be deemed a special inspection, and the approved agency performing the field sampling and testing of concrete at the construction site shall be subject to the requirements of Section [~~1704.1.2~~] 1704.1.1.2 regarding reporting of deficiencies.

1905.6.4 Field-cured specimens. Field-cured specimens shall comply with the provisions of Sections 1905.6.4.1 through 1905.6.4.4.

1905.6.4.1 When required. Where required by the commissioner, the results of strength tests of cylinders cured under field conditions shall be provided to the department.

1905.6.4.2 Curing. Field-cured cylinders shall be cured under field conditions in accordance with ASTM C 31.

1905.6.4.3 Sampling. Field-cured test cylinders shall be molded at the same time and from the same samples as laboratory-cured test cylinders.

1905.6.4.4 Correction. Procedures for protecting and curing concrete shall be improved when the strength of field-cured cylinders at the test age designated for determination of f'_c is less than 85 percent of that of companion laboratory-cured cylinders. The 85-percent limitation shall not apply if the field-cured strength exceeds f'_c by more than 500 psi (3.45 MPa).

1905.6.5 Low-strength test results. The investigation of low-strength test results shall be in accordance with the provisions of Sections 1905.6.5.1 through 1905.6.5.5.

1905.6.5.1 Precaution. If any strength test of laboratory-cured cylinders performed in accordance with Section 1905.6.2.4 falls below the specified value of f'_c by more than the values given in Section [~~1905.6.3.6~~] 1905.6.3.4, Item 2, or if tests of field-cured cylinders performed in accordance with Section [~~1905.6.4.4~~] 1905.6.4 indicate deficiencies in protection and curing, steps shall be taken to assure that the load-carrying capacity of the structure is not jeopardized.

1905.6.5.2 Core tests. Where calculations indicate that load-carrying capacity is significantly reduced, tests of cores drilled from the area in question in accordance with ASTM C 42 shall be permitted. In such cases, three cores shall be taken for each strength test that falls below the values given in Section 1905.6.3.4, Item 2.

1905.6.5.3 Condition of cores. Cores shall be prepared for transport and storage by wiping drilling water from their surfaces and placing the cores in water-tight bags or containers immediately after drilling. Cores shall be tested not earlier than 48 hours nor later than seven days after coring unless approved by the registered design professional of record.

1905.6.5.4 Test results. Concrete in an area represented by core tests shall be considered structurally adequate if the average of three cores is equal to at least 85 percent of f'_c and if no single core is less than 75 percent of f'_c . Additional testing of cores extracted from locations represented by erratic core strength results is permitted.

1905.6.5.5 Strength evaluation. If the criteria of Section 1905.6.5.4 are not met and the structural adequacy remains in doubt, the commissioner may order a strength evaluation in accordance with ACI 318, Chapter ~~[20]~~ 27, for the questionable portion of the structure, or take other appropriate action. The registered design professional of record shall present to the commissioner a complete analysis showing the final safe load-carrying capacity of the questionable portion of the structure including any proposed remedial actions necessary for review and approval.

1905.6.6 Steel fiber-reinforced concrete. Steel fiber-reinforced concrete used in beams shall be subject to the requirements of ACI 318, Section ~~[5.6.6]~~ 26.12.5. The required testing and inspection of steel fiber-reinforced concrete shall be deemed a special inspection. Steel fibers shall not be used in place of required reinforcing bars.

1905.7 Preparation of equipment and place of deposit. Preparation before concrete placement shall include the following:

1. Equipment for mixing and transporting concrete shall be clean.
2. Debris and ice shall be removed from spaces to be occupied by concrete.
3. Forms shall be properly coated.
4. Masonry filler units that will be in contact with concrete shall be well drenched.
5. Reinforcement shall be thoroughly clean of ice or other deleterious coatings.
6. Water shall be removed from the place of deposit before concrete is placed unless a tremie is to be used or unless otherwise permitted by the commissioner.
7. Laitance and other unsound material shall be removed before additional concrete is placed against hardened concrete.

1905.8 Mixing. Mixing of concrete shall be performed in accordance with Sections 1905.8.1 through 1905.8.3.

1905.8.1 General. Concrete shall be mixed until there is a uniform distribution of materials and shall be discharged completely before the mixer is recharged. Concrete delivered shall be proportioned in accordance with Section 1905.2.3. Modification to the approved concrete proportions shall be based upon standards acceptable to the commissioner.

1905.8.2 Ready-mixed concrete. Ready-mixed concrete shall be mixed and delivered in accordance with the requirements of ASTM C 94 or ASTM C 685.

1905.8.2.1 Concrete plants. Concrete plants shall be certified by the National Ready Mixed Concrete Association (NRMCA), the Concrete Industry Board Concrete Producer Certification Program, or other program acceptable to the department, and shall comply with the rules of the department. Concrete producers shall have their plants inspected quarterly and have their scales and trucks certified. In fulfilling this certification requirement, the concrete producer may present certification by either a New York City government agency, or by the New York State Department of Transportation subject to the approval of the commissioner.

1905.8.2.2 Delivery personnel. Concrete ready-mix truck drivers shall be certified by the NRMCA and shall comply with the rules of the department.

1905.8.2.3 Batch tickets. Batch tickets shall accompany every load of concrete delivered to a site. The batch ticket shall contain the information specified in Items 1 through 7:

1. Plant name and location.
2. Contract number and project.
3. Mix designation as to type and strength.
4. Each material in the load along with quantities of each by weight, and admixture by ounces or gallons.
5. The total amount of mix proportion water approved, quantity of water added at the plant and in transit, and the remaining water that can be added on site.
6. Any deviations from the approved concrete mix design and variations permitted by Section 1905.3.5.
7. The time the water was added to the batch.

1905.8.2.3.1 Copies of batch tickets. A copy of each batch ticket shall be given to the licensed concrete testing laboratory special inspector performing the acceptance testing at the delivery of each load. The licensed laboratory shall maintain copies of the batch tickets along with other inspection reports required by Section 1704.1, and make them available to the department upon request.

1905.8.3 Job-mixed concrete. Job-mixed concrete shall comply with ACI 318, Section [~~5.8.3~~ 26.5].

1905.9 Conveying. The method and equipment for conveying concrete to the place of deposit shall comply with Sections 1905.9.1 and 1905.9.2.

1905.9.1 Method of conveyance. Concrete shall be conveyed from the mixer to the place of final deposit by methods that will prevent separation or loss of materials that may alter the properties of the concrete delivered. Cylinders shall be made to determine the quality of concrete. Such cylinders shall be made at the truck or at the point of placement of the concrete as determined by the special inspection agency or the registered design professional of record.

1905.9.2 Conveying equipment. The conveying equipment shall be capable of providing a supply of concrete at the site of placement without separation of ingredients and without interruptions sufficient to permit the loss of plasticity between successive increments.

1905.10 Depositing. The depositing of concrete shall comply with the provisions of Sections 1905.10.1 through 1905.10.8.

1905.10.1 Segregation. Concrete shall be deposited as nearly as practicable to its final position to avoid segregation due to rehandling or flowing.

1905.10.2 Placement timing. Concreting operations shall be carried on at such a rate that the concrete is at all times plastic and flows readily into spaces between reinforcement.

1905.10.3 Unacceptable concrete. Concrete that has partially hardened or been contaminated by foreign materials shall not be deposited in the structure.

1905.10.4 Retempering. Retempered concrete or concrete that has been remixed after initial set shall not be used.

1905.10.5 Continuous operation. After concreting has started, it shall be carried on as a continuous operation until placing of a panel or section, as defined by its boundaries or predetermined joints, is completed, except as permitted or prohibited by Section 1906.4.

1905.10.6 Placement in vertical lifts. The top surfaces of vertically formed lifts shall be generally level.

1905.10.7 Construction joints. When construction joints are required, they shall be made in accordance with Section 1906.4.

1905.10.8 Consolidation. Concrete shall be thoroughly consolidated by suitable means during placement and shall be thoroughly worked around reinforcement and embedded fixtures and into corners of the forms.

1905.11 Curing. The curing of concrete shall be in accordance with Sections 1905.11.1 through 1905.11.3.

1905.11.1 Regular. Concrete (other than high early strength) shall be maintained above 50°F (10°C) and in a moist condition for at least the first seven days after placement, except when cured in accordance with Section 1905.11.3.

1905.11.2 High-early-strength. High-early-strength concrete shall be maintained above 50°F (10°C) and in a moist condition for at least the first three days, except when cured in accordance with Section 1905.11.3.

1905.11.3 Accelerated curing. Accelerated curing of concrete shall comply with ACI 318, Section ~~[5.11.3]~~ 26.5.3.2(c), but concrete temperature shall not exceed 160°F (71°C).

1905.12 Cold weather requirements. Concrete that is to be placed during freezing or near-freezing weather shall comply with the following:

1. Adequate equipment shall be provided for insulating or heating concrete materials and protecting concrete during freezing or near-freezing weather.
2. Concrete materials and reinforcement, forms, fillers and ground with which concrete is to be in contact shall be free from frost. The temperature of surfaces in contact with fresh concrete, including but not limited to forms and reinforcing steel, shall be raised above freezing.
3. Frozen materials or materials containing ice shall not be used.

1905.13 Hot weather requirements. During hot weather, proper attention shall be given to ingredients, production methods, handling, placing, protection and curing to prevent excessive concrete temperatures or water evaporation that could impair the required strength or serviceability of the member or structure.

SECTION BC 1906 FORMWORK, EMBEDDED PIPES AND CONSTRUCTION JOINTS

1906.1 Formwork. The design, fabrication and erection of forms shall comply with the requirements of ACI 318, Section 26.11 and Section 3305.3 of this code [~~and with ACI 318, Section 6.1~~].

1906.2 Removal of forms, shores and reshores. The removal of forms and shores, including slabs and beams (except where cast on the ground), and the installation of reshores shall comply with ACI 318, Section 26.11.2 and Section 3305.3 of this code [~~and ACI 318, Section 6.2~~].

1906.3 Conduits and pipes embedded in concrete. Conduits, pipes and sleeves of any material not harmful to concrete and within the limitations of ACI 318, Section [~~6.3~~] 20.7, are permitted to be embedded in concrete with approval of the registered design professional of record.

1906.4 Construction joints. Construction joints, including their location, shall comply with the provisions of ACI 318, Section [~~6.4~~] 26.5.6. Construction joints, including their location, shall be approved by the registered design professional of record prior to installation.

SECTION BC 1907 DETAILS OF REINFORCEMENT

1907.1 Hooks. Standard hooks on reinforcing bars used in concrete construction shall comply with ACI 318, Section [~~7.1~~] 25.3.

1907.2 Minimum bend diameters. Minimum reinforcement bend diameters utilized in concrete construction shall comply with ACI 318, Section [~~7.2~~] 25.3.2.

1907.3 Bending. The bending of reinforcement shall comply with Sections 1907.3.1 and 1907.3.2.

1907.3.1 Cold bending. Reinforcement shall be bent cold, unless otherwise permitted by the registered design professional of record.

1907.3.2 Embedded reinforcement. Reinforcement partially embedded in concrete shall not be field bent, except as shown on the construction documents or permitted by the registered design

professional of record.

1907.4 Surface conditions of reinforcement. The surface conditions of reinforcement shall comply with the provisions of Sections 1907.4.1 through 1907.4.3.

1907.4.1 Coatings. At the time concrete is placed, reinforcement shall be free from mud, oil or other nonmetallic coatings that decrease bond. Zinc and epoxy-coating of steel reinforcement in accordance with ACI 318, [~~Sections 3.5.3.8, 3.5.3.9, and 3.5.3.10~~] Section 20.6.2 shall be permitted.

1907.4.2 Rust or mill scale. Except for prestressing [~~steel~~] reinforcement, steel reinforcement with rust, mill scale or a combination of both, shall be permitted, provided the minimum dimensions, including height of deformations and weight of a hand-wire-brushed test specimen, comply with applicable ASTM specifications specified in Section [~~1903.5~~] 1903.6.

1907.4.3 Prestressing [~~steel~~] reinforcement. Prestressing [~~steel~~] reinforcement shall be clean and free of oil, dirt, scale, pitting and excessive rust. A light coating of rust is permitted.

1907.5 Placing reinforcement. The placement of concrete reinforcement shall comply with the provisions of Sections 1907.5.1 through 1907.5.4.

1907.5.1 Support. Reinforcement, including tendons, and posttensioning ducts shall be accurately placed and adequately supported before concrete is placed, and shall be secured against displacement within tolerances permitted in Section 1907.5.2. Where approved by the registered design professional of record, embedded items (such as dowels or inserts) that either protrude from precast concrete members or remain exposed for inspection are permitted to be embedded while the concrete is in a plastic state, provided the following conditions are met:

1. Embedded items are maintained in the correct position while the concrete remains plastic.
2. The concrete is properly consolidated around the embedded item. Embedded items are not required to be hooked or tied to reinforcement within the concrete.

1907.5.2 Tolerances. Unless otherwise specified by the registered design professional of record, reinforcement, including tendons, and posttensioning ducts shall be placed within the tolerances specified in Sections 1907.5.2.1 and 1907.5.2.2.

1907.5.2.1 *d* and cover. Tolerance for *d* and concrete cover [~~in flexural members, walls and compression members~~] shall be as [~~shown~~] required in [~~Table 1907.5.2.1, except that tolerance for the clear distance to formed soffits shall be minus $^{-1/4}$ inch (6.4 mm) and tolerance for cover shall not exceed minus one-third the concrete cover specified in the design drawings or specifications~~] ACI 318, Section 26.6.2.1(a).

**[TABLE 1907.5.2.1
TOLERANCES]**

[DEPTH (<i>d</i>) (inches)]	[TOLERANCE ON <i>d</i> (inch)]	[TOLERANCE ON SPECIFIED CONCRETE COVER]
[$d \leq 8$]	[$\pm \frac{3}{8}$]	[$-\frac{3}{8}$]
[$d > 8$]	[$\pm \frac{1}{2}$]	[$-\frac{1}{2}$]

[For SI: 1 inch = 25.4 mm.]

1907.5.2.2 Bends and ends. Tolerance for longitudinal location of bends and ends of reinforcement shall be [~~± 2 inches (± 51 mm)~~ except the tolerance shall be $\pm \frac{1}{2}$ inch (± 12.7 mm) at the discontinuous ends of brackets and corbels, and ± 1 inch (25 mm) at the discontinuous ends of other members. The tolerance for concrete cover of Section 1907.5.2.1 shall also apply at discontinuous ends of members.] as required by ACI 318, Section 26.6.2.1(b).

1907.5.3 Welded wire reinforcement. Welded wire reinforcement with wire size not greater than W5 or D5 used in slabs not exceeding 10 feet (3048 mm) in span is permitted to be curved from a point near the top of the slab over the support to a point near the bottom of the slab at midspan, provided such reinforcement is either continuous over, or securely anchored at support.

1907.5.4 Welding. Welding of crossing bars shall not be permitted for assembly of reinforcement unless authorized by the registered design professional of record.

1907.6 [Spacing limits for] Minimum spacing of reinforcement. The clear distance between reinforcing bars, bundled bars, tendons and ducts shall comply with ACI 318, Section [7.6] 25.2.

1907.7 Concrete protection for reinforcement. The minimum concrete cover for reinforcement shall comply with Sections 1907.7.1 through 1907.7.8.

1907.7.1 Cast-in-place concrete (nonprestressed). Minimum specified concrete cover shall be provided for reinforcement in nonprestressed[~~]~~ cast-in-place concrete construction in accordance with [~~Table 1907.7.1~~] ACI 318, Section 20.6.1.3.1, but shall not be less than required by Sections 1907.7.6 and 1907.7.8 of this code.

**[TABLE 1907.7.1
MINIMUM CONCRETE COVER]**

[CONCRETE EXPOSURE]	[MINIMUM COVER (inches)]
[1-] [Concrete cast against and permanently exposed to earth]	[3]
[2-] [Concrete exposed to earth or weather] [No. 6 through No. 18 bar] [No. 5 bar, W31 or D31 wire, and smaller]	[2] [1½]
[3-] [Concrete not exposed to weather or in contact with ground] [Slabs, walls, joists:] [No. 14 and No. 18 bars] [No. 11 bar and smaller] [Beams, columns:] [Primary reinforcement, ties, stirrups, spirals] [Shells, folded plate members:] [No. 6 bar and larger] [No. 5 bar, W31 or D31 wire, and smaller]	 [1½] [¾] [1½] [¾] [½]

[For SI: 1 inch = 25.4 mm.]

1907.7.2 Cast-in-place concrete (prestressed). The minimum specified concrete cover for prestressed and nonprestressed reinforcement, ducts and end fittings in cast-in-place prestressed concrete shall comply with ACI 318, Section [7.7.2] 20.6.1.3.2.

1907.7.3 Precast concrete (manufactured under plant control conditions). The minimum specified concrete cover for prestressed and nonprestressed reinforcement, ducts and end fittings in precast concrete manufactured under plant control conditions shall comply with ACI 318, Section [7.7.3] 20.6.1.3.3.

1907.7.4 Bundled bars. The minimum specified concrete cover for bundled bars shall comply with ACI 318, Section [7.7.4] 20.6.1.3.4.

1907.7.5 Headed shear stud reinforcement. For headed shear stud reinforcement, the minimum specified concrete cover shall comply with ACI 318, Section [7.7.5] 20.6.1.3.5.

1907.7.6 Corrosive environments. In corrosive environments or other severe exposure conditions, prestressed and nonprestressed reinforcement shall be provided with additional protection in accordance with ACI 318, Section [7.7.6] 20.6.1.4.

1907.7.7 Future extensions. Exposed reinforcement, inserts and plates intended for bonding with future extensions shall be protected from corrosion.

1907.7.8 Fire protection. When this code requires a thickness of cover for fire protection greater than the minimum concrete cover in Section 1907.7, such greater thickness shall be specified on the construction documents.

1907.8 Special reinforcement details for columns. Offset bent longitudinal bars in columns and load transfer in structural steel cores of composite compression members shall comply with the provisions of ACI 318, Section [~~7.8~~] 10.7.4.

1907.9 Connections. Connections between concrete framing members shall comply with the provisions of ACI 318, [~~Section 7.9~~] Chapters 15 and 16.

1907.10 Transverse reinforcement for compression members. Transverse reinforcement for compression members shall comply with the provisions of ACI 318, Section [~~7.10~~] 25.7.2.

1907.11 Transverse reinforcement for flexural members. Transverse reinforcement for compression reinforcement in flexural members shall comply with the provisions of ACI 318, Section [~~7.11~~] 25.7.1.

1907.12 Shrinkage and temperature reinforcement. Reinforcement for shrinkage and temperature stresses in concrete members shall comply with the provisions of ACI 318, Section [~~7.12~~] 24.4.

1907.13 Requirements for structural integrity. The detailing of reinforcement and connections between concrete members shall comply with the provisions of ACI 318, Section [~~7.13~~] 4.10 and Section 1912 of this code.

SECTION BC 1908 MODIFICATIONS TO ACI 318

1908.1 General. The text of ACI 318 shall be modified as indicated in Sections 1908.1.1 through [~~1908.1.7~~] 1908.1.10.

1908.1.1 ACI 318, Section [~~2.2~~] 2.3. Modify existing definitions and add the following definitions to ACI 318, Section [~~2.2~~] 2.3.

DESIGN DISPLACEMENT. Total lateral displacement expected for the design-basis earthquake, as specified by Section 12.8.6 of ASCE 7.

DETAILED PLAIN CONCRETE STRUCTURAL WALL. A wall complying with the requirements of Chapter [~~22, including 22.6.7~~] 14 including 14.6.2.

ORDINARY PRECAST STRUCTURAL WALL. A precast wall complying with the requirements of ACI 318 except for Chapters [~~1 through 18~~] 14, 17 and 18.

ORDINARY REINFORCED CONCRETE STRUCTURAL WALL. A cast-in-place wall complying with the requirements of ACI 318 except for Chapters [~~1 through 18~~] 14, 17 and 18.

ORDINARY STRUCTURAL PLAIN CONCRETE WALL. A wall complying with the requirements of Chapter [~~22~~] 14, excluding [~~22.6.7~~] 14.6.2.

SPECIAL STRUCTURAL WALL. A cast-in-place or precast wall complying with the requirements of ~~[21.1.3]~~ 18.2.4 through ~~[21.1.7, 21.9]~~ 18.2.8, 18.10 and ~~[21.10]~~ 18.11, as applicable, in addition to the requirements for ordinary reinforced concrete structural walls or ordinary precast structural walls, as applicable. Where ASCE 7 refers to a “special reinforced concrete structural shear wall,” it shall be deemed to mean a “special structural wall.”

~~[WALL PIER. A wall segment with a horizontal length to thickness ratio of at least 2.5, but not exceeding six, whose clear height is at least two times its horizontal length.]~~

1908.1.2 ACI 318, Section 8.7.2. Modify ACI 318, Section 8.7.2.3 and 8.7.2.4, and add new sections 8.7.2.5 and 8.7.2.6 to read as follows:

8.7.2.3 – For prestressed slabs with Banded-Distributed tendon placement, the maximum spacing s of tendons or groups of tendons in the distributed direction shall be the lesser of $8h$ and 5ft.

8.7.2.4 – The placement of tendons banded in both directions over the supports in two-way slabs is allowed. For Banded-Banded tendon placement, all provisions of ACI-318 Chapter 8 shall apply, except section 8.7.2.3, referring to the maximum tendon spacing limitation.

8.7.2.5 – At locations where the average effective prestress is not distributed, the two-way slab shall be designed using non-prestressed reinforcement.

8.7.2.6 – Concentrated Loads and openings shall be considered in determining tendon spacing.

1908.1.3 ACI 318, Section 14.1.4. Delete ACI 318, Section 14.1.4 and replace with the following:

14.1.4 – Plain concrete in structures assigned to Seismic Design Category C or D.

14.1.4.1 – Structures assigned to Seismic Design Category C or D shall not have elements of structural plain concrete, except as follows:

(a) Structural plain concrete basement, foundation or other walls below the base, as defined in ASCE 7, are permitted in detached one- and two-family dwellings three stories or less in height constructed with stud-bearing walls. In dwellings assigned to Seismic Design Category D, the height of the wall shall not exceed 8 feet (2438 mm), the thickness shall be not less than 7½ inches (190 mm), and the wall shall retain no more than 4 feet (1219 mm) of unbalanced fill. Walls shall have reinforcement in accordance with 14.6.1.

(b) Isolated footings of plain concrete supporting pedestals or columns are permitted, provided the projection of the footing beyond the face of the supported member does not exceed the footing thickness.

Exception: In detached one- and two-family dwellings three stories or less in height, the projection of the footing beyond the face of the supported member is permitted to exceed the footing thickness.

(c) Plain concrete footings supporting walls are permitted, provided the footings have at least two continuous longitudinal reinforcing bars. Bars shall not be smaller than No. 4 and shall have a total area of not less than 0.002 times the gross cross-sectional area

of the footing. For footings that exceed 8 inches (203 mm) in thickness, a minimum of one bar shall be provided at the top and bottom of the footing. Continuity of reinforcement shall be provided at corners and intersections.

Exceptions:

1. In Seismic Design Categories A, B and C, detached one- and two-family dwellings three stories or less in height constructed with stud-bearing walls are permitted to have plain concrete footings without longitudinal reinforcement.
2. For foundation systems consisting of a plain concrete footing and a plain concrete stemwall, a minimum of one bar shall be provided at the top of the stem wall and at the bottom of the footing.
3. Where a slab on ground is cast monolithically with the footing, one No. 5 bar is permitted to be located at either the top of the slab or bottom of the footing.

1908.1.4 ACI 318, Section 14.6. Modify ACI 318, Section 14.6 by adding new Section 14.6.2 to read as follows:

14.6.2 – Detailed plain concrete structural walls.

14.6.2.1 – Detailed plain concrete structural walls are walls conforming to the requirements of ordinary structural plain concrete walls and 14.6.2.2.

14.6.2.2 – Reinforcement shall be provided as follows:

- (a) Vertical reinforcement of at least 0.20 square inch (129 mm²) in cross-sectional area shall be provided continuously from support to support at each corner, at each side of each opening and at the ends of walls. The continuous vertical bar required beside an opening is permitted to substitute for one of the two No. 5 bars required by 14.6.1.
- (b) Horizontal reinforcement at least 0.20 square inch (129 mm²) in cross-sectional area shall be provided:
 1. Continuously at structurally connected roof and floor levels and at the top of walls;
 2. At the bottom of load-bearing walls or in the top of foundations where doweled to the wall; and
 3. At a maximum spacing of 120 inches (3048 mm).

Reinforcement at the top and bottom of openings, where used in determining the maximum spacing specified in Item 3 above, shall be continuous in the wall.

1908.1.5 ACI 318, Section 15.3. Modify ACI 318 by adding Section 15.3.2 to read as follows:

15.3.2 When the specified compressive strength of concrete in a column is greater than 1.4 times that specified for a floor system, the following additional requirements shall be adhered to:

1. All of the design provisions of Section 15.3 (unmodified) are adhered to.
2. The concrete construction is supervised and inspected continuously by a full-time professional engineer responsible for the concrete placement special inspection. Such professional engineer shall not delegate this responsibility to any subordinates.

1908.1.6 ACI 318, Section 17.2.3. Modify ACI 318 Sections 17.2.3.4.2, 17.2.3.4.3(d) and 17.2.3.5.2 to read as follows:

17.2.3.4.2 – Where the tensile component of the strength-level earthquake force applied to anchors exceeds 20 percent of the total factored anchor tensile force associated with the same load combination, anchors and their attachments shall be designed in accordance with 17.2.3.4.3. The anchor design tensile strength shall be determined in accordance with 17.2.3.4.4.

Exception: Anchors designed to resist wall out-of-plane forces with design strengths equal to or greater than the force determined in accordance with ASCE 7 Equation 12.11-1 or 12.14-10 shall be deemed to satisfy Section 17.2.3.4.3(d).

17.2.3.4.3(d) – The anchor or group of anchors shall be designed for the maximum tension obtained from design load combinations that include E, with E increased by Ω_0 . The anchor design tensile strength shall be calculated from 17.2.3.4.4.

17.2.3.5.2 – Where the shear component of the strength-level earthquake force applied to anchors exceeds 20 percent of the total factored anchor shear force associated with the same load combination, anchors and their attachments shall be designed in accordance with 17.2.3.5.3. The anchor design shear strength for resisting earthquake forces shall be determined in accordance with 17.5.

Exceptions:

1. For the calculation of the in-plane shear strength of anchor bolts attaching wood sill plates of bearing or nonbearing walls of light-frame wood structures to foundations or foundation stem walls, the in-plane shear strength in accordance with 17.5.2 and 17.5.3 need not be computed and 17.2.3.5.3 shall be deemed to be satisfied provided all of the following are met:
 - 1.1. The allowable in-plane shear strength of the anchor is determined in accordance with AWC NDS Table 12E for lateral design values parallel to grain.
 - 1.2. The maximum anchor nominal diameter is $\frac{5}{8}$ inch (16 mm).
 - 1.3. Anchor bolts are embedded into concrete a minimum of 7 inches (178 mm).

- 1.4. Anchor bolts are located a minimum of 1¾ inches (45 mm) from the edge of the concrete parallel to the length of the wood sill plate.
- 1.5. Anchor bolts are located a minimum of 15 anchor diameters from the edge of the concrete perpendicular to the length of the wood sill plate.
- 1.6. The sill plate is 2-inch (51 mm) or 3-inch (76 mm) nominal thickness.
- 2. For the calculation of the in-plane shear strength of anchor bolts attaching cold-formed steel track of bearing or nonbearing walls of light-frame construction to foundations or foundation stem walls, the in-plane shear strength in accordance with 17.5.2 and 17.5.3 need not be computed and 17.2.3.5.3 shall be deemed to be satisfied provided all of the following are met:
 - 2.1. The maximum anchor nominal diameter is ⅝ inch (16 mm).
 - 2.2. Anchors are embedded into concrete a minimum of 7 inches (178 mm).
 - 2.3. Anchors are located a minimum of 1¾ inches (45 mm) from the edge of the concrete parallel to the length of the track.
 - 2.4. Anchors are located a minimum of 15 anchor diameters from the edge of the concrete perpendicular to the length of the track.
 - 2.5. The track is 33 to 68 mil (0.84 mm to 1.73 mm) designation thickness.

Allowable in-plane shear strength of exempt anchors, parallel to the edge of concrete, shall be permitted to be determined in accordance with AISI S100, Section J3.3.1.

- 3. In light-frame construction bearing or non-bearing walls, shear strength of concrete anchors less than or equal to 1 inch (25 mm) in diameter attaching sill plate or track to foundation or foundation stem wall need not satisfy 17.2.3.5.3(a) through (c) when the design strength of the anchors is determined in accordance with 17.5.2.1(c).

1908.1.7 ACI 318, Section [21.1.1] 18.2.1. Modify ACI 318 Sections [21.1.1.3] 18.2.1.2 and [21.1.1.7] 18.2.1.6 to read as follows:

[21.1.1.3] 18.2.1.2 – Structures assigned to Seismic Design Category A shall satisfy requirements of Chapters 1 [~~to 19~~] through 17 and [22] 19 through 26; Chapter [24] 18 does not apply. Structures assigned to Seismic Design Category B, C, or D also shall satisfy [21.1.1.4] 18.2.1.3 through [21.1.1.8] 18.2.1.7, as applicable. Except for structural elements of plain concrete complying with Section [1908.1.8] 1908.1.2 of the *New York City Building Code*, structural elements of plain concrete are prohibited in structures assigned to Seismic Design Category C or D.

[21.1.1.7] 18.2.1.6 - Structural systems designated as part of the [~~seismic force-resisting~~] seismic force-resisting system shall be restricted to those permitted by ASCE 7 as modified

by Chapter 16 of the *New York City Building Code*. Except for Seismic Design Category A, for which Chapter ~~[21]~~ U8 does not apply, the following provisions shall be satisfied for each structural system designated as part of the ~~[seismic force-resisting]~~ seismic force-resisting system, regardless of the Seismic Design Category:

- (a) Ordinary moment frames shall satisfy ~~[21.2]~~ 18.3.
- (b) Ordinary reinforced concrete structural walls and ordinary precast structural walls need not satisfy any provisions in Chapter ~~[21]~~ 18.
- (c) Intermediate moment frames shall satisfy ~~[21.3]~~ 18.4.
- (d) Intermediate precast structural walls shall satisfy ~~[21.4]~~ 18.5.
- (e) Special moment frames shall satisfy ~~[21.5]~~ 18.6 through ~~[21.8]~~ 18.9.
- (f) Special structural walls shall satisfy ~~[21.9]~~ 18.10.
- (g) Special structural walls constructed using precast concrete shall satisfy ~~[21.10]~~ 18.11.

All special moment frames and special structural walls shall also satisfy ~~[21.1.3]~~ 18.2.4 through ~~[21.1.7]~~ 18.2.8.

~~[1908.1.3]~~ 1908.1.8 **ACI 318**, ~~[21.4]~~ **Section 18.5**. Modify ACI 318, Section ~~[21.4]~~ 18.5, by adding new **Section 18.5.2.2** and renumbering ~~[Section 21.4.3]~~ existing Sections 18.5.2.2 and 18.5.2.3 to become ~~[21.4.4 and adding new Sections 21.4.3, 21.4.5, 21.4.6, and 21.4.7 to read as follows:]~~ 18.5.2.3 and 18.5.2.4, respectively.

~~[21.4.3]~~ 18.5.2.2 – Connections that are designed to yield shall be capable of maintaining 80 percent of their design strength at the deformation induced by the design displacement or shall use Type 2 mechanical splices.

~~[21.4.4]~~ 18.5.2.3 – Elements of the connection that are not designed to yield shall develop at least $1.5 S_y$.

~~[21.4.5 – Wall piers in Seismic Design Category D shall comply with section 1908.1.4 of the *New York City Building Code*.]~~

18.5.2.4 – In structures assigned to Seismic Design Category D, wall piers shall be designed in accordance with Section 18.10.8 or 18.14 in ACI 318.

~~[21.4.6 – Wall piers not designed as part of a moment frame in buildings assigned to Seismic Design Category C shall have transverse reinforcement designed to resist the shear forces determined from 21.3.3. Spacing of transverse reinforcement shall not exceed 8 inches (203 mm). Transverse reinforcement shall be extended beyond the pier clear height for at least 12 inches (305 mm).]~~

[Exceptions:]

~~[1. Wall piers that satisfy 21.13.]~~

~~[2. Wall piers along a wall line within a story where other shear wall segments provide lateral support to the wall piers and such segments have a total stiffness of at least six times the sum of the stiffnesses of all the wall piers.]~~

~~[21.4.7—Wall segments with a horizontal length to thickness ratio less than 2.5 shall be designed as columns.]~~

[1908.1.4 ACI 318, Section 21.9. Modify ACI 318, Section 21.9.8, by deleting Section 21.9.8 and replacing with the following:]

~~[21.9.8 Wall piers and wall segments.]~~

~~[21.9.8.1 Wall piers not designed as a part of a special moment frame shall have transverse reinforcement designed to satisfy the requirements in Section 21.9.8.2.]~~

[Exceptions:]

~~[1. Wall piers that satisfy Section 21.13.]~~

~~[2. Wall piers along a wall line within a story where other shear wall segments provide lateral support to the wall piers, and such segments have a total stiffness of at least six times the sum of the stiffnesses of all the wall piers.]~~

~~[21.9.8.2 Transverse reinforcement with seismic hooks at both ends shall be designed to resist the shear forces determined from Sections 21.6.5.1.. Spacing of transverse reinforcement shall not exceed 6 inches (152 mm). Transverse reinforcement shall be extended beyond the pier clear height for at least 12 inches (305 mm).]~~

~~[21.9.8.3 Wall segments with a horizontal length to thickness ratio less than 2.5 shall be designed as columns.]~~

[1908.1.5 ACI 318, Section 21.10.2. Modify ACI 318, Section 21.10.2, to read as follows:]

1908.1.9 ACI 318, Section 18.11. Modify ACI 318, Section 18.11.2 to read as follows:

~~[21.10.2] 18.11.2.1 – Special structural walls constructed using precast concrete shall satisfy all the requirements of [21.9] Section 18.10 for cast-in-place special structural walls in addition to [Sections 21.4.2 through 21.4.4] Section 18.5.2.~~

[1908.1.6] 1908.1.10 ACI 318, Section [21.12.1.1] 18.13.1.1. Modify ACI 318, Section [21.12.1.1] 18.13.1.1, to read as follows:

~~[21.12.1.1] 18.13.1.1 Foundations resisting earthquake-induced forces or transferring earthquake-induced forces between a structure and [the] ground shall comply with the requirements of Section [21.10] 18.13 and other applicable provisions of ACI 318 unless modified by Chapter 18 of the *New York City Building Code*.~~

[1908.1.7 ACI 318, Section 22.6. Modify ACI 318, Section 22.6 by adding new 22.6.7 to read as follows:]

[22.6.7—Detailed plain concrete structural walls.]

[22.6.7.1—Detailed plain concrete structural walls are walls conforming to the requirements of ordinary structural plain concrete walls and 22.6.7.2.]

[22.6.7.2—Reinforcement shall be provided as follows:]

[(a) Vertical reinforcement of at least 0.20 square inch (129 mm²) in cross-sectional area shall be provided continuously from support to support at each corner, at each side of each opening and at the ends of walls. The continuous vertical bar required beside an opening is permitted to substitute for one of the two No. 5 bars required by 22.6.6.5.]

[(b) Horizontal reinforcement at least 0.20 square inch (129 mm²) in cross-sectional area shall be provided:]

[1. Continuously at structurally connected roof and floor levels and at the top of walls;]

[2. At the bottom of load-bearing walls or in the top of foundations where doveled to the wall; and]

[3. At a maximum spacing of 120 inches (3048 mm).]

[Reinforcement at the top and bottom of openings, where used in determining the maximum spacing specified in Item 3 above, shall be continuous in the wall.]

[1908.1.8 ACI 318, Section 22.10. Delete ACI 318, Section 22.10, and replace with the following:]

[22.10—Plain concrete in structures assigned to Seismic Design Category C or D.]

[22.10.1—Structures assigned to Seismic Design Category C or D shall not have elements of structural plain concrete, except as follows:]

[(a) Structural plain concrete basement, foundation or other walls below the base are permitted in detached one and two family dwellings three stories or less in height constructed with stud-bearing walls. In dwellings assigned to Seismic Design Category D, the height of the wall shall not exceed 8 feet (2438 mm), the thickness shall not less than 7½ inches (190 mm), and the wall shall retain no more than 4 feet (1219 mm) of unbalanced fill. Walls shall have reinforcement in accordance with 22.6.6.5.]

[(b) Isolated footings of plain concrete supporting pedestals or columns are permitted, provided the projection of the footing beyond the face of the supported member does not exceed the footing thickness.]

~~[**Exception:** In detached one and two family dwellings three stories or less in height, the projection of the footing beyond the face of the supported member is permitted to exceed the footing thickness.]~~

~~[(c) Plain concrete footings supporting walls are permitted, provided the footings have at least two continuous longitudinal reinforcing bars. Bars shall not be smaller than No. 4 and shall have a total area of not less than 0.002 times the gross cross-sectional area of the footing. For footings that exceed 8 inches (203 mm) in thickness, a minimum of one bar shall be provided at the top and bottom of the footing. Continuity of reinforcement shall be provided at corners and intersections.]~~

~~[**Exceptions:**~~

~~[1. In Seismic Design Categories A, B and C, detached one and two family dwellings three stories or less in height and constructed with stud bearing walls are permitted to have plain concrete footings without longitudinal reinforcement.]~~

~~[2. For foundation systems consisting of a plain concrete footing and a plain concrete stemwall, a minimum of one bar shall be provided at the top of the stem wall and at the bottom of the footing.]~~

~~[3. Where a slab on ground is cast monolithically with the footing, one No. 5 bar is permitted to be located at either the top of the slab or bottom of the footing.]~~

~~[1908.1.9 ACI 318, Section D.3.3. Modify ACI 318, Sections D.3.3.4.2, D.3.3.4.3(d), and D.3.3.5.2 to read as follows:]~~

~~[D.3.3.4.2—Where the tensile component of the strength level earthquake force applied to anchors exceeds 20 percent of the total factored anchor tensile force associated with the same load combination, anchors and their attachments shall be designed in accordance with D.3.3.4.3. The anchor design tensile strength shall be determined in accordance with D.3.3.4.4.]~~

~~[**Exception:** Anchors designed to resist wall out of plane forces with design strengths equal to or greater than the force determined in accordance with ASCE 7-10 Equation 12.11-1 or 12.14-10 shall be deemed to satisfy Section D.3.3.4.3(d).]~~

~~[D.3.3.4.3(d)—The anchor or group of anchors shall be designed for the maximum tension obtained from design load combinations that include E, with E increased by Ω_0 . The anchor design tensile strength shall be calculated from Section D.3.3.4.4.]~~

~~[D.3.3.5.2—Where the shear component of the strength level earthquake force applied to anchors exceeds 20 percent of the total factored anchor shear force associated with the same load combination, anchors and their attachments shall be designed in accordance with D.3.3.5.3. The anchor design shear strength for resisting earthquake forces shall be determined in accordance with D.6.]~~

[Exceptions:]

~~[1. For the calculation of the in-plane shear strength of anchor bolts attaching wood sill plates of bearing or nonbearing walls of light frame wood structures to foundations or foundation stem walls, the in-plane shear strength in accordance with D.6.2 and D.6.3 need not be computed and D.3.3.5.3 shall be deemed to be satisfied provided all of the following are met:]~~

~~[1.1. The allowable in-plane shear strength of the anchor is determined in accordance with AF&PA NDS Table 11E for lateral design values parallel to grain.]~~

~~[1.2. The maximum anchor nominal diameter is $\frac{5}{8}$ inches (16 mm).]~~

~~[1.3. Anchor bolts are embedded into concrete a minimum of 7 inches (178 mm).]~~

~~[1.4. Anchor bolts are located a minimum of $1\frac{3}{4}$ inches (45 mm) from the edge of the concrete parallel to the length of the wood sill plate.]~~

~~[1.5. Anchor bolts are located a minimum of 15 anchor diameters from the edge of the concrete perpendicular to the length of the wood sill plate.]~~

~~[1.6. The sill plate is of 2-inch or 3-inch nominal thickness.]~~

~~[2. For the calculation of the in-plane shear strength of anchor bolts attaching cold-formed steel track of bearing or nonbearing walls of light frame construction to foundations or foundation stem walls, the in-plane shear strength in accordance with D.6.2 and D.6.3 need not be computed and D.3.3.5.3 shall be deemed to be satisfied provided all of the following are met:]~~

~~[2.1. The maximum anchor nominal diameter is $\frac{5}{8}$ inches (16 mm).]~~

~~[2.2. Anchors are embedded into concrete a minimum of 7 inches (178 mm).]~~

~~[2.3. Anchors are located a minimum of $1\frac{3}{4}$ inches (45 mm) from the edge of the concrete parallel to the length of the track.]~~

~~[2.4. Anchors are located a minimum of 15 anchor diameters from the edge of the concrete perpendicular to the length of the track.]~~

~~[2.5. The track is 33 to 68 mil designation thickness. Allowable in-plane shear strength of exempt anchors, parallel to the edge of concrete, shall be permitted to be determined in accordance with AISI S100 Section E3.3.1.]~~

~~[3. In light frame construction, bearing or non-bearing walls, shear strength of concrete anchors less than or equal to 1 inch (25 mm) in diameter connecting sill plate or track to foundation or foundation stem wall need not satisfy D.3.3.5.3(a) through (c) when the design strength of the anchors is determined in accordance with D.6.2.1(c).]~~

~~[1908.1.10] 1908.1.11 [Reserved.]~~

~~[1908.1.11] ACI 318, Section [9.5.2.3] 24.2.3.5.~~ Add the following to Section [9.5.2.3] 24.2.3.5:

[^c] When calculating M_a , consideration shall be given to loads imposed during construction.^[2]

~~[1908.2 General. The text of ACI 318 shall be modified as indicated in Sections 1908.2.1 through 1908.2.4.]~~

~~[1908.2.1 ACI 318, Section 10.12. Modify ACI 318 by adding Section 10.12.4 to read as follows:]~~

~~[10.12.4 When the specified compressive strength of concrete in a column is greater than 1.4 times that specified for a floor system, the following additional requirements shall be adhered to:]~~

~~[1. All of the design provisions of Section 10.12 (unmodified) are adhered to.]~~

~~[2. The concrete construction is supervised and inspected continuously by a full time professional engineer responsible for the concrete placement special inspection. Such professional engineer shall not delegate this responsibility to any subordinates.]~~

SECTION BC 1909 STRUCTURAL PLAIN CONCRETE

1909.1 Scope. The design and construction of structural plain concrete, both cast-in-place and precast, shall comply with the minimum requirements of ~~[Section 1909 and]~~ ACI 318, ~~[Chapter 22,]~~ as modified by Section 1908 of this chapter.

~~[1909.1.1 Special structures. For special structures, such as arches, underground utility structures, gravity walls and shielding walls, the provisions of Section 1909 shall govern where applicable.]~~

~~[1909.2 Limitations. The use of structural plain concrete columns and structural plain concrete footings on piles is not permitted. In addition to the limitations set forth in Section 1908.1.8 of this chapter, the use of structural plain concrete shall otherwise be limited to:]~~

~~[1. Members that are continuously supported by soil, such as walls and footings, or by other structural members capable of providing continuous vertical support.]~~

~~[2. Members for which arch action provides compression under all conditions of loading.]~~

~~[3. Walls and pedestals.]~~

~~[1909.3 Joints. Contraction or isolation joints shall be provided to divide structural plain concrete members into flexurally discontinuous elements in accordance with ACI 318, Section 22.3.]~~

~~[1909.4 Design. Structural plain concrete walls, footings and pedestals shall be designed for adequate strength in accordance with ACI 318, Sections 22.4 through 22.8.]~~

Exception: For Group R-3 occupancies and buildings of other occupancies less than two stories above grade plane of light-frame construction, the required ~~[edge]~~ footing thickness of ACI 318 is permitted to be reduced to 6 inches (152 mm), provided that the footing does not extend more than 4 inches (102 mm) on either side of the supported wall.

~~[1909.5 Precast members. The design, fabrication, transportation and erection of precast, structural plain concrete elements shall be in accordance with ACI 318, Section 22.9.]~~

~~[1909.6 Walls. In addition to the requirements of this section, structural plain concrete walls shall comply with the applicable requirements of ACI 318, Chapter 22.]~~

~~[1909.6.1 Basement walls. The thickness of exterior basement walls and foundation walls shall be not less than $7\frac{1}{2}$ inches (191 mm).]~~

~~[1909.6.2 Other walls. Except as provided in Section 1909.6.1, the thickness of bearing walls shall be not less than $\frac{1}{24}$ the unsupported height or length, whichever is shorter, but not less than $5\frac{1}{2}$ inches (140 mm).]~~

~~[1909.6.3 Openings in walls. Not less than two No. 5 bars shall be provided around window and door openings. The bars shall be anchored to develop f_y in tension at the corners of openings.]~~

SECTION BC 1910 MINIMUM SLAB PROVISIONS

1910.1 General. The thickness of concrete floor slabs supported directly on the ground shall not be less than $3\frac{1}{2}$ inches (89 mm). A 6-mil [~~(0.006 inch; 0.152 mm)~~] (0.006 inch; 0.15 mm) polyethylene vapor retarder with joints lapped not less than 6 inches (152 mm) shall be placed between the base course or subgrade and the concrete floor slab, or other ~~[acceptable]~~ approved equivalent methods or materials shall be used to retard vapor transmission through the floor slab.

Exception: A vapor retarder is not required:

1. For detached structures accessory to occupancies in Group R-3, such as garages, utility buildings or other unheated facilities.
2. For unheated storage rooms having an area of less than 70 square feet (6.5 m²) and carports attached to occupancies in Group R-3.
3. For buildings of other occupancies where migration of moisture through the slab from below will not be detrimental to the intended occupancy of the building.
4. For drive ways, walks, patios and other flat work that will not be enclosed at a later date.
5. Where approved based on local site conditions.

**[SECTION BC 1911]
[ANCHORAGE TO CONCRETE—ALLOWABLE]
[STRESS DESIGN]**

[1911.1 Scope. The provisions of this section shall govern the allowable stress design of headed bolts and headed stud anchors cast in normal weight concrete for purposes of transmitting structural loads from one connected element to the other. These provisions do not apply to anchors installed in hardened concrete or where load combinations include earthquake loads or effects. The bearing area of headed anchors shall be not less than one and one half times the shank area. Where strength design is used, or where load combinations include earthquake loads or effects, the design strength of anchors shall be determined in accordance with Section 1912. Bolts shall conform to ASTM A 307 or an acceptable equivalent.]

[1911.2 Allowable service load. The allowable service load for headed anchors in shear or tension shall be as indicated in Table 1911.2. Where anchors are subject to combined shear and tension, the following relationship shall be satisfied:]

$$\left[\frac{(P_s/P_t)^{5/3} + (V_s/V_t)^{5/3}}{1} \leq 1 \right]$$

[(Equation 19-1)]

[where:]

[P_s = Applied tension service load, pounds (N).]

[P_t = Allowable tension service load from Table 1911.2, pounds (N).]

[V_s = Applied shear service load, pounds (N).]

[V_t = Allowable shear service load from Table 1911.2, pounds (N).]

**[TABLE 1911.2
ALLOWABLE SERVICE LOAD ON EMBEDDED BOLTS (pounds)]**

[BOLT DIAMETER (inches)]	[MINIMUM EMBEDMENT (inches)]	[EDGE DISTANCE (inches)]	[SPACING (inches)]	[MINIMUM CONCRETE STRENGTH (psi)]					
				[$f'_c=2,500$]		[$f'_c=3,000$]		[$f'_c=4,000$]	
				[Tension]	[Shear]	[Tension]	[Shear]	[Tension]	[Shear]
[$1/4$]	[$2^{1/2}$]	[$1^{1/2}$]	[3]	[200]	[500]	[200]	[500]	[200]	[500]
[$3/8$]	[3]	[$2^{1/4}$]	[$4^{1/2}$]	[500]	[1,100]	[500]	[1,100]	[500]	[1,100]
[$1/2$]	[44]	[35]	[6] [5]	[950] [1,450]	[1,250] [1,600]	[950] [1,500]	[1,250] [1,650]	[950] [1,550]	[1,250] [1,750]
[$5/8$]	[$4^{1/2}$] [$4^{3/2}$]	[$3^{3/4}$] [$6^{1/4}$]	[$7^{1/2}$] [$7^{3/2}$]	[1,500] [2,125]	[2,750] [2,950]	[1,500] [2,200]	[2,750] [3,000]	[1,500] [2,400]	[2,750] [3,050]
[$3/4$]	[5] [5]	[$4^{1/2}$] [$7^{1/2}$]	[9] [9]	[2,250] [2,825]	[3,250] [4,275]	[2,250] [2,950]	[3,560] [4,300]	[2,250] [3,200]	[3,560] [4,400]
[$7/8$]	[6]	[$5^{3/4}$]	[$10^{1/2}$]	[2,550]	[3,700]	[2,550]	[4,050]	[2,550]	[4,050]
[1]	[7]	[6]	[12]	[3,050]	[4,125]	[3,250]	[4,500]	[3,650]	[5,300]

[1 ¹ / ₈]	[8]	[6 ³ / ₄]	[13 ¹ / ₂]	[3,400]	[4,750]	[3,400]	[4,750]	[3,400]	[4,750]
[1 ¹ / ₄]	[9]	[7 ¹ / ₂]	[15]	[4,000]	[5,800]	[4,000]	[5,800]	[4,000]	[5,800]

[For SI: 1 inch = 25.4 mm, 1 pound per square inch = 0.00689MPa, 1 pound = 4.45 N.]

~~[1911.3 Required edge distance and spacing. The allowable service loads in tension and shear specified in Table 1911.2 are for the edge distance and spacing specified. The edge distance and spacing are permitted to be reduced to 50 percent of the values specified with an equal reduction in allowable service load. Where edge distance and spacing are reduced less than 50 percent, the allowable service load shall be determined by linear interpolation.]~~

~~[1911.4 Reserved.]~~

~~[1911.5 Increase for special inspection. Where special inspection is provided for the installation of anchors, a 100 percent increase in the allowable tension values of Table 1911.2 is permitted. No increase in shear value is permitted.]~~

~~[SECTION BC 1912]
[ANCHORAGE TO CONCRETE—STRENGTH DESIGN]~~

~~[1912.1 Scope. The provisions of this section shall govern the strength design of anchors installed in concrete for purposes of transmitting structural loads from one connected element to the other. Headed bolts, headed studs and hooked (J- or L-) bolts cast in concrete and expansion anchors and undercut anchors installed in hardened concrete shall be designed in accordance with Appendix D of ACI 318 as modified by Sections 1.9 and 1908.1.10, provided they are within the scope of Appendix D.]~~

~~[1912.1.1 Anchors outside scope of Appendix D. The strength design of anchors that are not within the scope of Appendix D of ACI 318, as modified by this code, shall be in accordance with a procedure subject to the approval of the commissioner.]~~

**SECTION BC ~~[1913] 1911~~
SHOTCRETE**

~~[1913.1] **1911.1 General.** Shotcrete is mortar or concrete that is pneumatically projected at high velocity onto a surface. Except as specified in this section, shotcrete shall conform to the requirements of this chapter for plain or reinforced concrete.~~

~~[1913.1.1] **1911.1.1 Qualifications.** Nozzlemen shall be ACI certified.~~

~~[1913.2] **1911.2 Proportions and materials.** Shotcrete proportions shall be selected that allow suitable placement procedures using the delivery equipment selected and shall result in finished in-place hardened shotcrete meeting the strength requirements of this code. Prior to using shotcrete, the mix design for shotcrete shall be performed by the contractor and shall be approved by the registered design professional of record. The approved mix design shall be filed with the department based upon preconstruction tests performed in accordance with Section ~~[1913.5] 1911.5.~~~~

~~[1913.3] **1911.3 Aggregate.** Coarse aggregate, if used, shall not exceed ¾ inch (19.1 mm).~~

[1913.4] 1911.4 Reinforcement. Reinforcement used in shotcrete construction shall comply with the provisions of Sections ~~[1913.4.1]~~ 1911.4.1 through ~~[1913.4.4]~~ 1911.4.4.

~~[1913.4.1]~~ 1911.4.1 Size. The maximum size of reinforcement shall be No. 5 bars unless it is demonstrated by preconstruction tests that adequate encasement of larger bars will be achieved.

~~[1913.4.2]~~ 1911.4.2 Clearance. When No. 5 or smaller bars are used, there shall be a minimum clearance between parallel reinforcement bars of 2½ inches (64 mm). When bars larger than No. 5 are permitted, there shall be a minimum clearance between parallel bars equal to six diameters of the bars used. When two curtains of steel are provided, the curtain nearer the nozzle shall have a minimum spacing equal to 12 bar diameters and the remaining curtain shall have a minimum spacing of six bar diameters.

Exception: Subject to the approval of the commissioner, required clearances shall be reduced where it is demonstrated by preconstruction tests that adequate encasement of the bars used in the design will be achieved.

~~[1913.4.3]~~ 1911.4.3 Splices. Lap splices of reinforcing bars shall utilize the noncontact lap splice method with a minimum clearance of 2 inches (51 mm) between bars. The use of contact lap splices necessary for support of the reinforcing is permitted when approved by the commissioner, based on satisfactory preconstruction tests that show that adequate encasement of the bars will be achieved, and provided that the splice is oriented so that a plane through the center of the spliced bars is perpendicular to the surface of the shotcrete.

~~[1913.4.4]~~ 1911.4.4 Spirally tied columns. Shotcrete shall not be applied to spirally tied columns.

~~[1913.5]~~ 1911.5 Preconstruction tests. A test panel shall be shot by each nozzleman and then, cured, cored or sawn, examined and tested prior to commencement of the project. The sample panel shall be representative of the project and simulate job conditions as closely as possible. The panel thickness and reinforcing shall reproduce the thickest and most congested area specified in the structural design. It shall be shot for each proposed concrete mix, at the proposed angles. The equipment used in preconstruction testing shall be the same equipment used in the work requiring such testing, unless substitute equipment is approved by the commissioner. Cores taken from the test panel shall be used to demonstrate that the proposed mix design meets the requirements of the construction documents and this code. All sampling and testing of shotcrete shall be performed by a licensed concrete testing laboratory. Construction of the test panels shall be witnessed by the special inspection agency responsible for the shotcrete construction.

~~[1913.5.1]~~ 1911.5.1 Sampling and testing. Six core samples shall be obtained from each preconstruction test panel:

1. Three specimens with no reinforcing shall be sampled and prepared in accordance with ASTM C 42; and
2. Three specimens with reinforcing steel.

[1913.5.2] 1911.5.2 Compressive strength testing. The licensed concrete testing laboratory that sampled the preconstruction test panels shall test the core specimens with no reinforcing in accordance with ASTM C 39.

[1913.5.3] 1911.5.3 Evaluation of strength tests. The shotcrete test panel strength shall be deemed acceptable if the mean compressive strength of the set of three cores shall equal or exceed f'_c with no individual core less than $0.75 f'_c$.

[1913.5.4] 1911.5.4 Visual grading of cores. Core samples and/or test panels shall be cut with reinforcing steel and shall be visually evaluated by the registered design professional of record for the structural design, or a registered design professional acceptable to the registered design professional of record for the structural design. The nozzleman shall not proceed with work if cores and/or sections cut show the rebar not to be encapsulated with concrete to the satisfaction of the registered design professional of record for the structural design.

[1913.6] 1911.6 Rebound. Any rebound or accumulated loose aggregate shall be removed from the surfaces to be covered prior to placing the initial or any succeeding layers of shotcrete. Rebound shall not be used as aggregate.

[1913.7] 1911.7 Joints. Except where permitted herein, unfinished work shall not be allowed to stand for more than 30 minutes unless edges are sloped to a thin edge. For structural elements that will be under compression and for construction joints shown on the approved construction documents, square joints are permitted. Before placing additional material adjacent to previously applied work, sloping and square edges shall be cleaned and wetted.

[1913.8] 1911.8 Damage. In-place shotcrete that exhibits sags, sloughs, segregation, honeycombing, sand pockets or other obvious defects shall be removed and replaced. Shotcrete above sags and sloughs shall be removed and replaced while still plastic.

[1913.9] 1911.9 Curing. During the curing periods specified herein, shotcrete shall be maintained above 40°F (4°C) and in moist condition.

[1913.9.1] 1911.9.1 Initial curing. Shotcrete shall be kept continuously moist for 24 hours after shotcreting is complete or shall be sealed with an approved curing compound.

[1913.9.2] 1911.9.2 Final curing. Final curing shall continue for seven days after shotcreting, or for three days if high-early-strength cement is used, or until the specified strength is obtained. Final curing shall consist of the initial curing process or the shotcrete shall be covered with an approved moisture-retaining cover.

[1913.9.3] 1911.9.3 Natural curing. Natural curing shall not be used in lieu of that specified in this section unless the relative humidity remains at or above 85 percent, and is authorized by the registered design professional of record and approved by the commissioner.

[1913.10] 1911.10 Strength tests. Strength tests for shotcrete shall be made by an approved agency on specimens that are representative of the work, and that are sampled and prepared in accordance with ASTM C 42.

[1913.10.1] 1911.10.1 Sampling. Specimens shall be taken from the in-place work or from test panels, and shall be taken at least once each shift, but not less than three cores for each 50 cubic yards (38.2 m³) of shotcrete. With the approval of the registered design professional of record, when in-place cores are not feasible due to rebar spacing, test panels shall be shot in the same position as the work represented. One panel shall be cast for each 50 cubic yards (38.2 m³) of concrete and 3 cores shall be taken per ASTM C 42.

[1913.10.2] 1911.10.2 Panel criteria. When the maximum-size aggregate is larger than 3/8 inch (9.5 mm), the test panels shall have minimum dimensions of 18 inches by 18 inches (457 mm by 457 mm). When the ~~[maximum-size]~~ maximum-size aggregate is 3/8 inch (9.5 mm) or smaller, the test panels shall have minimum dimensions of 12 inches by 12 inches (305 mm by 305 mm). Panels shall be shot in the same position as the work, during the course of the work and by the nozzlemen doing the work. The conditions under which the panels are cured shall be the same as the work.

[1913.10.3] 1911.10.3 Acceptance criteria. The average compressive strength of three cores from the in-place work tested in accordance with ASTM C 39 shall equal or exceed 0.85 f'_c with no single core less than 0.75 f'_c. The average compressive strength of three cubes taken from the in-place work or a single test panel shall equal or exceed f'_c with no individual cube less than 0.88 f'_c. To check accuracy, locations represented by erratic core or cube strengths shall be retested.

**[SECTION BC 1914]
[REINFORCED GYPSUM CONCRETE]**

[1914.1 General. Reinforced gypsum concrete shall comply with the requirements of ASTM C 317 and ASTM C 956.]

[1914.2 Minimum thickness. ~~The minimum thickness of reinforced gypsum concrete shall be 2 inches (51 mm) except the minimum required thickness shall be reduced to 1 1/2 inches (38 mm), provided the following conditions are satisfied:]~~

- ~~[1 The overall thickness, including the formboard, is not less than 2 inches (51 mm).]~~
- ~~[2. The clear span of the gypsum concrete between supports does not exceed 33 inches (838 mm).]~~
- ~~[3 Diaphragm action is not required.]~~
- ~~[4. The design live load does not exceed 40 pounds per square foot (psf) (1915 Pa).]~~

[1914.3 Limitations of use. Reinforced gypsum concrete shall not be used where exposed directly to the weather or where subject to frequent or continuous wetting. Precast units shall be protected by coverings or coatings from the weather and from contact with moisture during shipment and during storage at the work site.]

**[SECTION BC 1915]
[CONCRETE-FILLED STEEL COLUMNS]**

[1915.1 General. Concrete filled steel columns shall comply with Section 1915 and shall be filled with concrete so placed and manipulated as to secure maximum density and to ensure complete filling of the steel without voids.]

[1915.2 Design. The safe supporting capacity of concrete-filled steel columns shall be computed in accordance with ACI 318 and AISC 360 or as determined by a test approved by the commissioner.]

[1915.3 Connections. Caps, base plates and connections shall be in accordance with ACI 318 and AISC 360 and shall be positively attached to the shell and anchored to the concrete core. Welding of brackets without mechanical anchorage shall be prohibited. Where the pipe is slotted to accommodate webs of brackets or other connections, the integrity of the shell shall be restored by welding to ensure hooping action of the composite section.]

[1915.4 Reinforcement. Steel reinforcement shall be in the form of rods, structural shapes or pipe embedded in the concrete core in accordance with ACI 318 and AISC 360 with sufficient clearance to ensure the composite action of the section, but not nearer than 1 inch (25 mm) to the exterior steel shell. Structural shapes used as reinforcement shall be milled to ensure bearing on cap and base plates.]

[1915.5 Fire-resistance-rating protection. Steel columns shall be of such size or so protected as to develop the required fire-resistance ratings specified in Table 601. Where an outer steel shell is used to enclose the fire protective covering, the shell shall not be included in the calculations for strength of the column section. The minimum diameter of steel columns shall be 4 inches (102 mm) except that in structures of Type V construction not exceeding three stories or 40 feet (12 192 mm) above grade plane, steel columns used in basements and as secondary steel members shall have a minimum diameter of 3 inches (76 mm).]

[1915.5.1 Vent holes. Four minimum ½ in. (12.7 mm) diameter holes, top and bottom, shall be placed opposite each other, two at the top and two at the bottom of the column. The two bottom holes shall be rotated 90° relative to the two top holes.]

[1915.6 Approvals. Details of column connections and splices shall be shop fabricated in accordance with ACI 318 and AISC 360. Concrete filled steel columns shall be inspected by an approved agency pursuant to Chapter 17 of this code.]

**SECTION BC [1916] 1912
STRUCTURAL INTEGRITY REQUIREMENTS**

[1916.1] 1912.1 General. Reinforced concrete structures shall meet all the requirements of Sections [1916.1] 1912.1 through [1916.3] 1912.3. Concrete slabs on metal deck shall be governed by the provisions of Chapter 22. Reinforcement provided for gravity, seismic and wind forces or for other purposes may be regarded as forming part of, or the whole of, these requirements. Reinforcing provided for one requirement may be counted towards the other requirements.

[1916.2] 1912.2 Continuity and ties. The structural integrity requirements of ACI 318, ~~[Section]~~ Sections ~~[4.3.3.8.5 and 7.13]~~ 4.10 and 8.7.4.2, shall apply. In addition, the following requirements shall be met.

[1916.2.1] 1912.2.1 Slab reinforcement. At all floor and roof levels, slabs shall have a mat of bottom reinforcement in two perpendicular (or roughly perpendicular) directions. Reinforcement in this bottom mat shall be made continuous with lap, mechanical or welded tension splices.

[1916.2.1.1] 1912.2.1.1 Bottom mat reinforcement. In each direction, the bottom mat reinforcement shall be not less than, the steel required for temperature reinforcement. The bottom mat reinforcement shall be anchored at discontinuous edges within the column strip, reentrant corners, elevation changes and anywhere else the continuity of the reinforcing is interrupted.

Exception: Flat plate middle strip bottom mat reinforcing perpendicular to discontinuous slab edges. In addition, the main bottom mat reinforcement in one-way slabs shall be anchored at discontinuous edges.

[1916.2.2] 1912.2.2 Peripheral ties. At each floor and roof level, reinforcement forming a continuous peripheral tie shall be provided. Peripheral ties shall be located within perimeter beams or walls, where they occur, or within 4 feet (1219 mm) of the edge of slab, where perimeter beams or walls do not occur. Continuous tie reinforcement shall be equal to half of the bottom reinforcement within the edge or edge strip for two-way slabs but not less than two bars.

[1916.2.3] 1912.2.3 Horizontal ties. At each column, beam reinforcement or slab bottom reinforcement shall be provided at each level that can develop a tension force equal to the maximum of Item 1 or 2:

1. Three times the load entering the column at that level, using a load combination of $1.0 \times DL$ (self weight of structure only).
2. One and a half times the load entering the column at that level using the load combinations of $(1.2 DL + 1.6 LL)$ or $1.4 DL$.
3. For transfer elements only, in lieu of Item 1 or 2, the horizontal reinforcement shall be anchored at all supports.

[1916.2.3.1] 1912.2.3.1 Bottom reinforcing. This beam or slab bottom reinforcement shall be distributed around the column perimeter and shall be extended on all sides of the column into the adjacent slab for at least one-third of the span length. Where reinforcing bars cannot be extended beyond the column (e.g., at slab edges and openings), they shall be hooked or otherwise developed within the column.

[1916.2.4] 1912.2.4 Vertical ties. Each column and each wall carrying vertical load shall be vertically tied continuously from its lowest to highest level. The vertical ties composed of vertical column reinforcement shall be capable of resisting a tensile force equal to the maximum design dead and live load received by the column or wall from any one story within four floors below. A concrete compression element subjected to load reversal may have a reinforcing bar splice

length equal to the tension splice length required by ACI 318 reduced by the ratio of A_s required/ A_s , provided but not less than the splice required for compression.

~~[1916.3]~~ **1912.3 Precast concrete general.** Precast concrete structural elements shall be reinforced to meet all of the requirements of this section. However, reinforcement provided for gravity, seismic and wind forces and for other purposes may be regarded as forming part of, or the whole of, these requirements. Reinforcing provided for one requirement may be counted towards the other requirements.

~~[1916.3.1]~~ **1912.3.1 Continuity and ties.** The structural integrity requirements of ACI 318, Section ~~[46.5]~~ 4.10, shall apply. In precast and composite structures, ties within precast structural elements shall be continuous and shall be anchored to the supporting structure. In addition to Sections ~~[1916.2.2]~~ 1912.2.2 and ~~[1916.2.4]~~ 1912.2.4, the following requirements shall be met.

~~[1916.3.1.1]~~ **1912.3.1.1 End connections.** End connections of all precast slabs, beams and girders shall have an axial tension capacity equal to the larger of the vertical shear capacity of the connection at either end, or at least 2 percent of the maximum factored vertical dead and live load in the precast compression element, whichever is larger, but not less than 20 kips or 2,500 pounds per linear foot of slab (36.48 kN/m). Where more than one element frames in one direction, none of the elements or connections shall have an axial tension capacity of less than 1 percent of the column load but not less than 20 kips.

~~[1916.3.1.2]~~ **1912.3.1.2 Side connections.** Side connections of all precast elements shall have an axial tension capacity not less than the steel required for temperature reinforcement of the larger element at either side.

~~[1916.3.1.3]~~ **1912.3.1.3 Connection forces.** For design of the connections, the transverse shear force and the axial tensile force need not be considered to act simultaneously.

~~[1916.3.2]~~ **1912.3.2 Joints.** Joints in precast structures shall not rely on friction due to gravity to transfer load.

~~[1916.3.3]~~ **1912.3.3 Bearing.** The net bearing area shall not be less than 2 inches (51 mm) wide and 3 inches (76 mm) long in the direction of the member.

SECTION BC ~~[1917]~~ 1913 **ASPHALT PAVING**

~~[1917.1]~~ **1913.1 Definitions.** The following ~~[words and]~~ terms ~~[shall, for the purposes of this section, have the meanings shown herein]~~ are defined in Chapter 2.

ASPHALT. ~~[A dark brown to black bitumen pitch that melts readily and which appears in nature in asphalt beds or is produced as a by-product of the petroleum industry.]~~

ASPHALTIC CONCRETE or ASPHALT PAVING. ~~[A mixture of liquid asphalt and graded aggregate used as a paving material.]~~

I-4 MIX. [~~A type of heavy duty asphaltic concrete mix containing 0.75 inch (19 mm) nominal maximum size aggregate with 25 percent to 50 percent of the aggregate capable of passing through a No. 8 sieve and in which all sand contained in the mix is crushed.~~]

RECLAIMED ASPHALT PAVEMENT. [~~Asphalt pavement that has been processed for reuse in asphaltic concrete.~~]

[~~1917.2~~ 1913.2 Reclaimed asphalt pavement content in asphaltic concrete. [~~On and after January 1, 2015, asphaltic~~] Asphaltic concrete, other than I-4 mix or other approved heavy duty asphaltic concrete mix, shall contain not less than 30 percent reclaimed asphalt pavement, as measured by weight. I-4 mix or other approved heavy duty asphaltic concrete mix shall contain not less than 10 percent reclaimed asphalt pavement, as measured by weight. Reclaimed asphalt paving used in asphaltic concrete shall comply with ASTM D692 or ASTM D1073.

Exceptions:

1. Asphaltic concrete used in a project where the content of asphaltic concrete is governed by a federal or state law, rule, regulation, guideline, or specification that requires a different composition.
2. Asphaltic concrete used for runways, taxiways, or other surfaces utilized by aircraft.
3. The commissioner may waive compliance with this section if the commissioner, after consulting with the commissioner of transportation and the owners or persons in charge of all asphalt plants located within the city, finds that a sufficient supply of reclaimed asphalt pavement is not available.

§ 21. Chapter 21 of the New York city building code, as added by local law number 33 for the year 2007, sections 2101.2, 2101.2.1, 2101.2.2, 2101.2.3, 2101.2.4, 2101.2.5, 2101.2.6, 2101.3, 2101.3.1, 2102.1, 2103.1, 2103.2, 2103.4, 2103.5, 2103.6, 2103.7, 2103.8, 2103.9, 2103.10, 2103.10.1, 2103.10.2, 2103.10.3, 2103.10.4, 2103.10.5, 2103.10.6, 2103.10.7, 2103.13, 2104.1, 2104.1.1, 2104.1.2, 2104.1.3, 2104.1.5, 2104.2, 2104.3, 2104.3.1, 2104.4, 2105.2.1, 2105.2.2.1.1, 2105.2.2.1.2, 2106.1, 2106.1.1, 2107, 2107.1, 2108.1, 2109.1, 2109.1.1, 2109.2, 2109.2.1, 2109.2.2, 2109.5.3, 2109.7, 2109.7.1, 2109.7.2, 2110.1, 2110.1.1, 2111.2, 2111.2, 2111.3.1, 2111.4, 2111.8, 2112.1, 2112.2, 2112.4, 2113.1, 2113.1.6, 2113.3, 2113.4, 2113.9, 2113.11.1, 2113.11.1.2, 2113.12, 2113.15, and 2113.19, and tables 2103.10, 2105.2.2.1.1, 2109.2.1, 2109.5.3, 2113.16(2) as amended by, and sections 2103.3, 2103.11, 2103.12, 2104.6, 2104.7, 2104.8, 2104.8.1, 2104.8.2, 2104.9, 2104.9.1, 2104.9.1.1, 2104.9.1.2, 2104.9.1.3, 2104.10, 2104.10.1, 2104.10.2, 2104.11, 2104.12,

2105.2.2.1.3, 2105.4, 2107.2, 2107.3, 2107.4, 2107.5, 2108.2, 2108.3, 2109.3, 2109.4, 2109.6, 2111.2.2, 2112.3, and 2112.5, and figures 2113.16 and 2113.19 as added by, local law 141 for the year 2013, and section 2111.1 as amended by local law 38 for the year 2015, is amended to read as follows:

CHAPTER 21 MASONRY

SECTION BC 2101 GENERAL

2101.1 Scope. This chapter shall govern the materials, design, construction and quality of masonry.

2101.1.1 Referenced standards. Where this code makes reference to the nationally recognized standard TMS 402, such standard shall be as modified for New York City in accordance with this chapter.

2101.2 Design methods. Masonry shall comply with the provisions of [~~one of the following design methods in this chapter~~] TMS 402, TMS 403 or TMS 404, as well as the applicable requirements of [~~Sections 2101 through 2104. Masonry designed by the allowable stress design provisions of Section 2101.2.1, the strength design provisions of Section 2101.2.2 or the prestressed masonry provisions of Section 2101.2.3 shall comply with Section 2105 for quality assurance~~] this chapter.

~~[2101.2.1 Allowable stress design. Masonry designed by the allowable stress design method shall comply with the provisions of Sections 2106 and 2107.]~~

~~[2101.2.2 Strength design. Masonry designed by the strength design method shall comply with the provisions of Sections 2106 and 2108, except that autoclaved aerated concrete (AAC) masonry shall comply with the provisions of Section 2106 of this code, and Chapter 1 and Appendix A of TMS 402/ACI 530/ASCE 5.]~~

~~[2101.2.3 Prestressed masonry. Prestressed masonry shall be designed in accordance with Chapters 1 and 4 of TMS 402/ACI 530/ASCE 5 and Section 2106 of this code. Special inspection during construction shall be provided as set forth in Section 1704.5.]~~

~~[2101.2.4 Empirical design. Masonry designed by the empirical design method shall comply with the provisions of Sections 2106 and 2109 of this code or Chapter 5 of TMS 402/ACI 530/ASCE 5.]~~

~~[2101.2.5 Glass masonry. Glass masonry shall comply with the provisions of Section 2110 of this code or with the requirements of Chapter 7 of TMS 402/ACI 530/ASCE 5.]~~

~~[2101.2.6 2101.2.1 Masonry veneer. Masonry veneer shall comply with the provisions of Chapter 14[~~of this code or Chapter 6 or TMS 402/ACI 530/ASCE 5~~].~~

~~[2101.3 Construction documents. The construction documents shall show all of the items required by this code including the following:]~~

- ~~[1. Specified size, grade, type and location of reinforcement, anchors and wall ties.]~~
- ~~[2. Reinforcing bars to be welded and welding procedure.]~~
- ~~[3. Size and location of structural elements.]~~
- ~~[4. Provisions for dimensional changes resulting from elastic deformation, creep, shrinkage, temperature and moisture.]~~
- ~~[5. Specified compressive strength of masonry at stated ages or stages of construction for which masonry is designed, except where specifically exempted by this code.]~~
- ~~[6. Details of anchorage of masonry to structural members, including the type, size and location of connectors.]~~
- ~~[7. The minimum level of testing and inspection as defined in Chapter 17, or an itemized testing and inspection program that meets or exceeds the requirements of Chapter 17.]~~

2101.3 Special inspection. The special inspection of masonry shall be as defined in Chapter 17, or an itemized testing and inspection program shall be provided that meets or exceeds the requirements of Chapter 17.

~~[2101.3.1 Fireplace drawings. The construction documents shall describe in sufficient detail the location, size and construction of masonry fireplaces. The thickness and characteristics of materials and the clearances from walls, partitions and ceilings shall be clearly indicated. The masonry fireplace shall comply with the provisions of Section 2111.]~~

SECTION BC 2102 DEFINITIONS AND NOTATIONS

2102.1 General. The following [words and] terms [shall, for the purposes of this chapter and as used elsewhere] are defined in [this code, have the meanings shown herein.] Chapter 2:

AAC MASONRY. [Masonry made of autoclaved aerated concrete (AAC) units, manufactured without internal reinforcement and bonded together using thin or thick bed mortar.]

~~[ANCHOR. Metal rod, wire or strap that secures masonry to its structural support.]~~

ARCHITECTURAL TERRA COTTA. [Plain or ornamental hard burned modified clay units, larger in size than brick, with glazed or unglazed ceramic finish.]

AREA.

[Bedded. The area of the surface of a masonry unit that is in contact with mortar in the plane of the joint.]

Gross cross-sectional. [The area delineated by the out-to-out specified dimensions of masonry in the plane under consideration.]

Net cross-sectional. [The area of masonry units, grout and mortar crossed by the plane under consideration based on out-to-out specified dimensions.]

AUTOCLAVED AERATED CONCRETE (AAC). [Low-density cementitious product of calcium silicate hydrates, whose material specifications are defined in ASTM C 1386.]

BED JOINT. [The horizontal layer of mortar on which a masonry unit is laid.]

[BOND BEAM. A horizontal grouted element within masonry in which reinforcement is embedded.]

[BOND REINFORCING. The adhesion between steel reinforcement and mortar or grout.]

BRICK.

Calcium silicate (sand lime brick). [A masonry unit made of sand and lime.]

Clay or shale. [A masonry unit made of clay or shale, usually formed into a rectangular prism while in the plastic state and burned or fired in a kiln.]

Concrete. [A masonry unit having the approximate shape of a rectangular prism and composed of inert aggregate particles embedded in a hardened cementitious matrix.]

[BUTTRESS. A projecting part of a masonry wall built integrally therewith to provide lateral stability.]

CAST STONE. [A building stone manufactured from portland cement concrete precast and used as a trim, veneer or facing on or in buildings or structures.]

CELL. [A void space having a gross cross-sectional area greater than 1¹/₂ square inches (967 mm²).]

CHIMNEY. [A primarily vertical enclosure containing one or more flues used to remove hot gases from burning fuel, refuse, or from industrial processes to the outside atmosphere.]

Factory-built chimney.

Masonry chimney.

Metal chimney.

CHIMNEY TYPES.

High-heat appliance type. [An approved chimney for removing the products of combustion from fuel burning, high heat appliances producing combustion gases in excess of 2,000°F (1093°C) measured at the appliance flue outlet (see Section 2113.11.3).]

Low-heat appliance type. [An approved chimney for removing the products of combustion from fuel burning, low heat appliances producing combustion gases not in excess of 1,000°F (538°C) under normal operating conditions, but capable of producing combustion gases of 1,400°F (760°C) during intermittent forced firing for periods up to 1 hour. Temperatures shall be measured at the appliance flue outlet.]

[Masonry type. A field constructed chimney of solid masonry units or stones.]

Medium-heat appliance type. [An approved chimney for removing the products of combustion from fuel burning, medium heat appliances producing combustion gases between 1000°F (538°C) and 2,000°F (1093°C) measured at the appliance flue outlet (see Section 2113.11.2).]

[CLEANOUT. An opening to the bottom of a grout space of sufficient size and spacing to allow the removal of debris.]

COLLAR JOINT. [Vertical longitudinal joint between wythes of masonry or between masonry and backup construction that is permitted to be filled with mortar or grout.]

[COMPRESSIVE STRENGTH OF MASONRY. Maximum compressive force resisted per unit of net cross-sectional area of masonry, determined by the testing of masonry prisms or a function of individual masonry units, mortar and grout.]

[CONNECTOR. A mechanical device for securing two or more pieces, parts or members together, including anchors, wall ties and fasteners.]

[COVER. Distance between surface of reinforcing bar and edge of member.]

DECORATIVE SHROUD.[A listed partial noncombustible enclosure for aesthetic purposes that is installed at the termination of a venting system that surrounds or conceals the chimney or vent cap.]

DIMENSIONS.

[Actual. The measured dimension of a masonry unit or element.]

Nominal. [The specified dimension plus an allowance for the joints with which the units are to be laid. Thickness is given first, followed by height and then length.]

Specified. [The dimensions specified for the manufacture or construction of masonry, masonry units, joints or any other component of a structure.]

FIREPLACE. [A hearth and fire chamber or similar prepared place in which a fire may be made and which is built in conjunction with a chimney.]

FIREPLACE THROAT. [The opening between the top of the firebox and the smoke chamber.]

FLUE. [A passageway within a chimney or vent through which gaseous combustion products pass.]

FLUE, APPLIANCE. [The passage(s) within an appliance through which combustion products pass from the combustion chamber of the appliance to the draft hood inlet opening on an appliance

equipped with a draft hood or to the outlet of the appliance on an appliance not equipped with a draft hood.]

FLUE GASES. [Products of combustion plus excess air in appliance flues or heat exchangers.]

FLUE LINER (LINING). [A system or material used to form the inside surface of a flue in a chimney or vent, for the purpose of protecting the surrounding structure from the effects of combustion products and for conveying combustion products without leakage into the atmosphere.]

FOUNDATION PIER. [An isolated vertical foundation member whose horizontal dimension measured at right angles to its thickness does not exceed three times its thickness and whose height is equal to or less than four times its thickness.]

GROUT. [A plastic mixture of cementitious materials, aggregates, and water, with or without admixtures, initially produced to pouring consistency without segregation of the constituents during placement, or the equivalent of such mixtures, conforming to ASTM C 476.]

[GROUTED MASONRY.]

~~[Grouted hollow-unit masonry. That form of grouted masonry construction in which certain designated cells of hollow units are continuously filled with grout.]~~

~~[Grouted multi-wythe masonry. That form of grouted masonry construction in which the space between the wythes is solidly or periodically filled with grout.]~~

HEAD JOINT. [Vertical mortar joint placed between masonry units within the wythe at the time the masonry units are laid.]

[HEIGHT, WALLS. The vertical distance from the foundation wall or other immediate support of such wall to the top of the wall.]

MASONRY. [A built-up construction or combination of building units or materials of clay, shale, concrete, glass, gypsum, stone or other approved units bonded together with or without mortar or grout or other accepted method of joining.]

~~[Ashlar masonry. Masonry composed of various sized rectangular units having sawed, dressed or squared bed surfaces, properly bonded and laid in mortar.]~~

~~[Coursed ashlar. Ashlar masonry laid in courses of stone of equal height for each course, although different courses shall be permitted to be of varying height.]~~

Glass unit masonry. [masonryMasonry composed of glass units bonded by mortar.]

~~Plain masonry. [Masonry in which the tensile resistance of the masonry is taken into consideration and the effects of stresses in reinforcement are neglected.]~~

~~[Random ashlar. Ashlar masonry laid in courses of stone set without continuous joints and laid up without drawn patterns. When composed of material cut into modular heights, discontinuous but aligned horizontal joints are discernible.]~~

Reinforced masonry. [~~Masonry construction in which reinforcement acting in conjunction with the masonry is used to resist forces.~~]

Solid masonry. [~~Masonry consisting of solid masonry units laid contiguously with the joints between the units filled with mortar.~~]

Unreinforced (plain) masonry. [~~Masonry in which the tensile resistance of masonry is taken into consideration and the resistance of the reinforcing steel, if present, is neglected.~~]

MASONRY UNIT. [~~Brick, tile, stone, glass block or concrete block conforming to the requirements specified in Section 2103.~~]

[~~**Clay.** A building unit larger in size than a brick, composed of burned clay, shale, fired clay or mixtures thereof.~~]

[~~**Concrete.** A building unit or block larger in size than 12 inches by 4 inches by 4 inches (305 mm by 102 mm by 102 mm) made of cement and suitable aggregates.~~]

[~~**Hollow.** A masonry unit whose net cross-sectional area in any plane parallel to the load-bearing surface is less than 75 percent of its gross cross-sectional area measured in the same plane.~~]

[~~**Solid.** A masonry unit whose net cross-sectional area in every plane parallel to the load-bearing surface is 75 percent or more of its gross cross-sectional area measured in the same plane.~~]

MORTAR. [~~A plastic mixture of approved cementitious materials, fine aggregates and water used to bond masonry or other structural units.~~]

MORTAR, SURFACE-BONDING. [~~A mixture to bond concrete masonry units that contains hydraulic cement, glass fiber reinforcement with or without inorganic fillers or organic modifiers and water.~~]

PRESTRESSED MASONRY. [~~Masonry in which internal stresses have been introduced to counteract potential tensile stresses in masonry resulting from applied loads.~~]

[~~**PRISM.** An assemblage of masonry units and mortar with or without grout used as a test specimen for determining properties of the masonry.~~]

[~~**RUBBLE MASONRY.** Masonry composed of roughly shaped stones.~~]

[~~**Coursed rubble.** Masonry composed of roughly shaped stones fitting approximately on level beds and well bonded.~~]

[~~**Random rubble.** Masonry composed of roughly shaped stones laid without regularity of coursing but well bonded and fitted together to form well-divided joints.~~]

[~~**Rough or ordinary rubble.** Masonry composed of unsquared field stones laid without regularity of coursing but well bonded.~~]

RUNNING BOND. [The placement of masonry units such that head joints in successive courses are horizontally offset at least one quarter the unit length.]

[SHEAR WALL.]

~~[Detailed plain masonry shear wall. A masonry shear wall designed to resist lateral forces neglecting stresses in reinforcement, and designed in accordance with Section 2106.1.]~~

~~[Intermediate reinforced masonry shear wall. A masonry shear wall designed to resist lateral forces considering stresses in reinforcement, and designed in accordance with Section 2106.1.]~~

~~[Ordinary plain masonry shear wall. A masonry shear wall designed to resist lateral forces neglecting stresses in reinforcement, and designed in accordance with Section 2106.1.]~~

~~[Prestressed masonry shear wall. A prestressed masonry shear wall designed to resist lateral forces considering stresses in reinforcement, and designed in accordance with Section 2106.1.1.1.]~~

~~[Ordinary reinforced masonry shear wall. A masonry shear wall designed to resist lateral forces considering stresses in reinforcement, and designed in accordance with Section 2106.1.]~~

[SHELL. The outer portion of a hollow masonry unit as placed in masonry.]

[SPECIFIED. Required by construction documents.]

SPECIFIED COMPRESSIVE STRENGTH OF MASONRY, f'_m . [Minimum compressive strength, expressed as force per unit of net cross sectional area, required of the masonry used in construction by the construction documents, and upon which the project design is based. Whenever the quantity f'_m is under the radical sign, the square root of numerical value only is intended and the result has units of pounds per square inch (psi) (Mpa).]

~~**[STACK BOND.** The placement of masonry units in a bond pattern is such that head joints in successive courses are vertically aligned. For the purpose of this code, requirements for stack bond shall apply to masonry laid in other than running bond.]~~

STONE MASONRY. [Masonry composed of field, quarried or cast stone units bonded by mortar.]

~~[Ashlar stone masonry. Stone masonry composed of rectangular units having sawed, dressed or squared bed surfaces and bonded by mortar.]~~

~~[Rubble stone masonry. Stone masonry composed of irregular shaped units bonded by mortar.]~~

STRENGTH.

Design strength. [Nominal strength multiplied by a strength reduction factor.]

Nominal strength. [Strength of a member or cross section calculated in accordance with these provisions before application of any strength reduction factors.]

Required strength. [Strength of a member or cross section required to resist factored loads.]

~~[**THIN-BED MORTAR.** Mortar for use in construction of AAC unit masonry with joints 0.06 inch (1.5 mm) or less.]~~

~~[**TIE, LATERAL.** Loop of reinforcing bar or wire enclosing longitudinal reinforcement.]~~

~~**TIE, WALL.** [A connector that connects wythes of masonry walls together.]~~

~~[**TILE.** A ceramic surface unit, usually relatively thin in relation to facial area, made from clay or a mixture of clay or other ceramic materials, called the body of the tile, having either a “glazed” or “unglazed” face and fired above red heat in the course of manufacture to a temperature sufficiently high enough to produce specific physical properties and characteristics.]~~

~~**TILE, STRUCTURAL CLAY.** [A hollow masonry unit composed of burned clay, shale, fire clay or mixture thereof, and having parallel cells.]~~

~~**WALL.**[A vertical element with a horizontal length to thickness ratio greater than three, used to enclose space.]~~

~~**Cavity wall.** [A wall built of masonry units or of concrete, or a combination of these materials, arranged to provide an airspace within the wall, and in which the inner and outer parts of the wall are tied together with metal ties.]~~

~~[**Composite wall.** A wall built of a combination of two or more masonry units bonded together, one forming the backup and the other forming the facing elements.]~~

~~**Dry-stacked, surface-bonded walls.** [A wall built of concrete masonry units where the units are stacked dry, without mortar on the bed or head joints, and where both sides of the wall are coated with a surface bonding mortar.]~~

~~[**Masonry-bonded hollow wall.** A wall built of masonry units so arranged as to provide an airspace within the wall, and in which the facing and backing of the wall are bonded together with masonry units.]~~

~~**Parapet wall.** [The part of any wall entirely above the roof line.]~~

~~[**WEB.** An interior solid portion of a hollow masonry unit as placed in masonry.]~~

~~**WYTHER.** [Each continuous, vertical section of a wall, one masonry unit in thickness.]~~

NOTATIONS.

d_b = Diameter of reinforcement. inches (mm).

F_s = Allowable tensile or compressive stress in reinforcement. psi (MPa).

f_r = Modulus of rupture, psi (MPa).

f'_{AAC} = Specified compressive strength of AAC masonry, the minimum compressive strength for a class of AAC masonry as specified in ASTM C 1386. psi (MPa).

f'_m	=	Specified compressive strength of masonry at age of 28 days. psi (MPa).
f'_{mi}	=	Specified compressive strength of masonry at the time of prestress transfer, psi
K	=	The lesser of the masonry cover, clear spacing between adjacent reinforcement, or five times d_b , inches (mm).
L_s	=	Distance between supports, inches (mm).
l_d	=	Required development length or lap length of reinforcement. inches (mm).
P	=	The applied load at failure. pounds (N).
S_t	=	Thickness of the test specimen measured parallel to the direction of load. inches
S_w	=	Width of the test specimen measured parallel to the loading cylinder, inches (mm).

SECTION BC 2103 MASONRY CONSTRUCTION MATERIALS

2103.1 ~~[Concrete masonry]~~ Masonry units. Concrete masonry units [~~shall conform to the following standards: ASTM C 55 for concrete brick; ASTM C 73 for calcium silicate face brick; ASTM C 90 for load bearing concrete masonry units; ASTM C 129 for nonload bearing concrete masonry units or ASTM C 744 for prefaced concrete and calcium silicate masonry units~~], clay or shale masonry units, stone masonry units, glass unit masonry and AAC masonry units shall comply with Article 2.3 of TMS 602. Architectural cast stone shall conform to ASTM C1364 and TMS 504. Adhered manufactured stone masonry veneer units shall conform to ASTM C1670.

~~**[2103.2 Clay or shale masonry units.** Clay or shale masonry units shall conform to the following standards: ASTM C 34 for structural clay load bearing wall tile; ASTM C 56 for structural clay nonload bearing wall tile; ASTM C 62 for building brick (solid masonry units made from clay or shale); ASTM C 1088 for solid units of thin veneer brick; ASTM C 126 for ceramic glazed structural clay facing tile, facing brick and solid masonry units; ASTM C 212 for structural clay facing tile; ASTM C 216 for facing brick (solid masonry units made from clay or shale); ASTM C 652 for hollow brick (hollow masonry units made from clay or shale) and ASTM C 73 for calcium silicate face brick or ASTM C 1405 for glazed brick (single fired solid brick units).]~~

Exception: Structural clay tile for nonstructural use in fireproofing of structural members and in wall furring shall not be required to meet the compressive strength specifications. The fire-resistance rating shall be determined in accordance with ASTM E 119 or UL 263 and shall comply with the requirements of Table 602 of this code.

~~**[2103.3 AAC masonry.** AAC masonry units shall conform to ASTM C 1386 for the strength class specified.]~~

~~**[2103.4 Stone masonry units.** Stone masonry units shall conform to the following standards: ASTM C 503 for marble building stone (exterior); ASTM C 568 for limestone building stone; ASTM C 615 for granite building stone; ASTM C 616 for sandstone building stone or ASTM C 629 for slate building stone.]~~

~~**[2103.5 Ceramic tile.** Ceramic tile shall be as defined in, and shall conform to the requirements of, ANSI A137.1]~~

~~[2103.6 Glass unit masonry. Hollow glass units shall be partially evacuated and have a minimum average glass face thickness of $\frac{3}{16}$ inch (4.8 mm). Solid glass block units shall be provided when required. The surfaces of units intended to be in contact with mortar shall be treated with a polyvinyl butyral coating or latex-based paint. Reclaimed units shall not be used.]~~

~~[2103.7] **2103.1.1 Second-hand units.** Second-hand masonry units shall not be reused unless they conform to the requirements of new units. The units shall be of whole, sound materials and free from cracks and other defects that will interfere with proper laying or use. Old mortar shall be cleaned from the unit before reuse.~~

~~**Exception:** Second-hand masonry units need not conform to the requirements for new units when their reuse is to comply with historic restoration standards or requirements of the New York City Landmarks Preservation Commission or the New York State Historic Preservation Office.~~

~~[2103.8] **2103.2 Mortar.** Mortar for masonry construction shall comply with Section 2103.2.1, 2103.2.2, 2103.2.3 or 2103.2.4.~~

~~**2103.2.1 Masonry mortar.** Mortar for use in masonry construction shall conform to [ASTM C 270 and] Articles 2.1 and 2.6A of TMS 602[/ACI 530/ASCE 6, except for mortars listed in Sections 2103.9, 2103.10, and 2103.11 of this code. Type S or N mortar conforming to ASTM C 270 shall be used for glass unit masonry].~~

~~[2103.9] **2103.2.2 Surface-bonding mortar.** Surface-bonding mortar shall comply with ASTM C 887. Surface bonding of concrete masonry units shall comply with ASTM C 946.~~

~~[2103.10] **2103.2.3 Mortars for ceramic wall and floor tile.** Portland cement mortars for installing ceramic wall and floor tile shall comply with ANSI A108.1A and ANSI A108.1B and be of the compositions indicated in Table [2103.10] 2103.2.3.~~

**TABLE [2103.10] 2103.2.3
CERAMIC TILE MORTAR COMPOSITIONS**

LOCATION	MORTAR	COMPOSITION
Walls	Scratchcoat	1 cement; 1/5 hydrated lime; 4 dry or 5 damp sand
	Setting bed and leveling coat	1 cement; 1/2 hydrated lime; 5 damp sand to 1 cement 1 hydrated lime, 7 damp sand
Floors	Setting bed	1 cement; 1/10 hydrated lime; 5 dry or 6 damp sand; or 1 cement; 5 dry or 6 damp sand
Ceilings	Scratchcoat and sand bed	1 cement; 1/2 hydrated lime; 2 1/2 dry sand or 3 damp sand

[2103.10.1] 2103.2.3.1 Dry-set portland cement mortars. Premixed prepared portland cement mortars, which require only the addition of water and are used in the installation of ceramic tile, shall comply with ANSI A118.1. The shear bond strength for tile set in such mortar shall be as required in accordance with ANSI A118.1. Tile set in dry-set portland cement mortar shall be installed in accordance with ANSI A108.5.

[2103.10.2] 2103.2.3.2 Latex-modified portland cement mortar. Latex-modified portland cement thin-set mortars in which latex is added to dry-set mortar as a replacement for all or part of the gauging water that are used for the installation of ceramic tile shall comply with ANSI A118.4. Tile set in latex-modified portland cement shall be installed in accordance with ANSI A108.5.

[2103.10.3] 2103.2.3.3 Epoxy mortar. Ceramic tile set and grouted with chemical-resistant epoxy shall comply with ANSI A118.3. Tile set and grouted with epoxy shall be installed in accordance with [ANSI A 108.6] ANSI A108.6.

[2103.10.4] 2103.2.3.4 Furan mortar and grout. Chemical-resistant furan mortar and grout that are used to install ceramic tile shall comply with ANSI A118.5. Tile set and grouted with furan shall be installed in accordance with ANSI A108.8.

[2103.10.5] 2103.2.3.5 Modified epoxy-emulsion mortar and grout. Modified epoxy-emulsion mortar and grout that are used to install ceramic tile shall comply with ANSI A118.8. Tile set and grouted with modified epoxy-emulsion mortar and grout shall be installed in accordance with ANSI A108.9.

[2103.10.6] 2103.2.3.6 Organic adhesives. Water-resistant organic adhesives used for the installation of ceramic tile shall comply with ANSI A136.1. The shear bond strength after water immersion shall be not [be] less than 40 psi (275 kPa) for Type I adhesive[;] and not less than 20 psi (138 kPa) for Type II adhesive when tested in accordance with ANSI A136.1. Tile set in organic adhesives shall be installed in accordance with ANSI A108.4.

[2103.10.7] 2103.2.3.7 Portland cement grouts. Portland cement grouts used for the installation of ceramic tile shall comply with ANSI A118.6. Portland cement grouts for tile work shall be installed in accordance with ANSI A108.10.

~~[2103.11 Mortar for AAC masonry. Thin bed mortar for AAC masonry shall comply with Article 2.1C.1 of TMS 602/ACI 530.1/ASCE 6. Mortar used for the leveling courses of AAC masonry shall comply with Article 2.1C.2 of TMS 602/ACI 530.1/ASCE 6.]~~

2103.2.4 Mortar for adhered masonry veneer. Mortar for use with adhered masonry veneer shall conform to ASTM C 270 for Type N or S, or shall comply with ANSI A118.4 for latex-modified portland cement mortar.

~~[2103.12] 2103.3 Grout.~~ Grout shall comply with Article 2.2 of TMS 602~~[/ACI 530.1/ASCE 6.]~~

~~[2103.13] 2103.4 Metal reinforcement and accessories.~~ Metal reinforcement and accessories shall conform to Article 2.4 of TMS 602~~[/ACI 530.1/ASCE 6.]~~. Where unidentified reinforcement is approved for use, not less than three tension and three bending tests shall be made on representative specimens of the reinforcement from each shipment and grade of reinforcing steel proposed for use in the work.

SECTION BC 2104 CONSTRUCTION

2104.1 Masonry construction. Masonry construction shall comply with the requirements of Sections 2104.1.1 through ~~[2104.5 and with]~~ 2104.10, TMS 402, and TMS 602~~[/ACI 530.1/ASCE 6.]~~ or TMS 604.

~~[2104.1.1 Tolerances. Masonry, except masonry veneer, shall be constructed within the tolerances specified in TMS 602/ACI 530.1/ASCE 6.]~~

~~[2104.1.2 Placing mortar and units. Placement of mortar, grout and of clay, concrete, glass, and AAC masonry units shall comply with TMS 602/ACI 530.1/ASCE 6.]~~

~~[2104.1.3 Installation of wall ties. Installation of wall ties shall comply with TMS 602/ACI 530.1/ASCE 6.]~~

~~[2104.1.4 Chases and recesses. Chases and recesses shall be constructed as masonry units are laid. Masonry directly above chases or recesses wider than 12 inches (305 mm) shall be supported on lintels.]~~

~~[2104.1.5] 2104.1.1 Lintels.~~ ~~[The design of lintels shall be in accordance with the masonry design provisions of either Section 2107 or 2108.]~~ Minimum length of end support shall be 4 inches (102 mm).

~~[2104.1.6] 2104.1.2 Support on wood.~~ Masonry shall not be supported on wood girders or other forms of wood construction except as permitted in Section 2304.12.

~~[2104.2 Corbeled masonry. Corbeled masonry shall comply with the requirements of Section 1.12 of TMS 402/ACI 530/ASCE 5.]~~

~~[2104.2.1] 2104.1.3 [Molded cornices]~~ **Projecting masonry and cornices.** Unless structural support and anchorage are provided to resist the overturning moment, the center of gravity of projecting masonry or molded cornices shall lie within the middle one-third of the supporting

wall. Terra cotta and metal cornices shall be provided with a structural frame of approved noncombustible material anchored in a manner approved by the commissioner.

[2104.3] 2104.2 Cold weather construction. The cold weather construction provisions of ~~[TMS 602/ACI 530.1/ASCE 6]~~ Article 1.8 C of TMS 602 shall be implemented when either the ambient temperature falls below 40°F (4°C) or the temperature of masonry units is below 40°F (4°C).

[2104.3.1] 2104.2.1 Preparation. No salt or other chemicals for the purpose of lowering the freezing temperature of water shall be permitted in the mortar or grout mix.

[2104.4] 2104.3 Hot weather construction. The hot weather construction provisions of ~~[TMS 602/ACI 530.1/ASCE 6]~~ Article 1.8 D of TMS 602 shall be implemented when the temperature exceeds 100°F (37.8°C), or 90°F (32.2°C) with a wind-velocity greater than 8 mph (12.9 km/hr).

[2104.5] 2104.4 Wetting of brick. Brick (clay or shale) at the time of laying shall require wetting if the unit's initial rate of water absorption exceeds 21.42 grams per 30 square inches (19 355 mm²) per minute or 0.025 ounce psi (1 g/645 mm²), as determined by ASTM C 67.

[2104.6] 2104.5 Masonry construction bracing. In accordance with ~~[TMS 602/ACI 530.1/ASCE 6 Section]~~ Article 3.3E of TMS 602, the contractor shall design, provide, and install bracing that will assure stability of all masonry during construction. The contractor shall keep a bracing plan on site during all masonry construction. Bracing plans shall consider wind loads, initial and intermediate masonry strengths, and the contractor's ability to evacuate the site. Construction bracing for walls within a distance less than their height from adjoining properties or other unprotected and uncontrolled areas shall be designed for code prescribed wind loads and the bracing plan shall be signed and sealed by a licensed professional engineer. Construction bracing for walls may be designed using reduced loading in accordance with Section ~~[4618]~~ 1619. Such reduced loading shall only be permitted when an action plan meeting the requirements of Section ~~[4618.3]~~ 1619.3 is provided and maintained at the site.

[2104.7 Conduits, pipes, and sleeves in masonry. ~~Conduits, pipes and sleeves of any material not harmful to masonry are permitted to be installed in the masonry with approval of the registered design professional of record.]~~

[2104.8] 2104.6 Parapet walls. At a minimum, parapet walls shall meet the following requirements:

[2104.8.1] 2104.6.1 Parapet wall construction. All cells in the hollow masonry units and all joints in solid, cavity, or masonry-bonded hollow wall construction shall be filled solid. All corners of masonry parapet walls shall be reinforced with joint reinforcement or its equivalent at vertical intervals not greater than 16[12] inches ~~[(305 mm)]~~ (406 mm). Such reinforcement shall extend around the corner for at least 4 feet (1219 mm) in both directions, and splices shall be lapped at least 6 inches (152 mm).

[2104.8.2] 2104.6.2 Parapet anchorage. Parapets ~~[of buildings taller than 35 feet (10 668 mm)]~~ shall be reinforced vertically and shall be anchored to the roof and floors that provide lateral support for the wall in accordance with Section 1604.8.2.

[2104.9] 2104.7 Floor and roof anchorage. Floor and roof anchorage shall comply with Section 2104.7.1 through 2104.7.1.3.

[2104.9.1] 2104.7.1 Bearing details. Concentrated loads shall be supported upon construction of solid masonry, concrete, or masonry of hollow units with cells filled with mortar, grout, or concrete. In addition, construction supporting concentrated loads shall be of sufficient height to distribute safely the loads to the wall or column, or other adequate provisions shall be made to distribute the loads.

[2104.9.1.1] 2104.7.1.1 Joists. Solid construction for support under joists shall be at least 2¼ inches (57 mm) in height, and joists supported on such construction shall extend into the masonry at least 3 inches (76 mm).

[2104.9.1.2] 2104.7.1.2 Beams. Solid construction for support under beams, girders, or other concentrated loads shall be at least 4 inches (102 mm) in height, and the bearing of beams shall extend into the masonry at least 4 inches (102 mm).

[2104.9.1.3] 2104.7.1.3 Isolated piers. Isolated masonry piers shall be bonded as required for solid walls of the same thickness and shall be provided with adequate means for distributing the load at the top of the pier.

[2104.10] 2104.8 Walls adjoining structural framing. Walls adjoining structural framing shall comply with Sections 2104.8.1 and 2104.8.2.

[2104.10.1] 2104.8.1 Use of existing walls. An existing masonry wall may be used in the alteration or extension of a building provided that it meets the requirements of this code.

[2104.10.2] 2104.8.2 Walls of insufficient thickness. Existing walls of masonry units that are structurally sound, but that are of insufficient thickness when increased in height, may be strengthened by an addition of similar masonry units laid in Type M or S mortar. The foundations and lateral support shall be equivalent to those required for newly constructed walls under similar conditions. All such linings shall be thoroughly bonded into existing masonry by toothings to assure combined action of wall and lining. Toothings shall be distributed uniformly throughout the wall, and shall aggregate in vertical cross-sectional area at least 15 percent of the total surface area of the lining. Stresses in the masonry under the new conditions shall not exceed the allowable stresses.

[2104.11] 2104.9 Isolation joints. All non-participating masonry walls and veneers shall be constructed with adequate depth and width of isolation joints to prevent masonry distress induced by deflections, drifts, shortening, expansion, or other similar movements in the plane of the wall.

[2104.12] 2104.10 Substitution. Mortar shall not be substituted for grout where grout is specified on the construction documents.

SECTION BC 2105 QUALITY ASSURANCE

2105.1 General. A quality assurance program shall be used to ensure that the constructed masonry is in compliance with the approved construction documents. [~~The quality assurance program shall comply with the inspection and testing requirements of Chapter 17.~~]

The quality assurance program shall comply with the inspection and testing requirements of Chapter 17 and TMS 602.

[~~2105.2 Acceptance relative to strength requirements.~~]

~~[**2105.2.1 Compliance with f_m and f_{AAC} .** Compressive strength of masonry shall be considered satisfactory if the compressive strength of each masonry wythe and grouted collar joint equals or exceeds the value of f_m for clay and concrete masonry and f_{AAC} for AAC masonry. For partially grouted clay and concrete masonry, the compressive strength of both the grouted and ungrouted masonry shall equal or exceed the applicable f_m . At the time of prestress, the compressive strength of the masonry shall equal or exceed f_{mi} , which shall be less than or equal to $f_{m\tau}$.]~~

~~[**2105.2.2 Determination of compressive strength.** The compressive strength for each wythe shall be determined by the unit strength method or by the prism test method as specified herein.]~~

[~~2105.2.2.1 Unit strength method.~~]

~~[**2105.2.2.1.1 Clay masonry.** The compressive strength of masonry shall be determined based on the strength of the units and the type of mortar specified using Table 2105.2.2.1.1, provided:]~~

~~[1. Units are sampled and tested in accordance with ASTM C 67 to verify compliance with ASTM C 62, ASTM C 216 or ASTM C 652.]~~

~~[2. Thickness of bed joints does not exceed $\frac{5}{8}$ inch (15.9 mm).]~~

~~[3. For grouted masonry, the grout meets one of the following requirements:]~~

~~[3.1. Grout conforms to Article 2.2 of TMS 602/ACI 530.1/ASCE 6.]~~

~~[3.2. Minimum grout compressive strength equals or exceeds f_m but not less than 2,000 psi (13.79 MPa). The compressive strength of grout shall be determined in accordance with ASTM C 1019.]~~

**[TABLE 2105.2.2.1.1
COMPRESSIVE STRENGTH OF CLAY MASONRY]**

[NET AREA COMPRESSIVE STRENGTH OF CLAY MASONRY UNITS (psi)]		[NET AREA COMPRESSIVE STRENGTH OF MASONRY (psi)]
[Type M or S mortar]	[Type N mortar]	
[1,700]	[2,100]	[1,000]
[3,350]	[4,150]	[1,500]
[4,950]	[6,200]	[2,000]
[6,600]	[8,250]	[2,500]
[8,250]	[10,300]	[3,000]
[9,900]	[—]	[3,500]
[13,200]	[—]	[4,000]

[For SI: 1 pound per square inch = 0.00689 MPa.]

~~[2105.2.2.1.2 Concrete masonry. The compressive strength of masonry shall be determined based on the strength of the unit and type of mortar specified using Table 2105.2.2.1.2, provided:]~~

~~[1. Units conform to ASTM C 55 or ASTM C 90 and are sampled and tested in accordance with ASTM C 140.]~~

~~[2. Thickness of bed joints does not exceed $\frac{5}{8}$ inch (15.9 mm).]~~

~~[3. For grouted masonry, the grout meets one of the following requirements:]~~

~~[3.1. Grout conforms to Article 2.2 of TMS 602/ACI 530.1/ASCE 6.]~~

~~[3.2. Minimum grout compressive strength equals f'_m but not less than 2,000 psi (13.79 MPa). The compressive strength of grout shall be determined in accordance with ASTM C 1019.]~~

**[TABLE 2105.2.2.1.2
COMPRESSIVE STRENGTH OF CONCRETE MASONRY]**

[NET AREA COMPRESSIVE STRENGTH OF CONCRETE MASONRY UNITS (psi)]		[NET AREA COMPRESSIVE STRENGTH OF MASONRY (psi)]
[Type M or S mortar]	[Type N mortar]	
[1,250]	[1,300]	[1,000]
[1,900]	[2,150]	[1,500]
[2,800]	[3,050]	[2,000]
[3,750]	[4,050]	[2,500]
[4,800]	[5,250]	[3,000]

[For SI: 1 inch = 25.4 mm, 1 pound per square inch = 0.00689 mPa.]

[a.— For units less than 4 inches in height, 85 percent of the values listed.]

~~[2105.2.2.1.3 AAC masonry. The compressive strength of AAC masonry shall be based on the strength of the AAC masonry unit only and the following shall be met:]~~

~~[1. Units conform to ASTM C 1386.]~~

~~[2. Thickness of bed joints does not exceed $\frac{1}{8}$ inch (3.2 mm).]~~

~~[3. For grouted masonry, the grout meets one of the following requirements:]~~

~~[3.1. Grout conforms to Article 2.2 of TMS 602/ACI 530.1/ASCE 6.]~~

~~[3.2. Minimum grout compressive strength equals or exceeds f'_{AAC} but not less than 2,000 psi (13.79 MPa). The compressive strength of grout shall be determined in accordance with ASTM C 1019.]~~

~~[**2105.2.2.2 Prism test method.**]~~

~~[**2105.2.2.2.1 General.** The compressive strength of masonry shall be determined by the prism test method:]~~

~~[1. Where specified in the construction documents.]~~

~~[2. Where masonry does not meet the requirements for application of the unit strength method in Section 2105.2.2.1.]~~

~~[**2105.2.2.2.2 Number of prisms per test.** A prism test shall consist of three prisms constructed and tested in accordance with ASTM C 1314.]~~

~~[**2105.3 Testing prisms from constructed masonry.** When approved by the commissioner acceptance of masonry that does not meet the requirements of Section 2105.2.2.1 or 2105.2.2.2 shall be permitted to be based on tests of prisms cut from the masonry construction in accordance with Sections 2105.3.1, 2105.3.2 and 2105.3.3.]~~

~~[**2105.3.1 Prism sampling and removal.** A set of three masonry prisms that are at least 28 days old shall be saw cut from the masonry for each 5,000 square feet (465 m²) of the wall area that is in question but not less than one set of three masonry prisms for the project. The length, width and height dimensions of the prisms shall comply with the requirements of ASTM C 1314. Transporting, preparation and testing of prisms shall be in accordance with ASTM C 1314.]~~

~~[**2105.3.2 Compressive strength calculations.** The compressive strength of prisms shall be the value calculated in accordance ASTM C 1314, except that the net cross sectional area of the prism shall be based on the net mortar bedded area.]~~

~~[**2105.3.3 Compliance.** Compliance with the requirement for the specified compressive strength of masonry, f'_m , shall be considered satisfied provided the modified compressive strength equals or exceeds the specified f'_m . Additional testing of specimens cut from locations in question shall be permitted.]~~

~~[**2105.4 2105.2 Submittals.** Submittals required by [TMS 602/ACI 530.1/ASCE 6 Section] Article 1.5 of TMS 602 shall be sent to the applicant of record for review prior to use of the materials or methods of construction. In addition the contractor shall submit a Material Storage and Protection Plan.~~

SECTION BC 2106 SEISMIC DESIGN

2106.1 Seismic design requirements for masonry. Masonry structures and components shall comply with the requirements in ~~[Section]~~ Chapter 7 of TMS 402~~[/ACI 530/ASCE 5]~~ depending on the structure's seismic design category as determined in Section 1613 of this code. All masonry walls, unless isolated on three edges from in-plane motion of the basic structural systems, shall be considered to be part of the seismic-force-resisting system.

2106.1.1 Non-participating masonry walls. Masonry walls that are not part of the lateral-force-resisting system shall be isolated from the structure so that the vertical and lateral forces are not imparted to these elements. Isolation joints and connectors between these elements and the structure shall be designed to accommodate the design story drift.

SECTION BC 2107 ALLOWABLE STRESS DESIGN

2107.1 General. The design of masonry structures using allowable stress design shall comply with Section 2106 and the requirements of Chapters 1 ~~[and 2, except Section 2.1.2.1 and 2.1.3.3]~~ through 8 of TMS 402~~[/ACI 530/ASCE 5. The text of TMS 402/ACI 530/ASCE 5 shall be]~~ except as modified by Sections 2107.2 through [2107.5 of this code] 2107.4 of this code.

2107.2 TMS 402~~[/ACI 530/ASCE 5]~~, Section [2.1.2, load combinations] 6.1.6.1.1, lap splices. ~~[Delete Section 2.1.2.1.]~~ As an alternative to Section 6.1.6.1.1, it shall be permitted to design lap splices in accordance with Section 2107.2.1 of the New York City Building Code.

~~[2107.3 TMS 402/ACI 530/ASCE 5, Section 2.1.9.7.1.1, lap splices. Modify Section 2.1.9.7.1.1 as follows:]~~

~~[2.1.7.1.1]~~ **2107.2.1 Lap splices.** The minimum length of lap splices for reinforcing bars in tension or compression, ~~[l_d]~~ l_d , shall be

$$l_d = 0.002d_b f_s \quad \text{(Equation 21-1)}$$

For SI: $l_d = 0.29d_b f_s$

but not less than 12 inches (305 mm). In no case shall the length of the lapped splice be less than 40 bar diameters.

where:

d_b = Diameter of reinforcement, inches (mm).

f_s = Computed stress in reinforcement due to design loads, psi (MPa).

In regions of moment where the design tensile stresses in the reinforcement are greater than 80 percent of the allowable steel tension stress, F_s , the lap length of splices shall be increased not less than 50 percent of the minimum required length, but need not be greater than $72d_b$. Other equivalent means of stress transfer to accomplish the same 50 percent increase shall be permitted. Where epoxy coated bars are used, lap length shall be increased by 50 percent.

[2107.4] 2107.3 TMS 402[/~~ACI 530/ASCE 5~~], Section [2.1.9.7] 6.1.6.1, splices of reinforcement. Modify Section [2.1.9.7] 6.1.6.1 as follows:

[2.1.9.7] 6.1.6.1 – Splices of reinforcement. Lap splices, welded splices or mechanical splices are permitted in accordance with the provisions of this section. All welding shall conform to AWS D1.4. Welded splices shall be of ASTM A706 steel reinforcement. Reinforcement larger than No. 9 (M #29) shall be spliced using mechanical connections in accordance with Section [2.1.9.7.3] 6.1.6.1.3.

[2107.5] 2107.4 TMS 402[/~~ACI 530/ASCE 5~~], Section [2.3.6] 8.3.6, maximum bar size. Add the following to Chapter [2] 8:

[2.3.6] 8.3.6 – Maximum bar size. The bar diameter shall not exceed one-eighth of the nominal wall thickness and shall not exceed one-quarter of the least dimension of the cell, course or collar joint in which it is placed.

SECTION BC 2108 STRENGTH DESIGN OF MASONRY

2108.1 General. The design of masonry structures using strength design shall comply with Section 2106 and the requirements of Chapters 1 through 7 and [3] Chapter 9 of TMS 402[/~~ACI 530/ASCE 5~~], except as modified by Sections 2108.2 through 2108.3 of this code.

Exception: AAC masonry shall comply with the requirements of [Chapter] Chapters 1 through 7 and [Appendix A] Chapter 11 of TMS 402[/~~ACI 530/ASCE 5~~].

2108.2 TMS 402 [/~~ACI 530/ASCE 5~~], Section [3.3.3.3] 6.1.5.1.1, development. Modify the second paragraph of Section [3.3.3.3] 6.1.5.1.1 as follows:

The required development length of reinforcement shall be determined by Equation [(3-16)] (6-1), but shall not be less than 12 inches (305 mm) and need not be greater than $72 d_b$.

2108.3 TMS 402[/~~ACI 530/ASCE 5~~], Section [3.3.3.4] 6.1.6.1.1, splices. Modify [items (b) and (e) of Section 3.3.3.4] subsections 6.1.6.1.2 and 6.1.6.1.3 as follows:

[3.3.3.4 (b).] 6.1.6.1.2 – A welded splice shall have the bars butted and welded to develop at least 125 percent of the yield strength, f_y , of the bar in tension or compression, as required. Welded splices shall be of ASTM [A 706] A706 steel reinforcement. Welded splices shall not be permitted in plastic hinge zones of intermediate or special reinforced walls [or special moment frames of masonry].

[3.3.3.4 (e).] 6.1.6.1.3 – Mechanical splices shall be classified as Type 1 or 2 [according to] in accordance with Section [21.2.6.1] 18.2.7.1 of ACI 318. Type 1 mechanical splices shall not be used within a plastic hinge zone or within a beam-column joint of intermediate or special reinforced masonry shear walls [or special moment frames]. Type 2 mechanical splices are permitted in any location within a member.

**SECTION BC 2109
EMPIRICAL DESIGN OF MASONRY**

2109.1 General. Empirically designed masonry shall conform to this chapter or ~~[Chapter 5]~~ the requirements of Appendix A of TMS 402 ~~[ACI 530/ASCE 5]~~, except where otherwise noted in this section.

2109.1.1 Limitations. The use of empirical design of masonry shall be limited as noted in Section ~~[5.1.2]~~ A.1.2 of TMS 402 ~~[ACI 530/ASCE 5]~~. The use of dry-stacked, surface-bonded masonry shall be prohibited in ~~[Occupancy]~~ Risk Category IV structures. In buildings that exceed one or more of the limitations of Section ~~[5.1.2]~~ A.1.2 of TMS 402 ~~[ACI 530/ASCE 5]~~, masonry shall be designed in accordance with the engineered design provisions of Section ~~[2101.2.1, 2101.2.2]~~ 2101.2 or ~~[2101.2.3]~~ the foundation wall provisions of [this code] Section 1807.

2109.1.1.1 TMS 402, Section A.1.2.3, Wind. Section A.1.2.3 of TMS 402 shall be modified as follows:

A.1.2.3 – Wind. Empirical requirements shall not apply to the design or construction of masonry for buildings, parts of buildings, or other structures to be located in areas where V_{asd} as determined in accordance with Section 1609.3.1 of the *New York City Building Code* exceeds 110 mph.

2109.2 Surface-bonded walls. Dry-stacked, surface-bonded concrete masonry walls shall comply with the requirements of ~~[Chapter 5]~~ Appendix A of TMS 402 ~~[ACI 530/ASCE 5]~~, except where otherwise noted in this section.

~~[2109.2.11]~~ **2109.2.1 Strength.** Dry-stacked, surface-bonded concrete masonry walls shall be of adequate strength and proportions to support all superimposed loads without exceeding the allowable stresses listed in Table ~~[2109.2.11]~~ 2109.2.1. Allowable stresses not specified in Table ~~[2109.2.11]~~ 2109.2.1 shall comply with the requirements of TMS 402 ~~[ACI 530/ASCE 5]~~.

**TABLE ~~[2109.2.11]~~ 2109.2.1
ALLOWABLE STRESS GROSS CROSS-SECTIONAL
AREA FOR DRY-STACKED, SURFACE-BONDED
CONCRETE MASONRY WALLS**

DESCRIPTION	MAXIMUM ALLOWABLE STRESS (psi)
Compression standard block	45
Flexural tension	
Horizontal span	30
Vertical span	18
Shear	10

For SI: 1 pound per square inch = 0.006895 MPa

~~[2109.2.22]~~ **2109.2.2 Construction.** Construction of dry-stacked, surface-bonded masonry walls, including stacking and leveling of units, mixing and application of mortar and curing and protection shall comply with ASTM C 946.

2109.3 Reserved.

2109.4 [Reserved.]

[2109.5] Thickness of masonry. Minimum thickness requirements shall be based on nominal dimensions of masonry.

[2109.5.1] 2109.4.1 Thickness of walls. The thickness of masonry walls shall conform to the requirements of Section ~~[2109.5]~~ 2109.4.

[2109.5.2] 2109.4.2 Minimum thickness. The minimum thickness of masonry bearing walls more than one story high shall be 8 inches (203 mm) where the height floor to floor does not exceed 12 feet (3658 mm), the floor live load does not exceed 60 pounds per square ~~[feet]~~ foot (psf) (0.156 kg/m²), and the roof is designed so that the dead load imparts no lateral thrust to the wall. Bearing walls of one-story buildings shall not be less than 6 inches (152 mm) thick. However, the overall thickness of cavity or masonry-bonded hollow walls shall not be less than 8 inches (203 mm), including cavity.

[2109.5.2.1] 2109.4.2.1 Walls above roof level. Masonry walls above roof level, 12 feet (3658 mm) or less in height, enclosing stairways, machinery rooms, shafts, or penthouses, may be up to 8 inches (203 mm) thick and shall be considered as neither increasing the height, nor requiring any increase in the thickness of the wall below.

[2109.5.3] 2109.4.3 Partitions. The minimum thickness for partitions shall be as follows:

**TABLE [2109.5.3] 2109.4.3
MINIMUM THICKNESS OF MASONRY PARTITIONS**

HEIGHT OF WALLS	THICKNESS
8 ft. and under	2 in.
Over 8 ft. to 12 ft	3 in.
Over 12 ft. to 16 ft	4 in.
Over 16 ft. to 20 ft	6 in.
Over 20 ft. to 24 ft.	8 in.

For SI: 1 inch = 25.4 mm, 1 foot = 304.8 mm.

[2109.6 Reserved.]

[2109.7] 2109.5 Horizontal joints. All concrete framed buildings to be constructed over 35 feet (10 668 mm) in height (as measured from adjoining grade to the main roof level), whose exterior wythe are of cavity wall construction with steel lintels, shall have horizontal joints in the exterior wythe to prevent masonry distress induced by vertical shortening of the structural frame.

[2109.7.1] 2109.5.1 Joint minimum thickness. Unless substantiated as indicated by Section ~~[2109.7.2]~~ 2109.5.2, horizontal joints shall be ¹/₄ inch (6.4 mm) minimum thickness, with neoprene, polyethylene, or urethane gasket or equivalent joint filler filling the entire joint, except for a recess from the toe of the lintel angle to the exterior of the facing brick, to provide space for caulking. These joints shall be placed at each floor.

[2109.7.2] 2109.5.2 Joint thickness by analysis. The applicant of record shall submit an engineering analysis establishing that proposed building horizontal joints spaced further apart than in Section ~~[2109.7.1]~~ 2109.5.1 are sufficient to provide for the effects of vertical shortening

of the structural frame.

SECTION BC 2110 GLASS UNIT MASONRY

2110.1 General. ~~[This section covers the empirical requirements for non load bearing glass unit masonry elements in exterior or interior walls.]~~ Glass unit masonry construction shall comply with Chapter [7] 13 of TMS 402~~[/ACI-530/ASCE-5]~~ and this section.

2110.1.1 Limitations. Solid or hollow approved glass block shall not be used in ~~[firewalls]~~ fire walls, party walls, fire barriers, fire partitions, smoke barriers, or for load-bearing construction. Such blocks shall be erected with mortar and reinforcement in metal channel-type frames, structural frames, masonry or concrete recesses, embedded panel anchors as provided for both exterior and interior walls or other approved joint materials. Wood strip framing shall not be used in walls required to have a fire-resistance rating by other provisions of this code.

Exceptions:

1. ~~[Glass block]~~ Glass-block assemblies having a fire protection rating of not less than $\frac{3}{4}$ hour shall be permitted as opening protectives in accordance with Section ~~[715]~~ 716 in fire barriers, fire partitions and smoke barriers that have a required fire-resistance rating of 1 hour and do not enclose exit stairways or exit passageways.
2. ~~[Glass block]~~ Glass-block assemblies as permitted in Section 404.6, Exception [2] 1.

SECTION BC 2111 MASONRY FIREPLACES

2111.1 General. ~~[A] The construction of masonry [fireplace is a fireplace constructed of concrete or masonry. Masonry]~~ fireplaces shall be ~~[constructed]~~ in accordance with this section, Table 2111.1 and Figure 2111.1. All masonry fireplaces shall be installed, altered and maintained in buildings in conformity with the applicable provisions of the New York City Mechanical Code, the New York City Fuel Gas Code and the New York City Air Pollution Control Code. ~~[and no]~~ No new masonry fireplaces shall be permitted except those that burn the types of fuel allowed by ~~[section]~~ Section 24-149.2 of [such code] the New York City Air Pollution Control Code.

TABLE 2111.1
[SUMMARY OF] REQUIREMENTS FOR MASONRY FIREPLACES AND CHIMNEYS^a

ITEM	LETTER	[REQUIREMENTS]	SECTION
Hearth and hearth extension thickness	A	[4-inch minimum thickness for hearth, 2-inch minimum thickness for hearth extension.]	[2111.9] <u>2111.10</u>
Hearth extension (each side of opening)	B	[8 inches for fireplace opening less than 6 square feet. 12 inches for fireplace opening greater than or equal to 6 square feet.]	[2111.10] <u>2111.11</u>
Hearth extension (front of opening)	C	[16 inches for fireplace opening less than 6 square feet. 20 inches for fireplace opening greater than or equal to 6 square feet.]	[2111.10] <u>2111.11</u>
Firebox dimensions	—	[20-inch minimum firebox depth. 12-inch minimum firebox depth for Rumford fireplaces.]	[2111.6] <u>2111.7</u>
Hearth and hearth extension reinforcing	D	[Reinforced to carry its own weight and all imposed loads.]	[2111.9] <u>2111.10</u>
Thickness of wall of firebox	E	[10 inches solid masonry or 8 inches where firebrick lining is used.]	[2111.5] <u>2111.6</u>
Distance from top of opening to throat	F	[8 inches minimum.]	[2111.7] 2111.7.1 <u>2111.8</u> <u>2111.8.1</u>
Smoke chamber wall thickness dimensions	G	[6 inches lined; 8 inches unlined. Not taller than opening width; walls not inclined more than 45 degrees from vertical for prefabricated smoke chamber linings or 30 degrees from vertical for corbeled masonry.]	[2111.8] <u>2111.9</u>
Chimney vertical reinforcing	H	[Four No. 4 full length bars for chimney up to 40 inches wide. Add two No. 4 bars for each additional 40 inches or fraction of width, or for each additional flue.]	[2111.3.1] <u>2111.4.1</u> , 2113.3.1
Chimney horizontal reinforcing	J	[1/4 inch ties at each 18 inches, and two ties at each bend in vertical steel.]	[2111.3.2] <u>2111.4.2</u> , 2113.3.2
Fireplace lintel	L	[Noncombustible material with 4 inch bearing length of each side of opening.]	[2111.7] <u>2111.8</u>
Chimney walls with flue lining	M	[4-inch thick solid masonry with 5/8-inch fireclay liner or equivalent. 1/2-inch grout or airspace between fireclay liner and wall.]	[2113.11.1] <u>2113.11</u>
Effective flue area (based on area of fireplace opening and chimney)	P	[See Section 2113.16.]	2113.16
Clearances			
From chimney		[2 inches interior, 1 inch exterior or 12 inches from lining.]	2113.19
From fireplace		[2 inches back or sides or 12 inches from lining.]	[2111.11] 2111.12
From combustible trim or materials	R	[6 inches from opening]	[2111.12] <u>2111.13</u>
Above roof		[3 feet above roof penetration, 2 feet above part of structure within 10 feet.]	2113.9
Anchorage strap		[3/16 inch by 1 inch]	
Number required		[Two]	[2111.4] <u>2111.5</u>
Embedment into chimney	S	[12 inches hooked around outer bar with 6-inch extension.]	
Fasten to		[4 joists]	
Number of bolts		[Two 1/2-inch diameter.]	[2113.4.1] <u>2113.4</u>
Footing			
Thickness	T	[12-inch minimum.]	[2111.2] <u>2111.3</u>
Width		[6 inches each side of fireplace wall.]	

For SI: 1 inch = 25.4 mm, 1 foot = 304.8 mm, 1 square foot = 0.0929m², 1 degree = 0.017 rad.

a. [This table provides a summary of major requirements for the construction of masonry chimneys and fireplaces.] Letter references [are] refer to Figure 2111.1, which shows examples of typical construction. [This table does not cover all requirements, nor does it cover all aspects of the indicated requirements.] For the actual mandatory requirements of the code, see the indicated section of text.

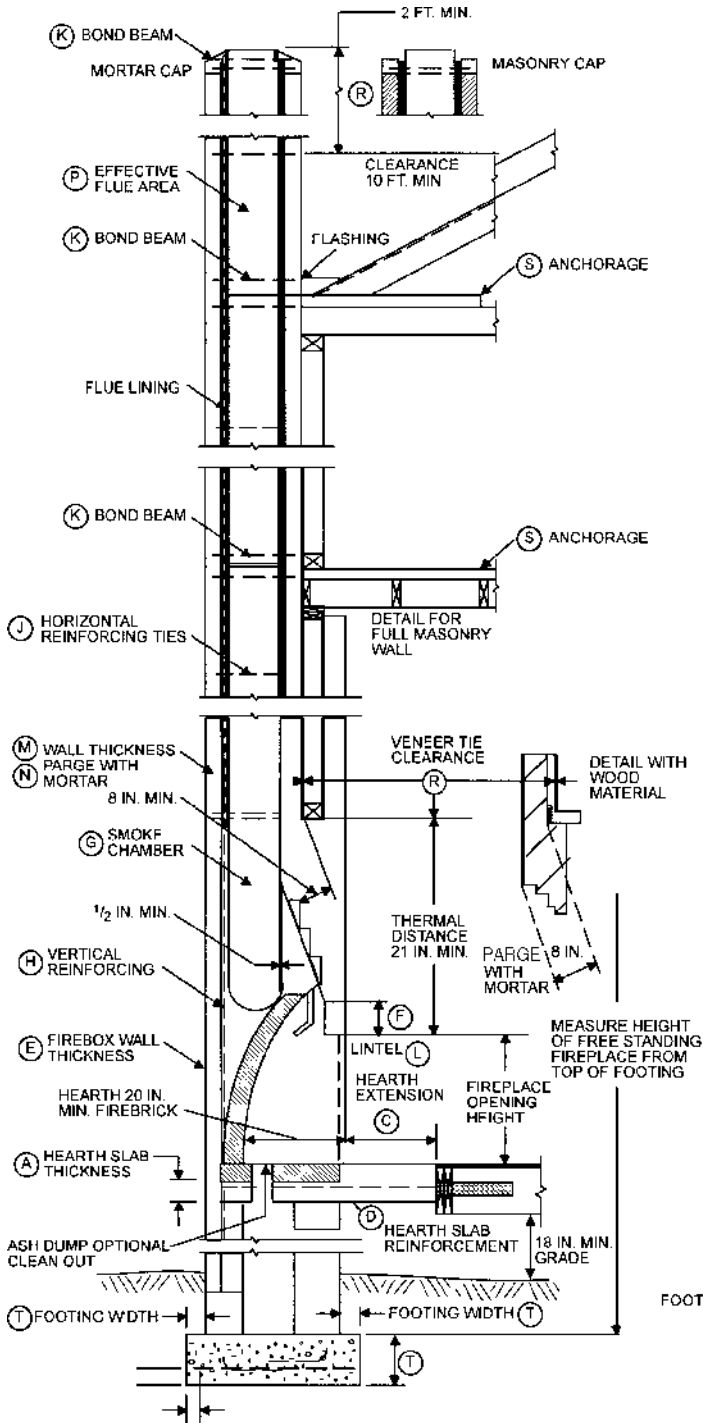

BRICK FIREBOX AND CHIMNEY—
SECTIONAL SIDE VIEW ON WOOD FLOOR

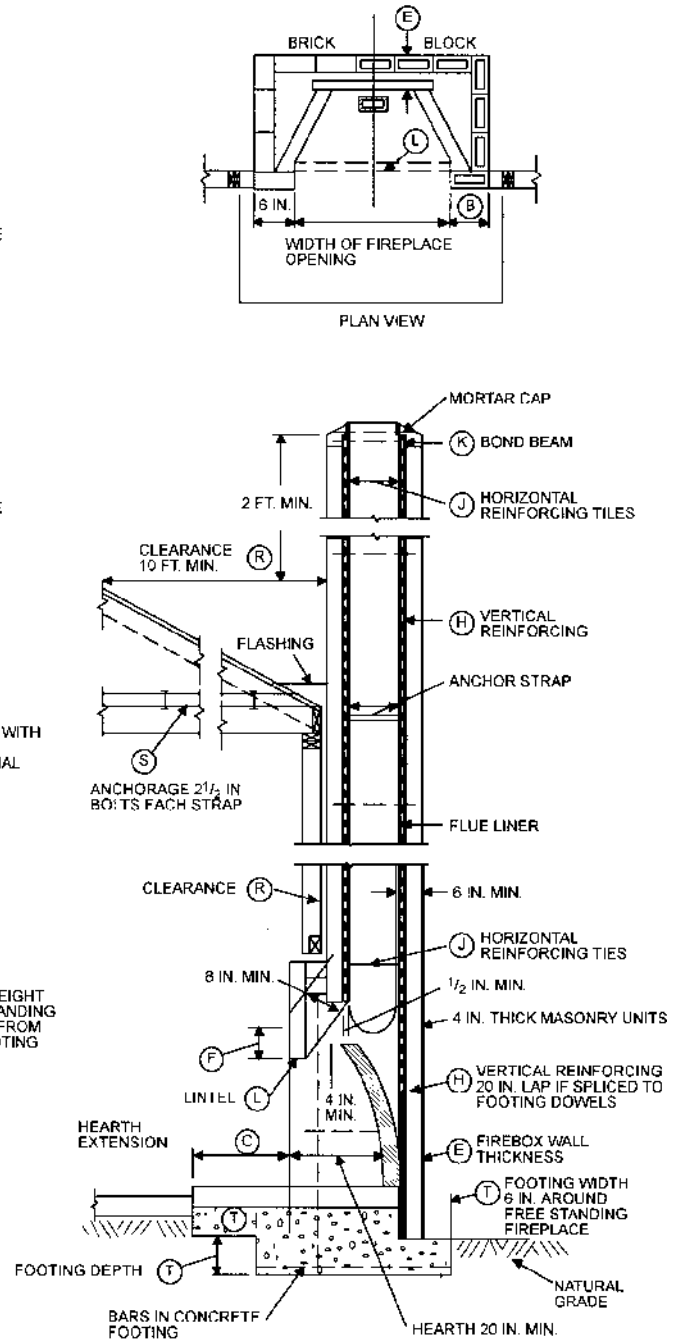

BRICK FIREBOX AND BLOCK CHIMNEY—
SECTIONAL SIDE VIEW ON CONCRETE SLAB

For SI: 1 inch = 25.4 mm, 1 foot = 304.8 mm.

FIGURE 2111.1
FIREPLACE AND CHIMNEY DETAILS

2111.2 Fireplace drawings. The construction documents shall describe in sufficient detail the location, size and construction of masonry fireplaces. The thickness and characteristics of materials and the clearances from walls, partitions and ceilings shall be indicated.

~~[2111.2]~~ **2111.3 Footings and foundations.** Footings for masonry fireplaces and their chimneys shall be constructed of reinforced concrete or solid masonry at least 12 inches (305 mm) thick and shall extend at least 6 inches (152 mm) beyond the face of the fireplace or foundation wall on all sides. Footings shall be founded on natural undisturbed earth or engineered fill below frost depth. In areas not subjected to freezing, footings shall be at least 12 inches (305 mm) below finished grade.

~~[2111.2.1]~~ **2111.3.1 Ash dump [clean-out] cleanout.** ~~[Clean-out]~~ Cleanout openings, located within foundation walls below fireboxes, when provided, shall be equipped with ferrous metal or masonry doors and frames constructed to remain tightly closed, except when in use. ~~[Clean-outs]~~ Cleanouts shall be accessible and located so that ash removal will not create a hazard to combustible materials.

~~[2111.2.2]~~ **2111.3.2 [Elevated] Floor-supported fireplaces.** Fireplaces not supported on foundations shall be supported on noncombustible construction having a minimum fire-resistance rating of 3 hours for the ~~[elements]~~ members or assemblies in contact with the fireplace. Structural ~~[elements]~~ members or assemblies not directly in contact with the fireplace shall only be required to meet the fire-resistance rating specified elsewhere in this code.

~~[2111.3 Seismic reinforcing. Masonry or concrete fireplaces shall be constructed, anchored, supported and reinforced as required in this chapter. In Seismic Design Category C or D, masonry and concrete fireplaces shall be reinforced and anchored as detailed in Sections 2111.3.1, 2111.3.2, 2111.4 and 2111.4.1 for chimneys serving fireplaces. In Seismic Design Category B, reinforcement and seismic anchorage is not required.]~~

2111.4 Seismic reinforcement. In structures assigned to Seismic Design Category A or B, seismic reinforcement is not required. In structures assigned to Seismic Design Category C or D, masonry fireplaces shall be reinforced and anchored in accordance with Sections 2111.4.1, 2111.4.2 and 2111.5, and Table 2111.1, and Figure 2111.1.

~~[2111.3.1]~~ **2111.4.1 Vertical reinforcing.** For fireplaces with chimneys up to 40 inches (1016 mm) wide, four No. 4 continuous vertical bars, anchored in the foundation, shall be placed in the concrete~~;~~ between wythes of solid masonry or within the cells of hollow unit masonry and grouted in accordance with Section ~~[2103.12]~~ 2103.3. For fireplaces with chimneys greater than 40 inches (1016 mm) wide, two additional No. 4 vertical bars shall be provided for each additional 40 inches (1016 mm) in width or fraction thereof.

~~[2111.3.2]~~ **2111.4.2 Horizontal reinforcing.** Vertical reinforcement shall be placed enclosed within ¼-inch (6.4 mm) ties or other reinforcing of equivalent net cross-sectional area, spaced not to exceed 18 inches (457 mm) on center in concrete; or placed in the bed joints of unit masonry at a minimum of every 18 inches (457 mm) of vertical height. Two such ties shall be provided at each bend in the vertical bars.

[2111.4] 2111.5 Seismic anchorage. Masonry ~~[and concrete chimneys in Seismic Design Category C or D shall be anchored at each floor, ceiling or roof line more than 6 feet (1829 mm) above grade, except where constructed completely within the exterior walls. Anchorage shall conform to the following requirements]~~ fireplaces shall have their chimneys anchored in accordance with Section 2113.4.

[2111.4.1 Anchorage. Two ³/₁₆-inch by 1-inch (4.8 mm by 25 mm) straps shall be embedded a minimum of 12 inches (305 mm) into the chimney. Straps shall be hooked around the outer bars and extend 6 inches (152 mm) beyond the bend. Each strap shall be fastened to a minimum of four floor joists with two 1/2-inch (12.7 mm) bolts.]

[2111.5] 2111.6 Firebox walls. Masonry fireboxes shall be constructed of solid masonry units, hollow masonry units grouted solid, or stone ~~[or concrete]~~. When a lining of firebrick at least 2 inches (51 mm) in thickness or other approved lining is provided, the minimum thickness of back and ~~[side-walls]~~ sidewalls shall each be 8 inches (203 mm) of solid masonry, including the lining. The approved lining shall be able to withstand a temperature of 2000°F (1093°C) without cracking. The width of joints between firebricks shall be not ~~[be]~~ greater than 1/4 inch (6.4 mm). When no lining is provided, the total minimum thickness of back and ~~[side-walls]~~ sidewalls shall be 12 inches (305 mm) of solid masonry. Firebrick shall conform to ASTM C 27 or ASTM C 1261 and shall be laid with medium-duty refractory mortar conforming to ASTM C 199.

[2111.5.1] 2111.6.1 Steel fireplace units. Steel fireplace units are permitted to be installed with solid masonry to form a masonry fireplace provided they are installed according to either the requirements of their listing or the requirements of this section. Steel fireplace units incorporating a steel firebox lining shall be constructed with steel not less than 1/4 inch (6.4 mm) in thickness, and an air-circulating chamber which is ducted to the interior of the building. The firebox lining shall be encased with solid masonry to provide a total thickness at the back and sides of not less than 8 inches (203 mm), of which not less than 4 inches (102 mm) shall be of solid masonry or concrete. Circulating air ducts employed with steel fireplace units shall be constructed of metal or masonry.

[2111.6] 2111.7 Firebox dimensions. The firebox of a ~~[concrete or]~~ masonry fireplace shall have a minimum depth of 20 inches (508 mm). The throat shall be not ~~[be]~~ less than 8 inches (203 mm) above the fireplace opening. The throat opening shall not be less than 4 inches (102 mm) in depth. The cross-sectional area of the passageway above the firebox, including the throat, damper and smoke chamber, shall be not ~~[be]~~ less than the cross-sectional area of the flue.

Exception: Rumford fireplaces shall be permitted provided that the depth of the fireplace is ~~[at least]~~ not less than 12 inches (305 mm) and at least one-third of the width of the fireplace opening, and the throat is ~~[at least]~~ not less than 12 inches (305 mm) above the lintel, and at least ¹/₂₀ the cross-sectional area of the fireplace opening.

[2111.7] 2111.8 Lintel and throat. Masonry over a fireplace opening shall be supported by a lintel of noncombustible material. The minimum required bearing length on each end of the fireplace opening shall be 4 inches (102 mm). The fireplace throat or damper shall be located ~~[a minimum of]~~ not less than 8 inches (203 mm) above the top of the fireplace opening.

[2111.7.1] 2111.8.1 Damper. Masonry fireplaces shall be equipped with a ferrous metal damper located ~~[at least]~~ not less than 8 inches (203 mm) above the top of the fireplace opening. Dampers shall be installed in the fireplace or at the top of the flue venting the fireplace, and shall be operable from the room containing the fireplace. Damper controls shall be permitted to be located in the fireplace. The damper shall be able to withstand distortion from binding, cracking or corrosion when exposed to the fireplace operating temperature.

[2111.8] 2111.9 Smoke chamber walls. Smoke chamber walls shall be constructed of solid masonry units, hollow masonry units grouted solid, or stone ~~[or concrete]~~. Corbeling of masonry units shall not leave unit cores exposed to the inside of the smoke chamber. The inside surface of corbeled masonry shall be parged smooth. Where no lining is provided, the total minimum thickness of front, back and ~~[side walls]~~ sidewalls shall be 8 inches (203 mm) of solid masonry. When a lining of firebrick ~~[at least]~~ not less than 2 inches (51 mm) thick, or a lining of vitrified clay ~~[at least]~~ not less than $\frac{5}{8}$ inch (15.9 mm) thick, is provided, the total minimum thickness of front, back and ~~[side walls]~~ sidewalls shall be 6 inches (152 mm) of solid masonry, including the lining. Firebrick shall conform to ASTM C 27 or ASTM C 1261 and shall be laid with refractory mortar conforming to ASTM C 199. ~~[Verified]~~ Vitrified clay linings shall conform to ASTM C 315.

[2111.8.1] 2111.9.1 Smoke chamber dimensions. The inside height of the smoke chamber from the fireplace throat to the beginning of the flue shall be not ~~[be]~~ greater than the inside width of the fireplace opening. The inside surface of the smoke chamber shall not be inclined more than 45 degrees (0.76 rad) from vertical when prefabricated smoke chamber linings are used or when the smoke chamber walls are rolled or sloped rather than corbeled. When the inside surface of the smoke chamber is formed by corbeled masonry, the walls shall not be corbeled more than 30 degrees (0.52 rad) from vertical.

[2111.9] 2111.10 Hearth and hearth extension. Masonry fireplace hearths and hearth extensions shall be constructed of concrete, ceramic tile, masonry or equivalent, supported by noncombustible materials, and reinforced to carry their own weight and all imposed loads. No combustible material shall remain against the underside of hearths or hearth extensions after construction.

[2111.9.1] 2111.10.1 Hearth thickness. The minimum thickness of fireplace hearths shall be 4 inches (102 mm).

[2111.9.2] 2111.10.2 Hearth extension thickness. The minimum thickness of hearth extensions shall be 2 inches (51 mm).

Exception: When the bottom of the firebox opening is raised ~~[at least]~~ not less than 8 inches (203 mm) above the top of the hearth extension, a hearth extension of not less than $\frac{3}{8}$ -inch-thick (9.5 mm) brick, concrete, stone, tile or other approved noncombustible material is permitted.

[2111.10] 2111.11 Hearth extension dimensions. Hearth extensions shall extend ~~[at least]~~ not less than 16 inches (406 mm) in front of, and ~~[at least]~~ not less than 8 inches (203 mm) beyond, each side of the fireplace opening. Where the fireplace opening is 6 square feet (0.56 m²) or larger, the hearth extension shall extend ~~[at least]~~ not less than 20 inches (508 mm) in front of, and ~~[at least]~~ not less than 12 inches (305 mm) beyond, each side of the fireplace opening.

[2111.10.1] 2111.11.1 Elevated or overhanging fireplace. Where a fireplace is elevated or overhangs a floor, the hearth extension shall also extend ~~[over the area under the fireplace]~~ beneath the entire area of the fireplace.

[2111.11] 2111.12 Fireplace clearance. Any portion of a masonry fireplace located in the interior of a building or within the exterior wall of a building shall have a clearance to combustibles of not less than 2 inches (51 mm) from the front faces and sides of masonry fireplaces and not less than 4 inches (102 mm) from the back faces of masonry fireplaces. The airspace shall not be filled, except to provide fireblocking in accordance with Section 2111.13.

Exceptions:

1. Masonry fireplaces listed and labeled for use in contact with combustibles in accordance with UL 127~~[7]~~ and installed in accordance with the manufacturer's ~~[installation]~~ instructions~~[7]~~ are permitted to have combustible material in contact with their exterior surfaces.
2. When masonry fireplaces are constructed as part of masonry or concrete walls, combustible materials shall not be in contact with the masonry or concrete walls less than 12 inches (306 mm) from the inside surface of the nearest firebox lining.
3. Exposed combustible trim and the edges of sheathing materials, such as wood siding, flooring and drywall, are permitted to abut the masonry fireplace sidewalls and hearth extension, in accordance with Figure ~~[2111.11]~~ 2111.12, provided such combustible trim or sheathing is ~~[a minimum of]~~ not less than 12 inches (306 mm) from the inside surface of the nearest firebox lining.
4. Exposed combustible mantels or trim is permitted to be placed directly on the masonry fireplace front surrounding the fireplace opening, provided such combustible materials shall not be placed within 6 inches ~~[(153 mm)]~~ (152 mm) of a fireplace opening. Combustible material within 12 inches (306 mm) of the fireplace opening shall not project more than $\frac{1}{8}$ inch (3.2 mm) for each 1-inch (25 mm) distance from such opening.

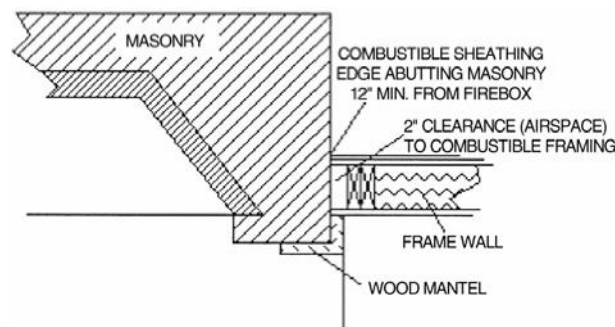

For SI: 1 inch = 25.4 mm

FIGURE ~~[211.11]~~ 2111.12
ILLUSTRATION OF EXCEPTION TO
FIREPLACE CLEARANCE PROVISION

~~[211.12 Mantel and trim. Woodwork or other combustible materials shall not be placed within 6 inches (152 mm) of a fire place opening. Combustible material within 12 inches (305 mm) of the fireplace opening shall not project more than ¼ inch (3.2 mm) for each 1 inch (25 mm) distance from such opening.]~~

2111.13 Fireplace fireblocking. All spaces between fireplaces and floors and ceilings through which fireplaces pass shall be fireblocked with approved noncombustible material securely fastened in place. The fireblocking of spaces between wood joists, beams or headers shall be to a depth of 1 inch (25 mm) and shall only be placed on strips of metal or metal lath laid across the spaces between combustible material and the chimney.

2111.14 Exterior air. Factory-built or masonry fireplaces covered in this section shall be equipped with an exterior air supply to ensure proper fuel combustion unless the room is mechanically ventilated and controlled so that the indoor pressure is neutral or positive.

2111.14.1 Factory-built fireplaces. Exterior combustion air ducts for factory-built fireplaces shall be listed components of the fireplace, and installed according to the fireplace manufacturer's instructions.

2111.14.2 Masonry fireplaces. Listed combustion air ducts for masonry fireplaces shall be installed according to the terms of their listing and manufacturer's instructions.

2111.14.3 Exterior air intake. The exterior air intake shall be capable of providing all combustion air from the exterior of the dwelling. The exterior air intake shall not be located within the garage, attic, basement or crawl space of the dwelling nor shall the air intake be located at an elevation higher than the firebox. The exterior air intake shall be covered with a corrosion-resistant screen of ¼-inch (6.4 mm) mesh.

2111.14.4 Clearance. Unlisted combustion air ducts shall be installed with a minimum 1-inch (25 mm) clearance to combustibles for all parts of the duct within 5 feet (1524 mm) of the duct outlet.

2111.14.5 Passageway. The combustion air passageway shall be [~~a minimum of~~] not less than 6 square inches (3870 mm²) and not more than 55 square inches (0.035 m²), except that combustion air systems for listed fireplaces or for fireplaces tested for emissions shall be constructed according to the fireplace manufacturer's instructions.

2111.14.6 Outlet. The exterior air outlet is permitted to be located in the back or sides of the firebox chamber or within 24 inches (610 mm) of the firebox opening on or near the floor. The outlet shall be closable and designed to prevent burning material from dropping into concealed combustible spaces.

SECTION BC 2112 MASONRY HEATERS

2112.1 Definition. A masonry heater is a heating appliance constructed of concrete or solid masonry, hereinafter referred to as “masonry,” which is designed to absorb and store heat from a solid fuel fire built in the firebox by routing the exhaust gases through internal heat exchange channels in which the flow path downstream of the firebox may include flow in a horizontal or downward direction before entering the chimney and which delivers heat by radiation from the masonry surface of the heater.

2112.2 Installation. Masonry heaters may be installed only when their use is permitted by the *New York City Air Pollution Control Code*. When such use is permitted, such appliances shall be operated in compliance with the *New York City Air Pollution Control Code*. Masonry heaters shall also be installed in accordance with this section and comply with one of the following:

1. Masonry heaters shall comply with the requirements of ASTM E 1602~~[; or]~~.
2. Masonry heaters shall be listed and labeled in accordance with UL 1482 or EN 15250 and installed in accordance with the manufacturer’s ~~[installation]~~ instructions.

2112.3 Footings and foundation. The firebox floor of a masonry heater shall be a minimum thickness of 4 inches (102 mm) of noncombustible material and be supported on a noncombustible footing and foundation in accordance with Section 2113.2.

2112.4 Seismic reinforcing. In structures assigned to Seismic Design Category D, masonry heaters shall be anchored to the masonry foundation in accordance with Section 2113.3. Seismic reinforcing shall not be required within the body of a masonry heater with a height that is equal to or less than 3.5 times its body width and where the masonry chimney serving the heater is not supported by the body of the heater. Where the masonry chimney shares a common wall with the facing of the masonry heater, the chimney portion of the structure shall be reinforced in accordance with Section 2113.

2112.5 Masonry heater clearance. Combustible materials shall not be placed within 36 inches ~~[(765 mm) or]~~ (914 mm) or the distance of the allowed reduction method from the outside surface of a masonry heater in accordance with NFPA 211, Section ~~[8-7 (clearances for solid fuel burning appliances),]~~ 12.6, and the required space between the heater and combustible material shall be fully vented to permit the free flow of air around all heater surfaces.

Exceptions:

- ~~[4.]~~ 1. ~~[When]~~ Where the masonry heater wall thickness is at least 8 inches (203 mm) ~~[thick]~~ of solid masonry and the wall thickness of the heat exchange channels is ~~[at least]~~ not less than 5 inches (127 mm) ~~[thick]~~ of solid masonry, combustible materials shall not be placed within 4 inches (102 mm) of the outside surface of a masonry heater. A clearance of ~~[at least]~~ not less than 8 inches (203 mm) shall be provided between the gas-tight capping slab of the heater and a combustible ceiling.
- ~~[5.]~~ 2. Masonry heaters listed and labeled in accordance with UL 1482 or EN 15250 and installed in accordance with the manufacturer’s instructions.

SECTION BC 2113 MASONRY CHIMNEYS

2113.1 General. ~~[A] The construction of masonry [chimney is a chimney constructed of concrete or masonry, hereinafter referred to as "masonry." Masonry]~~ chimneys consisting of solid masonry units, hollow masonry units grouted solid, or stone shall be [constructed, anchored, supported and reinforced as required in this chapter] in accordance with this section.

Chimneys shall be designed and constructed so as to provide the necessary draft and capacity for each appliance connected to them to completely exhaust the products of combustion to the outside air. The temperature on adjacent combustible surfaces shall not be raised above 160°F (71°C). Chimney and vents shall be designed to resist the effects of condensation that would cause deterioration of the chimney or vent.

In any case, the outlet shall be arranged so that the flue gases are not directed so that they jeopardize people, overheat combustible structures, or enter building openings in the vicinity of the outlet. Gas-fired appliances shall be vented in accordance with this code, the *New York City Fuel Gas Code* and NFPA 54.

Chimneys shall not be supported by the equipment they serve unless such equipment has been specifically designed for such loads.

2113.1.1 Chimney adequacy for temperature and gas action. Chimneys shall be of adequate structural strength and resistant to the temperatures to which they may be subjected and to the corrosive action of gases.

~~[2113.1.2 Chimney caps. Termination caps shall not be permitted and a 3-inch (76 mm) minimum drain shall be installed to receive collected water. A positive means shall be provided to prevent water from entering the appliance.]~~

~~[Exception: Termination caps shall be permitted on listed factory-built chimneys.]~~

~~[2113.1.2.1 Decorative shrouds. Decorative shrouds shall not be installed at the termination of factory-built chimneys except where such shrouds are listed and labeled for use with the specific factory-built chimney system and are installed in accordance with the manufacturers' installation instructions.]~~

~~[2113.1.3] 2113.1.2 Chimney linings.~~ The lining in chimneys shall not be considered as taking either compression or tension stresses.

~~[2113.1.4] 2113.1.3 Chimney expansion and contraction.~~ Expansion and contraction in chimney walls due to temperature variations shall be accommodated solely by the use of steel reinforcing rings.

~~[2113.1.5] 2113.1.4 Reinforcing rings.~~ Reinforcing rings shall be provided at all changes in wall thickness, at the top of the chimney, and above and below all flue openings.

~~[2113.1.6] 2113.1.5 [Adjoining] Existing chimneys and vents.~~ ~~[Adjoining] Existing chimneys and vents shall [be in accordance with]~~ comply with the requirements of Section 28-104.13 of

the *Administrative Code* and Sections 107.18 and ~~[2113.1.6.1]~~ 2113.1.5.1 through ~~[2113.1.6.8]~~ 2113.1.5.8 of this code.

~~[2113.1.6.1]~~ **2113.1.5.1 Responsibility of owner of taller building.** Whenever a building is erected, enlarged, or increased in height so that any portion of such building, except chimneys or vents, extends higher than the top of any ~~[previously constructed]~~ existing chimneys or vents within 100 feet (30 480 mm), the owner of such new or altered building shall have the responsibility of altering such chimneys or vents to make them conform with the requirements of this chapter. A chimney or vent that is no longer connected with a fireplace or combustion or other equipment for which a chimney or vent was required, shall be exempt from this requirement. Such alterations shall be accomplished by one of the following means or a combination thereof:

1. Carry up the ~~[previously constructed]~~ existing chimneys or vents to the height required in this chapter.
2. Offset such chimneys or vents to a distance beyond that required in this chapter from the new or altered building provided that the new location of the outlet of the offset chimney or vent shall otherwise comply with the requirements of this chapter.

Such requirements shall not dispense with or modify any additional requirements that may be applicable pursuant to rules of the New York City Department of Environmental Protection.

2113.1.5.1.1 Chimney and vent plan. Applications for a new or altered building shall include a chimney and vent plan submitted pursuant to Section 107.18.

~~[2113.1.6.2]~~ **2113.1.5.2 Protection of draft.** After the alteration of a chimney or vent as required by this section, it shall be the responsibility of the owner of the new or altered building to provide any mechanical equipment or devices necessary to maintain the proper draft in the equipment.

~~[2113.1.6.3]~~ **2113.1.5.3 Written notification, plans and required documents.** The owner of the new or altered building shall notify the owner of ~~[the]~~ any building that may require a chimney or vent to be altered. Notification, plans and required documents shall comply with the requirements of Sections 2113.1.5.3.1 through 2113.1.5.3.3. ~~[affected in writing at least 45 days before starting and request written consent to do such work. Such notice shall be accompanied by plans indicating the manner in which the proposed alterations are to be made.]~~

2113.1.5.3.1 First notice. Written notice in a form acceptable to the department shall be provided to the building owner not less than 60 days prior to a request for permit for construction on the new or altered building. Such notice shall include a request for access to determine the need to alter the existing chimney or vent and a description of such work. Notice shall be sent by regular mail and certified mail, return receipt requested. A copy of such return receipt shall be filed with the department.

2113.1.5.3.2 Second notice. Written notice in a form acceptable to the department shall be provided to the building owner not more than 45 days following commencement of work after a permit has been issued for the new or altered building. Such notice shall include a request for access to determine the need to alter the existing chimney or vent and a description of such work. Notice shall be sent by regular mail and certified mail, return receipt requested. The second notice shall also be posted by a licensed process server at the public entrance of the building requiring a chimney or vent to be altered. A copy of such return receipt and proof of service by the licensed process server shall be filed with the department.

Exceptions:

1. A second notice shall not be required where an application to alter the affected chimney or vent has been filed with the department.
2. A second notice shall not be required where access is granted and conditions are observed that result in a determination that chimney or vent alteration is not required and a revised chimney and vent plan is submitted to the department.

2113.1.5.3.3 Plans and required documentation for alteration work. Where access is granted and conditions are observed that result in a determination that chimney or vent alteration is required, plans for such alteration work shall be provided to the owner of the existing building and a request for written consent to submit construction documents and perform such work shall be made.

~~[2113.1.6.4]~~ **2113.1.5.4 Approval.** The [~~plans and method of~~] construction documents for the proposed chimney extension, alteration or relocation shall be [~~subject~~] submitted to the [~~approval of the commissioner~~] department pursuant to Section 28-104 of the *Administrative Code*. No certificate of occupancy shall be issued for the new building pursuant to Section 28-118.23 of the *Administrative Code* until the work associated with such construction documents for the proposed chimney extension, alteration or relocation has been signed-off by the department.

Exceptions:

1. A certificate of occupancy may be issued where access is granted and conditions are observed that result in a determination that chimney or vent alteration is not required and a revised chimney or vent plan is submitted pursuant to Section 107.18 of the New York City Building Code documenting such.
2. A certificate of occupancy may be issued in accordance with Section 28-118.23, Exception 2 of the *Administrative Code*.

~~[2113.1.6.5]~~ **2113.1.5.5 Refusal of consent.** If consent is not granted by the owner of the [~~previously constructed~~] affected building to do the alteration work required by this section, such owner shall signify his or her refusal in writing to the owner of the new or altered building and to the commissioner; and the owner of the new or altered building having

~~[submitted plans that conform to the requirements of this section]~~ provided the notices required by Section 2113.1.5.3 shall thereupon be released from any responsibility for the proper operation of the equipment due to loss of draft and for any health hazard or nuisance that may occur as a result of the new or altered building. Such responsibilities shall then be assumed by the owner of the previously constructed building. Similarly, should such owner fail to grant consent within 45 days from the date of [written request] the second notice or fail to signify his or her refusal, he or she shall then assume all responsibilities as prescribed above.

~~[2113.1.6.6]~~ **2113.1.5.6 Procedure.** It shall be the obligation of the owner of the new or altered building to:

1. Prepare and submit a chimney and vent plan to the department pursuant to Section 107.18.
2. Provide required notification pursuant to Section 2113.1.5.3.
3. Provide plans pursuant to Section 2113.1.5.3.3.
4. Prepare and submit construction documents to the department pursuant to Section 28-104 of the *Administrative Code* for the alteration of existing chimneys or vents which conform to the requirements of this chapter;
5. Obtain permit(s) for the proposed work in accordance with Section 28-105 of the *Administrative Code*;
6. Schedule this work so as to create a minimum of disturbance to the occupants of the affected building;
- [2] 7. Provide such essential services as are normally supplied by the equipment while it is out of service;
- [3] 8. Where necessary, support such extended chimneys, vents and equipment from this building or to carry up such chimneys or vents within his or her building;
- [4] 9. Provide for the maintenance, repair, and/or replacement of such extensions and added equipment; ~~and~~
- [5] 10. Make such alterations of the same material as the original chimney or vent so as to maintain the same quality and appearance, except where the owner of the chimney or vent shall give his or her consent to do otherwise. All work shall be done in such fashion as to maintain the architectural aesthetics of the existing building. Where there is practical difficulty in complying strictly with the provisions of this item, the commissioner may permit an equally safe alternative[-];
11. Comply with the tenant protection plan requirements of Section 28-120 of the *Administrative Code*; and

12. Comply with inspection and sign-off requirements of Section 28-116 of the Administrative Code.

~~[2113.1.6.7]~~ **2113.1.5.7 Existing violations.** Any existing violations on the previously constructed equipment shall be corrected by the owner of the equipment before any equipment is added or alterations made at the expense of the owner of the new or altered building.

~~[2113.1.6.8]~~ **2113.1.5.8 Variance.** The commissioner may grant a variance in accordance with the provisions of this code.

2113.2 Footings and foundations. ~~[Foundations]~~ Footings for masonry chimneys shall be constructed of concrete or solid masonry ~~[at least]~~ not less than 12 inches (305 mm) thick and shall extend at least 6 inches (152 mm) beyond the face of the foundation or support wall on all sides. Footings shall be founded on natural undisturbed earth or engineered fill below frost depth. In areas not subjected to freezing, footings shall be ~~[at least]~~ not less than 12 inches (305 mm) below finished grade.

2113.3 Seismic reinforcing. ~~[Masonry or concrete chimneys shall be constructed, anchored, supported and reinforced as required in this chapter. In Seismic Design Category C or D, masonry and concrete chimneys shall be reinforced and anchored as detailed in Sections 2113.3.1, 2113.3.2, and 2113.4. In Seismic Design Category B, reinforcement and seismic anchorage is not required.]~~ In structures assigned to Seismic Design Category A or B, or those exempt from seismic analysis, seismic reinforcement is not required. In structures assigned to Seismic Design Category C or D, masonry chimneys shall be analyzed and designed for seismic loading in accordance with TMS 402, and at a minimum shall be reinforced and anchored in accordance with Sections 2113.3.1, 2113.3.2, and 2113.4, Table 2111.1 and Figure 2111.1.

2113.3.1 Vertical ~~[reinforcing]~~ reinforcement. For chimneys up to 40 inches (1016 mm) wide, four No. 4 continuous vertical bars anchored in the foundation shall be placed in the concrete~~;~~ between wythes of solid masonry or within the cells of hollow unit masonry and grouted in accordance with Section ~~[2103.10]~~ 2103.3. Grout shall be prevented from bonding with the flue liner so that the flue liner is free to move with thermal expansion. For chimneys greater than 40 inches (1016 mm) wide, two additional No. 4 vertical bars shall be provided for each additional 40 inches (1016 mm) in width or fraction thereof.

2113.3.2 Horizontal ~~[reinforcing]~~ reinforcement. Vertical reinforcement shall be placed enclosed within ¼-inch (6.4 mm) ties, or other reinforcing of equivalent net cross-sectional area, spaced not to exceed 18 inches (457 mm) ~~[o-e.]~~ on center in concrete, or placed in the bed joints of unit masonry, at ~~[a minimum of]~~ not less than every 18 inches (457 mm) of vertical height. Two such ties shall be provided at each bend in the vertical bars.

2113.4 Seismic anchorage. Masonry ~~[and concrete]~~ chimneys and foundations ~~[in Seismic Design Category C or D]~~ shall be anchored at each floor, ceiling or roof line more than 6 feet (1829 mm) above grade~~;~~ ~~except where constructed completely within the exterior walls. Anchorage shall conform to the following requirements.]~~

~~[2113.4.1 Anchorage. Two]~~ with two $\frac{3}{16}$ -inch by 1-inch (4.8 mm by 25 mm) straps ~~[shall be]~~ embedded ~~[a minimum of]~~ not less than 12 inches (305 mm) into the chimney. Straps shall be hooked around the outer bars and extend 6 inches (152 mm) beyond the bend. Each strap shall be fastened to ~~[a minimum of]~~ not less than four floor joists with two $\frac{1}{2}$ -inch (12.7 mm) bolts.

Exception: Seismic anchorage is not required for the following:

1. In structures assigned to Seismic Design Category A or B.
2. Where the masonry fireplace is constructed completely within the exterior walls.

2113.5 Corbeling. Masonry chimneys shall not be corbeled more than half of the chimney's wall thickness from a wall or foundation, nor shall a chimney be corbeled from a wall or foundation that is less than 12 inches (305 mm) in thickness unless it projects equally on each side of the wall, except that on the second story of a two-story dwelling, corbeling of chimneys on the exterior of the enclosing walls is permitted to equal the wall thickness. The projection of a single course shall not exceed one-half the unit height or one-third of the unit bed depth, whichever is less. No masonry shall be corbeled from hollow or cavity wall masonry units.

2113.6 Changes in dimension. The chimney wall or chimney flue lining shall not change in size or shape within 6 inches (152 mm) above or below where the chimney passes through floor components, ceiling components or roof components.

2113.7 Offsets. Where a masonry chimney is constructed with a fireclay flue liner surrounded by one wythe of masonry, the maximum offset shall be such that the centerline of the flue above the offset does not extend beyond the center of the chimney wall below the offset. Where the chimney offset is supported by masonry below the offset in an approved manner, the maximum offset limitations shall not apply. Each individual corbeled masonry course of the offset shall not exceed the projection limitations specified in Section 2113.5.

2113.8 Additional load. Chimneys shall not support loads other than their own weight unless they are designed and constructed to support the additional load. Masonry chimneys are permitted to be constructed as part of the masonry walls or concrete walls of the building.

2113.9 Termination. Chimneys serving appliances that operate at less than 600°F (316°C) shall extend at least 3 feet (914 mm) above the highest construction, such as a roof ridge, parapet wall, or penthouse, within 10 feet (3048 mm) of the chimney outlet, whether the construction is on the same building as the chimney or on another building. However, such constructions do not include other chimneys, vents, or open structural framing. Any chimney located beyond 10 feet (3048 mm) from such construction, but not more than the distance determined from Equation ~~[21-5]~~ 21-2 and Table 2113.9, shall be at least as high as the construction.

Chimneys serving appliances that operate at between 600°F (316°C) and 1000°F (538°C) shall extend at least 10 feet (3048 mm) above the highest construction, such as a roof ridge, or parapet wall or penthouse within 20 feet (6096 mm) of the chimney outlet, whether the construction is on the same building as the chimney or on another building. However, such construction does not include other chimneys, vents or open structural framing. Any chimney located beyond 20 feet (6096

mm) from such construction, but not more than the distance determined from Equation [21-5] 21-2 and Table 2113.9, shall be at least as high as the construction.

$$D = F \times \sqrt{A} \quad \text{(Equation [21-5] 21-2)}$$

where:

- D = Distance, in feet, measured from the center of the chimney outlet to the nearest edge of the construction.
- F = Value determined from Table 2113.9.
- A = Free area, in square inches, of chimney flue space.

TABLE 2113.9
“F” FACTOR FOR DETERMINING CHIMNEY DISTANCES

“F” FACTOR FOR DETERMINING CHIMNEY DISTANCES			
Type of Fuel	“F” Factor		
	600°F (316°C) and less	600°F (316°C) to 1000°F (538°C)	Greater than 1000°F (538°C)
Gas	2	2	3
No. 2 fuel oil	2.5	2.5	3
No. 4, No. 6 fuel oils, solid fuels and incinerators	3	3	3

2113.9.1 Chimney caps. Masonry chimneys shall have a concrete, metal or stone cap, sloped to shed water, a drip edge and a caulked bond break around any flue liners in accordance with ASTM C 1283.

~~[2113.9.1]~~ **2113.9.2 Spark arrestors.** Where a spark arrestor is installed on a masonry chimney, the spark arrestor shall meet all of the following requirements:

1. The net free area of the arrestor shall be not ~~be~~ less than four times the net free area of the outlet of the chimney flue it serves.
2. The arrestor screen shall have heat and corrosion resistance equivalent to 19-gage galvanized steel or 24-gage stainless steel.
3. Openings shall not permit the passage of spheres having a diameter greater than ½ inch (12.7 mm) nor block the passage of spheres having a diameter less than ⅜ inch (9.5 mm).
4. The spark arrestor shall be accessible for cleaning and the screen or chimney cap shall be removable to allow for cleaning of the chimney flue.

2113.9.3 Rain caps. Termination caps shall not be permitted and a 3-inch (76 mm) minimum drain shall be installed to receive collected water. A positive means shall be provided to prevent water from entering the appliance.

Exception: Termination caps shall be permitted on listed factory-built chimneys.

2113.9.3.1 Decorative shrouds. Decorative shrouds shall not be installed at the termination of factory-built chimneys except where such shrouds are listed and labeled for use with the specific factory-built chimney system and are installed in accordance with the manufacturers' installation instructions.

2113.10 Wall thickness. Masonry chimney walls shall be constructed of concrete, solid masonry units or hollow masonry units grouted solid with not less than 4 inches (102 mm) nominal thickness, or 8 inches (203 mm) nominal thickness for chimney walls extending more than 3 feet (914 mm) above the highest lateral support point.

2113.11 Flue lining (material). Masonry chimneys shall be lined. The lining material shall be appropriate for the type of appliance connected, according to the terms of the appliance listing and the manufacturer's instructions.

2113.11.1 Residential-type appliances and low heat appliances (general). Flue lining systems shall comply with one of the following:

1. Clay flue lining complying with the requirements of ASTM C 315.
2. Listed chimney lining systems complying with UL 1777.
3. Factory-built chimneys or chimney units listed for installation within masonry chimneys.
4. Other approved materials that will resist corrosion, erosion, softening or cracking from flue gases and condensate at temperatures up to 1,800°F (982°C).

2113.11.1.1 Flue linings for specific appliances. Flue linings other than those covered in Section 2113.11.1 intended for use with specific appliances shall comply with Sections 2113.11.1.2 through 2113.11.1.4 and Sections 2113.11.2 and 2113.11.3.

2113.11.1.2 Gas appliances. Flue lining systems for gas appliances shall be in accordance with the *New York City Fuel Gas Code* and ULC-S635.

2113.11.1.3 Pellet fuel-burning appliances. Pellet fuel-burning appliances may be installed only when their use is permitted by the *New York City Air Pollution Control Code*. Any such appliances shall be listed and labeled and shall be installed in accordance with the terms of the listing. If permitted, such appliances shall be operated in compliance with the *New York City Air Pollution Control Code*. Flue lining and vent systems for use in masonry chimneys with pellet fuel-burning appliances shall be limited to flue lining systems complying with Section 2113.11.1 and pellet vents listed for installation within masonry chimneys [~~see Section 2113.11.1.5 for marking~~]. See Section 2113.11.1.5 for marking.

2113.11.1.4 Oil-fired appliances approved for use with L-vent. Flue lining and vent systems for use in masonry chimneys with oil-fired appliances approved for use with Type L vent shall be limited to flue lining systems complying with Section 2113.11.1 and listed chimney liners complying with UL 641 [~~see Section 2113.11.1.5 for marking~~]. See Section 2113.11.1.5 for marking.

2113.11.1.5 Notice of usage. When a flue is relined with a material not complying with Section 2113.11.1, the chimney shall be plainly and permanently identified by a label attached to a wall, ceiling or other conspicuous location adjacent to where the connector enters the chimney. The label shall include the following message or equivalent language: “This chimney is for use only with (type or category of appliance) that burns (type of fuel). Do not connect other types of appliances.”

2113.11.2 [~~Concrete and masonry~~] Masonry chimneys for [medium-heat] medium-heat appliances. Masonry chimneys for medium-heat appliances shall comply with the provisions of Sections 2113.11.2.1 through 2113.11.2.5.

~~[2113.11.2.1 General. Concrete and masonry chimneys for medium-heat appliances shall comply with Sections 2113.1 through 2113.5.]~~

~~[2113.11.2.2] 2113.11.2.1 Construction.~~ Chimneys for medium-heat appliances shall be constructed of solid masonry units [~~or of concrete~~] with walls [~~a minimum of~~] not less than 8 inches (203 mm) thick, or with stone masonry [~~a minimum of~~] not less than 12 inches (305 mm) thick. Chimneys for medium-heat appliances constructed with radial brick may be permitted to have different requirements. Design of all such chimneys shall be submitted to the commissioner for approval.

~~[2113.11.2.3] 2113.11.2.2 Lining.~~ [~~Concrete and masonry~~] Masonry chimneys shall be lined with an approved medium-duty refractory brick [~~a minimum of~~] not less than 4½ inches (114 mm) thick laid on the 4½-inch bed (114 mm) in an approved medium-duty refractory mortar. The lining shall start 2 feet (610 mm) or more below the lowest chimney connector entrance. Chimneys terminating 25 feet (7620 mm) or less above a chimney connector entrance shall be lined to the top.

~~[2113.11.2.4] 2113.11.2.3 Multiple passageway.~~ [~~Concrete and masonry~~] Masonry chimneys containing more than one passageway shall have the liners separated by a minimum 4-inch-thick (102 mm) concrete or solid masonry wall.

~~[2113.11.2.5] 2113.11.2.4 Termination height.~~ Chimneys serving appliances that operate at greater than 1,000°F (538°C) shall extend at least 20 feet (6096 mm) above the highest construction, such as roof ridge, parapet wall, penthouse, or other obstruction within 50 feet (15 240 mm) of the chimney outlet, whether the construction is on the same building as the chimney or in another building. However, such construction does not include other chimneys, vents, or open structural framing. Any chimney located beyond 50 feet (15 240 mm) from such construction but not more than the distance determined from Equation [~~21-5~~] 21-2 and Table 2113.9, shall be at least as high as the construction.

~~[2113.11.2.6] 2113.11.2.5 Clearance.~~ A minimum clearance of 4 inches (102 mm) shall be provided between the exterior surfaces of a [~~concrete or~~] masonry chimney for medium-heat appliances and combustible material.

2113.11.3 [~~Concrete and masonry~~] Masonry chimneys for high-heat appliances. Masonry chimneys for high-heat appliances shall comply with the provisions of Sections 2113.11.3.1 through 2113.11.3.4.

~~[2113.11.3.1 General. Concrete and masonry chimneys for high-heat appliances shall comply with Sections 2113.1 through 2113.5.]~~

~~[2113.11.3.2]~~ **2113.11.3.1 Construction.** Chimneys for high-heat appliances shall be constructed with double walls of solid masonry units or of concrete, each wall to be ~~[a minimum of]~~ not less than 8 inches (203 mm) thick with a minimum airspace of 2 inches (51 mm) between the walls. Alternate chimney designs for high-heat appliances constructed with radial brick shall be permitted subject to the approval of the commissioner.

~~[2113.11.3.3]~~ **2113.11.3.2 Lining.** The inside of the interior wall shall be lined with an approved high-duty refractory brick, ~~[a minimum of]~~ not less than 4½ inches (114 mm) thick laid on the 4½-inch bed (114 mm) in an approved high-duty refractory mortar. The lining shall start at the base of the chimney and extend continuously to the top.

~~[2113.11.3.4]~~ **2113.11.3.3 Termination height.** ~~[Concrete and masonry]~~ Masonry chimneys for high-heat appliances shall extend ~~[at least]~~ not less than 20 feet [(6069 mm)] (6096 mm) above the highest construction, such as roof ridge, parapet wall, penthouse, or other obstruction within 50 feet (15 240 mm) of the chimney outlet, whether the construction is on the same building as the chimney or on another building. However, such constructions do not include other chimneys, vents, or open structural framing. Any chimney located beyond 50 feet (15 240 mm) from such construction but not more than the distance determined from Equation ~~[21-5]~~ 21-2 and Table 2113.9, shall be at least as high as the construction.

~~[2113.11.3.5]~~ **2113.11.3.4 Clearance.** ~~[Concrete and masonry]~~ Masonry chimneys for high-heat appliances shall have approved clearance from buildings and structures to prevent overheating combustible materials, permit inspection and maintenance operations on the chimney and prevent danger of burns to persons.

2113.12 Clay flue lining (installation). Flue liners shall be installed in accordance with ASTM C 1283 and extend from a point not less than 8 inches (203 mm) below the lowest inlet or, in the case of fireplaces, from the top of the smoke chamber~~[.]~~ to a point above the enclosing walls. The lining shall be carried up vertically, with a maximum slope no greater than 30 degrees (0.52 rad) from the vertical. ~~[Clay flue liners shall be laid in medium-duty refractory mortar conforming to ASTM C 199, with tight mortar joints left smooth on the inside and installed to maintain an airspace or insulation not to exceed the thickness of the flue liner separating the flue liners from the interior face of the chimney masonry walls. Flue lining shall be supported on all sides. Only enough mortar shall be placed to make the joint and hold the liners in position.]~~

Clay flue liners shall be laid in medium-duty nonwater-soluble refractory mortar conforming to ASTM C 199 with tight mortar joints left smooth on the inside and installed to maintain an airspace or insulation not to exceed the thickness of the flue liner separating the flue liners from the interior face of the chimney masonry walls. Flue lining shall be supported on all sides. Only enough mortar shall be placed to make the joint and hold the liners in position.

2113.13 Additional requirements. Masonry chimneys shall also comply with the additional requirements of Sections 2113.13.1 and 2113.13.2.

2113.13.1 Listed materials. Listed materials used as flue linings shall be installed in accordance with the terms of their listings and the manufacturer's instructions.

2113.13.2 Space around lining. The space surrounding a chimney lining system or vent installed within a masonry chimney shall not be used to vent any other appliance.

Exception: This shall not prevent the installation of a separate flue lining in accordance with the manufacturer's instructions.

2113.14 Multiple flues. When two or more flues are located in the same chimney, masonry wythes shall be built between adjacent flue linings. The masonry wythes shall be at least 4 inches (102 mm) thick and bonded into the walls of the chimney.

Exception: When venting only one appliance, two flues are permitted to adjoin each other in the same chimney with only the flue lining separation between them. The joints of the adjacent flue linings shall be staggered [~~at least~~] not less than 4 inches (102 mm).

2113.15 Flue area (appliance). Chimney flues shall not be smaller in area than the area of the connector from the appliance. Chimney flues connected to more than one appliance shall be not [~~be~~] less than the area of the largest connector plus 50 percent of the areas of additional chimney connectors.

Exceptions:

1. Chimney flues serving oil-fired appliances sized in accordance with the *New York City Mechanical Code* and NFPA 31.
2. Chimney flues serving gas-fired appliances sized in accordance with the *New York City Fuel Gas Code*.

2113.16 Flue area (masonry fireplace). Flue sizing for chimneys serving fireplaces shall be in accordance with Section 2113.16.1 or 2113.16.2.

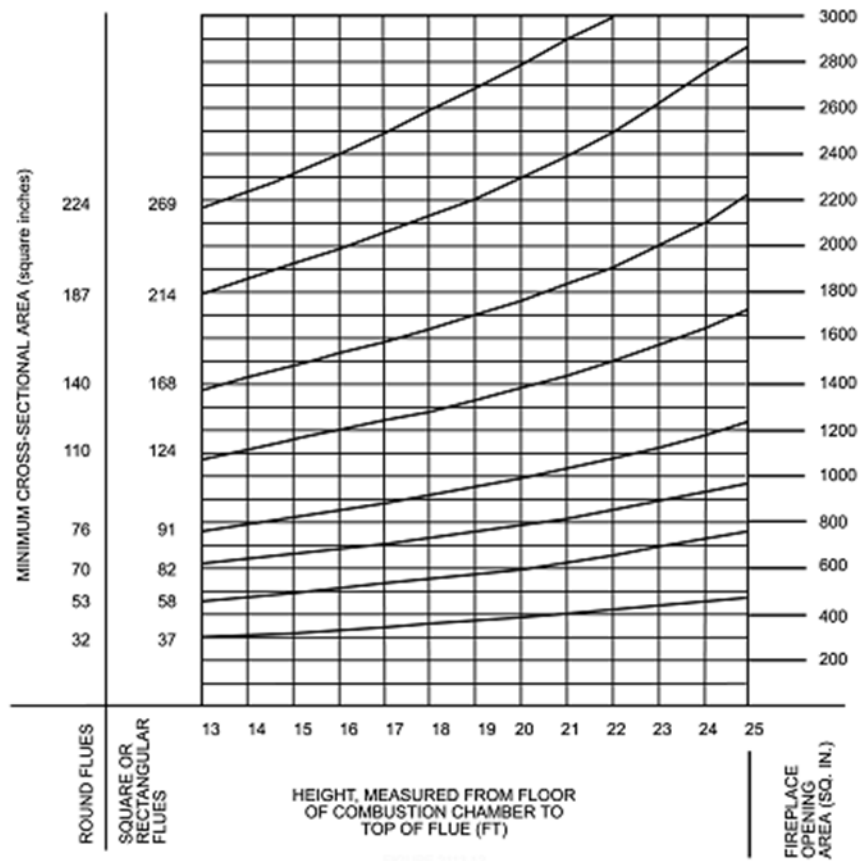

For SI: 1 inch = 25.4 mm, 1 square inch = 645 mm².

**FIGURE 2113.16
FLUE SIZES FOR MASONRY CHIMNEYS**

2113.16.1 Minimum area. Round chimney flues shall have a minimum net cross-sectional area of ~~[at least]~~ not less than 1/12 of the fireplace opening. Square chimney flues shall have a minimum net cross-sectional area of ~~[at least]~~ not less than 1/10 of the fireplace opening. Rectangular chimney flues with an aspect ratio less than 2 to 1 shall have a minimum net cross-sectional area of ~~[at least]~~ not less than 1/10 of the fireplace opening. Rectangular chimney flues with an aspect ratio of 2 to 1 or more shall have a minimum net cross-sectional area of ~~[at least]~~ not less than 1/8 of the fireplace opening.

TABLE 2113.16(1)
NET CROSS-SECTIONAL AREA OF ROUND FLUE SIZES^a

FLUE SIZE, INSIDE DIAMETER (inches)	CROSS-SECTIONAL AREA (square inches)
6	28
7	38
8	50
10	78
10 ³ / ₄	90
12	113
15	176
18	254

For SI: 1 inch = 25.4 mm, 1 square inch = 645.16 mm².
a. Flue sizes are based on ASTM C 315.

2113.16.2 Determination of minimum area. The minimum net cross-sectional area of the flue shall be determined in accordance with Figure 2113.16. A flue size providing [~~at least~~] not less than the equivalent net cross-sectional area shall be used. Cross-sectional areas of clay flue linings are as provided in Tables 2113.16(1) and 2113.16(2) or as provided by the manufacturer or as measured in the field. The height of the chimney shall be measured from the firebox floor to the top of the chimney flue.

TABLE 2113.16(2)
NET CROSS-SECTIONAL AREA OF SQUARE
1. AND RECTANGULAR FLUE SIZES^a

Flue Size, Outside Nominal Dimensions (inches)	Cross-Sectional Area (square inches)
4.5 × 8.5	23
4.5 × 13	34
8 × 8	42
8.5 × 8.5	49
8 × 12	67
8.5 × 13	76
12 × 12	102
8.5 × 18	101
13 × 13	127
12 × 16	131
13 × 18	173
16 × 16	181
16 × 20	222
18 × 18	233
20 × 20	298
20 × 24	335
24 × 24	431

For SI: 1 inch = 25.4 mm, 1 square inch = 645.16 mm².

a. Flue sizes are based on ASTM C 315.

2113.17 Inlet. Inlets to masonry chimneys shall enter from the side. Inlets shall have a thimble of fireclay, rigid refractory material or metal that will prevent the connector from pulling out of the inlet or from extending beyond the wall of the liner.

2113.18 Masonry chimney cleanout openings. Cleanout openings shall be provided within 6 inches (152 mm) of the base of each flue within every masonry chimney. The upper edge of the cleanout shall be located [~~at least~~] not less than 6 inches (152 mm) below the lowest chimney inlet opening. The height of the opening shall be [~~at least~~] not less than 6 inches (152 mm). The cleanout shall be provided with a noncombustible cover.

Exception: Chimney flues serving masonry fireplaces, where cleaning is possible through the fireplace opening.

2113.19 Chimney clearances. Any portion of a masonry chimney located in the interior of the building or within the exterior wall of the building shall have a minimum airspace clearance to combustibles of 2 inches (51 mm). Chimneys located entirely outside the exterior walls of the building, including chimneys that pass through the soffit or cornice, shall have a minimum airspace

clearance of 1 inch (25 mm). The airspace shall not be filled, except to provide fireblocking in accordance with Section 2113.20.

Exceptions:

1. Masonry chimneys equipped with a chimney lining system listed and labeled for use in chimneys in contact with combustibles in accordance with UL 1777 and [~~ULC-S635~~] ULC-S635, and installed in accordance with the manufacturer's instructions, are permitted to have combustible material in contact with their exterior surfaces.
2. Where masonry chimneys are constructed as part of masonry [~~or concrete~~] walls, combustible materials shall not be in contact with the masonry [~~or concrete~~] wall less than 12 inches (305 mm) from the inside surface of the nearest flue lining.
3. Exposed combustible trim and the edges of sheathing materials, such as wood siding, are permitted to abut the masonry chimney sidewalls, in accordance with Figure 2113.19, provided such combustible trim or sheathing is [~~a minimum of~~] not less than 12 inches (305 mm) from the inside surface of the nearest flue lining. Combustible material and trim shall not overlap the corners of the chimney by more than 1 inch (25 mm).

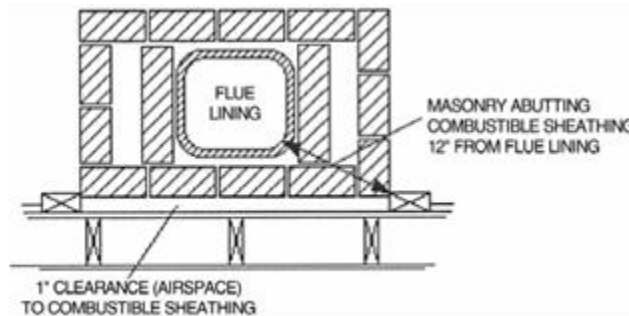

For SI: 1 inch = 25.4 mm

1

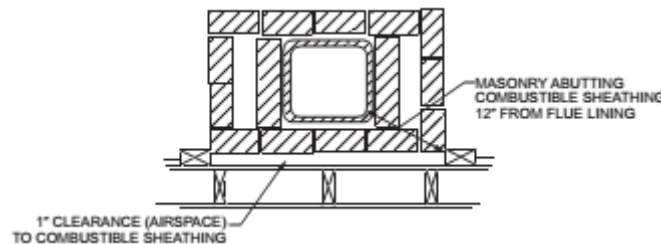

**FIGURE 2113.19
ILLUSTRATION OF EXCEPTION TO
CHIMNEY CLEARANCE PROVISION**

2113.19.1 Additional requirements for clearance.

1. Trimmers shall be not less than 5 inches (127 mm) from the inside face of the concrete or masonry chimney wall. Finished flooring shall have at least $\frac{1}{2}$ inch (13 mm) clearance from chimney walls.
2. A clearance of at least 2 inches (51 mm) shall be provided between the exterior surfaces of interior masonry [~~or concrete~~] chimneys for all wood-burning appliances.
3. No combustible lathing, furring, or plaster grounds shall be placed against a chimney at any point more than $1\frac{1}{2}$ inches (38 mm) from the corner of the chimney; but this shall not prevent plastering directly on masonry or on metal lath and metal furring nor shall it prevent placing chimneys for low-temperature equipment entirely on the exterior of a building against the sheathing.

2113.20 Chimney fireblocking. All spaces between chimneys and floors and ceilings through which chimneys pass shall be fireblocked with noncombustible material securely fastened in place. The fireblocking of spaces between wood joists, beams or headers shall be [~~to a depth of 1 inch (25 mm) and shall only~~] self-supporting or be placed on strips of metal or metal lath laid across the spaces between combustible material and the chimney.

2113.21 Test run. All new chimneys shall be test run by the registered design professional responsible for the testing under standard conditions to demonstrate fire safety and the complete exhausting of smoke and the products of combustion to the outer air. The results of such test run shall be certified as correct by the design professional engineer responsible for the test and shall be submitted in writing to the department.

2113.22 Requirement of a smoke test. A smoke test shall be made as outlined below. Any faults or leaks found shall be corrected. Such smoke test shall be witnessed by a representative of the commissioner. In lieu thereof, the commissioner may accept the test report of the design professional engineer responsible for the test, which shall be submitted in writing to the department.

2113.22.1 Smoke test. To determine the tightness of chimney construction, a smoke test shall be made in accordance with the following conditions and requirements:

1. The equipment, materials, power and labor necessary for such test shall be furnished by, and at the expense of, the owner or holder of the work permit.
2. If the test shows any evidence of leakage or other defects, such defects shall be corrected in accordance with the requirement of this chapter and the test shall be repeated until the results are satisfactory.
3. Method of test. The chimney shall be filled with a thick penetrating smoke produced by one or more smoke machines, or smoke bombs, or other equivalent method. As the smoke appears at the stack opening on the roof, such opening shall be tightly closed, and a pressure equivalent to $\frac{1}{2}$ inch (12.7 mm) column of water measured at the base of the stack shall be applied. The test shall be conducted for a length of time sufficient to permit the inspection of the chimney.

SECTION BC 2114 STRUCTURAL INTEGRITY REQUIREMENTS

2114.1 General. Load-bearing masonry structures shall be reinforced to meet all of the requirements of this section. However, reinforcement provided for gravity, seismic or wind forces or for other purposes may be regarded as satisfying part of, or the whole of, these requirements. Reinforcement provided for one requirement may be counted towards the other requirements.

2114.2 Continuity and ties. Load-bearing masonry structures shall be reinforced to obtain a continuous system of vertical and horizontal ties. Continuity of all ties shall be ensured by providing lap, welded or mechanical tension splices. The following requirements shall be met for walls, columns and piers:

2114.2.1 Horizontal. At each floor and roof level, continuous horizontal ties shall be provided in all load-bearing masonry walls, and around the perimeter of the building. Minimum horizontal tie reinforcement shall be not less than the equivalent of two No. 4 bars.

2114.2.1.1 Location of horizontal ties. Ties shall be located within the thickness of walls or beams, where they occur, or within 1 foot (305 mm) of the edge of slab, where walls or beams do not occur.

2114.2.1.2 End connections of horizontal ties. All horizontal ties shall be terminated in a perpendicular horizontal tie. Where no perpendicular horizontal tie exists within 4 feet (1219 mm) of the end of a wall, the horizontal tie shall be anchored at the end of the wall. The vertical reinforcement at the end of such walls shall not be less than two No. 4 bars placed within 16 inches (406 mm) of the end of the wall. This vertical reinforcement shall be continuous from the lowest to highest level of the wall, and anchored at each end in a horizontal tie or the foundation element.

2114.2.2 End connections. Where slab or beam elements are supported on a masonry wall, column or pier, the connection shall be designed to sustain an axial tension capacity equal to the greater of the vertical shear capacity of the connected element at either end or 2 percent of the maximum factored vertical dead and live load in the compression masonry element. The design of the end connections shall ensure the transfer of such loads to horizontal or vertical ties.

Where more than one element frames in one direction, none of the elements or connections shall have an axial tension capacity of less than 1 percent of the vertical load.

For the design of the connections, the transverse shear force and the axial tensile force need not be considered to act simultaneously.

The reinforcement of the end connections shall be equivalent to at least one No. 4 bar, at a maximum spacing of 24 inches (610 mm) on center. Where end connections occur at a masonry pier or column, reinforcement equivalent to a minimum of four fully developed No. 4 bars shall be provided. The reinforcement shall be distributed around the perimeter of the column or pier. The minimum anchorage into both the slab and the masonry compression element shall be equivalent to the capacity of the fully developed No. 4 bar.

Where the floor extends on both sides of a bearing wall, the portion of the tie within the slab shall alternate between both sides.

2114.2.3 Vertical ties. Each column, pier and wall shall be vertically tied continuously from its lowest to highest level. The vertical reinforcement shall be terminated in a horizontal tie or foundation or their equivalent. Where openings in bearing walls greater than 24 inches (610 mm) in height occur, ties shall be provided at each side of the opening that extend and are anchored in the masonry above and below the opening. Vertical ties shall be placed on both sides of control joints in bearing walls.

2114.2.3.1 Vertical ties reinforcing. Vertical tie reinforcing shall not be less than the equivalent of one No. 4 bar, at a maximum spacing of 48 inches (1219 mm) on center. A minimum of four continuous No.4 bars shall be provided per masonry column or pier.

§ 22. Chapter 22 of the New York city building code, as amended by local law number 141 for the year 2013, is amended to read as follows:

CHAPTER 22 STEEL

SECTION BC 2201 GENERAL

2201.1 Scope. The provisions of this chapter govern the quality, design, fabrication and erection of steel ~~[used structurally in buildings or structures]~~ construction.

2201.2 Special inspection. Steel shall be subject to the requirements of special inspection in accordance with Chapter 17.

SECTION BC 2202 DEFINITIONS

2202.1 Definitions. The following ~~[words and terms shall, for the purposes of this chapter and as used elsewhere in this code, have the meaning shown herein]~~ terms are defined in Chapter 2.

STEEL CONSTRUCTION, COLD-FORMED. ~~[That type of construction made up entirely or in part of steel structural members cold formed to shape from sheet or strip steel such as roof deck, floor and wall panels, studs, floor joists, roof joists and other structural elements.]~~

STEEL ELEMENT, STRUCTURAL.

STEEL JOIST. ~~[Any steel structural member of a building or structure made of hot-rolled or cold-formed solid or open web sections, or riveted or welded bars, strip or sheet steel members, or slotted and expanded, or otherwise deformed rolled sections.]~~

~~**[STEEL MEMBER, STRUCTURAL.** Any steel structural member of a building or structure consisting of a rolled steel structural shape other than cold formed steel, or steel joist members.]~~

SECTION BC 2203 IDENTIFICATION AND PROTECTION OF STEEL FOR STRUCTURAL PURPOSES

2203.1 Identification. Identification of structural steel ~~[members]~~ elements shall ~~[comply]~~ be in accordance with the requirements contained in AISC ~~[360]~~ 303. Identification of cold-formed steel members shall ~~[comply]~~ be in accordance with the requirements contained in AISI S100. Identification of cold-formed steel light-frame construction shall also comply with the requirements contained in AISI ~~[S200]~~ S240 or AISI S220, as applicable. Other steel furnished for structural ~~[load carrying]~~ load-carrying purposes shall be properly identified for conformity to the ordered grade in accordance with the specified ASTM standard or other specification and the provisions of this chapter. ~~[Steel that]~~ Where the steel grade is not readily identifiable ~~[as to grade]~~ from marking and test records, the steel shall be tested to determine conformity to such standards.

2203.2 Protection. ~~[Painting]~~ Coating of structural steel ~~[members]~~ elements shall ~~[comply]~~ be in accordance with ~~[the requirements contained in]~~ AISC 360. ~~[Painting]~~ Coating of open-web steel joists and joist girders shall ~~[comply]~~ be in accordance with ~~[the requirements of SJI CJ 1.0, SJI JG 1.1, SJI K 1.1 and SJI LH/DLH 1.1]~~ SJI 100 and SJI 200. Individual structural members and assembled panels of cold-formed steel construction shall be protected against corrosion in accordance with the requirements contained in AISI S100. Protection of cold-formed steel light-frame construction shall ~~[also comply]~~ be in accordance with ~~[the requirements contained in]~~ AISI ~~[S200]~~ S240 or AISI S220, as applicable.

SECTION BC 2204 CONNECTIONS

2204.1 Welding. The details of design, workmanship and technique for welding~~[, inspection of welding]~~ and qualification of welding ~~[operators]~~ procedures and personnel shall ~~[conform to the requirements of]~~ be in accordance with the specifications listed in Sections 2205, 2206, 2207, ~~[2209]~~ 2208, 2210 and [2210] 2211. ~~[Special]~~ For special inspection of welding ~~[shall be provided where required by]~~, see Section [1704] 1705.2.

2204.2 Bolting. The design, installation and inspection of bolts shall be in accordance with the requirements of ~~[the specifications listed in]~~ Sections 2205, 2206, ~~[2209]~~ 2207, 2210 and [2210] 2211. ~~[Special]~~ For special inspection of the installation of high-strength bolts ~~[shall be provided where required by]~~, see Section [1704] 1705.2.

~~[2204.2.1]~~ **2204.3 Anchor rods.** Anchor rods shall be set ~~[accurately to the pattern and dimensions called for on the plans.]~~ in accordance with the approved construction documents. The protrusion of the threaded ends through the connected material shall ~~[be sufficient to]~~ fully engage the threads of the nuts~~[, but shall not be greater than the length of the threads on the bolts]~~. The entire projection of the rod beyond the connected material shall be fully threaded.

SECTION BC 2205 STRUCTURAL STEEL

2205.1 General. The design, fabrication and erection of structural steel ~~[for]~~ elements in buildings ~~[and structures]~~, including materials used for such elements, shall be in accordance with AISC 360.

~~[Where required, the seismic design of steel structures shall be in accordance with the additional provisions of Section 2205.2.]~~

2205.1.1 Structural steel. Material for use as structural steel not listed in AISC 360 may be used in accordance with AISC 360 when approved by the commissioner for such use. Refer to Section 28-113.2.2 of the ~~[Administrative Code]~~ *Administrative Code* for provisions relating to approval of alternative materials.

2205.2 Seismic ~~[requirements for steel structures]~~ design and detailing. ~~[The design of structural steel structures to resist seismic forces]~~ Where required, a building's seismic design, detailing, material, fabrication and erection shall be in accordance with [the provisions of] Section 2205.2.1 or 2205.2.2[for the appropriate seismic design category], as applicable.

2205.2.1 Structural steel seismic force-resisting systems. The design, detailing, fabrication and erection of structural steel seismic force-resisting systems, and the material used for such systems, shall be in accordance with the provisions of Section 2205.2.1.1 or 2205.2.1.2, as applicable.

~~[2205.2.1]~~ **2205.2.1.1 Seismic Design Category [A,] B or C.** ~~[Structural steel structures]~~ Structures assigned to Seismic Design Category [A,] B or C shall be of any construction permitted in Section 2205. [An R factor as set forth in Section 12.2.1 of ASCE 7 for the appropriate steel system is permitted where the structure is designed and detailed in accordance with the provisions of AISC 341, Part I. Systems not detailed in accordance with the above shall use the R factor in Section 12.2.1 of ASCE 7 designated for "structural steel systems not specifically detailed for seismic resistance."] Where a response modification coefficient, R, in accordance with Table 1613.5, is used for the design of structures assigned to Seismic Design Category B or C, the structures shall be designed and detailed in accordance with the requirements of AISC 341.

Exception: The response modification coefficient, R, designated for "Steel systems not specifically detailed for seismic resistance, excluding cantilever column systems" in Table 1613.5, shall be permitted for systems designed and detailed in accordance with AISC 360, and need not be designed and detailed in accordance with AISC 341.

~~[2205.2.2]~~ **2205.2.1.2 Seismic Design Category D.** ~~[Structural steel structures]~~ Structures assigned to Seismic Design Category D shall be designed and detailed in accordance with AISC 341, [Part I] except as specified in Table 1613.5.

2205.2.2 Structural steel elements. The design, detailing, fabrication and erection of structural steel elements in seismic force-resisting systems other than those covered in Section 2205.2.1, including struts, collectors, chords and foundation elements, shall be in accordance with AISC 341 where either of the following applies:

1. The structure is assigned to Seismic Design Category D except as specified in Table 1613.5.
2. A response modification coefficient, R, greater than 3 in accordance with Table 1613.5, is used for the design of the structure assigned to Seismic Design Category B or C.

~~[2205.3 Seismic requirements for composite construction. The design, construction and quality of composite steel and concrete components that resist seismic forces shall conform to the requirements of the AISC 360 and ACI 318. An R factor as set forth in Section 12.2.1 of ASCE 7 for the appropriate composite steel and concrete system is permitted where the structure is designed and detailed in accordance with the provisions of AISC 341, Part II. In Seismic Design Category B or above, the design of such systems shall conform to the requirements of AISC 341, Part II.]~~

~~[2205.3.1 Seismic Design Category D. Composite structures are permitted in Seismic Design Categories D Seismic Categories D, subject to the limitations in Section 12.2.1 of ASCE 7, where substantiating evidence is provided to demonstrate that the proposed system will perform as intended by AISC 341, Part II. The substantiating evidence shall be subject to the commissioner's approval. Where composite elements or connections are required to sustain inelastic deformations, the substantiating evidence shall be based on cyclic testing.]~~

~~[2205.6] 2205.3 Fabrication, erection and quality control. In addition to the provisions for fabrication, erection and quality control in AISC 360, the following provisions shall be used.~~

~~[2205.6.1] 2205.3.1 Shop drawings. Shop drawings shall include the location of oversized, short slotted and long slotted holes, and shall comply with AISC 303.~~

~~[2205.6.2] 2205.3.2 Field connections. Field connections shall meet the requirements for corresponding types of shop connections described in AISC 360. No holes, copes or cuts of any type, or alterations to anchor rods, shall be made to facilitate erection unless specifically shown on the shop or erection drawings or authorized in writing by the [engineer or architect of record] registered design professional of record for the structural design.~~

~~[2205.6.3] 2205.3.3 Structural steel erection. [In addition, to the provisions of AISC 360,] the The requirements of Section 3305.2 shall apply.~~

SECTION BC 2206 **COMPOSITE STRUCTURAL STEEL AND** **CONCRETE STRUCTURES**

2206.1 General. Systems of structural steel elements acting compositely with reinforced concrete shall be designed in accordance with AISC 360 and ACI 318, excluding ACI 318 Chapter 14.

2206.2 Seismic design. Where required, the seismic design, materials, fabrication and erection of composite steel and concrete systems shall be in accordance with Section 2206.2.1.

2206.2.1 Seismic requirements for composite structural steel and concrete construction. Where a response modification coefficient, R, in accordance with Table 1613.5, is used for the design of systems of structural steel acting compositely with reinforced concrete, the structures shall be designed and detailed in accordance with the requirements of AISC 341.

2206.3 Fabrication, erection and quality control. The fabrication, erection and quality control of composite structural steel and concrete construction shall comply with the applicable requirements of Sections 2205 and 3305, and Chapter 19 of this code, AISC 360, AISC 341 and ACI 318.

2206.4 Concrete-filled steel columns. Concrete-filled steel columns shall comply with Section 2206.4.1 through 2206.4.5 and shall be filled with concrete so placed and manipulated as to secure maximum density and to ensure complete filling of the steel without voids.

2206.4.1 Design. The safe supporting capacity of concrete-filled steel columns shall be computed in accordance with AISC 360 or as determined by a test approved by the commissioner.

2206.4.2 Connections. Caps, base plates and connections shall be in accordance with AISC 360 and shall be positively attached to the shell and anchored to the concrete core. Welding of brackets without mechanical anchorage is prohibited. Where the pipe is slotted to accommodate webs of brackets or other connections, the integrity of the shell shall be restored by welding to ensure hooping action of the composite section.

2206.4.3 Reinforcement. Steel reinforcement shall be in the form of rods, structural shapes or pipe embedded in the concrete core in accordance with AISC 360 with sufficient clearance to ensure the composite action of the section, but not nearer than 1 inch (25 mm) to the exterior steel shell. Structural shapes used as reinforcement shall be milled to ensure bearing on cap and base plates.

2206.4.4 Fire-resistance-rating protection of concrete filled columns. Concrete-filled steel columns shall comply with the required fire-resistance ratings specified in Table 601. Where an outer steel shell is used to enclose the fire protective covering, the shell shall not be included in the calculations for strength of the column section. The minimum diameter of steel columns shall be 4 inches (102 mm) except that in structures of Type V construction not exceeding three stories or 40 feet (12 192 mm) above grade plane, steel columns used in basements and as secondary steel members shall have a minimum diameter of 3 inches (76 mm).

2206.4.4.1 Vent holes. Concrete-filled steel columns shall have a minimum of four ½ in. (12.7 mm) diameter holes that shall be placed opposite each other with two at the top and two at the bottom of the column. The two bottom holes shall be rotated 90° relative to the two top holes.

2206.4.5 Approvals. Details of column connections and splices shall be shop-fabricated in accordance with AISC 360. Concrete-filled steel columns shall be inspected by an approved agency pursuant to Chapter 17 of this code.

SECTION BC 2207 **STEEL JOISTS**

[2206.1] 2207.1 General. The design, manufacture and use of [~~open-web~~] open-web steel joists and joist girders shall be in accordance with [~~one of the following Steel Joist Institute (SJI) specifications:~~] SJI 100 or SJI 200, as applicable.

[1. ~~SJI-CJ-1.0~~]

[2. ~~SJI-K-1.1.~~]

[3. ~~SJI-LH/DLH-1.1.~~]

[4. ~~SJI-JG-1.1.~~]

2207.1.1 Seismic design. Where required, the seismic design of buildings shall be in accordance with the additional provisions of Section 2205.2 or [2210.5] 2211.1.1.

[2206.2] **2207.2 Design.** The registered design professional of record shall indicate on the construction documents the steel joist and [~~or~~] steel joist girder designations from the specifications listed in Section [2206.4] 2207.1; and shall indicate the requirements for joist and joist girder design, layout, end supports, anchorage, [~~non-SJI standard bridging~~] bridging design that differs from the SJI specifications listed in Section 2207.1, bridging termination connections and bearing connection design to resist uplift and lateral loads. These documents shall indicate special requirements as follows:

1. Special loads including:

1.1. Concentrated loads[;].

1.2. Nonuniform loads[;].

1.3. Net uplift loads[;].

1.4. Axial loads[;].

1.5. End moments[; and].

1.6. Transfer forces.

1.7. Connection forces.

2. Special considerations including:

2.1. Profiles for [~~nonstandard~~] joist and joist girder configurations [~~(standard joist and joist girder configurations are as indicated in the SJI catalog);~~] that differ from those defined by the SJI specifications listed in Section 2207.1.

2.2. Oversized or other nonstandard web openings[; and].

2.3. Extended ends.

3. [~~Deflection criteria for live and total loads for non-SJI standard joists.~~] Live and total load deflection criteria for joists and joist girder configurations that differ from those defined by the SJI specifications listed in Section 2207.1.

~~[2206.3]~~ **2207.3 Calculations.** The steel joist and joist girder manufacturer shall design the steel joists and ~~[or]~~ steel joist girders in accordance with the ~~[current]~~ SJI specifications ~~[and load tables]~~ listed in Section 2207.1 to support the load requirements of Section ~~[2206.2]~~ 2207.2. The registered design professional of record ~~[may]~~ shall be permitted to require submission of the steel joist and joist girder calculations as prepared by a registered design professional responsible for the product design. ~~[If]~~ Where requested by the registered design professional of record, the steel joist manufacturer shall submit design calculations with a cover letter bearing the seal and signature of the joist manufacturer's registered design professional. In addition to ~~[standard]~~ the design calculations submitted under [this] seal and signature, ~~[submittal of]~~ the following shall be included:

1. ~~[Non-SJI standard bridging details (e.g., for cantilevered conditions, net uplift, etc.)]~~ Bridging design that differs from the SJI specifications listed in Section 2207.1, such as cantilevered conditions and net uplift.
2. Connection ~~[details]~~ design for:
 - 2.1. ~~[Non-SJI standard connections (e.g., flush framed or framed connections);]~~ Connections that differ from the SJI specifications listed in Section 2207.1, such as flush-framed or framed connections.
 - 2.2. Field splices~~;~~ and.
 - 2.3. Joist headers.

~~[2206.4]~~ **2207.4 Steel joist drawings.** Steel joist placement plans shall be provided to show the steel joist products as specified on the approved construction documents and are to be utilized for field installation in accordance with specific project requirements as stated in Section ~~[2206.2]~~ 2207.2. Steel joist placement plans shall include, at a minimum, the following:

1. Listing of ~~[all]~~ applicable loads as stated in Section ~~[2206.2]~~ 2207.2 and used in the design of the steel joists and joist girders as specified in the approved construction documents.
2. Profiles for ~~[nonstandard]~~ joist and joist girder configurations ~~[(standard joist and joist girder configurations are as indicated in the SJI catalog)]~~ that differ from those defined by the SJI specifications listed in Section 2207.1.
3. Connection requirements for:
 - 3.1. Joist supports~~;~~.
 - 3.2. Joist girder supports~~;~~.
 - 3.3. Field splices~~;~~ and.
 - 3.4. Bridging attachments.
4. ~~[Deflection criteria for live and total loads for non-SJI standard joists]~~ Live and total load deflection criteria for joists and joist girder configurations that differ from those defined by the SJI specifications listed in Section 2207.1.

5. Size, location and connections for ~~all~~ bridging.
6. Joist headers.

[Exception:] Steel joist placement plans do not require the seal and signature of the joist manufacturer's registered design professional.

~~[2206.5]~~ **2207.5 Certification.** At completion of manufacture, the steel joist manufacturer shall submit a certificate of compliance in accordance with Section 1704.2.2 stating that work was performed in accordance with approved construction documents and with SJI ~~[standard]~~ specifications listed in Section 2207.1.

~~[2203.6]~~ **2207.6 Limitations of use.** Open web steel joists shall be prohibited in high-rise buildings until the commissioner promulgates rules establishing minimum acceptable fireproofing methods.

SECTION BC ~~[2207]~~ 2208 STEEL CABLE STRUCTURES

~~[2207.1]~~ **2208.1 General.** The design, fabrication and erection including related connections, and protective coatings of steel cables for buildings shall be in accordance with ASCE 19.

~~[2207.2 Seismic requirements for steel cable. The design strength of steel cables shall be determined by the provisions of ASCE 19 except as modified by these provisions.]~~

- ~~[1. A load factor of 1.1 shall be applied to the prestress force included in T₃ and T₄ as defined in Section 3.12.]~~
- ~~[2. In Section 3.2.1, Item (c) shall be replaced with "1.5 T₃" and Item (d) shall be replaced with "1.5 T₄".]~~

SECTION BC ~~[2208]~~ 2209 STEEL STORAGE RACKS

~~[2208.1]~~ **2209.1 Storage racks.** The design, testing and utilization of ~~[industrial steel]~~ storage racks made of cold-formed or hot-rolled steel structural members~~[.]~~ shall be in accordance with ~~[RMI/ANSI MH 16.1]~~ RMI ANSI/MH 16.1. Where required by ASCE 7, the seismic design of storage racks shall be in accordance with ~~[the provisions of]~~ Section 15.5.3 of ASCE 7~~[, except that items (1), (2) and (3) of Section 15.5.3 of ASCE 7 do not apply when the rack design satisfies RMI/ANSI MH 16.1.]~~

2209.2 Cantilevered steel storage racks. The design, testing, and utilization of cantilevered storage racks made of cold-formed or hot-rolled steel structural members shall be in accordance with RMI ANSI/MH 16.3 Where required by ASCE 7, the seismic design of cantilevered steel storage racks shall be in accordance with Section 15.5.3 of ASCE 7.

SECTION BC ~~[2209]~~ 2210 COLD-FORMED STEEL

~~[2209.1]~~ **2210.1 General.** The design of cold-formed carbon and low-alloy steel structural members shall be in accordance with AISI S100. The design of cold-formed stainless-steel structural members

shall be in accordance with ASCE 8. Cold-formed steel [~~light-framed~~] light-frame construction shall [~~also~~] comply with Section [~~2210~~] 2211. Where required, the seismic design of cold-formed steel structures shall be in accordance with the additional provisions of Section 2210.2.

~~[2209.2]~~ **2210.1.1 Steel decks.** The design and construction of cold-formed steel decks shall be in accordance with this section.

~~[2209.2.1 Composite slabs on steel decks.~~ Composite slabs of concrete and steel deck shall be designed and constructed in accordance with ASCE 3.]

~~[2209.2.2]~~ **2210.1.1.1 Noncomposite steel floor decks.** Noncomposite steel floor decks shall be permitted to be designed and constructed in accordance with ANSI/SDI-NC [~~1.0, as modified in Section 2209.2.2.1~~].

~~[2209.2.2.1 ANSI/SDI-NC1.0 Section 2.4B1.~~ Replace Section 2.4B1 of ANSI/SDI-NC1.0 with the following:]

[~~General. The design of the concrete slabs shall be done in accordance with the ACI Building Code Requirements for Reinforced Concrete. The minimum concrete thickness above the top of the deck shall be 1½ inches (38 mm).~~]

~~[2209.2.3]~~ **2210.1.1.2 Steel roof deck.** Steel roof decks shall be permitted to be designed and constructed in accordance with ANSI/SDI-RD[~~1.0~~].

2210.1.1.3 Composite slabs on steel decks. Composite slabs of concrete and steel deck shall be permitted to be designed and constructed in accordance with SDI-C.

2210.2 Seismic requirements for cold-formed steel structures. Where a response modification coefficient, R, in accordance with Table 1613.5, is used for the design of cold-formed steel structures, the structures shall be designed and detailed in accordance with the requirements of AISI S100, ASCE 8, or, for cold-formed steel special-bolted moment frames, AISI S400.

SECTION BC [~~2210~~] 2211 COLD-FORMED STEEL LIGHT-FRAME CONSTRUCTION

~~[2210.1 General.~~ The design and installation of structural members and nonstructural members utilized in cold formed steel light frame construction where the specified minimum base steel thickness is between 0.0179 inches (0.455 mm) and 0.1180 inches (2.997 mm) shall be in accordance with AISI S200 and Sections 2210.2 through 2210.7, as applicable.]

2211.1 Structural framing. For cold-formed steel light-frame construction, the design and installation of the following structural framing systems, including their members and connections, shall be in accordance with AISI S240, and Sections 2211.1.1 through 2211.1.3, as applicable:

1. Floor and roof systems.
2. Structural walls.
3. Shear walls, strap-braced walls and diaphragms that resist in-plane lateral loads.

4. Trusses.

2211.1.1 Seismic requirements for cold-formed steel structural systems. The design of cold-formed steel light-frame construction to resist seismic forces shall be in accordance with the provisions of Section 2211.1.1.1 or 2211.1.1.2, as applicable.

2211.1.1.1 Seismic Design Categories B and C. Where a response modification coefficient, R, in accordance with Table 1613.5 is used for the design of cold-formed steel light-frame construction assigned to Seismic Design Category B or C, the seismic force-resisting system shall be designed and detailed in accordance with the requirements of AISI S400.

Exception: The response modification coefficient, R, designated for "Steel systems not specifically detailed for seismic resistance, excluding cantilever column systems" in Table 1613.5 shall be permitted for systems designed and detailed in accordance with AISI S240 and need not be designed and detailed in accordance with AISI S400.

2211.1.1.2 Seismic Design Categories D. In cold-formed steel light-frame construction assigned to Seismic Design Category D, the seismic force-resisting system shall be designed and detailed in accordance with AISI S400.

2211.1.2 Prescriptive framing. Detached one- and two-family dwellings and townhouses, less than or equal to three stories above grade plane, shall be permitted to be constructed in accordance with AISI S230 subject to the limitations therein.

~~[2210.2 Header design. Headers, including box and back to back headers, and double and single L-headers shall be designed in accordance with AISI S212 or AISI S100.]~~

~~[2210.3 Trusses. Cold-formed steel trusses shall comply with the requirements of Sections 2210.3.1 through 2210.3.5.]~~

~~[2210.3.1] **2211.1.3 [Design] Truss design.** Cold-formed steel trusses shall ~~[be designed in accordance with AISI S214, Sections 2210.3.2 through 2210.3.5 and accepted engineering practice]~~ comply with the additional provisions of Sections 2211.1.3.1. through 2211.1.3.3.~~

~~[2210.3.2] **2211.1.3.1 Truss design drawings.** The truss design drawings shall conform to the requirements of Section ~~[B2.3]~~ I1 of AISI ~~[S214]~~ S202 and shall be provided with the shipment of trusses delivered to the job site. The truss design drawings shall include the details of permanent individual truss member restraint/bracing in accordance with Section ~~[B6(a) or B6 (e) of AISI S214]~~ I1.6 of AISI S202 where these methods are utilized to provide restraint/bracing.~~

~~[2210.3.3 Deferred submittals. AISI Section B4.2 shall be deleted.]~~

~~[2210.3.4] **2211.1.3.2 Trusses spanning 60 feet or greater.** The owner or the owner's authorized agent shall contract with a registered design professional for the design of the temporary installation restraint/bracing and the permanent individual truss member restraint/bracing for trusses with clear spans 60 feet (18 288 mm) or greater. Special inspection of trusses over 60 feet (18 288 mm) in length shall be in accordance with Section 1705.2.~~

~~[2210.3.5] 2211.1.3.3 Truss quality assurance. [Trusses manufactured in the fabricators plant shall be manufactured in compliance with Sections 1704.2 and 1704.3, as applicable.] Trusses not part of a manufacturing process that provides requirements for quality control done under the supervision of a third-party quality control agency in accordance with AISI S240 Chapter D shall be fabricated in compliance with Sections 1704.2.2 and 1705.2, as applicable.]~~

2211.2 Nonstructural members. For cold-formed steel light-frame construction, the design and installation of non-structural members and connections shall be in accordance with AISI S220.

~~[2210.4 Wall stud design. Wall studs shall be designed in accordance with either AISI S211 or AISI S100.]~~

~~[2210.5 Floor and roof system design. Framing for floor and roof systems in buildings shall be designed in accordance with either AISI S210 or AISI S100.]~~

~~[2210.6 Lateral design. Light frame shear walls, diagonal strap bracing that is part of a structural wall and diaphragms used to resist wind, seismic and other in-plane lateral loads shall be designed in accordance with AISI S213.]~~

~~[2210.7 Prescriptive framing. Detached one and two family dwellings and townhouses, less than or equal to three stories above grade plane, shall be permitted to be constructed in accordance with AISI S230 subject to the limitations therein.]~~

SECTION BC ~~[2211]~~ **2212** MINIMUM THICKNESS OF METAL

~~[2211.1] 2212.1 General.~~ All steel of Chapter 22 shall conform to the minimum thickness of metal in accordance with Section ~~[2211.2] 2212.2.~~

~~[2211.2] 2212.2 Exterior members.~~ All exterior structural steel members exposed to weather shall have a minimum thickness of metal of 0.23 inches (5.8 mm).

Exceptions:

1. When an approved type of atmospheric corrosion-resistant steel is used.
2. Exposed surfaces are zinc coated with a minimum weight of coating of approximately 0.6 ounces per square foot (0.00 156 kg/m²) of exposed surface and covered with a protective coating as required by Section 2203.2.
3. Exposed surfaces are protected by other means approved by the commissioner.
4. Temporary construction installations that will be in place for a period of 1 year or less, provided that all surfaces which are exposed to the weather shall have a protective coating as required by Section 2203.2.
5. Joists or purlins that are exposed to the weather but which do not support more than 200 square feet (19 m²) of floor or roof area, and which have a protective coating as required

by Section 2203.2.

SECTION BC ~~[2212]~~ 2213 STRUCTURAL INTEGRITY REQUIREMENTS

~~[2212.1]~~ 2213.1 **General.** Steel structures shall be designed to meet all of the requirements of this section. However, details provided for gravity, seismic and wind forces and for other purposes may be regarded as forming part of, or the whole of, these requirements. Detailing provided for one requirement may be counted towards the other requirements.

Exceptions:

1. One-story structures less than 5,000 square feet (465 m²) not to exceed 15 feet (4572 mm) in height.
2. Structures ~~[is]~~ containing only Group R-3 occupancy not more than three stories in height.

~~[2212.2]~~ 2213.2 **Continuity and ties.** The following requirements shall be met:

1. All bolted connections shall have at least two bolts.
2. Bolted connections of all columns, beams, braces and other structural elements that are part of the lateral load resisting system shall be designed as bearing-type connections with pretensioned bolts or as slip critical connections.
3. End connections of all beams and girders shall have a minimum available tensile strength equal to the larger of the ~~[available]~~ required vertical shear strength of the connections at either end, but not less than 10 kips (45 kN)(LRFD) and 6.7 kips (30kN)(ASD). For the design of the connections, the shear force and ~~[the]~~ this axial tensile force need not be considered to act simultaneously. For the purpose of this provision, a connection shall be considered compliant if it meets the following requirements:
 - 3.1. For single-plate shear connections, the available tensile strength shall be determined only for the limit state of bolt bearing on the plate and beam web.
 - 3.2. For single angle and double angle shear connections, the available tensile strength shall be determined for the limit states of bolt bearing on the angles and beam web and for tension yielding on the gross area of the angles.
 - 3.3. All other connections shall be designed for the required tension force noted above in accordance with the provisions of AISC 360~~[, or AISC-HSS]~~.
4. For the purpose of satisfying these integrity provisions only, bearing bolts in connections with short-slotted holes parallel to the direction of the tension force and inelastic deformation are permitted. Elements and their connections that brace compression members shall have a minimum available tensile strength equal to at least 2 percent of the required compressive strength of the member being braced, but not less than 10 kips (45 kN)(LRFD) and 6.7 kips (30kN)(ASD). For design of these bracing connections, the shear force and the tensile force

need not be considered to act simultaneously. Where more than one element braces a compression member at a point in one direction, all elements and connections shall have a minimum available tensile strength equal to at least 1 percent of the required compressive strength of the member being braced but not less than 10 kips (45 kN)(LRFD) and 6.7 kips (30kN)(ASD).

~~[2212.2.1]~~ **2213.2.1 Vertical ties.** Column slices shall have an available tensile strength at least equal to the largest design gravity load reaction applied to the column at any floor level located within four floors below the splice.

~~[2212.3]~~ **2213.3 Composite construction.** For steel framing members and/or decking acting compositely with concrete slabs of roofs or floors, the following requirements shall be met:

1. Shear studs shall not be less than ½ inch (12.7 mm) in diameter. The spacing of shear studs shall not be greater than one every 12 inches (305 mm) averaged over the length of the beam.
2. Connections at the discontinuous edges of permanent metal decking to supporting members shall have a minimum connection strength in the direction parallel to the rib of the deck equal to the shear strength of a ¾-inch (19.1 mm) puddle weld every 12 inches (305 mm) on center.
3. Side lap connections of permanent metal decking shall have a minimum strength equal to the strength of a button punch every 24 inches (610 mm) on center.
4. Welded wire fabric reinforcement in concrete slabs shall be continuous over all supports and in all spans. Minimum area of continuous reinforcement in each direction shall be 0.0015 times the gross area of concrete. The welded wire fabric reinforcement shall have tension splices and be anchored at discontinuous edges, and shall not be substituted with alternative materials including but not limited to fibers.

§ 23. Chapter 23 of the New York city building code, as added by local law number

141 for the year 2013, is amended to read as follows:

CHAPTER 23

WOOD

SECTION BC 2301

GENERAL

2301.1 Scope. The provisions of this chapter shall govern the materials, design, construction and quality of wood members and their fasteners.

2301.2 General design requirements. The design of structural elements or systems, constructed partially or wholly of wood or wood-based products, shall be in accordance with one of the following methods:

1. Allowable stress design in accordance with Sections 2304, 2305 and 2306.

2. Load and resistance factor design in accordance with Sections 2304, 2305 and 2307.
3. Conventional light-frame construction in accordance with Sections 2304 and 2308.

[Exception: Buildings designed]

4. AWC WFCM in accordance with ~~[the provisions of the AF&PA WFCM shall be deemed to meet the requirements of the provisions of]~~ Section ~~[2308]~~ 2309.

- ~~[4.]~~ 5. The design and construction of log structures ~~[shall be]~~ in accordance with the provisions of ICC 400.

2301.3 Nominal sizes. For the purposes of this chapter, where dimensions of lumber are specified, they shall be deemed to be nominal dimensions unless specifically designated as actual dimensions (see Section 2304.2).

SECTION BC 2302 DEFINITIONS

2302.1 Definitions. The following ~~[words and terms shall, for the purposes of this chapter, have the meanings shown herein.]~~ terms are defined in Chapter 2:

ACCREDITATION BODY. ~~[An approved, third party organization that is independent of the grading and inspection agencies, and the lumber mills, and that initially accredits and subsequently monitors, on a continuing basis, the competency and performance of a grading or inspection agency related to carrying out specific tasks.]~~

BRACED WALL LINE. ~~[A series of braced wall panels in a single story that meets the requirements of Section 2308.3 or 2308.12.4.]~~

BRACED WALL PANEL. ~~[A section of wall braced in accordance with Section 2308.9.3 or 2308.12.4.]~~

COLLECTOR. ~~[A horizontal diaphragm element parallel and in line with the applied force that collects and transfers diaphragm shear forces to the vertical elements of the lateral force-resisting system and/or distributes forces within the diaphragm.]~~

CONVENTIONAL LIGHT-FRAME CONSTRUCTION. ~~[A type of construction whose primary structural elements are formed by a system of repetitive wood framing members. See Section 2308 for conventional light frame construction provisions.]~~

CRIPPLE WALL. ~~[A framed stud wall extending from the top of the foundation to the underside of floor framing for the lowest occupied floor level.]~~

CROSS-LAMINATED TIMBER (CLT).

[DIAPHRAGM, UNBLOCKED. A diaphragm that has edge nailing at supporting members only. Blocking between supporting structural members at panel edges is not included. Diaphragm panels are field-nailed to supporting members.]

DIAPHRAGM.

Diaphragm, blocked.

Diaphragm boundary.

Diaphragm chord.

Diaphragm, unblocked.

DRAG STRUT.[See "Collector."]

ENGINEERED WOOD RIM BOARD.

FIBERBOARD.[A fibrous, homogeneous panel made from lignocellulosic fibers (usually wood or cane) and having a density of less than 31 pounds per cubic foot (pcf) (497 kg/m³) but more than 10 pcf (160 kg/m³).]

FIRECUT. [A sloping cut on the ends of wood beams, joists and rafters resting on masonry or concrete walls.]

GABLE.

[GLUED BUILT-UP MEMBER. A structural element, the section of which is composed of built-up lumber, wood structural panels or wood structural panels in combination with lumber, all parts bonded together with structural adhesives.]

GRADE (LUMBER).[The classification of lumber in regard to strength and utility in accordance with American Softwood Lumber Standard DOC PS 20 and the grading rules of an approved lumber rules writing agency.]

HARDBOARD. [A fibrous-felted, homogeneous panel made from lignocellulosic fibers consolidated under heat and pressure in a hot press to a density not less than 31 pcf (497 kg/m³).]

HOLD-DOWN.

NAILING, BOUNDARY. [A special nailing pattern required by design at the boundaries of diaphragms.]

NAILING, EDGE. [A special nailing pattern required by design at the edges of each panel within the assembly of a diaphragm or shear wall.]

NAILING, FIELD. [Nailing required between the sheathing panels and framing members at locations other than boundary nailing and edge nailing.]

NATURALLY DURABLE WOOD. [The heartwood of the following species, with the exception that an occasional piece with corner sapwood is permitted if 90 percent or more of the width of each side on which it occurs is heartwood:]

Decay resistant. [Redwood, cedar, black locust and black walnut.]

Termite resistant. [Redwood, Alaska yellow cedar, Eastern red cedar and both heartwood and all sapwood of Western red cedar.]

NOMINAL SIZE (LUMBER). [The commercial size designation of width and depth, in standard sawn lumber and glued laminated lumber grades; somewhat larger than the standard net size of dressed lumber, in accordance with DOC PS-20 for sawn lumber and with the AF&PA NDS for glued laminated lumber.]

PARTICLEBOARD. [A generic term for a panel primarily composed of cellulosic materials (usually wood), generally in the form of discrete pieces or particles, as distinguished from fibers. The cellulosic material is combined with synthetic resin or other suitable bonding system by a process in which the interparticle bond is created by the bonding system under heat and pressure.]

PERFORMANCE CATEGORY.

PREFABRICATED WOOD I-JOIST. [Structural member manufactured using sawn or structural composite lumber flanges and wood structural panel webs bonded together with exterior exposure adhesives, which forms an “I” cross-sectional shape.]

RIM BOARD.

RISK CATEGORY.

SHEAR WALL. [A wall designed to resist lateral forces parallel to the plane of a wall.]

Shear wall, perforated. [A wood structural panel sheathed wall with openings, that has not been specifically designed and detailed for force transfer around openings.]

Shear wall segment, perforated. [A section of shear wall with full height sheathing that meets the height to width ratio limits of Section 4.3.4 of AF&PA SDPWS.]

STRUCTURAL COMPOSITE LUMBER. [Structural member manufactured using wood elements bonded together with exterior adhesives. Examples of structural composite lumber are:]

Laminated strand lumber (LSL).

Laminated veneer lumber (LVL). [A composite of wood veneer sheet elements with wood fibers primarily oriented along the length of the member.]

Oriented strand lumber (OSL).

Parallel strand lumber (PSL). [A composite of wood strand elements with wood fibers primarily oriented along the length of the member.]

STRUCTURAL GLUED-LAMINATED TIMBER. [An engineered, stress-rated product of a timber laminating plant, comprised of assemblies of specially selected and prepared wood

~~laminations in which the grain of all laminations is approximately parallel longitudinally and the laminations are bonded with adhesives.]~~

~~[**SUBDIAPHRAGM.** A portion of a larger wood diaphragm designed to anchor and transfer local forces to primary diaphragm struts and the main diaphragm.]~~

~~**TIE-DOWN (HOLD-DOWN).** [A device used to resist uplift of the chords of shear walls.]~~

~~**TREATED WOOD.** [Wood and wood-based materials that use vacuum pressure impregnation processes to enhance fire retardant or preservative properties.]~~

~~**Fire-retardant-treated wood.** [Pressure treated lumber and plywood that exhibit reduced surface burning characteristics and resist propagation of fire.]~~

~~**Preservative-treated wood.** [Pressure treated wood products that exhibit reduced susceptibility to damage by fungi, insects or marine borers.]~~

~~**WOOD SHEAR PANEL.** [A wood floor, roof or wall component sheathed to act as a shear wall or diaphragm.]~~

~~**WOOD STRUCTURAL PANEL.** [A panel manufactured from veneers, wood strands or wafers or a combination of veneer and wood strands or wafers bonded together with waterproof synthetic resins or other suitable bonding systems. Examples of wood structural panels are:]~~

~~**Composite panels.** [A wood structural panel that is comprised of wood veneer and reconstituted wood based material and bonded together with waterproof adhesive;]~~

~~**Oriented strand board (OSB).** [A mat formed wood structural panel comprised of thin rectangular wood strands arranged in cross-aligned layers with surface layers normally arranged in the long panel direction and bonded with waterproof adhesive; or]~~

~~**Plywood.** [A wood structural panel comprised of plies of wood veneer arranged in cross-aligned layers. The plies are bonded with waterproof adhesive that cures on application of heat and pressure.]~~

SECTION BC 2303 MINIMUM STANDARDS AND QUALITY

2303.1 General. Structural sawn lumber; end-jointed lumber; prefabricated wood I-joists; structural glued-laminated timber; cross-laminated timber; wood structural panels[~~;~~]; fiberboard sheathing (when used structurally); hardboard siding (when used structurally); particleboard; preservative-treated wood; structural log members; structural composite lumber; round timber poles and piles; engineered wood rim board; fire-retardant-treated wood; hardwood plywood; wood trusses; joist hangers; nails; and staples shall conform to the applicable provisions of this section.

2303.1.1 Sawn lumber. Sawn lumber used for load-supporting purposes, including end-jointed or edge-glued lumber, machine stress-rated or machine-evaluated lumber, shall be identified by the grade mark of a lumber grading or inspection agency that has been approved by the commissioner that complies with DOC PS 20 or equivalent. Grading practices and identification

shall comply with rules published by an agency approved in accordance with the procedures of DOC PS 20 or equivalent procedures.

2303.1.1.1 Certificate of inspection. In lieu of a grade mark on the material, a certificate of inspection as to species and grade issued by a lumber grading or inspection agency meeting the requirements of this section is permitted to be accepted for precut, remanufactured or rough-sawn lumber and for sizes larger than 3 inches (76 mm) nominal thickness.

2303.1.1.2 End-jointed lumber. Approved end-jointed lumber is permitted to be used interchangeably with solid-sawn members of the same species and grade. End-jointed lumber used in an assembly required to have a fire-resistance rating shall have the designation “Heat Resistant Adhesive” or “HRA” included in its grade mark.

2303.1.2 Prefabricated wood I-joists. Structural capacities and design provisions for prefabricated wood I-joists shall be established and monitored in accordance with ASTM D 5055. The use of prefabricated wood I-joists structurally shall be subject to the special inspection requirements of Chapter 17.

2303.1.3 Structural glued-laminated timber. Glued-laminated timbers shall be manufactured and identified as required in [~~ANSI/AITC A-190.1~~] ANSI/APA A190.1 and ASTM D3737.

2303.1.4 Cross-laminated timber. Cross-laminated timber shall be manufactured and identified in accordance with ANSI/APA PRG 320.

2303.1.5 Wood structural panels. Wood structural panels, when used structurally (including those used for siding, roof and wall sheathing, subflooring, diaphragms and built-up members), shall conform to the requirements for their type in DOC PS 1, DOC PS 2 or [~~PS2~~] ANSI/APA PRP 210. Each panel or member shall be identified for grade, bond classification, and [~~glue type~~] Performance Category by the trademarks of an approved testing and grading agency. The Performance Category value shall be used as the “nominal panel thickness” or “panel thickness” whenever referenced in this code. Wood structural panel components shall be designed and fabricated in accordance with the applicable standards listed in Section 2306.1 and identified by the trademarks of an approved testing and inspection agency indicating conformance [~~with~~] to the applicable standard. In addition, wood structural panels when permanently exposed in outdoor applications shall be of [~~exterior~~] Exterior type, except that wood structural panel roof sheathing exposed to the outdoors on the underside is permitted to be [~~interior type bonded with exterior glue,~~] Exposure 1 type.

[~~2303.1.5~~] **2303.1.6 Fiberboard.** Fiberboard for its various uses shall conform to ASTM C208. Fiberboard sheathing, when used structurally, shall be identified by an approved agency as conforming to ASTM C208.

[~~2303.1.5.1~~] **2303.1.6.1 Jointing.** To ensure tight-fitting assemblies, edges shall be manufactured with square, shiplapped, beveled, tongue-and-groove or U-shaped joints.

[~~2303.1.5.2~~] **2303.1.6.2 Roof insulation.** Where used as roof insulation in all types of construction, fiberboard shall be protected with an approved roof covering.

[2303.1.5.3] 2303.1.6.3 Wall insulation. Where installed and fireblocked to comply with Chapter 7, fiberboards are permitted as wall insulation in all types of construction. In fire walls and fire barriers, unless treated to comply with Section 803.1 for Class A materials, the boards shall be cemented directly to the concrete, masonry or other noncombustible base and shall be protected with an approved noncombustible veneer anchored to the base without intervening airspaces.

[2303.1.5.3.1] 2303.1.6.3.1 Protection. Fiberboard wall insulation applied on the exterior of foundation walls shall be protected below ground level with a bituminous coating.

[2303.1.6] 2303.1.7 Hardboard. Hardboard siding used structurally shall be identified by an approved agency conforming to CPA/ANSI A135.6. Hardboard underlayment shall meet the strength requirements of $7/32$ -inch (5.6 mm) or $1/4$ -inch (6.4 mm) service class hardboard planed or sanded on one side to a uniform thickness of not less than 0.200 inch (5.1 mm). Prefinished hardboard paneling shall meet the requirements of CPA/ANSI A135.5. Other basic hardboard products shall meet the requirements of CPA/ANSI A135.4. Hardboard products shall be installed in accordance with manufacturer's recommendations.

[2303.1.7] 2303.1.8 Particleboard. Particleboard shall conform to ANSI A208.1. Particleboard shall be identified by the grade mark or certificate of inspection issued by an approved agency. Particleboard shall not be utilized for applications other than indicated in this section unless the particleboard complies with the provisions of Section [2306.5] 2306.3.

[2303.1.7.1] 2303.1.8.1 Floor underlayment. Particleboard floor underlayment shall conform to Type PBU of ANSI A208.1. Type PBU underlayment shall not be less than $1/4$ -inch (6.4 mm) thick and shall be installed in accordance with the instructions of the Composite Panel Association.

[2303.1.8] 2303.1.9 Preservative-treated wood. Lumber, timber, plywood, piles and poles supporting permanent structures required by Section [2304.11] 2304.12 to be preservative treated shall conform to [the requirements of the applicable] AWPA [Standard] U1 and M4 [for the species, product, preservative and end use. Preservatives shall be listed in Section 4 of AWPA U1]. Lumber and plywood used in permanent wood foundation systems shall conform to Chapter 18 of this code.

[2303.1.8.1] 2303.1.9.1 Identification. Wood required by Section [2304.11] 2304.12 to be preservative treated shall bear the quality mark of an inspection agency that maintains continuing supervision, testing and inspection over the quality of the preservative-treated wood. Inspection agencies for preservative-treated wood shall be listed by an accreditation body that complies with the requirements of the American Lumber Standards Treated Wood Program, or its equivalent. The quality mark shall be on a stamp or label affixed to the preservative-treated wood, and shall include the following information:

1. Identification of treating manufacturer.
2. Type of preservative used.
3. Minimum preservative retention (pcf).

4. End use for which the product is treated.
5. AWWPA standard to which the product was treated.
6. Identity of the accredited inspection agency.

~~[2303.1.8.2]~~ **2303.1.9.2 Moisture content.** Where preservative-treated wood is used in enclosed locations where drying in service cannot readily occur, such wood shall be at a moisture content of 19 percent or less before being covered with insulation, interior wall finish, floor covering or other materials.

~~[2303.1.9]~~ **2303.1.10 Structural composite lumber.** Structural capacities for structural composite lumber shall be established and monitored in accordance with ASTM D5456.

~~[2303.1.10]~~ **2303.1.11 Structural log members.** Stress grading of structural log members of nonrectangular shape, as typically used in log buildings, shall be in accordance with ASTM D3957. Such structural log members shall be identified by the grade mark of an approved lumber grading or inspection agency. In lieu of a grade mark on the material, a certificate of inspection as to species and grade issued by ~~[an approved]~~ a lumber grading or inspection agency meeting the requirements of this section shall be permitted.

~~[2303.1.11]~~ **2303.1.12 Round timber poles and piles.** Round timber poles and piles shall comply with ASTM D3200 and ASTM D25, respectively.

2303.1.13 Engineered wood rim board. Engineered wood rim boards shall conform to ANSI/APA PRR 410 or shall be evaluated in accordance with ASTM D7672. Structural capacities shall be in accordance with ANSI/APA PRR 410 or established in accordance with ASTM D7672. Rim boards conforming to ANSI/APA PRR 410 shall be marked in accordance with that standard.

2303.2 Fire-retardant-treated wood. Fire-retardant-treated wood is any wood product which, when impregnated with chemicals by a pressure process or other means during manufacture, shall have, when tested in accordance with ASTM E84 or UL 723, a listed flame spread index of 25 or less and show no evidence of significant progressive combustion when the test is continued for an additional 20-minute period. Additionally, the flame front shall not progress more than 10½-feet (3200 mm) beyond the centerline of the burners at any time during the test.

2303.2.1 Pressure process. For wood products impregnated with chemicals by a pressure process, the process shall be performed in closed vessels under pressures not less than 50 pounds per square inch gauge (psig) (345 kPa).

2303.2.2 Other means during manufacture. For wood products produced by other means during manufacture, the treatment shall be an integral part of the manufacturing process of the wood product. The treatment shall provide permanent protection to all surfaces of the wood product.

2303.2.3 Testing. For wood products produced by other means during manufacture, other than a pressure process, all sides of the wood product shall be tested in accordance with and produce the results required in Section 2303.2. Wood structural panels shall be permitted to be tested on only the front and back faces.

2303.2.4 Labeling. [~~Fire-retardant-treated~~] In addition to the labels required in Section 2303.1.1 for sawn lumber and Section 2303.1.5 for wood structural panels, each piece of fire-retardant-treated lumber and wood structural panels shall be labeled. The label shall contain the following items:

1. The identification mark of an approved agency in accordance with Chapter 1 of Title 28 of the *Administrative Code*;
2. Identification of the treating manufacturer;
3. The name of the fire-retardant treatment;
4. The species of wood treated;
5. Flame spread and smoke-developed index;
6. Method of drying after treatment;
7. Conformance with appropriate standards in accordance with Sections [~~2303.2.2~~] 2303.2.5 through [~~2303.2.5~~] 2303.2.8; and
8. For fire-retardant-treated wood exposed to weather, damp or wet locations, include the words “No increase in the listed classification when subjected to the Standard Rain Test” (ASTM D2898).

2303.2.5 Strength adjustments. Design values for untreated lumber and wood structural panels, as specified in Section 2303.1, shall be adjusted for fire-retardant-treated wood. Adjustments to design values shall be based on an approved method of investigation that takes into consideration the effects of the anticipated temperature and humidity to which the fire-retardant-treated wood will be subjected, the type of treatment and redrying procedures.

2303.2.5.1 Wood structural panels. The effect of treatment and the method of redrying after treatment, and exposure to high temperatures and high humidities on the flexure properties of fire-retardant-treated softwood plywood shall be determined in accordance with ASTM D5516. The test data developed by ASTM D5516 shall be used to develop adjustment factors, maximum loads and spans, or both, for untreated plywood design values in accordance with ASTM D6305. Each manufacturer shall publish the allowable maximum loads and spans for service as floor and roof sheathing for its treatment.

2303.2.5.2 Lumber. For each species of wood that is treated, the effects of the treatment, the method of redrying after treatment and exposure to high temperatures and high humidities on the allowable design properties of fire-retardant-treated lumber shall be determined in accordance with ASTM D5664. The test data developed by ASTM D5664 shall be used to develop modification factors for use at or near room temperature and at elevated temperatures and humidity in accordance with ASTM D6841. Each manufacturer shall publish the modification factors for service at temperatures of not less than 80°F (27°C) and for roof framing. The roof framing modification factors shall take into consideration the climatological location.

2303.2.6 Exposure to weather, damp or wet locations. Where fire-retardant-treated wood is exposed to weather, or damp or wet locations, it shall be identified as “Exterior” to indicate there is no increase in the listed flame spread index as defined in Section 2303.2 when subjected to ASTM D2898.

2303.2.7 Interior applications. Interior fire-retardant-treated wood shall have moisture content of not over 28 percent when tested in accordance with ASTM D3201 procedures at 92-percent relative humidity. Interior fire-retardant-treated wood shall be tested in accordance with Section 2303.2.5.1 or 2303.2.5.2. Interior fire-retardant-treated wood designated as Type A shall be tested in accordance with the provisions of this section.

2303.2.8 Moisture content. Fire-retardant-treated wood shall be dried to a moisture content of 19 percent or less for lumber and 15 percent or less for wood structural panels before use. For wood [~~kiln-dried~~] kiln-dried after treatment (KDAT), the kiln temperatures shall not exceed those used in kiln drying the lumber and plywood submitted for the tests described in Section 2303.2.5.1 for plywood and 2303.2.5.2 for lumber.

2303.2.9 Type I and II construction applications. See Section 603.1 for limitations on the use of fire-retardant-treated wood in buildings of Type I or II construction.

2303.3 Hardwood [~~and~~] plywood. Hardwood and decorative plywood shall be manufactured and identified as required in HPVA HP-1.

2303.4 Trusses. Wood trusses shall comply with Sections 2303.4.1 through 2303.4.8.

2303.4.1 Design. Wood trusses shall be designed in accordance with the provisions of this code and accepted engineering practice. Members are permitted to be joined by nails, glue, bolts, timber connectors, metal connector plates or other approved framing devices. Metal-plate-connected wood trusses shall also be subject to the special inspection requirements of Chapter 17.

2303.4.1.1 Truss design drawings. Truss construction documents shall be prepared by a registered design professional and the written, graphic and pictorial depiction of each individual truss shall be provided to the commissioner and approved prior to installation. Truss design drawings shall also be provided with the shipment of trusses delivered to the job site. Truss design drawings shall include, at a minimum, the information specified below:

1. Slope or depth, span and spacing;
2. Location of all joints and support locations;
3. Number of plies, if greater than one;
4. Required bearing widths;
5. Design loads as applicable, including:
 - 5.1. Top chord live load;
 - 5.2. Top chord dead load;

- 5.3. Bottom chord live load;
- 5.4. Bottom chord dead load;
- 5.5. Additional loads and locations; and
- 5.6. Environmental design criteria and loads (wind, rain, snow, seismic, etc.).
- 6. Other lateral loads, including drag strut loads;
- 7. Adjustments to wood member and metal connector plate design value for conditions of use;
- 8. Maximum reaction force and direction, including maximum uplift reaction forces where applicable;
- 9. ~~[Metal connector plate type,]~~ Joint connection type and description, such as size and thickness or gage, and the dimensioned location of each [metal] joint connector [plate] except where symmetrically located relative to the joint interface;
- 10. Size, species and grade for each wood member;
- 11. Truss-to-truss connections and truss field assembly requirements;
- 12. Calculated span-to-deflection ratio and maximum vertical and horizontal deflection for live and total load as applicable;
- 13. Maximum axial tension and compression forces in the truss members; ~~[and]~~
- 14. Required permanent individual truss member restraint location and the method and details of restraint/bracing to be used in accordance with Section 2303.4.1.2[~~7~~];
- 15. Required temporary individual and system truss member restraint/bracing requirements for safe handling and field assembly.

2303.4.1.2 Permanent individual truss member restraint. Where permanent restraint of truss members is required on the truss design drawings, it shall be accomplished by one of the following methods:

- 1. Permanent individual truss member restraint/bracing shall be installed using standard industry lateral restraint/bracing details in accordance with generally accepted engineering practice. Locations for lateral restraint shall be identified on the truss design drawing.
- 2. The trusses shall be designed so that the buckling of any individual truss member is resisted internally by the individual truss through suitable means (i.e., buckling reinforcement by T-reinforcement or L-reinforcement, proprietary reinforcement, etc.). The buckling reinforcement of individual members of the trusses shall be

installed as shown on the truss design drawing or on supplemental truss member buckling reinforcement details provided by the truss designer.

3. A project-specific permanent individual truss member restraint/bracing design shall be permitted to be specified by any registered design professional.

2303.4.1.3 Trusses spanning 60 feet or greater. The owner or the owner's authorized agent shall contract with any qualified registered design professional for the design of the temporary installation restraint/bracing and the permanent individual truss member restraint/bracing for all trusses with clear spans 60 feet (18 288 mm) or greater.

2303.4.1.4 Truss designer. The individual or organization responsible for the design of trusses.

2303.4.1.4.1 Truss design drawings. Each individual truss design drawing shall bear the seal and signature of the truss designer.

Exceptions:

1. Where a cover sheet and truss index sheet are combined into a single sheet and attached to the set of truss design drawings, the single cover/truss index sheet is the only document required to be signed and sealed by the truss designer.
2. When a cover sheet and a truss index sheet are separately provided and attached to the set of truss design drawings, the cover sheet and the truss index sheet are the only documents required to be signed and sealed by the truss designer.

2303.4.2 Truss placement diagram. The truss manufacturer shall provide a truss placement diagram that identifies the proposed location for each individually designated truss and references the corresponding truss design drawing. The truss placement diagram shall be provided as part of the truss submittal package, and with the shipment of trusses delivered to the job site. Truss placement diagrams that serve only as a guide for installation and do not deviate from the Truss Designer's approved construction drawings shall not be required to bear the seal or signature of the truss designer.

2303.4.3 Truss submittal package. The truss submittal package provided by the truss manufacturer shall consist of each individual truss design drawing, the truss placement diagram, the permanent individual truss member restraint/bracing method and details and any other structural details germane to the trusses; and, as applicable, the cover/truss index sheet.

2303.4.4 Anchorage. The design for the transfer of loads and anchorage of each truss to the supporting structure is the responsibility of the registered design professional.

2303.4.5 Alterations to trusses. Truss members and components shall not be cut, notched, drilled, spliced or otherwise altered in any way without written concurrence and approval of a registered design professional. Alterations resulting in the addition of loads to any member (e.g.,

HVAC equipment, piping, additional roofing or insulation, etc.) shall not be permitted without verification that the truss is capable of supporting such additional loading.

2303.4.6 TPI 1 specifications. In addition to Sections 2303.4.1 through 2303.4.5, the design, manufacture and quality assurance of metal-plate-connected wood trusses shall be in accordance with TPI 1. Job-site inspections shall be in compliance with Section 110.4, as applicable.

2303.4.7 Glued prefabricated parallel chord wood trusses. In addition to Sections 2303.4.1 through 2303.4.5, the design, manufacture and quality assurance of glued prefabricated parallel chord wood trusses shall be in accordance with the rules of the department. Job-site inspections shall be in compliance with Sections 1704.6.2 and 1704.6.3, as applicable.

2303.4.8 Truss quality assurance. Trusses not part of a manufacturing process in accordance with either Section 2303.4.6 or a referenced standard [~~listed in Chapter 35~~], which provides requirements for quality control done under the supervision of a third-party quality control agency, shall be manufactured in compliance with Sections 1704.2 and [~~1704.6~~] 1705.5, as applicable.

2303.5 Test standard for joist hangers [and connectors]. [~~For the required test standards for joist hangers and connectors, see Section 1716.1.~~] Joist hangers shall be in accordance with ASTM D7147.

2303.6 Nails and staples. Nails and staples shall conform to requirements of ASTM F1667, including Supplement 1. Nails used for framing and sheathing connections shall have minimum average bending yield strengths as follows: 80 kips per square inch (ksi) (551 MPa) for shank diameters larger than 0.177 inch (4.50 mm) but not larger than 0.254 inch (6.45 mm), 90 ksi (620 MPa) for shank diameters larger than 0.142 inch (3.61 mm) but not larger than 0.177 inch (4.50 mm) and 100 ksi (689 MPa) for shank diameters of [~~at least~~] not less than 0.099 inch (2.51 mm) but not larger than 0.142 inch (3.61 mm). Staples used for framing and sheathing connections shall have minimum average bending moments as follows: 3.6 in.-lbs (0.41 N-m) for No. 16 gage staples, 4.0 in.-lbs (0.45 N-m) for No. 15 gage staples, and 4.3 in.-lbs (0.49 N-m) for No. 14 gage staples.

2303.7 Shrinkage. Consideration shall be given in design to the possible effect of cross-grain dimensional changes considered vertically which may occur in lumber fabricated in a green condition.

SECTION BC 2304 GENERAL CONSTRUCTION REQUIREMENTS

2304.1 General. The provisions of this section apply to design methods specified in Section 2301.2.

2304.2 Size of structural members. Computations to determine the required sizes of members shall be based on the net dimensions (actual sizes) and not nominal sizes.

2304.3 Wall framing. The framing of exterior and interior walls shall be in accordance with the provisions specified in Section 2308 unless a specific design is furnished.

2304.3.1 Bottom plates. Studs shall have full bearing on a 2-inch-thick (actual 1½-inch, 38 mm) or larger plate or sill having a width at least equal to the width of the studs.

2304.3.2 Framing over openings. Headers, double joists, trusses or other approved assemblies that are of adequate size to transfer loads to the vertical members shall be provided over window and door openings in load-bearing walls and partitions.

2304.3.3 Shrinkage. Wood walls and bearing partitions shall not support more than two floors and a roof unless an analysis satisfactory to the commissioner shows that shrinkage of the wood framing will not have adverse effects on the structure or any plumbing, electrical or mechanical systems[-] or other equipment installed therein due to excessive shrinkage or differential movements caused by shrinkage. The analysis shall also show that the roof drainage system and the foregoing systems or equipment will not be adversely affected or, as an alternate, such systems shall be designed to accommodate the differential shrinkage or movements.

2304.4 Floor and roof framing. The framing of wood-joisted floors and [~~wood-framed~~] wood-framed roofs shall be in accordance with the provisions specified in Section 2308 unless a specific design is furnished.

2304.4.1 Firecutting. The ends of wood beams, joists and rafters resting on unreinforced masonry or plain concrete walls shall be firecut to a bevel of 3 inches (76 mm) in depth.

2304.5 Framing around flues and chimneys. Combustible framing shall be a minimum of 2 inches (51 mm), but shall not be less than the distance specified in Sections 2111 and 2113 and the *New York City Mechanical Code*, from flues, chimneys and fireplaces, and 6 inches (152 mm) away from flue openings.

2304.6 [~~Wall~~] Exterior wall sheathing. [~~Except as provided for in Section 1405 for weatherboarding or where stucco construction that complies with Section 2510 is installed, enclosed buildings shall be sheathed with one of the materials of the nominal thickness specified in Table 2304.6 or any other approved material of equivalent strength or durability.~~] Wall sheathing on the outside of exterior walls, including gables, and the connection of the sheathing to framing shall be designed in accordance with the general provisions of this code and shall be capable of resisting wind pressures in accordance with Section 1609.

**[TABLE 2304.6
MINIMUM THICKNESS OF WALL SHEATHING]**

[SHEATHING TYPE]	[MINIMUM THICKNESS]	[MAXIMUM WALL STUD SPACING]
[Wood boards]	[5/8 inch]	[24 inches on center]
[Fiberboard]	[1/2 inch]	[16 inches on center]
[Wood structural panel]	[In accordance with Tables 2308.9.3(2) and 2308.9.3(3)]	[-]
[M-S "Exterior Glue" and M-2 "Exterior Glue" Particleboard]	[In accordance with Tables 2306.5 and 2308.9.3(4)]	[-]
[Gypsum sheathing]	[1/2 inch]	[16 inches on center]

**[TABLE 2304.6
MINIMUM THICKNESS OF WALL SHEATHING]**

[SHEATHING TYPE]	[MINIMUM THICKNESS]	[MAXIMUM WALL STUD SPACING]
[Gypsum wallboard]	[½ inch]	[24 inches on center]
[Reinforced cement mortar]	[1 inch]	[24 inches on center]

[For SI: 1 inch=25.4 mm.]

2304.6.1 Wood structural panel sheathing. Where wood structural panel sheathing is used as the exposed finish on the outside of exterior [~~of outside~~] walls, it shall have an exterior exposure durability classification. Where wood structural panel sheathing is used elsewhere, but not as the exposed finish, it shall be of a type manufactured with exterior glue (Exposure 1 or Exterior). Wood structural panel [wall] sheathing [~~or siding used as structural sheathing shall be capable of resisting wind pressures in accordance with Section 1609. Maximum wind speeds for wood structural panel sheathing used to resist wind pressures~~], connections and framing spacing shall be in accordance with Table 2304.6.1 for the applicable wind speed and exposure category where used in enclosed buildings with a mean roof height not greater than 30 feet (9144 mm) [~~an importance factor (I) of 1.0~~] and a topographic factor (K_{zt}) of 1.0.

TABLE 2304.6.1
MAXIMUM [BASIC] ALLOWABLE STRESS DESIGN WIND SPEED [(mph) (3-SECOND-GUST)] V_{asd}
PERMITTED FOR WOOD STRUCTURAL PANEL WALL SHEATHING USED TO RESIST WIND
PRESSURES^{a,b,c}

MINIMUM NAIL		MINIMUM WOOD STRUCTURAL PANEL SPAN RATING	MINIMUM NOMINAL PANEL THICKNESS (inches)	MAXIMUM WALL STUD SPACING (inches)	PANEL NAIL SPACING		MAXIMUM ALLOWABLE STRESS DESIGN WIND SPEED, V_{asd} ^d (mph)		
Size	Penetration (inches)				Edges (inches o.c.)	Field (inches o.c.)	Wind exposure category		
							B	C	D
6d common (2.0" × 0.113")	1.5	24/0	3/8	16	6	12	110	90	85
		24/16	7/16	16	6	12	110	100	90
6	150					125	110		
8d common (2.5" × 0.131")	1.75	24/16	7/16	16	6	12	130	110	105
						6	150	125	110
				24	6	12	110	90	85
						6	110	90	85

For SI: 1 inch = 25.4 mm, 1 mile per hour = 0.447 m/s.

- Panel strength axis shall be parallel or perpendicular to supports. Three-ply plywood sheathing with studs spaced more than 16 inches on center shall be applied with panel strength axis perpendicular to supports.
- The table is based on wind pressures acting toward and away from building surfaces in accordance with Section [6.4.2.2] 30.6 of ASCE 7. Lateral requirements shall be in accordance with Section 2305 or 2308.
- Wood structural panels with span ratings of wall-16 or wall-24 shall be permitted as an alternative to panels with a 24/0 span rating. Plywood siding rated 16 [ø-e:] on center or 24 [ø-e:] on center shall be permitted as an alternative to panels with a 24/16 span rating. Wall-16 and plywood siding 16 [ø-e:] on center shall be used with studs spaced [a maximum of] not more than 16 inches [ø-e:] on center.
- V_{asd} shall be determined in accordance with Section 1609.3.1.

[2304.6.2] 2304.7 Interior paneling. Softwood wood structural panels used for interior paneling shall conform to the provisions of Chapter 8 and shall be installed in accordance with Table [2304.9.1] 2304.10.1. Panels shall comply with DOC PS 1, DOC PS 2 or [PS2] ANSI/APA PRP 210. Prefinished hardboard paneling shall meet the requirements of CPA/ANSI A135.5. Hardwood plywood shall conform to HPVA HP-1.

[2304.7] 2304.8 Floor and roof sheathing. Structural floor sheathing and structural roof sheathing shall comply with Sections 2304.8.1 and 2304.8.2, respectively.

TABLE [2304.7(1)] 2304.8(1)
ALLOWABLE SPANS FOR LUMBER FLOOR AND ROOF SHEATHING^[a,b]

SPAN (inches)	MINIMUM NET THICKNESS (inches) OF LUMBER PLACED			
	Perpendicular to supports		Diagonally to supports	
	Surfaced dry ^[e]	Surfaced unseasoned	Surfaced dry ^[e]	Surfaced unseasoned
Floors				
24	3/4	25/32	3/4	25/32
16	5/8	11/16	5/8	11/16
Roofs				
24	5/8	11/16	3/4	25/32

For SI: 1 inch = 25.4 mm.

- [Installation details shall conform to Sections 2304.7.1 and 2304.7.2 for floor and roof sheathing, respectively.]
- [Floor or roof sheathing conforming with this table shall be deemed to meet the design criteria of Section 2304.7.]
- [e—] Maximum 19-percent moisture content.

TABLE [2304.7(2)] 2304.8(2)
SHEATHING LUMBER, MINIMUM GRADE REQUIREMENTS: BOARD GRADE

SOLID FLOOR OR ROOF SHEATHING	SPACED ROOF SHEATHING	GRADING RULES
Utility	Standard	NLGA, WCLIB, WWPA
4 common or utility	3 common or standard	NLGA, WCLIB, WWPA, NSLB or NELMA
No. 3	No. 2	SPIB
Merchantable	Construction common	RIS

TABLE [2304.7(2)] 2304.8(2)
SHEATHING LUMBER, MINIMUM GRADE REQUIREMENTS: BOARD GRADE

SOLID FLOOR OR ROOF SHEATHING	SPACED ROOF SHEATHING	GRADING RULES
-------------------------------	-----------------------	---------------

TABLE [2304.7(3)] 2304.8(3)
ALLOWABLE SPANS AND LOADS FOR WOOD STRUCTURAL PANEL SHEATHING AND SINGLE-FLOOR GRADES CONTINUOUS OVER TWO OR MORE SPANS WITH STRENGTH AXIS PERPENDICULAR TO SUPPORTS^{a, [b]}

SHEATHING GRADES		ROOF ^{[e]b}				FLOOR ^{[d]c}
Panel span rating roof/floor span	Panel thickness (inches)	Maximum span (inches)		Load ^{[e]d} (psf)		Maximum span (inches)
		With edge support ^{[f]e}	Without edge support	Total load	Live load	
16/0	3/8	16	16	40	30	0
20/0	3/8	20	20	40	30	0
24/0	3/8, 7/16, 1/2	24	20 ^{[g]i}	40	30	0
24/16	7/16, 1/2	24	24	50	40	16
32/16	15/32, 1/2, 5/8	32	28	40	30	16 ^{[h]g}
40/20	19/32, 5/8, 3/4, 7/8	40	32	40	30	20 ^{[g, h]i}
48/24	23/32, 3/4, 7/8	48	36	45	35	24
54/32	7/8, 1	54	40	45	35	32
60/32	7/8, 1 1/8	60	48	45	35	32
SINGLE FLOOR GRADES		ROOF ^{[e]b}				FLOOR ^{[d]c}
Panel span rating	Panel thickness (inches)	Maximum span (inches)		Load ^{[e]d} (psf)		Maximum span (inches)
		With edge support ^{[f]e}	Without edge support	Total load	Live load	
16 o.c.	1/2, 19/32, 5/8	24	24	50	40	16 ^{[h]g}
20 o.c.	19/32, 5/8, 3/4	32	32	40	30	20 ^{[g, h]i}
24 o.c.	23/32, 3/4	48	36	35	25	24
32 o.c.	7/8, 1	48	40	50	40	32
48 o.c.	1 3/32, 1 1/8	60	48	50	40	48

For SI: 1 inch = 25.4 mm, 1 pound per square foot = 0.0479 kN/m².

a. Applies to panels 24 inches or wider.

b. [Floor and roof sheathing conforming with this table shall be deemed to meet the design criteria of Section 2304.7.]

[e.] Uniform load deflection limitations 1/180 of span under live load plus dead load, 1/240 under live load only.

[d.]c. Panel edges shall have approved tongue-and-groove joints or shall be supported with blocking unless 1/4-inch minimum thickness underlayment or 1/2 inches of approved cellular or lightweight concrete is placed over the subfloor, or finish floor is 3/4-inch wood strip. Allowable uniform load based on deflection of 1/360 of span is 100 pounds per square foot except the span rating of 48 inches on center is based on a total load of 65 pounds per square foot.

[e.]d. Allowable load at maximum span.

[f.]e. Tongue-and-groove edges, panel edge clips (one midway between each support, except two equally spaced between supports 48 inches on center), lumber blocking or other. Only lumber blocking shall satisfy blocked diaphragm requirements.

[g.]f. For 1/2-inch panel, maximum span shall be 24 inches.

[h.]g. Span is permitted to be 24 inches on center where 3/4-inch wood strip flooring is installed at right angles to joist.

[i.]h. Span is permitted to be 24 inches on center for floors where 1 1/2 inches of cellular or lightweight concrete is applied over the panels.

TABLE [2304.7(4)] 2304.8(4)
ALLOWABLE SPAN FOR WOOD STRUCTURAL PANEL COMBINATION SUBFLOOR-UNDERLAYMENT (SINGLE FLOOR)^{a, [b]}

(Panels Continuous Over Two or More Spans and Strength Axis Perpendicular to Supports)

IDENTIFICATION	MAXIMUM SPACING OF JOISTS (inches)				
	16	20	24	32	48
Species group ^{[e]b}	Thickness (inches)				
1	1/2	5/8	3/4	—	—
2, 3	5/8	3/4	7/8	—	—
4	3/4	7/8	1	—	—
Single floor span rating ^{[d]c}	16 o.c.	20 o.c.	24 o.c.	32 o.c.	48 o.c.

For SI: 1 inch = 25.4 mm, 1 pound per square foot = 0.0479 kN/m².

a. Spans limited to value shown because of possible effects of concentrated loads. Allowable uniform loads based on deflection of 1/360 of span is 100 pounds per square foot except allowable total uniform load for 1 1/2-inch wood structural panels over joists spaced 48 inches on center is 65 pounds per square foot. Panel edges shall have approved tongue-and-groove joints or shall be supported with blocking, unless 1/4-inch minimum thickness underlayment or 1/2 inches of approved cellular or lightweight concrete is placed over the subfloor, or finish floor is 3/4-inch wood strip.

- b. ~~[Floor panels conforming with this table shall be deemed to meet the design criteria of Section 2304.7.]~~
 [e-] Applicable to all grades of sanded exterior-type plywood. See DOC PS 1 for plywood species groups.
 [d-] Applicable to Underlayment grade, C-C (Plugged) plywood, and Single Floor grade wood structural panels.

TABLE [2304.7(5)] 2304.8(5)
ALLOWABLE LOAD (PSF) FOR WOOD STRUCTURAL PANEL ROOF SHEATHING CONTINUOUS
OVER TWO OR MORE SPANS AND STRENGTH AXIS PARALLEL TO SUPPORTS
(Plywood Structural Panels Are Five-Ply, Five-Layer Unless Otherwise Noted)^{a [e-b]}

PANEL GRADE	THICKNESS (inch)	MAXIMUM SPAN (inches)	LOAD AT MAXIMUM SPAN (psf)	
			Live	Total
Structural I sheathing	$\frac{7}{16}$	24	20	30
	$\frac{15}{32}$	24	35 ^{[e]b}	45 ^{[e]b}
	$\frac{1}{2}$	24	40 ^{[e]b}	50 ^{[e]b}
	$\frac{19}{32}, \frac{5}{8}$	24	70	80
	$\frac{23}{32}, \frac{3}{4}$	24	90	100
Sheathing, other grades covered in DOC PS 1 or DOC PS 2	$\frac{7}{16}$	16	40	50
	$\frac{15}{32}$	24	20	25
	$\frac{1}{2}$	24	25	30
	$\frac{19}{32}$	24	40 ^{[e]b}	50 ^{[e]b}
	$\frac{5}{8}$	24	45 ^{[e]b}	55 ^{[e]b}
	$\frac{23}{32}, \frac{3}{4}$	24	60 ^{[e]b}	65 ^{[e]b}

For SI: 1 inch = 25.4 mm, 1 pound per square foot = 0.0479 kN/m².

- a. ~~[Roof sheathing conforming with this table shall be deemed to meet the design criteria of Section 2304.7.]~~
 [b-] Uniform load deflection limitations $\frac{1}{180}$ of span under live load plus dead load, $\frac{1}{240}$ under live load only. Edges shall be blocked with lumber or other approved type of edge supports.
 [e-] For composite and four-ply plywood structural panel, load shall be reduced by 15 pounds per square foot.

[2304.7.1] 2304.8.1 Structural floor sheathing. Structural floor sheathing shall be designed in accordance with the general provisions of this code ~~[and the special provisions in this section. Floor sheathing conforming to the provisions of Table 2304.7(1), 2304.7(2), 2304.7(3) or 2304.7(4) shall be deemed to meet the requirements of this section].~~

Floor sheathing conforming to the provisions of Table 2304.8(1), 2304.8(2), 2304.8(3) or 2304.8(4) shall be deemed to meet the requirements of this section.

[2304.7.2] 2304.8.2 Structural roof sheathing. Structural roof sheathing shall be designed in accordance with the general provisions of this code and the special provisions in this section. ~~[Roof sheathing conforming to the provisions of Table 2304.7(1), 2304.7(2), 2304.7(3) or 2304.7(5) shall be deemed to meet the requirements of this section. Wood structural panel roof sheathing shall be bonded by exterior glue.]~~

Roof sheathing conforming to the provisions of Table 2304.8(1), 2304.8(2), 2304.8(3) or 2304.8(5) shall be deemed to meet the requirements of this section. Wood structural panel roof sheathing shall be of a type manufactured with exterior glue (Exposure 1 or Exterior).

[2304.8] 2304.9 Lumber decking. Lumber decking shall be designed and installed in accordance with the general provisions of this code and Sections 2304.9.1 through 2304.9.5.3.

[2304.8.1] 2304.9.1 General. ~~[Lumber decking shall be designed and installed in accordance with the general provisions of this code and Section 2304.8.]~~ Each piece of lumber decking shall be ~~[square end]~~ square-end trimmed. When random lengths are furnished, each piece shall be ~~[square end]~~ square-end trimmed across the face so that at least 90 percent of the pieces are within 0.5 degrees (0.00873 rad) of square. The ends of the pieces shall be permitted to be beveled up to 2 degrees (0.0349 rad) from the vertical with the exposed face of the piece slightly longer than the opposite face of the piece. Tongue-and-groove decking shall be installed with the tongues up on sloped or pitched roofs with pattern faces down.

[2304.8.2] 2304.9.2 Layup patterns. Lumber decking is permitted to be laid up following one of five standard patterns as defined in Sections [2304.8.2.1] 2304.9.2.1 through [2304.8.2.5] 2304.9.2.5. Other patterns are permitted to be used provided they are substantiated through engineering analysis.

[2304.8.2.1] 2304.9.2.1 Simple span pattern. All pieces shall be supported on their ends (i.e., by two supports).

[2304.8.2.2] 2304.9.2.2 Two-span continuous pattern. All pieces shall be supported by three supports, and all end joints shall occur in line on alternating supports. Supporting members shall be designed to accommodate the load redistribution caused by this pattern.

[2304.8.2.3] 2304.9.2.3 Combination simple and two-span continuous pattern. Courses in end spans shall be alternating simple-span pattern and two-span continuous pattern. End joints shall be staggered in adjacent courses and shall bear on supports.

[2304.8.2.4] 2304.9.2.4 Cantilevered pieces intermixed pattern. The decking shall extend across a minimum of three spans. Pieces in each starter course and every third course shall be simple span pattern. Pieces in other courses shall be cantilevered over the supports with end joints at alternating quarter or third points of the spans. Each piece shall bear on at least one support.

[2304.8.2.5] 2304.9.2.5 Controlled random pattern. The decking shall extend across a minimum of three spans. End joints of pieces within 6 inches (152 mm) of the end joints of the adjacent pieces in either direction shall be separated by at least two intervening courses. In the end bays, each piece shall bear on at least one support. Where an end joint occurs in an end bay, the next piece in the same course shall continue over the first inner support for at least 24 inches (610 mm). The details of the controlled random pattern shall be as specified for each decking material in Section [2304.8.3.3] 2304.9.3.3, [2304.8.4.3] 2304.9.4.3 or [2304.8.5.3] 2304.9.5.3. [~~Decking that cantilevers beyond a support for a horizontal distance greater than 18 inches (457 mm), 24 inches (610 mm) or 36 inches (914 mm) for 2-inch (51 mm), 3-inch (76 mm) and 4-inch (102 mm) nominal thickness decking, respectively, shall comply with the following:~~]

Decking that cantilevers beyond a support for a horizontal distance greater than 18 inches (457 mm), 24 inches (610 mm) or 36 inches (914 mm) for 2-inch (51 mm), 3-inch (76 mm) and 4-inch (102 mm) nominal thickness decking, respectively, shall comply with the following:

1. The maximum cantilevered length shall be 30 percent of the length of the first adjacent interior span;
2. A structural fascia shall be fastened to each decking piece to maintain a continuous, straight line; and
3. There shall be no end joints in the decking between the cantilevered end of the decking and the centerline of the first adjacent interior span.

[2304.8.3] 2304.9.3 Mechanically laminated decking. Mechanically laminated decking shall comply with Sections 2304.9.3.1 through 2304.9.3.3.

[2304.8.3.1] 2304.9.3.1 General. Mechanically laminated decking consists of square-edged dimension lumber laminations set on edge and ~~nailed~~ mechanically fastened to the adjacent pieces and to the supports.

2304.9.3.2 Nailing and fastening to supports. Nailing of adjacent laminations and fastening to supports shall conform to the requirements of Section 2304.9.3.2.1 through 2304.9.3.2.2.

2304.9.3.2.1 Two-inch mechanically laminated decking. For mechanically laminated decking constructed with laminations of 2-inch (51 mm) nominal thickness, nailing and fastening to supports in accordance with Table 2304.9.3.2.1 shall be permitted. Other connections are permitted to be used provided they are reviewed and approved by the registered design professional of record, but shall be spaced at no more than 16 inches (406 mm) on center.

**TABLE 2304.9.3.2.1
FASTENING SCHEDULE FOR MECHANICALLY LAMINATED DECKING USING LAMINATIONS OF
2-INCH NOMINAL THICKNESS**

MINIMUM NAIL SIZE (Length x Diameter)	MAXIMUM SPACING BETWEEN FACE NAILS^{a,b,c} (inches)		NUMBER OF TOENAILS INTO SUPPORTS^d
	Decking Supports ≤ 48 inches on center	Decking Supports > 48 inches on center	
4" x 0.192"	30	18	1
4" x 0.162"	24	14	2
4" x 0.148"	22	13	2
3½" x 0.162"	20	12	2
3½" x 0.148"	19	11	2
3½" x 0.135"	17	10	2
3" x 0.148"	11	7	2
3" x 0.128"	9	5	2
2¾" x 0.148"	10	6	2
2¾" x 0.131"	9	6	3
2¾" x 0.120"	8	5	3

For SI: 1 inch = 25.4mm

- a. Nails shall be driven perpendicular to the lamination face, alternating between top and bottom edges.
- b. Where nails penetrate through two laminations and into the third, they shall be staggered one-third of the spacing in adjacent laminations. Otherwise, nails shall be staggered one-half of the spacing in adjacent laminations.
- c. Two side nails shall be installed at each end of butt-jointed pieces.
- d. Where supports are 48 inches (1219 mm) on center or less, alternate laminations shall be toenailed to alternate supports; where supports are spaced more than 48 inches (1219 mm) on center, alternate laminations shall be toenailed to every support.

[2304.8.3.2 Nailing. The] 2304.9.3.2.2 Three- and four-inch mechanically laminated decking. For mechanically laminated decking constructed with laminations of 3-inch (76 mm) and 4-inch (102 mm) thickness, the length of nails connecting laminations shall not be less than two and one-half times the net thickness of each lamination. Where decking supports are 48 inches (1219 mm) on center ~~[(ø.ø.)]~~ or less, side nails shall be installed not more than 30 inches (762 mm) ~~[(ø.ø.)]~~ on center alternating between top and bottom edges, and staggered one-third of the spacing in adjacent laminations. Where supports are spaced more than 48 inches (1219 mm) ~~[(ø.ø.)]~~ on center, side nails shall be installed

not more than 18 inches (457 mm) [~~(o.c.)~~] on center alternating between top and bottom edges and staggered one-third of the spacing in adjacent laminations. Two side nails shall be installed at each end of butt-jointed pieces. [~~Laminations shall be toenailed to supports with 20d or larger common nails. Where the supports are 48 inches (1219 mm) (o.c.) or less, alternate laminations shall be toenailed to alternate supports; where supports are spaced more than 48 inches (1219 mm) (o.c.), alternate laminations shall be toenailed to every support.~~]

Laminations shall be toenailed to supports with 20d or larger common nails. Where the supports are 48 inches (1219 mm) on center or less, alternate laminations shall be toenailed to alternate supports; where supports are spaced more than 48 inches (1219 mm) on center, alternate laminations shall be toenailed to every support.

Other connections are permitted to be used provided they are reviewed and approved by the registered design professional of record, but shall be spaced at no more than 16 inches (406 mm) on center.

[~~2304.8.3.3~~ 2304.9.3.3 Controlled random pattern. There shall be a minimum distance of 24 inches (610 mm) between end joints in adjacent courses. The pieces in the first and second courses shall bear on at least two supports with end joints in these two courses occurring on alternate supports. A maximum of seven intervening courses shall be permitted before this pattern is repeated.

[~~2304.8.4~~ 2304.9.4 Two-inch sawn tongue-and-groove decking. Two-inch (51 mm) sawn tongue-and-groove decking shall comply with Sections 2304.9.4.1 through 2304.9.4.3.

[~~2304.8.4.1~~ 2304.9.4.1 General. Two-inch (51 mm) decking shall have a maximum moisture content of 15 percent when machined and installed. Decking shall be machined with a single tongue-and-groove pattern. Each decking piece shall be nailed to each support.

[~~2304.8.4.2~~ 2304.9.4.2 Nailing. Each piece of decking shall be toenailed at each support with one 16d common nail through the tongue and face-nailed with one 16d common nail.

[~~2304.8.4.3~~ 2304.9.4.3 Controlled random pattern. There shall be a minimum distance of 24 inches (610 mm) between end joints in adjacent courses. The pieces in the first and second courses shall bear on at least two supports with end joints in these two courses occurring on alternate supports. A maximum of seven intervening courses shall be permitted before this pattern is repeated.

[~~2304.8.5~~ 2304.9.5 Three- and [~~4-inch~~] four-inch sawn tongue-and-groove decking. Three- and four-inch (76 mm and 102 mm) sawn tongue-and-groove decking shall comply with Sections 2304.9.5.1 through 2304.9.5.3.

[~~2304.8.5.1~~ 2304.9.5.1 General. Three-inch (76 mm) and [~~4-inch~~] four-inch (102 mm) decking shall have a maximum moisture content of 19 percent when machined and installed. Decking shall be machined with a double tongue-and-groove pattern. Decking pieces shall be interconnected and nailed to the supports.

[2304.8.5.2] **2304.9.5.2 Nailing.** Each piece shall be toenailed at each support with one 40d common nail and face-nailed with one 60d common nail. Courses shall be spiked to each other with 8-inch (203 mm) spikes at maximum intervals of 30 inches (762 mm) through predrilled edge holes penetrating to a depth of approximately 4 inches [~~(102mm)~~] (102 mm). One spike shall be installed at a distance not exceeding 10 inches (254 mm) from the end of each piece.

[2304.8.5.3] **2304.9.5.3 Controlled random pattern.** There shall be a minimum distance of 48 inches (1219 mm) between end joints in adjacent courses. Pieces not bearing on a support are permitted to be located in interior bays provided the adjacent pieces in the same course continue over the support for at least 24 inches (610 mm). This condition shall not occur more than once in every six courses in each interior bay.

[2304.9 Connections] **2304.10 Connectors and fasteners.** Connectors and fasteners shall comply with the applicable provisions of Sections 2304.10.1 through 2304.10.8.

[2304.9.1] **2304.10.1 Fastener requirements.** Connections for wood members shall be designed in accordance with the appropriate methodology in Section 2301.2. The number and size of fasteners connecting wood members shall not be less than that set forth in Table [2304.9.1] 2304.10.1.

[TABLE 2304.9.1
FASTENING SCHEDULE

CONNECTION	FASTENING ^{a,m}	LOCATION
1. Joist to sill or girder	3— 8d common (2 ¹ / ₂ " × 0.131") 3— 3" × 0.131" nails 3— 3" 14 gage staples	toenail
2. Bridging to joist	2— 8d common (2 ¹ / ₂ " × 0.131") 2— 3" × 0.131" nails 2— 3" 14 gage staples	toenail each end
3. 1" × 6" subfloor or less to each joist	2— 8d common (2 ¹ / ₂ " × 0.131")	face nail
4. Wider than 1" × 6" subfloor to each joist	3— 8d common (2 ¹ / ₂ " × 0.131")	face nail
5. 2" subfloor to joist or girder	2— 16d common (3 ¹ / ₂ " × 0.162")	blind and face nail
6. Sole plate to joist or blocking	16d (3 ¹ / ₂ " × 0.135") at 16" o.c. 3" × 0.131" nails at 8" o.c. 3" 14 gage staples at 12" o.c.	typical face nail
Sole plate to joist or blocking at braced wall panel	3— 16d (3 ¹ / ₂ " × 0.135") at 16" o.c. 4— 3" × 0.131" nails at 16" o.c. 4— 3" 14 gage staples at 16" o.c.	braced wall panels
7. Top plate to stud	2— 16d common (3 ¹ / ₂ " × 0.162") 3— 3" × 0.131" nails 3— 3" 14 gage staples	end nail
8. Stud to sole plate	4— 8d common (2 ¹ / ₂ " × 0.131") 4— 3" × 0.131" nails 3— 3" 14 gage staples 2— 16d common (3 ¹ / ₂ " × 0.162") 3— 3" × 0.131" nails 3— 3" 14 gage staples	toenail end nail
9. Double studs	16d (3 ¹ / ₂ " × 0.135") at 24" o.c. 3" × 0.131" nail at 8" o.c.	face nail

**[TABLE 2304.9.1
FASTENING SCHEDULE**

CONNECTION	FASTENING^{a,m}	LOCATION
	3" 14 gage staple at 8" o.c.	
10. Double top plates	16d (3 ¹ / ₂ " × 0.135") at 16" o.c. 3" × 0.131" nail at 12" o.c. 3" 14 gage staple at 12" o.c.	typical face nail
–Double top plates	8—16d common (3 ¹ / ₂ " × 0.162") 12—3" × 0.131" nails 12—3" 14 gage staples	lap splice
11. Blocking between joists or rafters to top plate	3—8d common (2 ¹ / ₂ " × 0.131") 3—3" × 0.131" nails 3—3" 14 gage staples	toenail
12. Rim joist to top plate	8d (2 ¹ / ₂ " × 0.131") at 6" o.c. 3" × 0.131" nail at 6" o.c. 3" 14 gage staple at 6" o.c.	toenail
13. Top plates, laps and intersections	2—16d common (3 ¹ / ₂ " × 0.162") 3—3" × 0.131" nails 3—3" 14 gage staples	face nail
14. Continuous header, two pieces	16d common (3 ¹ / ₂ " × 0.162")	16" o.c. along edge
15. Ceiling joists to plate	3—8d common (2 ¹ / ₂ " × 0.131") 5—3" × 0.131" nails 5—3" 14 gage staples	toenail
16. Continuous header to stud	4—8d common (2 ¹ / ₂ " × 0.131")	toenail
17. Ceiling joists, laps over partitions (see Section 2308.10.4.1, Table 2308.10.4.1)	3—16d common (3 ¹ / ₂ " × 0.162") minimum; Table 2308.10.4.1 4—3" × 0.131" nails 4—3" 14 gage staples	face nail
18. Ceiling joists to parallel rafters (see Section 2308.10.4.1, Table 2308.10.4.1)	3—16d common (3 ¹ / ₂ " × 0.162") minimum; Table 2308.10.4.1 4—3" × 0.131" nails 4—3" 14 gage staples	face nail
19. Rafter to plate (see Section 2308.10.1, Table 2308.10.1)	3—8d common (2 ¹ / ₂ " × 0.131") 3—3" × 0.131" nails 3—3" 14 gage staples	toenail
20. 1" diagonal brace to each stud and plate	2—8d common (2 ¹ / ₂ " × 0.131") 2—3" × 0.131" nails 3—3" 14 gage staples	face nail
21. 1" × 8" sheathing to each bearing	3—8d common (2 ¹ / ₂ " × 0.131")	face nail
22. Wider than 1" × 8" sheathing to each bearing	3—8d common (2 ¹ / ₂ " × 0.131")	face nail
23. Built up corner studs	16d common (3 ¹ / ₂ " × 0.162") 3" × 0.131" nails 3" 14 gage staples	24" o.c. 16" o.c. 16" o.c.
24. Built up girder and beams	20d common (4" × 0.192") 32" o.c. 3" × 0.131" nail at 24" o.c. 3" 14 gage staple at 24" o.c. 2—20d common (4" × 0.192") 3—3" × 0.131" nails 3—3" 14 gage staples	face nail at top and bottom staggered on opposite sides face nail at ends at each splice
25. 2" planks	16d common (3 ¹ / ₂ " × 0.162")	at each bearing
26. Collar tie to rafter	3—10d common (3" × 0.148") 4—3" × 0.131" nails 4—3" 14 gage staples	face nail

**[TABLE 2304.9.1
FASTENING SCHEDULE**

CONNECTION	FASTENING ^{a,m}	LOCATION
27. Jack rafter to hip	3—10d common (3" × 0.148") 4—3" × 0.131" nails 4—3" 14 gage staples 2—16d common (3 ¹ / ₂ " × 0.162") 3—3" × 0.131" nails 3—3" 14 gage staples	toenail face nail
28. Roof rafter to 2 by ridge beam	2—16d common (3 ¹ / ₂ " × 0.162") 3—3" × 0.131" nails 3—3" 14 gage staples 2—16d common (3 ¹ / ₂ " × 0.162") 3—3" × 0.131" nails 3—3" 14 gage staples	toenail face nail
29. Joist to band joist	3—16d common (3 ¹ / ₂ " × 0.162") 4—3" × 0.131" nails 4—3" 14 gage staples	face nail
30. Ledger strip	3—16d common (3 ¹ / ₂ " × 0.162") 4—3" × 0.131" nails 4—3" 14 gage staples	face nail at each joist
31. Wood structural panels and particleboard ^a Subfloor, roof and wall sheathing (to framing) Single floor (combination subfloor-underlayment to framing)	¹ / ₂ " and less — 6d ^{e,t} — 2 ³ / ₈ " × 0.113" nail ⁿ — 1 ³ / ₄ " 16 gage ^o ¹⁹ / ₃₂ " to ³ / ₄ " — 8d ^d or 6d ^e — 2 ³ / ₈ " × 0.113" nail ^p — 2" 16 gage ^p ⁷ / ₈ " to 1" — 8d ^e 1 ¹ / ₈ " to 1 ¹ / ₄ " — 10d ^d or 8d ^e ³ / ₄ " and less — 6d ^e ⁷ / ₈ " to 1" — 8d ^e 1 ¹ / ₈ " to 1 ¹ / ₄ " — 10d ^d or 8d ^e	
32. Panel siding (to framing)	¹ / ₂ " or less — 6d ^f ⁵ / ₈ " — 8d ^f	
33. Fiberboard sheathing ^z	¹ / ₂ " — No. 11 gage roofing nail ^b — 6d common nail (2" × 0.113") — No. 16 gage staple ^l ²⁵ / ₃₂ " — No. 11 gage roofing nail ^b — 8d common nail (2 ¹ / ₂ " × 0.131") — No. 16 gage staple ^l	
34. Interior paneling	¹ / ₄ " — 4d ^j ³ / ₈ " — 6d ^k	

For SI: 1 inch = 25.4 mm.

a. — Common or box nails are permitted to be used except where otherwise stated.

b. — Nails spaced at 6 inches on center at edges, 12 inches at intermediate supports except 6 inches at supports where spans are 48 inches or more. For nailing of wood structural panel and particleboard diaphragms and shear walls, refer to Section 2305. Nails for wall sheathing are permitted to be common, box or casing.

c. — Common or deformed shank (6d—2" × 0.113"; 8d—2¹/₂" × 0.131"; 10d—3" × 0.148").

d. — Common (6d—2" × 0.113"; 8d—2¹/₂" × 0.131"; 10d—3" × 0.148").

e. — Deformed shank (6d—2" × 0.113"; 8d—2¹/₂" × 0.131"; 10d—3" × 0.148").

f. — Corrosion resistant siding (6d—1⁷/₈" × 0.106"; 8d—2³/₈" × 0.128") or casing (6d—2" × 0.099"; 8d—2¹/₂" × 0.113") nail.

g. — Fasteners spaced 3 inches on center at exterior edges and 6 inches on center at intermediate supports, when used as structural sheathing. Spacing shall be 6 inches on center on the edges and 12 inches on center at intermediate supports for nonstructural applications.

h. — Corrosion resistant roofing nails with ⁷/₁₆-inch diameter head and 1¹/₂-inch length for ¹/₂-inch sheathing and 1³/₄-inch length for ²⁵/₃₂-inch sheathing.

i. — Corrosion resistant staples with nominal ⁷/₁₆-inch crown or 1-inch crown and 1¹/₄-inch length for ¹/₂-inch sheathing and 1¹/₂-inch length for ²⁵/₃₂-inch sheathing. Panel supports at 16 inches (20 inches if strength axis in the long direction of the panel, unless otherwise marked).

- j. Casing ($1\frac{1}{2}'' \times 0.080''$) or finish ($1\frac{1}{2}'' \times 0.072''$) nails spaced 6 inches on panel edges, 12 inches at intermediate supports.
- k. Panel supports at 24 inches. Casing or finish nails spaced 6 inches on panel edges, 12 inches at intermediate supports.
- l. For roof sheathing applications, 8d nails ($2\frac{1}{2}'' \times 0.113''$) are the minimum required for wood structural panels.
- m. Staples shall have a minimum crown width of $\frac{7}{16}''$ inch.
- n. For roof sheathing applications, fasteners spaced 4 inches on center at edges, 8 inches at intermediate supports.
- o. Fasteners spaced 4 inches on center at edges, 8 inches at intermediate supports for subfloor and wall sheathing and 3 inches on center at edges, 6 inches at intermediate supports for roof sheathing.
- p. Fasteners spaced 4 inches on center at edges, 8 inches at intermediate supports.]

**TABLE 2304.10.1
FASTENING SCHEDULE**

<u>DESCRIPTION OF BUILDING ELEMENTS</u>	<u>NUMBER AND TYPE OF FASTENER</u>	<u>SPACING AND LOCATION</u>
Roof		
1. Blocking between ceiling joists, rafters or trusses to top plate or other framing below	3-8d common ($2\frac{1}{2}'' \times 0.131''$); or 3-10d box ($3'' \times 0.128''$); or 3-3" $\times 0.131''$ nails; or 3-3" 14 gage staples, $\frac{7}{16}''$ crown	Each end, toenail
Blocking between rafters or truss not at the wall top plate, to rafter or truss	2-8d common ($2\frac{1}{2}'' \times 0.131''$) 2-3" $\times 0.131''$ nails 2-3" 14 gage staples	Each end, toenail
	2-16 d common ($3\frac{1}{2}'' \times 0.162''$) 3-3" $\times 0.131''$ nails 3-3" 14 gage staples	End nail
Flat blocking to truss and web filler	16d common ($3\frac{1}{2}'' \times 0.162''$) @ 6" o.c. 3" $\times 0.131''$ nails @ 6" o.c. 3" $\times 14$ gage staples @ 6" o.c	Face nail
2. Ceiling joists to top plate	3-8d common ($2\frac{1}{2}'' \times 0.131''$); or 3-10d box ($3'' \times 0.128''$); or 3-3" $\times 0.131''$ nails; or 3-3" 14 gage staples, $\frac{7}{16}''$ crown	Each joist, toenail
3. Ceiling joist not attached to parallel rafter, laps over partitions (no thrust) (see Section 2308.7.3.1, Table 2308.7.3.1)	3-16d common ($3\frac{1}{2}'' \times 0.162''$); or 4-10d box ($3'' \times 0.128''$); or 4-3" $\times 0.131''$ nails; or 4-3" 14 gage staples, $\frac{7}{16}''$ crown	Face nail
4. Ceiling joist attached to parallel rafter (heel joint) (see Section 2308.7.3.1, Table 2308.7.3.1)	Per Table 2308.7.3.1	Face nail
5. Collar tie to rafter	3-10d common ($3'' \times 0.148''$); or 4-10d box ($3'' \times 0.128''$); or 4-3" $\times 0.131''$ nails; or 4-3" 14 gage staples, $\frac{7}{16}''$ crown	Face nail
6. Rafter or roof truss to top plate (See Section 2308.7.5, Table 2308.7.5)	3-10 common ($3'' \times 0.148''$); or 3-16d box ($3\frac{1}{2}'' \times 0.135''$); or 4-10d box ($3'' \times 0.128''$); or 4-3" $\times 0.131''$ nails; or 4-3" 14 gage staples, $\frac{7}{16}''$ crown	Toenail
7. Roof rafters to ridge valley or hip rafters; or roof rafter to 2-inch ridge beam	2-16d common ($3\frac{1}{2}'' \times 0.162''$); or 3-10d box ($3'' \times 0.128''$); or 3-3" $\times 0.131''$ nails; or 3-3" 14 gage staples, $\frac{7}{16}''$ crown; or	End nail
	3-10d common ($3'' \times 0.148''$); or 4-16d box ($3\frac{1}{2}'' \times 0.135''$); or 4-10d box ($3'' \times 0.128''$); or 4-3" $\times 0.131''$ nails; or 4-3" 14 gage staples, $\frac{7}{16}''$ crown	Toenail
Wall		
8. Stud to stud (not at braced wall panels)	16d common ($3\frac{1}{2}'' \times 0.162''$); 10d box ($3'' \times 0.128''$); or 3" $\times 0.131''$ nails; or 3-3" 14 gage staples, $\frac{7}{16}''$ crown	24" o.c. face nail
	16d common ($3\frac{1}{2}'' \times 0.162''$); or	16" o.c. face nail
9. Stud to stud and abutting studs at intersecting wall corners (at braced wall panels)	16d box ($3\frac{1}{2}'' \times 0.135''$); or	16" o.c. face nail
	3" $\times 0.131''$ nails; or 3-3" 14 gage staples, $\frac{7}{16}''$ crown	12" o.c. face nail
10. Built-up header (2" to 2" header)	16d common ($3\frac{1}{2}'' \times 0.162''$); or	16" o.c. each edge, face nail

**TABLE 2304.10.1
FASTENING SCHEDULE**

DESCRIPTION OF BUILDING ELEMENTS	NUMBER AND TYPE OF FASTENER	SPACING AND LOCATION
	16d box (3 ¹ / ₂ " × 0.135")	12" o.c. each edge, face nail
11. Continuous header to stud	4-8d common (2 ¹ / ₂ " × 0.131"); or 4-10d box (3" × 0.128")	Toenail
	16d common (3 ¹ / ₂ " × 0.162"); or	16" o.c. face nail
12. Top plate to top plate	10d box (3" × 0.128"); or 3" × 0.131" nails; or 3" 14 gage staples, ⁷ / ₁₆ " crown	12" o.c. face nail
13. Top plate to top plate, at end joints	8-16d common (3 ¹ / ₂ " × 0.162"); or 12-10d box (3" × 0.128"); or 12-3" × 0.131" nails; or 12-3" 14 gage staples, ⁷ / ₁₆ " crown	Each side of end joint, face nail (minimum 24" lap splice length each side of end joint)
	16d common (3 ¹ / ₂ " × 0.162"); or	16" o.c. face nail
14. Bottom plate to joist, rim joist, band joist or blocking (not at braced wall panels)	16d box (3 ¹ / ₂ " × 0.135"); or 3" × 0.131" nails; or 3" 14 gage staples, ⁷ / ₁₆ " crown	12" o.c. face nail
15. Bottom plate to joist, rim joist, band joist or blocking at braced wall panels	2-16d common (3 ¹ / ₂ " × 0.162"); or 3-16d box (3 ¹ / ₂ " × 0.135"); or 4-3" × 0.131" nails; or 4-3" 14 gage staples, ⁷ / ₁₆ " crown	16" o.c. face nail
	4-8d common (2 ¹ / ₂ " × 0.131"); or 4-10d box (3" × 0.128"); or 4-3" × 0.131" nails; or 4-3" 14 gage staples, ⁷ / ₁₆ " crown; or	Toenail
16. Stud to top or bottom plate	2-16d common (3 ¹ / ₂ " × 0.162"); or 3-10d box (3" × 0.128"); or 3-3" × 0.131" nails; or 3-3" 14 gage staples, ⁷ / ₁₆ " crown	End nail
17. Top plates, laps at corners and intersections	2-16d common (3 ¹ / ₂ " × 0.162"); or 3-10d box (3" × 0.128"); or 3-3" × 0.131" nails; or 3-3" 14 gage staples, ⁷ / ₁₆ " crown	Face nail
18. 1" brace to each stud and plate	2-8d common (2 ¹ / ₂ " × 0.131"); or 2-10d box (3" × 0.128"); or 2-3" × 0.131" nails; or 2-3" 14 gage staples, ⁷ / ₁₆ " crown	Face nail
19. 1" × 6" sheathing to each bearing	2-8d common (2 ¹ / ₂ " × 0.131"); or 2-10d box (3" × 0.128")	Face nail
20. 1" × 8" and wider sheathing to each bearing	3-8d common (2 ¹ / ₂ " × 0.131"); or 3-10d box (3" × 0.128")	Face nail
Floor		
21. Joist to sill, top plate, or girder	3-8d common (2 ¹ / ₂ " × 0.131"); or floor 3-10d box (3" × 0.128"); or 3-3" × 0.131" nails; or 3-3" 14 gage staples, ⁷ / ₁₆ " crown	Toenail
22. Rim joist, band joist, or blocking to top plate, sill or other framing below	8d common (2 ¹ / ₂ " × 0.131"); or 10d box (3" × 0.128"); or 3" × 0.131" nails; or 3" 14 gage staples, ⁷ / ₁₆ " crown	6" o.c., toenail
23. 1" × 6" subfloor or less to each joist	2-8d common (2 ¹ / ₂ " × 0.131"); or 2-10d box (3" × 0.128")	Face nail
24. 2" subfloor to joist or girder	2-16d common (3 ¹ / ₂ " × 0.162")	Face nail
25. 2" planks (plank & beam – floor & roof)	2-16d common (3 ¹ / ₂ " × 0.162")	Each bearing, face nail
	20d common (4" × 0.192")	32" o.c., face nail at top and bottom staggered on opposite sides
26. Built-up girders and beams, 2" lumber layers	10d box (3" × 0.128"); or 3" × 0.131" nails; or 3" 14 gage staples, ⁷ / ₁₆ " crown	24" o.c. face nail at top and bottom staggered on opposite sides
	And: 2-20d common (4" × 0.192"); or 3-10d box (3" × 0.128"); or 3-3" × 0.131" nails; or 3-3" 14 gage staples, ⁷ / ₁₆ " crown	Ends and at each splice, face nail

**TABLE 2304.10.1
FASTENING SCHEDULE**

DESCRIPTION OF BUILDING ELEMENTS	NUMBER AND TYPE OF FASTENER	SPACING AND LOCATION	
27. Ledger strip supporting joists or rafters	3-16d common (3 ¹ / ₂ " × 0.162"); or 4-10d box (3" × 0.128"); or 4-3" × 0.131" nails; or 4-3" 14 gage staples, ⁷ / ₁₆ " crown	Each joist or rafter, face nail	
28. Joist to band joist or rim joist	3-16d common (3 ¹ / ₂ " × 0.162"); or 4-10d box (3" × 0.128"); or 4-3" × 0.131" nails; or 4-3" 14 gage staples, ⁷ / ₁₆ " crown	End nail	
29. Bridging or blocking to joist, rafter or truss	2-8d common (2 ¹ / ₂ " × 0.131"); or 2-10d box (3" × 0.128"); or 2-3" × 0.131" nails; or 2-3" 14 gage staples, ⁷ / ₁₆ " crown	Each end, toenail	
Wood structural panels (WSP), subfloor, roof and interior wall sheathing to framing and particleboard wall sheathing to framing^a			
		Edges (inches)	Intermediate supports (inches)
30. $\frac{3}{8}'' - \frac{1}{2}''$	6d common or deformed (2" × 0.113") (subfloor and wall)	6	12
	8d common or deformed (2 ¹ / ₂ " × 0.113") (roof) or RSRs-01 (23/8" × 0.113") nail (roof) ^d	6	12
	2 ³ / ₈ " × 0.113" nail (subfloor and wall)	6	12
	1 ³ / ₄ " 16 gage staple, ⁷ / ₁₆ " crown (subfloor and wall)	4	8
	2 ³ / ₈ " × 0.113" nail (roof)	4	8
	1 ³ / ₄ " 16 gage staple, ⁷ / ₁₆ " crown (roof)	3	6
31. $\frac{19}{32}'' - \frac{3}{4}''$	8d common (2 ¹ / ₂ " × 0.131"); or 6d deformed (2" × 0.113") (subfloor and wall)	6	12
	8d common or deformed (2 ¹ / ₂ " × 0.131") or RSRs-01 (2 ³ / ₈ " × 0.113") nail (roof) ^d	6	12
	2 ³ / ₈ " × 0.113" nail; or 2" 16 gage staple, ⁷ / ₁₆ " crown	4	8
32. $\frac{7}{8}'' - 1\frac{1}{4}''$	10d common (3" × 0.148"); or 8d deformed (2 ¹ / ₂ " × 0.131")	6	12
Other exterior wall sheathing			
33. $\frac{1}{2}''$ fiberboard sheathing ^b	1 ¹ / ₂ " galvanized roofing nail (⁷ / ₁₆ " head diameter); or 1 ¹ / ₄ " 16 gage staple with ⁷ / ₁₆ " or 1" crown	3	6
34. $\frac{25}{32}''$ fiberboard sheathing ^b	1 ³ / ₄ " galvanized roofing nail (⁷ / ₁₆ " diameter head); or 1 ¹ / ₂ " 16 gage staple with ⁷ / ₁₆ " or 1" crown	3	6
Wood structural panels, combination subfloor underlayment to framing			
35. $\frac{3}{4}''$ and less	8d common (2 ¹ / ₂ " × 0.131"); or 6d deformed (2" × 0.113")	6	12
36. $\frac{7}{8}'' - 1''$	8d common (2 ¹ / ₂ " × 0.131"); or 8d deformed (2 ¹ / ₂ " × 0.131")	6	12
37. $1\frac{1}{8}'' - 1\frac{1}{4}''$	10d common (3" × 0.148"); or 8d deformed (2 ¹ / ₂ " × 0.131")	6	12
Panel siding to framing			
38. $\frac{1}{2}''$ or less	6d corrosion-resistant siding (1 ⁷ / ₈ " × 0.106"); or 6d corrosion-resistant casing (2" × 0.099")	6	12
39. $\frac{5}{8}''$	8d corrosion-resistant siding (2 ³ / ₈ " × 0.128"); or 8d corrosion-resistant casing (2 ¹ / ₂ " × 0.113")	6	12
Interior paneling			

**TABLE 2304.10.1
FASTENING SCHEDULE**

<u>DESCRIPTION OF BUILDING ELEMENTS</u>	<u>NUMBER AND TYPE OF FASTENER</u>		<u>SPACING AND LOCATION</u>
40. $\frac{1}{4}$ "	4d casing ($1\frac{1}{2}$ " \times 0.080"); or 4d finish ($1\frac{1}{2}$ " \times 0.072")	6	12
41. $\frac{3}{8}$ "	6d casing (2" \times 0.099"); or 6d finish (Panel supports at 24 inches)	6	12

For SI: 1 inch = 25.4 mm.

- a. Nails spaced at 6 inches at intermediate supports where spans are 48 inches or more. For nailing of wood structural panel and particleboard diaphragms and shear walls, refer to Section 2305. Nails for wall sheathing are permitted to be common, box or casing.
- b. Spacing shall be 6 inches on center on the edges and 12 inches on center at intermediate supports for nonstructural applications. Panel supports at 16 inches (20 inches if strength axis in the long direction of the panel, unless otherwise marked).
- c. Where a rafter is fastened to an adjacent parallel ceiling joist in accordance with this schedule and the ceiling joist is fastened to the top plate in accordance with this schedule, the number of toenails in the rafter shall be permitted to be reduced by one nail.
- d. RSRS-01 is a Roof Sheathing Ring Shank nail meeting the specifications of ATSM F1667.

[2304.9.2] 2304.10.2 Sheathing fasteners. Sheathing nails or other approved sheathing connectors shall be driven so that their head or crown is flush with the surface of the sheathing.

[2304.9.3] 2304.10.3 Joist hangers and framing anchors. Connections depending on joist hangers or framing anchors, ties and other mechanical fastenings not otherwise covered are permitted where approved. The vertical load-bearing capacity, torsional moment capacity and deflection characteristics of joist hangers shall be determined in accordance with ~~[Section 1716.1]~~ ASTM D7147.

[2304.9.4] 2304.10.4 Other fasteners. Clips, staples, glues and other approved methods of fastening are permitted where approved.

[2304.9.5] 2304.10.5 Fasteners and connectors in contact with preservative-treated and fire-retardant-treated wood. Fasteners, including nuts and washers, and connectors in contact with preservative-treated and fire-retardant-treated wood shall be in accordance with Sections ~~[2304.9.5.1]~~ 2304.10.5.1 through ~~[2304.9.5.4]~~ 2304.10.5.4. The coating weights for zinc-coated fasteners shall be in accordance with ASTM A153. Stainless steel driven fasteners shall be in accordance with the material requirements of ASTM F1667.

[2304.9.5.1] 2304.10.5.1 Fasteners and connectors for preservative-treated wood. Fasteners, including nuts and washers, in contact with preservative-treated wood shall be of hot-dipped zinc-coated galvanized steel, stainless steel, silicon bronze or copper. Staples shall be of stainless steel. Fasteners other than nails, staples, timber rivets, wood screws and lag screws shall be permitted to be of mechanically deposited zinc-coated steel with coating weights in accordance with ASTM B695, Class 55 minimum. Connectors that are used in exterior applications and in contact with preservative-treated wood shall have coating types and weights in accordance with the treated wood or connector manufacturer's recommendations. In the absence of manufacturer's recommendations, a minimum of ASTM A653, ~~[type]~~ Type G185 zinc-coated galvanized steel, or equivalent, shall be used.

Exception: Plain carbon steel fasteners, including nuts and washers, in SBX/DOT and zinc borate preservative-treated wood in an interior, dry environment shall be permitted.

[2304.9.5.2] 2304.10.5.2 Fastenings for wood foundations. Fastenings, including nuts and washers, for wood foundations shall be as required in ~~[AF&PA PWF]~~ AWC PWF.

[2304.9.5.3] 2304.10.5.3 Fasteners for fire-retardant-treated wood used in exterior applications or wet or damp locations. Fasteners, including nuts and washers, for fire-retardant-treated wood used in exterior applications or wet or damp locations shall be of hot-dipped zinc-coated galvanized steel, stainless steel, silicon bronze or copper. Staples shall be of stainless steel. Fasteners other than nails, staples, timber rivets, wood screws and lag screws shall be permitted to be of mechanically deposited zinc-coated steel with coating weights in accordance with ASTM B695, Class 55 minimum.

[2304.9.5.4] 2304.10.5.4 Fasteners for fire-retardant-treated wood used in interior applications. Fasteners, including nuts and washers, for fire-retardant-treated wood used in interior locations shall be in accordance with the manufacturer's recommendations. In the absence of manufacturer's recommendations, Section [2304.9.5.3] 2304.10.5.3 shall apply.

[2304.9.6] 2304.10.6 Load path. Where wall framing members are not continuous from the foundation sill to the roof, the members shall be secured to ensure a continuous load path. Where required, sheet metal clamps, ties or clips shall be formed of galvanized steel or other approved corrosion-resistant material not less than ~~[0.040-inch (1.01mm) nominal]~~ 0.0329-inch (0.836 mm) base metal thickness.

[2304.9.7] 2304.10.7 Framing requirements. Wood columns and posts shall be framed to provide full end bearing. Alternatively, column-and-post end connections shall be designed to resist the full compressive loads, neglecting end-bearing capacity. Column-and-post end connections shall be fastened to resist lateral and net induced uplift forces.

2304.10.8 Connection fire resistance rating. Wood structural connections, including connectors, fasteners, and portions of wood members included in the connection design, shall be protected from fire exposure for the required fire resistance time. For connections in Type IV construction, the required fire resistance time shall be at minimum one hour or as required for the building element by Table 601 and Section 602.4. Fire resistance ratings for connections shall be determined by one of the following:

1. Testing in accordance with Section 703.2 where the connection is part of the fire resistance test.
2. Engineering analysis that demonstrates that the temperature rise at any portion of the connection is limited to an average temperature rise of 250°F (139°C), and a maximum temperature rise of 325°F (181°C), for a time corresponding to the required fire resistance rating of the structural element being connected. For the purposes of this analysis, the connection includes connectors, fasteners, and portions of wood members included in the structural design of the connection.

[2304.10] 2304.11 Heavy timber construction. Where a structure, portion thereof or individual structural elements are required by other provisions of this code to be of heavy timber, the building elements therein shall comply with the applicable provisions of Sections 2304.11.1 through 2304.11.4. Minimum dimensions of heavy timber shall comply with the applicable requirements in Table 2304.11 based on roofs or floors supported and the configuration of each structural element, or the applicable requirements in Sections 2304.11.2 through 2304.11.4. Lumber decking shall be in accordance with Section 2304.9.

**TABLE 2304.11
MINIMUM DIMENSIONS OF HEAVY TIMBER STRUCTURAL MEMBERS**

<u>SUPPORTING</u>	<u>HEAVY TIMBER STRUCTURAL ELEMENTS</u>	<u>MINIMUM NOMINAL SOLID SAWN SIZE</u>		<u>MINIMUM GLUED LAMINATED NET SIZE</u>		<u>MINIMUM STRUCTURAL COMPOSITE LUMBER NET SIZE</u>	
		<u>Width, Inch</u>	<u>Depth, Inch</u>	<u>Width, Inch</u>	<u>Depth, Inch</u>	<u>Width, Inch</u>	<u>Depth, Inch</u>
<u>Floor loads only or combined floor and roof loads</u>	<u>Columns; Framed sawn or glued- laminated timber arches that spring from the floor line; Framed timber trusses</u>	<u>8</u>	<u>8</u>	<u>6¾</u>	<u>8¼</u>	<u>7</u>	<u>7½</u>
<u>Roof loads only</u>	<u>Wood beams and girders</u>	<u>6</u>	<u>10</u>	<u>5</u>	<u>10½</u>	<u>5¼</u>	<u>9½</u>
	<u>Columns (roof and ceiling loads); Lower half of: wood-frame or glued-laminated arches that spring from the floor line or from grade</u>	<u>6</u>	<u>8</u>	<u>5</u>	<u>8¼</u>	<u>5¼</u>	<u>7½</u>
	<u>Upper half of: wood-frame or glued-laminated arches that spring from the floor line or from grade</u>	<u>6</u>	<u>6</u>	<u>5</u>	<u>6</u>	<u>5¼</u>	<u>5½</u>
	<u>Framed timber trusses and other roof framing^a; Framed or glued- laminated arches that spring from the top of walls or wall abutments</u>	<u>4^b</u>	<u>6</u>	<u>3^b</u>		<u>3½^b</u>	<u>5½</u>

For SI: 1 inch = 25.4 mm.

- a. Spaced members shall be permitted to be composed of two or more pieces not less than 3 inches nominal in thickness where blocked solidly throughout their intervening spaces or where spaces are tightly closed by a continuous wood cover plate of not less than 2 inches nominal in thickness secured to the underside of the members. Splice plates shall be not less than 3 inches nominal in thickness.
- b. Where protected by approved automatic sprinklers under the roof deck, framing members shall be not less than 3 inches nominal in width.

[2304.10.1 Minimum member sizes.]

[2304.10.1.1 Columns. Columns shall be at least 8 inches (203 mm) in all dimensions when supporting floor loads and at least 6 inches (152 mm) wide and 8 inches (203 mm) deep when supporting roof and ceiling loads only.]

[2304.10.1.2 Beams and girders. Beams and girders shall be at least 6 inches (152 mm) wide and 10 inches (254 mm) deep.]

[2304.10.1.3 Frames and arches. Frames and arches that spring from grade or the floor line and support floor loads shall be at least 8 inches (203 mm) in all dimensions. Frames or arches for roof construction that spring from grade or the floor line and do not support floor loads shall have members at least 6 inches (152 mm) wide and 8 inches (203 mm) deep for the lower half of the height, and at least 6 inches (152 mm) deep for the upper half. Frames or arches for roof construction that spring from the top of walls or wall abutments, framed

timber trusses, and other roof framing, which do not support floor loads, shall have members at least 4 inches (102 mm) wide and 6 inches (152 mm) deep. Spaced members may be composed of two or more pieces at least 3 inches (76 mm) thick when blocked solidly through their intervening spaces or when such spaces are tightly closed by a continuous wood cover plate at least 2 inches (51 mm) thick secured to the underside of the members. Splice plates shall be at least 3 inches (76 mm) thick. When protected by approved automatic sprinklers under the roof deck, framing members shall be at least 3 inches (76 mm) wide.]

[2304.10.1.4 Trusses. Timber trusses supporting floor loads shall have members at least 8 inches (203 mm) in all dimensions.]

[2304.10.2 Columns. Columns shall be continuous or superimposed throughout all stories by means of reinforced concrete or metal caps with brackets, or shall be connected by properly designed steel or iron caps, with pintles and base plates, or by timber splice plates affixed to the columns by metal connectors housed within the contact faces, or by other approved methods.]

[2304.10.2.1 Column connections. Girders and beams shall be closely fitted around columns and adjoining ends shall be cross tied to each other, or intertied by caps or ties, to transfer horizontal loads across joints. Wood bolsters shall not be placed on tops of columns unless the columns support roof loads only.]

[2304.10.3 Floor framing. Approved wall plate boxes or hangers shall be provided where wood beams, girders or trusses rest on masonry or concrete walls. Where intermediate beams are used to support a floor, they shall rest on top of girders, or shall be supported by ledgers or blocks securely fastened to the sides of the girders, or they shall be supported by an approved metal hanger into which the ends of the beams shall be closely fitted.]

[2304.10.4 Roof framing. Every roof girder and at least every alternate roof beam shall be anchored to its supporting member; and every monitor and every sawtooth construction shall be anchored to the main roof construction. Such anchors shall consist of steel bolts of sufficient strength to resist vertical uplift of the roof.]

[2304.10.5 Floor decks. Floor decks and covering shall not extend closer than $^{+}/_{2}$ -inch (12.7 mm) to walls. Such $^{+}/_{2}$ -inch (12.7 mm) spaces shall be covered by a molding fastened to the wall either above or below the floor and arranged such that the molding will not obstruct the expansion or contraction movements of the floor. Corbeling of masonry walls under floors is permitted in place of such molding.]

[2304.10.6 Roof decks. Where supported by a wall, roof decks shall be anchored to walls to resist uplift forces determined in accordance with Chapter 16. Such anchors shall consist of steel bolts of sufficient strength to resist vertical uplift of the roof.]

[2304.10.7 Fabrication. All timber shall be accurately cut and framed to a close fit in such a manner that the joints will have even bearing over the contact surfaces. Mortises shall be true to size for their full depth and tenons shall fit snugly. No shimming in joints, or open joints, shall be permitted.]

~~[**2304.10.8 Erection.** Joints shall have a tight fit. Fasteners shall be installed in a manner that will not damage the wood. End compression joints shall be brought to full bearing. All framework shall be carried up true and plumb. As erection progresses, the work shall be bolted, or nailed as necessary, to resist all dead load, wind, and erection stresses. The structure shall be properly aligned before final tightening of the connections.]~~

2304.11.1 Details of heavy timber structural members. Heavy timber structural members shall be detailed and constructed in accordance with Sections 2304.11.1 through 2304.11.1.4.

2304.11.1.1 Columns. Minimum dimensions of columns shall be in accordance with Table 2304.11. Columns shall be continuous or superimposed throughout all stories and connected in an approved manner. Girders and beams at column connections shall be closely fitted around columns and adjoining ends shall be cross tied to each other, or intertied by caps or ties, to transfer horizontal loads across joints. Wood bolsters shall not be placed on tops of columns unless the columns support roof loads only. Where traditional heavy timber detailing is used, connections shall be by means of reinforced concrete or metal caps with brackets, by properly designed steel or iron caps, with pintles and base plates, by timber splice plates affixed to the columns by metal connectors housed within the contact faces, or by other approved methods.

2304.11.1.2 Floor framing. Minimum dimensions of floor framing shall be in accordance with Table 2304.11. Approved wall plate boxes or hangers shall be provided where wood beams, girders or trusses rest on masonry or concrete walls. Where intermediate beams are used to support a floor, they shall rest on top of girders, or shall be supported by an approved metal hanger into which the ends of the beams shall be closely fitted. Where traditional heavy timber detailing is used, these connections shall be permitted to be supported by ledgers or blocks securely fastened to the sides of the girders.

2304.11.1.3 Roof framing. Minimum dimensions of roof framing shall be in accordance with Table 2304.11. Every roof girder and not less than every alternate roof beam shall be anchored to its supporting member to resist forces as required in Chapter 16.

2304.11.1.4 Cross-laminated timber. Cross-laminated timber shall be used only when engineered by a registered design professional. The design shall take into account the effects of openings cut into the panels. Cross-laminated timber shall not be used as individual columns or beams.

2304.11.2 Partitions and walls. Partitions and walls shall comply with Section 2304.11.2.1 or 2304.11.2.2.

2304.11.2.1 Exterior walls. Exterior walls shall be of noncombustible materials or other materials as permitted by Section 602.4.

2304.11.2.2 Interior walls and partitions. Interior walls and partitions shall be of solid wood construction formed by not less than two layers of 1-inch (25 mm) matched boards or laminated construction 4 inches (102 mm) thick, or of 1-hour fire-resistance-rated construction.

2304.11.3 Floors. Floors shall be without concealed spaces. Wood floors shall be constructed in accordance with Section 2304.11.3.1 or 2304.11.3.2.

2304.11.3.1 Cross-laminated timber floors. Cross-laminated timber shall be not less than 4 inches (102 mm) in actual thickness. Cross-laminated timber shall be continuous from support to support and mechanically fastened to one another. Cross-laminated timber shall be permitted to be connected to walls without a shrinkage gap providing swelling or shrinking is considered in the design. Corbelling of masonry walls under the floor shall be permitted to be used.

2304.11.3.2 Sawn or glued-laminated plank floors. Sawn or glued-laminated plank floors shall be one of the following:

1. Sawn or glued-laminated planks, splined or tongue-and-groove, of not less than 3 inches (76 mm) nominal in thickness covered with 1-inch (25 mm) nominal dimension tongue-and-groove flooring, laid crosswise or diagonally, ¹⁵/₃₂-inch (12 mm) wood structural panel or ½-inch (12.7 mm) particleboard.
2. Planks not less than 4 inches (102 mm) nominal in width set on edge close together and well spiked and covered with 1-inch (25 mm) nominal dimension flooring or ¹⁵/₃₂-inch (12 mm) wood structural panel or ½-inch (12.7 mm) particleboard.

The lumber shall be laid so that continuous lines of joints will occur only at points of support. Floors shall not extend closer than ½ inch (12.7 mm) to walls. Such ½-inch (12.7 mm) space shall be covered by a molding fastened to the wall and so arranged that it will not obstruct the swelling or shrinkage movements of the floor. Corbelling of masonry walls under the floor shall be permitted to be used in place of molding.

2304.11.4 Roof decks. Roofs shall be without concealed spaces and roof decks shall be constructed in accordance with Section 2304.11.4.1 or 2304.11.4.2. Other types of decking shall be an alternative that provides equivalent fire resistance and structural properties. Where supported by a wall, roof decks shall be anchored to walls to resist forces determined in accordance with Chapter 16. Such anchors shall consist of steel bolts, lags, screws or approved hardware of sufficient strength to resist prescribed forces.

2304.11.4.1 Cross-laminated timber roofs. Cross-laminated timber roofs shall be not less than 3 inches (76 mm) nominal in thickness and shall be continuous from support to support and mechanically fastened to one another.

2304.11.4.2 Sawn, wood structural panel, or glued-laminated plank roofs. Sawn, wood structural panel, or glued-laminated plank roofs shall be one of the following:

1. Sawn or glued laminated, splined or tongue-and-groove plank, not less than 2 inches (51 mm) nominal in thickness.
2. 1½-inch-thick (32 mm) wood structural panel (exterior glue).

3. Planks not less than 3 inches (76 mm) nominal in width, set on edge close together and laid as required for floors.

[2304.11] 2304.12 Protection against decay and termites. Wood shall be protected from decay and termites in accordance with the applicable provisions of Sections 2304.12.1 through 2304.12.8.

~~[2304.11.1 General. Where required by this section, protection from decay and termites shall be provided by the use of naturally durable or preservative-treated wood.]~~

~~[2304.11.2 Wood used above ground]~~ **2304.12.1 Locations requiring water-borne preservatives or naturally durable wood.** Wood used above ground in the locations specified in Sections ~~[2304.11.2.1]~~ 2304.12.1.1 through ~~[2304.11.2.7]~~ 2304.12.1.5, ~~[2304.11.3]~~ 2304.12.3 and ~~[2304.11.5]~~ 2304.12.5 shall be naturally durable wood or preservative-treated wood using water-borne preservatives, in accordance with AWPA U1 [~~Commodity Specifications A or F~~] for above-ground use.

~~[304.11.2.1]~~ **2304.12.1.1 Joists, girders and subfloor.** ~~[Where wood]~~ Wood joists or ~~[the bottom of a]~~ wood structural ~~[floor without joists]~~ floors that are closer than 18 inches (457 mm)~~;~~ or wood girders that are closer than 12 inches (305 mm) to the exposed ground in crawl spaces or unexcavated areas located within the perimeter of the building foundation~~;~~ ~~the floor construction (including posts, girders, joists and subfloor)]~~ shall be of naturally durable or preservative-treated wood.

~~[2304.11.2.2]~~ **2304.12.1.2 Wood supported by exterior foundation walls.** Wood framing members, including wood sheathing, that ~~rest on~~ are in contact with exterior foundation walls and are less than 8 inches (203 mm) from exposed earth shall be of naturally durable or preservative-treated wood.

~~[2304.11.2.3]~~ **2304.12.1.3 Exterior walls below grade.** Wood framing members and furring strips ~~attached directly to~~ in direct contact with the interior of exterior masonry or concrete walls below grade shall be of ~~approved~~ naturally durable or preservative-treated wood.

~~[2304.11.2.4]~~ **2304.12.1.4 Sleepers and sills.** Sleepers and sills on a concrete or masonry slab that is in direct contact with earth shall be of naturally durable or preservative-treated wood.

~~[2304.11.2.5 Girder ends. The ends of wood girders entering exterior masonry or concrete walls shall be provided with a 1/2-inch (12.7 mm) air space on top, sides and end, unless naturally durable or preservative-treated wood is used.]~~

~~[2304.11.2.6]~~ **2304.12.1.5 Wood siding.** Clearance between wood siding and earth on the exterior of a building shall not be less than 8 inches (203 mm) or less than 2 inches (51 mm) vertical from covered concrete steps, porch slabs, patio slabs and similar horizontal surfaces exposed to the weather except where siding, sheathing and wall framing are of naturally durable or preservative-treated wood.

2304.12.2 Other locations. Wood used in the locations specified in Sections 2304.12.2.1 through 2304.12.2.5 shall be naturally durable wood or preservative-treated wood in accordance with AWPA U1. Preservative-treated wood used in interior locations shall be protected with two coats

of urethane, shellac, latex epoxy or varnish unless water-borne preservatives are used. Prior to application of the protective finish, the wood shall be dried in accordance with the manufacturer's recommendations.

2304.12.2.1 Girder ends. The ends of wood girders entering exterior masonry or concrete walls shall be provided with a ½-inch (12.7 mm) airspace on top, sides and end, unless naturally durable or preservative-treated wood is used.

~~[2304.11.2.7]~~ **2304.12.2.2 Posts or columns.** Posts or columns supporting permanent structures and supported by a concrete or masonry slab or footing that is in direct contact with the earth shall be of naturally durable or preservative-treated wood.

[Exceptions]

- ~~[1. Posts or columns that are either exposed to the weather or located in basements or cellars, supported by concrete piers or metal pedestals projected at least 1 inch (25 mm) above the slab or deck and 6 inches (152 mm) above exposed earth, and are separated therefrom by an impervious moisture barrier.]~~
- ~~[2. Posts or columns in enclosed crawl spaces or unexcavated areas located within the periphery of the building, supported by a concrete pier or metal pedestal at a height greater than 8 inches (203 mm) from exposed ground, and are separated there from by an impervious moisture barrier.]~~

Exception: Posts or columns that meet all of the following:

1. Are not exposed to the weather, or are protected by a roof, eave, overhang, or other covering if exposed to the weather.
2. Are supported by concrete piers or metal pedestals projected not less than 1 inch (25 mm) above the slab or deck and are separated from the concrete pier by an impervious moisture barrier.
3. Are located not less than 8 inches (203 mm) above exposed earth.

~~[2304.11.3 Laminated timbers. The portions of glued-laminated timbers that form the structural supports of a building or other structure and are exposed to weather and not fully protected from moisture by a roof, eave or similar covering shall be pressure treated with preservative or be manufactured from naturally durable or preservative-treated wood.]~~

~~[2304.11.4 Wood in contact with the ground or fresh water. Wood used in contact with the ground (exposed earth) in the locations specified in Sections 2304.11.4.1 and 2304.11.4.2 shall be naturally durable (species for both decay and termite resistance) or preservative-treated using water-borne preservatives in accordance with AWWA U1 (Commodity Specifications A or F) for soil or fresh water use.]~~

~~[Exception: Untreated wood is permitted where such wood is continuously and entirely below the groundwater level or submerged in fresh water.]~~

~~[2304.11.4.1 Posts or columns. Posts and columns supporting permanent structures that are embedded in concrete that is in direct contact with the earth, embedded in concrete that is exposed to the weather or in direct contact with the earth shall be of preservative treated wood.]~~

~~[2304.11.4.2 Wood structural members. Wood structural members that support moisture-permeable floors or roofs that are exposed to the weather, such as concrete or masonry slabs, shall be of naturally durable or preservative treated wood unless separated from such floors or roofs by an impervious moisture barrier.]~~

~~[2304.11.5]~~ **2304.12.2.3 Supporting member for permanent appurtenances.** Naturally durable or preservative-treated wood shall be utilized for those portions of wood members that form the structural supports of buildings, balconies, porches or similar permanent building appurtenances where such members are exposed to the weather without adequate protection from a roof, eave, overhang or other covering to prevent moisture or water accumulation on the surface or at joints between members.

2304.12.2.4 Laminated timbers. The portions of glued-laminated timbers that form the structural supports of a building or other structure and are exposed to weather and not fully protected from moisture by a roof, eave or similar covering shall be pressure treated with preservative or be manufactured from naturally durable or preservative-treated wood.

2304.12.2.5 Supporting members for permeable floors and roofs. Wood structural members that support moisture-permeable floors or roofs that are exposed to the weather, such as concrete or masonry slabs, shall be of naturally durable or preservative-treated wood unless separated from such floors or roofs by an impervious moisture barrier. The impervious moisture barrier system protecting the structure supporting floors shall provide positive drainage of water that infiltrates the moisture-permeable floor topping.

2304.12.2.6 Ventilation beneath balcony or elevated walking surfaces. Enclosed framing in exterior balconies and elevated walking surfaces that are exposed to rain, snow or drainage from irrigation shall be provided with openings that provide a net free cross-ventilation area not less than 1/150 of the area of each separate space.

2304.12.3 Wood in contact with the ground or fresh water. Wood used in contact with exposed earth shall be naturally durable for both decay and termite resistance or preservative treated in accordance with AWP A U1 for soil or fresh water use.

Exception: Untreated wood is permitted where such wood is continuously and entirely below the ground-water level or submerged in fresh water.

2304.12.3.1 Posts or columns. Posts and columns that are supporting permanent structures and embedded in concrete that is exposed to the weather or in direct contact with the earth shall be of preservative-treated wood.

~~[2304.11.6]~~ **2304.12.4 Termite protection.** In geographical areas where hazard of termite damage is known to be very heavy, wood floor framing in the locations specified in Section 2304.12.1 & 2304.12.2 and exposed framing of exterior decks or balconies shall be of naturally

durable species (termite resistant) or preservative treated in accordance with AWP A U1 for the species, product preservative and end use or provided with approved methods of termite protection.

~~[2304.11.7]~~ **2304.12.5 Wood used in retaining walls and cribs.** Wood installed in retaining or crib walls shall be preservative treated in accordance with AWP A U1 [~~(Commodity Specifications A or F)~~] for soil and fresh water use.

~~[2304.11.8]~~ **2304.12.6 Attic ventilation.** For attic ventilation, see Section 1203.2.

~~[2304.11.9]~~ **2304.12.7 Under-floor ventilation (crawl space).** For under-floor ventilation (crawl space), see Section [~~1203.3~~] 1203.4.

~~[2304.11.10]~~ **Firecutting.** ~~The ends of wood beams, joists and rafters resting on masonry or concrete walls shall be firecut to a level of 3 inches (76 mm) in depth.]~~

~~[2304.11.11]~~ **2304.12.8 Debris.** All loose wood and debris and all wood forms shall be removed from spaces under the building. All stump and roots shall be grubbed to a minimum depth of 12 inches (305 mm).

[2304.12] 2304.13 Long-term loading. Wood members supporting concrete, masonry or similar materials shall be checked for the effects of long-term loading using the provisions of the [~~AF&PA NDS~~] ANSI/AWC NDS. The total deflection, including the effects of long-term loading, shall be limited in accordance with Section 1604.3.1 for these supported materials.

Exception: Horizontal wood members supporting masonry or concrete nonstructural floor or roof surfacing not more than 4 inches (102 mm) thick need not be checked for long-term loading.

SECTION BC 2305 GENERAL DESIGN REQUIREMENTS FOR ~~[LATERAL FORCE-RESISTING]~~ LATERAL FORCE-RESISTING SYSTEMS

2305.1 General. Structures using [~~wood~~] wood-frame shear walls [~~and~~] or wood-frame diaphragms to resist wind, seismic [~~and~~] or other lateral loads shall be designed and constructed in accordance with [~~AF&PA~~] AWC SDPWS and the applicable provisions of Sections 2305, 2306 and 2307.

2305.1.1 Openings in shear panels. Openings in shear panels that materially affect their strength shall be detailed on the plans[~~;~~] and shall have their edges adequately reinforced to transfer all shearing stresses.

2305.2 Diaphragm deflection. The deflection [~~(A)~~] of wood-frame diaphragms shall be determined in accordance with AWC SDPWS. The deflection (Δ_{dia}) of a blocked wood structural panel diaphragm uniformly fastened throughout with staples is permitted to be calculated [~~by using the following equation~~] in accordance with Equation 23-1. If not uniformly fastened, the constant 0.188 (For SI: ¹/₁₆₂₇) in the third term shall be modified [~~accordingly~~] by an approved method.

$$[\Delta = \frac{5vL^3}{8EAb} + \frac{vb}{4Gt} + 0.188Le_{\frac{v}{n}} + \frac{\Sigma(A_e X)}{2b}] \quad \text{(Equation 23-1)}$$

$$[\text{For SI: } \Delta = \frac{0.052vL^2}{EAb} + \frac{vL}{4Gt} + \frac{Le_n}{1627} + \frac{\sum(\Delta_c X)}{2b}]$$

$$\Delta_{dia} = \frac{5vL^3}{8EAW} + \frac{vL}{4Gt} + 0.188Le_n + \frac{\sum(x\Delta_c)}{2W}$$

$$\text{For SI: } \Delta_{dia} = \frac{0.052vL^3}{EAW} + \frac{vL}{4Gt} + \frac{Le_n}{1627} + \frac{\sum(x\Delta_c)}{2W}$$

where:

A = Area of chord cross section, in square inches (mm^2).

~~B = Diaphragm width, in feet (mm).~~

E = ~~[Elastic modulus of]~~ Modulus of elasticity of diaphragm chords, in pounds per square inch (N/mm^2).

e_n = Staple ~~[deformation]~~ slip, in inches (mm)~~[-]~~ ~~[See Table 2305.2(1)]~~ (See Table 2305.2(1)).

Gt = Panel rigidity through the thickness, in pounds per inch (N/mm) of panel width of or depth~~[-]~~ ~~[See Table 2305.2(2)]~~ (See Table 2305.2(2)).

L = Diaphragm length (dimension perpendicular to the direction of the applied load), in feet (mm).

v = ~~[Maximum shear due to design loads in the direction under consideration, in pounds per linear foot (plf) (N/mm)]~~ Induced unit shear in pounds per linear foot (plf)(N/mm).

~~Δ = The calculated deflection, in inches (mm).~~

~~$\sum(\Delta_c X)$ = Sum of individual chord splice slip values on both sides of the diaphragm, each multiplied by its distance to the nearest support.~~

W = Diaphragm width (in the direction of applied force, in feet (mm)).

x = Distance from chord splice to nearest support, in feet (mm).

Δ_c = Diaphragm chord splice slip at the induced unit shear, in inches (mm).

Δ_{dia} = Maximum mid-span diaphragm deflection determined by elastic analysis, in inches (mm).

TABLE 2305.2(1)
 e_n VALUES (inches) FOR USE IN CALCULATING DIAPHRAGM
 AND SHEAR WALL DEFLECTION DUE TO FASTENER SLIP
 (Structural I)^{a,c}

LOAD PER FASTENER ^b (pounds)	FASTENER DESIGNATIONS
	14-Ga staple × 2 inches long
60	0.011

TABLE 2305.2(1)
 e_n VALUES (inches) FOR USE IN CALCULATING DIAPHRAGM
AND SHEAR WALL DEFLECTION DUE TO FASTENER SLIP
(Structural I)^{a,c}

LOAD PER FASTENER ^b (pounds)	FASTENER DESIGNATIONS
	14-Ga staple × 2 inches long
80	0.018
100	0.028
120	0.04
140	0.053
160	0.068

For SI: 1 inch = 25.4 mm, 1 foot = 304.8 mm, 1 pound = 4.448 N.

- a. Increase e_n values 20 percent for plywood grades other than Structural I.
- b. Load per fastener = maximum shear per foot divided by the number of fasteners per foot at interior panel edges.
- c. Decrease e_n values 50 percent for seasoned lumber (moisture content < 19 percent).

TABLE 2305.2(2)
VALUES OF G_t FOR USE IN CALCULATING DEFLECTION OF WOOD STRUCTURAL PANEL SHEAR WALLS AND
DIAPHRAGMS

PANEL TYPE	SPAN RATING	VALUES OF G_t (lb/in. panel depth or width)							
		[OTHER] Structural Sheathing				[STRUCTURAL] Structural I			
		plywood				plywood			
		3-ply [Plywood]	4-ply [Plywood]	5-ply [Plywood] ^a	OSB	3-ply [Plywood]	4-ply [Plywood]	5-ply [Plywood] ^a	OSB
Sheathing	24/0	25,000	32,500	37,500	77,500	32,500	42,500	41,500	77,500
	24/16	27,000	35,000	40,500	83,500	35,000	45,500	44,500	83,500
	32/16	27,000	35,000	40,500	83,500	35,000	45,500	44,500	83,500
	40/20	28,500	37,000	43,000	88,500	37,000	48,000	47,500	88,500
	48/24	31,000	40,500	46,500	96,000	40,500	52,500	51,000	96,000
Single Floor	16 o.c.	27,000	35,000	40,500	83,500	35,000	45,500	44,500	83,500
	20 o.c.	28,000	36,500	42,000	87,000	36,500	47,500	46,000	87,000
	24 o.c.	30,000	39,000	45,000	93,000	39,000	50,500	49,500	93,000
	32 o.c.	36,000	47,000	54,000	110,000	47,000	61,000	59,500	110,000
	48 o.c.	50,500	65,500	76,000	155,000	65,500	85,000	83,500	155,000

	Thickness (in.)	[OTHER] Structural Sheathing			[STRUCTURAL] Structural I		
		A-A, A-C	Marine	All Other Grades	A-A, A-C	Marine	All Other Grades
Sanded Plywood	1/4	24,000	31,000	24,000	31,000	31,000	31,000
	1 1/32	25,500	33,000	25,500	33,000	33,000	33,000
	3/8	26,000	34,000	26,000	34,000	34,000	34,000
	15/32	38,000	49,500	38,000	49,500	49,500	49,500
	1/2	38,500	50,000	38,500	50,000	50,000	50,000
	19/32	49,000	63,500	49,000	63,500	63,500	63,500
	5/8	49,500	64,500	49,500	64,500	64,500	64,500
	23/32	50,500	65,500	50,500	65,500	65,500	65,500
	3/4	51,000	66,500	51,000	66,500	66,500	66,500
	7/8	52,500	68,500	52,500	68,500	68,500	68,500
	1	73,500	95,500	73,500	95,500	95,500	95,500
1 1/8	75,000	97,500	75,000	97,500	97,500	97,500	

For SI: 1 inch = 25.4 mm, 1 pound per inch = 0.1751 N/mm.

- a. 5-ply [Applies] applies to plywood with five or more layers; for five-ply [three-layer] plywood with three layers, use values for four ply.

2305.3 Shear wall deflection. The deflection [~~(A)~~] of wood-frame shear walls shall be determined in accordance with AWC SDPWS. The deflection (Δ_{sw}) of a blocked wood structural panel shear wall uniformly fastened throughout with staples is permitted to be calculated [~~by the use of the following equation:~~] in accordance with Equation 23-2.

$$[\Delta = \frac{8vh^3}{EAb} + \frac{vh}{Gt} + 0.75he_n + d_a \frac{h}{b}] \quad \text{(Equation 23-2)}$$

$$[\text{For SI: } \Delta = \frac{vh^3}{3EAb} + \frac{vh}{Gt} + \frac{he_n}{407.6} + d_a \frac{h}{b}]$$

$$\Delta_{sw} = \frac{8vh^3}{EAb} + \frac{vh}{4Gt} + 0.75he_n + \frac{d_a h}{b}$$

$$\text{For SI: } \frac{vh^3}{3EAb} + \frac{vh}{Gt} + \frac{he_n}{407.6} + \frac{d_a h}{b}$$

where:

A = Area of [~~boundary element~~] end-post cross section in square inches (mm^2) [~~(vertical member at shear wall boundary)~~].

b = [~~Wall width~~] Shear wall length, in feet (mm).

d_a = [~~Vertical~~] Total vertical elongation of [overturning] wall anchorage system (including fastener slip, device elongation, [~~etc.~~] rod elongation) at the [~~design shear load~~] induced unit shear in the shear wall (v).

E = [~~Elastic modulus of boundary element (vertical member at shear wall boundary)~~] Modulus of elasticity of end posts, in pounds per square inch (N/mm^2).

e_n = Staple [~~deformation~~] slip, in inches (mm) [~~]~~] [~~See Table 2305.2(1)~~] (See Table 2305.2(1)).

Gt = Panel rigidity through the thickness, in pounds per inch (N/mm) of panel width [~~or~~] or depth [~~]~~] [~~See Table 2305.2(2)~~] (See Table 2305.2(2)).

h = [~~Wall~~] Shear wall height, in feet (mm).

v = [~~Maximum shear due to design loads at the top of the wall~~] Induced unit shear, in pounds per linear foot (plf) (N/mm).

[~~A~~]

Δ_{sw} = [~~The calculated deflection~~] Maximum shear wall deflection determined by elastic analysis, in inches (mm).

**SECTION BC 2306
ALLOWABLE STRESS DESIGN**

2306.1 Allowable stress design. The ~~[structural analysis]~~ design and construction of wood elements in structures using allowable stress design shall be in accordance with the following applicable standards:

American ~~[Forest & Paper Association]~~ Wood Council.

ANSI/AWC NDS National Design Specification for Wood Construction

ANSI/AWC SDPWS Special Design Provisions for Wind and Seismic

~~[American Institute of Timber Construction.]~~

~~[AITC 104 ——— Typical Construction Details]~~

~~[AITC 110 ——— Standard Appearance Grades for Structural Glued Laminated Timber]~~

~~[AITC 113 ——— Standard for Dimensions of Structural Glued Laminated Timber]~~

~~[AITC 117 ——— Standard Specifications for Structural Glued Laminated Timber of Softwood Species]~~

~~[AITC 119 ——— Standard Specifications for Structural Glued Laminated Timber of Hardwood Species]~~

~~[ANSI/AITC A190.1 Structural Glued Laminated Timber]~~

~~[AITC 200 ——— Inspection Manual]~~

American Society of Agricultural and Biological Engineers.

ASABE EP ~~[484.2]~~ 484.3 Diaphragm Design of Metal-clad, ~~[Post-Frame]~~ Wood-frame Rectangular Buildings

ASABE EP ~~[486.4]~~ 486.2 Shallow Post Foundation Design

ASABE EP 559.1 Design Requirements and Bending Properties for Mechanically Laminated ~~[Columns]~~ Wood Assemblies

APA—The Engineered Wood Association.

ANSI 117 Standard Specifications for Structural Glued Laminated Timber of Softwood Species

ANSI A190.1 Structural Glued Laminated Timber

Panel Design Specification

Plywood Design Specification Supplement 1 - Design & Fabrication of Plywood Curved Panel

Plywood Design Specification Supplement 2 - Design & Fabrication of Glued Plywood-lumber Beams

Plywood Design Specification Supplement 3 - Design & Fabrication of Plywood Stressed-skin Panels

Plywood Design Specification Supplement 4 - Design & Fabrication of Plywood Sandwich Panels

Plywood Design Specification Supplement 5 - Design & Fabrication of All-plywood Beams

[EWS] <u>APA T300</u>	Glulam Connection Details
[EWS] <u>APA S560</u>	Field Notching and Drilling of Glued Laminated Timber Beams
[EWS] <u>APA S475</u>	Glued Laminated Beam Design Tables
[EWS] X450	Glulam in Residential Construction
[EWS] <u>APA X440</u>	Product and Application Guide: Glulam
[EWS] <u>APA R540</u>	Builders Tips: Proper Storage and Handling of Glulam Beams

Truss Plate Institute, Inc.

TPI 1	National Design Standard for Metal Plate Connected Wood Truss Construction
-------	--

West Coast Lumber Inspection Bureau

<u>AITC 104</u>	<u>Typical Construction Details</u>
<u>AITC 110</u>	<u>Standard Appearance Grades for Structural Glued Laminated Timber</u>
<u>AITC 113</u>	<u>Standard for Dimensions of Structural Glued Laminated Timber</u>
<u>AITC 119</u>	<u>Standard Specifications for Structural Glued Laminated Timber of Hardwood Species</u>
<u>AITC 200</u>	<u>Inspection Manual</u>

2306.1.1 Joists and rafters. The design of rafter spans is permitted to be in accordance with the ~~[AF&PA Span Tables for Joists and Rafters]~~ AWC STJR.

2306.1.2 Plank and beam flooring. The design of plank and beam flooring is permitted to be in accordance with the ~~[AF&PA]~~ AWC Wood Construction Data No. 4.

2306.1.3 Treated wood stress adjustments. The allowable unit stresses for preservative-treated wood ~~[need no adjustment]~~ shall be adjusted for treatment~~[, but are subject to other adjustments. The allowable unit stresses for fire-retardant treated wood, including fastener values, shall be developed from an approved method of investigation that considers the effects of anticipated temperature and humidity to which the fire-retardant-treated wood will be subjected, the type of treatment and the redrying process. Other adjustments are applicable except that the impact load duration shall not apply.]~~ in accordance with the ANSI/AWC NDS.

The allowable unit stresses for fire-retardant-treated wood, including fastener values, shall be developed from an approved method of investigation that considers the effects of anticipated temperature and humidity to which the fire-retardant-treated wood will be subjected, the type of treatment and the redrying process. Other adjustments are applicable except that the impact load duration shall not apply.

2306.1.4 Lumber decking. The capacity of lumber decking arranged according to the patterns described in Section [2304.8.2] 2304.9.2 shall be the lesser of the capacities determined for flexure and deflection according to the formulas in Table 2306.1.4.

**TABLE 2306.1.4
ALLOWABLE LOADS FOR LUMBER DECKING**

PATTERN	ALLOWABLE AREA LOAD ^{a,b}	
	Flexure	Deflection
Simple span	$\sigma_b = \frac{8F'_b d^2}{l^2 6}$	$\sigma_\Delta = \frac{384\Delta E' d^3}{5l^4 12}$
Two-span continuous	$\sigma_b = \frac{8F'_b d^2}{l^2 6}$	$\sigma_\Delta = \frac{185\Delta E' d^3}{l^4 12}$
Combination simple- and two-span continuous	$\sigma_b = \frac{8F'_b d^2}{l^2 6}$	$\sigma_\Delta = \frac{131\Delta E' d^3}{l^4 12}$
Cantilevered pieces intermixed	$\sigma_b = \frac{20F'_b d^2}{3l^2 6}$	$\sigma_\Delta = \frac{105\Delta E' d^3}{l^4 12}$
Controlled random layup		
Mechanically laminated decking	$\sigma_b = \frac{20F'_b d^2}{3l^2 6}$	$\sigma_\Delta = \frac{100\Delta E' d^3}{l^4 12}$
2-inch decking	$\sigma_b = \frac{20F'_b d^2}{3l^2 6}$	$\sigma_\Delta = \frac{100\Delta E' d^3}{l^4 12}$
3-inch and 4-inch decking	$\sigma_b = \frac{20F'_b d^2}{3l^2 6}$	$\sigma_\Delta = \frac{116\Delta E' d^3}{l^4 12}$

For SI: 1 inch = 25.4 mm.

- a. σ_b = Allowable total uniform load limited by bending.
 σ_Δ = Allowable total uniform load limited by deflection.
- b. d = Actual decking thickness.
 l = Span of decking.
 F'_b = Allowable bending stress adjusted by applicable factors.
 E' = Modulus of elasticity adjusted by applicable factors.

2306.2 [Wood diaphragms.]

~~[2306.2.1 Wood structural panel]~~ **Wood-frame diaphragms.** ~~[Wood structural panel]~~ Wood-frame diaphragms shall be designed and constructed in accordance with ~~[AF&PA]~~ AWC SDPWS. ~~[Wood structural panel diaphragms]~~ Where panels are ~~[permitted]~~ fastened to ~~[resist horizontal forces using]~~ framing members with staples, requirements and limitations of AWC SDPWS shall be met and the allowable shear ~~[capacities]~~ values set forth in Table ~~[2306.2.1(1)]~~ 2306.2(1) or ~~[2306.2.1(2)]~~ 2306.2(2) shall be permitted. The allowable shear ~~[capacities]~~ values in Tables ~~[2306.2.1(1)]~~ 2306.2(1) and ~~[2306.2.1(2)]~~ 2306.2(2) are permitted to be increased 40 percent for wind design.

TABLE [2306.2.1(1)] 2306.2(1)
ALLOWABLE SHEAR VALUES (POUNDS PER FOOT) FOR WOOD STRUCTURAL PANEL
[DIAPHRAGMS] DIAPHRAGMS UTILIZING STAPLES WITH
FRAMING OF DOUGLAS FIR-LARCH, OR SOUTHERN PINE^a FOR WIND OR SEISMIC LOADING^{(b)(f)}

PANEL GRADE	[COMMON NAIL SIZE OR] STAPLE ^(f) LENGTH AND GAGE ^d	MINIMUM FASTENER PENETRATION IN FRAMING (inches)	MINIMUM NOMINAL PANEL THICKNESS (inch)	MINIMUM NOMINAL WIDTH OF FRAMING MEMBERS AT ADJOINING PANEL EDGES AND BOUNDARIES ^(e) (inches)	BLOCKED DIAPHRAGMS				UNBLOCKED DIAPHRAGMS		
					Fastener spacing (inches) at diaphragm boundaries (all cases) at continuous panel edges parallel to load (Cases 3,4), and at all panel edges (Cases 5,6) ^b				Fasteners spaced 6 ⁽¹⁾ max. at supported edges ^b		
					6	4	2 1/2 ^c	2 ^c	Case 1 (No unblocked edges or continuous joints parallel to load)		All other configurations (Cases 2, 3, 4, 5 and 6)
					Fastener spacing (inches) at other panel edges (Cases 1, 2, 3 and 4) ^b				6	6	
Structural I grades	[8d-(2 1/2" x 0-131") or] [1 1/2-16 Gage] [10d ⁴ -(3" x 0-148") 1 1/2 16 Gage	[1 3/8] [1] [1 1/2] 1	3/8	[2]	[270]	[360]	[530]	[600]	[240]	[180]	
				[3]	[300]	[400]	[600]	[675]	[265]	[200]	
				2	175	235	350	400	155	115	
				3	200	265	395	450	175	130	
			15/32	[2]	[320]	[425]	[640]	[760]	[285]	[215]	
				[3]	[360]	[480]	[720]	[820]	[350]	[240]	
				2	175	235	350	400	155	120	
				3	200	265	395	450	175	130	
Sheathing, single floor and other grades covered in DOC PS 1 and PS 2	[6de-(2" x 0-113") or] [8d-(2 1/2" x 0-131") 1 1/2 16 Gage] [8d-(2 1/2" x 0-131") or] [1 1/2-16 Gage] [10d ⁴ -(3" x 0-148") 1 1/2 16 Gage] [10d ⁴ -(3" x 0-148") or] [1 1/2-16 Gage] [1 3/4-16 Gage]	[1 1/4] [1 3/8] [1] [1 1/2] [1] [1 1/2] 1	3/8	[2]	[185]	[250]	[375]	[420]	[165]	[125]	
				[3]	[210]	[280]	[420]	[475]	[185]	[140]	
				[2]	[240]	[320]	[480]	[545]	[215]	[160]	
				[3]	[270]	[360]	[540]	[610]	[240]	[180]	
			7/16	2	160	210	315	360	140	105	
				3	180	235	355	400	160	120	
				[2]	[255]	[340]	[505]	[575]	[230]	[170]	
				[3]	[185]	[380]	[570]	[645]	[255]	[190]	
			15/32	2	165	225	335	380	150	110	
				3	190	250	375	425	165	125	
				[2]	[270]	[360]	[530]	[600]	[240]	[180]	
				[3]	[300]	[400]	[600]	[675]	[265]	[200]	
			19/32	[2]	[290]	[385]	[575]	[655]	[255]	[190]	
				[3]	[325]	[430]	[650]	[735]	[290]	[215]	
				2	160	210	315	360	140	105	
				3	180	235	355	405	160	120	
				[2]	[320]	[425]	[640]	[730]	[285]	[215]	
				[3]	[360]	[480]	[720]	[820]	[320]	[240]	
				2	175	235	350	400	155	115	
				3	200	265	395	450	175	130	

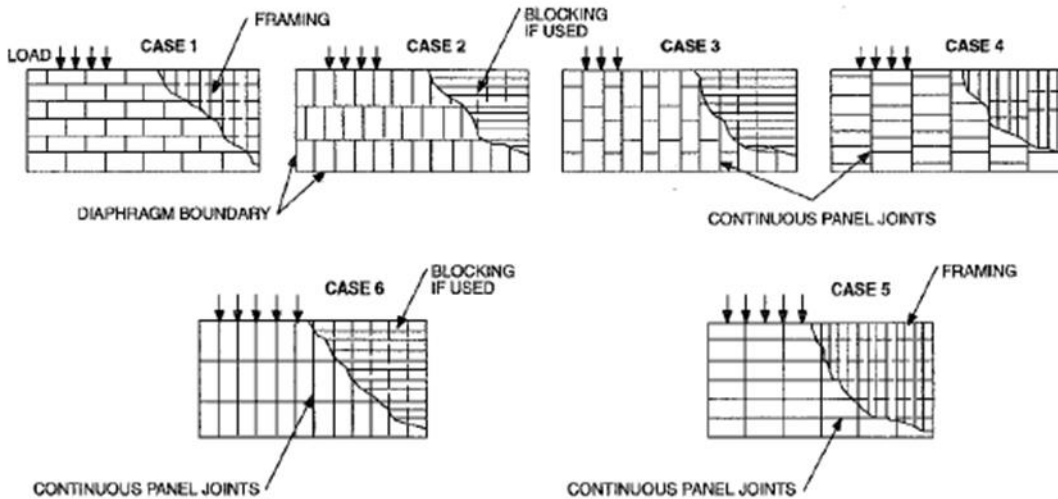

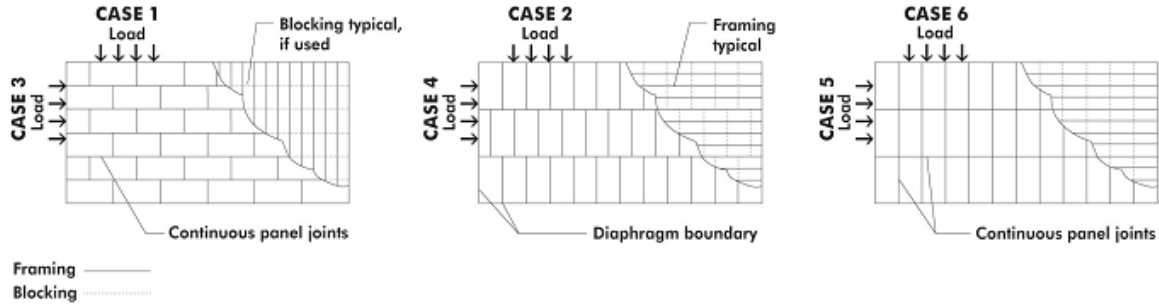

For SI: 1 inch = 25.4 mm, 1 pound per foot = 14.5939 N/m.

- a. For framing of other species: (1) Find specific gravity for species of lumber in [AF&PA NDS] ANSI/AWC NDS. (2) For staples, find shear value from table above for Structural I panels (regardless of actual grade) and multiply value by 0.82 for species with specific gravity of 0.42 or greater, or 0.65 for all other species. [(3) For nails find shear value from table above for nail size for actual grade and multiply value by the following adjustment factor: Specific Gravity Adjustment Factor = (1 - (0.5 - SG)), where SG = Specific Gravity of the framing lumber. This adjustment factor shall not be greater than 1.]
- b. Space fasteners maximum 12 inches [ø-e-] on center along intermediate framing members (6 inches [ø-e-] on center where supports are spaced 48 inches [ø-e-] on center).
- c. Framing at adjoining panel edges shall be 3 inches nominal or wider [-, and nails at all panel edges shall be staggered where panel edge nailing is specified at 2½-inches o.e. or less-].
- [d- Framing at adjoining panel edges shall be 3 inches nominal or wider, and nails at all panel edges shall be staggered where both of the following conditions are met: (1) 10d nails having penetration into framing of more than 1½ inches and (2) panel edge nailing is specified at least 3 inches o.e. or less-].
- [e- 8d is recommended minimum for roofs due to negative pressures of high winds-].
- [f-]d. Staples shall have a minimum crown width of 7/16 inch and shall be installed with their crowns parallel to the long dimension of the framing members.
- [g-]e. The minimum nominal width of framing members not located at boundaries or adjoining panel edges shall be 2 inches.
- [h-]f. For shear loads of normal or permanent load duration as defined by the [AF&PA NDS] ANSI/AWC NDS, the values in the table above shall be multiplied by 0.63 or 0.56, respectively.

TABLE [2306.2.1(2)] 2306.2(2)
ALLOWABLE SHEAR VALUES (POUNDS PER FOOT) FOR WOOD STRUCTURAL PANEL BLOCKED
DIAPHRAGMS UTILIZING MULTIPLE ROWS OF [FASTENERS] STAPLES ([HIGH-LOAD] HIGH-LOAD
DIAPHRAGMS) WITH [FRAMES-OF] FRAMING OF DOUGLAS FIR-LARCH OR SOUTHERN PINE^a FOR WIND OR
SEISMIC LOADING^{b,g,h}

PANEL GRADE ^c	[COMMON NAIL SIZE OR] STAPLE ^[f] GAGE ^f	MINIMUM FASTENER PENETRATION IN FRAMING (inches)	MINIMUM NOMINAL PANEL THICKNESS (inch)	MINIMUM NOMINAL WIDTH OF FRAMING MEMBER AT ADJOINING PANEL EDGES AND BOUNDARIES ^e	LINES OF FASTENERS	BLOCKED DIAPHRAGMS								
						Cases 1 and 2 ^d								
						Fastener Spacing Per Line at Boundaries (inches)								
						4	2½	2						
						Fastener Spacing Per Line at Other Panel Edges (inches)								
						6	4	4	3	3	2			
Structural I grades	[10d common nails] 14 gage staples	[1½] 2	[15/32]	[3]	[2]	[605]	[815]	[875]	[1,150]	[-]	[-]			
				[4]	[2]	[700]	[915]	[1,005]	[1,290]	[-]	[-]			
				[4]	[3]	[875]	[1,220]	[1,285]	[1,395]	[-]	[-]			
			[19/32]	[3]	[2]	[670]	[880]	[965]	[1,255]	[-]	[-]			
				[4]	[2]	[780]	[990]	[1,110]	[1,440]	[-]	[-]			
				[4]	[3]	[965]	[1,320]	[1,405]	[1,790]	[-]	[-]			
			[23/32]	[3]	[2]	[730]	[955]	[1,050]	[1,365]	[-]	[-]			
				[4]	[2]	[855]	[1,070]	[1,210]	[1,565]	[-]	[-]			
				[4]	[3]	[1,050]	[1,430]	[1,525]	[1,800]	[-]	[-]			
			15/32						600	600	860	960	1,060	1,200
									860	900	1,160	1,295	1,295	1,400
									19/32	3	2	600	600	875
4	3	875								900	1,175	1,440	1,475	1,795
[15/32]	[3]	[2]								[525]	[725]	[765]	[1,010]	[-]
	[4]	[2]							[605]	[815]	[875]	[1,105]	[-]	[-]
	[4]	[3]	[765]	[1,085]	[1,130]	[1,195]	[-]	[-]						
[19/32]						[650]	[960]	[935]	[1,225]	[-]	[-]			
						[4]	[2]	[755]	[965]	[1,080]	[1,370]	[-]	[-]	
						[4]	[3]	[935]	[1,290]	[1,365]	[1,485]	[-]	[-]	
						[23/32]	[3]	[2]	[710]	[935]	[1,020]	[1,335]	[-]	[-]
							[4]	[2]	[825]	[1,050]	[1,175]	[1,445]	[-]	[-]
							[4]	[3]	[1,025]	[1,355]	[1,405]	[1,725]	[-]	[-]

TABLE [2306.2.1(2)] 2306.2(2)
ALLOWABLE SHEAR VALUES (POUNDS PER FOOT) FOR WOOD STRUCTURAL PANEL BLOCKED
DIAPHRAGMS UTILIZING MULTIPLE ROWS OF [FASTENERS] STAPLES ([HIGH LOAD] HIGH-LOAD
DIAPHRAGMS) WITH [FRAMES-OF] FRAMING OF DOUGLAS FIR-LARCH OR SOUTHERN PINE^a FOR WIND OR
SEISMIC LOADING^{b,g,h}

PANEL GRADE ^c PS 2	[COMMON NAIL SIZE OR] STAPLE ^f GAGE ^f	MINIMUM FASTENER PENETRATION IN FRAMING (inches)	MINIMUM NOMINAL PANEL THICKNESS (inch)	MINIMUM NOMINAL WIDTH OF FRAMING MEMBER AT ADJOINING PANEL EDGES AND BOUNDARIES ^e	LINES OF FASTENERS	BLOCKED DIAPHRAGMS									
						Cases 1 and 2 ^a									
						Fastener Spacing Per Line at Boundaries (inches)									
						4	2 ^{1/2}	2	Fastener Spacing Per Line at Other Panel Edges (inches)						
6	4	4	3	3	2										
				[4]	[3]	[1,020]	[1,400]	[1,480]	[1,565]	[-]	[-]				
			15/32	3	2	540	540	735	865	915	1,080				
				4	3	735	810	1,005	1,105	1,105	1,195				
			19/32	3	2	600	600	865	960	1,065	1,200				
				4	3	865	900	1,130	1,430	1,370	1,485				
			23/32	4	3	865	900	1,130	1,490	1,430	1,545				

For SI: 1 inch = 25.4 mm, 1 pound per foot = 14.5939 N/m.

- For framing of other species: (1) Find specific gravity for species of framing lumber in [AF&PA-NDS] ANSI/AWC NDS. (2) For staples, find shear value from table above for Structural I panels (regardless of actual grade) and multiply value by 0.82 for species with specific gravity of 0.42 or greater, or 0.65 for all other species. [(3) For nails, find shear value from table above for nail size of actual grade and multiply value by the following adjustment factor: Specific Gravity Adjustment Factor = {1 - (0.5 - SG)}, where SG = Specific gravity of the framing lumber. This adjustment factor shall not be greater than 1.]
- Fastening along intermediate framing members: Space fasteners [a maximum of] not greater than 12 inches on center, except 6 inches on center for spans greater than 32 inches.
- Panels conforming to PS 1 or PS 2.
- This table gives shear values for Cases 1 and 2 as shown in Table [2306.2.1(4)] 2306.2(1). The values shown are applicable to Cases 3, 4, 5 and 6 as shown in Table [2306.2.1(4)] 2306.2(1), providing fasteners at all continuous panel edges are spaced in accordance with the boundary fastener spacing.
- The minimum nominal depth of framing members shall be 3 inches nominal. The minimum nominal width of framing members not located at boundaries or adjoining panel edges shall be 2 inches.
- Staples shall have a minimum crown width of 7/16 inch, and shall be installed with their crowns parallel to the long dimension of the framing members.
- [High load] High-load diaphragms shall be subject to special inspection in accordance with Section [1704.6.1] 1705.5.1.
- For shear loads of normal or permanent load [durations] duration as defined by the [AF&PA-NDS] ANSI/AWC NDS, the values in the table above shall be multiplied by 0.63 or 0.56, respectively.

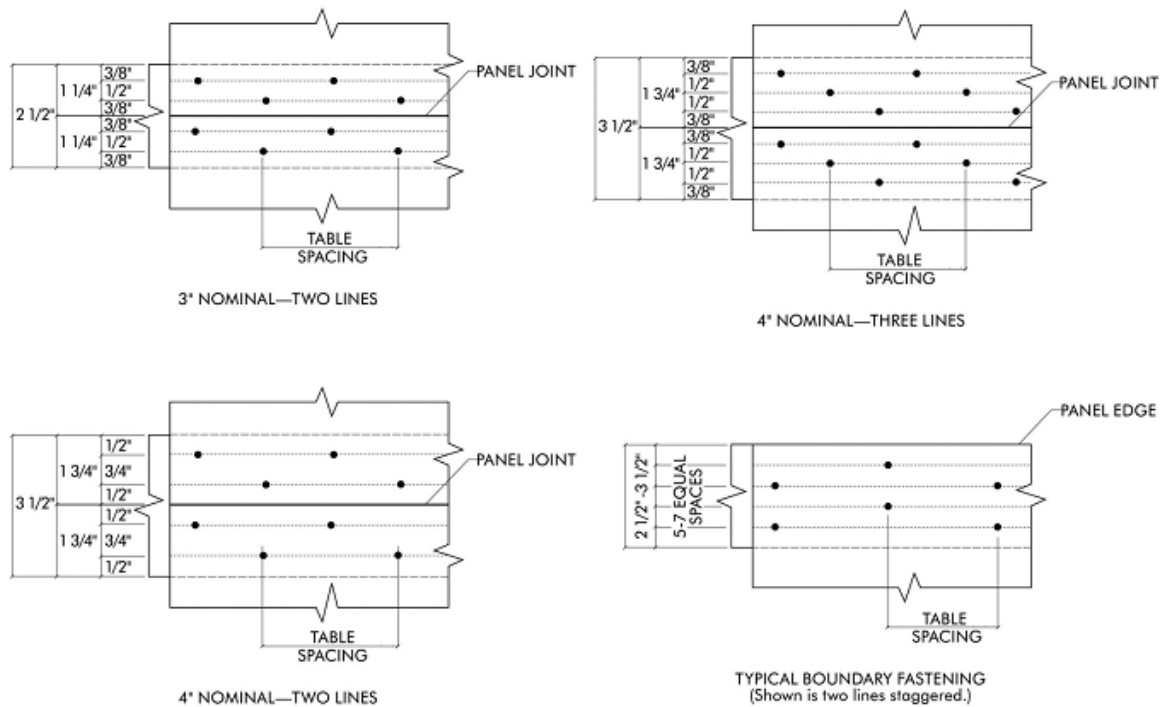

NOTE: SPACE PANEL END AND EDGE JOINT 1/8 INCH. REDUCE SPACING BETWEEN LINES OF NAILS AS NECESSARY TO MAINTAIN MINIMUM 3/8 INCH FASTENER EDGE MARGINS, MINIMUM SPACING BETWEEN LINES IS 3/8 INCH

~~[2306.2.2 Single diagonally sheathed lumber diaphragms. Single diagonally sheathed lumber diaphragms shall be designed and constructed in accordance with AF&PA SDPWS.]~~

~~[2306.2.3 Double diagonally sheathed lumber diaphragms. Double diagonally sheathed lumber diaphragms shall be designed and constructed in accordance with AF&PA SDPWS.]~~

~~[2306.2.4] 2306.2.1 Gypsum board diaphragm ceilings. Gypsum board diaphragm ceilings shall be in accordance with Section 2508.5.~~

2306.3 [Wood structural panel] Wood-frame shear walls. ~~[Wood structural panel] Wood-frame shear walls shall be designed and constructed in accordance with [AF&PA SDPWS] AWC SDPWS. Where panels are fastened to framing members with staples, requirements and limitations of AWC SDPWS[. Wood structural panel shear walls are permitted to resist horizontal forces using the allowable capacities] shall be met and the allowable shear values set forth in Table [2306.3- Allowable capacities in Table 2306.3] 2306.3(1), 2306.3(2) or 2306.3(3) shall be permitted. The allowable shear values in Tables 2306.3(1) and 2306.3(2) are permitted to be increased 40 percent for wind design. Panels complying with ANSI/APA PRP-210 shall be permitted to use design values for Plywood Siding in the AWC SDPWS.~~

TABLE [2306.3] 2306.3(1)
ALLOWABLE SHEAR VALUES (POUNDS PER FOOT) FOR [THE] WOOD STRUCTURAL PANEL SHEAR WALLS UTILIZING STAPLES WITH FRAMING OF DOUGLAS FIR-LARCH OR SOUTHERN PINE^a FOR WIND OR SEISMIC LOADING^{(b),(c),(d),(e),(f),(g),(h),(i),(j),(k),(l)}

PANEL GRADE	MINIMUM NOMINAL PANEL THICKNESS (inch)	MINIMUM FASTENER PENETRATION IN FRAMING (inches)	PANELS APPLIED DIRECT TO FRAMING				PANELS APPLIED OVER 1/2" OR 5/8" GYPSUM SHEATHING						
			[NAIL-(common or galvanized box) or staple size ^(j)] Staple length and gage (inches) ^(h)	Fastener spacing at panel edges (inches)				[NAIL-(common or galvanized box) or staple size ^(j)] Staple length and gage (inches) ^(h)	Fastener spacing at panel edges (inches)				
				6	4	3	2 ^{(e),(l)}		6	4	3	2 ^{(e),(l)}	
Structural I sheathing	3/8 ^{(e),(j)}	1 1/2	[10d (3" x 0.148" common, 3" x 0.128" galvanized box)] 1 1/2 16 Gage	155	235	315	400	[-] 2 16 Gage	155	235	310	400	
	7/16			170	260	345	440			155	235	310	400
	15/32			[340] 185	[540] 280	[665 ^(f)] 375	[870] 475			[-] 155	[-] 235	[-] 300	[-] 400
Sheathing, plywood siding ^{(e),(l)} except Group 5 Species	5/16 ^(e) or 1/4 ^(e)	1	[6d (2" x 0.113" common, 2" x 0.099" galvanized box)] [1 1/2-16 Gage]	[180]	[270]	[350]	[450]	[8d (2 1/2" x 0.131" common, 2 1/2" x 0.113" galvanized box)] [2-16 Gage] [8d (2 1/2" x 0.131" common, 2 1/2" x 0.113" galvanized box)] [2 1/2" x 0.113" galvanized box]	[180]	[270]	[350]	[450]	
	3/8		[145]	220	295	375	[110]		165	220	285		
			[200]	[300]	[390]	[510]	[200]		[300]	[390]	[510]		
			[220 ^(f)]	[320 ^(f)]	[410]	[530 ^(f)]	[260]		[380]	[490 ^(f)]	[640]		
	7/16		[140]	210	280	360	[140]		210	280	360		
			[240 ^(f)]	[350 ^(f)]	[450 ^(f)]	[585 ^(f)]	[260]		[380]	[490 ^(f)]	[640]		
			[155]	230	310	395	[140]		210	280	360		
	15/32		[260]	[380]	[490]	[640]	[260]		[380]	[490]	[640]		
			[340]	[460]	[600]	[770]	[-]		[-]	[-]	[-]		
			[170]	255	335	430	[140]		210	280	360		
			[340]	[510]	[665 ^(f)]	[870]	[-]		[-]	[-]	[-]		
			[185]	280	375	475	-		-	-	-		
			[Nail Size (galvanized casing)]				[Nail Size (galvanized casing)]						
	19/32			[10d (3" x 0.148" common, 3" x 0.128" galvanized box)] 1 3/4 16 Gage	[340]	[510]	[665 ^(f)]		[870]	[-]	[-]	[-]	[-]
				[Nail Size (galvanized casing)]						[Nail Size (galvanized casing)]			
5/16 ^(e)	1 1/4	[6d (2" x 0.099")]	[140]	[210]	[275]	[350]	[8d (2 1/2" x 0.113")]	[140]	[210]	[275]	[360]		
3/8 ^(e)	1 3/8	[8d (2 1/2" x 0.113")]	[160]	[240]	[310]	[410]	[10d (3" x 0.128")]	[160]	[240]	[310]	[410]		

For SI: 1 inch = 25.4 mm, 1 pound per foot = 14.5939 N/m.

- a. For framing of other species: (1) Find specific gravity for species of lumber in [AF&PA-NDS] ANSI/AWC NDS. (2) For staples, find shear value from table above for Structural I panels (regardless of actual grade) and multiply value by 0.82 for species with specific gravity of 0.42 or greater, or 0.65 for all other species. ~~(3) For nails find shear value from table above for nail size for actual grade and multiply value by the following adjustment factor: Specific Gravity-Adjustment Factor: [1 - (0.5 - SG)], where SG = Specific Gravity of the framing lumber. This adjustment factor shall not be greater than 1.~~
- b. Panel edges backed with 2-inch nominal or wider framing. Install panels either horizontally or vertically. Space fasteners maximum 6 inches on center along intermediate framing members for 3/8-inch and 7/16-inch panels installed on studs spaced 24 inches on center. For other conditions and panel thickness, space fasteners maximum 12 inches on center on intermediate supports.
- c. 3/8-inch panel thickness or siding with a span rating of 16 inches on center is the minimum recommended where applied directly to framing as exterior siding. For grooved panel siding, the nominal panel thickness is the thickness of the panel measured at the point of [nailing] fastening.
- [d. Allowable shear values are permitted to be increased to values shown for 15/32-inch sheathing with same nailing provided (a) studs are spaced a maximum of 16 inches on center, or (b) panels are applied with long dimension across studs.]
- [e.].d. Framing at adjoining panel edges shall be 3 inches nominal or wider, and nails at all panel edges shall be staggered where panel edge nailing is specified at 2 inches on center or less.]
- [f. Framing at adjoining panel edges shall be 3 inches nominal or wider, and nails at all panel edges shall be staggered where both of the following conditions are met: (1) 10d (3" x 0.148") nails having penetration into framing of more than 1 1/2 inches and (2) panel edge nailing is specified at 2 inches on center or less.]
- [g.].e. Values apply to all-veneer plywood. Thickness at point of fastening on panel edges governs shear values.
- [h.].f. Where panels are applied on both faces of a wall and [nail] fastener spacing is less than 6 inches [o.e.] on center on either side, panel joints shall be offset to fall on different framing members [-O.r], or framing shall be 3 [inch] inches nominal or thicker at adjoining panel edges [and nails at all panel edges shall be staggered].
- [i.].g. In Seismic Design Category D [-E or F] where shear design values exceed 350 pounds per linear foot, all framing members receiving edge [nailing] fastening from abutting panels shall be not [be] less than a single 3-inch nominal member, or two 2-inch nominal members fastened together in accordance with Section 2306.1 to transfer the design shear value between framing members. Wood structural panel joint and sill plate nailing shall be staggered at all panel edges. [See Sections 4.3.6.1 and 4.3.6.4.3 of] See [AF&PA-SDPWS] AWC SDPWS for sill plate size and anchorage requirements.
- [j. Galvanized nails shall be hot dipped or tumbled.]
- [k.].l. Staples shall have a minimum crown width of 7/16-inch and shall be installed with their crowns parallel to the long dimension of the framing members.

[i.] For shear loads of normal or permanent load duration as defined by the [AF&PA NDS] ANS/AWC NDS, the values in the table above shall be multiplied by 0.63 or 0.56, respectively.

~~[2306.4 Lumber sheathed shear walls. Single and double diagonally sheathed lumber shear walls shall be designed and constructed in accordance with AF&PA SDPWS.]~~

~~[2306.5 Particleboard shear walls. Particleboard shear walls shall be designed and constructed in accordance with AF&PA SDPWS. Particleboard shear walls shall be permitted to resist horizontal forces using the allowable shear capacities set forth in Table 2306.5. Allowable capacities in Table 2306.5 are permitted to be increased 40 percent for wind design. Particleboard shall not be used to resist seismic forces in structures assigned to Seismic Design Category D.]~~

~~[2306.6 Fiberboard shear walls. Fiberboard shear walls shall be designed and constructed in accordance with AF&PA SDPWS. Fiberboard shear walls are permitted to resist horizontal forces using the allowable shear capacities set forth in Table 2306.6. Allowable capacities in Table 2306.6 are permitted to be increased 40 percent for wind design. Fiberboard shall not be used to resist seismic forces in structures assigned to Seismic Design Category D.]~~

TABLE [2306.6] 2306.3(2)
ALLOWABLE SHEAR VALUES (plf) FOR WIND OR SEISMIC LOADING ON
SHEAR WALLS OF FIBERBOARD SHEATHING BOARD CONSTRUCTION UTILIZING STAPLES
FOR TYPE V CONSTRUCTION ONLY^{a,b,c,d,e}

THICKNESS AND GRADE (inches)	[FASTENER SIZE] STAPLE GAGE AND DIMENSIONS	ALLOWABLE SHEAR VALUE (pounds per linear foot) [NAIL] STAPLE SPACING AT PANEL EDGES (inches) ^a		
		4	3	2
1/2" or 25/32" Structural	[No. 11 gage galvanized roofing nail 1 1/2" long for 3/2", 1 3/4" long for 25/32" with 3/8" head]	[470]	[230]	[260]
	No. [4+] 16 gage galvanized staple, 7/16 ^[f] inch crown ^[f] 1 3/4 inch long	150	200	225
	No. [4+] 16 gage galvanized staple, 1 ^[f] inch crown ^[f] 1 3/4 inch long	220	290	325

For SI: 1 inch = 25.4 mm, 1 pound per linear foot = 14.5939 N/m.

a. Fiberboard sheathing shall not be used to brace concrete or masonry walls.

b. Panel edges shall be backed with 2-inch or wider framing of Douglas ~~[fir-larch]~~ Fir-larch or Southern ~~[pine]~~ Pine. For framing of other species: (1) Find specific gravity for species of framing lumber in [AF&PA NDS] ANS/AWC NDS. (2) For staples, multiply the shear value from the table above by 0.82 for species with specific gravity of 0.42 or greater, or 0.65 for all other species. ~~[(3) For nails, multiply the shear value from the table above by the following adjustment factor: specific gravity adjustment factor = {1 - (0.5 - SG)}, where SG = Specific gravity of the framing lumber.]~~

c. Values shown are for fiberboard sheathing on one side only with long panel dimension either parallel or perpendicular to studs.

d. Fastener shall be spaced 6 inches on center along intermediate framing members.

e. Values are not permitted in Seismic Design Category D [~~E or F~~].

~~[f. Staple length shall not be less than 1 1/2 inches for 25/32-inch sheathing or 1 3/4 inches for 3/2-inch sheathing.]~~

~~[2306.7 Shear walls sheathed with other materials. Shear walls sheathed with portland cement plaster, gypsum lath, gypsum sheathing or gypsum board shall be designed and constructed in accordance with AF&PA SDPWS. Shear walls sheathed with these materials are permitted to resist horizontal forces using the allowable shear capacities set forth in Table 2306.7.]~~

TABLE [2306.7] 2306.3(3)
ALLOWABLE SHEAR VALUES FOR WIND OR SEISMIC FORCES FOR SHEAR WALLS OF LATH AND PLASTER OR GYPSUM BOARD WOOD FRAMED WALL ASSEMBLIES UTILIZING STAPLES

TYPE OF MATERIAL	THICKNESS OF MATERIAL	WALL CONSTRUCTION	[FASTENER] STAPLE SPACING ^b MAXIMUM (inches)	SHEAR VALUE ^{a,c,e} (plf)	MINIMUM [FASTENER] STAPLE SIZE ^{d,e,f,g,h}		
1. Expanded metal or woven wire lath and portland cement plaster	7/8"	Unblocked	6	180	[No. 11 gage 1 1/2" long, 7/16" head] No. 16 gage galv. staple, 7/8" legs		
2. Gypsum lath, plain or perforated [with vertical joints staggered]	3/8" lath and 1/2" plaster	Unblocked	5	[180] 100	No. [13] 16 gage galv. staple 1 1/2" long [7/16" head, plasterboard nail]		
[3. Gypsum lath, plain or perforated]	[3/8" lath and 1/2" plaster]	[Unblocked]	[5]	[180]	[No. 16 gage galv. staple, 1 1/2" long, 0.120" nail, min. 3/8" head, 1 1/4" long]		
3. Gypsum sheathing	1/2" x 2' x 8'	Unblocked	4	75	No. 16 gage galv. staple, 1 3/4" long		
	1/2" x 4'	Blocked ^d Unblocked	4 7	175 100			
4. Gypsum board, gypsum veneer base or water-resistant gypsum backing board	1/2"	Unblocked ^{f,d}	7	75	[5d cooler (1 5/8" x 0.086") or wallboard 0.120" nail, min. 3/8" head, 1 1/2" long] No. 16 gage galv. staple, 1 1/2" long		
		Unblocked ^{f,d}	4	110			
		Unblocked	7	100			
		Unblocked	4	125			
		Blocked ^{d,e}	7	125			
		Blocked ^{d,e}	4	150			
		[Unblocked]	[8/12 ^h]	[60]		[No. 6 1 3/4" screws ⁱ]	
		[Blocked ^e]	[4/16 ^h]	[160]			
	[Blocked ^{e,g}]	[4/12 ^h]	[155]				
	[Blocked ^e]	[8/12 ^h]	[70]				
	5/8"	Unblocked ^{f,d}		7	115	[6d cooler (1 7/8" x 0.092") or wallboard 0.120" nail, min. 3/8" head, 1 3/4" long] No. 16 gage galv. staple, 1 1/2" legs, 1 5/8" long	
				4	145		
				7	145		
				4	175		
		Blocked ^{d,e}	Two-ply	Base ply: 9 Face ply: 7	7	250	[Base ply 6d cooler (1 7/8" x 0.092") or wallboard 1 3/4" x 0.120" nail, min. 3/8" head 1 5/8" 16 gage galv. staple 1 5/8" 16 gage galv. staple Face ply 8d cooler (2 3/8" x 0.113") or wallboard 0.120" nail, min. 3/8" head, 2 3/8" long No. 15 gage galv. staple, 2 3/4" long] No. 16 gage galv. staple, 1 5/8" long No. 15 gage galv. staple, 2 1/4" long
					4	250	
7					250		
4					250		
[Unblocked]	[8/12 ^h]	[70]	[No. 6 1 3/4" screws ⁱ]				
[Blocked ^e]	[8/12 ^h]	[90]					

For SI: 1 inch = 25.4 mm, 1 foot = 304.8 mm, 1 pound per foot = 14.5939 N/m.

a. These shear walls shall not be used to resist loads imposed by masonry or concrete walls (see [Section 4.1.5 of] [AF&PA SDPWS] AWC SDPWS). Values shown are for short-term loading due to wind or seismic loading. Walls resisting seismic loads shall be subject to the limitations in Section 12.2.1 of ASCE 7. Values shown shall be reduced 25 percent for normal loading.

b. Applies to fastening at studs, top and bottom plates and blocking.

c. Alternate fasteners are permitted to be used if their dimensions are not less than the specified dimensions. Drywall screws are permitted to substitute for the 5d (1 5/8" x 0.086"), and 6d (1 7/8" x 0.092") (cooler) nails listed above, and No. 6 1 3/4-inch Type S or W screws for 6d (1 7/8" x 0.092") (cooler) nails.

d. For properties of cooler nails, see ASTM C 514.

e. Except as noted, shear values are based on a maximum framing spacing of 16 inches on center.

f. Maximum framing spacing of 24 inches on center.

g. All edges are blocked, and edge fastening is provided at all supports and all panel edges.

h. First number denotes fastener spacing at the edges; second number denotes fastener spacing at intermediate framing members.

i. Screws are Type W or S.

[j-]f. Staples shall have a minimum crown width of $\frac{7}{16}$ inch, measured outside the legs, and shall be installed with their crowns parallel to the long dimension of the framing members.

[k-]g. Staples for the attachment of gypsum lath and woven-wire lath shall have a minimum crown width of $\frac{3}{4}$ inch, measured outside the legs.

SECTION BC 2307 LOAD AND RESISTANCE FACTOR DESIGN

2307.1 Load and resistance factor design. The [~~structural analysis~~] design and construction of wood elements and structures using load and resistance factor design [~~(LRFD) methods~~] shall be in accordance with [~~AF&PA NDS~~] ANSI/AWC NDS and [~~AF&PA SDPWS~~] AWC SDPWS.

~~[2307.1.1 Wood structural panel shear walls. In Seismic Design Category D, where shear design values exceed 490 pounds per foot (7154 N/m), all framing members receiving edge nailing from abutting panels shall not be less than a single 3-inch (76 mm) nominal member or two 2-inch (51 mm) nominal members fastened together in accordance with AF&PA NDS to transfer the design shear value between framing members. Wood structural panel joint and sill plate nailing shall be staggered at all panel edges. See Sections 4.3.6.1 and 4.3.6.4.3 of AF&PA SDPWS for sill plate size and anchorage requirements.]~~

SECTION BC 2308 CONVENTIONAL LIGHT-FRAME CONSTRUCTION

2308.1 General. The requirements of this section are intended for conventional light-frame construction. Other construction methods are permitted to be used, provided a satisfactory design is submitted showing compliance with other provisions of this code. Interior nonload-bearing partitions, ceilings and curtain walls of conventional light-frame construction are not subject to the limitations of [~~this section. Alternatively, compliance with AF&PA WFCM shall be permitted subject to the limitations therein and the limitations of this code.]~~ Section 2308.2.

2308.1.1 Portions exceeding limitations of conventional light-frame construction. When portions of a building of otherwise conventional light-frame construction exceed the limits of Section 2308.2, [~~these~~] those portions and the supporting load path shall be designed in accordance with accepted engineering practice and the provisions of this code. For the purposes of this section, the term “portions” shall mean parts of buildings containing volume and area [~~;~~] such as a room or a series of rooms. The extent of such design need only demonstrate compliance of the nonconventional light-framed elements with other applicable provisions of this code and shall be compatible with the performance of the conventional light-framed system.

2308.1.2 Connectors and fasteners. Connectors and fasteners used in conventional light-frame construction shall comply with the requirements of Section 2304.10.

2308.2 Limitations. Buildings are permitted to be constructed in accordance with the provisions of [~~Section 2308 for~~] conventional light-frame construction, subject to the [~~following~~] limitations [~~;~~ and to further limitations of] in Sections [2308.11 and 2308.12:] 2308.2.1 through 2308.2.6.

[1. ~~Buildings shall be limited to a maximum of three stories above grade plane. For the purposes of this section, for buildings in Seismic Design Category D as determined in Section 1613, cripple stud walls shall be considered to be a story.~~

Exception: Solid blocked cripple walls not exceeding 14 inches (356 mm) in height need not be considered a story.]

2308.2.1 Stories. Structures of conventional light-frame construction shall be limited in story height in accordance with Table 2308.2.1.

**TABLE 2308.2.1
ALLOWABLE STORY HEIGHT**

<u>SEISMIC DESIGN CATEGORY</u>	<u>ALLOWABLE STORY ABOVE GRADE PLANE</u>
A and B	Three stories
C	Two stories
D ^a	One story

For SI: 1 inch = 25.4 mm.

a. For the purposes of this section, for buildings assigned to Seismic Design Category D cripple walls shall be considered to be a story unless cripple walls are solid blocked and do not exceed 14 inches in height.

[2-] **2308.2.2 Allowable floor-to-floor height.** Maximum floor-to-floor height shall not exceed 11 feet, 7 inches (3531 mm). [Bearing] Exterior bearing wall [height] and interior braced wall heights shall not exceed a stud height of 10 feet (3048 mm).

[3-] **2308.2.3 Allowable loads.** Loads [as determined] shall be in accordance with Chapter 16 and shall not exceed the following:

[3-1.] 1. Average dead loads shall not exceed 15 psf (718 N/m²) for combined roof and ceiling, exterior walls, floors and partitions.

Exceptions:

1. Subject to the limitations of [Sections 2308.11.2 and 2308.12.2,] Section 2308.6.10, stone or masonry veneer up to the lesser of 5 inches (127 mm) thick or 50 psf (2395 N/m²) and installed in accordance with Chapter 14 is permitted to a height of 30 feet (9144 mm) above a noncombustible foundation, with an additional 8 feet (2438 mm) permitted for gable ends.
2. Concrete or masonry fireplaces, heaters and chimneys shall be permitted in accordance with the provisions of this code.

[3-2.] 2. Live loads shall not exceed 40 psf (1916 N/m²) for floors.

Exception: Live loads for concrete slab-on-ground floors in Risk Categories I and II shall be not more than 125 psf.

[3-3.] Ground snow loads shall not exceed 50 psf (2395 N/m²).]

[4. Wind speeds shall not exceed 100 miles per hour (mph)(44 m/s) (3-second gust).]

Exception: Wind speeds shall not exceed 110 mph (48.4 m/s) (3-second gust) for buildings in Exposure Category B that are not located in a hurricane-prone region.]

2308.2.4 Basic design wind speed. The basic design wind speed, V, in miles per hour for determination of wind loads shall be as set forth in Table 1609.3. Values are ultimate design 3-

second gust wind speeds in miles per hour at 33 feet (10 058 mm) above ground Exposure Category C.

~~[5. Roof] **2308.2.5 Allowable roof span.** Ceiling joist and rafter framing constructed in accordance with Section 2308.7 and trusses [and rafters] shall not span more than 40 feet (12 192 mm) between points of vertical support. A ridge board in accordance with Section 2308.7 or 2308.7.3.1 shall not be considered a vertical support.~~

~~[6.] **2308.2.6 Risk category limitation.** The use of the provisions for conventional light-frame construction in this section shall not be permitted for [Occupancy] Risk Category IV buildings assigned to Seismic Design Category B, C, or D, as determined in Section 1613.~~

~~[7. Conventional light frame construction is limited in irregular structures in Seismic Design Category D, as specified in Section 2308.12.6.]~~

~~[**2308.2.1 Basic wind speed greater than 100 mph (3-second gust).** Where the basic wind speed exceeds 100 mph (3-second gust), the provisions of either AF&PA WFCM or ICC 600 are permitted to be used.]~~

~~[**2308.2.2 Buildings in Seismic Design Category B, C, or D.** Buildings of conventional light-frame construction in Seismic Design Category B or C, as determined in Section 1613, shall comply with the additional requirements in Section 2308.11. Buildings of conventional light-frame construction in Seismic Design Category D, as determined in Section 1613, shall comply with the additional requirements in Section 2308.12.]~~

~~[**2308.3 Braced wall lines.** Buildings shall be provided with exterior and interior braced wall lines as described in Section 2308.9.3 and installed in accordance with Sections 2308.3.1 through 2308.3.4.]~~

~~[**2308.3.1 Spacing.** Spacing of braced wall lines shall not exceed 35 feet (10 668 mm) o.c. in both the longitudinal and transverse directions in each story.]~~

~~[**2308.3.2 Braced wall line connections.** Wind and seismic lateral forces shall be transferred from the roofs and floors to braced wall lines and from the braced wall lines in upper stories to the braced wall lines in the story below in accordance with this section. Braced wall line top plates shall be fastened to joists, rafters or full depth blocking above in accordance with Table 2304.9.1, Items 11, 12, 15 or 19 as applicable based on the orientation of the joists or rafters to the braced wall line. Braced wall line bottom plates shall be connected to joists or blocking below in accordance with Table 2304.9.1, Item 6, or to foundations in accordance with Section 2308.3.3. At exterior gable end walls, braced wall panel sheathing in the top story shall be extended and fastened to roof framing where the spacing between parallel exterior braced wall lines is greater than 50 feet (15 240 mm).]~~

~~[**Exception:** Where roof trusses are used and are installed perpendicular to an exterior braced wall line, lateral forces shall be transferred from the roof diaphragm to the braced wall by blocking of the ends of the trusses or by other approved methods providing equivalent lateral force transfer. Blocking shall be a minimum of 2 inches (51 mm) nominal in thickness and equal to the depth of the truss at the wall line and shall be fastened to the braced wall line top plate as specified in Table 2304.9.1, Item 11.]~~

~~[2308.3.3 Sill anchorage. Where foundations are required by Section 2308.3.4, braced wall line sills shall be anchored to concrete or masonry foundations. Such anchorage shall conform to the requirements of Section 2308.6, except that such anchors shall be spaced at not more than 4 feet (1219 mm) o.c. for structures over two stories above grade plane. The anchors shall be distributed along the length of the braced wall line. Other anchorage devices having equivalent capacity are permitted.]~~

~~[2308.3.3.1 Anchorage to all wood foundations. Where all wood foundations are used, the force transfer from the braced wall lines shall be determined based on calculation and shall have a capacity greater than or equal to the connections required by Section 2308.3.3.]~~

~~[2308.3.4 Braced wall line support. Braced wall lines shall be supported by continuous foundations.]~~

~~[Exception: For structures with a maximum plan dimension not over 50 feet (15 240 mm), continuous foundations are required at exterior walls only.]~~

~~[2308.4 Design of elements. Combining of engineered elements or systems and conventionally specified elements or systems is permitted subject to the following limits:]~~

~~[2308.4.1 Elements exceeding limitations of conventional construction. When a building of otherwise conventional construction contains structural elements exceeding the limits of Section 2308.2, these elements and the supporting load path shall be designed in accordance with accepted engineering practice and the provisions of this code.]~~

~~[2308.4.2 Structural elements or systems not described herein. When a building of otherwise conventional construction contains structural elements or systems not described in Section 2308, these elements or systems shall be designed in accordance with accepted engineering practice and the provisions of this code. The extent of such design need only demonstrate compliance of the nonconventional elements with other applicable provisions of this code and shall be compatible with the performance of the conventionally framed system.]~~

~~[2308.5 Connections and fasteners. Connections and fasteners used in conventional construction shall comply with the requirements of Section 2304.9.]~~

2308.3 Foundations and footings. Foundations and footings shall be designed and constructed in accordance with Chapter 18. Connections to foundations and footings shall comply with this section.

~~[2308.6] 2308.3.1 Foundation plates or sills.[Foundations and footings shall be as specified in Chapter 18.] Foundation plates or sills resting on concrete or masonry foundations shall comply with Section 2304.3.1. Foundation plates or sills shall be bolted or anchored to the foundation with not less than ½-inch-diameter (12.7 mm) steel bolts or approved anchors suitable for use with pressure-treated plates spaced to provide equivalent anchorage as the steel bolts. Bolts shall be embedded ~~[at least]~~ not less than 7 inches (178 mm) into concrete or masonry~~[-and]~~. The bolts shall be located in the middle third of the width of the plate. Bolts shall be spaced not more than 6 feet (1829 mm) [apart. There] on center and there shall be [a minimum of] not less than two bolts or anchor straps per piece with one bolt or anchor strap located not more than 12 inches (305 mm) or less than 4 inches (102 mm) from each end of each piece. Bolts in sill plates of braced~~

wall lines in structures over two stories above grade shall be spaced not more than 4 feet (1219 mm) on center. A properly sized nut and washer shall be tightened on each bolt to the plate.

2308.3.2 Braced wall line sill plate anchorage in Seismic Design Category D. Sill plates along braced wall lines in buildings assigned to Seismic Design Category D shall be anchored with anchor bolts with steel plate washers between the foundation sill plate and the nut, or approved anchor straps load-rated in accordance with Section 2304.10.3. Such washers shall be a minimum of 0.229 inch by 3 inches by 3 inches (5.82 mm by 76 mm by 76 mm) in size. The hole in the plate washer is permitted to be diagonally slotted with a width of up to $\frac{3}{16}$ inch (4.76 mm) larger than the bolt diameter and a slot length not to exceed 1 $\frac{3}{4}$ inches (44 mm), provided a standard cut washer is placed between the plate washer and the nut. All steel shall be of appropriate corrosion resistance when in contact with pressure-treated wood.

2308.4 Floor framing. Floor framing shall comply with this section.

~~[2308.7]~~ **2308.4.1 Girders.** Girders for single-story construction or girders supporting loads from a single floor shall be not [be] less than 4 inches by 6 inches (102 mm by 152 mm) for spans 6 feet (1829 mm) or less, provided that girders are spaced not more than 8 feet (2438 mm) [o.e.] on center. [Spans for built-up 2-inch (51 mm) girders shall be in accordance with Table 2308.9.5 or 2308.9.6.] Other girders shall be designed to support the loads specified in this code. Girder end joints shall occur over supports. [Where a girder is spliced over a support, an adequate tie shall be provided. The ends of beams or girders supported on masonry or concrete shall not have less than 3 inches (76 mm) of bearing.]

Where a girder is spliced over a support, an adequate tie shall be provided. The ends of beams or girders supported on masonry or concrete shall not have less than 3 inches (76 mm) of bearing.

2308.4.1.1 Allowable girder spans. The allowable spans of girders that are fabricated of dimension lumber shall not exceed the values set forth in Table 2308.4.1.1(1) or 2308.4.1.1(2).

TABLE 2308.4.1.1(1)
HEADER AND GIRDER SPANS^{a, b, c, d} FOR EXTERIOR BEARING WALLS
(Maximum spans for Douglas Fir-Larch, Hem-Fir, Southern Pine and Spruce-Pine-Fir and required
number of jack studs)

HEADERS AND GIRDERS SUPPORTING	SIZE	Building width ^c (feet)					
		12		24		36	
		Span ^a	NJ ^f	Span ^a	NJ ^f	Span ^a	NJ ^f
Roof and ceiling	2-2 x 4	4-0	1	3-1	1	2-7	1
	2-2 x 6	6-0	1	4-7	1	3-10	1
	2-2 x 8	7-7	1	5-9	1	4-10	2
	2-2 x 10	9-0	1	6-10	2	5-9	2
	2-2 x 12	10-7	2	8-1	2	6-10	2
	3-2 x 8	9-5	1	7-3	1	6-1	1
	3-2 x 10	11-3	1	8-7	1	7-3	2
	3-2 x 12	13-2	1	10-1	2	8-6	2
	4-2 x 8	10-11	1	8-4	1	7-0	1
	4-2 x 10	12-11	1	9-11	1	8-4	1
4-2 x 12	15-3	1	11-8	1	9-10	2	
Roof, ceiling and one center-bearing floor	2-2 x 4	3-3	1	2-6	1	2-2	1
	2-2 x 6	4-10	1	3-9	1	3-3	2
	2-2 x 8	6-1	1	4-10	2	4-1	2
	2-2 x 10	7-3	2	5-8	2	4-10	2
	2-2 x 12	8-6	2	6-8	2	5-8	2
	3-2 x 8	7-8	1	6-0	1	5-1	2
	3-2 x 10	9-1	1	7-2	2	6-1	2
	3-2 x 12	10-8	2	8-5	2	7-2	2
	4-2 x 8	8-10	1	6-11	1	5-11	1
	4-2 x 10	10-6	1	8-3	2	7-0	2
4-2 x 12	12-4	1	9-8	2	8-3	2	
Roof, ceiling and one clear span floor	2-2 x 4	2-11	1	2-3	1	1-10	1
	2-2 x 6	4-4	1	3-4	2	2-10	2
	2-2 x 8	5-6	2	4-3	2	3-7	2
	2-2 x 10	6-7	2	5-0	2	4-2	2
	2-2 x 12	7-9	2	5-11	2	4-11	3
	3-2 x 8	6-11	1	5-3	2	4-5	2
	3-2 x 10	8-3	2	6-3	2	5-3	2
	3-2 x 12	9-8	2	7-5	2	6-2	2
	4-2 x 8	8-0	1	6-1	1	5-1	2
	4-2 x 10	9-6	1	7-3	2	6-1	2
4-2 x 12	11-2	2	8-6	2	7-2	2	
Roof, ceiling and two center-bearing floors	2-2 x 4	2-8	1	2-1	1	1-9	1
	2-2 x 6	4-0	1	3-2	2	2-8	2
	2-2 x 8	5-0	2	4-0	2	3-5	2
	2-2 x 10	6-0	2	4-9	2	4-0	2
	2-2 x 12	7-0	2	5-7	2	4-9	3
	3-2 x 8	6-4	1	5-0	2	4-3	2
	3-2 x 10	7-6	2	5-11	2	5-1	2
	3-2 x 12	8-10	2	7-0	2	5-11	2
	4-2 x 8	7-3	1	5-9	1	4-11	2
	4-2 x 10	8-8	1	6-10	2	5-10	2
4-2 x 12	10-2	2	8-1	2	6-10	2	
Roof, ceiling and two clear span floors	2-2 x 4	2-3	1	1-8	1	1-4	1
	2-2 x 6	3-4	1	2-6	2	2-2	2
	2-2 x 8	4-3	2	3-3	2	2-8	2
	2-2 x 10	5-0	2	3-10	2	3-2	3
	2-2 x 12	5-11	2	4-6	3	3-9	3
	3-2 x 8	5-3	1	4-0	2	3-5	2
	3-2 x 10	6-3	2	4-9	2	4-0	2
	3-2 x 12	7-5	2	5-8	2	4-9	3
	4-2 x 8	6-1	1	4-8	2	3-11	2
	4-2 x 10	7-3	2	5-6	2	4-8	2
4-2 x 12	8-6	2	6-6	2	5-6	2	

For SI: 1 inch = 25.4 mm, 1 pound per square foot = 0.0479 kPa.

a. Spans are given in feet and inches.

b. Spans are based on minimum design properties for No. 2 grade lumber of Douglas Fir-Larch, Hem-Fir, Southern Pine and Spruce-Pine Fir.

c. Use for cases in which the roof live load is equal to or less than 20 psf.

d. Values are for 30 psf ground snow load.

- e. Building width is measured perpendicular to the ridge. For widths between those shown, spans are permitted to be interpolated.
- f. NJ = Number of jack studs required to support each end. Where the number of required jack studs equals one, the header is permitted to be supported by an approved framing anchor attached to the full-height wall stud and to the header.
- g. Spans are calculated assuming the top of the header or girder is laterally braced by perpendicular framing. Where the top of the header or girder is not laterally braced (for example, cripple studs bearing on the header), tabulated spans for headers consisting of 2 x 8, 2 x 10, or 2 x 12 sizes shall be multiplied by 0.70 or the header or girder shall be designed.

TABLE 2308.4.1.1(2)
HEADER AND GIRDER SPANS^{a, b} FOR INTERIOR BEARING WALLS
(Maximum spans for Douglas Fir-Larch, Hem-Fir, Southern Pine and Spruce-Pine-Fir and required number of jack studs)

HEADERS AND GIRDER SUPPORTING	SIZE	Building width ^c (feet)					
		12		24		36	
		Span ^e	NJ ^d	Span ^e	NJ ^d	Span ^e	NJ ^d
One floor only	2-2 x 4	4-1	1	2-10	1	2-4	1
	2-2 x 6	6-1	1	4-4	1	3-6	1
	2-2 x 8	7-9	1	5-5	1	4-5	2
	2-2 x 10	9-2	1	6-6	2	5-3	2
	2-2 x 12	10-9	1	7-7	2	6-3	2
	3-2 x 8	9-8	1	6-10	1	5-7	1
	3-2 x 10	11-5	1	8-1	1	6-7	2
	3-2 x 12	13-6	1	9-6	2	7-9	2
	4-2 x 8	11-2	1	7-11	1	6-5	1
	4-2 x 10	13-3	1	9-4	1	7-8	1
4-2 x 12	15-7	1	11-0	1	9-0	2	
Two floors	2-2 x 4	2-7	1	1-11	1	1-7	1
	2-2 x 6	3-11	1	2-11	2	2-5	2
	2-2 x 8	5-0	1	3-8	2	3-1	2
	2-2 x 10	5-11	2	4-4	2	3-7	2
	2-2 x 12	6-11	2	5-2	2	4-3	3
	3-2 x 8	6-3	1	4-7	2	3-10	2
	3-2 x 10	7-5	1	5-6	2	4-6	2
	3-2 x 12	8-8	2	6-5	2	5-4	2
	4-2 x 8	7-2	1	5-4	1	4-5	2
	4-2 x 10	8-6	1	6-4	2	5-3	2
4-2 x 12	10-1	1	7-5	2	6-2	2	

For SI: 1 inch = 25.4 mm, 1 pound per square foot = 0.0479 kPa.

- a. Spans are given in feet and inches.
- b. Spans are based on minimum design properties for No. 2 grade lumber of Douglas Fir-Larch, Hem-Fir, Southern Pine and Spruce-Pine Fir.
- c. Building width is measured perpendicular to the ridge. For widths between those shown, spans are permitted to be interpolated.
- d. NJ = Number of jack studs required to support each end. Where the number of required jack studs equals one, the header is permitted to be supported by an approved framing anchor attached to the full-height wall stud and to the header.
- e. Spans are calculated assuming the top of the header or girder is laterally braced by perpendicular framing. Where the top of the header or girder is not laterally braced (for example, cripple studs bearing on the header), tabulated spans for headers consisting of 2 x 8, 2 x 10, or 2 x 12 sizes shall be multiplied by 0.70 or the header or girder shall be designed.

[2308.8] 2308.4.2 Floor joists. [Span for floor joists shall be in accordance with Table 2308.8(1) or 2308.8(2). For other grades and or species, refer to the AF&PA Span Tables for Joists and Rafters.] Floor joists shall comply with this section.

[TABLE 2308.8(1)]
FLOOR JOIST SPANS FOR COMMON LUMBER SPECIES
(Residential Sleeping Areas, Live Load = 30 pounds per square foot, L/Δ = 360)

JOIST SPACING (inches)	SPECIES AND GRADE	DEAD LOAD = 10 psf				DEAD LOAD = 20 psf			
		2×6	2×8	2×10	2×12	2×6	2×8	2×10	2×12
		Maximum floor joists spans							
		(ft. in.)	(ft. in.)	(ft. in.)	(ft. in.)	(ft. in.)	(ft. in.)	(ft. in.)	(ft. in.)
12	Douglas Fir Larch SS	12-6	16-6	21-0	25-7	12-6	16-6	21-0	25-7
	Douglas Fir Larch #1	12-0	15-10	20-3	24-8	12-0	15-7	19-0	22-0
	Douglas Fir Larch #2	11-10	15-7	19-10	23-0	11-6	14-7	17-9	20-7
	Douglas Fir Larch #3	9-8	12-4	15-0	17-5	8-8	11-0	13-5	15-7
	Hem Fir SS	11-10	15-7	19-10	24-2	11-10	15-7	19-10	24-2
	Hem Fir #1	11-7	15-3	19-5	23-7	11-7	15-2	18-6	21-6
	Hem Fir #2	11-0	14-6	18-6	22-6	11-0	14-4	17-6	20-4
	Hem Fir #3	9-8	12-4	15-0	17-5	8-8	11-0	13-5	15-7
	Southern Pine SS	12-3	16-2	20-8	25-1	12-3	16-2	20-8	25-1
	Southern Pine #1	12-0	15-10	20-3	24-8	12-0	15-10	20-3	24-8
	Southern Pine #2	11-10	15-7	19-10	24-2	11-10	15-7	18-7	21-9
	Southern Pine #3	10-5	13-3	15-8	18-8	9-4	11-11	14-0	16-8
	Spruce Pine Fir SS	11-7	15-3	19-5	23-7	11-7	15-3	19-5	23-7
	Spruce Pine Fir #1	11-3	14-11	19-0	23-0	11-3	14-7	17-9	20-7
	Spruce Pine Fir #2	11-3	14-11	19-0	23-0	11-3	14-7	17-9	20-7
	Spruce Pine Fir #3	9-8	12-4	15-0	17-5	8-8	11-0	13-5	15-7
16	Douglas Fir Larch SS	11-4	15-0	19-1	23-3	11-4	15-0	19-1	23-0
	Douglas Fir Larch #1	10-11	14-5	18-5	21-4	10-8	13-6	16-5	19-1
	Douglas Fir Larch #2	10-9	14-1	17-2	19-11	9-11	12-7	15-5	17-10
	Douglas Fir Larch #3	8-5	10-8	13-0	15-1	7-6	9-6	11-8	13-6
	Hem Fir SS	10-9	14-2	18-0	21-11	10-9	14-2	18-0	21-11
	Hem Fir #1	10-6	13-10	17-8	20-9	10-4	13-1	16-0	18-7
	Hem Fir #2	10-0	13-2	16-10	19-8	9-10	12-5	15-2	17-7
	Hem Fir #3	8-5	10-8	13-0	15-1	7-6	9-6	11-8	13-6
	Southern Pine SS	11-2	14-8	18-9	22-10	11-2	14-8	18-9	22-10
	Southern Pine #1	10-11	14-5	18-5	22-5	10-11	14-5	17-11	21-4
	Southern Pine #2	10-9	14-2	18-0	21-1	10-5	13-6	16-1	18-10
	Southern Pine #3	9-0	11-6	13-7	16-2	8-1	10-3	12-2	14-6
	Spruce Pine Fir SS	10-6	13-10	17-8	21-6	10-6	13-10	17-8	21-4
	Spruce Pine Fir #1	10-3	13-6	17-2	19-11	9-11	12-7	15-5	17-10
	Spruce Pine Fir #2	10-3	13-6	17-2	19-11	9-11	12-7	15-5	17-10
	Spruce Pine Fir #3	8-5	10-8	13-0	15-1	7-6	9-6	11-8	13-6
19.2	Douglas Fir Larch SS	10-8	14-1	18-0	21-10	10-8	14-1	18-0	21-0
	Douglas Fir Larch #1	10-4	13-7	16-9	19-6	9-8	12-4	15-0	17-5
	Douglas Fir Larch #2	10-1	12-10	15-8	18-3	9-1	11-6	14-1	16-3
	Douglas Fir Larch #3	7-8	9-9	11-10	13-9	6-10	8-8	10-7	12-4
	Hem Fir SS	10-1	13-4	17-0	20-8	10-1	13-4	17-0	20-7
	Hem Fir #1	9-10	13-0	16-4	19-0	9-6	12-0	14-8	17-0
	Hem Fir #2	9-5	12-5	15-6	17-1	8-11	11-4	13-10	16-1
	Hem Fir #3	7-8	9-9	11-10	13-9	6-10	8-8	10-7	12-4
	Southern Pine SS	10-6	13-10	17-8	21-6	10-6	13-10	17-8	21-6
	Southern Pine #1	10-4	13-7	17-4	21-1	10-4	13-7	16-4	19-6
	Southern Pine #2	10-1	13-4	16-5	19-3	9-6	12-4	14-8	17-2
	Southern Pine #3	8-3	10-6	12-5	14-9	7-4	9-5	11-1	13-2
	Spruce Pine Fir SS	9-10	13-0	16-7	20-2	9-10	13-0	16-7	19-6
	Spruce Pine Fir #1	9-8	12-9	15-8	18-3	9-1	11-5	14-1	16-3
	Spruce Pine Fir #2	9-8	12-9	15-8	18-3	9-1	11-5	14-1	16-3
	Spruce Pine Fir #3	7-8	9-9	11-10	13-9	6-10	8-8	10-7	12-4
24	Douglas Fir Larch SS	9-11	13-1	16-8	20-3	9-11	13-1	16-2	18-9
	Douglas Fir Larch #1	9-7	12-4	15-0	17-5	8-8	11-0	13-5	15-7
	Douglas Fir Larch #2	9-1	11-6	14-1	16-3	8-1	10-3	12-7	14-7
	Douglas Fir Larch #3	6-10	8-8	10-7	12-4	6-2	7-9	9-6	11-0
	Hem Fir SS	9-4	12-4	15-9	19-2	9-4	12-4	15-9	18-5
	Hem Fir #1	9-2	12-0	14-8	17-0	8-6	10-9	13-1	15-2
	Hem Fir #2	8-9	11-4	13-10	16-1	8-0	10-2	12-5	14-4
	Hem Fir #3	6-10	8-8	10-7	12-4	6-2	7-9	9-6	11-0
	Southern Pine SS	9-9	12-10	16-5	19-11	9-9	12-10	16-5	19-11
	Southern Pine #1	9-7	12-7	16-1	19-6	9-7	12-4	14-7	17-5
Southern Pine #2	9-4	12-4	14-8	17-2	8-6	11-0	13-1	15-5	

[TABLE 2308.8(1)]
FLOOR JOIST SPANS FOR COMMON LUMBER SPECIES
(Residential Sleeping Areas, Live Load = 30 pounds per square foot, L/Δ = 360)

JOIST SPACING (inches)	SPECIES AND GRADE	DEAD LOAD = 10 psf				DEAD LOAD = 20 psf			
		2×6	2×8	2×10	2×12	2×6	2×8	2×10	2×12
		Maximum floor joists spans							
		(ft. in.)	(ft. in.)	(ft. in.)	(ft. in.)	(ft. in.)	(ft. in.)	(ft. in.)	(ft. in.)
	Southern Pine #3	7-4	9-5	11-1	13-2	6-7	8-5	9-11	11-10
	Spruce Pine Fir SS	9-2	12-1	15-5	18-9	9-2	12-1	15-0	17-5
	Spruce Pine Fir #1	8-11	11-6	14-1	16-3	8-1	10-3	12-7	14-7
	Spruce Pine Fir #2	8-11	11-6	14-1	16-3	8-1	10-3	12-7	14-7
	Spruce Pine Fir #3	6-10	8-8	10-7	12-4	6-2	7-9	9-6	11-0

Check sources for availability of lumber in lengths greater than 20 feet.
 For SI: 1 inch = 25.4 mm, 1 foot = 304.8 mm, 1 pound per square foot = 47.8 N/m².]

[TABLE 2308.8(2)]
FLOOR JOIST SPANS FOR COMMON LUMBER SPECIES
(Residential Living Areas, Live Load = 40 pounds per square foot, L/Δ = 360)

JOIST SPACING (inches)	SPECIES AND GRADE	DEAD LOAD = 10 psf				DEAD LOAD = 20 psf			
		2×6	2×8	2×10	2×12	2×6	2×8	2×10	2×12
		Maximum floor joists spans							
		(ft. in.)	(ft. in.)	(ft. in.)	(ft. in.)	(ft. in.)	(ft. in.)	(ft. in.)	(ft. in.)
12	Douglas Fir Larch SS	11-4	15-0	19-1	23-3	11-4	15-0	19-1	23-3
	Douglas Fir Larch #1	10-11	14-5	18-5	22-0	10-11	14-2	17-4	20-1
	Douglas Fir Larch #2	10-9	14-2	17-9	20-7	10-6	13-3	16-3	18-10
	Douglas Fir Larch #3	8-8	11-0	13-5	15-7	7-11	10-0	12-3	14-3
	Hem Fir SS	10-9	14-2	18-0	21-11	10-9	14-2	18-0	21-11
	Hem Fir #1	10-6	13-10	17-8	21-6	10-6	13-10	16-11	19-7
	Hem Fir #2	10-0	13-2	16-10	20-4	10-0	13-1	16-0	18-6
	Hem Fir #3	8-8	11-0	13-5	15-7	7-11	10-0	12-3	14-3
	Southern Pine SS	11-2	14-8	18-9	22-10	11-2	14-8	18-9	22-10
	Southern Pine #1	10-11	14-5	18-5	22-5	10-11	14-5	18-5	22-5
	Southern Pine #2	10-9	14-2	18-0	21-9	10-9	14-2	16-11	19-10
	Southern Pine #3	9-4	11-11	14-0	16-8	8-6	10-10	12-10	15-3
	Spruce Pine Fir SS	10-6	13-10	17-8	21-6	10-6	13-10	17-8	21-6
	Spruce Pine Fir #1	10-3	13-6	17-3	20-7	10-3	13-3	16-3	18-10
	Spruce Pine Fir #2	10-3	13-6	17-3	20-7	10-3	13-3	16-3	18-10
	Spruce Pine Fir #3	8-8	11-0	13-5	15-7	7-11	10-0	12-3	14-3
16	Douglas Fir Larch SS	10-4	13-7	17-4	21-1	10-4	13-7	17-4	21-0
	Douglas Fir Larch #1	9-11	13-1	16-5	19-1	9-8	12-4	15-0	17-5
	Douglas Fir Larch #2	9-9	12-7	15-5	17-10	9-1	11-6	14-1	16-3
	Douglas Fir Larch #3	7-6	9-6	11-8	13-6	6-10	8-8	10-7	12-4
	Hem Fir SS	9-9	12-10	16-5	19-11	9-9	12-10	16-5	19-11
	Hem Fir #1	9-6	12-7	16-0	18-7	9-6	12-0	14-8	17-0
	Hem Fir #2	9-1	12-0	15-2	17-7	8-11	11-4	13-10	16-1
	Hem Fir #3	7-6	9-6	11-8	13-6	6-10	8-8	10-7	12-4
	Southern Pine SS	10-2	13-4	17-0	20-9	10-2	13-4	17-0	20-9
	Southern Pine #1	9-11	13-1	16-9	20-4	9-11	13-1	16-4	19-6
	Southern Pine #2	9-9	12-10	16-1	18-10	9-6	12-4	14-8	17-2
	Southern Pine #3	8-1	10-3	12-2	14-6	7-4	9-5	11-1	13-2
	Spruce Pine Fir SS	9-6	12-7	16-0	19-6	9-6	12-7	16-0	19-6
	Spruce Pine Fir #1	9-4	12-3	15-5	17-10	9-1	11-6	14-1	16-3
	Spruce Pine Fir #2	9-4	12-3	15-5	17-10	9-1	11-6	14-1	16-3
	Spruce Pine Fir #3	7-6	9-6	11-8	13-6	6-10	8-8	10-7	12-4
19.2	Douglas Fir Larch SS	9-8	12-10	16-4	19-10	9-8	12-10	16-4	19-2
	Douglas Fir Larch #1	9-4	12-4	15-0	17-5	8-10	11-3	13-8	15-11
	Douglas Fir Larch #2	9-1	11-6	14-1	16-3	8-3	10-6	12-10	14-10
	Douglas Fir Larch #3	6-10	8-8	10-7	12-4	6-3	7-11	9-8	11-3
	Hem Fir SS	9-2	12-1	15-5	18-9	9-2	12-1	15-5	18-9
	Hem Fir #1	9-0	11-10	14-8	17-0	8-8	10-11	13-4	15-6
	Hem Fir #2	8-9	11-3	13-10	16-1	8-2	10-4	12-8	14-8
	Hem Fir #3	6-10	8-8	10-7	12-4	6-3	7-11	9-8	11-3
	Southern Pine SS	9-6	12-7	16-0	19-6	9-6	12-7	16-0	19-6
	Southern Pine #1	9-4	12-4	15-9	19-2	9-4	12-4	14-11	17-9
	Southern Pine #2	9-2	12-1	14-8	17-2	8-8	11-3	13-5	15-8
	Southern Pine #3	7-4	9-5	11-1	13-2	6-9	8-7	10-1	12-1

[TABLE 2308.8(2)]
FLOOR JOIST SPANS FOR COMMON LUMBER SPECIES
(Residential Living Areas, Live Load = 40 pounds per square foot, L/Δ = 360)

JOIST SPACING (inches)	SPECIES AND GRADE		DEAD LOAD = 10 psf				DEAD LOAD = 20 psf			
			2×6	2×8	2×10	2×12	2×6	2×8	2×10	2×12
			Maximum floor joists spans							
		(ft. in.)	(ft. in.)	(ft. in.)	(ft. in.)	(ft. in.)	(ft. in.)	(ft. in.)	(ft. in.)	
24	Spruce Pine Fir	SS	9-0	11-10	15-1	18-4	9-0	11-10	15-1	17-9
	Spruce Pine Fir	#1	8-9	11-6	14-1	16-3	8-3	10-6	12-10	14-10
	Spruce Pine Fir	#2	8-9	11-6	14-1	16-3	8-3	10-6	12-10	14-10
	Spruce Pine Fir	#3	6-10	8-8	10-7	12-4	6-3	7-11	9-8	11-3
	Douglas Fir Larch	SS	9-0	11-11	15-2	18-5	9-0	11-11	14-9	17-1
	Douglas Fir Larch	#1	8-8	11-0	13-5	15-7	7-11	10-0	12-3	14-3
	Douglas Fir Larch	#2	8-1	10-3	12-7	14-7	7-5	9-5	11-6	13-4
	Douglas Fir Larch	#3	6-2	7-9	9-6	11-0	5-7	7-1	8-8	10-1
	Hem Fir	SS	8-6	11-3	14-4	17-5	8-6	11-3	14-4	16-10 ^a
	Hem Fir	#1	8-4	10-9	13-1	15-2	7-9	9-9	11-11	13-10
	Hem Fir	#2	7-11	10-2	12-5	14-4	7-4	9-3	11-4	13-1
	Hem Fir	#3	6-2	7-9	9-6	11-0	5-7	7-1	8-8	10-1
	Southern Pine	SS	8-10	11-8	14-11	18-1	8-10	11-8	14-11	18-1
	Southern Pine	#1	8-8	11-5	14-7	17-5	8-8	11-3	13-4	15-11
	Southern Pine	#2	8-6	11-0	13-1	15-5	7-9	10-0	12-0	14-0
	Southern Pine	#3	6-7	8-5	9-11	11-10	6-0	7-8	9-1	10-9
	Spruce Pine Fir	SS	8-4	11-0	14-0	17-0	8-4	11-0	13-8	15-11
	Spruce Pine Fir	#1	8-1	10-3	12-7	14-7	7-5	9-5	11-6	13-4
	Spruce Pine Fir	#2	8-1	10-3	12-7	14-7	7-5	9-5	11-6	13-4
	Spruce Pine Fir	#3	6-2	7-9	9-6	11-0	5-7	7-1	8-8	10-1

Check sources for availability of lumber in lengths greater than 20 feet.
 For SI: 1 inch = 25.4 mm, 1 foot = 304.8 mm, 1 pound per square foot = 47.8 N/m².
 a. — End bearing length shall be increased to 2 inches.]

2308.4.2.1 Span. Spans for floor joists shall be in accordance with Table 2308.4.2.1(1) or 2308.4.2.1(2) or the AWC STJR.

TABLE 2308.4.2.1(1)
FLOOR JOIST SPANS FOR COMMON LUMBER SPECIES
(Residential sleeping areas, live load = 30 psf, L/Δ = 360)

JOIST SPACING (inches)	SPECIES AND GRADE		DEAD LOAD = 10 psf				DEAD LOAD = 20 psf			
			2×6	2×8	2×10	2×12	2×6	2×8	2×10	2×12
			Maximum floor joist spans							
		(ft. in.)	(ft. in.)	(ft. in.)	(ft. in.)	(ft. in.)	(ft. in.)	(ft. in.)	(ft. in.)	
12	Douglas Fir-Larch	SS	12-6	16-6	21-0	25-7	12-6	16-6	21-0	25-7
	Douglas Fir-Larch	#1	12-0	15-10	20-3	24-8	12-0	15-7	19-0	22-0
	Douglas Fir-Larch	#2	11-10	15-7	19-10	23-0	11-6	14-7	17-9	20-7
	Douglas Fir-Larch	#3	9-8	12-4	15-0	17-5	8-8	11-0	13-5	15-7
	Hem-Fir	SS	11-10	15-7	19-10	24-2	11-10	15-7	19-10	24-2
	Hem-Fir	#1	11-7	15-3	19-5	23-7	11-7	15-2	18-6	21-6
	Hem-Fir	#2	11-0	14-6	18-6	22-6	11-0	14-4	17-6	20-4
	Hem-Fir	#3	9-8	12-4	15-0	17-5	8-8	11-0	13-5	15-7
	Southern Pine	SS	12-3	16-2	20-8	25-1	12-3	16-2	20-8	25-1
	Southern Pine	#1	11-10	15-7	19-10	24-2	11-10	15-7	18-7	22-0
	Southern Pine	#2	11-3	14-11	18-1	21-4	10-9	13-8	16-2	19-1
	Southern Pine	#3	9-2	11-6	14-0	16-6	8-2	10-3	12-6	14-9
	Spruce-Pine-Fir	SS	11-7	15-3	19-5	23-7	11-7	15-3	19-5	23-7
	Spruce-Pine-Fir	#1	11-3	14-11	19-0	23-0	11-3	14-7	17-9	20-7
	Spruce-Pine-Fir	#2	11-3	14-11	19-0	23-0	11-3	14-7	17-9	20-7
	Spruce-Pine-Fir	#3	9-8	12-4	15-0	17-5	8-8	11-0	13-5	15-7
16	Douglas Fir-Larch	SS	11-4	15-0	19-1	23-3	11-4	15-0	19-1	23-0
	Douglas Fir-Larch	#1	10-11	14-5	18-5	21-4	10-8	13-6	16-5	19-1
	Douglas Fir-Larch	#2	10-9	14-1	17-2	19-11	9-11	12-7	15-5	17-10
	Douglas Fir-Larch	#3	8-5	10-8	13-0	15-1	7-6	9-6	11-8	13-6
	Hem-Fir	SS	10-9	14-2	18-0	21-11	10-9	14-2	18-0	21-11
	Hem-Fir	#1	10-6	13-10	17-8	20-9	10-4	13-1	16-0	18-7
	Hem-Fir	#2	10-0	13-2	16-10	19-8	9-10	12-5	15-2	17-7
Hem-Fir	#3	8-5	10-8	13-0	15-1	7-6	9-6	11-8	13-6	

TABLE 2308.4.2.1(1)
FLOOR JOIST SPANS FOR COMMON LUMBER SPECIES
(Residential sleeping areas, live load = 30 psf, L/Δ = 360)

JOIST SPACING (inches)	SPECIES AND GRADE		DEAD LOAD = 10 psf				DEAD LOAD = 20 psf			
			2 × 6	2 × 8	2 × 10	2 × 12	2 × 6	2 × 8	2 × 10	2 × 12
			Maximum floor joist spans							
			(ft.-in.)	(ft.-in.)	(ft.-in.)	(ft.-in.)	(ft.-in.)	(ft.-in.)	(ft.-in.)	(ft.-in.)
19.2	Southern Pine	SS	11-2	14-8	18-9	22-10	11-2	14-8	18-9	22-10
	Southern Pine	#1	10-9	14-2	18-0	21-4	10-9	13-9	16-1	19-1
	Southern Pine	#2	10-3	13-3	15-8	18-6	9-4	11-10	14-0	16-6
	Southern Pine	#3	7-11	10-10	12-1	14-4	7-1	8-11	10-10	12-10
	Spruce-Pine-Fir	SS	10-6	13-10	17-8	21-6	10-6	13-10	17-8	21-4
	Spruce-Pine-Fir	#1	10-3	13-6	17-2	19-11	9-11	12-7	15-5	17-10
	Spruce-Pine-Fir	#2	10-3	13-6	17-2	19-11	9-11	12-7	15-5	17-10
	Spruce-Pine-Fir	#3	8-5	10-8	13-0	15-1	7-6	9-6	11-8	13-6
	Douglas Fir-Larch	SS	10-8	14-1	18-0	21-10	10-8	14-1	18-0	21-0
	Douglas Fir-Larch	#1	10-4	13-7	16-9	19-6	9-8	12-4	15-0	17-5
	Douglas Fir-Larch	#2	10-1	12-10	15-8	18-3	9-1	11-6	14-1	16-3
	Douglas Fir-Larch	#3	7-8	9-9	11-10	13-9	6-10	8-8	10-7	12-4
	Hem-Fir	SS	10-1	13-4	17-0	20-8	10-1	13-4	17-0	20-7
	Hem-Fir	#1	9-10	13-0	16-4	19-0	9-6	12-0	14-8	17-0
Hem-Fir	#2	9-5	12-5	15-6	17-1	8-11	11-4	13-10	16-1	
Hem-Fir	#3	7-8	9-9	11-10	13-9	6-10	8-8	10-7	12-4	
Southern Pine	SS	10-6	13-10	17-8	21-6	10-6	13-10	17-8	21-6	
Southern Pine	#1	10-1	13-4	16-5	19-6	9-11	12-7	14-8	17-5	
Southern Pine	#2	9-6	12-1	14-4	16-10	8-6	10-10	12-10	15-1	
Southern Pine	#3	7-3	9-1	11-0	13-1	6-5	8-2	9-10	11-8	
Spruce-Pine-Fir	SS	9-10	13-0	16-7	20-2	9-10	13-0	16-7	19-6	
Spruce-Pine-Fir	#1	9-8	12-9	15-8	18-3	9-1	11-6	14-1	16-3	
Spruce-Pine-Fir	#2	9-8	12-9	15-8	18-3	9-1	11-6	14-1	16-3	
Spruce-Pine-Fir	#3	7-8	9-9	11-10	13-9	6-10	8-8	10-7	12-4	
24	Douglas Fir-Larch	SS	9-11	13-1	16-8	20-3	9-11	13-1	16-2	18-9
	Douglas Fir-Larch	#1	9-7	12-4	15-0	17-5	8-8	11-0	13-5	15-7
	Douglas Fir-Larch	#2	9-1	11-6	14-1	16-3	8-1	10-3	12-7	14-7
	Douglas Fir-Larch	#3	6-10	8-8	10-7	12-4	6-2	7-9	9-6	11-0
	Hem-Fir	SS	9-4	12-4	15-9	19-2	9-4	12-4	15-9	18-5
	Hem-Fir	#1	9-2	12-0	14-8	17-0	8-6	10-9	13-1	15-2
	Hem-Fir	#2	8-9	11-4	13-10	16-1	8-0	10-2	12-5	14-4
	Hem-Fir	#3	6-10	8-8	10-7	12-4	6-2	7-9	9-6	11-0
	Southern Pine	SS	9-9	12-10	16-5	19-11	9-9	12-10	16-5	19-8
	Southern Pine	#1	9-4	12-4	14-8	17-5	8-10	11-3	13-1	15-7
	Southern Pine	#2	8-6	10-10	12-10	15-1	7-7	9-8	11-5	13-6
	Southern Pine	#3	6-5	8-2	9-10	11-8	5-9	7-3	8-10	10-5
	Spruce-Pine-Fir	SS	9-2	12-1	15-5	18-9	9-2	12-1	15-0	17-5
	Spruce-Pine-Fir	#1	8-11	11-6	14-1	16-3	8-1	10-3	12-7	14-7
	Spruce-Pine-Fir	#2	8-11	11-6	14-1	16-3	8-1	10-3	12-7	14-7
	Spruce-Pine-Fir	#3	6-10	8-8	10-7	12-4	6-2	7-9	9-6	11-0

For SI: 1 inch = 25.4 mm, 1 foot = 304.8 mm, 1 pound per square foot = 0.0479 kPa.

Note: Check sources for availability of lumber in lengths greater than 20 feet.

TABLE 2308.4.2.1(2)
FLOOR JOIST SPANS FOR COMMON LUMBER SPECIES
(Residential living areas, live load = 40 psf, L/Δ = 360)

JOIST SPACING (inches)	SPECIES AND GRADE		DEAD LOAD = 10 psf				DEAD LOAD = 20 psf			
			2 × 6	2 × 8	2 × 10	2 × 12	2 × 6	2 × 8	2 × 10	2 × 12
			Maximum floor joist spans							
			(ft.-in.)	(ft.-in.)	(ft.-in.)	(ft.-in.)	(ft.-in.)	(ft.-in.)	(ft.-in.)	(ft.-in.)
12	Douglas Fir-Larch	SS	11-4	15-0	19-1	23-3	11-4	15-0	19-1	23-3
	Douglas Fir-Larch	#1	10-11	14-5	18-5	22-0	10-11	14-2	17-4	20-1
	Douglas Fir-Larch	#2	10-9	14-2	17-9	20-7	10-6	13-3	16-3	18-10
	Douglas Fir-Larch	#3	8-8	11-0	13-5	15-7	7-11	10-0	12-3	14-3
	Hem-Fir	SS	10-9	14-2	18-0	21-11	10-9	14-2	18-0	21-11
	Hem-Fir	#1	10-6	13-10	17-8	21-6	10-6	13-10	16-11	19-7
	Hem-Fir	#2	10-0	13-2	16-10	20-4	10-0	13-1	16-0	18-6
	Hem-Fir	#3	8-8	11-0	13-5	15-7	7-11	10-0	12-3	14-3
	Southern Pine	SS	11-2	14-8	18-9	22-10	11-2	14-8	18-9	22-10
	Southern Pine	#1	10-9	14-2	18-0	21-11	10-9	14-2	16-11	20-1
	Southern Pine	#2	10-3	13-6	16-2	19-1	9-10	12-6	14-9	17-5
	Southern Pine	#3	8-2	10-3	12-6	14-9	7-5	9-5	11-5	13-6
	Spruce-Pine-Fir	SS	10-6	13-10	17-8	21-6	10-6	13-10	17-8	21-6
	Spruce-Pine-Fir	#1	10-3	13-6	17-3	20-7	10-3	13-3	16-3	18-10
	Spruce-Pine-Fir	#2	10-3	13-6	17-3	20-7	10-3	13-3	16-3	18-10
	Spruce-Pine-Fir	#3	8-8	11-0	13-5	15-7	7-11	10-0	12-3	14-3
16	Douglas Fir-Larch	SS	10-4	13-7	17-4	21-1	10-4	13-7	17-4	21-0
	Douglas Fir-Larch	#1	9-11	13-1	16-5	19-1	9-8	12-4	15-0	17-5
	Douglas Fir-Larch	#2	9-9	12-7	15-5	17-10	9-1	11-6	14-1	16-3
	Douglas Fir-Larch	#3	7-6	9-6	11-8	13-6	6-10	8-8	10-7	12-4
	Hem-Fir	SS	9-9	12-10	16-5	19-11	9-9	12-10	16-5	19-11
	Hem-Fir	#1	9-6	12-7	16-0	18-7	9-6	12-0	14-8	17-0
	Hem-Fir	#2	9-1	12-0	15-2	17-7	8-11	11-4	13-10	16-1
	Hem-Fir	#3	7-6	9-6	11-8	13-6	6-10	8-8	10-7	12-4
	Southern Pine	SS	10-2	13-4	17-0	20-9	10-2	13-4	17-0	20-9
	Southern Pine	#1	9-9	12-10	16-1	19-1	9-9	12-7	14-8	17-5
	Southern Pine	#2	9-4	11-10	14-0	16-6	8-6	10-10	12-10	15-1
	Southern Pine	#3	7-1	8-11	10-10	12-10	6-5	8-2	9-10	11-8
	Spruce-Pine-Fir	SS	9-6	12-7	16-0	19-6	9-6	12-7	16-0	19-6
	Spruce-Pine-Fir	#1	9-4	12-3	15-5	17-10	9-1	11-6	14-1	16-3
	Spruce-Pine-Fir	#2	9-4	12-3	15-5	17-10	9-1	11-6	14-1	16-3
	Spruce-Pine-Fir	#3	7-6	9-6	11-8	13-6	6-10	8-8	10-7	12-4
19.2	Douglas Fir-Larch	SS	9-8	12-10	16-4	19-10	9-8	12-10	16-4	19-2
	Douglas Fir-Larch	#1	9-4	12-4	15-0	17-5	8-10	11-3	13-8	15-11
	Douglas Fir-Larch	#2	9-1	11-6	14-1	16-3	8-3	10-6	12-10	14-10
	Douglas Fir-Larch	#3	6-10	8-8	10-7	12-4	6-3	7-11	9-8	11-3
	Hem-Fir	SS	9-2	12-1	15-5	18-9	9-2	12-1	15-5	18-9
	Hem-Fir	#1	9-0	11-10	14-8	17-0	8-8	10-11	13-4	15-6
	Hem-Fir	#2	8-7	11-3	13-10	16-1	8-2	10-4	12-8	14-8
	Hem-Fir	#3	6-10	8-8	10-7	12-4	6-3	7-11	9-8	11-3
	Southern Pine	SS	9-6	12-7	16-0	19-6	9-6	12-7	16-0	19-6
	Southern Pine	#1	9-2	12-1	14-8	17-5	9-0	11-5	13-5	15-11
	Southern Pine	#2	8-6	10-10	12-10	15-1	7-9	9-10	11-8	13-9
	Southern Pine	#3	6-5	8-2	9-10	11-8	5-11	7-5	9-0	10-8
	Spruce-Pine-Fir	SS	9-0	11-10	15-1	18-4	9-0	11-10	15-1	17-9
	Spruce-Pine-Fir	#1	8-9	11-6	14-1	16-3	8-3	10-6	12-10	14-10
	Spruce-Pine-Fir	#2	8-9	11-6	14-1	16-3	8-3	10-6	12-10	14-10
	Spruce-Pine-Fir	#3	6-10	8-8	10-7	12-4	6-3	7-11	9-8	11-3
24	Douglas Fir-Larch	SS	9-0	11-11	15-2	18-5	9-0	11-11	14-9	17-1
	Douglas Fir-Larch	#1	8-8	11-0	13-5	15-7	7-11	10-0	12-3	14-3
	Douglas Fir-Larch	#2	8-1	10-3	12-7	14-7	7-5	9-5	11-6	13-4
	Douglas Fir-Larch	#3	6-2	7-9	9-6	11-0	5-7	7-1	8-8	10-1
	Hem-Fir	SS	8-6	11-3	14-4	17-5	8-6	11-3	14-4	16-10*
	Hem-Fir	#1	8-4	10-9	13-1	15-2	7-9	9-9	11-11	13-10
	Hem-Fir	#2	7-11	10-2	12-5	14-4	7-4	9-3	11-4	13-1
	Hem-Fir	#3	6-2	7-9	9-6	11-0	5-7	7-1	8-8	10-1
	Southern Pine	SS	8-10	11-8	14-11	18-1	8-10	11-8	14-11	18-0
	Southern Pine	#1	8-6	11-3	13-1	15-7	8-1	10-3	12-0	14-3
Southern Pine	#2	7-7	9-8	11-5	13-6	7-0	8-10	10-5	12-4	

TABLE 2308.4.2.1(2)
FLOOR JOIST SPANS FOR COMMON LUMBER SPECIES
(Residential living areas, live load = 40 psf, L/Δ = 360)

JOIST SPACING (inches)	SPECIES AND GRADE		DEAD LOAD = 10 psf				DEAD LOAD = 20 psf			
			2 × 6	2 × 8	2 × 10	2 × 12	2 × 6	2 × 8	2 × 10	2 × 12
			Maximum floor joist spans							
			(ft.-in.)	(ft.-in.)	(ft.-in.)	(ft.-in.)	(ft.-in.)	(ft.-in.)	(ft.-in.)	(ft.-in.)
	Southern Pine	#3	5-9	7-3	8-10	10-5	5-3	6-8	8-1	9-6
	Spruce-Pine-Fir	SS	8-4	11-0	14-0	17-0	8-4	11-0	13-8	15-11
	Spruce-Pine-Fir	#1	8-1	10-3	12-7	14-7	7-5	9-5	11-6	13-4
	Spruce-Pine-Fir	#2	8-1	10-3	12-7	14-7	7-5	9-5	11-6	13-4
	Spruce-Pine-Fir	#3	6-2	7-9	9-6	11-0	5-7	7-1	8-8	10-1

For SF: 1 inch = 25.4 mm, 1 foot = 304.8 mm, 1 pound per square foot = 0.0479 kPa.

Note: Check sources for availability of lumber in lengths greater than 20 feet.

a. End bearing length shall be increased to 2 inches.

[2308.8.1] 2308.4.2.2 Bearing. ~~[Except where]~~ The ends of each joist shall have not less than 1½ inches (38 mm) of bearing on wood or metal, or not less than 3 inches (76 mm) on masonry, except where supported on a 1-inch by 4-inch ~~[(25.4 mm by 102 mm)]~~ (25 mm by 102 mm) ribbon strip and nailed to the adjoining stud ~~[, the ends of each joist shall not have less than 1½ inches (38 mm) of bearing on wood or metal, or less than 3 inches (76 mm) on masonry].~~

[2308.8.2] 2308.4.2.3 Framing details. Joists shall be supported laterally at the ends and at each support by solid blocking except where the ends of the joists are nailed to a header, band or rim joist or to an adjoining stud or by other means. Solid blocking shall ~~be~~ not ~~[be]~~ less than 2 inches ~~[(51mm)]~~ (51 mm) in thickness and the full depth of the joist. ~~[Notches on the ends of joists shall not exceed one fourth the hoist depth. Holes bored in joists shall not be within 2 inches (51 mm) of the top or bottom of the joist, and the diameter of any such hole shall not exceed one third the depth of the joist. Notches in the top or bottom of joists shall not exceed one sixth the depth and shall not be located in the middle third of the span.]~~ Joist framing from opposite sides of a beam, girder or partition shall be lapped at least 3 inches (76 mm) or the opposing joists shall be tied together in an approved manner. Joists framing into the side of a wood girder shall be supported by framing anchors or on ledger strips not less than 2 inches by 2 inches (51 mm by 51 mm).

2308.4.2.4 Notches and holes. ~~Notches on the ends of joists shall not exceed one-fourth the joist depth. Notches in the top or bottom of joists shall not exceed one-sixth the depth, shall not be longer than one-third the depth and shall not be located in the middle third of the span. Holes bored in joists shall not be within 2 inches (51 mm) of the top or bottom of the joist and the diameter of any such hole shall not exceed one-third the depth of the joist. Holes bored in the middle third of the span shall be located at the center of the joist depth. Clear distance between holes & notches shall be a minimum of 2 inches (51 mm). See Figure 2308.4.2.4.~~

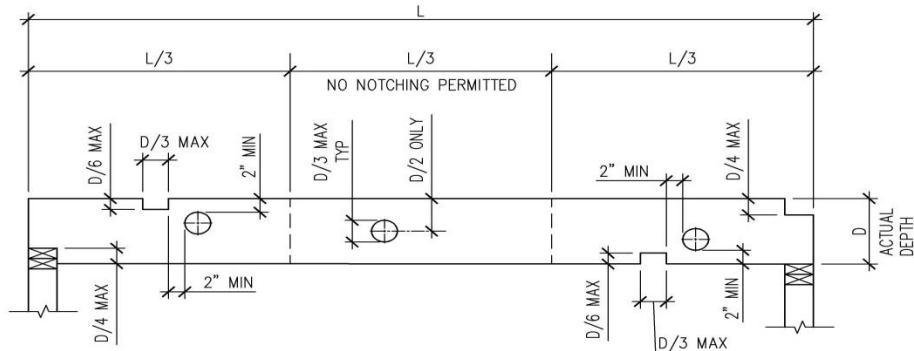

JOIST BORING AND NOTCHING NOTES:

1. INDICATED BORING AND NOTCHING LIMITS ARE FOR REPETITIVELY SPACED, UNIFORMLY LOADED, SIMPLY SUPPORTED SAWN MEMBERS.
2. FOR OTHER COMBINATIONS OF BORING, NOTCHING, OR LOADING CONSULT RDP OR DOB.
3. AVOID EXISTING KNOT AND WOOD DEFECT LOCATIONS WHEN PLANNING BORING AND NOTCHING.

FIGURE 2308.4.2.4 JOIST BORING AND NOTCHING LIMITS

NOT TO SCALE

[2308.8.2.1] 2308.4.3 Engineered wood products. Engineered wood products shall be installed in accordance with manufacturer’s recommendations. Cuts, notches and holes bored in trusses, structural composite lumber, structural glued-laminated members or I-joists are ~~not permitted~~ prohibited except where permitted by the manufacturer’s recommendations or where the effects of such alterations are specifically considered in the design of the member by a registered design professional.

[2308.8.3] 2308.4.4 Framing around openings. Trimmer and header joists shall be doubled, or of lumber of equivalent cross section, where the span of the header exceeds 4 feet (1219 mm). The ends of header joists more than 6 feet (1829 mm) ~~long~~ in length shall be supported by framing anchors or joist hangers unless bearing on a beam, partition or wall. Tail joists over 12 feet (3658 mm) ~~long~~ in length shall be supported at the header by framing anchors or on ledger strips not less than 2 inches by 2 inches (51 mm by 51 mm).

2308.4.4.1 Openings in floor diaphragms in Seismic Design Categories B, C, and D.

Openings in horizontal diaphragms in Seismic Design Categories B, C, and D with a dimension that is greater than 4 feet (1219 mm) shall be constructed with metal ties and blocking in accordance with this section and Figure 2308.4.4.1(1). Metal ties shall be not less than 0.058 inch (1.47 mm) (16 galvanized gage) in thickness by 1½ inches (38 mm) in width and shall have a yield stress not less than 33,000 psi (227 Mpa). Blocking shall extend not less than the dimension of the opening in the direction of the tie and blocking. Ties shall be attached to blocking in accordance with the manufacturer’s instructions but with not less than eight 16d common nails on each side of the header-joist intersection.

Openings in floor diaphragms in Seismic Design Category D shall not have any dimension exceeding 50 percent of the distance between braced wall lines or an area greater than 25 percent of the area between orthogonal pairs of braced wall lines (see Figure 2308.4.4.1(2)); or the portion of the structure containing the opening shall be designed in accordance with

accepted engineering practice to resist the forces specified in Chapter 16, to the extent such irregular opening affects the performance of the conventional framing system.

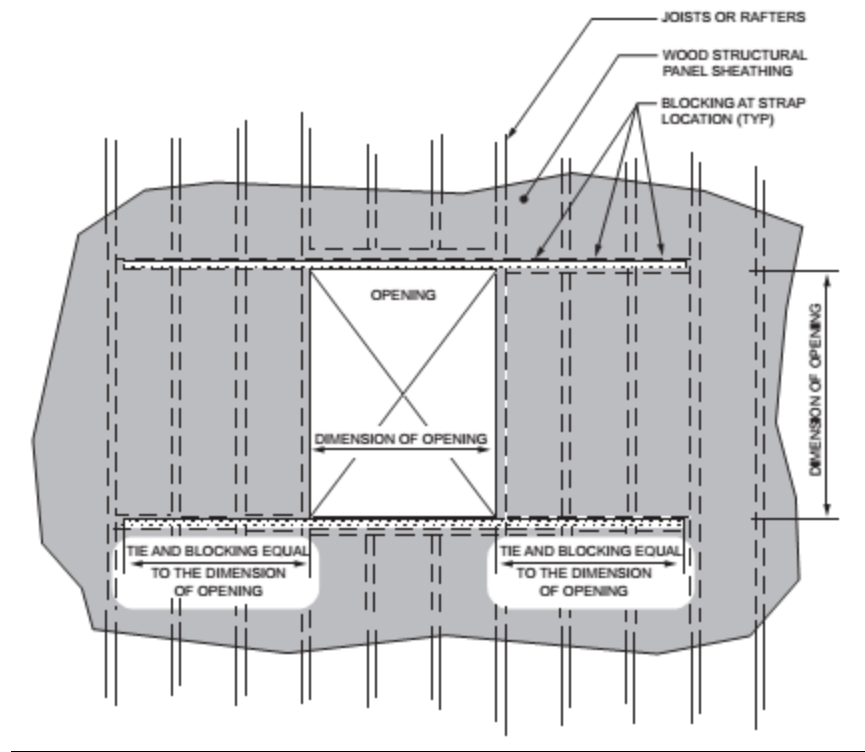

FIGURE 2308.4.4.1(1)
OPENINGS IN FLOOR AND ROOF DIAPHRAGMS

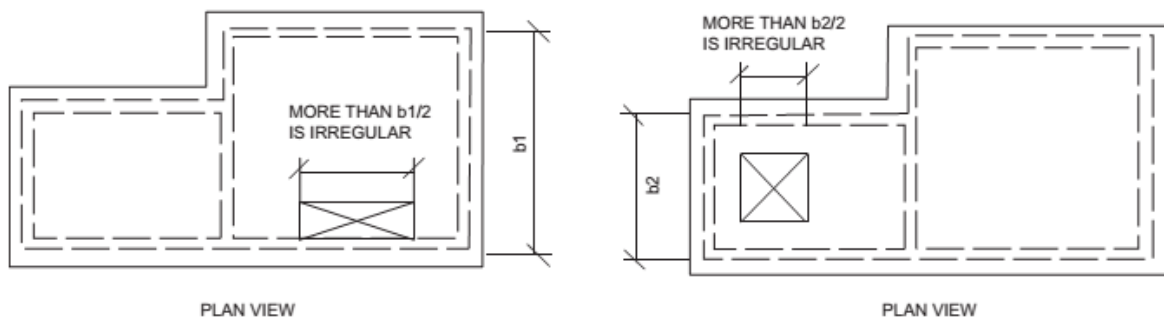

FIGURE 2308.4.4.1(2)
OPENING LIMITATIONS FOR FLOOR AND ROOF DIAPHRAGMS

2308.4.4.2 Vertical offsets in floor diaphragms in Seismic Design Category D. In Seismic Design Category D, portions of a floor level shall not be vertically offset such that the framing members on either side of the offset cannot be lapped or tied together in an approved manner in accordance with Figure 2308.4.4.2 unless the portion of the structure containing the irregular offset is designed in accordance with accepted engineering practice.

Exception: Framing supported directly by foundations need not be lapped or tied directly together.

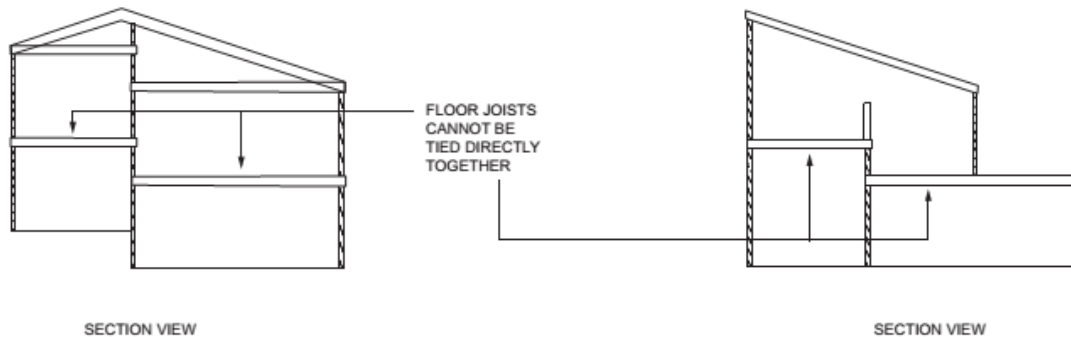

FIGURE 2308.4.4.2
PORTIONS OF FLOOR LEVEL OFFSET VERTICALLY

[2308.8.4 Supporting] 2308.4.5 Joists supporting bearing partitions. Bearing partitions parallel to joists shall be supported on beams, girders, doubled joists, walls or other bearing partitions. Bearing partitions perpendicular to joists shall not be offset from supporting girders, walls or partitions more than the joist depth unless such joists are of sufficient size to carry the additional load.

[2308.8.5] 2308.4.6 Lateral support. Floor[~~,-attic~~] and [~~roof~~] ceiling framing with a nominal depth-to-thickness ratio [~~greater~~] not less than [~~or equal 5:1~~] 5 to 1 shall have one edge held in line for the entire span. Where the nominal depth-to-thickness ratio of the framing member exceeds [~~6:1~~] 6 to 1, there shall be one line of bridging for each 8 feet (2438 mm) of span, unless both edges of the member are held in line. The bridging shall consist of not less than 1-inch by 3-inch (25 mm by 76 mm) lumber, double nailed at each end, [~~or~~] or equivalent metal bracing of equal rigidity, full-depth solid blocking or other approved means. A line of bridging shall also be required at supports where equivalent lateral support is not otherwise provided.

[2308.8.6] 2308.4.7 Structural floor sheathing. Structural floor sheathing shall comply with the provisions of Section [~~2304.7.1~~] 2304.8.1.

[2308.8.7] 2308.4.8 Under-floor ventilation. For under-floor ventilation, see Section [~~1203.3~~] 1203.4.

2308.4.9 Floor framing supporting braced wall panels. Where braced wall panels are supported by cantilevered floors or are set back from the floor joist support, the floor framing shall comply with Section 2308.6.7.

2308.4.10 Anchorage of exterior means of egress components in Seismic Design Category D. Exterior egress balconies, exterior stairways and ramps and similar means of egress components in structures assigned to Seismic Design Category D shall be positively anchored to the primary structure at not more than 8 feet (2438 mm) on center or shall be designed for lateral forces. Such attachment shall not be accomplished by use of toenails or nails subject to withdrawal.

2308.5 Wall construction. Walls of conventional light-frame construction shall be in accordance with this section.

[2308.9 Wall framing.]

[2308.9.1 Size] 2308.5.1 Stud size, height and spacing. The size, height and spacing of studs shall be in accordance with Table [2308.9.1] 2308.5.1. [except that utility-grade studs shall not be spaced more than 16 inches (406 mm) o.c., or support more than a roof and ceiling, or exceed 8 feet (2438 mm) in height for exterior walls and load-bearing walls or 10 feet (3048 mm) for interior nonload-bearing walls. Studs shall be continuous from a support at the sole plate to a support at the top plate to resist loads perpendicular to the wall. The support shall be a foundation or floor, ceiling or roof diaphragm or shall be designed in accordance with accepted engineering practice.]

Studs shall be continuous from a support at the sole plate to a support at the top plate to resist loads perpendicular to the wall. The support shall be a foundation or floor, ceiling or roof diaphragm or shall be designed in accordance with accepted engineering practice.

Exception: Jack studs, trimmer studs and cripple studs at openings in walls that comply with Table [2308.9.5:] 2308.4.1.1(1) or 2308.4.1.1(2).

**TABLE [2308.9.1] 2308.5.1
SIZE, HEIGHT AND SPACING OF WOOD STUDS^c**

STUD SIZE (inches)	BEARING WALLS				NONBEARING WALLS	
	Laterally unsupported stud height ^a (feet)	Supporting roof and ceiling only	Supporting one floor, roof and ceiling	Supporting two floors, roof and ceiling	Laterally unsupported stud height ^a (feet)	Spacing (inches)
2 × 3 ^b	—	—	—	—	10	16
2 × 4	10	24	16	—	14	24
3 × 4	10	24	24	16	14	24
2 × 5	10	24	24	—	16	24
2 × 6	10	24	24	16	20	24

For SI: 1 inch = 25.4 mm, 1 foot = 304.8 mm.

- a. Listed heights are distances between points of lateral support placed perpendicular to the plane of the wall. Increases in unsupported height are permitted where justified by an analysis.
- b. Shall not be used in exterior walls.
- c. Utility-grade studs shall not be spaced more than 16 inches on center or support more than a roof and ceiling, or exceed 8 feet in height for exterior walls and load-bearing walls or 10 feet for interior nonload-bearing walls.

[2308.9.2] 2308.5.2 Framing details. Studs shall be placed with their wide dimension perpendicular to the wall. Not less than three studs shall be installed at each corner of an exterior wall.

[Exception:] Exceptions:

1. In interior nonload-bearing walls and partitions that are not braced wall panels, studs are permitted to be set with the long dimension parallel to the wall.
2. At corners, two studs are permitted, provided that wood spacers or backup cleats of 3/8-inch-thick (9.5 mm) wood structural panel, 3/8-inch (9.5 mm) Type M “Exterior Glue” particleboard, 1-inch-thick (25 mm) lumber or other approved devices that will

serve as an adequate backing for the attachment of facing materials are used. Where fire-resistance ratings or shear values are involved, wood spacers, backup cleats or other devices shall not be used unless specifically approved for such use.

2308.5.3 Plates and sills. Studs shall have plates and sills in accordance with this section.

2308.5.3.1 Bottom plate or sill. Studs shall have full bearing on a plate or sill. Plates or sills shall be not less than 2 inches (51 mm) nominal in thickness and have a width not less than the width of the wall studs.

~~[2308.9.2.1]~~ **2308.5.3.2 Top plates.** Bearing and exterior wall studs shall be capped with double top plates installed to provide overlapping at corners and at intersections with other partitions. End joints in double top plates shall be offset ~~[at least]~~ not less than 48 inches (1219 mm), and shall be nailed in accordance with ~~[not less than eight 16d face nails on each side of the joint]~~ Table 2304.10.1. Plates shall be a nominal 2 inches (51 mm) in depth and have a width ~~[at least equal to]~~ not less than the width of the studs.

Exception: A single top plate is permitted, provided that the plate is adequately tied at ~~[joints,]~~ corners and intersecting walls by ~~[at least]~~ not less than the equivalent of a 3-inch by 6-inch (76 mm by 152 mm) by 0.036-inch-thick (0.914 mm) galvanized steel plate that is nailed to each wall or segment of wall by six 8d (2½" × 0.113" (64 mm by 2.87 mm)) box nails or equivalent ~~[, provided]~~ on each side of the joint. For the butt-jointed splice between adjacent single top plates, not less than the equivalent of a 3-inch by 12-inch (76 mm by 304 mm) by 0.036-inch-thick (0.914 mm) galvanized steel plate that is nailed to each wall or segment of wall by twelve 8d (2½-inch × 0.113-inch (64 mm by 2.87 mm)) box nails on each side of the joint shall be required, provided that the rafters, joists or trusses are centered over the studs with a tolerance of ~~[no]~~ not more than 1 inch (25 mm). The top plate shall not be required over headers that are in the same plane and in line with the upper surface of the adjacent top plates and are tied to adjacent wall sections as required for the butt joint splice between adjacent single top plates.

~~[2308.9.2.2 Top plates for studs spaced at 24 inches (610 mm).]~~ Where bearing studs are spaced at 24-inch (610 mm) intervals ~~[and]~~ top plates are less than two 2-inch by 6-inch (51 mm by 152 mm) or two 3-inch by 4-inch (76 mm by 102 mm) members and ~~[where]~~ the floor joists, floor trusses or roof trusses that they support are spaced at more than 16-inch (406 mm) intervals, such joists or trusses shall bear within 5 inches (127 mm) of the studs beneath or a third plate shall be installed.

~~[2308.9.2.3 Nonbearing]~~ **2308.5.4 Nonload-bearing walls and partitions.** In ~~[nonbearing]~~ nonload-bearing walls and partitions ~~[,]~~ that are not part of a braced wall panel, studs shall be spaced not more than ~~[28]~~ 24 inches [(711 mm)] (610 mm) ~~[o.e. and]~~ on center. In interior nonload-bearing walls and partitions, studs are permitted to be set with the long dimension parallel to the wall. Where studs are set with the long dimensions parallel to the wall, use of utility grade lumber or studs exceeding 10 feet (3048 mm) is not permitted. Interior ~~[nonbearing]~~ nonload-bearing partitions shall be capped with ~~[no]~~ not less than a single top plate installed to provide overlapping at corners and at intersections with other walls and partitions. The plate shall be continuously tied at joints by solid blocking ~~[at least]~~ not less than 16 inches (406 mm) in length

and equal in size to the plate or by ½-inch by 1½-inch (12.7 mm by 38 mm) metal ties with spliced sections fastened with two 16d nails on each side of the joint.

~~[2308.9.2.4 Plates or sills. Studs shall have full bearing on a plate or sill not less than 2 inches (51 mm) in thickness having a width not less than that of the wall studs.]~~

2308.5.5 Openings in walls and partitions. Openings in exterior and interior walls and partitions shall comply with Sections 2308.5.5.1 through 2308.5.5.3.

2308.5.5.1 Openings in exterior bearing walls. Headers shall be provided over each opening in exterior bearing walls. The size and spans in Table 2308.4.1.1(1) are permitted to be used for one- and two-family dwellings. Headers for other buildings shall be designed in accordance with Section 2301.2, Item 1 or 2. Headers shall be of two pieces of nominal 2-inch (51 mm) framing lumber set on edge as permitted by Table 2308.4.1.1(1) and nailed together in accordance with Table 2304.10.1 or of solid lumber of equivalent size.

Wall studs shall support the ends of the header in accordance with Table 2308.4.1.1(1). Each end of a lintel or header shall have a bearing length of not less than 1½ inches (38 mm) for the full width of the lintel.

~~[2308.9.3 Bracing. Braced wall lines shall consist of braced wall panels that meet the requirements for location, type and amount of bracing as shown in Figure 2308.9.3, specified in Table 2308.9.3(1), and are in line or offset from each other by not more than 4 feet (1219 mm). Braced wall panels shall start not more than 12½ feet (3810 mm) from each end of a braced wall line. Braced wall panels shall be clearly indicated on the plans. Construction of braced wall panels shall be by one of the following methods:]~~

- ~~[1. Nominal 1-inch by 4-inch (25 mm by 102 mm) continuous diagonal braces let into top and bottom plates and intervening studs, placed at an angle not more than 60 degrees (1.0 rad) or less than 45 degrees (0.79 rad) from the horizontal and attached to the framing in conformance with Table 2304.9.1.]~~
- ~~[2. Wood boards of 5⁄8-inch (15.9 mm) net minimum thickness applied diagonally on studs spaced not over 24 inches (610 mm) o.c.]~~
- ~~[3. Wood structural panel sheathing with a thickness not less than 3⁄8-inch (9.5 mm) for 16-inch (406 mm) or 24-inch (610 mm) stud spacing in accordance with Tables 2308.9.3(2) and 2308.9.3(3).]~~
- ~~[4. Fiberboard sheathing panels not less than ½-inch (12.7 mm) thick applied vertically or horizontally on studs spaced not over 16 inches (406 mm) o.c. where installed with fasteners in accordance with Section 2306.6 and Table 2306.6.]~~
- ~~[5. Gypsum board [sheathing ½-inch thick (12.7 mm) by 4 feet wide (1219 mm) wallboard or veneer base] on studs spaced not over 24 inches (610 mm) o.c. and nailed at 7 inches (178 mm) o.c. with nails as required by Table 2306.7.]~~

[6. Particleboard wall sheathing panels where installed in accordance with Table 2308.9.3(4).]

[7. Portland cement plaster on studs spaced 16 inches (406 mm) o.c. installed in accordance with Section 2510.]

[8. Hardboard panel siding where installed in accordance with Section 2303.1.6 and Table 2308.9.3(5).]

[For cripple wall bracing, see Section 2308.9.4.1. For Methods 2, 3, 4, 6, 7 and 8, each panel must be at least 48 inches (1219 mm) in length, covering three stud spaces where studs are spaced 16 inches (406 mm) apart and covering two stud spaces where studs are spaced 24 inches (610 mm) apart. For Method 5, each panel must be at least 96 inches (2438 mm) in length where applied to one face of a panel and 48 inches (1219 mm) where applied to both faces. All vertical joints of panel sheathing shall occur over studs and adjacent panel joints shall be nailed to common framing members. Horizontal joints shall occur over blocking or other framing equal in size to the studding except where waived by the installation requirements for the specific sheathing materials. Sole plates shall be nailed to the floor framing and top plates shall be connected to the framing above in accordance with Section 2308.3.2. Where joists are perpendicular to braced wall lines above, blocking shall be provided under and in line with the braced wall panels.]

[TABLE 2308.9.3(1)
BRACED WALL PANELS^a

SEISMIC DESIGN CATEGORY	CONDITION	CONSTRUCTION METHODS ^{b,e}								BRACED PANEL LOCATION AND LENGTH ^d
		1	2	3	4	5	6	7	8	
A and B	One story, top of two or three story	X	X	X	X	X	X	X	X	Located in accordance with Section 2308.9.3 and not more than 25 feet on center.
	First story of two story or second story of three story	X	X	X	X	X	X	X	X	
	First story of three story	—	X	X	X	X ^e	X	X	X	
C	One story or top of two story	—	X	X	X	X	X	X	X	Located in accordance with Section 2308.9.3 and not more than 25 feet on center.
	First story of two story	—	X	X	X	X ^e	X	X	X	Located in accordance with Section 2308.9.3 and not more than 25 feet on center, but total length shall not be less than 25% of building length ^f .

For SI: 1 inch = 25.4 mm, 1 foot = 304.8 mm.

a. This table specifies minimum requirements for braced panels that form interior or exterior braced wall lines.

b. See Section 2308.9.3 for full description.

c. See Sections 2308.9.3.1 and 2308.9.3.2 for alternative braced panel requirements.

d. Building length is the dimension parallel to the braced wall length.

e. Gypsum wallboard applied to framing supports that are spaced at 16 inches on center.

f. The required lengths shall be doubled for gypsum board applied to only one face of a braced wall panel.]

**[TABLE 2308.9.3(2)
EXPOSED PLYWOOD PANEL SIDING**

MINIMUM THICKNESS ^a (inch)	MINIMUM NUMBER OF PLIES	STUD SPACING (inches)
		Plywood siding applied directly to studs or over sheathing
$\frac{3}{8}$	3	16 ^b
$\frac{1}{2}$	4	24

For SI: 1 inch = 25.4 mm.

a. Thickness of grooved panels is measured at bottom of grooves.

b. Spans are permitted to be 24 inches if plywood siding applied with face grain perpendicular to studs or over one of the following: (1) 1-inch board sheathing; (2) $\frac{7}{16}$ -inch wood structural panel sheathing or (3) $\frac{3}{8}$ -inch wood structural panel sheathing with strength axis (which is the long direction of the panel unless otherwise marked) of sheathing perpendicular to studs.

**[TABLE 2308.9.3(3)
WOOD STRUCTURAL PANEL WALL SHEATHING^b**

(Not Exposed to the Weather, Strengthen Axis Parallel or Perpendicular to Studs Except as Indicated Below)

MINIMUM THICKNESS (inch)	PANEL SPAN RATING	STUD SPACING (inches)		
		Nailable sheathing		
		Siding nailed to studs	Sheathing parallel to studs	Sheathing perpendicular to studs
$\frac{3}{8}$ – $\frac{15}{32}$ – $\frac{1}{2}$	16/0, 20/0, 24/0, 32/16 Wall 24" o.c.	24	16	24
$\frac{7}{16}$ – $\frac{15}{32}$ – $\frac{1}{2}$	24/0, 24/16, 32/16 Wall 24" o.c.	24	24 ^a	24

For SI: 1 inch = 25.4 mm.

a. Plywood shall consist of four or more plies.

b. Blocking of horizontal joints shall not be required except as specified in Sections 2306.3 and 2308.12.4.]

**[TABLE 2308.9.3(4)
ALLOWABLE SPANS FOR PARTICLEBOARD WALL SHEATHING
(Not Exposed to the Weather, Long Dimension of the Panel Parallel or Perpendicular to Studs)**

GRADE	THICKNESS (inch)	STUD SPACING (inches)	
		Siding nailed to studs	Sheathing under coverings specified in Section 2308.9.3 parallel or perpendicular to studs
M-S "Exterior Glue" and M-2 "Exterior Glue"	$\frac{3}{8}$	16	—
	$\frac{1}{2}$	16	16

For SI: 1 inch = 25.4 mm.]

**[TABLE 2308.9.3(5)
HARDBOARD SIDING**

SIDING	MINIMUM NOMINAL THICKNESS (inch)	2 × 4 FRAMING MAXIMUM SPACING	NAIL SIZE ^{a,b,d}	NAIL SPACING	
				General	Bracing panels ^e
1. Lap siding					
Direct to studs	$\frac{3}{8}$	16" o.c.	8d	16" o.c.	Not applicable
Over sheathing	$\frac{3}{8}$	16" o.c.	10d	16" o.c.	Not applicable
2. Square edge panel siding					
Direct to studs	$\frac{3}{8}$	24" o.c.	6d	6" o.c. edges; 12" o.c. at intermediate supports	4" o.c. edges 8" o.c. at intermediate supports
Over sheathing	$\frac{3}{8}$	24" o.c.	8d	6" o.c. edges; 12" o.c. at intermediate supports	4" o.c. edges 8" o.c. at intermediate supports
3. Shiplap edge panel siding					
Direct to studs	$\frac{3}{8}$	16" o.c.	6d	6" o.c. edges; 12" o.c. at intermediate supports	4" o.c. edges 8" o.c. at intermediate supports
Over sheathing	$\frac{3}{8}$	16" o.c.	8d	6" o.c. edges; 12" o.c. at intermediate supports	4" o.c. edges 8" o.c. at intermediate supports

For SI: 1 inch = 25.4 mm.

a. Nails shall be corrosion resistant.

b. Minimum acceptable nail dimensions:

	Panel Siding (inch)	Lap Siding (inch)
Shank diameter	0.092	0.099
Head diameter	0.225	0.240

c. Where used to comply with Section 2308.9.3.

d. Nail length must accommodate the sheathing and penetrate framing 1½ inches.]

SEISMIC DESIGN CATEGORY	MAXIMUM WALL SPACING (feet)	REQUIRED BRACING LENGTH, b
A, B and C	35'-0"	Table 2308.9.3(1) and Section 2308.9.3
D and E	25'-0"	Table 2308.12.4

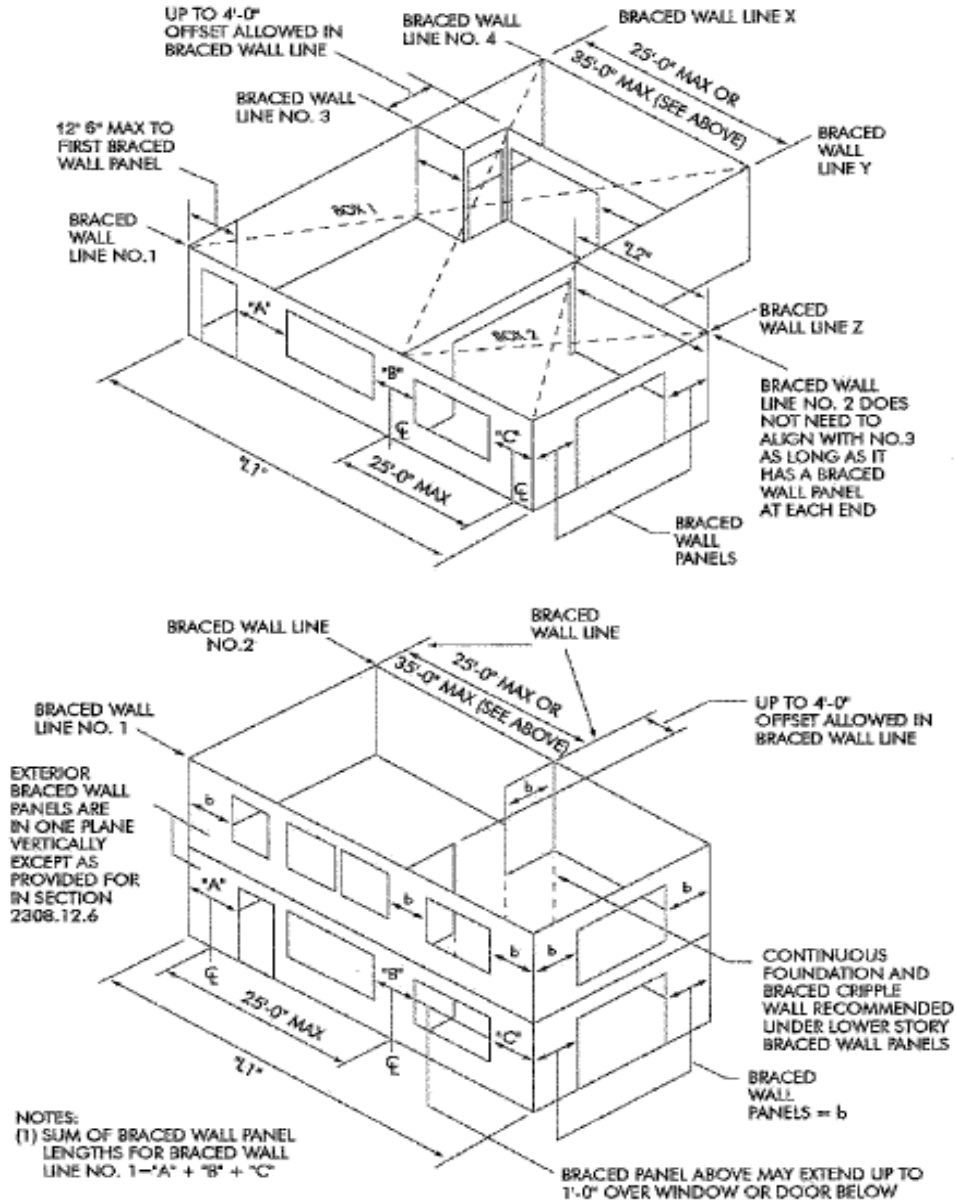

For SI: 1 inch = 25.4 mm, 1 foot = 304.8 mm.

FIGURE 2308.9.3
BASIC COMPONENTS OF THE LATERAL BRACING SYSTEM

[2308.9.3.1 Alternative bracing. Any bracing required by Section 2308.9.3 is permitted to be replaced by the following:]

[1. ~~In one-story buildings, each panel shall have a length of not less than 2 feet 8 inches (813 mm) and a height of not more than 10 feet (3048 mm). Each panel shall be sheathed on one face with $\frac{3}{8}$ -inch minimum thickness (9.5 mm) wood structural panel sheathing nailed with 8d common or galvanized box nails in accordance with Table 2304.9.1 and blocked at wood structural panel edges. Two anchor bolts installed in accordance with Section 2308.6 shall be provided in each panel. Anchor bolts shall be placed at each panel outside quarter points. Each panel end stud shall have a tie-down device fastened to the foundation, capable of providing an approved uplift capacity of not less than 1,800 pounds (8006 N). The tie-down device shall be installed in accordance with the manufacturer's recommendations. The panels shall be supported directly on a foundation or on floor framing supported directly on a foundation that is continuous across the entire length of the braced wall line. This foundation shall be reinforced with not less than one No. 4 bar top and bottom. Where the continuous foundation is required to have a depth greater than 12 inches (305 mm), a minimum 12-inch by 12-inch (305 mm by 305 mm) continuous footing or turned down slab edge is permitted at door openings in the braced wall line. This continuous footing or turned down slab edge shall be reinforced with not less than one No. 4 bar top and bottom. This reinforcement shall be lapped 15 inches (381 mm) with the reinforcement required in the continuous foundation located directly under the braced wall line.~~]

[2. ~~In the first story of two-story buildings, each wall panel shall be braced in accordance with Section 2308.9.3.1, Item 1, except that the wood structural panel sheathing shall be provided on both faces, three anchor bolts shall be placed at one quarter points, and tie-down device uplift capacity shall not be less than 3,000 pounds (13 344 N).~~]

[2308.9.3.2 Alternate bracing wall panel adjacent to a door or window opening. Any bracing required by Section 2308.9.3 is permitted to be replaced by the following when used adjacent to a door or window opening with a full-length header:]

[1. ~~In one-story buildings, each panel shall have a length of not less than 16 inches (406 mm) and a height of not more than 10 feet (3048 mm). Each panel shall be sheathed on one face with a single layer of $\frac{3}{8}$ -inch (9.5 mm) minimum thickness wood structural panel sheathing nailed with 8d common or galvanized box nails in accordance with Figure 2308.9.3.2. The wood structural panel sheathing shall extend up over the solid sawn or glued laminated header and shall be nailed in accordance with Figure 2308.9.3.2. A built-up header consisting of at least two 2 × 12s and fastened in accordance with Item 24 of Table 2304.9.1 shall be permitted to be used. A spacer, if used, shall be placed on the side of the built-up beam opposite the wood structural panel sheathing. The header shall extend between the inside faces of the first full-length outer studs of each panel. The clear span of the header between the inner studs of each panel shall be not less than 6 feet (1829 mm) and not more than 18 feet (5486 mm) in length. A strap with an uplift capacity of not less than 1,000 pounds (4,400 N) shall fasten the header to~~

~~the inner studs opposite the sheathing. One anchor bolt not less than $\frac{5}{8}$ inch (15.9 mm) diameter and installed in accordance with Section 2308.6 shall be provided in the center of each sill plate. The studs at each end of the panel shall have a tie-down device fastened to the foundation with an uplift capacity of not less than 4,200 pounds (18 480 N). Where a panel is located on one side of the opening, the header shall extend between the inside face of the first full-length stud of the panel and the bearing studs at the other end of the opening. A strap with an uplift capacity of not less than 1,000 pounds (4400 N) shall fasten the header to the bearing studs. The bearing studs shall also have a tie-down device fastened to the foundation with an uplift capacity of not less than 1,000 pounds (4400 N). The tie-down devices shall be an embedded strap type, installed in accordance with the manufacturer's recommendations. The panels shall be supported directly on a foundation that is continuous across the entire length of the braced wall line. This foundation shall be reinforced with not less than one No. 4 bar top and bottom. Where the continuous foundation is required to have a depth greater than 12 inches (305 mm), a minimum 12-inch by 12-inch (305 mm by 305 mm) continuous footing or turned-down slab edge is permitted at door openings in the braced wall line. This continuous footing or turned-down slab edge shall be reinforced with not less than one No. 4 bar top and bottom. This reinforcement shall be lapped not less than 15 inches (381 mm) with the reinforcement required in the continuous foundation located directly under the braced wall line.]~~

- [2. ~~In the first story of two-story buildings, each wall panel shall be braced in accordance with Item 1 above, except that each panel shall have a length of not less than 24 inches (610 mm).]~~

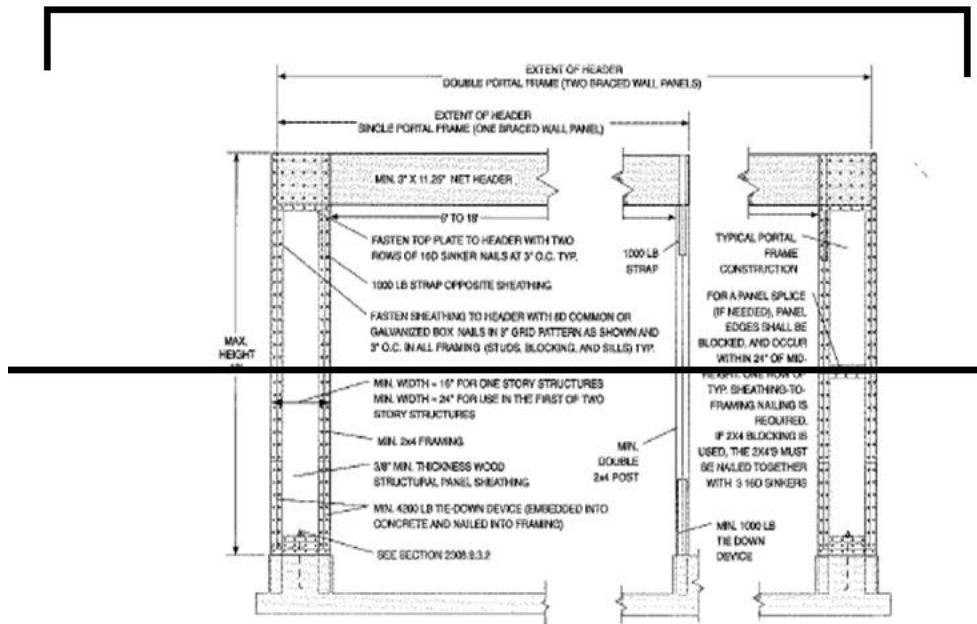

For SI: 1 foot = 304.8 mm; 1 inch = 25.4 mm; 1 pound = 4.448 N.

FIGURE 2308.9.3.2
ALTERNATE BRACED WALL PANEL ADJACENT TO A DOOR OR WINDOW OPENING

[2308.9.4 Cripple walls. Foundation cripple walls shall be framed of studs not less in size than the studding above with a minimum length of 14 inches (356mm), or shall be framed of solid blocking. Where exceeding 4 feet (1219 mm) in height, such walls shall be framed of studs having the size required for an additional story.]

[2308.9.4.1 Bracing. For the purposes of this section, cripple walls having a stud height exceeding 14 inches (356mm) shall be considered a story and shall be braced in accordance with Table 2308.9.3(1) for Seismic Design Category A, B or C. See Section 2308.12.4 for Seismic Design Category D.]

[2308.9.4.2 Nailing of bracing. Spacing of edge nailing for required wall bracing shall not exceed 6 inches (152 mm) o.c. along the foundation plate and the top plate of the cripple wall. Nail size, nail spacing for field nailing and more restrictive boundary nailing requirements shall be as required elsewhere in the code for the specific bracing material used.]

[2308.9.5 Openings in exterior walls.]

**[TABLE 2308.9.5
 HEADER AND GIRDER SPANS^a FOR EXTERIOR BEARING WALLS
 (Maximum Spans for Douglas Fir-Larch, Hem-Fir, Southern Pine and Spruce-Pine-Fir^b and Required
 Number of Jack Studs)**

HEADERS SUPPORTING	SIZE	GROUND SNOW LOAD (psf) ^c											
		30						50					
		Building width ^e (feet)											
		20		28		36		20		28		36	
Span	NJ ^d	Span	NJ ^d	Span	NJ ^d	Span	NJ ^d	Span	NJ ^d	Span	NJ ^d		
Roof & Ceiling	2-2x4	3-6	1	3-2	1	2-10	1	3-2	1	2-9	1	2-6	1
	2-2x6	5-5	1	4-8	1	4-2	1	4-8	1	4-1	1	3-8	2
	2-2x8	6-10	1	5-11	2	5-4	2	5-11	2	5-2	2	4-7	2
	2-2x10	8-5	2	7-3	2	6-6	2	7-3	2	6-3	2	5-7	2
	2-2x12	9-9	2	8-5	2	7-6	2	8-5	2	7-3	2	6-6	2
	3-2x8	8-4	1	7-5	1	6-8	1	7-5	1	6-5	2	5-9	2
	3-2x10	10-6	1	9-1	2	8-2	2	9-1	2	7-10	2	7-0	2
	3-2x12	12-2	2	10-7	2	9-5	2	10-7	2	9-2	2	8-2	2
	4-2x8	9-2	1	8-4	1	7-8	1	8-4	1	7-5	1	6-8	1
	4-2x10	11-8	1	10-6	1	9-5	2	10-6	1	9-1	2	8-2	2
4-2x12	14-1	1	12-2	2	10-11	2	12-2	2	10-7	2	9-5	2	
Roof, Ceiling & 1 Center-Bearing Floor	2-2x4	3-1	1	2-9	1	2-5	1	2-9	1	2-5	1	2-2	1
	2-2x6	4-6	1	4-0	1	3-7	2	4-1	1	3-7	2	3-3	2
	2-2x8	5-9	2	5-0	2	4-6	2	5-2	2	4-6	2	4-1	2
	2-2x10	7-0	2	6-2	2	5-6	2	6-4	2	5-6	2	5-0	2
	2-2x12	8-1	2	7-1	2	6-5	2	7-4	2	6-5	2	5-9	3
	3-2x8	7-2	1	6-3	2	5-8	2	6-5	2	5-8	2	5-1	2
	3-2x10	8-9	2	7-8	2	6-11	2	7-11	2	6-11	2	6-3	2
	3-2x12	10-2	2	8-11	2	8-0	2	9-2	2	8-0	2	7-3	2
	4-2x8	8-1	1	7-3	1	6-7	1	7-5	1	6-6	1	5-11	2
	4-2x10	10-1	1	8-10	2	8-0	2	9-1	2	8-0	2	7-2	2
4-2x12	11-9	2	10-3	2	9-3	2	10-7	2	9-3	2	8-4	2	
Roof, Ceiling & 1 Clear Span Floor	2-2x4	2-8	1	2-4	1	2-1	1	2-7	1	2-3	1	2-0	1
	2-2x6	3-11	1	3-5	2	3-0	2	3-10	2	3-4	2	3-0	2
	2-2x8	5-0	2	4-4	2	3-10	2	4-10	2	4-2	2	3-9	2
	2-2x10	6-1	2	5-3	2	4-8	2	5-11	2	5-1	2	4-7	3
	2-2x12	7-1	2	6-1	3	5-5	3	6-10	2	5-11	3	5-4	3
	3-2x8	6-3	2	5-5	2	4-10	2	6-1	2	5-3	2	4-8	2
	3-2x10	7-7	2	6-7	2	5-11	2	7-5	2	6-5	2	5-9	2
	3-2x12	8-10	2	7-8	2	6-10	2	8-7	2	7-5	2	6-8	2
	4-2x8	7-2	1	6-3	2	5-7	2	7-0	1	6-1	2	5-5	2
	4-2x10	8-9	2	7-7	2	6-10	2	8-7	2	7-5	2	6-7	2
4-2x12	10-2	2	8-10	2	7-11	2	9-11	2	8-7	2	7-8	2	
Roof, Ceiling & 2 Center-Bearing Floors	2-2x4	2-7	1	2-3	1	2-0	1	2-6	1	2-2	1	1-11	1
	2-2x6	3-9	2	3-3	2	2-11	2	3-8	2	3-2	2	2-10	2
	2-2x8	4-9	2	4-2	2	3-9	2	4-7	2	4-0	2	3-8	2
	2-2x10	5-9	2	5-1	2	4-7	3	5-8	2	4-11	2	4-5	3
	2-2x12	6-8	2	5-10	3	5-3	3	6-6	2	5-9	3	5-2	3
	3-2x8	5-11	2	5-2	2	4-8	2	5-9	2	5-1	2	4-7	2
	3-2x10	7-3	2	6-4	2	5-8	2	7-1	2	6-2	2	5-7	2
	3-2x12	8-5	2	7-4	2	6-7	2	8-2	2	7-2	2	6-5	3
	4-2x8	6-10	1	6-0	2	5-5	2	6-8	1	5-10	2	5-3	2
	4-2x10	8-4	2	7-4	2	6-7	2	8-2	2	7-2	2	6-5	2
4-2x12	9-8	2	8-6	2	7-8	2	9-5	2	8-3	2	7-5	2	
Roof, Ceiling & 2 Clear Span Floors	2-2x4	2-1	1	1-8	1	1-6	2	2-0	1	1-8	1	1-5	2
	2-2x6	3-1	2	2-8	2	2-4	2	3-0	2	2-7	2	2-3	2
	2-2x8	3-10	2	3-4	2	3-0	3	3-10	2	3-4	2	2-11	3
	2-2x10	4-9	2	4-1	3	3-8	3	4-8	2	4-0	3	3-7	3
	2-2x12	5-6	3	4-9	3	4-3	3	5-5	3	4-8	3	4-2	3
	3-2x8	4-10	2	4-2	2	3-9	2	4-9	2	4-1	2	3-8	2
	3-2x10	5-11	2	5-1	2	4-7	3	5-10	2	5-0	2	4-6	3
	3-2x12	6-10	2	5-11	3	5-4	3	6-9	2	5-10	3	5-3	3
	4-2x8	5-7	2	4-10	2	4-4	2	5-6	2	4-9	2	4-3	2
	4-2x10	6-10	2	5-11	2	5-3	2	6-9	2	5-10	2	5-2	2
4-2x12	7-11	2	6-10	2	6-2	3	7-9	2	6-9	2	6-0	3	

For SI: 1 inch = 25.4 mm, 1 foot = 304.8 mm, 1 pound per square foot = 47.8 N/m².
 a. Spans are given in feet and inches (ft-in).
 b. Tabulated values are for No. 2 grade lumber.
 c. Building width is measured perpendicular to the ridge. For widths between those shown, spans are permitted to be interpolated.
 d. NJ - Number of jack studs required to support each end. Where the number of required jack studs equals one, the header is permitted to be supported by an approved framing anchor attached to the full height wall stud and to the header.
 e. Use 30 pounds per square foot ground snow load for cases in which ground snow load is less than 30 pounds per square foot and the roof live load is equal to or less than 20 pounds per square foot.]

[2308.9.5.1 Headers. Headers shall be provided over each opening in exterior bearing walls. The spans in Table 2308.9.5 are permitted to be used for one and two family dwellings. Headers for other buildings shall be designed in accordance with Section 2301.2, Item 1 or 2. Headers shall be of two pieces of nominal 2-inch (51 mm) framing lumber set on edge as permitted by Table 2308.9.5 and nailed together in accordance with Table 2304.9.1 or of solid lumber of equivalent size.]

[2308.9.5.2 Header support. Wall studs shall support the ends of the header in accordance with Table 2308.9.5 Each end of a lintel or header shall have a length of bearing of not less than 1½ inches (38 mm) for the full width of the lintel.]

[2308.9.6] 2308.5.5.2 Openings in interior bearing partitions. Headers shall be provided over each opening in interior bearing partitions as required in Section [2308.9.5] 2308.5.5.1. The spans in Table [2308.9.6] 2308.4.1.1(2) are permitted to be used. Wall studs shall support the ends of the header in accordance with Table [2308.9.5] 2308.4.1.1(1) or [2308.9.6] 2308.4.1.1(2), as [appropriate] applicable.

**[TABLE 2308.9.6
HEADER AND GIRDER SPANS^a FOR INTERIOR BEARING WALLS
(Maximum Spans for Douglas Fir-Larch, Hem-Fir, Southern Pine and Spruce-Pine-Fir^b and Required
Number of Jack Studs)**

HEADERS AND GIRDERS SUPPORTING	SIZE	BUILDING WIDTH ^c (feet)					
		20		28		36	
		Span	NJ ^d	Span	NJ ^d	Span	NJ ^d
One Floor Only	2-2x4	3-1	1	2-8	1	2-5	1
	2-2x6	4-6	1	3-11	1	3-6	1
	2-2x8	5-9	1	5-0	2	4-5	2
	2-2x10	7-0	2	6-1	2	5-5	2
	2-2x12	8-1	2	7-0	2	6-3	2
	3-2x8	7-2	1	6-3	1	5-7	2
	3-2x10	8-9	1	7-7	2	6-9	2
	3-2x12	10-2	2	8-10	2	7-10	2
	4-2x8	9-0	1	7-8	1	6-9	1
4-2x10	10-1	1	8-9	1	7-10	2	
4-2x12	11-9	1	10-2	2	9-1	2	
Two Floors	2-2x4	2-2	1	1-10	1	1-7	1
	2-2x6	3-2	2	2-9	2	2-5	2
	2-2x8	4-1	2	3-6	2	3-2	2
	2-2x10	4-11	2	4-3	2	3-10	3
	2-2x12	5-9	2	5-0	3	4-5	3
	3-2x8	5-1	2	4-5	2	3-11	2
	3-2x10	6-2	2	5-4	2	4-10	2
	3-2x12	7-2	2	6-3	2	5-7	3
	4-2x8	6-1	1	5-3	2	4-8	2
4-2x10	7-2	2	6-2	2	5-6	2	
4-2x12	8-4	2	7-2	2	6-5	2	

For SI: 1 inch = 25.4 mm, 1 foot = 304.8 mm.

a. Spans are given in feet and inches (ft-in).

b. Tabulated values are for No. 2 grade lumber.

c. Building width is measured perpendicular to the ridge. For widths between those shown, spans are permitted to be interpolated.

d. NJ = Number of jack studs required to support each end. Where the number of required jack studs equals one, the headers are permitted to be supported by an approved framing anchor attached to the full height wall stud and to the header.]

[2308.9.7] 2308.5.5.3 Openings in interior [nonbearing] nonload-bearing partitions. Openings in [nonbearing] nonload-bearing partitions are permitted to be framed with single studs and headers. Each end of a lintel or header shall have a [length-of] bearing length of not less than 1½ inches (38 mm) for the full width of the lintel.

~~[2308.9.8 Pipes in walls. Stud partitions containing plumbing, heating or other pipes shall be so framed and the joists underneath so spaced as to give proper clearance for the piping. Where a partition containing such piping runs parallel to the floor joists, the joists underneath such partitions shall be doubled and spaced to permit the passage of such pipes and shall be bridged. Where plumbing, heating or other pipes are placed in or partly in a partition, necessitating the cutting of the soles or plates, a metal tie not less than 0.058 inch (1.47 mm) (16 galvanized gage) and 1½ inches (38 mm) wide shall be fastened to each plate across and to each side of the opening with not less than six 16d nails.]~~

2308.5.6 Cripple walls. Foundation cripple walls shall be framed of studs that are not less than the size of the studding above and not less than 14 inches (356 mm) in length, or shall be framed of solid blocking. Where exceeding 4 feet (1219 mm) in height, such walls shall be framed of studs having the size required for an additional story. See Section 2308.6.6 for cripple wall bracing.

~~[2308.9.9]~~ 2308.5.7 Bridging. Unless covered by interior or exterior wall coverings or sheathing meeting the minimum requirements of this code, stud partitions or walls with studs having a height-to-least-thickness ratio exceeding 50 shall have bridging that is not less than 2 inches (51 mm) in thickness and of the same width as the studs fitted snugly and nailed thereto to provide adequate lateral support. Bridging shall be placed in every stud cavity and at a frequency such that no stud so braced shall have a height-to-least-thickness ratio exceeding 50 with the height of the stud measured between horizontal framing and bridging or between bridging, whichever is greater.

2308.5.8 Pipes in walls. Stud partitions containing plumbing, heating or other pipes shall be framed and the joists underneath spaced to provide proper clearance for the piping. Where a partition containing piping runs parallel to the floor joists, the joists underneath such partitions shall be doubled and spaced to permit the passage of pipes and shall be bridged. Where plumbing, heating or other pipes are placed in, or partly in, a partition, necessitating the cutting of the soles or plates, a metal tie not less than 0.058 inch (1.47 mm) (16 galvanized gage) and 1½ inches (38 mm) in width shall be fastened to each plate across and to each side of the opening a minimum of 6 inches (152 mm) with not less than six 16d nails. See Figure 2308.5.8.

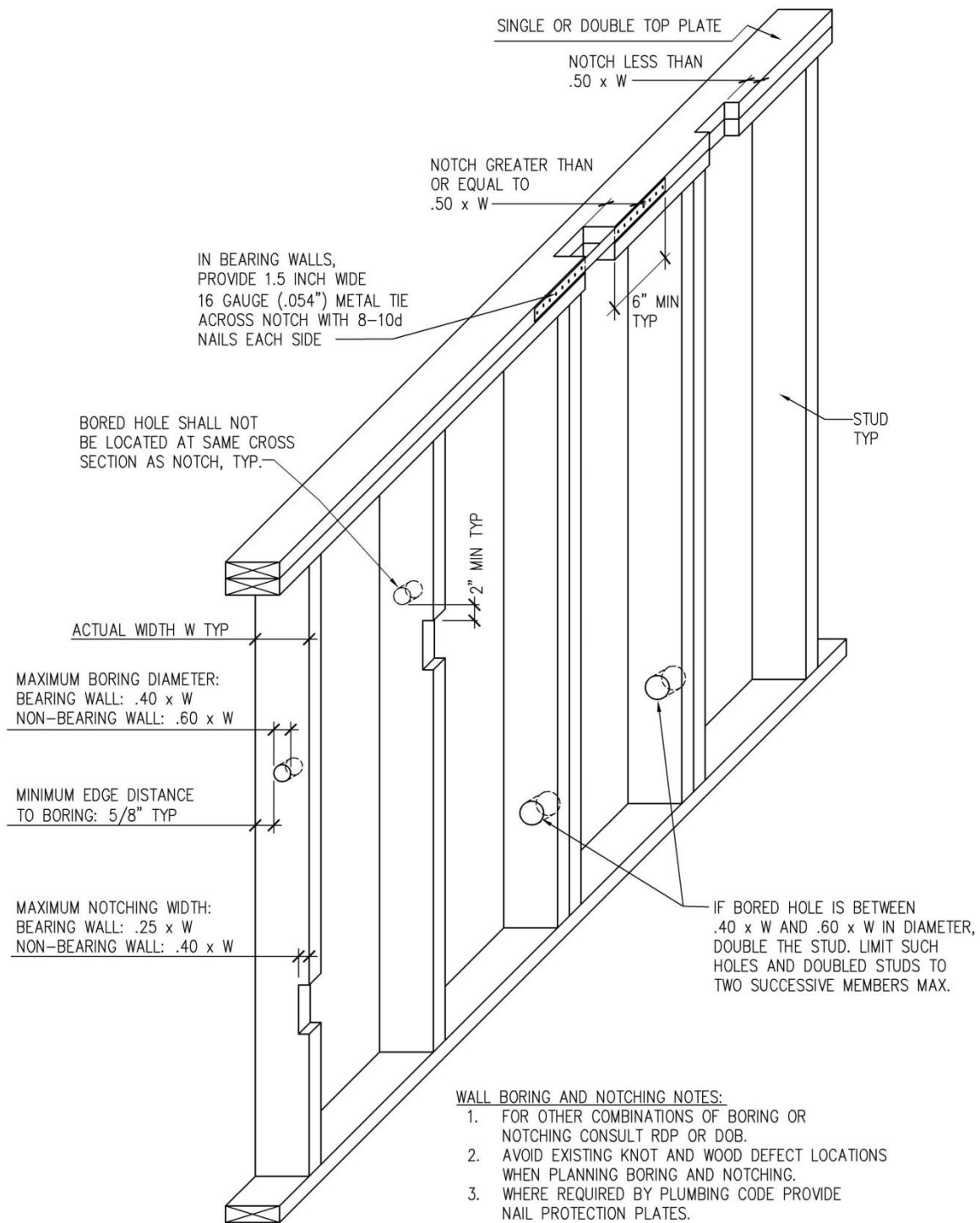

FIGURE 2308.5.8 WALL BORING AND NOTCHING LIMITS

NOT TO SCALE

[2308.9.10] 2308.5.9 Cutting and notching. In exterior walls and bearing partitions, ~~[any]~~ wood ~~[stud is]~~ studs are permitted to be cut or notched to a depth not exceeding 25 percent of ~~[its]~~ the

width of the stud. Cutting or notching of studs to a depth not greater than 40 percent of the width of the stud is permitted in ~~[nonbearing]~~ nonload-bearing partitions supporting no loads other than the weight of the partition. See Figure 2308.5.8.

~~[2308.9.11]~~ **2308.5.10 Bored holes.** ~~[A hole]~~ Bored holes not greater ~~[in diameter]~~ than 40 percent of the stud width ~~[is]~~ are permitted to be bored in any wood stud. Bored holes not greater than 60 percent of the stud width ~~[of the stud]~~ are permitted in ~~[nonbearing]~~ nonload-bearing partitions or in any wall where each bored stud is doubled, provided not more than two such successive doubled studs are so bored. In no case shall the edge of ~~[the]~~ a bored hole be nearer than 5/8 inch (15.9 mm) to the edge of the stud. Bored holes shall not be located at the same section of stud as a cut or notch. See Figure 2308.5.8.

2308.5.11 Exterior wall sheathing. Except where stucco construction that complies with Section 2510 is installed, the outside of exterior walls of enclosed buildings, including gables, shall be sheathed with one of the materials of the minimum thickness specified in Table 2308.5.11. Fasteners shall be used that are designed in accordance with the requirements of Section 2304.10 or accepted engineering practice. Alternatively, sheathing materials and fasteners complying with Section 2304.6 shall be permitted.

**TABLE 2308.5.11
MINIMUM THICKNESS OF WALL SHEATHING**

<u>SHEATHING TYPE</u>	<u>MINIMUM THICKNESS</u>	<u>MAXIMUM WALL STUD SPACING</u>
Diagonal wood boards	5/8 inch	24 inches on center
Structural fiberboard	1/2 inch	16 inches on center
Wood structural panel	In accordance with Tables 2308.6.3(2) and 2308.6.3(3)	=
M-S "Exterior Glue" and M-2 "Exterior Glue" particleboard	In accordance with Section 2306.3 and Table 2308.6.3(4)	=
Gypsum sheathing	1/2 inch	16 inches on center
Reinforced cement mortar	1 inch	24 inches on center
Hardboard panel siding	In accordance with Table 2308.6.3(5)	=

For SI: 1 inch = 25.4 mm.

2308.6 Wall bracing. Buildings shall be provided with exterior and interior braced wall lines as described in Sections 2308.6.1 through 2308.6.10.2.



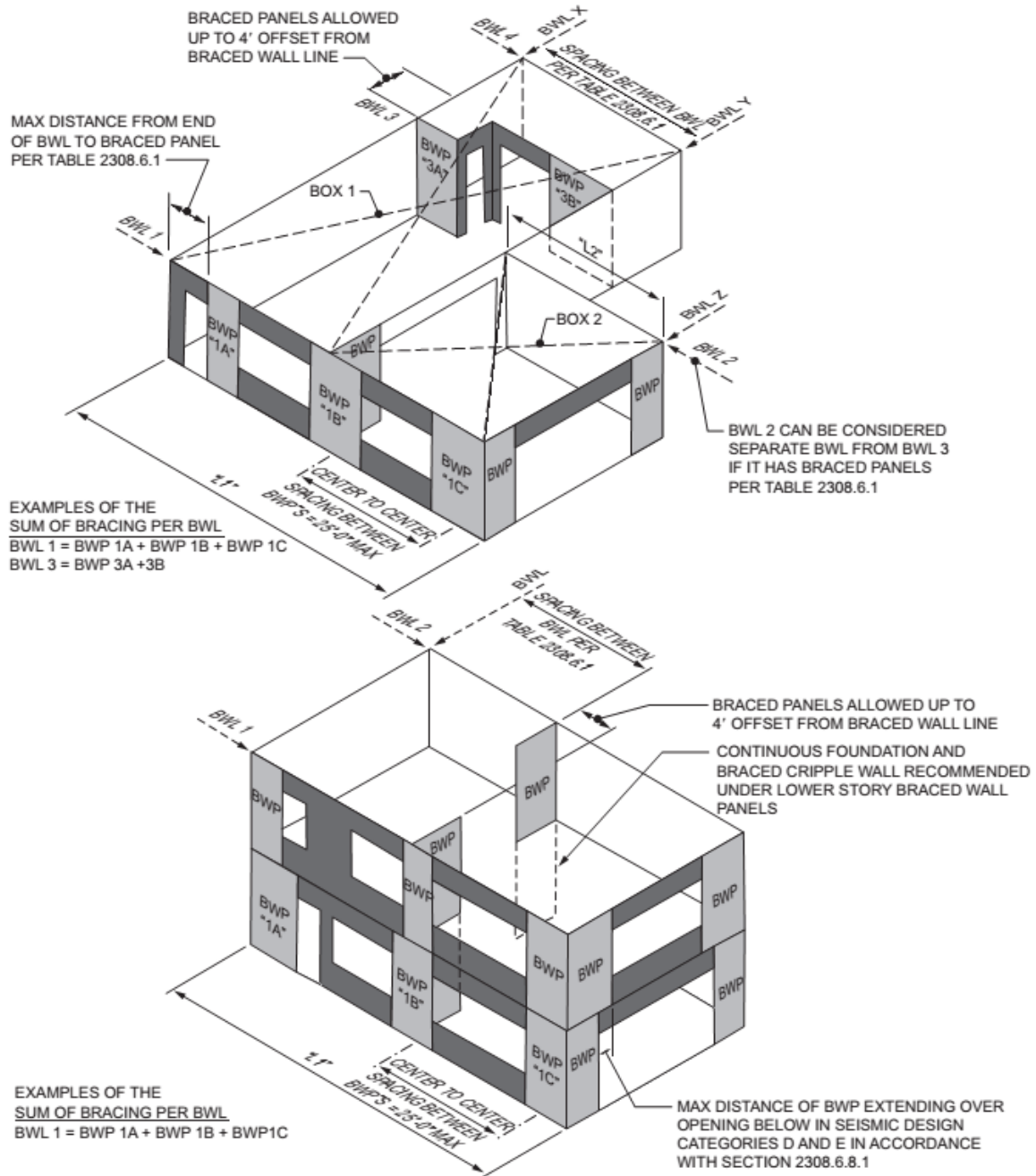

2308.6.1 Braced wall lines. For the purpose of determining the amount and location of bracing required along each story level of a building, braced wall lines shall be designated as straight lines through the building plan in both the longitudinal and transverse direction and placed in accordance with Table 2308.6.1 and Figure 2308.6.1. Braced wall line spacing shall not exceed the distance specified in Table 2308.6.1. In structures assigned to Seismic Design Category D, braced wall lines shall intersect perpendicularly to each other.

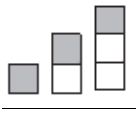

For SI: 1 foot = 304.8 mm.

FIGURE 2308.6.1
BASIC COMPONENTS OF THE LATERAL BRACING SYSTEM

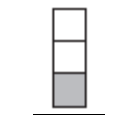
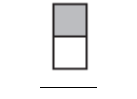
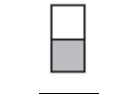
TABLE 2308.6.1^A
WALL BRACING REQUIREMENTS

<u>SEISMIC DESIGN CATEGORY</u>	<u>STORY CONDITION (SEE SECTION 2308.2)</u>	<u>MAXIMUM SPACING OF BRACED WALL LINES</u>	<u>BRACED PANEL LOCATION, SPACING (O.C.) AND MINIMUM PERCENTAGE (X)</u>			<u>MAXIMUM DISTANCE OF BRACED WALL PANELS FROM EACH END OF BRACED WALL LINE</u>
			<u>Bracing method^b</u>			
			<u>LIB</u>	<u>DWB, WSP</u>	<u>SFB, PBS, PCP, HPS, GB^{c,d}</u>	
A and B		35'- 0"	Each end and ≤ 25'- 0" o.c.	Each end and ≤ 25'- 0" o.c.	Each end and ≤ 25'- 0" o.c.	12'- 6"
		35'- 0"	Each end and ≤ 25'- 0" o.c.	Each end and ≤ 25'- 0" o.c.	Each end and ≤ 25'- 0" o.c.	12'- 6"
		35'- 0"	NP	Each end and ≤ 25'- 0" o.c.	Each end and ≤ 25'- 0" o.c.	12'- 6"
C		35'- 0"	NP	Each end and ≤ 25'- 0" o.c.	Each end and ≤ 25'- 0" o.c.	12'- 6"
		35'- 0"	NP	Each end and ≤ 25'- 0" o.c. (minimum 25% of wall length) ^e	Each end and ≤ 25'- 0" o.c. (minimum 25% of wall length) ^e	12'- 6"
D		25'- 0"	NP	$S_{DS} < 0.50$: Each end and ≤ 25'- 0" o.c. (minimum 21% of wall length) ^e	$S_{DS} < 0.50$: Each end and ≤ 25'- 0" o.c. (minimum 43% of wall length) ^e	8'- 0"
				$0.5 \leq S_{DS} < 0.75$: Each end and ≤ 25'- 0" o.c. (minimum 32% of wall length) ^e	$0.5 \leq S_{DS} < 0.75$: Each end and ≤ 25'- 0" o.c. (minimum 59% of wall length) ^e	
				$0.75 \leq S_{DS} \leq 1.00$: Each end and ≤ 25'- 0" o.c. (minimum 37% of wall length) ^e	$0.75 \leq S_{DS} \leq 1.00$: Each end and ≤ 25'- 0" o.c. (minimum 75% of wall length) ^e	
				$S_{DS} > 1.00$: Each end and ≤ 25'- 0" o.c. (minimum 48% of wall length) ^e	$S_{DS} > 1.00$: Each end and ≤ 25'- 0" o.c. (minimum 100% of wall length) ^e	

For SI: 1 inch = 25.4 mm, 1 foot = 304.8 mm.



NP = Not Permitted.

- a. This table specifies minimum requirements for braced wall panels along interior or exterior braced wall lines.
- b. See Section 2308.6.3 for full description of bracing methods.
- c. For Method GB, gypsum wallboard applied to framing supports that are spaced at 16 inches on center.
- d. The required lengths shall be doubled for gypsum board applied to only one face of a braced wall panel.
- e. Percentage shown represents the minimum amount of bracing required along the building length (or wall length if the structure has an irregular shape).

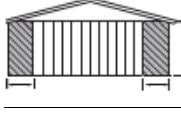

2308.6.2 Braced wall panels. Braced wall panels shall be placed along braced wall lines in accordance with Table 2308.6.1 and Figure 2308.6.1 and as specified in Table 2308.6.3(1). A braced wall panel shall be located at each end of the braced wall line and at the corners of intersecting braced wall lines or shall begin within the maximum distance from the end of the braced wall line in accordance with Table 2308.6.1. Braced wall panels in a braced wall line shall not be offset from each other by more than 4 feet (1219 mm). Braced wall panels shall be clearly indicated on the plans.

2308.6.3 Braced wall panel methods. Construction of braced wall panels shall be by one or a combination of the methods in Table 2308.6.3(1). Braced wall panel length shall be in accordance with Section 2308.6.4 or 2308.6.5.

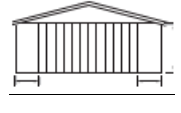
**TABLE 2308.6.3(1)
BRACING METHODS**

<u>METHODS, MATERIAL</u>	<u>MINIMUM THICKNESS</u>	<u>FIGURE</u>	<u>CONNECTION CRITERIA^a</u>	
			<u>Fasteners</u>	<u>Spacing</u>
LIB ^a Let-in-bracing	1" × 4" wood or approved metal straps attached at 45° to 60° angles to studs at maximum of 16" o.c.		Table 2304.10.1	Wood: per stud plus top and bottom plates
			Metal strap: installed in accordance with manufacturer's recommendations	Metal strap: installed in accordance with manufacturer's recommendations
DWB Diagonal wood boards	¾" thick (1" nominal) × 6" minimum width to studs at maximum of 24" o.c.		Table 2304.10.1	Per stud
WSP Wood structural panel	¾" in accordance with Table 2308.6.3(2) or 2308.6.3(3)		Table 2304.10.1	6" edges 12" field
SFB Structural fiberboard sheathing	½" in accordance with Table 2304.10.1 to studs at maximum 16" o.c.		Table 2304.10.1	3" edges 6" field
GB Gypsum board (Double sided)	½" or ⅝" by a minimum of 4" wide to studs at maximum of 24" o.c.		Section 2506.2 for exterior and interior sheathing: 5d annual ringed cooler nails (1⅝" × 0.086") or 1¼" screws (Type W or S) for ½" gypsum board or 1⅝" screws (Type W or S) for ⅝" gypsum board	For all braced wall panel locations: 7" o.c. along panel edges (including top and bottom plates) and 7" o.c. in the field

**TABLE 2308.6.3(1)
BRACING METHODS**

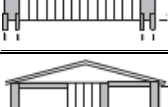
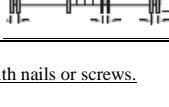
<u>METHODS, MATERIAL</u>	<u>MINIMUM THICKNESS</u>	<u>FIGURE</u>	<u>CONNECTION CRITERIA^a</u>	
			<u>Fasteners</u>	<u>Spacing</u>
PBS Particleboard sheathing	$\frac{3}{8}$ " or $\frac{1}{2}$ " in accordance with Table 2308.6.3(4) to studs at maximum of 16" o.c.		6d common (2" long \times 0.113" dia.) nails for $\frac{3}{8}$ " thick sheathing or 8d common (2½" long \times 0.131" dia.) nails for $\frac{1}{2}$ " thick sheathing	3" edges 6" field
PCP Portland cement plaster	Section 2510 to studs at maximum of 16" o.c.		1½" long, 11 gage, $\frac{7}{16}$ " dia. head nails or $\frac{7}{8}$ " long, 16 gage staples	6" o.c. on all framing members
HPS Hardboard panel siding	$\frac{7}{16}$ " in accordance with Table 2308.6.3(5)		Table 2304.10.1	4" edges 8" field
ABW Alternate braced wall	$\frac{3}{8}$ "		Figure 2308.6.5.1 and Section 2308.6.5.1	Figure 2308.6.5.1
PFH Portal frame with hold-downs	$\frac{3}{8}$ "		Figure 2308.6.5.2 and Section 2308.6.5.2	Figure 2308.6.5.2

For SI: 1 foot = 304.8 mm, 1 degree = 0.01745 rad.

a. Method LIB shall have gypsum board fastened to at least one side with nails or screws.

**TABLE 2308.6.3(2)
EXPOSED PLYWOOD PANEL SIDING**

<u>MINIMUM THICKNESS^a (inch)</u>	<u>MINIMUM NUMBER OF PLYS</u>	<u>STUD SPACING (inches) Plywood siding applied directly to studs or over sheathing</u>
$\frac{3}{8}$	3	16 ^b
$\frac{1}{2}$	4	24

For SI: 1 inch = 25.4 mm.

a. Thickness of grooved panels is measured at bottom of grooves.

b. Spans are permitted to be 24 inches if plywood siding is applied with face grain perpendicular to studs or over one of the following: (1) 1-inch board sheathing, (2) $\frac{7}{16}$ -inch wood structural panel sheathing or (3) $\frac{3}{8}$ -inch wood structural panel sheathing with strength axis (which is the long direction of the panel unless otherwise marked) of sheathing perpendicular to studs.

**TABLE 2308.6.3(3)
WOOD STRUCTURAL PANEL WALL SHEATHING^b**

(Not Exposed to the Weather, Strength Axis Parallel or Perpendicular to Studs Except as Indicated Below)

<u>MINIMUM THICKNESS (inch)</u>	<u>PANEL SPAN RATING</u>	<u>Siding nailed to studs</u>	<u>STUD SPACING (inches)</u>	
			<u>Available sheathing</u>	
			<u>Sheathing parallel to studs</u>	<u>Sheathing perpendicular to studs</u>
$\frac{3}{8}, \frac{15}{32}, \frac{1}{2}$	16/0, 20/0, 24/0, 32/16 Wall—24" o.c.	24	16	24
$\frac{7}{16}, \frac{15}{32}, \frac{1}{2}$	24/0, 24/16, 32/16 Wall—24" o.c.	24	24 ^a	24

For SI: 1 inch = 25.4 mm.

a. Plywood shall consist of four or more plies.

b. Blocking of horizontal joints shall not be required except as specified in Section 2308.6.4.

TABLE 2308.6.3(4)
ALLOWABLE SPANS FOR PARTICLEBOARD WALL SHEATHING
(Not Exposed to the Weather, Long Dimension of the Panel Parallel or Perpendicular to Studs)

<u>GRADE</u>	<u>THICKNESS (inch)</u>	<u>STUD SPACING (inches)</u>	
		<u>Siding nailed to studs</u>	<u>Sheathing under coverings specified in Section 2308.6.3 parallel or perpendicular to studs</u>
M-S "Exterior Glue" and M-2 "Exterior Glue"	$\frac{3}{8}$	<u>16</u>	<u>—</u>
	$\frac{1}{2}$	<u>16</u>	<u>16</u>

For SI: 1 inch = 25.4 mm.

**TABLE 2308.6.3(5)
HARDBOARD SIDING**

SIDING	MINIMUM NOMINAL THICKNESS (inch)	2 × 4 FRAMING MAXIMUM SPACING	NAIL SIZE ^{a, b, d}	NAIL SPACING	
				General	Bracing panels ^c
1. Lap siding					
Direct to studs	$\frac{3}{8}$	16" o.c.	8d	16" o.c.	Not applicable
Over sheathing	$\frac{3}{8}$	16" o.c.	10d	16" o.c.	Not applicable
2. Square edge panel siding					
Direct to studs	$\frac{3}{8}$	24" o.c.	6d	6" o.c. edges; 12" o.c. at intermediate supports	4" o.c. edges; 8" o.c. at intermediate supports
Over sheathing	$\frac{3}{8}$	24" o.c.	8d	6" o.c. edges; 12" o.c. at intermediate supports	4" o.c. edges; 8" o.c. at intermediate supports
3. Shiplap edge panel siding					
Direct to studs	$\frac{3}{8}$	16" o.c.	6d	6" o.c. edges; 12" o.c. at intermediate supports	4" o.c. edges; 8" o.c. at intermediate supports
Over sheathing	$\frac{3}{8}$	16" o.c.	8d	6" o.c. edges; 12" o.c. at intermediate supports	4" o.c. edges; 8" o.c. at intermediate supports

For SI: 1 inch = 25.4 mm.

a. Nails shall be corrosion resistant.

b. Minimum acceptable nail dimensions:

	Panel Siding (inch)	Lap Siding (inch)
Shank diameter	0.092	0.099
Head diameter	0.225	0.240

c. Where used to comply with Section 2308.6.

d. Nail length must accommodate the sheathing and penetrate framing 1½ inches.

2308.6.4 Braced wall panel construction. For Methods DWB, WSP, SFB, PBS, PCP and HPS, each panel must be not less than 48 inches (1219 mm) in length, covering three stud spaces where studs are spaced 16 inches (406 mm) on center and covering two stud spaces where studs are spaced 24 inches (610 mm) on center. Braced wall panels less than 48 inches (1219 mm) in length shall not contribute toward the amount of required bracing. Braced wall panels that are longer than the required length shall be credited for their actual length. For Method GB, each panel must be not less than 96 inches (2438 mm) in length where applied to one side of the studs or 48 inches (1219 mm) in length where applied to both sides.

Vertical joints of panel sheathing shall occur over studs and adjacent panel joints shall be nailed to common framing members. Horizontal joints shall occur over blocking or other framing equal in size to the studding except where waived by the installation requirements for the specific sheathing materials. Sole plates shall be nailed to the floor framing in accordance with Section 2308.6.7 and top plates shall be connected to the framing above in accordance with Section 2308.6.7.2. Where joists are perpendicular to braced wall lines above, blocking shall be provided under and in line with the braced wall panels.

2308.6.5 Alternative bracing. An alternate braced wall (ABW) or a portal frame with hold-downs (PFH) described in this section is permitted to substitute for a 48-inch (1219 mm) braced wall panel of Method DWB, WSP, SFB, PBS, PCP or HPS. For Method GB, each 96-inch (2438 mm) section (applied to one face) or 48-inch (1219 mm) section (applied to both faces) or portion thereof required by Table 2308.6.1 is permitted to be replaced by one panel constructed in accordance with Method ABW or PFH.

2308.6.5.1 Alternate braced wall (ABW). An ABW shall be constructed in accordance with this section and Figure 2308.6.5.1. In one-story buildings, each panel shall have a length of not less than 2 feet 8 inches (813 mm) and a height of not more than 10 feet (3048 mm). Each panel shall be sheathed on one face with $\frac{3}{8}$ -inch (3.2 mm) minimum-thickness wood structural panel sheathing nailed with 8d common or galvanized box nails in accordance with Table 2304.10.1 and blocked at wood structural panel edges. Two anchor bolts installed in accordance with Section 2308.3.1 shall be provided in each panel. Anchor bolts shall be placed at each panel outside quarter points. Each panel end stud shall have a hold-down device fastened to the foundation, capable of providing an approved allowable uplift capacity of not less than 1,800 pounds (8006 N). The hold-down device shall be installed in accordance with the manufacturer's recommendations. The ABW shall be supported directly on a foundation or on floor framing supported directly on a foundation that is continuous across the entire length of the braced wall line. This foundation shall be reinforced with not less than one No. 4 bar top and bottom. Where the continuous foundation is required to have a depth greater than 12 inches (305 mm), a minimum 12-inch by 12-inch (305 mm by 305 mm) continuous footing or turned-down slab edge is permitted at door openings in the braced wall line. This continuous footing or turned-down slab edge shall be reinforced with not less than one No. 4 bar top and bottom. This reinforcement shall be lapped 15 inches (381 mm) with the reinforcement required in the continuous foundation located directly under the braced wall line.

Where the ABW is installed at the first story of two-story buildings, the wood structural panel sheathing shall be provided on both faces, three anchor bolts shall be placed at one-quarter points, and tie-down device allowable uplift capacity shall be not less than 3,000 pounds (13 344 N).

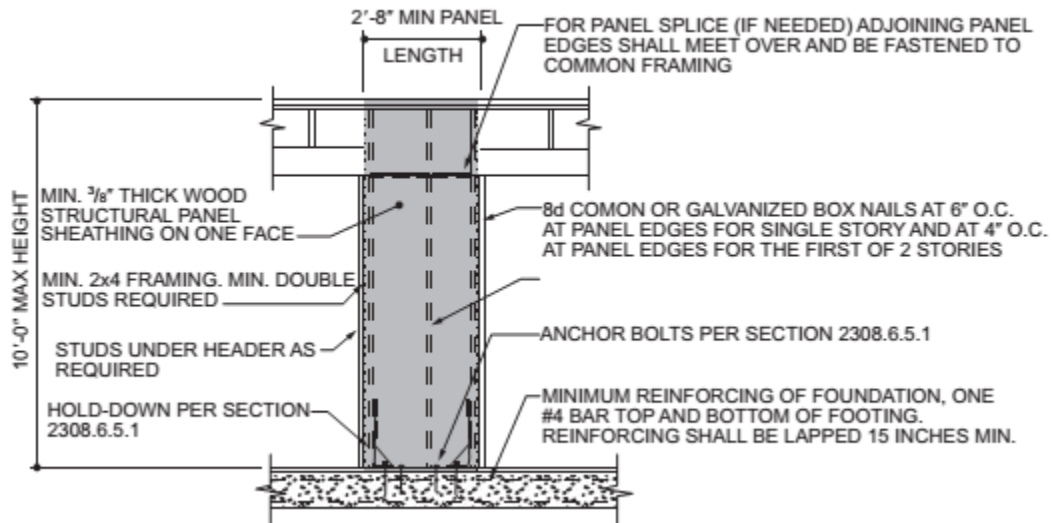

For SI: 1 inch = 25.4 mm, 1 foot = 304.8 mm.

FIGURE 2308.6.5.1
ALTERNATE BRACED WALL PANEL (ABW)

2308.6.5.2 Portal frame with hold-downs (PFH). A PFH shall be constructed in accordance with this section and Figure 2308.6.5.2. The adjacent door or window opening shall have a full-length header.

In one-story buildings, each panel shall have a length of not less than 16 inches (406 mm) and a height of not more than 10 feet (3048 mm). Each panel shall be sheathed on one face with a single layer of 3/8-inch (9.5 mm) minimum-thickness wood structural panel sheathing nailed with 8d common or galvanized box nails in accordance with Figure 2308.6.5.2. The wood structural panel sheathing shall extend up over the solid sawn or glued-laminated header and shall be nailed in accordance with Figure 2308.6.5.2. A built-up header consisting of at least two 2-inch by 12-inch (51 mm by 305 mm) boards, fastened in accordance with Item 24 of Table 2304.10.1, shall be permitted to be used. A spacer, if used, shall be placed on the side of the built-up beam opposite the wood structural panel sheathing. The header shall extend between the inside faces of the first full-length outer studs of each panel. The clear span of the header between the inner studs of each panel shall be not less than 6 feet (1829 mm) and not more than 18 feet (5486 mm) in length. A strap with an allowable uplift capacity of not less than 1,000 pounds (4400 N) shall fasten the header to the inner studs opposite the sheathing. One anchor bolt not less than 5/8 inch (15.9 mm) diameter and installed in accordance with Section 2308.3.1 shall be provided in the center of each sill plate. The studs at each end of the panel shall have a hold-down device fastened to the foundation with an allowable uplift capacity of not less than 3,500 pounds (15 570 N).

Where a panel is located on one side of the opening, the header shall extend between the inside face of the first full-length stud of the panel and the bearing studs at the other end of the opening. A strap with an allowable uplift capacity of not less than 1,000 pounds (4400 N) shall fasten the header to the bearing studs. The bearing studs shall also have a hold-down device fastened to the foundation with an allowable uplift capacity of not less than 1,000 pounds (4400 N). The hold-down devices shall be an embedded strap type, installed in accordance with the manufacturer's recommendations. The PFH panels shall be supported directly on a foundation that is continuous across the entire length of the braced wall line. This foundation shall be reinforced with not less than one No. 4 bar top and bottom. Where the continuous foundation is required to have a depth greater than 12 inches (305 mm), a minimum 12-inch by 12-inch (305 mm by 305 mm) continuous footing or turned-down slab edge is permitted at door openings in the braced wall line. This continuous footing or turned-down slab edge shall be reinforced with not less than one No. 4 bar top and bottom. This reinforcement shall be lapped not less than 15 inches (381 mm) with the reinforcement required in the continuous foundation located directly under the braced wall line.

Where a PFH is installed at the first story of two-story buildings, each panel shall have a length of not less than 24 inches (610 mm).

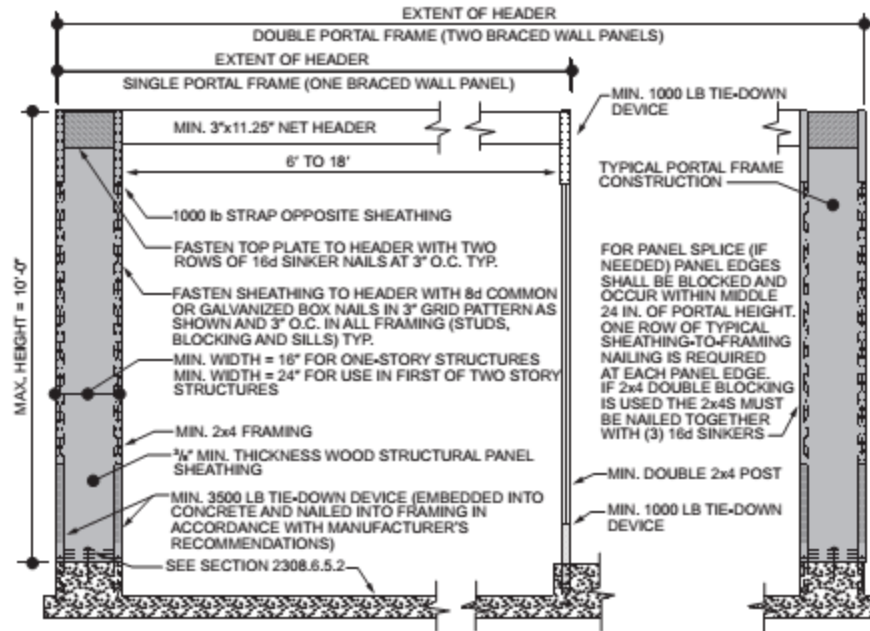

For SI: 1 inch = 25.4 mm, 1 foot = 304.8 mm, 1 pound = 4.448 N.

FIGURE 2308.6.5.2
PORTAL FRAME WITH HOLD-DOWNS (PFH)

2308.6.6 Cripple wall bracing. Cripple walls shall be braced in accordance with Section 2308.6.6.1 or 2308.6.6.2.

2308.6.6.1 Cripple wall bracing in Seismic Design Categories A, B and C. For the purposes of this section, cripple walls in Seismic Design Categories A, B and C having a stud height exceeding 14 inches (356 mm) shall be considered a story and shall be braced in accordance with Table 2308.6.1. Spacing of edge nailing for required cripple wall bracing shall not exceed 6 inches (152 mm) on center along the foundation plate and the top plate of the cripple wall. Nail size, nail spacing for field nailing and more restrictive boundary nailing requirements shall be as required elsewhere in the code for the specific bracing material used.

2308.6.6.2 Cripple wall bracing in Seismic Design Category D. For the purposes of this section, cripple walls in Seismic Design Category D having a stud height exceeding 14 inches (356 mm) shall be considered a story and shall be braced in accordance with Table 2308.6.1. Where interior braced wall lines occur without a continuous foundation below, the length of parallel exterior cripple wall bracing shall be one and one-half times the lengths required by Table 2308.6.1. Where the cripple wall sheathing type used is Method WSP or DWB and this additional length of bracing cannot be provided, the capacity of WSP or DWB sheathing shall be increased by reducing the spacing of fasteners along the perimeter of each piece of sheathing to 4 inches (102 mm) on center.

2308.6.7 Connections of braced wall panels. Braced wall panel joints shall occur over studs or blocking. Braced wall panels shall be fastened to studs, top and bottom plates and at panel edges. Braced wall panels shall be applied to nominal 2-inch-wide (actual 1½-inch (38 mm)) or larger stud framing.

2308.6.7.1 Bottom plate connection. Braced wall line bottom plates shall be connected to joists or full-depth blocking below in accordance with Table 2304.10.1, or to foundations in accordance with Section 2308.6.7.3.

2308.6.7.2 Top plate connection. Where joists or rafters are used, braced wall line top plates shall be fastened over the full length of the braced wall line to joists, rafters, rim boards or full-depth blocking above in accordance with Table 2304.10.1, as applicable, based on the orientation of the joists or rafters to the braced wall line. Blocking shall be not less than 2 inches (51 mm) in nominal thickness and shall be fastened to the braced wall line top plate as specified in Table 2304.10.1. Notching or drilling of holes in blocking in accordance with the requirements of Section 2308.4.2.4 or 2308.7.4 shall be permitted.

At exterior gable end walls, braced wall panel sheathing in the top story shall be extended and fastened to the roof framing where the spacing between parallel exterior braced wall lines is greater than 50 feet (15 240 mm).

Where roof trusses are used and are installed perpendicular to an exterior braced wall line, lateral forces shall be transferred from the roof diaphragm to the braced wall over the full length of the braced wall line by blocking of the ends of the trusses or by other approved methods providing equivalent lateral force transfer. Blocking shall be not less than 2 inches (51 mm) in nominal thickness and equal to the depth of the truss at the wall line and shall be fastened to the braced wall line top plate as specified in Table 2304.10.1. Notching or drilling of holes in blocking in accordance with the requirements of Section 2308.4.2.4 or 2308.7.4 shall be permitted.

Exception: Where the roof sheathing is greater than 9¼ inches (235 mm) above the top plate, solid blocking is not required where the framing members are connected using one of the following methods:

1. In accordance with Figure 2308.6.7.2(1).
2. In accordance with Figure 2308.6.7.2(2).
3. Full-height engineered blocking panels designed for values listed in AWC WFCM.
4. A design in accordance with accepted engineering methods.

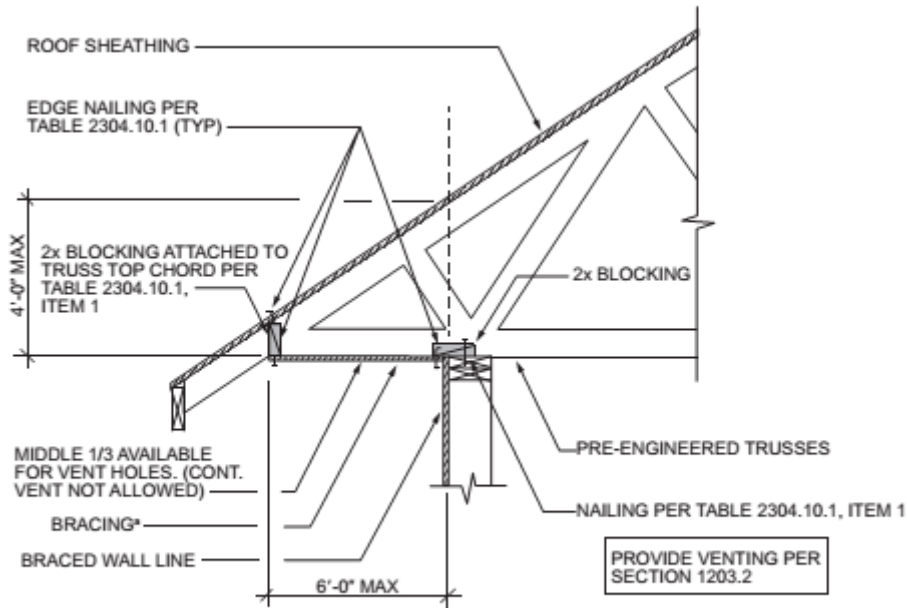

a. Methods of bracing shall be as described in Table 2308.6.3(1) DWB, WSP, SFB, GB, PBS, PCP or HPS.

For SI: 1 foot = 304.8 mm.

FIGURE 2308.6.7.2(1)
BRACED WALL LINE TOP PLATE CONNECTION

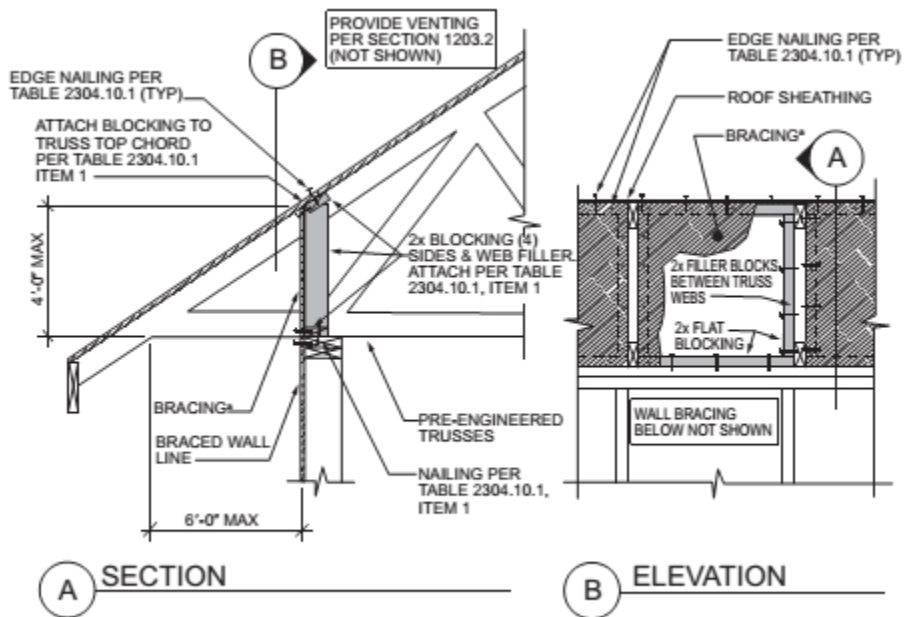

a. Methods of bracing shall be as described in Table 2308.6.3(1) DWB, WSP, SFB, GB, PBS, PCP or HPS.

For SI: 1 foot = 304.8 mm.

FIGURE 2308.6.7.2(2)
BRACED WALL PANEL TOP PLATE CONNECTION

2308.6.7.3 Sill anchorage. Where foundations are required by Section 2308.6.8, braced wall line sills shall be anchored to concrete or masonry foundations. Such anchorage shall conform

to the requirements of Section 2308.3. The anchors shall be distributed along the length of the braced wall line. Other anchorage devices having equivalent capacity are permitted.

2308.6.7.4 Anchorage to all-wood foundations. Where all-wood foundations are used, the force transfer from the *braced wall lines* shall be determined based on calculation and shall have a capacity that is not less than the connections required by Section 2308.3.

2308.6.8 Braced wall line and diaphragm support. Braced wall lines and floor and roof diaphragms shall be supported in accordance with this section.

2308.6.8.1 Foundation requirements. Braced wall lines shall be supported by continuous foundations.

Exception: For structures with a maximum plan dimension not more than 50 feet (15 240 mm), continuous foundations are required at exterior walls only.

For structures in Seismic Design Category D, exterior braced wall panels shall be in the same plane vertically with the foundation or the portion of the structure containing the offset shall be designed in accordance with accepted engineering practice and Section 2308.1.1.

Exceptions:

1. Exterior braced wall panels shall be permitted to be located not more than 4 feet (1219 mm) from the foundation below where supported by a floor constructed in accordance with all of the following:
 - 1.1. Cantilevers or setbacks shall not exceed four times the nominal depth of the floor joists.
 - 1.2. Floor joists shall be 2 inches by 10 inches (51 mm by 254 mm) or larger and spaced not more than 16 inches (406 mm) on center.
 - 1.3. The ratio of the back span to the cantilever shall be not less than 2 to 1.
 - 1.4. Floor joists at ends of braced wall panels shall be doubled.
 - 1.5. A continuous rim joist shall be connected to the ends of cantilevered joists. The rim joist is permitted to be spliced using a metal tie not less than 0.058 inch (1.47 mm) (16 galvanized gage), 1½ inches (38 mm) in width and 12 inches (305 mm) in length, fastened with six 16d common nails on each side. The metal tie shall have a yield stress not less than 33,000 psi (227 MPa).
 - 1.6. Joists at setbacks or the end of cantilevered joists shall not carry gravity loads from more than a single story having uniform wall and roof loads nor carry the reactions from headers having a span of 8 feet (2438 mm) or more.
2. The end of a required braced wall panel shall be allowed to extend not more than 1 foot (305 mm) over an opening in the wall below. This requirement is applicable to braced wall panels offset in plane and braced wall panels offset out of plane as

permitted by Exception 1. Braced wall panels are permitted to extend over an opening not more than 8 feet (2438 mm) in width where the header is a 4-inch by 12-inch (102 mm by 305 mm) or larger member.

2308.6.8.2 Floor and roof diaphragm support in Seismic Design Category D. In structures assigned to Seismic Design Category D, floor and roof diaphragms shall be laterally supported by braced wall lines on all edges and connected in accordance with Section 2308.6.7 (see Figure 2308.6.8.2(1)).

Exception: Portions of roofs or floors that do not support braced wall panels above are permitted to extend up to 6 feet (1829 mm) beyond a braced wall line (see Figure 2308.6.8.2(2)) provided that the framing members are connected to the braced wall line below in accordance with Section 2308.6.7.

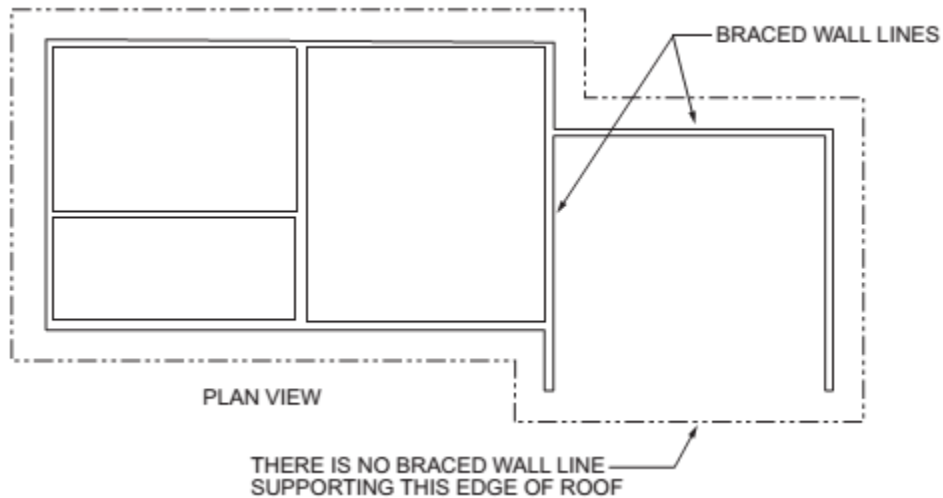
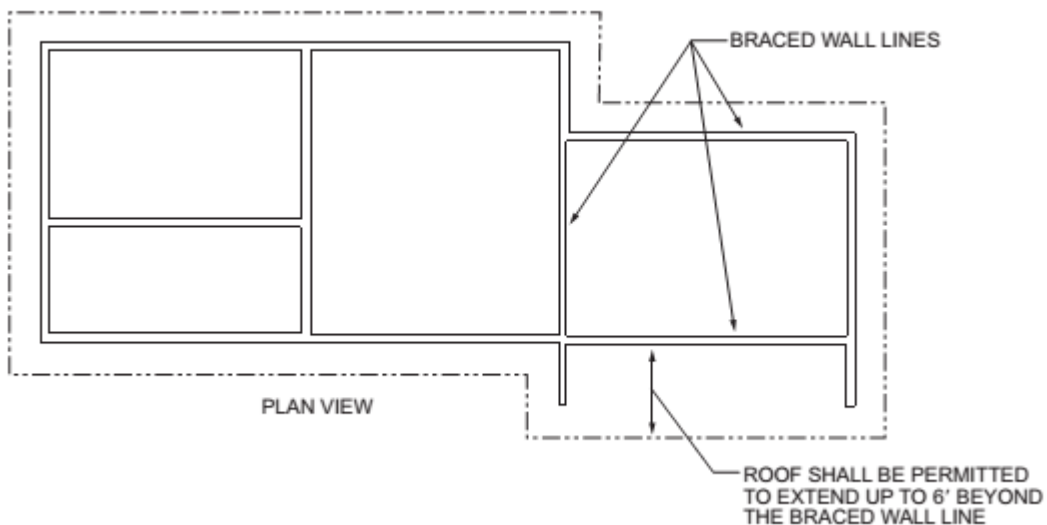

FIGURE 2308.6.8.2(1)
ROOF IN SDC D NOT SUPPORTED ON ALL EDGES



For SI: 1 foot = 304.8 mm.

FIGURE 2308.6.8.2(2)
ROOF EXTENSION IN SDC D BEYOND BRACED WALL LINE

2308.6.8.3 Stepped footings in Seismic Design Categories B, C and D. In Seismic Design Categories B, C and D, where the height of a required braced wall panel extending from foundation to floor above varies more than 4 feet (1219 mm), the following construction shall be used:

1. Where the bottom of the footing is stepped and the lowest floor framing rests directly on a sill bolted to the footings, the sill shall be anchored as required in Section 2308.3.
2. Where the lowest floor framing rests directly on a sill bolted to a footing not less than 8 feet (2438 mm) in length along a line of bracing, the line shall be considered to be braced. The double plate of the cripple stud wall beyond the segment of footing extending to the lowest framed floor shall be spliced to the sill plate with metal ties, one on each side of the sill and plate. The metal ties shall be not less than 0.058 inch (1.47 mm) (16 galvanized gage) by 1½ inches (38 mm) in width by 48 inches (1219 mm) with eight 16d common nails on each side of the splice location (see Figure 2308.6.8.3). The metal tie shall have a yield stress not less than 33,000 psi (227 MPa).
3. Where cripple walls occur between the top of the footing and the lowest floor framing, the bracing requirements for a story shall apply.

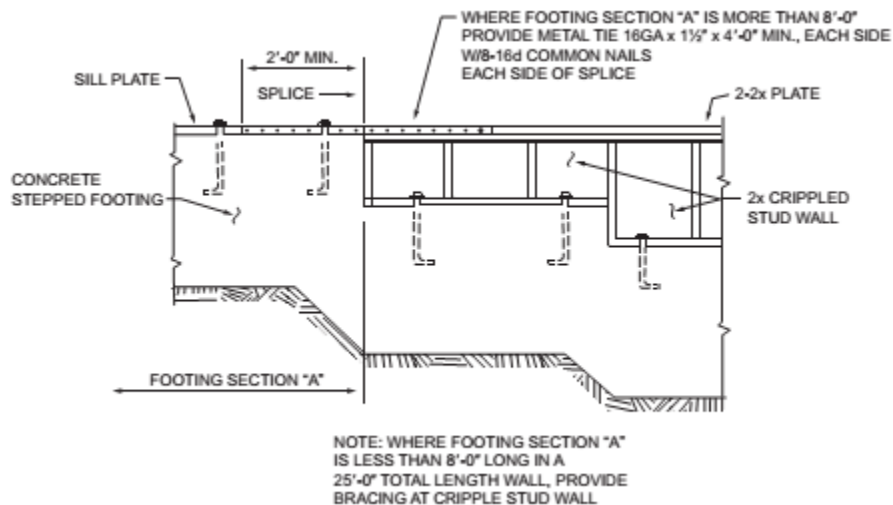

For SI: 1 inch = 25.4 mm, 1 foot = 304.8 mm.

FIGURE 2308.6.8.3
STEPPED FOOTING CONNECTION DETAILS

2308.6.9 Attachment of sheathing. Fastening of braced wall panel sheathing shall be not less than that prescribed in Tables 2308.6.1 and 2304.10.1. Wall sheathing shall not be attached to framing members by adhesives.

2308.6.10 Limitations of concrete or masonry veneer. Concrete or masonry veneer shall comply with Chapter 14 and this section.

2308.6.10.1 Limitations of concrete or masonry veneer in Seismic Design Categories B and C. In Seismic Design Categories B and C, concrete or masonry walls and stone or masonry veneer shall not extend above a basement.

Exceptions:

1. In structures assigned to Seismic Design Category B, stone and masonry veneer is permitted to be used in the first two stories above grade plane or the first three stories above grade plane where the lowest story has concrete or masonry walls, provided that wood structural panel wall bracing is used and the length of bracing provided is one and one-half times the required length specified in Table 2308.6.1.
2. Stone and masonry veneer is permitted to be used in the first story above grade plane or the first two stories above grade plane where the lowest story has concrete or masonry walls.
3. Stone and masonry veneer is permitted to be used in both stories of buildings with two stories above grade plane, provided the following criteria are met:
 - 3.1. Type of brace in accordance with Section 2308.6.1 shall be WSP and the allowable shear capacity in accordance with Section 2306.3 shall be not less than 350 plf (5108 N/m).
 - 3.2. Braced wall panels in the second story shall be located in accordance with Section 2308.6.1 and not more than 25 feet (7620 mm) on center, and the total length of braced wall panels shall be not less than 25 percent of the braced wall line length. Braced wall panels in the first story shall be located in accordance with Section 2308.6.1 and not more than 25 feet (7620 mm) on center, and the total length of braced wall panels shall be not less than 45 percent of the braced wall line length.
 - 3.3. Hold-down connectors with an allowable capacity of 2,000 pounds (8896 N) shall be provided at the ends of each braced wall panel for the second story to the first story connection. Hold-down connectors with an allowable capacity of 3,900 pounds (17 347 N) shall be provided at the ends of each braced wall panel for the first story to the foundation connection. In all cases, the hold-down connector force shall be transferred to the foundation.
 - 3.4. Cripple walls shall not be permitted.

2308.6.10.2 Limitations of concrete or masonry in Seismic Design Category D. In Seismic Design Category D, concrete or masonry walls and stone or masonry veneer shall not extend above a basement.

Exception: Stone and masonry veneer is permitted to be used in the first story above grade plane, provided the following criteria are met:

1. Type of brace in accordance with Section 2308.6.1 shall be WSP and the allowable shear capacity in accordance with Section 2306.3 shall be not less than 350 plf (5108 N/m).
2. The braced wall panels in the first story shall be located at each end of the braced wall line and not more than 25 feet (7620 mm) on center, and the total length of braced wall panels shall be not less than 45 percent of the braced wall line length.
3. Hold-down connectors shall be provided at the ends of braced walls for the first floor to foundation with an allowable capacity of 2,100 pounds (9341 N).
4. Cripple walls shall not be permitted.

[2308.10] 2308.7 Roof and ceiling framing. The framing details required in this section apply to roofs having a [minimum] slope of not less than three units vertical in 12 units horizontal (25-percent slope)[~~or greater~~]. Where the roof slope is less than three units vertical in 12 units horizontal (25-percent slope), members supporting rafters and ceiling joists such as ridge board, hips and valleys shall be designed as beams.

[2308.10.1 Wind uplift. ~~The roof construction shall have rafter and truss ties to the wall below. Resultant uplift loads shall be transferred to the foundation using a continuous load path. The rafter or truss to wall connection shall comply with Tables 2304.9.1 and 2308.10.1.]~~

**[TABLE 2308.10.1
REQUIRED RATING OF APPROVED UPLIFT CONNECTORS (pounds)^{a,b,c,e,f,g,h}**

BASIC WIND SPEED (3-second gust)	ROOF SPAN (feet)							OVERHANGS (pounds/foot) ^d
	12	20	24	28	32	36	40	
85	-72	-120	-145	-169	-193	-217	-241	-38.55
90	-91	-151	-181	-212	-242	-272	-302	-43.22
100	-131	-281	-262	-305	-349	-393	-436	-53.36
110	-175	-292	-351	-409	-467	-526	-584	-64.56

For SI: 1 inch = 25.4 mm, 1 foot = 304.8 mm, 1 mile per hour = 1.61 km/hr, 1 pound = 0.454 Kg, 1 pound per foot = 14.5939 N/m.

a. The uplift connection requirements are based on a 30-foot mean roof height located in Exposure B. For Exposure C or D and for other mean roof heights, multiply the above loads by the adjusted coefficients below.

EXPOSURE	Mean Roof Height (feet)									
	15	20	25	30	35	40	45	50	55	60
B	1.00	1.00	1.00	1.00	1.05	1.09	1.12	1.16	1.19	1.22
C	1.21	1.29	1.35	1.40	1.45	1.49	1.53	1.56	1.59	1.62
D	1.47	1.55	1.61	1.66	1.70	1.74	1.78	1.81	1.84	1.87

b. The uplift connection requirements are based on the framing being spaced 24 inches on center. Multiply by 0.67 for framing spaced 16 inches on center and multiply by 0.5 for framing spaced 12 inches on center.

c. The uplift connection requirements include an allowance for 10 pounds of dead load.

d. The uplift connection requirements do not account for the effects of overhangs. The magnitude of the above loads shall be increased by adding the overhang loads found in the table. The overhang loads are also based on framing spaced 24 inches on center. The overhang loads given shall be multiplied by the overhang projection and added to the roof uplift value in the table.

e. The uplift connection requirements are based upon wind loading on end zones as defined in Figure 6-2 of ASCE 7. Connection loads for connections located a distance of 20 percent of the least horizontal dimension of the building from the corner of the building are permitted to be reduced by multiplying the table connection value by 0.7 and multiplying the overhang load by 0.8.

f. For wall-to-wall and wall-to-foundation connections, the capacity of the uplift connector is permitted to be reduced by 100 pounds for each full wall above. (For example, if a 500-pound-rated connector is used on the roof framing, a 400-pound-rated connector is permitted at the next floor level down).

g. Interpolation is permitted for intermediate values of basic wind speeds and roof spans.

h. The rated capacity of approved tie-down devices is permitted to include up to a 60 percent increase for wind effects where allowed by material specifications.]

~~[2308.10.2]~~ **2308.7.1** **Ceiling joist spans.** ~~[Allowable spans]~~ Spans for ceiling joists shall be in accordance with Table ~~[2308.10.2(1)]~~ 2308.7.1(1) or ~~[2308.10.2(2)]~~ 2308.7.1(2). For other grades and species, and other loading conditions, refer to the ~~[AF&PA Span Tables for Joists and Rafters]~~ AWC STJR.

TABLE [2308.10.2(4)] 2308.7.1(1)
CEILING JOIST SPANS FOR COMMON LUMBER SPECIES
(Uninhabitable Attics Without Storage, Live Load = 10 [pounds per square foot] psf, L/Δ = 240)

CEILING JOIST SPACING (inches)	SPECIES AND GRADE	DEAD LOAD = 5 [pounds per square foot] psf			
		2 × 4	2 × 6	2 × 8	2 × 10
		Maximum ceiling joist spans			
		(ft. – in.)	(ft. – in.)	(ft. – in.)	(ft. – in.)
12	Douglas Fir-Larch SS	13-2	20-8	Note a	Note a
	Douglas Fir-Larch #1	12-8	19-11	Note a	Note a
	Douglas Fir-Larch #2	12-5	19-6	25-8	Note a
	Douglas Fir-Larch #3	10-10	15-10	20-1	24-6
	Hem-Fir SS	12-5	19-6	25-8	Note a
	Hem-Fir #1	12-2	19-1	25-2	Note a
	Hem-Fir #2	11-7	18-2	24-0	Note a
	Hem-Fir #3	10-10	15-10	20-1	24-6
	Southern Pine SS	12-11	20-3	Note a	Note a
	Southern Pine #1	[12-8] 12-5	[19-11] 19-6	[Note a] 25-8	Note a
	Southern Pine #2	[12-5] 11-10	[19-6] 18-8	[25-8] 24-7	Note a
	Southern Pine #3	[11-6] 10-1	[17-0] 14-11	[21-8] 18-9	[25-7] 22-9
	Spruce-Pine-Fir SS	12-2	19-1	25-2	Note a
	Spruce-Pine-Fir #1	11-10	18-8	24-7	Note a
	Spruce-Pine-Fir #2	11-10	18-8	24-7	Note a
	Spruce-Pine-Fir #3	10-10	15-10	20-1	24-6
16	Douglas Fir-Larch SS	11-11	18-9	24-8	Note a
	Douglas Fir-Larch #1	11-6	18-1	23-10	Note a
	Douglas Fir-Larch #2	11-3	17-8	23-0	Note a
	Douglas Fir-Larch #3	9-5	13-9	17-5	21-3
	Hem-Fir SS	11-3	17-8	23-4	Note a
	Hem-Fir #1	11-0	17-4	22-10	Note a
	Hem-Fir #2	10-6	16-6	21-9	Note a
	Hem-Fir #3	9-5	13-9	17-5	21-3
	Southern Pine SS	11-9	18-5	24-3	Note a
	Southern Pine #1	[11-6] 11-3	[18-1] 17-8	[23-1] 23-4	Note a
	Southern Pine #2	[11-3] 10-9	[17-8] 16-11	[23-4] 21-7	[Note a] 25-7
	Southern Pine #3	[10-0] 8-9	[14-9] 12-11	[18-9] 16-3	[22-2] 19-9
	Spruce-Pine-Fir SS	11-0	17-4	22-10	Note a
	Spruce-Pine-Fir #1	10-9	16-11	22-4	Note a
	Spruce-Pine-Fir #2	10-9	16-11	22-4	Note a
	Spruce-Pine-Fir #3	9-5	13-9	17-5	21-3
19.2	Douglas Fir-Larch SS	11-3	17-8	23-3	Note a
	Douglas Fir-Larch #1	10-10	17-0	22-5	Note a
	Douglas Fir-Larch #2	10-7	16-7	21-0	25-8
	Douglas Fir-Larch #3	8-7	12-6	15-10	19-5
	Hem-Fir SS	10-7	16-8	21-11	Note a
	Hem-Fir #1	10-4	16-4	21-6	Note a
	Hem-Fir #2	9-11	15-7	20-6	25-3
	Hem-Fir #3	8-7	12-6	15-10	19-5
	Southern Pine SS	11-0	17-4	22-10	Note a
	Southern Pine #1	[10-10] 10-7	[17-0] 16-8	[22-5] 22-0	Note a
	Southern Pine #2	[10-7] 10-2	[16-8] 15-7	[21-11] 19-8	[Note a] 23-5
	Southern Pine #3	[9-1] 8-0	[13-6] 11-9	[17-2] 14-10	[20-3] 18-0
	Spruce-Pine-Fir SS	10-4	16-4	21-6	Note a
	Spruce-Pine-Fir #1	10-2	15-11	21-0	25-8
	Spruce-Pine-Fir #2	10-2	15-11	21-0	25-8
	Spruce-Pine-Fir #3	8-7	12-6	15-10	19-5
24	Douglas Fir-Larch SS	10-5	16-4	21-7	Note a
	Douglas Fir-Larch #1	10-0	15-9	20-1	24-6
	Douglas Fir-Larch #2	9-10	14-10	18-9	22-11
	Douglas Fir-Larch #3	7-8	11-2	14-2	17-4

TABLE [2308.10.2(1)] 2308.7.1(1)
CEILING JOIST SPANS FOR COMMON LUMBER SPECIES
(Uninhabitable Attics Without Storage, Live Load = 10 [pounds per square foot] psf, L/Δ = 240)

CEILING JOIST SPACING (inches)	SPECIES AND GRADE	DEAD LOAD = 5 [pounds per square foot] psf			
		2 × 4	2 × 6	2 × 8	2 × 10
		Maximum ceiling joist spans			
		(ft. – in.)	(ft. – in.)	(ft. – in.)	(ft. – in.)
	Hem-Fir SS	9-10	15-6	20-5	Note a
	Hem-Fir #1	9-8	15-2	19-7	23-11
	Hem-Fir #2	9-2	14-5	18-6	22-7
	Hem-Fir #3	7-8	11-2	14-2	17-4
	Southern Pine SS	10-3	16-1	21-2	Note a
	Southern Pine #1	[10-0] 9-10	[15-9] 15-6	[20-10] 20-5	[Note a] 24-0
	Southern Pine #2	[9-10] 9-3	[15-6] 13-11	[20-1] 17-7	[23-11] 20-11
	Southern Pine #3	[8-2] 7-2	[12-0] 10-6	[15-4] 13-3	[18-1] 16-1
	Spruce-Pine-Fir SS	9-8	15-2	19-11	25-5
	Spruce-Pine-Fir #1	9-5	14-9	18-9	22-11
	Spruce-Pine-Fir #2	9-5	14-9	18-9	22-11
	Spruce-Pine-Fir #3	7-8	11-2	14-2	17-4

Check sources for availability of lumber in lengths greater than 20 feet.

For SI: 1 inch = 25.4 mm, 1 foot = 304.8 mm, 1 pound per square foot = [47.8 N/m²] 0.0479 kPa.

a. Span exceeds 26 feet in length. [Check sources for availability of lumber in lengths greater than 20 feet.]

TABLE [2308.10.2(2)] 2308.7.1(2)
CEILING JOIST SPANS FOR COMMON LUMBER SPECIES
(Uninhabitable Attics With Limited Storage, Live Load = 20 [pounds per square foot] psf, L/Δ = 240)

CEILING JOIST SPACING (inches)	SPECIES AND GRADE	DEAD LOAD = 10 [pounds per square foot] psf			
		2 × 4	2 × 6	2 × 8	2 × 10
		Maximum ceiling joist spans			
		(ft. – in.)	(ft. – in.)	(ft. – in.)	(ft. – in.)
12	Douglas Fir-Larch SS	10-5	16-4	21-7	Note a
	Douglas Fir-Larch #1	10-0	15-9	20-1	24-6
	Douglas Fir-Larch #2	9-10	14-10	18-9	22-11
	Douglas Fir-Larch #3	7-8	11-2	14-2	17-4
	Hem-Fir SS	9-10	15-6	20-5	Note a
	Hem-Fir #1	9-8	15-2	19-7	23-11
	Hem-Fir #2	9-2	14-5	18-6	22-7
	Hem-Fir #3	7-8	11-2	14-2	17-4
	Southern Pine SS	10-3	16-1	21-2	Note a
	Southern Pine #1	[10-0] 9-10	[15-9] 15-6	[20-10] 20-5	[Note a] 24-0
	Southern Pine #2	[9-10] 9-3	[15-6] 13-11	[20-1] 17-7	[23-11] 20-11
	Southern Pine #3	[8-2] 7-2	[12-0] 10-6	[15-4] 13-3	[18-1] 16-1
	Spruce-Pine-Fir SS	9-8	15-2	19-11	25-5
	Spruce-Pine-Fir #1	9-5	14-9	18-9	22-11
	Spruce-Pine-Fir #2	9-5	14-9	18-9	22-11
Spruce-Pine-Fir #3	7-8	11-2	14-2	17-4	
16	Douglas Fir-Larch SS	9-6	14-11	19-7	25-0
	Douglas Fir-Larch #1	9-1	13-9	17-5	21-3
	Douglas Fir-Larch #2	8-9	12-10	16-3	19-10
	Douglas Fir-Larch #3	6-8	9-8	12-4	15-0
	Hem-Fir SS	8-11	14-1	18-6	23-8
	Hem-Fir #1	8-9	13-5	16-10	20-8
	Hem-Fir #2	8-4	12-8	16-0	19-7
	Hem-Fir #3	6-8	9-8	12-4	15-0
	Southern Pine SS	9-4	14-7	19-3	24-7
	Southern Pine #1	[9-1] 8-11	[14-4] 14-0	[18-11] 17-9	[23-1] 20-9
	Southern Pine #2	[8-11] 8-0	[13-6] 12-0	[17-5] 15-3	[20-9] 18-1
	Southern Pine #3	[7-1] 6-2	[10-5] 9-2	[13-3] 11-6	[15-8] 14-0
	Spruce-Pine-Fir SS	8-9	13-9	18-1	23-1
	Spruce-Pine-Fir #1	8-7	12-10	16-3	19-10

TABLE [2308.10.2(2)] 2308.7.1(2)
CEILING JOIST SPANS FOR COMMON LUMBER SPECIES
(Uninhabitable Attics With Limited Storage, Live Load = 20 [pounds per square foot] psf, L/Δ = 240)

CEILING JOIST SPACING (inches)	SPECIES AND GRADE	DEAD LOAD = 10 [pounds per square foot] psf			
		2 × 4	2 × 6	2 × 8	2 × 10
		Maximum ceiling joist spans			
		(ft. – in.)	(ft. – in.)	(ft. – in.)	(ft. – in.)
19.2	Spruce-Pine-Fir #2	8-7	12-10	16-3	19-10
	Spruce-Pine-Fir #3	6-8	9-8	12-4	15-0
19.2	Douglas Fir-Larch SS	8-11	14-0	18-5	23-4
	Douglas Fir-Larch #1	8-7	12-6	15-10	19-5
	Douglas Fir-Larch #2	8-0	11-9	14-10	18-2
	Douglas Fir-Larch #3	6-1	8-10	11-3	13-8
	Hem-Fir SS	8-5	13-3	17-5	22-3
	Hem-Fir #1	8-3	12-3	15-6	18-11
	Hem-Fir #2	7-10	11-7	14-8	17-10
	Hem-Fir #3	6-1	8-10	11-3	13-8
	Southern Pine SS	8-9	13-9	[18-1] 18-2	23-1
	Southern Pine #1	[8-7] 8-5	[13-6] 12-9	[17-9] 16-2	[21-1] 18-11
	Southern Pine #2	[8-5] 7-4	[12-3] 11-0	[15-10] 13-11	[18-11] 16-6
	Southern Pine #3	[6-5] 5-8	[9-6] 8-4	[12-1] 10-6	[14-4] 12-9
	Spruce-Pine-Fir SS	8-3	12-11	17-1	21-8
	Spruce-Pine-Fir #1	8-0	11-9	14-10	18-2
	Spruce-Pine-Fir #2	8-0	11-9	14-10	18-2
Spruce-Pine-Fir #3	6-1	8-10	11-3	13-8	
24	Douglas Fir-Larch SS	8-3	13-0	17-1	20-11
	Douglas Fir-Larch #1	7-8	11-2	14-2	17-4
	Douglas Fir-Larch #2	7-2	10-6	13-3	16-3
	Douglas Fir-Larch #3	5-5	7-11	10-0	12-3
	Hem-Fir SS	7-10	12-3	16-2	20-6
	Hem-Fir #1	7-6	10-11	13-10	16-11
	Hem-Fir #2	7-1	10-4	13-1	16-0
	Hem-Fir #3	5-5	7-11	10-0	12-3
	Southern Pine SS	8-1	12-9	16-10	21-6
	Southern Pine #1	[8-0] 7-8	[12-6] 11-5	[15-10] 14-6	[18-10] 16-11
	Southern Pine #2	[7-8] 6-7	[11-0] 9-10	[14-2] 12-6	[16-11] 14-9
	Southern Pine #3	[5-9] 5-1	[8-6] 7-5	[10-10] 9-5	[12-10] 11-5
	Spruce-Pine-Fir SS	7-8	12-0	15-10	19-5
	Spruce-Pine-Fir #1	7-2	10-6	13-3	16-3
	Spruce-Pine-Fir #2	7-2	10-6	13-3	16-3
Spruce-Pine-Fir #3	5-5	7-11	10-0	12-3	

Check sources for availability of lumber in lengths greater than 20 feet.

For SI: 1 inch = 25.4 mm, 1 foot = 304.8 mm, 1 pound per square foot = [47.8 N/m²] 0.0479 kPa.

a. Span exceeds 26 feet in length. [Check sources for availability of lumber in lengths greater than 20 feet.]

[2308.10.3] 2308.7.2 Rafter spans. [Allowable spans] Spans for rafters shall be in accordance with Table [2308.10.3(1)] 2308.7.2(1), [2308.10.3(2)] 2308.7.2(2), [2308.10.3(3)] 2308.7.2(3), [2308.10.3(4)] 2308.7.2(4), [2308.10.3(5)] 2308.7.2(5), or [2308.10.3(6)] 2308.7.2(6). For other grades and species and other loading conditions, refer to the [AF&PA Span Tables for Joists and Rafters] AWC STJR. The span of each rafter shall be measured along the horizontal projection of the rafter.

TABLE [2308.10.3(1)] 2308.7.2(1)
RAFTER SPANS FOR COMMON LUMBER SPECIES

(Roof Live Load = 20 [pounds per square foot] psf, Ceiling Not Attached to Rafters, L/Δ = 180)

RAFTER SPACING (inches)	SPECIES AND GRADE	DEAD LOAD = 10 [pounds per square foot] psf				DEAD LOAD = 20 [pounds per square foot] psf					
		2 × 4	2 × 6	2 × 8	2 × 10	2 × 4	2 × 6	2 × 8	2 × 10	2 × 12	
		Maximum rafter spans ^a									
		(ft. – in.)	(ft. – in.)	(ft. – in.)	(ft. – in.)	(ft. – in.)	(ft. – in.)	(ft. – in.)	(ft. – in.)	(ft. – in.)	(ft. – in.)
12	Douglas Fir-Larch SS	11-6	18-0	23-9	Note [a]b	Note [a]b	11-6	18-0	18-0	Note [a]b	Note [a]b
	Douglas Fir-Larch #1	11-1	17-4	22-5	Note [a]b	Note [a]b	10-6	15-4	15-4	23-9	Note [a]b
	Douglas Fir-Larch #2	10-10	16-7	21-0	25-8	Note [a]b	9-10	14-4	18-2	22-3	25-9
	Douglas Fir-Larch #3	8-7	12-6	15-10	19-5	22-6	7-5	10-10	13-9	16-9	19-6
	Hem-Fir SS	10-10	17-0	22-5	Note [a]b	Note [a]b	10-10	17-0	22-5	Note [a]b	Note [a]b
	Hem-Fir #1	10-7	16-8	21-10	Note [a]b	Note [a]b	10-3	14-11	18-11	23-2	Note [a]b
	Hem-Fir #2	10-1	15-11	20-8	25-3	Note [a]b	9-8	14-2	17-11	21-11	25-5
	Hem-Fir #3	8-7	12-6	15-10	19-5	22-6	7-5	10-10	13-9	16-9	19-6
	Southern Pine SS	11-3	17-8	23-4	Note [a]b	Note [a]b	11-3	17-8	23-4	Note [a]b	Note [a]b
	Southern Pine #1	[11-1] 10-10	[17-4] 17-0	[22-11] 22-5	[Note a] 26-0	[Note a] 26-0	[11-1] 10-6	[17-3] 15-8	[21-9] 19-10	[25-10] 23-2	[Note a] Note b
	Southern Pine #2	[10-10] 10-4	[17-0] 15-7	[22-5] 19-8	[Note a] 23-5	[Note a] 26-0	[10-6] 9- 0	[15-1] 13-6	[19-5] 17-1	[23-2] 20- 3	[Note a] 23-10
	Southern Pine #3	[9-1] 8-0 11-9	[13-6] 14-10	[17-2] 14-10	[20-3] 18- 0	[24-1] 21-4	[7-11] 6- 11	[11-8] 10-2	[14-10] 12-10	[17-6] 15- 7	[20-11] 18-6
	Spruce-Pine-Fir SS	10-7	16-8	21-11	Note [a]b	Note [a]b	10-7	16-8	21-9	Note [a]b	Note [a]b
	Spruce-Pine-Fir #1	10-4	16-3	21-0	25-8	Note [a]b	9-10	14-4	18-2	22-3	25-9
	Spruce-Pine-Fir #2	10-4	16-3	21-0	25-8	Note [a]b	9-10	14-4	18-2	22-3	25-9
	Spruce-Pine-Fir #3	8-7	12-6	15-10	19-5	22-6	7-5	10-10	13-9	16-9	19-6
16	Douglas Fir-Larch SS	10-5	16-4	21-7	Note [a]b	Note [a]b	10-5	16-0	20-3	24-9	Note [a]b
	Douglas Fir-Larch #1	10-0	15-4	19-5	23-9	Note [a]b	9-1	13-3	16-10	20-7	23-10
	Douglas Fir-Larch #2	9-10	14-4	18-2	22-3	25-9	8-6	12-5	15-9	19-3	22-4
	Douglas Fir-Larch #3	7-5	10-10	13-9	16-9	19-6	6-5	9-5	11-11	14-6	16-10
	Hem-Fir SS	9-10	15-6	20-5	Note [a]b	Note [a]b	9-10	15-6	19-11	24-4	Note [a]b
	Hem-Fir #1	9-8	14-11	18-11	23-2	Note [a]b	8-10	12-11	16-5	20-0	23-3
	Hem-Fir #2	9-2	14-2	17-11	21-11	25-5	8-5	12-3	15-6	18-11	22-0
	Hem-Fir #3	7-5	10-10	13-9	16-9	19-6	6-5	9-5	11-11	14-6	16-10
	Southern Pine SS	10-3	16-1	21-2	Note [a]b	Note [a]b	10-3	16-1	21-2	[Note a] 25-7	Note [a]b
	Southern Pine #1	[10-0] 9- 10	[15-9] 15-6	[20-10] 19-10	[25-10] 23-2	[Note a] 26- 0	[10-0] 9- 1	[15-0] 13-7	[18-10] 17-2	[22-4] 20- 1	[Note a] 23-10
	Southern Pine #2	[9-10] 9- 0	[15-1] 13-6	[19-5] 17-1	[23-2] 20- 3	[Note a] 23- 10	[9-1] 7-9	[13-0] 11-8	[16-10] 14-9	[20-1] 17- 6	[23-7] 20- 8
	Southern Pine #3	[7-11] 6- 11	[11-8] 10-2	[14-10] 12-10	[17-6] 15- 7	[20-11] 18-6	[6-10] 6- 0	[10-1] 8- 10	[12-10] 11-2	[15-2] 13- 6	[18-1] 16- 0
	Spruce-Pine-Fir SS	9-8	15-2	19-11	25-5	Note a	9-8	14-10	18-10	23-0	Note a
Spruce-Pine-Fir #1	9-5	14-4	18-2	22-3	25-9	8-6	12-5	15-9	19-3	22-4	
Spruce-Pine-Fir #2	9-5	14-4	18-2	22-3	25-9	8-6	12-5	15-9	19-3	22-4	
Spruce-Pine-Fir #3	7-5	10-10	13-9	16-9	19-6	6-5	9-5	11-11	14-6	16-10	

TABLE [2308.10.3(1)] 2308.7.2(1)

RAFTER SPANS FOR COMMON LUMBER SPECIES

(Roof Live Load = 20 [pounds per square foot] psf, Ceiling Not Attached to Rafters, L/Δ = 180)

RAFTER SPACING (inches)	SPECIES AND GRADE	DEAD LOAD = 10 [pounds per square foot] psf				DEAD LOAD = 20 [pounds per square foot] psf					
		2 × 4	2 × 6	2 × 8	2 × 10	2 × 4	2 × 6	2 × 8	2 × 10	2 × 12	
		Maximum rafter spans ^a									
		(ft. – in.)	(ft. – in.)	(ft. – in.)	(ft. – in.)	(ft. – in.)	(ft. – in.)	(ft. – in.)	(ft. – in.)	(ft. – in.)	(ft. – in.)
	#3										
19.2	Douglas Fir-Larch SS	9-10	15-5	20-4	25-11	Note [a]b	9-10	14-7	18-6	22-7	Note [a]b
	Douglas Fir-Larch #1	9-5	14-0	17-9	21-8	25-2	8-4	12-2	15-4	18-9	21-9
	Douglas Fir-Larch #2	8-11	13-1	16-7	20-3	23-6	7-9	11-4	14-4	17-7	20-4
	Douglas Fir-Larch #3	6-9	9-11	12-7	15-4	17-9	5-10	8-7	10-10	13-3	15-5
	Hem-Fir SS	9-3	14-7	19-2	24-6	Note [a]b	9-3	14-4	18-2	22-3	25-9
	Hem-Fir #1	9-1	13-8	17-4	21-1	24-6	8-1	11-10	15-0	18-4	21-3
	Hem-Fir #2	8-8	12-11	16-4	20-0	23-2	7-8	11-2	14-2	17-4	20-1
	Hem-Fir #3	6-9	9-11	12-7	15-4	17-9	5-10	8-7	10-10	13-3	15-5
	Southern Pine SS	9-8	15-2	19-11	25-5	Note [a]b	9-8	15-2	19-11	25-5	Note [a]b
	Southern Pine #1	[9-5] 9-3	[14-10] 14-3	[19-7] 18-1	[23-7] 21-2	[25-2] 25-2	[9-3] 8-4	[13-8] 12-4	[17-2] 15-8	[20-5] 18-4	[24-4] 21-9
	Southern Pine #2	[9-3] 8-2	[13-9] 12-3	[17-9] 15-7	[21-2] 18-6	[24-10] 21-9	[8-4] 7-1	[11-11] 10-8	[15-4] 13-6	[18-4] 16-0	[21-6] 18-10
	Southern Pine #3	[7-3] 6-4	[10-8] 9-4	[13-7] 11-9	[16-0] 14-3	[19-4] 16-10	[6-3] 5-6	[9-3] 8-1	[11-9] 10-2	[13-10] 12-4	[16-6] 14-7
	Spruce-Pine-Fir SS	9-1	14-3	18-9	23-11	Note [a]b	9-1	13-7	17-2	21-0	24-4
	Spruce-Pine-Fir #1	8-10	13-1	16-7	20-3	23-6	7-9	11-4	14-4	17-7	20-4
	Spruce-Pine-Fir #2	8-10	13-1	16-7	20-3	23-6	7-9	11-4	14-4	17-7	20-4
Spruce-Pine-Fir #3	6-9	9-11	12-7	15-4	17-9	5-10	8-7	10-10	13-3	15-5	
24	Douglas Fir-Larch SS	9-1	14-4	18-10	23-4	Note [a]b	8-11	13-1	16-7	20-3	23-5
	Douglas Fir-Larch #1	8-7	12-6	15-10	19-5	22-6	7-5	10-10	13-9	16-9	19-6
	Douglas Fir-Larch #2	8-0	11-9	14-10	18-2	21-0	6-11	10-2	12-10	15-8	18-3
	Douglas Fir-Larch #3	6-1	8-10	11-3	13-8	15-11	5-3	7-8	9-9	11-10	13-9
	Hem-Fir SS	8-7	13-6	17-10	22-9	Note [a]b	8-7	12-10	16-3	19-10	23-0
	Hem-Fir #1	8-4	12-3	15-6	18-11	21-11	7-3	10-7	13-5	16-4	19-0
	Hem-Fir #2	7-11	11-7	14-8	17-10	20-9	6-10	10-0	12-8	15-6	17-11
	Hem-Fir #3	6-1	8-10	11-3	13-8	15-11	5-3	7-8	9-9	11-10	13-9
	Southern Pine SS	8-11	14-1	18-6	23-8	Note [a]b	8-11	14-1	18-6	22-11	Note [a]b
	Southern Pine #1	[8-9] 8-7	[13-9] 12-9	[17-9] 16-2	[21-4] 18-11	[25-2] 22-6	[8-3] 7-5	[12-3] 11-1	[15-4] 14-0	[18-3] 16-5	[21-9] 19-6
	Southern Pine #2	[8-7] 7-4	[12-3] 11-0	[15-10] 13-11	[18-11] 16-6	[22-2] 19-6	[7-5] 6-4	[10-8] 9-2	[13-9] 12-1	[16-5] 14-4	[19-3] 16-10
	Southern Pine #3	[6-5] 5-8	[9-6] 8-4	[12-4] 10-6	[14-4] 12-9	[17-4] 15-1	[5-7] 4-2	[8-3] 7-3	[10-6] 9-1	[12-5] 11-0	[14-9] 13-1
	Spruce-Pine-Fir SS	8-5	13-3	17-5	21-8	25-2	8-4	12-2	15-4	18-9	21-9
	Spruce-Pine-Fir #1	8-0	11-9	14-10	18-2	21-0	6-11	10-2	12-10	15-8	18-3
	Spruce-Pine-Fir #2	8-0	11-9	14-10	18-2	21-0	6-11	10-2	12-10	15-8	18-3
Spruce-Pine-Fir #3	6-1	8-10	11-3	13-8	15-11	5-3	7-8	9-9	11-10	13-9	

TABLE [2308.10.3(1)] 2308.7.2(1)
RAFTER SPANS FOR COMMON LUMBER SPECIES

(Roof Live Load = 20 [pounds per square foot] psf, Ceiling Not Attached to Rafters, L/Δ = 180)

RAFTER SPACING (inches)	SPECIES AND GRADE	DEAD LOAD = 10 [pounds per square foot] psf				DEAD LOAD = 20 [pounds per square foot] psf				
		2 × 4	2 × 6	2 × 8	2 × 10	2 × 4	2 × 6	2 × 8	2 × 10	2 × 12
		Maximum rafter spans ^a								
		(ft. – in.)	(ft. – in.)	(ft. – in.)	(ft. – in.)	(ft. – in.)	(ft. – in.)	(ft. – in.)	(ft. – in.)	(ft. – in.)
#3										

Check sources for availability of lumber in lengths greater than 20 feet.

For SI: 1 inch = 25.4 mm, 1 foot = [304] 304.8 mm, 1 pound per square foot = [47.9 N/m²] 0.0479 kPa.

a. The tabulated rafter spans assume that ceiling joists are located at the bottom of the attic space or that some other method of resisting the outward push of the rafters on the bearing walls, such as rafter ties, is provided at that location. Where ceiling joists or rafter ties are located higher in the attic space, the rafter spans shall be multiplied by the following factors:

H _c /H _R	Rafter Span Adjustment Factor
1/3	0.67
1/4	0.76
1/5	0.83
1/6	0.90
1/7.5 or less	1.00

where:

H_c = Height of ceiling joists or rafter ties measured vertically above the top of the rafter support walls.

H_R = Height of roof ridge measured vertically above the top of the rafter support walls.

b. Span exceeds 26 feet in length. [Check sources for availability of lumber in lengths greater than 20 feet.]

TABLE [2308.10.3(2)] 2308.7.2(2)
RAFTER SPANS FOR COMMON LUMBER SPECIES

(Roof Live Load = 20 [pounds per square foot] psf, Ceiling [Not] Attached to Rafters, L/Δ = 240)

RAFTER SPACING (inches)	SPECIES AND GRADE	DEAD LOAD = 10 [pounds per square foot] psf				DEAD LOAD = 20 [pounds per square foot] psf					
		2 × 4	2 × 6	2 × 8	2 × 10	2 × 4	2 × 6	2 × 8	2 × 10	2 × 12	
		Maximum rafter spans ^a									
		(ft. – in.)	(ft. – in.)	(ft. – in.)	(ft. – in.)	(ft. – in.)	(ft. – in.)	(ft. – in.)	(ft. – in.)	(ft. – in.)	
12	Douglas Fir-Larch SS	10-5	16-4	21-7	Note [a]b	Note [a]b	10-5	16-4	21-7	Note [a]b	Note [a]b
	Douglas Fir-Larch #1	10-0	15-9	20-10	Note [a]b	Note [a]b	10-0	15-4	19-5	23-9	Note [a]b
	Douglas Fir-Larch #2	9-10	15-6	20-5	25-8	Note [a]b	9-10	14-4	18-2	22-3	25-9
	Douglas Fir-Larch #3	8-7	12-6	15-10	19-5	22-6	7-5	10-10	13-9	16-9	19-6
	Hem-Fir SS	9-10	15-6	20-5	Note [a]b	Note [a]b	9-10	15-6	20-5	Note [a]b	Note [a]b
	Hem-Fir #1	9-8	15-2	19-11	25-5	Note [a]b	9-8	14-11	18-11	23-2	Note [a]b
	Hem-Fir #2	9-2	14-5	19-0	24-3	Note [a]b	9-2	14-2	17-11	21-11	25-5
	Hem-Fir #3	8-7	12-6	15-10	19-5	22-6	7-5	10-10	13-9	16-9	19-6
	Southern Pine SS	10-3	16-1	21-2	Note [a]b	Note [a]b	10-3	16-1	21-2	Note [a]b	Note [a]b
	Southern Pine #1	[10-0] 9-10	[15-9] 15-6	[20-10] 20-5	[Note a] 26-0	[Note a] 26-0	[10-0] 9-10	[15-9] 15-6	[20-10] 19-10	[25-10] 23-2	[Note a] 26-0
	Southern Pine #2	[9-10] 9-5	[15-6] 14-9	[20-5] 19-6	[Note a] 23-5	[Note a] 26-0	[9-10] 9-0	[15-1] 13-6	[19-5] 17-1	[23-2] 20-3	[Note a] 23-10
	Southern Pine #3	[9-1] 8-0	[13-6] 11-9	[17-2] 14-10	[20-3] 18-0	[24-1] 21-4	[7-11] 6-11	[11-8] 10-2	[14-10] 12-10	[17-6] 15-7	[20-11] 18-6
	Spruce-Pine-Fir SS	9-8	15-2	19-11	25-5	Note [a]b	9-8	15-2	19-11	25-5	Note [a]b
	Spruce-Pine-Fir #1	9-5	14-9	19-6	24-10	Note [a]b	9-5	14-4	18-2	22-3	25-9
Spruce-Pine-Fir #2	9-5	14-9	19-6	24-10	Note [a]b	9-5	14-4	18-2	22-3	25-9	
Spruce-Pine-Fir #3	8-7	12-6	15-10	19-5	22-6	7-5	10-10	13-9	16-9	19-6	
16	Douglas Fir-Larch SS	9-6	14-11	19-7	25-0	Note [a]b	9-6	14-11	19-7	24-9	Note [a]b
	Douglas Fir-Larch #1	9-1	14-4	18-11	23-9	Note [a]b	9-1	13-3	16-10	20-7	23-10
	Douglas Fir-Larch #2	8-11	14-1	18-2	22-3	25-9	8-6	12-5	15-9	19-3	22-4
	Douglas Fir-Larch #3	7-5	10-10	13-9	16-9	19-6	6-5	9-5	11-11	14-6	16-10
	Hem-Fir SS	8-11	14-1	18-6	23-8	Note [a]b	8-11	14-1	18-6	23-8	Note [a]b
	Hem-Fir #1	8-9	13-9	18-1	23-1	Note [a]b	8-9	12-11	16-5	20-0	23-3

TABLE [2308.10.3(2)] 2308.7.2(2)
RAFTER SPANS FOR COMMON LUMBER SPECIES
(Roof Live Load = 20 [pounds per square foot] psf, Ceiling [Not] Attached to Rafters, L/Δ = 240)

RAFTER SPACING (inches)	SPECIES AND GRADE	DEAD LOAD = 10 [pounds per square foot] psf					DEAD LOAD = 20 [pounds per square foot] psf					
		2 × 4	2 × 6	2 × 8	2 × 10	2 × 12	2 × 4	2 × 6	2 × 8	2 × 10	2 × 12	
		Maximum rafter spans ^a										
		(ft. – in.)	(ft. – in.)	(ft. – in.)	(ft. – in.)	(ft. – in.)	(ft. – in.)	(ft. – in.)	(ft. – in.)	(ft. – in.)	(ft. – in.)	
	Hem-Fir #2	8-4	13-1	17-3	21-11	25-5	8-4	12-3	15-6	18-11	22-0	
	Hem-Fir #3	7-5	10-10	13-9	16-9	19-6	6-5	9-5	11-11	14-6	16-10	
	Southern Pine SS	9-4	14-7	19-3	24-7	Note [a]b	9-4	14-7	19-3	24-7	Note [a]b	
	Southern Pine #1	[9-4] 8-11	[14-4] 14-1	[18-11] 18-6	[24-1] 23-2	[Note-a] 26-0	[9-4] 8-11	[14-4] 13-7	[18-10] 17-2	[22-4] 20-1	[Note-a] 23-10	
	Southern Pine #2	[8-11] 8-7	[14-1] 13-5	[18-6] 17-1	[23-2] 20-3	[Note-a] 23-10	[8-11] 7-9	[13-0] 11-8	[16-10] 14-9	[20-1] 17-6	[23-7] 20-8	
	Southern Pine #3	[7-11] 6-11	[11-8] 10-2	[14-10] 12-10	[17-6] 15-7	[20-11] 18-6	[6-10] 6-0	[10-1] 8-10	[12-10] 11-2	[15-2] 13-6	[18-1] 16-0	
	Spruce-Pine-Fir SS	8-9	13-9	18-1	23-1	Note [a]b	8-9	13-9	18-1	23-0	Note [a]b	
	Spruce-Pine-Fir #1	8-7	13-5	17-9	22-3	25-9	8-6	12-5	15-9	19-3	22-4	
	Spruce-Pine-Fir #2	8-7	13-5	17-9	22-3	25-9	8-6	12-5	15-9	19-3	22-4	
	Spruce-Pine-Fir #3	7-5	10-10	13-9	16-9	19-6	6-5	9-5	11-11	14-6	16-10	
	19.2	Douglas Fir-Larch SS	8-11	14-0	18-5	23-7	Note [a]b	8-11	14-0	18-5	22-7	Note [a]b
		Douglas Fir-Larch #1	8-7	13-6	17-9	21-8	25-2	8-4	12-2	15-4	18-9	21-9
		Douglas Fir-Larch #2	8-5	13-1	16-7	20-3	23-6	7-9	11-4	14-4	17-3	20-4
Douglas Fir-Larch #3		6-9	9-11	12-7	15-4	17-9	5-10	8-7	10-10	13-3	15-5	
Hem-Fir SS		8-5	13-3	17-5	22-3	Note [a]b	8-5	13-3	17-5	22-3	25-9	
Hem-Fir #1		8-3	12-11	17-1	21-1	24-6	8-1	11-10	15-0	18-4	21-3	
Hem-Fir #2		7-10	12-4	16-3	20-0	23-2	7-8	11-2	14-2	17-4	20-1	
Hem-Fir #3		6-9	9-11	12-7	15-4	17-9	5-10	8-7	10-10	13-3	15-5	
Southern Pine SS		8-9	13-9	18-1	23-1	Note [a]b	8-9	13-9	18-1	23-1	Note [a]b	
Southern Pine #1		[8-7] 8-5	[13-6] 13-3	[17-9] 17-5	[22-8] 21-2	[Note-a] 25-2	[8-7] 8-4	[13-6] 12-4	[17-2] 15-8	[20-4] 18-4	[24-4] 21-9	
Southern Pine #2		[8-5] 8-1	[13-3] 12-3	[17-5] 15-7	[21-2] 18-6	[24-10] 21-9	[8-4] 7-1	[11-11] 10-8	[15-4] 13-6	[18-4] 16-0	[21-6] 18-10	
Southern Pine #3		[7-3] 6-4	[10-8] 9-4	[13-7] 11-9	[16-0] 14-3	[19-1] 16-10	[6-3] 5-6	[9-3] 8-1	[11-9] 10-2	[13-10] 12-4	[16-6] 14-7	
Spruce-Pine-Fir SS		8-3	12-11	17-1	21-9	Note [a]b	8-3	12-11	17-1	21-0	24-4	
Spruce-Pine-Fir #1	8-1	12-8	16-7	20-3	23-6	7-9	11-4	14-4	17-7	20-4		
Spruce-Pine-Fir #2	8-1	12-8	16-7	20-3	23-6	7-9	11-4	14-4	17-7	20-4		
Spruce-Pine-Fir #3	6-9	9-11	12-7	15-4	17-9	5-10	8-7	10-10	13-3	15-5		
24	Douglas Fir-Larch SS	8-3	13-0	17-2	21-10	Note [a]b	8-3	13-0	16-7	20-3	23-5	
	Douglas Fir-Larch #1	8-0	12-6	15-10	19-5	22-6	7-5	10-10	13-9	16-9	19-6	
	Douglas Fir-Larch #2	7-10	11-9	14-10	18-2	21-0	6-11	10-2	12-10	15-8	18-3	
	Douglas Fir-Larch #3	6-1	8-10	11-3	13-8	15-11	5-3	7-8	9-9	11-10	13-9	
	Hem-Fir SS	7-10	23-3	16-2	20-8	25-1	7-10	12-3	16-2	19-10	23-0	
	Hem-Fir #1	7-8	12-0	15-6	18-11	21-11	7-3	10-7	13-5	16-4	19-0	
	Hem-Fir #2	7-3	11-5	14-8	17-10	20-9	6-10	10-0	12-8	15-6	17-11	
	Hem-Fir #3	6-1	8-10	11-3	13-8	15-11	5-3	7-8	9-9	11-10	13-9	
	Southern Pine SS	8-1	12-9	16-10	21-6	Note [a]b	8-1	12-9	16-10	21-6	Note [a]b	
	Southern Pine #1	[8-0] 7-10	[12-6] 12-3	[16-6] 16-2	[21-1] 18-11	[25-2] 22-6	[8-0] 7-5	[12-3] 11-1	[15-4] 14-0	[18-3] 16-5	[21-9] 19-6	
	Southern Pine #2	[7-10] 7-4	[12-3] 11-0	[15-10] 13-11	[18-11] 16-6	[22-2] 19-6	[7-5] 6-4	[10-8] 9-6	[13-9] 12-1	[16-5] 14-4	[19-3] 16-10	

TABLE [2308.10.3(2)] 2308.7.2(2)
RAFTER SPANS FOR COMMON LUMBER SPECIES
(Roof Live Load = 20 [pounds per square foot] psf, Ceiling [Not] Attached to Rafters, L/Δ = 240)

RAFTER SPACING (inches)	SPECIES AND GRADE	DEAD LOAD = 10 [pounds per square foot] psf					DEAD LOAD = 20 [pounds per square foot] psf				
		2 × 4	2 × 6	2 × 8	2 × 10	2 × 12	2 × 4	2 × 6	2 × 8	2 × 10	2 × 12
		Maximum rafter spans ^a									
		(ft. – in.)	(ft. – in.)	(ft. – in.)	(ft. – in.)	(ft. – in.)	(ft. – in.)	(ft. – in.)	(ft. – in.)	(ft. – in.)	(ft. – in.)
	Southern Pine #3	[6-5] 5-8	[9-6] 8-4	[12-4] 10-6	[14-4] 12-9	[17-4] 15-1	[5-7] 4-11	[8-3] 7-3	[10-6] 9-1	[12-5] 11-0	[14-9] 13-1
	Spruce-Pine-Fir SS	7-8	12-0	15-10	20-2	24-7	7-8	12-0	15-4	18-9	21-9
	Spruce-Pine-Fir #1	7-6	11-9	14-10	18-2	21-0	6-11	10-2	12-10	15-8	18-3
	Spruce-Pine-Fir #2	7-6	11-9	14-10	18-2	21-0	6-11	10-2	12-10	15-8	18-3
	Spruce-Pine-Fir #3	6-1	8-10	11-3	13-8	15-11	5-3	7-8	9-9	11-10	13-9

Check sources for availability of lumber in lengths greater than 20 feet.

For SF: 1 inch = 25.4 mm, 1 foot = [304] 304.8 mm, 1 pound per square foot = [47.9 N/m²] 0.0479 kPa.

- a. The tabulated rafter spans assume that ceiling joists are located at the bottom of the attic space or that some other method of resisting the outward push of the rafters on the bearing walls, such as rafter ties, is provided at that location. Where ceiling joists or rafter ties are located higher in the attic space, the rafter spans shall be multiplied by the following factors:

H_c/H_R	Rafter Span Adjustment Factor
1/3	0.67
1/4	0.76
1/5	0.83
1/6	0.90
1/7.5 or less	1.00

where:

H_c = Height of ceiling joists or rafter ties measured vertically above the top of the rafter support walls.

H_R = Height of roof ridge measured vertically above the top of the rafter support walls.

b. _____ Span exceeds 26 feet in length. [Check sources for availability of lumber in lengths greater than 20 feet.]

TABLE [2308.10.3(3)] 2308.7.2(3)
RAFTER SPANS FOR COMMON LUMBER SPECIES
(Ground Snow Load = 30 [pounds per square foot] psf, Ceiling Not Attached to Rafters, L/Δ = 180)

RAFTER SPACING (inches)	SPECIES AND GRADE	DEAD LOAD = 10 [pounds per square foot] psf					DEAD LOAD = 20 [pounds per square foot] psf				
		2 × 4	2 × 6	2 × 8	2 × 10	2 × 12	2 × 4	2 × 6	2 × 8	2 × 10	2 × 12
		Maximum rafter spans ^a									
		(ft. – in.)	(ft. – in.)	(ft. – in.)	(ft. – in.)	(ft. – in.)	(ft. – in.)	(ft. – in.)	(ft. – in.)	(ft. – in.)	(ft. – in.)
12	Douglas Fir-Larch SS	10-0	15-9	20-9	Note [a]b	Note [a]b	10-0	15-9	20-1	24-6	Note [a]b
	Douglas Fir-Larch #1	9-8	14-9	18-8	22-9	Note [a]b	9-0	13-2	16-8	20-4	23-7
	Douglas Fir-Larch #2	9-5	13-9	17-5	21-4	24-8	8-5	12-4	15-7	19-1	22-1
	Douglas Fir-Larch #3	7-1	10-5	13-2	16-1	18-8	6-4	9-4	11-9	14-5	16-8
	Hem-Fir SS	9-6	14-10	19-7	25-0	Note [a]b	9-6	14-10	19-7	24-1	Note [a]b
	Hem-Fir #1	9-3	14-4	18-2	22-2	25-9	8-9	12-10	16-3	19-10	23-0
	Hem-Fir #2	8-10	13-7	17-2	21-0	24-4	8-4	12-2	15-4	18-9	21-9
	Hem-Fir #3	7-1	10-5	13-2	16-1	18-8	6-4	9-4	11-9	14-5	16-8
	Southern Pine SS	9-10	15-6	20-5	Note [a]b	Note [a]b	9-10	15-6	20-5	Note [a]b	Note [a]b
	Southern Pine #1	[9-8] 9-6	[15-2] 14-10	[20-0] 19-0	[24-9] 22-3	[Note a] 26-0	[9-8] 9-0	[14-10] 13-5	[18-8] 17-0	[22-2] 19-11	[Note a] 23-7
	Southern Pine #2	[9-6] 8-7	[14-5] 12-11	[18-8] 16-4	[22-3] 19-5	[Note a] 22-10	[9-0] 7-8	[12-11] 11-7	[16-8] 14-8	[19-11] 17-4	[23-4] 20-5
	Southern Pine #3	[7-7] 6-7	[11-2] 9-9	[14-3] 12-4	[16-10] 15-0	[20-0] 17-9	[6-9] 5-11	[10-0] 8-9	[12-9] 11-0	[15-1] 13-5	[17-11] 15-10
	Spruce-Pine-Fir SS	9-3	14-7	19-2	24-6	Note [a]b	9-3	14-7	18-8	22-9	Note [a]b
	Spruce-Pine-Fir #1	9-1	13-9	17-5	21-4	24-8	8-5	12-4	15-7	19-1	22-1
Spruce-Pine-Fir #2	9-1	13-9	17-5	21-4	24-8	8-5	12-4	15-7	19-1	22-1	
Spruce-Pine-Fir #3	7-1	10-5	13-2	16-1	18-8	6-4	9-4	11-9	14-5	16-8	
16	Douglas Fir-Larch SS	9-1	14-4	18-10	23-9	Note [a]b	9-1	13-9	17-5	21-3	24-8
	Douglas Fir-Larch	8-9	12-9	16-2	19-9	22-10	7-10	11-5	14-5	17-8	20-5

TABLE [2308.10.3(3)] 2308.7.2(3)

RAFTER SPANS FOR COMMON LUMBER SPECIES

(Ground Snow Load = 30 [pounds per square foot] psf, Ceiling Not Attached to Rafters, L/Δ = 180)

RAFTER SPACING (inches)	SPECIES AND GRADE	DEAD LOAD = 10 [pounds per square foot] psf					DEAD LOAD = 20 [pounds per square foot] psf				
		2 × 4	2 × 6	2 × 8	2 × 10	2 × 12	2 × 4	2 × 6	2 × 8	2 × 10	2 × 12
		Maximum rafter spans ^a									
		(ft. - in.)	(ft. - in.)	(ft. - in.)	(ft. - in.)	(ft. - in.)	(ft. - in.)	(ft. - in.)	(ft. - in.)	(ft. - in.)	(ft. - in.)
	#1										
	Douglas Fir-Larch #2	8-2	11-11	15-1	18-5	21-5	7-3	10-8	13-6	16-6	19-2
	Douglas Fir-Larch #3	6-2	9-0	11-5	13-11	16-2	5-6	8-1	10-3	12-6	14-6
	Hem-Fir SS	8-7	13-6	17-10	22-9	Note [a]b	8-7	13-6	17-1	20-10	24-2
	Hem-Fir #1	8-5	12-5	15-9	19-3	22-3	7-7	11-1	14-1	17-2	19-11
	Hem-Fir #2	8-0	11-9	14-11	18-2	21-1	7-2	10-6	13-4	16-3	18-10
	Hem-Fir #3	6-2	9-0	11-5	13-11	16-2	5-6	8-1	10-3	12-6	14-6
	Southern Pine SS	8-11	14-1	18-6	23-8	Note [a]b	8-11	14-1	18-6	23-8	Note [a]b
	Southern Pine #1	[8-9] 8-7	[13-9] 13-0	[18-1] 16-6	[21-5] 19-3	[25-7] 22-10	[8-8] 7-10	[12-10] 11-7	[16-2] 14-9	[19-2] 17-3	[22-10] 20-5
	Southern Pine #2	[8-7] 7-6	[12-6] 11-2	[16-2] 14-2	[19-3] 16-10	[22-7] 19-10	[7-10] 6-8	[11-2] 10-0	[14-5] 12-8	[17-3] 15-1	[20-2] 17-9
	Southern Pine #3	[6-7] 5-9	[9-8] 8-6	[12-4] 10-8	[14-7] 13-0	[17-4] 15-4	[5-10] 5-2	[8-8] 7-7	[11-0] 9-7	[13-0] 11-7	[15-6] 13-9
	Spruce-Pine-Fir SS	8-5	13-3	17-5	22-1	25-7	8-5	12-9	16-2	19-9	22-10
	Spruce-Pine-Fir #1	8-2	11-11	15-1	18-5	21-5	7-2	10-8	13-6	16-6	19-2
	Spruce-Pine-Fir #2	8-2	11-11	15-1	18-5	21-5	7-3	10-8	13-6	16-6	19-2
	Spruce-Pine-Fir #3	6-2	9-0	11-5	13-11	16-2	5-6	8-1	10-3	12-6	14-6
19.2	Douglas Fir-Larch SS	8-7	13-6	17-9	21-8	25-2	8-7	12-6	15-10	19-5	22-6
	Douglas Fir-Larch #1	7-11	11-8	14-9	18-0	20-11	7-1	10-5	13-2	16-1	18-8
	Douglas Fir-Larch #2	7-5	10-11	13-9	16-10	19-6	6-8	9-9	12-4	15-1	17-6
	Douglas Fir-Larch #3	5-7	8-3	10-5	12-9	14-9	5-0	7-4	9-4	11-5	13-2
	Hem-Fir SS	8-1	12-9	16-9	21-4	24-8	8-1	12-4	15-7	19-1	22-1
	Hem-Fir #1	7-9	11-4	14-4	17-7	20-4	6-11	10-2	12-10	15-8	18-2
	Hem-Fir #2	7-4	10-9	13-7	16-7	19-3	6-7	9-7	12-2	14-10	17-3
	Hem-Fir #3	5-7	8-3	10-5	12-9	14-9	5-0	7-4	9-4	11-5	13-2
	Southern Pine SS	8-5	13-3	17-5	22-3	Note [a]b	8-5	13-3	17-5	22-0	25-9
	Southern Pine #1	[8-3] 8-0	[13-0] 11-10	[16-6] 15-1	[19-7] 17-7	[23-4] 20-11	[7-11] 7-1	[11-9] 10-7	[14-9] 13-5	[17-6] 15-9	[20-11] 18-8
	Southern Pine #2	[7-11] 6-10	[11-5] 10-2	[14-9] 12-11	[17-7] 15-4	[20-7] 18-1	[7-1] 6-1	[10-2] 9-2	[13-2] 11-7	[15-9] 13-9	[18-5] 16-2
	Southern Pine #3	[6-0] 5-3	[8-10] 7-9	[11-3] 9-9	[13-4] 11-10	[15-10] 14-0	[5-4] 4-8	[7-11] 6-11	[10-1] 8-9	[11-11] 10-7	[14-2] 12-6
	Spruce-Pine-Fir SS	7-11	12-5	16-5	20-2	23-4	7-11	11-8	14-9	18-0	20-11
	Spruce-Pine-Fir #1	7-5	10-11	13-9	16-10	19-6	6-8	9-9	12-4	15-1	17-6
	Spruce-Pine-Fir #2	7-5	10-11	13-9	16-10	19-6	6-8	9-9	12-4	15-1	17-6
	Spruce-Pine-Fir #3	5-7	8-3	10-5	12-9	14-9	5-0	7-4	9-4	11-5	13-2
24	Douglas Fir-Larch SS	7-11	12-6	15-10	19-5	22-6	7-8	11-3	14-2	17-4	20-1
	Douglas Fir-Larch #1	7-1	10-5	13-2	16-1	18-8	6-4	9-4	11-9	14-5	16-8
	Douglas Fir-Larch #2	6-8	9-9	12-4	15-1	17-6	5-11	8-8	11-0	13-6	15-7
	Douglas Fir-Larch #3	5-0	7-4	9-4	11-5	13-2	4-6	6-7	8-4	10-2	11-10
	Hem-Fir SS	7-6	11-10	15-7	19-1	22-1	7-6	11-0	13-11	17-0	19-9
	Hem-Fir #1	6-11	10-2	12-10	15-8	18-2	6-2	9-1	11-6	14-0	16-3
	Hem-Fir #2	6-7	9-7	12-2	14-10	17-3	5-10	8-7	10-10	13-3	15-5
	Hem-Fir #3	5-0	7-4	9-4	11-5	13-2	4-6	6-7	8-4	10-2	11-10
	Southern Pine SS	7-10	12-3	16-2	20-8	25-1	7-10	12-3	16-2	19-8	23-0
	Southern Pine #1	[7-8] 7-1	[11-9] 10-7	[14-9] 13-5	[17-6] 15-9	[20-11] 18-8	[7-1] 6-4	[10-6] 9-6	[13-2] 12-0	[15-8] 14-1	[18-8] 16-8

TABLE [2308.10.3(3)] 2308.7.2(3)

RAFTER SPANS FOR COMMON LUMBER SPECIES

(Ground Snow Load = 30 [pounds per square foot] psf, Ceiling Not Attached to Rafters, L/Δ = 180)

RAFTER SPACING (inches)	SPECIES AND GRADE	DEAD LOAD = 10 [pounds per square foot] psf					DEAD LOAD = 20 [pounds per square foot] psf				
		2 × 4	2 × 6	2 × 8	2 × 10	2 × 12	2 × 4	2 × 6	2 × 8	2 × 10	2 × 12
		Maximum rafter spans ^a									
		(ft. – in.)	(ft. – in.)	(ft. – in.)	(ft. – in.)	(ft. – in.)	(ft. – in.)	(ft. – in.)	(ft. – in.)	(ft. – in.)	
	Southern Pine #2	[7-4] 6-1	[10-2] 9-2	[13-2] 11-7	[15-9] 13-9	[18-5] 16-2	[6-4] 5-5	[9-2] 8-2	[11-9] 10-4	[14-1] 12-3	[16-6] 14-6
	Southern Pine #3	[5-4] 4-8	[7-11] 6-11	[10-1] 8-9	[11-11] 10-7	[14-2] 12-6	[4-9] 4-2	[7-1] 6-2	[9-0] 7-10	[10-8] 9-6	[12-8] 11-2
	Spruce-Pine-Fir SS	7-4	11-7	14-9	18-0	20-11	7-1	10-5	13-2	16-1	18-8
	Spruce-Pine-Fir #1	6-8	9-9	12-4	15-1	17-6	5-11	8-8	11-0	13-6	15-7
	Spruce-Pine-Fir #2	6-8	9-9	12-4	15-1	17-6	5-11	8-8	11-0	13-6	15-7
	Spruce-Pine-Fir #3	5-0	7-4	9-4	11-5	13-2	4-6	6-7	8-4	10-2	11-10

Check sources for availability of lumber in lengths greater than 20 feet.

For SI: 1 inch = 25.4 mm, 1 foot = [304] 304.8 mm, 1 pound per square foot = [47.9 N/m²] 0.0479 kPa.

- a. The tabulated rafter spans assume that ceiling joists are located at the bottom of the attic space or that some other method of resisting the outward push of the rafters on the bearing walls, such as rafter ties, is provided at that location. Where ceiling joists or rafter ties are located higher in the attic space, the rafter spans shall be multiplied by the following factors:

H_c/H_R	Rafter Span Adjustment Factor
1/3	0.67
1/4	0.76
1/5	0.83
1/6	0.90
1/7.5 or less	1.00

where:

H_c = Height of ceiling joists or rafter ties measured vertically above the top of the rafter support walls.

H_R = Height of roof ridge measured vertically above the top of the rafter support walls.

- b. Span exceeds 26 feet in length. [Check sources for availability of lumber in lengths greater than 20 feet.]

TABLE [2308.10.3(4)] 2308.7.2(4)

RAFTER SPANS FOR COMMON LUMBER SPECIES

(Ground Snow Load = 50 [pounds per square foot] psf, Ceiling Not Attached to Rafters, L/Δ = 180)

RAFTER SPACING (inches)	SPECIES AND GRADE	DEAD LOAD = 10 [pounds per square foot] psf					DEAD LOAD = 20 [pounds per square foot] psf				
		2 × 4	2 × 6	2 × 8	2 × 10	2 × 12	2 × 4	2 × 6	2 × 8	2 × 10	2 × 12
		Maximum rafter spans ^a									
		(ft. – in.)	(ft. – in.)	(ft. – in.)	(ft. – in.)	(ft. – in.)	(ft. – in.)	(ft. – in.)	(ft. – in.)	(ft. – in.)	
12	Douglas Fir-Larch SS	8-5	13-3	17-6	22-4	26-0	8-5	13-3	17-0	20-9	24-10
	Douglas Fir-Larch #1	8-2	12-0	15-3	18-7	21-7	7-7	11-2	14-1	17-3	20-0
	Douglas Fir-Larch #2	7-8	11-3	14-3	17-5	20-2	7-1	10-5	13-2	16-1	18-8
	Douglas Fir-Larch #3	5-10	8-6	10-9	13-2	15-3	5-5	7-10	10-0	12-2	14-1
	Hem-Fir SS	8-0	12-6	16-6	21-1	25-6	8-0	12-6	16-6	20-4	23-7
	Hem-Fir #1	7-10	11-9	14-10	18-1	21-0	7-5	10-10	13-9	16-9	19-5
	Hem-Fir #2	7-5	11-1	14-0	17-2	19-11	7-0	10-3	13-0	15-10	18-5
	Hem-Fir #3	5-10	8-6	10-9	13-2	15-3	5-5	7-10	10-0	12-2	14-1
	Southern Pine SS	8-4	13-0 13-1	17-2	21-11	Note [a]b	8-4	13-0 13-1	17-2	21-11 21-5	Note a 25-3
	Southern Pine #1	8-2 8-0	12-10 12-3	16-10 15-6	20-3 18-2	24-1 21-7	8-2 7-7	12-6 11-4	15-9 14-5	18-9 16-10	22-4 20-0
	Southern Pine #2	8-0 7-0	11-9 10-6	15-3 13-4	18-2 15-10	21-3 18-8	7-7 6-6	10-11 9-2	14-1 12-4	16-10 14-8	19-9 17-3
	Southern Pine #3	6-2 5-5	9-2 8-0	11-8 10-1	13-9 12-3	16-4 14-6	5-9 5-0	8-5 7-5	10-9 9-4	12-9 11-4	15-2 13-5
	Spruce-Pine-Fir SS	7-10	12-3	16-2	20-8	24-1	7-10	12-3	15-9	19-3	22-4
	Spruce-Pine-Fir #1	7-8	11-3	14-3	17-5	20-2	7-1	10-5	13-2	16-1	18-8
	Spruce-Pine-Fir #2	7-8	11-3	14-3	17-5	20-2	7-1	10-5	13-2	16-1	18-8
	Spruce-Pine-Fir #3	5-10	8-6	10-9	13-2	15-3	5-5	7-10	10-0	12-2	14-1
16	Douglas Fir-Larch SS	7-8	12-1	15-10	19-5	22-6	7-8	11-7	14-8	17-11	20-10
	Douglas Fir-Larch #1	7-1	10-5	13-2	16-1	18-8	6-7	9-8	12-2	14-11	17-3
	Douglas Fir-Larch #2	6-8	9-9	12-4	15-1	17-6	6-2	9-0	11-5	13-11	16-2
	Douglas Fir-Larch #3	5-0	7-4	9-4	11-5	13-2	4-8	6-10	8-8	10-6	12-3
	Hem-Fir SS	7-3	11-5	15-0	19-1	22-1	7-3	11-5	14-5	17-8	20-5
	Hem-Fir #1	6-11	10-2	12-10	15-8	18-2	6-5	9-5	11-11	14-6	16-10
	Hem-Fir #2	6-7	9-7	12-2	14-10	17-3	6-1	8-11	13-3	13-9	15-11
	Hem-Fir #3	5-0	7-4	9-4	11-5	13-2	4-8	6-10	8-8	10-6	12-3
	Southern Pine SS	7-6	11-10	15-7	19-11	24-3 23-7	7-6	11-10	15-7	19-11 18-6	23-10 21-10
	Southern Pine #1	7-5 7-1	11-7 10-7	14-9 13-5	17-6 15-9	20-11 18-8	7-4 6-7	10-10 9-2	13-8 12-5	16-2 14-7	19-4 17-3
	Southern Pine #2	7-1 6-1	10-2 9-2	13-2 11-7	15-9 13-9	18-5 16-2	6-7 5-8	9-5 8-5	12-2 10-9	14-7 12-9	17-1 15-0
	Southern Pine #3	5-4 4-8	7-11 6-11	10-1 8-9	11-11 10-7	14-2 12-6	4-11 4-4	7-4 6-5	9-4 8-1	11-0 9-2	13-1 11-7
	Spruce-Pine-Fir SS	7-1	11-2	14-8	18-0	20-11	7-1	10-9	13-8	16-8	19-4
	Spruce-Pine-Fir #1	6-8	9-9	12-4	15-1	17-6	6-2	9-0	11-5	13-11	16-2
	Spruce-Pine-Fir #2	6-8	9-9	12-4	15-1	17-6	6-2	9-0	11-5	13-11	16-2
	Spruce-Pine-Fir #3	5-0	7-4	9-4	11-5	13-2	4-8	6-10	8-8	10-6	12-3
19.2	Douglas Fir-Larch SS	7-3	11-4	14-6	17-8	20-6	7-3	10-7	13-5	16-5	19-0
	Douglas Fir-Larch #1	6-6	9-6	12-0	14-8	17-1	6-0	8-10	11-2	13-7	15-9
	Douglas Fir-Larch #2	6-1	8-11	11-3	13-9	15-11	5-7	8-3	10-5	12-9	14-9

TABLE [2308.10.3(4)] 2308.7.2(4)
RAFTER SPANS FOR COMMON LUMBER SPECIES
(Ground Snow Load = 50 [pounds per square foot] psf, Ceiling Not Attached to Rafters, L/Δ = 180)

RAFTER SPACING (inches)	SPECIES AND GRADE	DEAD LOAD = 10 [pounds per square foot] psf					DEAD LOAD = 20 [pounds per square foot] psf				
		2 × 4	2 × 6	2 × 8	2 × 10	2 × 12	2 × 4	2 × 6	2 × 8	2 × 10	2 × 12
		Maximum rafter spans ^a									
		(ft. – in.)	(ft. – in.)	(ft. – in.)	(ft. – in.)	(ft. – in.)	(ft. – in.)	(ft. – in.)	(ft. – in.)	(ft. – in.)	
	#2										
	Douglas Fir-Larch #3	4-7	6-9	8-6	10-5	12-1	4-3	6-3	7-11	9-7	11-2
	Hem-Fir SS	6-10	10-9	14-2	17-5	20-2	6-10	10-5	13-2	16-1	18-8
	Hem-Fir #1	6-4	9-3	11-9	14-4	16-7	5-10	8-7	10-10	13-3	15-5
	Hem-Fir #2	6-0	8-9	11-1	13-7	15-9	5-7	8-1	10-3	12-7	14-7
	Hem-Fir #3	4-7	6-9	8-6	10-5	12-1	4-3	6-3	7-11	9-7	11-2
	Southern Pine SS	7-1	11-2	14-8	<u>18-9</u> <u>18-3</u>	<u>22-10</u> <u>21-7</u>	7-1	11-2	<u>14-8</u> <u>14-2</u>	<u>18-7</u> <u>16-11</u>	<u>21-9</u> <u>20-0</u>
	Southern Pine #1	<u>7-0</u> <u>6-6</u>	<u>10-8</u> <u>9-8</u>	<u>13-5</u> <u>12-3</u>	<u>16-0</u> <u>14-4</u>	<u>19-1</u> <u>17-1</u>	<u>6-8</u> <u>6-0</u>	<u>9-11</u> <u>9-0</u>	<u>12-5</u> <u>11-4</u>	<u>14-10</u> <u>13-4</u>	<u>17-8</u> <u>15-9</u>
	Southern Pine #2	<u>6-6</u> <u>5-7</u>	<u>9-4</u> <u>8-4</u>	<u>12-0</u> <u>10-7</u>	<u>14-4</u> <u>12-6</u>	<u>16-10</u> <u>14-9</u>	<u>6-0</u> <u>5-2</u>	<u>8-8</u> <u>7-9</u>	<u>11-2</u> <u>9-9</u>	<u>13-4</u> <u>11-7</u>	<u>15-7</u> <u>13-8</u>
	Southern Pine #3	<u>4-11</u> <u>4-3</u>	<u>7-3</u> <u>6-4</u>	<u>9-2</u> <u>8-0</u>	<u>10-10</u> <u>9-2</u>	<u>12-11</u> <u>11-5</u>	<u>4-6</u> <u>4-0</u>	<u>6-8</u> <u>5-10</u>	<u>8-6</u> <u>7-4</u>	<u>10-1</u> <u>8-11</u>	<u>12-0</u> <u>10-7</u>
	Spruce-Pine-Fir SS	6-8	10-6	13-5	16-5	19-1	6-8	9-10	12-5	15-3	17-8
	Spruce-Pine-Fir #1	6-1	8-11	11-3	13-9	15-11	5-7	8-3	10-5	12-9	14-9
	Spruce-Pine-Fir #2	6-1	8-11	11-3	13-9	15-11	5-7	8-3	10-5	12-9	14-9
	Spruce-Pine-Fir #3	4-7	6-9	8-6	10-5	12-1	4-3	6-3	7-11	9-7	11-2
24	Douglas Fir-Larch SS	6-8	10-3	13-0	15-10	18-4	6-6	9-6	12-0	14-8	17-0
	Douglas Fir-Larch #1	5-10	8-6	10-9	13-2	15-3	5-5	7-10	10-0	12-2	14-1
	Douglas Fir-Larch #2	5-5	7-11	10-1	12-4	14-3	5-0	7-4	9-4	11-5	13-2
	Douglas Fir-Larch #3	4-1	6-0	7-7	9-4	10-9	3-10	5-7	7-1	8-7	10-0
	Hem-Fir SS	6-4	9-11	12-9	15-7	18-0	6-4	9-4	11-9	14-5	16-8
	Hem-Fir #1	5-8	8-3	10-6	12-10	14-10	5-3	7-8	9-9	11-10	13-9
	Hem-Fir #2	5-4	7-10	9-11	12-1	14-1	4-11	7-3	9-2	11-3	13-0
	Hem-Fir #3	4-1	6-0	7-7	9-4	10-9	3-10	5-7	7-1	8-7	10-0
	Southern Pine SS	6-7	10-4	13-8	<u>17-5</u> <u>16-4</u>	<u>21-0</u> <u>19-3</u>	6-7	<u>10-4</u> <u>10-0</u>	13-8	<u>16-7</u> <u>15-2</u>	<u>19-5</u> <u>17-10</u>
	Southern Pine #1	<u>6-5</u> <u>5-10</u>	<u>9-7</u> <u>8-8</u>	<u>12-0</u> <u>11-0</u>	<u>14-4</u> <u>12-10</u>	<u>17-1</u> <u>15-3</u>	<u>6-0</u> <u>5-5</u>	<u>8-10</u> <u>8-0</u>	<u>11-2</u> <u>10-2</u>	<u>13-3</u> <u>11-11</u>	<u>15-9</u> <u>14-1</u>
	Southern Pine #2	<u>5-10</u> <u>5-0</u>	<u>8-4</u> <u>7-5</u>	<u>10-9</u> <u>9-5</u>	<u>12-10</u> <u>11-3</u>	<u>15-1</u> <u>13-2</u>	<u>5-5</u> <u>4-7</u>	<u>7-9</u> <u>6-11</u>	<u>10-0</u> <u>8-9</u>	<u>11-11</u> <u>10-5</u>	<u>13-11</u> <u>12-3</u>
	Southern Pine #3	<u>4-4</u> <u>3-10</u>	<u>6-5</u> <u>5-8</u>	<u>8-3</u> <u>7-1</u>	<u>9-9</u> <u>8-8</u>	<u>11-7</u> <u>10-3</u>	<u>4-1</u> <u>3-6</u>	<u>6-0</u> <u>5-3</u>	<u>7-7</u> <u>6-7</u>	<u>9-0</u> <u>8-0</u>	<u>10-8</u> <u>9-6</u>
	Spruce-Pine-Fir SS	6-2	9-6	12-0	14-8	17-1	6-0	8-10	11-2	13-7	15-9
	Spruce-Pine-Fir #1	5-5	7-11	10-1	12-4	14-3	5-0	7-4	9-4	11-5	13-2
	Spruce-Pine-Fir #2	5-5	7-11	10-1	12-4	14-3	5-0	7-4	9-4	11-5	13-2
	Spruce-Pine-Fir #3	4-1	6-0	7-7	9-4	10-9	3-10	5-7	7-1	8-7	10-0

Check sources for availability of lumber in lengths greater than 20 feet.

For SI: 1 inch = 25.4 mm, 1 foot = [304] 304.8 mm, 1 pound per square foot = [47.9 N/m²] 0.0479 kPa.

- a. The tabulated rafter spans assume that ceiling joists are located at the bottom of the attic space or that some other method of resisting the outward push of the rafters on the bearing walls, such as rafter ties, is provided at that location. Where ceiling joists or rafter ties are located higher in the attic space, the rafter spans shall be multiplied by the following factors:

H_e/H_k	Rafter Span Adjustment Factor
1/3	0.67
1/4	0.76
1/5	0.83
1/6	0.90
1/7.5 or less	1.00

where:

H_c = Height of ceiling joists or rafter ties measured vertically above the top of the rafter support walls.

H_g = Height of roof ridge measured vertically above the top of the rafter support walls.

b. ____ Span exceeds 26 feet in length. [Check sources for availability of lumber in lengths greater than 20 feet.]

TABLE [2308.10.3(5)] 2308.7.2(5)
RAFTER SPANS FOR COMMON LUMBER SPECIES
(Ground Snow Load = 30 [pounds per square foot] psf, Ceiling Attached to Rafters, L/Δ = 240)

RAFTER SPACING (inches)	SPECIES AND GRADE	DEAD LOAD = 10 [pounds per square foot] psf					DEAD LOAD = 20 [pounds per square foot] psf				
		2 × 4	2 × 6	2 × 8	2 × 10	2 × 12	2 × 4	2 × 6	2 × 8	2 × 10	2 × 12
		Maximum rafter spans ^a									
		(ft. – in.)	(ft. – in.)	(ft. – in.)	(ft. – in.)	(ft. – in.)	(ft. – in.)	(ft. – in.)	(ft. – in.)	(ft. – in.)	(ft. – in.)
12	Douglas Fir-Larch SS	9-1	14-4	18-10	24-1	Note [a]b	9-1	14-4	18-10	24-1	Note [a]b
	Douglas Fir-Larch #1	8-9	13-9	18-2	22-9	Note [a]b	8-9	13-2	16-8	20-4	23-7
	Douglas Fir-Larch #2	8-7	13-6	17-5	21-4	24-8	8-5	12-4	15-7	19-1	22-1
	Douglas Fir-Larch #3	7-1	10-5	13-2	16-1	18-8	6-4	9-4	11-9	14-5	16-8
	Hem-Fir SS	8-7	13-6	17-10	22-9	Note [a]b	8-7	13-6	17-10	22-9	Note [a]b
	Hem-Fir #1	8-5	13-3	17-5	22-2	25-9	8-5	12-10	16-3	19-10	23-0
	Hem-Fir #2	8-0	12-7	16-7	21-0	24-4	8-0	12-2	15-4	18-9	21-9
	Hem-Fir #3	7-1	10-5	13-2	16-1	18-8	6-4	9-4	11-9	14-5	16-8
	Southern Pine SS	8-11	14-1	18-6	23-8	Note [a]b	8-11	14-1	18-6	23-8	Note [a]b
	Southern Pine #1	[8-9] 8-7	[13-9] 13-6	[18-2] 17-10	[23-2] 22-3	Note [a]b	[8-9] 8-7	[13-9] 13-5	[18-2] 17-0	[22-2] 19-11	Note [a]b
	Southern Pine #2	[8-7] 8-3	[13-6] 12-11	[17-10] 16-4	[22-3] 19-5	Note [a]b	[8-7] 7-8	[12-11] 11-7	[16-8] 14-8	[19-11] 17-4	[23-4] 20-5
	Southern Pine #3	[7-7] 6-7	[11-2] 9-9	[14-3] 12-4	[16-10] 15-0	[20-9] 17-9	[6-9] 5-11	[10-0] 8-9	[12-9] 11-0	[15-1] 13-5	[17-11] 15-10
	Spruce-Pine-Fir SS	8-5	13-3	17-5	22-3	Note [a]b	8-5	13-3	17-5	22-3	Note [a]b
	Spruce-Pine-Fir #1	8-3	12-11	17-0	21-4	24-8	8-3	12-4	15-7	19-1	22-1
	Spruce-Pine-Fir #2	8-3	12-11	17-0	21-4	24-8	8-3	12-4	15-7	19-1	22-1
Spruce-Pine-Fir #3	7-1	10-5	13-2	16-1	18-8	6-4	9-4	11-9	14-5	16-8	
16	Douglas Fir-Larch SS	8-3	13-0	17-2	21-10	Note [a]b	8-3	13-0	17-2	21-3	24-8
	Douglas Fir-Larch #1	8-0	12-6	16-2	19-9	22-10	7-10	11-5	14-5	17-8	20-5
	Douglas Fir-Larch #2	7-10	11-11	15-1	18-5	21-5	7-3	10-8	13-6	16-6	19-2
	Douglas Fir-Larch #3	6-2	9-0	11-5	13-11	16-2	5-6	8-1	10-3	12-6	14-6
	Hem-Fir SS	7-10	12-3	16-2	20-8	25-1	7-10	12-3	16-2	20-8	24-2
	Hem-Fir #1	7-8	12-0	15-9	19-3	22-3	7-7	11-1	14-1	17-2	19-11
	Hem-Fir #2	7-3	11-5	14-11	18-2	21-1	7-2	10-6	13-4	16-3	18-10
	Hem-Fir #3	6-2	9-0	11-5	13-11	16-2	5-6	8-1	10-3	12-6	14-6
	Southern Pine SS	8-1	12-9	16-10	21-6	Note [a]b	8-1	12-9	16-10	21-6	Note [a]b
	Southern Pine #1	[8-0] 7-10	[12-6] 12-3	[16-6] 16-2	[21-4] 19-3	[25-7] 22-10	[8-0] 7-10	[12-6] 11-7	[16-2] 14-9	[19-2] 17-3	[22-10] 20-5
	Southern Pine #2	[7-10] 7-6	[12-3] 11-2	[16-2] 14-2	[19-3] 16-10	[22-7] 19-10	[7-10] 6-8	[11-2] 10-0	[14-5] 12-8	[17-3] 15-1	[20-2] 17-9
	Southern Pine #3	[6-7] 5-9	[9-8] 8-6	[12-4] 10-8	[14-7] 13-0	[17-4] 15-4	[5-10] 5-2	[8-8] 7-7	[11-0] 9-7	[13-0] 11-7	[15-6] 13-9
	Spruce-Pine-Fir SS	7-8	12-0	15-10	20-2	24-7	7-8	12-0	15-10	19-9	22-10
	Spruce-Pine-Fir #1	7-6	11-9	15-1	18-5	21-5	7-3	10-8	13-6	16-6	19-2
	Spruce-Pine-Fir #2	7-6	11-9	15-1	18-5	21-5	7-3	10-8	13-6	16-6	19-2
Spruce-Pine-Fir #3	6-2	9-0	11-5	13-11	16-2	5-6	8-1	10-3	12-6	14-6	
19.2	Douglas Fir-Larch SS	7-9	12-3	16-1	20-7	25-0	7-9	12-3	15-10	19-5	22-6
	Douglas Fir-	7-6	11-8	14-9	18-0	20-11	7-1	10-5	13-2	16-1	18-8

TABLE [2308.10.3(5)] 2308.7.2(5)
RAFTER SPANS FOR COMMON LUMBER SPECIES
(Ground Snow Load = 30 [pounds per square foot] psf, Ceiling Attached to Rafters, L/Δ = 240)

RAFTER SPACING (inches)	SPECIES AND GRADE	DEAD LOAD = 10 [pounds per square foot] psf					DEAD LOAD = 20 [pounds per square foot] psf				
		2 × 4	2 × 6	2 × 8	2 × 10	2 × 12	2 × 4	2 × 6	2 × 8	2 × 10	2 × 12
		Maximum rafter spans ^a									
		(ft. – in.)	(ft. – in.)	(ft. – in.)	(ft. – in.)	(ft. – in.)	(ft. – in.)	(ft. – in.)	(ft. – in.)	(ft. – in.)	(ft. – in.)
	Larch #1										
	Douglas Fir-Larch #2	7-4	10-11	13-9	16-10	19-6	6-8	9-9	12-4	15-1	17-6
	Douglas Fir-Larch #3	5-7	8-3	10-5	12-9	14-9	5-0	7-4	9-4	11-5	13-2
	Hem-Fir SS	7-4	11-7	15-3	19-5	23-7	7-4	11-7	15-3	19-1	22-1
	Hem-Fir #1	7-2	11-4	14-4	17-7	20-4	6-11	10-2	12-10	15-8	18-2
	Hem-Fir #2	6-10	10-9	13-7	16-7	19-3	6-7	9-7	12-2	14-10	17-3
	Hem-Fir #3	5-7	8-3	10-5	12-9	14-9	5-0	7-4	9-1	11-5	13-2
	Southern Pine SS	7-8	12-0	15-10	20-2	24-7	7-8	12-0	15-10	20-2	24-7
	Southern Pine #1	[7-6] 7-4	[11-9] 11-7	[15-6] 15-1	[19-7] 17-7	[23-4] 20-11	[7-6] 7-1	[11-9] 10-7	[14-9] 13-5	[17-6] 15-9	[20-11] 18-8
	Southern Pine #2	[7-4] 6-10	[11-5] 10-2	[14-9] 12-11	[17-7] 15-4	[20-7] 18-1	[7-1] 6-1	[10-2] 9-2	[13-2] 11-7	[15-9] 13-9	[18-5] 16-2
	Southern Pine #3	[6-0] 5-3	[8-10] 7-9	[11-3] 9-9	[13-4] 11-10	[15-10] 14-0	[5-4] 4-8	[7-11] 6-11	[10-1] 8-9	[11-11] 10-7	[14-2] 12-6
	Spruce-Pine-Fir SS	7-2	11-4	14-11	19-0	23-1	7-2	11-4	14-9	18-0	20-11
	Spruce-Pine-Fir #1	7-0	10-11	13-9	16-10	19-6	6-8	9-9	12-4	15-1	17-6
	Spruce-Pine-Fir #2	7-0	10-11	13-9	16-10	19-6	6-8	9-9	12-4	15-1	17-6
	Spruce-Pine-Fir #3	5-7	8-3	10-5	12-9	14-9	5-0	7-4	9-4	11-5	13-2
24	Douglas Fir-Larch SS	7-3	11-4	15-0	19-1	22-6	7-3	11-3	14-2	17-4	20-1
	Douglas Fir-Larch #1	7-0	10-5	13-2	16-1	18-8	6-4	9-4	11-9	14-5	16-8
	Douglas Fir-Larch #2	6-8	9-9	12-4	15-1	17-6	5-11	8-8	11-0	13-5	15-7
	Douglas Fir-Larch #3	5-0	7-4	9-4	11-5	13-2	4-6	6-7	8-4	10-2	11-10
	Hem-Fir SS	6-10	10-9	14-2	18-0	21-11	6-10	10-9	13-11	17-0	19-9
	Hem-Fir #1	6-8	10-2	12-10	15-8	18-2	6-2	9-1	11-6	14-0	16-3
	Hem-Fir #2	6-4	9-7	12-2	14-10	17-3	5-10	8-7	10-10	13-3	15-5
	Hem-Fir #3	5-0	7-4	9-4	11-5	13-2	4-6	6-7	8-4	10-2	11-10
	Southern Pine SS	7-1	11-2	14-8	18-9	22-10	7-1	11-2	14-8	18-9	22-10
	Southern Pine #1	[7-0] 6-10	[10-11] 10-7	[14-5] 13-5	[17-6] 15-9	[20-11] 18-8	[7-0] 6-4	[10-6] 9-6	[13-2] 12-0	[15-8] 14-1	[18-8] 16-8
	Southern Pine #2	[6-10] 6-1	[10-2] 9-2	[13-2] 11-7	[15-9] 13-9	[18-5] 16-2	[6-4] 5-5	[9-2] 8-2	[11-9] 10-4	[14-1] 12-3	[16-6] 14-6
	Southern Pine #3	[5-4] 4-8	[7-11] 6-11	[10-1] 8-9	[11-11] 10-7	[14-2] 12-6	[4-9] 4-2	[7-1] 6-2	[9-0] 7-10	[10-8] 9-6	[12-8] 11-2
	Spruce-Pine-Fir SS	6-8	10-6	13-10	17-8	20-11	6-8	10-5	13-2	16-1	18-8
	Spruce-Pine-Fir #1	6-6	9-9	12-4	15-1	17-6	5-11	8-8	11-0	13-6	15-7
	Spruce-Pine-Fir #2	6-6	9-9	12-4	15-1	17-6	5-11	8-8	11-0	13-6	15-7
Spruce-Pine-Fir #3	5-0	7-4	9-4	11-5	13-2	4-6	6-7	8-4	10-2	11-10	

Check sources for availability of lumber in lengths greater than 20 feet.

For SI: 1 inch = 25.4 mm, 1 foot = [304] 304.8 mm, 1 pound per square foot = [47.9 N/m²] 0.0479 kPa.

a. The tabulated rafter spans assume that ceiling joists are located at the bottom of the attic space or that some other method of resisting the outward push of the rafters on the bearing walls, such as rafter ties, is provided at that location. Where ceiling joists or rafter ties are located higher in the attic space, the rafter spans shall be multiplied by the following factors:

H/H_R	Rafter Span Adjustment Factor
1/3	0.67

1/4	0.76
1/5	0.83
1/6	0.90
1/7.5 or less	1.00

where:

H_c = Height of ceiling joists or rafter ties measured vertically above the top of the rafter support walls.

H_g = Height of roof ridge measured vertically above the top of the rafter support walls.

b. ___ Span exceeds 26 feet in length. [Check sources for availability of lumber in lengths greater than 20 feet.]

TABLE [2308.10.3(6)] 2308.7.2(6)
RAFTER SPANS FOR COMMON LUMBER SPECIES
(Ground Snow Load = 50 [pounds per square foot] psf, Ceiling Attached to Rafters, L/Δ = 240)

RAFTER SPACING (inches)	SPECIES AND GRADE	DEAD LOAD = 10 [pounds per square foot] psf					DEAD LOAD = 20 [pounds per square foot] psf				
		2 × 4	2 × 6	2 × 8	2 × 10	2 × 12	2 × 4	2 × 6	2 × 8	2 × 10	2 × 12
		Maximum rafter spans ^a									
		(ft. - in.)	(ft. - in.)	(ft. - in.)	(ft. - in.)	(ft. - in.)	(ft. - in.)	(ft. - in.)	(ft. - in.)	(ft. - in.)	(ft. - in.)
12	Douglas Fir-Larch SS	7-8	12-1	15-11	20-3	24-8	7-8	12-1	15-11	20-3	24-0
	Douglas Fir-Larch #1	7-5	11-7	15-3	18-7	21-7	7-5	11-2	14-0	17-3	20-0
	Douglas Fir-Larch #2	7-3	11-3	14-3	17-5	20-2	7-1	10-5	13-2	16-1	18-8
	Douglas Fir-Larch #3	5-10	8-6	10-9	13-2	15-3	5-5	7-10	10-0	12-2	14-1
	Hem-Fir SS	7-3	11-5	15-0	19-2	23-4	7-3	11-8	15-0	19-2	23-4
	Hem-Fir #1	7-1	11-2	14-8	18-1	21-0	7-1	10-10	13-9	16-9	19-5
	Hem-Fir #2	6-9	10-8	14-0	17-2	19-11	6-9	10-3	13-0	15-10	18-5
	Hem-Fir #3	5-10	8-6	10-9	13-2	15-3	5-5	7-10	10-0	12-2	14-1
	Southern Pine SS	7-6	11-10	15-7	19-11	24-3	7-6	11-10	15-7	19-11	24-3
	Southern Pine #1	7-5 7-3	11-7 11-5	15-4 15-0	19-7 18-2	23-9 21-7	7-5 7-3	11-7 11-4	15-4 14-5	19-9 16-10	22-4 20-0
	Southern Pine #2	7-3 6-11	11-5 10-6	15-0 13-4	18-2 15-10	21-3 18-8	7-3 6-6	10-11 9-2	14-1 12-4	16-10 14-8	19-9 17-3
	Southern Pine #3	6-2 5-5	9-2 8-0	11-8 10-1	13-9 12-3	16-4 14-6	5-9 5-0	8-5 7-5	10-9 9-4	12-9 11-4	15-2 13-5
	Spruce-Pine-Fir SS	7-1	11-2	14-8	18-9	22-10	7-1	11-2	14-8	18-9	22-4
	Spruce-Pine-Fir #1	6-11	10-11	14-3	17-5	20-2	6-11	10-5	13-2	16-1	18-8
	Spruce-Pine-Fir #2	6-11	10-11	14-3	17-5	20-2	6-11	10-5	13-2	16-1	18-8
	Spruce-Pine-Fir #3	5-10	8-6	10-9	13-2	15-3	5-5	7-10	10-0	12-2	14-1
16	Douglas Fir-Larch SS	7-0	11-0	14-5	18-5	22-5	7-0	11-0	14-5	17-11	20-10
	Douglas Fir-Larch #1	6-9	10-5	13-2	16-1	18-8	6-7	9-8	12-2	14-11	17-3
	Douglas Fir-Larch #2	6-7	9-9	12-4	15-1	17-6	6-2	9-0	11-5	13-11	16-2
	Douglas Fir-Larch #3	5-0	7-4	9-4	11-5	13-2	4-8	6-10	8-8	10-6	12-3
	Hem-Fir SS	6-7	10-4	13-8	17-5	21-2	6-7	10-4	13-8	17-5	20-5
	Hem-Fir #1	6-5	10-2	12-10	15-8	18-2	6-5	9-5	11-11	14-6	16-10
	Hem-Fir #2	6-2	9-7	12-2	14-10	17-3	6-1	8-11	11-3	13-9	15-11
	Hem-Fir #3	5-0	7-4	9-4	11-5	13-2	4-8	6-10	8-8	10-6	12-3
	Southern Pine SS	6-10	10-9	14-2	18-1	22-0	6-10	10-9	14-2	18-1	22-0 21-10
	Southern Pine #1	6-9 6-7	10-7 10-4	13-11 13-5	17-6 15-9	20-11 18-8	6-9 6-7	10-7 9-10	13-8 12-5	16-2 14-7	19-4 17-3
	Southern Pine #2	6-7 6-1	10-2 9-2	13-2 11-7	15-9 13-9	18-5 16-2	6-7 5-8	9-5 8-5	12-2 10-9	14-7 12-9	17-1 15-0
	Southern Pine #3	5-4 4-8	7-11 6-11	10-1 8-9	11-11 10-7	14-2 12-6	4-11 4-4	7-4 6-5	9-4 8-1	11-0 9-10	13-1 11-7
	Spruce-Pine-Fir SS	6-5	10-2	13-4	17-0	20-9	6-5	10-2	13-4	16-8	19-4
	Spruce-Pine-Fir #1	6-4	9-9	12-4	15-1	17-6	6-2	9-0	11-5	13-11	16-2
Spruce-Pine-Fir #2	6-4	9-9	12-4	15-1	17-6	6-2	9-0	11-5	13-11	16-2	

TABLE [2308.10.3(6)] 2308.7.2(6)
RAFTER SPANS FOR COMMON LUMBER SPECIES
(Ground Snow Load = 50 [pounds per square foot] psf, Ceiling Attached to Rafters, L/Δ = 240)

RAFTER SPACING (inches)	SPECIES AND GRADE	DEAD LOAD = 10 [pounds per square foot] psf					DEAD LOAD = 20 [pounds per square foot] psf				
		2 × 4	2 × 6	2 × 8	2 × 10	2 × 12	2 × 4	2 × 6	2 × 8	2 × 10	2 × 12
		Maximum rafter spans ^a									
		(ft. – in.)	(ft. – in.)	(ft. – in.)	(ft. – in.)	(ft. – in.)	(ft. – in.)	(ft. – in.)	(ft. – in.)	(ft. – in.)	(ft. – in.)
	Spruce-Pine-Fir #3	5-0	7-4	9-4	11-5	13-2	4-8	6-10	8-8	10-6	12-3
19.2	Douglas Fir-Larch SS	6-7	10-4	13-7	17-4	20-6	6-7	10-4	13-5	16-5	19-0
	Douglas Fir-Larch #1	6-4	9-6	12-0	14-8	17-1	6-0	8-10	11-2	13-7	15-9
	Douglas Fir-Larch #2	6-1	8-11	11-3	13-9	15-11	5-7	8-3	10-5	12-9	14-9
	Douglas Fir-Larch #3	4-7	6-9	8-6	10-5	12-1	4-3	6-3	7-11	9-7	11-2
	Hem-Fir SS	6-2	9-9	12-10	16-5	19-11	6-2	9-9	12-10	16-1	18-8
	Hem-Fir #1	6-1	9-3	11-9	14-4	16-7	5-10	8-7	10-10	13-3	15-5
	Hem-Fir #2	5-9	8-9	11-1	13-7	15-9	5-7	8-1	10-3	12-7	14-7
	Hem-Fir #3	4-7	6-9	8-6	10-5	12-1	4-3	6-3	7-11	9-7	11-2
	Southern Pine SS	6-5	10-2	13-4	17-0	20-9	6-5	10-2	13-4	17-0	20-9
	Southern Pine #1	[6-4] 6-2	[9-11] 9-8	[13-4] 12-3	[16-0] 14-4	[19-4] 17-1	[6-4] 6-0	[9-11] 9-0	[12-5] 11-4	[14-10] 13-4	[17-8] 15-9
	Southern Pine #2	[6-2] 5-7	[9-4] 8-4	[12-0] 10-7	[14-4] 12-6	[16-10] 14-9	[6-0] 5-2	[8-8] 7-9	[11-2] 9-9	[13-4] 11-7	[15-7] 13-8
	Southern Pine #3	[4-11] 4-3	[7-3] 6-4	[9-2] 8-0	[10-10] 9-8	[12-11] 11-5	[4-6] 4-0	[6-8] 5-10	[8-6] 7-4	[10-1] 8-11	[12-0] 10-7
	Spruce-Pine-Fir SS	6-1	9-6	12-7	16-0	19-1	6-1	9-6	12-5	15-3	17-8
	Spruce-Pine-Fir #1	5-11	8-11	11-3	13-9	15-11	5-7	8-3	10-5	12-9	14-9
	Spruce-Pine-Fir #2	5-11	8-11	11-3	13-9	15-11	5-7	8-3	10-5	12-9	14-9
	Spruce-Pine-Fir #3	4-7	6-9	8-6	10-5	12-1	4-3	6-3	7-11	9-7	11-2
24	Douglas Fir-Larch SS	6-1	9-7	12-7	15-10	18-4	6-1	9-6	12-0	14-8	17-0
	Douglas Fir-Larch #1	5-10	8-6	10-9	13-2	15-3	5-5	7-10	10-0	12-2	14-1
	Douglas Fir-Larch #2	5-5	7-11	10-1	12-4	14-3	5-0	7-4	9-4	11-5	13-2
	Douglas Fir-Larch #3	4-1	6-0	7-7	9-4	10-9	3-10	5-7	7-1	8-7	10-0
	Hem-Fir SS	5-9	9-1	11-11	15-12	18-0	5-9	9-1	11-9	14-5	16-8
	Hem-Fir #1	5-8	8-3	10-6	12-10	14-10	5-3	7-8	9-9	11-10	13-9
	Hem-Fir #2	5-4	7-10	9-11	12-1	14-1	4-11	7-3	9-2	11-3	13-0
	Hem-Fir #3	4-1	6-10	7-7	9-4	10-9	3-10	5-7	7-1	8-7	10-0
	Southern Pine SS	6-0	9-5	12-5	15-10	19-3	6-0	9-5	12-5	15-10	19-3
	Southern Pine #1	[5-10] 5-9	[9-3] 8-8	[12-0] 11-0	[14-4] 12-10	[17-4] 15-3	[5-10] 5-5	[8-10] 8-0	[11-2] 10-2	[13-3] 11-11	[15-9] 14-1
	Southern Pine #2	[5-9] 5-0	[8-4] 7-5	[10-9] 9-5	[12-10] 11-3	[15-4] 13-2	[5-5] 4-7	[7-9] 6-11	[10-0] 8-9	[11-11] 10-5	[13-11] 12-3
	Southern Pine #3	[4-4] 3-10	[6-5] 5-8	[8-3] 7-1	[9-9] 8-8	[11-7] 10-3	[4-1] 3-6	[6-0] 5-3	[7-7] 6-7	[9-0] 8-0	[10-8] 9-6
	Spruce-Pine-Fir SS	5-8	8-10	11-8	14-8	17-1	5-8	8-10	11-2	13-7	15-9
	Spruce-Pine-Fir #1	5-5	7-11	10-1	12-4	14-3	5-0	7-4	9-4	11-5	13-2
	Spruce-Pine-Fir #2	5-5	7-11	10-1	12-4	14-3	5-0	7-4	9-4	11-5	13-2
	Spruce-Pine-Fir #3	4-1	6-0	7-7	9-4	10-9	3-10	5-7	7-1	8-7	10-0

Check sources for availability of lumber in lengths greater than 20 feet.

For SI: 1 inch = 25.4 mm, 1 foot = [304] 304.8 mm, 1 pound per square foot = [47.9 N/m²] 0.0479 kPa.

a. The tabulated rafter spans assume that ceiling joists are located at the bottom of the attic space or that some other method of resisting the outward push of the rafters on the bearing walls, such as rafter ties, is provided at that location. Where ceiling joists or rafter ties are located higher in the attic space, the rafter spans shall be

multiplied by the following factors:

H_c/H_R	Rafter Span Adjustment Factor
1/3	0.67
1/4	0.76
1/5	0.83
1/6	0.90
1/7.5 or less	1.00

where:

H_c = Height of ceiling joists or rafter ties measured vertically above the top of the rafter support walls.

H_R = Height of roof ridge measured vertically above the top of the rafter support walls.

[2308.10.4] 2308.7.3 Ceiling joist and rafter framing. Rafters shall be framed directly opposite each other at the ridge. There shall be a ridge board ~~[at least]~~ not less than 1-inch (25 mm) nominal thickness at ridges and not less in depth than the cut end of the rafter. At valleys and hips, there shall be a single valley or hip rafter not less than 2-inch (51 mm) nominal thickness and not less in depth than the cut end of the rafter.

[2308.10.4.1] 2308.7.3.1 Ceiling joist and rafter connections. Ceiling joists and rafters shall be nailed to each other and the assembly shall be nailed to the top wall plate in accordance with Tables ~~[2304.9.1]~~ 2304.10.1 and ~~[2308.10.4.1]~~ 2308.7.5. Ceiling joists shall be continuous or securely joined where they meet over interior partitions and be fastened to adjacent rafters in accordance with Tables [2308.10.4.1] 2304.10.1 and [2304.9.1] 2308.7.3.1 to provide a continuous rafter tie across the building where such joists are parallel to the rafters. Ceiling joists shall have a bearing surface of not less than 1½ inches (38 mm) on the top plate at each end.

Where ceiling joists are not parallel to rafters, an equivalent rafter tie shall be installed in a manner to provide a continuous tie across the building, at a spacing of not more than 4 feet (1219 mm) ~~[o.c.]~~ on center. The connections shall be in accordance with Tables ~~[2308.10.4.1]~~ 2304.10.1 and ~~[2304.9.1]~~ 2308.7.3.1, or connections of equivalent capacities shall be provided. Where ceiling joists or rafter ties are not provided at the top of the rafter support walls, the ridge formed by these rafters shall also be supported by a girder conforming to Section ~~[2308.4]~~ 2308.8. Rafter ties shall be spaced not more than 4 feet (1219 mm) ~~[o.c.]~~ on center.

Rafter tie connections shall be based on the equivalent rafter spacing in Table ~~[2308.10.4.1] 2308.7.3.1.~~ ~~[Where rafter ties are spaced at 32 inches (813 mm) o.c., the number of 16d common nails shall be two times the number specified for rafters spaced 16 inches (406 mm) o.c., with a minimum of four 1-6d common nails where no snow loads are indicated. Where rafter ties are spaced at 48 inches (1219 mm) o.c., the number of 16d common nails shall be two times the number specified for rafters spaced 24 inches (610 mm) o.c., with a minimum of six 16d common nails where no snow loads are indicated. Rafter/ceiling joist connections and rafter/tie connections shall be of sufficient size and number to prevent splitting from nailing.]~~ Rafter-to-ceiling joist connections and rafter tie connections shall be of sufficient size and number to prevent splitting from nailing.

Roof framing member connection to braced wall lines shall be in accordance with Section 2308.6.7.2.

**TABLE [2308.10.4.1] 2308.7.3.1
RAFTER TIE CONNECTIONS^g**

RAFTER SLOPE	TIE SPACING (inches)	GROUND SNOW LOAD ([pound] pounds per square foot)											
		NO SNOW LOAD				30 pounds per square foot				50 pounds per square foot			
		Roof span (feet)											
		12	20	28	36	12	20	28	36	12	20	28	36
Required number of 16d common (3 1/2" x 0.162") nails ^{a,b} per connection ^{c,d,e,f}													
3:12	12	4	6	8	10	4	6	8	11	5	8	12	15
	16	5	7	10	13	5	8	11	14	6	11	15	20
	24	7	11	15	19	7	11	16	21	9	16	23	30
	32	10	14	19	25	10	16	22	28	12	27	30	40
	48	14	21	29	37	14	32	36	42	18	32	46	60
4:12	12	3	4	5	6	3	5	6	8	4	6	9	11
	16	3	5	7	8	4	6	8	11	5	8	12	15
	24	4	7	10	12	5	9	12	16	7	12	17	22
	32	6	9	13	16	8	12	16	22	10	16	24	30
	48	8	14	19	24	10	18	24	32	14	24	34	44
5:12	12	3	3	4	5	3	4	5	7	3	5	7	9
	16	3	4	5	7	3	5	7	9	4	7	9	12
	24	4	6	8	10	4	7	10	13	6	10	14	18
	32	5	8	10	13	6	10	14	18	8	14	18	24
	48	7	11	15	20	8	14	20	26	12	20	28	36
7:12	12	3	3	3	4	3	3	4	5	3	4	5	7
	16	3	3	4	5	3	4	5	6	3	5	7	9
	24	3	4	6	7	3	5	7	9	4	7	10	13
	32	4	6	8	10	4	8	10	12	6	10	14	18
	48	5	8	11	14	6	10	14	18	9	14	20	26
9:12	12	3	3	3	3	3	3	3	4	3	3	4	5
	16	3	3	3	4	3	3	4	5	3	4	5	7
	24	3	3	5	6	3	4	6	7	3	6	8	10
	32	3	4	6	8	4	6	8	10	5	8	10	14
	48	4	6	9	11	5	8	12	14	7	12	16	20
12:12	12	3	3	3	3	3	3	3	3	3	3	3	4
	16	3	3	3	3	3	3	3	4	3	3	4	5
	24	3	3	3	4	3	3	4	6	3	4	6	8
	32	3	3	4	5	3	5	6	8	4	6	8	10
	48	3	4	6	7	4	7	8	12	6	8	12	16

For SI: 1 inch = 25.4 mm, 1 foot = [304] 304.8 mm, 1 pound per square foot = 47.8 N/m².

a. 40d box (5" x 0.162") or 16d sinker (3 1/4" x 0.148") nails are permitted to be substituted for 16d common (3 1/2" x 0.16") nails.

b. Nailing requirements are permitted to be reduced 25 percent if nails are clinched.

c. Rafter tie heel joint connections are not required where the ridge is supported by a load-bearing wall, header or ridge beam.

d. When intermediate support of the rafter is provided by vertical struts or purlins to a load-bearing wall, the tabulated heel joint connection requirements are permitted to be reduced proportionally to the reduction in span.

e. Equivalent nailing patterns are required for ceiling joist to ceiling joist lap splices.

f. Connected members shall be of sufficient size to prevent splitting due to nailing.

g. For snow loads less than 30 pounds per square foot, the required number of nails is permitted to be reduced by multiplying by the ratio of actual snow load plus 10 divided by 40, but not less than the number required for no snow load.

[2308.10.4.2] 2308.7.4 Notches and holes. Notching at the ends of rafters or ceiling joists shall not exceed one-fourth the depth. Notches in the top or bottom of the rafter or ceiling joist shall not exceed one-sixth the depth and shall not be located in the middle one-third of the span, except that a notch not [exceeding] more than one-third of the depth is permitted in the top of the rafter or ceiling joist not further from the face of the support than the depth of the member. Holes bored in rafters or ceiling joists shall not be within 2 inches (51 mm) of the top and bottom and their diameter shall not exceed one-third the depth of the member.

2308.7.5 Wind uplift. The roof construction shall have rafter and truss ties to the wall below. Resultant uplift loads shall be transferred to the foundation using a continuous load path. The rafter or truss to wall connection shall comply with Tables 2304.10.1 and 2308.7.5.

**TABLE 2308.7.5
REQUIRED RATING OF APPROVED UPLIFT CONNECTORS (pounds)^{a,b,c,e,f,g,h}**

ALLOWABLE STRESS DESIGN WIND SPEED, V _{base} ^k	ROOF SPAN (feet)							OVERHANGS (pounds/feet) ^d
	12	20	24	28	32	36	40	
85	-72	-120	-145	-169	-193	-217	-241	-38.55

90	-91	-151	-181	-212	-242	-272	-302	-43.22
100	-131	-281	-262	-305	-349	-393	-436	-53.36
110	-175	-292	-351	-409	-467	-526	-584	-64.56

For SI: 1 inch = 25.4 mm, 1 foot = 304.8 mm, 1 mile per hour = 1.61 km/hr, 1 pound = 0.454 Kg, 1 pound per foot = 14.5939 N/m.

a. The uplift connection requirements are based on a 30-foot mean roof height located in Exposure B. For Exposure C or D and for other mean roof heights, multiply the above loads by the adjustment coefficients below.

EXPOSURE	Mean Roof Height (feet)									
	15	20	25	30	35	40	45	50	55	60
B	1.00	1.00	1.00	1.00	1.05	1.09	1.12	1.16	1.19	1.22
C	1.21	1.29	1.35	1.40	1.45	1.49	1.53	1.56	1.59	1.62
D	1.47	1.55	1.61	1.66	1.70	1.74	1.78	1.81	1.84	1.87

b. The uplift connection requirements are based on the framing being spaced 24 inches on center. Multiply by 0.67 for framing spaced 16 inches on center and multiply by 0.5 for framing spaced 12 inches on center.

c. The uplift connection requirements include an allowance for 10 pounds of dead load.

d. The uplift connection requirements do not account for the effects of overhangs. The magnitude of the above loads shall be increased by adding the overhang loads found in the table. The overhang loads are also based on framing spaced 24 inches on center. The overhang loads given shall be multiplied by the overhang projection and added to the roof uplift value in the table.

e. The uplift connection requirements are based upon wind loading on end zones as defined in Figure 28.5-1 of ASCE 7. Connection loads for connections located a distance of 20 percent of the least horizontal dimension of the building from the corner of the building are permitted to be reduced by multiplying the table connection value by 0.7 and multiplying the overhang load by 0.8.

f. For wall-to-wall and wall-to-foundation connections, the capacity of the uplift connector is permitted to be reduced by 100 pounds for each full wall above. (For example, if a 500-pound rated connector is used on the roof framing, a 400-pound rated connector is permitted at the next floor level down).

g. Interpolation is permitted for intermediate values of V_{wind} and roof spans.

h. The rated capacity of approved tie-down devices is permitted to include up to a 60-percent increase for wind effects where allowed by material specifications.

i. V_{wind} shall be determined in accordance with Section 1609.3.1.

[2308.10.4.3] 2308.7.6 Framing around openings. Trimmer and header rafters shall be doubled, or of lumber of equivalent cross section, where the span of the header exceeds 4 feet (1219 mm). The ends of header rafters that are more than 6 feet (1829 mm) ~~long~~ in length shall be supported by framing anchors or rafter hangers unless bearing on a beam, partition or wall.

2308.7.6.1 Openings in roof diaphragms in Seismic Design Categories B, C and D. In buildings classified as Seismic Design Category B, C or D, openings in horizontal diaphragms with a dimension that is greater than 4 feet (1219 mm) shall be constructed with metal ties and blocking in accordance with this section and Figure 2308.4.4.1(1). Metal ties shall be not less than 0.058 inch (1.47 mm) (16 galvanized gage) in thickness by 1½ inches (38 mm) in width and shall have a yield stress not less than 33,000 psi (227 Mpa). Blocking shall extend not less than the dimension of the opening in the direction of the tie and blocking. Ties shall be attached to blocking in accordance with the manufacturer's instructions but with not less than eight 16d common nails on each side of the header-joint intersection.

[2308.10.5] 2308.7.7 Purlins. Purlins to support roof loads are permitted to be installed to reduce the span of rafters within allowable limits and shall be supported by struts to bearing walls. The maximum span of a 2-inch by 4-inch (51 mm by 102 mm) ~~purlins~~ purlin shall be 4 feet (1219 mm). The maximum span of ~~the~~ a 2-inch by 6-inch (51 mm by 152 mm) purlin shall be 6 feet (1829 mm), but in no case shall the purlin be smaller than the supported rafter. Struts shall be not ~~be smaller~~ less than 2-inch by 4-inch (51 mm by 102 mm) members. The unbraced length of struts shall not exceed 8 feet (2438 mm) and the ~~minimum~~ slope of the struts shall be not ~~be~~ less than 45 degrees (0.79 rad) from the horizontal.

[2308.10.6] 2308.7.8 Blocking. Roof rafters and ceiling joists shall be supported laterally to prevent rotation and lateral displacement in accordance with ~~the provisions of~~ Section ~~[2308.8.5]~~ 2308.4.6 and shall be connected to braced wall lines in accordance with Section 2308.6.7.2.

[2308.10.7] 2308.7.9 Engineered wood products. Prefabricated wood I-joists, structural glued-laminated timber and structural composite lumber shall not be notched or drilled except where

permitted by the manufacturer's recommendations or where the effects of such alterations are specifically considered in the design of the member by a registered design professional.

[2308.10.8] 2308.7.10 Roof sheathing. Roof sheathing shall be in accordance with Tables [2304.7(3)] 2304.8(3) and [2304.7(5)] 2304.8(5) for wood structural panels, and Tables [2304.7(1)] 2304.8(1) and [2304.7(2)] 2304.8(2) for lumber and shall comply with Section [2304.7.2] 2304.8.2.

[2308.10.8.1] 2308.7.11 Joints. Joints in lumber sheathing shall occur over supports unless approved end-matched lumber is used, in which case each piece shall bear on at least two supports.

[2308.10.9] 2308.7.12 Roof planking. Planking shall be designed in accordance with the general provisions of this code.

In lieu of such design, 2-inch (51 mm) ~~tongue-and-groove~~ tongue-and-groove planking is permitted in accordance with Table [2308.10.9] 2308.7.12. Joints in such planking are permitted to be randomly spaced, provided the system is applied to not less than three continuous spans, planks are center matched and end matched or splined, each plank bears on at least one support, and joints are separated by ~~at least~~ not less than 24 inches (610 mm) in adjacent pieces.

**TABLE [2308.10.9] 2308.7.12
ALLOWABLE SPANS FOR 2-INCH TONGUE-AND-GROOVE DECKING**

SPAN ^a (feet)	LIVE LOAD (pound) pounds per square foot)	DEFLECTION LIMIT	BENDING STRESS (<i>f</i>) (pound) pounds per square inch)	MODULUS OF ELASTICITY (<i>E</i>) (pound) pounds per square inch)
Roofs				
4	20	1/240 1/360	160	170,000 256,000
	30	1/240 1/360	210	256,000 384,000
	40	1/240 1/360	270	340,000 512,000
4.5	20	1/240 1/360	200	242,000 305,000
	30	1/240 1/360	270	363,000 405,000
	40	1/240 1/360	350	484,000 725,000
5.0	20	1/240 1/360	250	332,000 500,000
	30	1/240 1/360	330	495,000 742,000
	40	1/240 1/360	420	660,000 1,000,000
5.5	20	1/240 1/360	300	442,000 660,000
	30	1/240 1/360	400	662,000 998,000
	40	1/240 1/360	500	884,000 1,330,000
6.0	20	1/240 1/360	360	575,000 862,000
	30	1/240 1/360	480	862,000 1,295,000
	40	1/240 1/360	600	1,150,000 1,730,000
6.5	20	1/240 1/360	420	595,000 892,000
	30	1/240	560	892,000

**TABLE [2308.10.9] 2308.7.12
ALLOWABLE SPANS FOR 2-INCH TONGUE-AND-GROOVE DECKING**

SPAN ^a (feet)	LIVE LOAD (pound) pounds per square foot)	DEFLECTION LIMIT	BENDING STRESS (f) (pound) pounds per square inch)	MODULUS OF ELASTICITY (E) (pound) pounds per square inch)
		1/360		1,340,000
	40	1/240 1/360	700	1,190,000 1,730,000
7.0	20	1/240 1/360	490	910,000 1,360,000
	30	1/240 1/360	650	1,370,000 2,000,000
	40	1/240 1/360	810	1,820,000 2,725,000
7.5	20	1/240 1/360	560	1,125,000 1,685,000
	30	1/240 1/360	750	1,685,000 2,530,000
	40	1/240 1/360	930	2,250,000 3,380,000
8.0	20	1/240 1/360	640	1,360,000 2,040,000
	30	1/240 1/360	850	2,040,000 3,060,000
	Floors			
4	40	1/360	840	1,000,000
4.5			950	1,300,000
5.0			1,060	1,600,000

For SI: 1 inch = 25.4 mm, 1 foot = 304.8 mm, 1 pound per square foot = 0.0479 kN/m², 1 pound per square inch = 0.00689 N/mm².

a. Spans are based on simple beam action with 10 pounds per square foot dead load and provisions for a 300-pound concentrated load on a 12-inch width of decking. Random layup is permitted in accordance with the provisions of Section [2308.10.9] 2308.7.12. Lumber thickness is 1½ inches [~~nominal~~] actual.

[2308.10.10] 2308.7.13 Wood trusses. Wood trusses shall be designed in accordance with Section 2303.4. Connection to braced wall lines shall be in accordance with Section 2308.6.7.2.

[2308.10.11] 2308.7.14 Attic ventilation. For attic ventilation, see Section 1203.2. For provisions related to cutting and notching of members, see Section 2308.7.4.

~~**[2308.11 Additional requirements for conventional construction in Seismic Design Category B or C.** Structures of conventional light frame construction in Seismic Design Category B or C, as determined in Section 1613, shall comply with Sections 2308.11.1 through 2308.11.3, in addition to the provisions of Sections 2308.1 through 2308.10.]~~

~~**[2308.11.1 Number of stories.** Structures of conventional light frame construction shall not exceed two stories above grade plane in Seismic Design Category C.]~~

~~**[2308.11.2 Concrete or masonry.** Concrete or masonry walls and stone or masonry veneer shall not extend above a basement.]~~

[Exceptions:]

- ~~[1. Masonry stone and masonry veneer is permitted to be used in the first two stories above grade plane or the first three stories above grade plane where the lowest story has concrete or masonry walls in Seismic Design Category B, provided that structural use panel wall bracing is used and the length of bracing provided is one and one half times the required length as determined in Table 2308.9.3(1).]~~

~~[2. Stone and masonry veneer is permitted to be used in the first story above grade plane or the first two stories above grade plane where the lowest story has concrete or masonry walls in Seismic Design Category B or C.]~~

~~[3. Stone and masonry veneer is permitted to be used in both stories of buildings with two stories above grade plane in Seismic Design Categories B and C, provided the following criteria are met:]~~

~~[3.1. Type of brace per Section 2308.9.3 shall be Method 3 and the allowable shear capacity in accordance with Table 2306.3 shall be a minimum of 350 plf (5108 N/m).]~~

~~[3.2. Braced wall panels in the second story shall be located in accordance with Section 2308.9.3 and not more than 25 feet (7620 mm) on center, and the total length of braced wall panels shall be not less than 25 percent of the braced wall line length. Braced wall panels in the first story shall be located in accordance with Section 2308.9.3 and not more than 25 feet (7620 mm) on center, and the total length of braced wall panels shall be not less than 45 percent of the braced wall line length.]~~

~~[3.3. Hold down connectors shall be provided at the ends of each braced wall panel for the allowable design of 2,000 pounds (8896 N). Hold down connectors shall be provided at the ends of each braced wall panel for the first story to foundation connection with an allowable capacity of 3,900 pounds (17 347 N). In all cases, the hold down connector force shall be transferred to the foundation.]~~

~~[3.4. Cripple walls shall not be permitted.]~~

~~**[2308.11.3 Framing and connection details.** Framing and connection details shall conform to Sections 2308.11.3.1 through 2308.11.3.3.]~~

~~**[2308.11.3.1 Anchorage.** Braced wall lines shall be anchored in accordance with Section 2308.6 at foundations.]~~

~~**[2308.11.3.2 Stepped footings.** Where the height of a required braced wall panel extending from foundation to floor above varies more than 4 feet (1219 mm), the following construction shall be used:]~~

~~[1. Where the bottom of the footing is stepped and the lowest floor framing rests directly on a sill bolted to the footings, the sill shall be anchored as required in Section 2308.3.3.]~~

~~[2. Where the lowest floor framing rests directly on a sill bolted to a footing not less than 8 feet (2438 mm) in length along a line of bracing, the line shall be considered to be braced. The double plate of the cripple stud wall beyond the segment of footing extending to the lowest framed floor shall be spliced to the sill plate with metal ties, one on each side of the sill and plate. The metal ties shall not be less than 0.058 inch [1.47 mm (16 galvanized gage)] by 11/2 inches (38mm) wide by 48 inches (1219mm)~~

with eight 16d common nails on each side of the splice location (see Figure 2308.11.3.2). The metal tie shall have a minimum yield of 33,000 pounds per square inch (psi) (227 MPa). Where cripple walls occur between the top of the footing and the lowest floor framing, the bracing requirements for a story shall apply.]

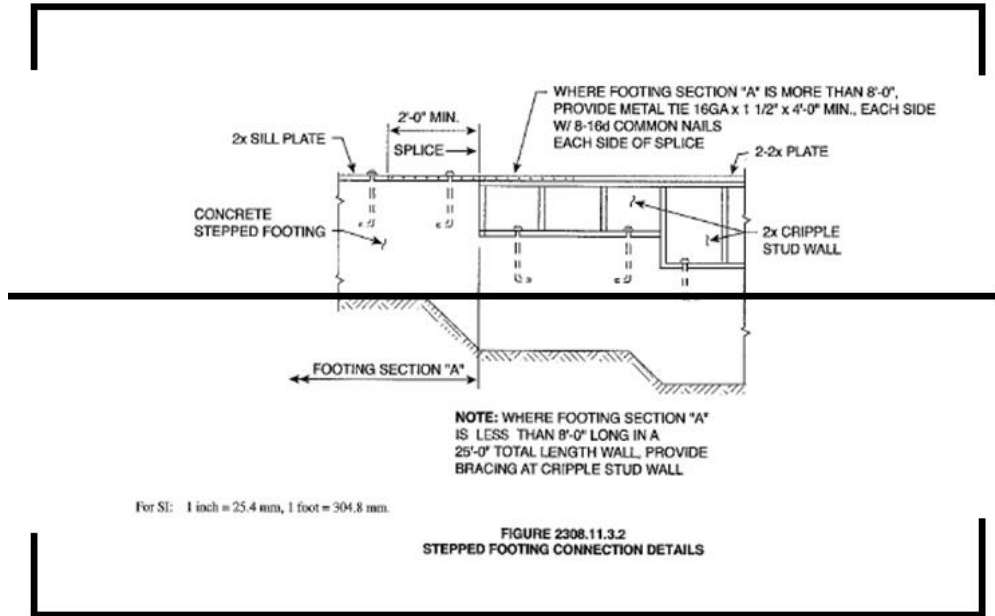

[2308.11.3.3 Openings in horizontal diaphragms. Openings in horizontal diaphragms with a dimension perpendicular to the joist that is greater than 4 feet (1219 mm) shall be constructed in accordance with the following:]

- [1. Blocking shall be provided beyond headers.]
- [2. Metal ties not less than 0.058 inch [1.47 mm (16 galvanized gage)] by 1 1/2 inches (38 mm) wide with eight 16d common nails on each side of the header joist intersection shall be provided (see Figure 2308.11.3.3). The metal ties shall have a minimum yield of 33,000 psi (227 MPa).]

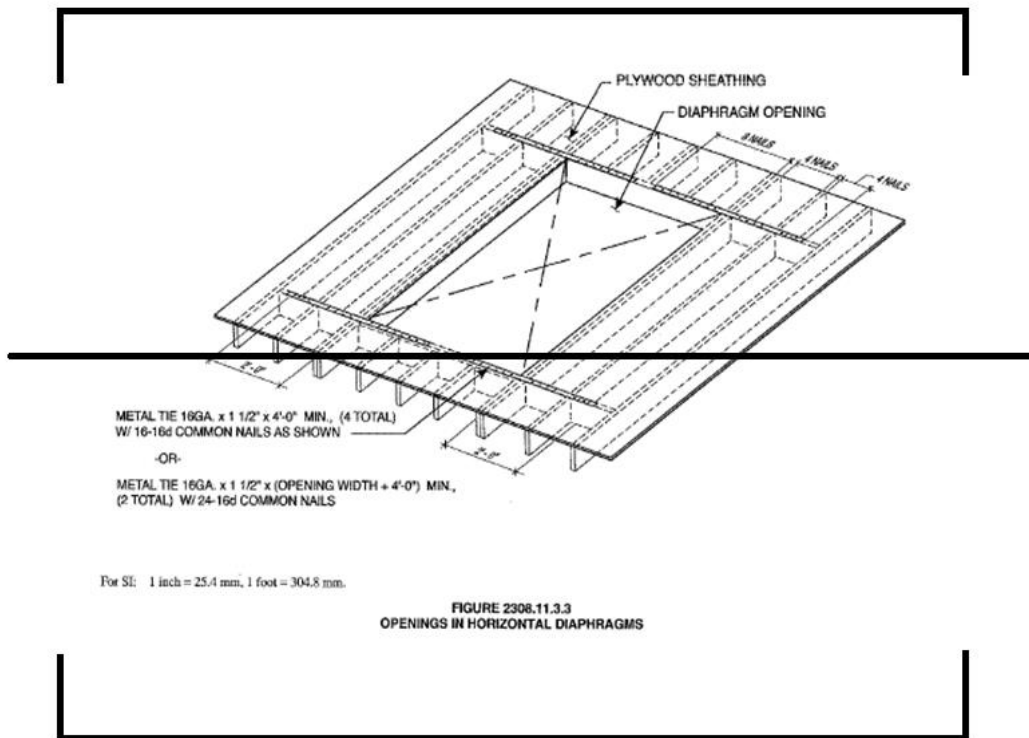

~~[2308.12 Additional requirements for conventional construction in Seismic Design Category D. Structures of conventional light frame construction in Seismic Design Category D as determined in Section 1613, shall conform to Sections 2308.12.1 through 2308.12.8, in addition to the requirements for Seismic Design Category B or C in Section 2308.11.]~~

~~[2308.12.1 Number of stories. Structures of conventional light frame construction shall not exceed one story above grade plane in Seismic Design Category D.]~~

~~[2308.12.2 Concrete or masonry. Concrete or masonry walls and stone or masonry veneer shall not extend above a basement.]~~

~~[Exception: Stone and masonry veneer is permitted to be used in the first story above grade plane in Seismic Design Category D, provided the following criteria are met:]~~

- ~~[1. Type of brace in accordance with Section 2308.9.3 shall be Method 3 and the allowable shear capacity in accordance with Table 2306.3 shall be a minimum of 350 plf (5108 N/m).]~~
- ~~[2. The bracing of the first story shall be located at each end and at least every 25 feet (7620 mm) o.c. but not less than 45 percent of the braced wall line.]~~
- ~~[3. Hold down connectors shall be provided at the ends of braced walls for the first floor to foundation with an allowable capacity of 2,100 pounds (9341 N).]~~

[4. Cripple walls shall not be permitted.]

[2308.12.3 Braced wall line spacing. Spacing between interior and exterior braced wall lines shall not exceed 25 feet (7620 mm).]

[2308.12.4 Braced wall line sheathing. Braced wall lines shall be braced by one of the types of sheathing prescribed by Table 2308.12.4 as shown in Figure 2308.9.3. The sum of lengths of braced wall panels at each braced wall line shall conform to Table 2308.12.4. Braced wall panels shall be distributed along the length of the braced wall line and start at not more than 8 feet (2438 mm) from each end of the braced wall line. Panel sheathing joints shall occur over studs or blocking. Sheathing shall be fastened to studs and top and bottom plates and at panel edges occurring over blocking. Wall framing to which sheathing used for bracing is applied shall be nominal 2 inch wide [actual 1 1/2 inch (38 mm)] or larger members. Cripple walls having a stud height exceeding 14 inches (356 mm) shall be considered a story for the purpose of this section and shall be braced as required for braced wall lines in accordance with Table 2308.12.4. Where interior braced wall lines occur without a continuous foundation below, the length of parallel exterior cripple wall bracing shall be one and one-half times the lengths required by Table 2308.12.4. Where the cripple wall sheathing type used is Type S-W and this additional length of bracing cannot be provided, the capacity of Type S-W sheathing shall be increased by reducing the spacing of fasteners along the perimeter of each piece of sheathing to 4 inches (102 mm) o.c.]

**[TABLE 2308.12.4
WALL BRACING IN SEISMIC DESIGN CATEGORIES D AND E
(Minimum Length of Wall Bracing per each 25 Linear Feet of Braced Wall Line^a)**

CONDITION	SHEATHING TYPE ^b	$S_{DS} < 0.50$	$0.50 \leq S_{DS} < 0.75$	$0.75 \leq S_{DS} < 1.00$	$S_{DS} > 1.00$
One-story	G-P ^c	10 feet 8 inches	14 feet 8 inches	18 feet 8 inches	25 feet 0 inches
	S-W	5 feet 4 inches	8 feet 0 inches	9 feet 4 inches	12 feet 0 inches

For SI: 1 inch = 25.4 mm, 1 foot = 304.8 mm.

a. Minimum length of panel bracing of one face of the wall for S-W sheathing or both faces of the wall for G-P sheathing; h/w ratio shall not exceed 2:1. For S-W panel bracing of the same material on two faces of the wall, the minimum length is permitted to be one-half the tabulated value but the h/w ratio shall not exceed 2:1 and design for uplift is required.

b. G-P = gypsum board, fiberboard, particleboard, lath and plaster or gypsum sheathing boards; S-W = wood structural panels and diagonal wood sheathing.

c. Nailing as specified below shall occur at all panel edges at studs, at top and bottom plates and, where occurring, at blocking:

For 5/8-inch gypsum board, 5d (0.113 inch diameter) cooler nails at 7 inches on center;

For 5/8-inch gypsum board, No. 11 gage (0.120 inch diameter) at 7 inches on center;

For gypsum sheathing board, 1 3/4 inches long by 7/16 inch head, diamond point galvanized nails at 4 inches on center;

For gypsum lath, No. 13 gage (0.092 inch) by 1 3/8 inches long, 3/16 inch head, plasterboard at 5 inches on center;

For Portland cement plaster, No. 11 gage (0.120 inch) by 1 1/2 inches long, 7/16 inch head at 6 inches on center;

For fiberboard and particleboard, No. 11 gage (0.120 inch) by 1 1/2 inches long, 7/16 inch head, galvanized nails at 3 inches on center.]

[2308.12.5 Attachment of sheathing. Fastening of braced wall panel sheathing shall not be less than that prescribed in Table 2308.12.4 or 2304.9.1. Wall sheathing shall not be attached to framing members by adhesives.]

[2308.12.6 Irregular structures. Conventional light frame construction shall not be used in irregular portions of structures in Seismic Design Category D. Such irregular portions of structures shall be designed to resist the forces specified in Chapter 16 to the extent such irregular features affect the performance of the conventional framing system. A portion of a structure shall be considered to be irregular where one or more of the conditions described in Items 1 through 6 below are present.]

[1. Where exterior braced wall panels are not in one plane vertically from the foundation to the uppermost story in which they are required, the structure shall be considered to be irregular (see Figure 2308.12.6(1)).]

[Exception: Floors with cantilevers or setbacks not exceeding four times the nominal depth of the floor joists (see Figure 2308.12.6(2)) are permitted to support braced wall panels provided:]

~~[1. Floor joists are 2 inches by 10 inches (51 mm by 254 mm) or larger and spaced not more than 16 inches (406 mm) o.c.]~~

~~[2. The ratio of the back span to the cantilever is at least 2:1.]~~

~~[3. Floor joists at ends of braced wall panels are doubled.]~~

~~[4. A continuous rim joist is connected to the ends of cantilevered joists. The rim joist is permitted to be spliced using a metal tie not less than 0.058 inch (1.47 mm) (16 galvanized gage) and 1 1/2 inches (38 mm) wide fastened with six 16d common nails on each side. The metal tie shall have a minimum yield of 33,000 psi (227 Mpa).]~~

~~[5. Joists at setbacks or the end of cantilevered joists shall not carry gravity loads from more than a single story having uniform wall and roof loads, nor carry the reactions from headers having a span of 8 feet (2438 mm) or more.]~~

~~[2. Where a section of floor or roof is not laterally supported by braced wall lines on all edges, the structure shall be considered to be irregular (see Figure 2308.12.6(3)).]~~

[Exception: Portions of roofs or floors that do not support braced wall panels above are permitted to extend up to 6 feet (1829 mm) beyond a braced wall line (see Figure 2308.12.6(4)).]

~~[3. Where the end of a required braced wall panel extends more than 1 foot (305mm) over an opening in the wall below, the structure shall be considered to be irregular. This requirement is applicable to braced wall panels offset in plane and to braced wall panels offset out of plane as permitted by the exception to Item 1 above in this section (see Figure 2308.12.6(5)).]~~

[Exception: Braced wall panels are permitted to extend over an opening not more than 8 feet (2438 mm) in width where the header is a 4 inch by 12 inch (102 mm by 305 mm) or larger member.]

~~[4. Where portions of a floor level are vertically offset such that the framing members on either side of the offset cannot be lapped or tied together in an approved manner, the structure shall be considered to be irregular (see Figure 2308.12.6(6)).]~~

[Exception: Framing supported directly by foundations need not be lapped or tied directly together.]

~~[5. Where braced wall lines are not perpendicular to each other, the structure shall be considered to be irregular (see Figure 2308.12.6(7)).]~~

~~[6. Where openings in floor and roof diaphragms having a maximum dimension greater than~~

50 percent of the distance between lines of bracing or an area greater than 25 percent of the area between orthogonal pairs of braced wall lines are present, the structure shall be considered to be irregular (see Figure 2308.12.6(8)).]

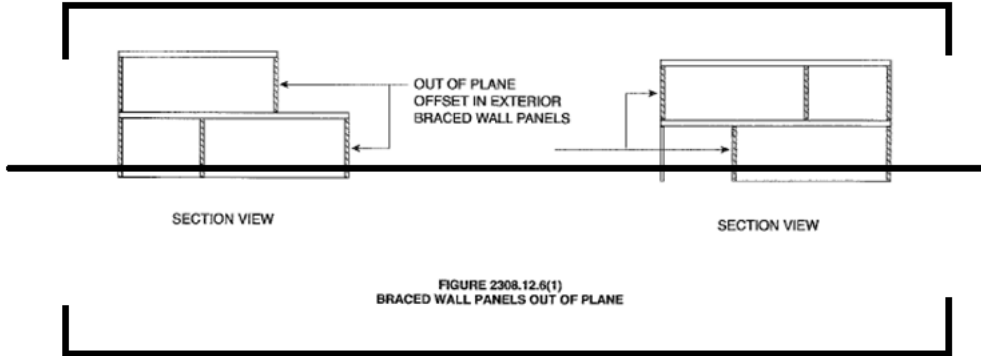

]

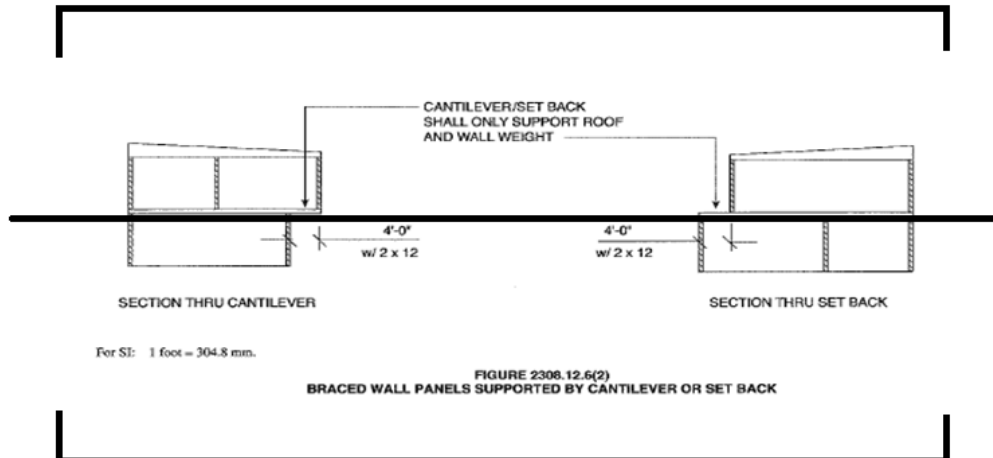

[

]

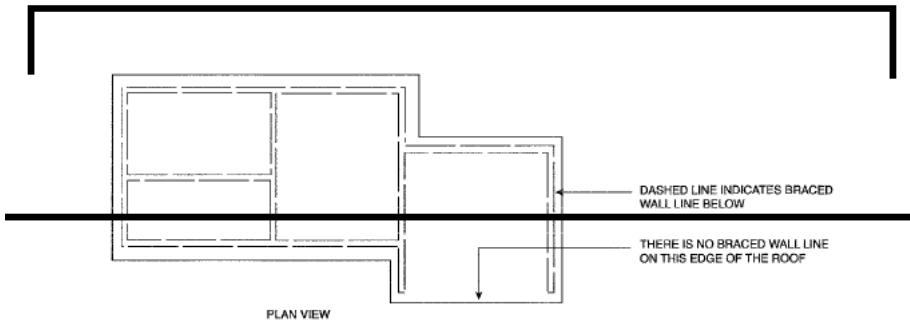
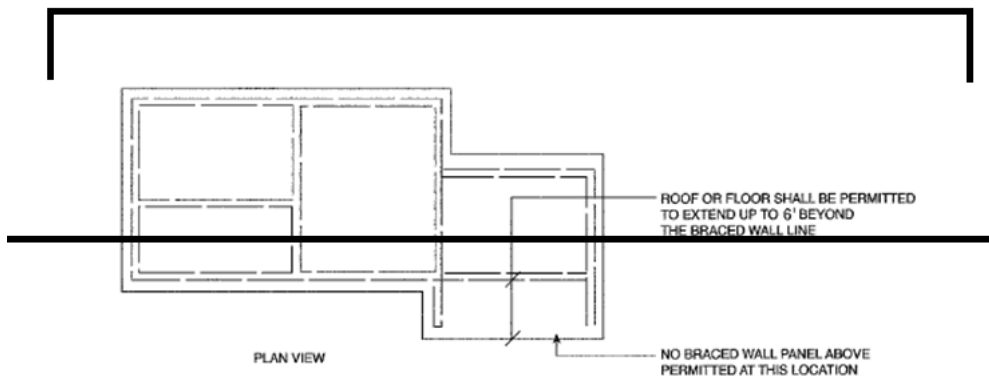
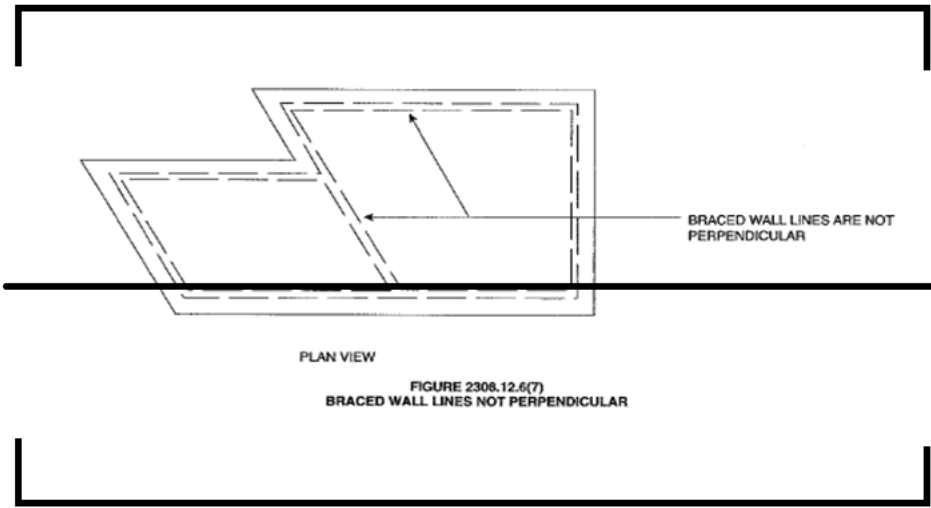
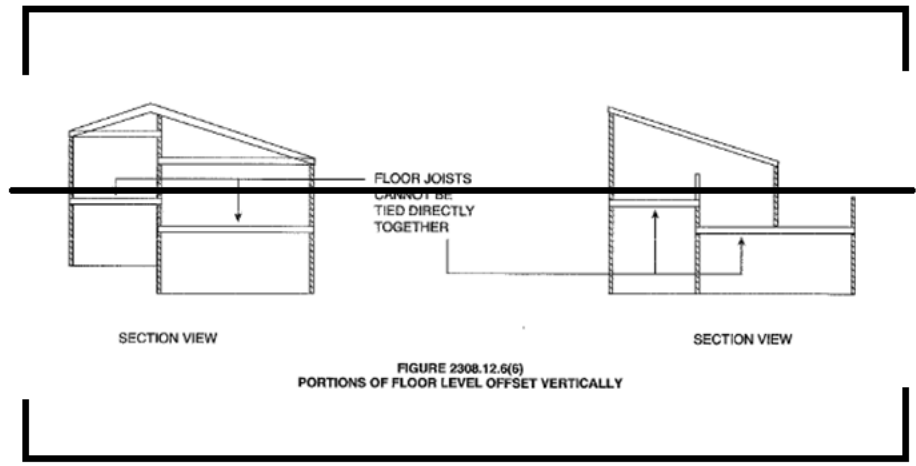
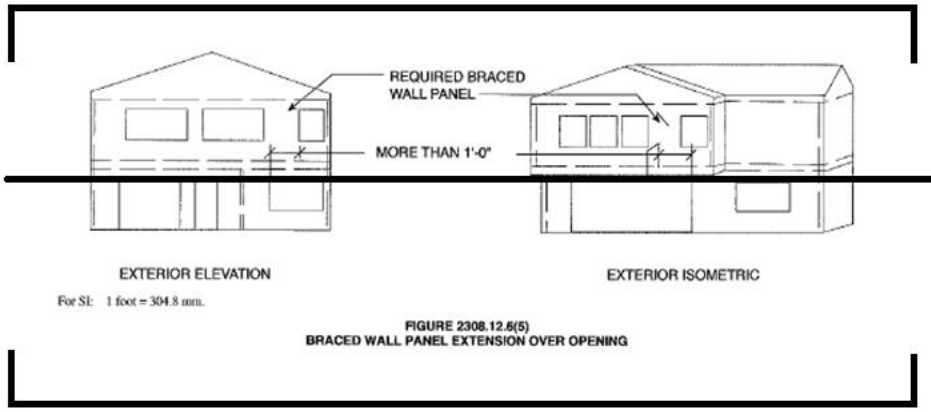

FIGURE 2308.12.6(3)
FLOOR OR ROOF NOT SUPPORTED ON ALL EDGES



For SI: 1 foot = 304.8 mm.

FIGURE 2308.12.6(4)
ROOF OR FLOOR EXTENSION BEYOND BRACED WALL LINE



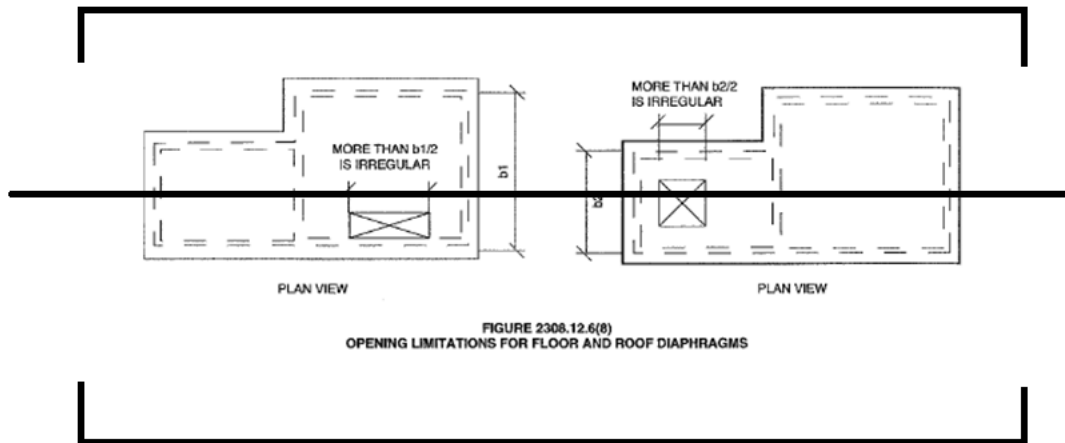

~~[2308.12.7 Anchorage of exterior means of egress components. Exterior egress balconies, exterior exit stairways and similar means of egress components shall be positively anchored to the primary structure at not over 8 feet (2438 mm) o.c. or shall be designed for lateral forces. Such attachment shall not be accomplished by use of toenails or nails subject to withdrawal.]~~

~~[2308.12.8 Sill plate anchorage. Sill plates shall be anchored with anchor bolts with steel plate washers between the foundation sill plate and the nut, or approved anchor straps load rated in accordance with Section 1716.1. Such washers shall be a minimum of 0.229 inch by 3 inches by 3 inches (5.82 mm by 76 mm by 76 mm) in size. The hole in the plate washer is permitted to be diagonally slotted with a width of up to 3/16 inch (4.76 mm) larger than the bolt diameter and a slot length not to exceed 1³/₄ inches (44 mm), provided a standard cut washer is placed between the plate washer and the nut.]~~

2308.8 Design of elements. Combining of engineered elements or systems and conventionally specified elements or systems shall be permitted subject to the limits of Sections 2308.8.1 and 2308.8.2.

2308.8.1 Elements exceeding limitations of conventional construction. Where a building of otherwise conventional construction contains structural elements exceeding the limits of Section 2308.2, these elements and the supporting load path shall be designed in accordance with accepted engineering practice and the provisions of this code.

2308.8.2 Structural elements or systems not described herein. Where a building of otherwise conventional construction contains structural elements or systems not described in Section 2308, these elements or systems shall be designed in accordance with accepted engineering practice and the provisions of this code. The extent of such design need only demonstrate compliance of the nonconventional elements with other applicable provisions of this code and shall be compatible with the performance of the conventionally framed system.

SECTION BC 2309
WOOD FRAME CONSTRUCTION MANUAL

2309.1 Wood Frame Construction Manual. Structural design in accordance with the AWC WFCM shall be permitted for buildings assigned to Risk Category I or II subject to the limitations of Section 1.1.3 of the AWC WFCM and the load assumptions contained therein. Structural elements beyond these limitations shall be designed in accordance with accepted engineering practice.

§ 24. Chapter 24 of the New York city building code, as amended by local law number 141 for the year 2013, is amended to read as follows:

CHAPTER 24
GLASS AND GLAZING

SECTION BC 2401
GENERAL

2401.1 Scope. The provisions of this chapter shall govern the materials, design, construction and quality of glass, light-transmitting ceramic and light-transmitting plastic panels for exterior and interior use in both vertical and sloped applications in buildings and structures.

2401.2 Glazing replacement. The installation of replacement glass shall be as required for new installations. See Sections 28-101.4.1, 28-101.4.2, 28-101.4.3 and 28-101.4.4 of the [~~Administrative Code~~] Administrative Code for requirements relating to prior code buildings.

Exception: Permit or inspection is not required for certain glazing repair or replacement work as described in Title 1 of the Rules of the City of New York.

SECTION BC 2402
DEFINITIONS

2402.1 Definitions. The following [~~words and~~] terms [~~shall, for the purposes of this chapter and as used elsewhere~~] are defined in [~~this code, have the meanings shown herein.~~] Chapter 2:

DALLE GLASS. [~~A decorative composite glazing material made of individual pieces of glass that are embedded in a cast matrix of concrete or epoxy.~~]

DECORATIVE GLASS. [~~A carved, leaded or Dalle glass or glazing material whose purpose is decorative or artistic, not functional; whose coloring, texture or other design qualities or components cannot be removed without destroying the glazing material and whose surface, or assembly into which it is incorporated, is divided into segments.~~]

[~~**HOISTWAY.** The hoistway is the opening through a building or structure for the travel of elevators, dumbwaiters, or material lifts, extending from the pit floor to the roof or floor above.~~]

[~~**SIDELIGHTS.**~~] **SIDELITES.**

TRANSPARENT.

TRANSPARENT DOOR.

TRANSPARENT SAFETY GLAZING MATERIALS.

SECTION BC 2403 GENERAL REQUIREMENTS FOR GLASS

2403.1 Identification. Each pane shall bear the manufacturer's label designating the type and thickness of the glass or glazing material. The identification shall not be omitted unless approved and an affidavit is furnished by the glazing contractor certifying that each [~~light~~] lite is glazed in accordance with approved construction documents that comply with the provisions of this chapter. Safety glazing shall be identified in accordance with Section 2406.3.

Each pane of tempered glass [~~, except tempered spandrel glass,~~] shall be permanently identified by the manufacturer. The identification label shall be acid etched, sand blasted, ceramic fired, laser etched, embossed or [~~shall be~~] of a type that, once applied, cannot be removed without being destroyed. [~~Tempered spandrel glass shall be provided with a removable paper marking by the manufacturer.~~]

Exception: Tempered spandrel glass shall be permanently labeled unless doing so would weaken, alter the performance of, or cause breakage of the spandrel glass, as determined by the manufacturer. Where the manufacturer makes such a determination, the tempered spandrel glass shall be provided with a removable paper marking by the manufacturer, and an affidavit shall be provided in accordance with this section.

2403.2 Glass supports. Where one or more sides of any pane of glass are not firmly supported, or are subjected to unusual load conditions, or as requested by the applicant, detailed construction documents, detailed shop drawings and analysis or test data [~~assuring~~] ensuring safe performance for the specific installation shall be prepared by [~~an architect or engineer~~] a registered design professional.

2403.3 Framing. To be considered firmly supported, the framing members for each individual pane of glass shall be designed so the deflection of the edge of the glass perpendicular to the glass pane shall not exceed $1/175$ of the glass edge length or $3/4$ inch (19.1 mm), whichever is less, when subjected to the larger of the positive or negative load where loads are combined as specified in Section 1605. Gaskets, washers, shims, seals or spacers shall be used where required to prevent contact of glass to metal components in framing and supports. The system shall allow for movement.

2403.4 Interior glazed areas. Where interior glazing is installed adjacent to a walking surface, the differential deflection of two adjacent unsupported edges shall not be greater than the thickness of the panels when a force of 50 pounds per linear foot (plf) (730 N/m) is applied horizontally to one panel at any point up to 42 inches (1067 mm) above the walking surface.

2403.5 Louvered windows or jalousies. Float, wired and patterned glass in louvered windows and jalousies shall be no thinner than nominal $3/16$ inch (4.8 mm) and no longer than 48 inches (1219 mm). Exposed glass edges shall be smooth.

Wired glass with wire exposed on longitudinal edges shall not be used in louvered windows or jalousies. ~~[Where other glass types are used, the design shall be submitted to the department for approval.]~~

Where other glass types are used, the design shall be submitted to the department for approval.

**SECTION BC 2404
WIND, SNOW, SEISMIC AND DEAD LOADS ON
GLASS**

2404.1 Vertical glass. Glass sloped 15 degrees (0.26 rad) or less from vertical in windows, curtain walls and window walls, doors and other exterior applications shall be designed to resist the ~~[wind loads in Section 1609 for components and cladding. The load resistance of glass under uniform load shall be determined in accordance with ASTM E 1300. Glass and glazing assemblies shall meet the seismic requirements of ASCE 7.]~~ wind loads in accordance with Chapter 16 for components and cladding. Glass in glazed curtain walls, glazed storefronts and glazed partitions shall meet the seismic requirements of ASCE 7, Section 13.5.9, as modified by Chapter 16. The load resistance of glass under uniform load shall be determined in accordance with ASTM E 1300. The glass breakage probability for load resistance shall be less than or equal to 8 lites per 1,000.

The design of vertical glazing shall be based on ~~[the following equation:]~~ Equation 24-1.

$$\begin{aligned}
 & \text{[} F_{gw} \leq F_{ga} \text{]} \\
 & \underline{0.6F_{gw} \leq F_{ga}} \qquad \qquad \qquad \text{(Equation 24-1)}
 \end{aligned}$$

where:

F_{gw} = Wind load on the glass due to basic design wind speed, V , computed in accordance with Section 1609.

F_{ga} = Short duration load on the glass as determined in accordance with ASTM E 1300.

2404.2 Sloped glass. Glass sloped more than 15 degrees (0.26 rad) from vertical in skylights, sunrooms, sloped roofs and other exterior applications shall be designed to resist the most critical ~~[of the following]~~ combinations of loads as determined by Equations 24-2, 24-3 and 24-4.

$$\begin{aligned}
 & \text{[} F_g = W_o + D \text{]} \\
 & \underline{F_g = 0.6W_o + D} \qquad \qquad \qquad \text{(Equation 24-2)}
 \end{aligned}$$

$$\begin{aligned}
 & \text{[} F_g = W_i + D + 0.5S \text{]} \\
 & \underline{F_g = 0.6W_i + D + 0.5S} \qquad \qquad \qquad \text{(Equation 24-3)}
 \end{aligned}$$

$$\begin{aligned}
 & \text{[} F_g = 0.5W_i + D + S \text{]} \\
 & \underline{F_g = 0.3W_i + D + S} \qquad \qquad \qquad \text{(Equation 24-4)}
 \end{aligned}$$

where:

D = Glass dead load psf (kN/m²).

For glass sloped 30 degrees (0.52 rad) or less from horizontal,

$$= 13 t_g \text{ (For SI: } 0.0245 t_g \text{)}$$

For glass sloped more than 30 degrees (0.52 rad) from horizontal,

$$= 13 t_g \cos \theta \text{ (For SI: } 0.0245 t_g \cos \theta \text{)}$$

F_g = Total load, psf (kN/m²) on glass.

S = Snow load, psf (kN/m²) as determined in Section 1608.

t_g = Total glass thickness, inches (mm) of glass panes and plies.

W_i = Inward wind force, psf (kN/m²) due to basic design wind speed, V , as calculated in Section 1609.

W_o = Outward wind force, psf (kN/m²) due to basic design wind speed, V , as calculated in Section 1609.

θ = Angle of slope from horizontal.

Exception: ~~[Unit]~~ The performance grade rating of unit skylights and tubular daylighting devices shall be [designed] determined in accordance with Section 2405.5.

The design of sloped glazing shall be based on ~~[the following equation:]~~ Equation 24-5.

$$F_g \leq F_{ga} \quad \text{(Equation 24-5)}$$

where:

F_g = Total load on the glass determined ~~[from the load combinations above]~~ by Equations 24-2, 24-3 and 24-4.

F_{ga} = Short duration load resistance of the glass as determined ~~[according to]~~ in accordance with ASTM E 1300 for Equations 24-2 and 24-3; or the long duration load resistance of the glass as determined ~~[according to]~~ in accordance with ASTM E 1300 for Equation 24-4.

2404.3 Wired, patterned and sandblasted glass.

2404.3.1 Vertical wired glass. Wired glass sloped 15 degrees (0.26 rad) or less from vertical in windows, curtain and window walls, doors and other exterior applications shall be designed to resist the wind loads in Section 1609 for components and cladding according to the following equation:

$$[\cancel{F_{gw} < 0.5F_{ge}}]$$

$$\underline{0.6F_{gw} < 0.5F_{ge}} \quad \text{(Equation 24-6)}$$

where:

F_{gw} = ~~[Is the wind]~~ Wind load on the glass due to basic design wind speed, V , computed ~~[per]~~ in accordance with Section 1609.

F_{ge} = Nonfactored load from ASTM E 1300 using a thickness designation for monolithic glass that is not greater than the thickness of wired glass.

2404.3.2 Sloped wired glass. Wired glass sloped more than 15 degrees (0.26 rad) from vertical

in skylights, sunspaces, sloped roofs and other exterior applications shall be designed to resist the most critical of the combinations of loads from Section 2404.2.

For Equations 24-2 and 24-3:

$$F_g < 0.5 F_{ge} \quad \text{(Equation 24-7)}$$

For Equation 24-4:

$$F_g < 0.3 F_{ge} \quad \text{(Equation 24-8)}$$

where:

F_g = Total load on the glass as determined by Equations 24-2, 24-3 and 24-4.

F_{ge} = Nonfactored load [~~from~~] in accordance with ASTM E 1300.

2404.3.3 Vertical patterned glass. Patterned glass sloped 15 degrees (0.26 rad) or less from vertical in windows, curtain and window walls, doors and other exterior applications shall be designed to resist the wind loads in Section 1609 for components and cladding according to [~~the following equation:~~] Equation 24-9.

$$F_{gw} < 1.0 F_{ge} \quad \text{(Equation 24-9)}$$

where:

F_{gw} = Wind load on the glass due to basic design wind speed, V, computed [~~per~~] in accordance with Section 1609.

F_{ge} = Nonfactored load [~~from~~] in accordance with ASTM E 1300. The value for patterned glass shall be based on the thinnest part of the glass. Interpolation between nonfactored load charts in ASTM E 1300 shall be permitted.

2404.3.4 Sloped patterned glass. Patterned glass sloped more than 15 degrees (0.26 rad) from vertical in skylights, sunspaces, sloped roofs and other exterior applications shall be designed to resist the most critical of the combinations of loads from Section 2404.2.

For Equations 24-2 and 24-3:

$$F_g < 1.0 F_{ge} \quad \text{(Equation 24-10)}$$

For Equation 24-4:

$$F_g < 0.6 F_{ge} \quad \text{(Equation 24-11)}$$

where:

F_g = Total load on the glass as determined by Equations 24-2, 24-3 and 24-4.

F_{ge} = Nonfactored load [~~from~~] in accordance with ASTM E 1300. The value for patterned glass shall be based on the thinnest part of the glass. Interpolation between the nonfactored load charts in ASTM E 1300 shall be permitted.

2404.3.5 Vertical sandblasted glass. Sandblasted glass sloped 15 degrees (0.26 rad) or less from vertical in windows, curtain and window walls, doors, and other exterior applications shall be designed to resist the wind loads in Section 1609 for components and cladding according to [~~the following equation:~~] Equation 24-12.

$$[F_g < 0.5 F_{ge}]$$

$$0.6F_{gw} < 0.5 F_{ge}$$

(Equation 24-12)

where:

F_{gw} = ~~[Total]~~ Wind load on the glass due to basic design wind speed, V, computed in accordance with Section 1609.

F_{ge} = Nonfactored load ~~[from]~~ in accordance with ASTM E 1300. The value for sandblasted glass is for moderate levels of sandblasting.

2404.4 Other designs. For designs outside the scope of this section, an analysis or test data for the specific installation shall be prepared by a registered design professional.

SECTION BC 2405 SLOPED GLAZING AND SKYLIGHTS

2405.1 Scope. This section applies to the installation of glass and other transparent, translucent or opaque glazing material installed at a slope more than 15 degrees (0.26 rad) from the vertical plane, including glazing materials in skylights, roofs and sloped walls.

~~[2405.1.1 Glass in walking surfaces. Glass installed in the walking surface of floors, landings, stairs and similar locations shall be designed and engineered by a registered design professional and the design shall include the applicable provisions of ASTM E 2751.]~~

2405.2 Allowable glazing materials and limitations. Sloped glazing shall be any of the following materials, subject to the listed limitations[;].

1. For monolithic glazing systems, the glazing material of the single ~~[light]~~ lite or layer shall be laminated glass with a minimum 30-mil (0.76 mm) polyvinyl butyral (or equivalent) interlayer, wired glass, light-transmitting plastic materials meeting the requirements of Section 2607 ~~[, heat-strengthened glass or fully tempered glass].~~
2. For multiple-layer glazing systems, ~~[each light or]~~ the exterior layer shall ~~[consist of]~~ be fully tempered glass and the bottom layer shall consist of any of the glazing materials specified in Item 1 above.

Annealed glass is permitted to be used as specified ~~[within]~~ in Exceptions 2 and 3 of Section 2405.3.

Heat-strengthened glass or fully tempered monolithic glass is permitted to be used with screens, as specified in Section 2405.3.

For additional requirements for plastic skylights, see Section 2610. Glass-block construction shall conform to the requirements of Section ~~[2401.2.5]~~ 2110.1.

2405.3 Screening. Where used in monolithic glazing systems, heat-strengthened ~~[glass]~~ and fully tempered glass shall have screens installed below the glazing material. The screens and their fastenings shall: ~~([1] i)~~ be capable of supporting twice the weight of the glazing; ~~([2] ii)~~ be firmly and substantially fastened to the framing members; and ~~([3] iii)~~ be installed within 4 inches (102 mm) of

the glass. The screens shall be constructed of a noncombustible material not thinner than No. 12 B&S gage (0.0808 inch) with mesh not larger than 1 inch by 1 inch (25 mm by 25 mm). In a corrosive atmosphere, structurally equivalent noncorrosive screen materials shall be used. Heat-strengthened glass, fully tempered glass and wired glass, when used in multiple-layer glazing systems as the bottom glass layer over the walking surface, shall be equipped with screening that conforms to the requirements for monolithic glazing systems.

Exception: In monolithic and multiple-layer sloped glazing systems, the following applies:

1. Fully tempered glass installed without protective screens where glazed between intervening floors at a slope of 30 degrees (0.52 rad) or less from the vertical plane shall have the highest point of the glass 10 feet (3048 mm) or less above the walking surface.
2. Screens are not required below any glazing material, including annealed glass, where the walking surface below the glazing material is permanently protected from the risk of falling glass or the area below the glazing material is not a walking surface.
3. Any glazing material, including annealed glass, is permitted to be installed without screens in the sloped glazing systems of commercial or detached noncombustible greenhouses used exclusively for growing plants and not open to the public, provided that the height of the greenhouse at the ridge does not exceed 30 feet (9144 mm) above grade.
4. Screens shall not be required [~~within~~] in individual dwelling units in Occupancy Groups R-2 and R-3 where fully tempered glass is used as single glazing or as both panes in an insulating glass unit, and the following conditions are met:
 - 4.1 Each pane of the glass is 16 square feet (1.5 m²) or less in area.
 - 4.2 The highest point of the glass is 12 feet (3658 mm) or less above any walking surface [~~or other accessible area~~].
 - 4.3 The glass thickness is ³/₁₆ inch (4.8 mm) or less.
5. Screens shall not be required for laminated glass with a 15-mil (0.38 mm) polyvinyl butyral (or equivalent) interlayer used [~~within~~] in individual dwelling units in Occupancy Groups R-2 and R-3 within the following limits:
 - 5.1. Each pane of glass is 16 square feet (1.5 m²) or less in area.
 - 5.2. The highest point of the glass is 12 feet (3658 mm) or less above a walking surface [~~or other accessible area~~].

2405.4 Framing. In Type I and II construction, sloped glazing and skylight frames shall be constructed of noncombustible materials. In structures where acid fumes deleterious to metal are incidental to the use of the buildings, approved pressure-treated wood or other approved noncorrosive materials are permitted to be used for sash and frames. Framing supporting sloped glazing and skylights shall be designed to resist the tributary roof loads in Chapter 16. Skylights set at an angle of less than 45 degrees (0.79 rad) from the horizontal plane shall be mounted [~~at least~~] not less than 4 inches (102 mm) above the plane of the roof on a curb constructed as required for the frame.

Skylights shall not be installed in the plane of the roof where the roof pitch is less than 45 degrees (0.79 rad) from the horizontal.

Exception: Installation of a skylight without a curb shall be permitted on roofs with a minimum slope of 14 degrees (three units vertical in 12 units horizontal) in Group R-3 occupancies. All unit skylights installed in a roof with a pitch flatter than 14 degrees (0.24 rad) shall be mounted [at least] not less than 4 inches (102 mm) above the plane of the roof on a curb constructed as required for the frame unless otherwise specified in the manufacturer’s [installation] instructions.

2405.5 Unit skylights and tubular daylighting devices. Unit skylights and tubular daylighting devices shall be tested and labeled as complying with AAMA/WDMA/CSA 101/I.S.2/A440 [~~Voluntary Performance Specification for Windows, Skylights and Glass~~]. The label shall state the name of the manufacturer, the approved [labeling] agency, the product designation and the performance grade rating as specified in AAMA/WDMA/CSA 101/I.S.2/A440. [H] Where the product manufacturer has chosen to have the performance grade of the skylight rated separately for positive and negative design pressure, then the label shall state both performance grade ratings as specified in AAMA/WDMA/CSA 101/I.S.2/A440 and the skylight shall comply with Section 2405.5.2. [H] Where the skylight is not rated separately for positive and negative pressure, then the performance grade rating shown on the label shall be the performance grade rating determined in accordance with AAMA/WDMA/CSA 101/I.S.2/A440 for both positive and negative design pressure[;] and the skylight shall conform to Section 2405.5.1.

2405.5.1 [Unit skylights] Skylights rated for the same performance grade for both positive and negative design pressure. The design of [unit] skylights shall be based on [~~the following equation:~~] Equation 24-13.

$$F_g \leq PG \tag{Equation 24-13}$$

where:

F_g = Maximum load on the skylight determined from Equations 24-2 through 24-4 in Section 2404.2.

PG = Performance grade rating of the skylight.

2405.5.2 [Unit skylights] Skylights rated for separate performance grades for positive and negative design pressure. The design of [unit] skylights rated for performance grade for both positive and negative design pressures shall be based on [~~the following equations:~~] Equations 24-14 and 24-15.

$$F_{gi} \leq PG_{Pos} \tag{Equation 24-14}$$

$$F_{go} \leq PG_{Neg} \tag{Equation 24-15}$$

where:

PG_{Pos} = Performance grade rating of the skylight under positive design pressure[;]

PG_{Neg} = Performance grade rating of the skylight under negative design pressure[;] and

F_{gi} and F_{go} are determined in accordance with the following:

For [~~$W_e < D$~~] $0.6W_o \geq D$,

where:

W_o = Outward wind force, psf (kN/m²) due to basic design wind speed, V , as calculated in Section 1609.

D = The dead weight of the glazing, psf (kN/m²) as determined in Section 2404.2 for glass, or by the weight of the plastic, psf (kN/m²) for plastic glazing.

F_{gi} = Maximum load on the skylight determined from Equations 24-3 and 24-4 in Section 2404.2.

F_{go} = Maximum load on the skylight determined from Equation 24-2.

For [~~$W_o < D$~~] $0.6W_o < D$,

where:

W_o = [~~Outward~~] The outward wind force, psf (kN/m²) due to basic design wind speed, V , as calculated in Section 1609.

D = The dead weight of the glazing, psf (kN/m²) as determined in Section 2404.2 for glass, or by the weight of the plastic for plastic glazing.

F_{gi} = Maximum load on the skylight determined from Equations 24-2 through 24-4 in Section 2404.2.

F_{go} = 0.

SECTION BC 2406 SAFETY GLAZING

2406.1 Human impact loads. Individual glazed areas, including glass mirrors, in hazardous locations as defined in Section 2406.4 shall comply with Sections 2406.1.1 through 2406.1.4.

Exception: Mirrors and other glass panels mounted or hung on a surface that provides a continuous backing support.

2406.1.1 Impact test. Except as provided in Sections 2406.1.2 through 2406.1.4, all glazing shall pass the impact test requirements of Section 2406.2.

2406.1.2 Plastic glazing. Plastic glazing shall meet the weathering requirements of ANSI Z97.1.

2406.1.3 Glass block. Glass-block walls shall comply with Section 2101.2.5.

2406.1.4 Louvered windows and jalousies. Louvered windows and jalousies shall comply with Section 2403.5.

2406.2 Impact test. Where required by other sections of this code, glazing shall be tested in accordance with CPSC 16 CFR Part 1201. Glazing shall comply with the test criteria for Category [~~I~~] II, [~~as~~] unless otherwise indicated in Table 2406.2(1).

TABLE 2406.2(1)
MINIMUM CATEGORY CLASSIFICATION OF GLAZING USING CPSC 16 CFR 1201

EXPOSED SURFACE AREA OF ONE SIDE OF ONE LITE	GLAZING IN STORM OR COMBINATION DOORS (Category class)	GLAZING IN DOORS (Category class)	GLAZED PANELS REGULATED BY [ITEM 7 OF] SECTION [2406.4] <u>2406.4.3</u> (Category class)	GLAZED PANELS REGULATED BY [ITEM 6 OF] SECTION [2406.4] <u>2406.4.2</u> (Category class)	DOORS AND ENCLOSURES REGULATED BY [ITEM 5 OF] SECTION [2406.4] <u>2406.4.5</u> (Category class)	SLIDING GLASS DOORS PATIO TYPE (Category class)
9 square feet or less	I	I	No requirement	I	II	II
More than 9 square feet	II	II	II	II	II	II

For SI: 1 square foot = 0.0929 m².

Exception: Glazing not ~~[being used for]~~ in doors or enclosures for hot tubs, whirlpools, saunas, steam rooms, bathtubs and showers shall be permitted to be tested in accordance with ANSI Z97.1. Glazing shall comply with the test criteria for Class A ~~[or B as]~~, unless otherwise indicated in Table 2406.2(2).

TABLE 2406.2(2)
MINIMUM CATEGORY CLASSIFICATION OF GLAZING USING ANSI Z97.1

EXPOSED SURFACE AREA OF ONE SIDE OF ONE LITE	GLAZED PANELS REGULATED BY [ITEM 7 OF] SECTION [2406.4] <u>2406.4.3</u> (Category class)	GLAZED PANELS REGULATED BY [ITEM 6 OF] SECTION [2406.4] <u>2406.4.2</u> (Category class)	DOORS AND ENCLOSURES REGULATED BY [ITEM 5 OF] SECTION [2406.4] <u>2406.4.5^a</u> (Category class)
9 square feet or less	No requirement	B	A
More than 9 square feet	A	A	A

For SI: 1 square foot = 0.0929 m².

a. Use is only permitted by the exception to Section 2406.2.

2406.3 Identification of safety glazing. Except as indicated in Section 2406.3.1, each pane of safety glazing installed in hazardous locations shall be identified by a label specifying the labeler, ~~[whether]~~ the manufacturer or installer~~[-]~~ and the safety glazing standard with which it complies, as well as the information specified in Section 2403.1. A label as defined in Section 202 and meeting the requirements of this section shall be permitted in lieu of the manufacturer's designation.

Exceptions:

1. For other than tempered glass, labels are not required, provided the department approves the use of a certificate, affidavit or other evidence confirming compliance with this code.
2. Tempered spandrel glass ~~[is permitted to]~~ shall be identified ~~[by the manufacturer with a removable paper label]~~ in accordance with Section 2403.1.

2406.3.1 ~~[Multi-pane]~~ Multi-pane assemblies. ~~[Multi-pane]~~ Multi-pane glazed assemblies having individual panes not exceeding 1 square foot (0.09 ~~[square meter]~~ m²) in exposed ~~[area]~~ areas shall have at least one pane in the assembly marked as indicated in Section 2406.3. Other panes in the assembly shall be marked "CPSC 16 CFR ~~[1201]~~ Part 1201" or "ANSI Z97.1," as appropriate.

2406.4 Hazardous locations. ~~[The following shall be considered specific hazardous locations requiring safety glazing materials:]~~ The locations specified in Sections 2406.4.1 through 2406.4.7 shall be considered to be specific hazardous locations requiring safety glazing materials.

- ~~[1. Glazing in swinging doors except jalousies (see Section 2406.4.1).]~~
- ~~[2. Glazing in fixed and sliding panels of sliding door assemblies and panels in sliding and bifold closet door assemblies.]~~
- ~~[3. Glazing in storm doors.]~~
- ~~[4. Glazing in unframed swinging doors.]~~
- ~~[5. Glazing in doors and enclosures for hot tubs, whirlpools, saunas, steam rooms, bathtubs and showers. Glazing in any portion of a building wall enclosing these compartments where the bottom exposed edge of the glazing is less than 60 inches (1524 mm) above a standing surface.]~~
- ~~[6. Glazing in an individual fixed or operable panel adjacent to a door where the nearest exposed edge of the glazing is within a 24 inch (610 mm) are of either vertical edge of the door in a closed position and where the bottom exposed edge of the glazing is less than 60 inches (1524 mm) above the walking surface.]~~

[Exceptions:]

- ~~[1. Panels where there is an intervening wall or other permanent barrier between the door and glazing.]~~
- ~~[2. Where access through the door is to a closet or storage area 3 feet (914 mm) or less in depth. Glazing in this application shall comply with Section 2406.4, Item 7.]~~
- ~~[3. Glazing in walls perpendicular to the plane of the door in a closed position, other than the wall towards which the door swings when opened in one and two family dwellings or within dwelling units in Group R-2.]~~
- ~~[7. Glazing in an individual fixed or operable panel, other than in those locations described in preceding Items 5 and 6, which meets all of the following conditions:]~~
 - ~~[7.1. Exposed area of an individual pane greater than 9 square feet (0.84 m²);]~~
 - ~~[7.2. Exposed bottom edge less than 18 inches (457 mm) above the floor;]~~
 - ~~[7.3. Exposed top edge greater than 36 inches (914 mm) above the floor; and]~~
 - ~~[7.4. One or more walking surface(s) within 36 inches (914 mm) horizontally of the plane of the glazing.]~~

[Exception: Safety glazing for Item 7 is not required for the following installations:]

- ~~[1. A horizontal protective bar 1½ inches (38 mm) or more in height, capable of withstanding a horizontal load of 50 pounds plf (730 N/m) without contacting the glass, is installed on the accessible sides of the glazing 34 inches to 38 inches (864 mm to 965 mm) above the floor.]~~

- ~~[2. The outboard pane in insulating glass units or multiple glazing where the bottom exposed edge of the glass is 25 feet (7620 mm) or more above any grade, roof, walking surface or other horizontal or sloped (within 45 degrees of horizontal) (0.78 rad) surface adjacent to the glass exterior.]~~
 - ~~[8. Glazing in guards and railings, including structural baluster panels and nonstructural in-fill panels, regardless of area or height above a walking surface.]~~
 - ~~[9. Glazing in walls and fences enclosing indoor and outdoor swimming pools, hot tubs and spas where all of the following conditions are present:]~~
 - ~~[9.1. The bottom edge of the glazing on the pool or spa side is less than 60 inches (1524 mm) above a walking surface on the pool or spa side of the glazing; and]~~
 - ~~[9.2. The glazing is within 60 inches (1524 mm) horizontally of the water's edge of a swimming pool or spa.]~~
 - ~~[10. — Glazing adjacent to stairways, landings and ramps within 36 inches (914 mm) horizontally of a walking surface; when the exposed surface of the glass is less than 60 inches (1524 mm) above the plane of the adjacent walking surface.]~~
 - ~~[11. — Glazing adjacent to stairways within 60 inches (1524 mm) horizontally of the bottom tread of a stairway in any direction when the exposed surface of the glass is less than 60 inches (1524 mm) above the nose of the tread.]~~
- ~~[**Exception:** Safety glazing for Item 10 or 11 is not required for the following installations where:]~~
- ~~[1. The side of a stairway, landing or ramp which has a guard or handrail, including balusters or in-fill panels, complying with the provisions of Sections 1013 and 1607.7; and]~~
 - ~~[2. The plane of the glass is greater than 18 inches (457 mm) from the railing.]~~

2406.4.1 [Exceptions: The following products, materials and uses shall not be considered specific hazardous locations:] **Glazing in doors.** Glazing in all fixed and operable panels of swinging, sliding and bifold doors shall be considered a hazardous location.

- ~~[1. Openings in doors through which a 3 inch (76 mm) sphere is unable to pass.]~~
- ~~[2. Decorative glass in Section 2406.4, Item 1, 6 or 7.]~~
- ~~[3. Glazing materials used as curved glazed panels in revolving doors.]~~
- ~~[4. Commercial refrigerated cabinet glazed doors.]~~
- ~~[5. Glass block panels complying with Section 2101.2.5.]~~
- ~~[6. Louvered windows and jalousies complying with the requirements of Section 2403.5.]~~

~~[7. Mirrors and other glass panels mounted or hung on a surface that provides a continuous backing support.]~~

Exceptions:

1. Glazed openings of a size through which a 3-inch diameter (76 mm) sphere is unable to pass.
2. Decorative glazing.
3. Glazing materials used as curved glazed panels in revolving doors.
4. Commercial refrigerated cabinet glazed doors.

2406.4.2 Glazing adjacent to doors. Glazing in an individual fixed or operable panel adjacent to a door where the nearest vertical edge of the glazing is within a 24-inch (610 mm) arc of either vertical edge of the door in a closed position and where the bottom exposed edge of the glazing is less than 60 inches (1524 mm) above the walking surface shall be considered a hazardous location.

Exceptions:

1. Decorative glazing.
2. Where there is an intervening wall or other permanent barrier between the door and glazing.
3. Where access through the door is to a closet or storage area 3 feet (914 mm) or less in depth. Glazing in this application shall comply with Section 2406.4.3.
4. Glazing in walls on the latch side of and perpendicular to the plane of the door in a closed position in one- and two-family dwellings or within dwelling units in Group R-2 occupancies.

2406.4.3 Glazing in windows. Glazing in an individual fixed or operable panel that meets all of the following conditions shall be considered to be a hazardous location:

1. The exposed area of an individual pane is greater than 9 square feet (0.84 m²).
2. The bottom edge of the glazing is less than 18 inches (457 mm) above the floor.
3. The top edge of the glazing is greater than 36 inches (914 mm) above the floor.
4. One or more walking surface(s) are within 36 inches (914 mm), measured horizontally and in a straight line, of the plane of the glazing.

Exceptions:

1. Decorative glazing.

2. Where a horizontal rail is installed on the accessible side(s) of the glazing 34 to 38 inches (864 to 965 mm) above the walking surface. The rail shall be capable of withstanding a horizontal load of 50 pounds per linear foot (730 N/m) without contacting the glass and be not less than 1½ inches (38 mm) in cross-sectional height.
3. Outboard panes in insulating glass units or multiple glazing where the bottom exposed edge of the glass is 25 feet (7620 mm) or more above any grade, roof, walking surface or other horizontal or sloped (within 45 degrees of horizontal) (0.79 rad) surface adjacent to the glass exterior.

2406.4.4 Glazing in guards and railings. Glazing in guards and railings, including structural baluster panels and nonstructural in-fill panels, regardless of area or height above a walking surface, shall be considered to be a hazardous location.

2406.4.5 Glazing and wet surfaces. Glazing in walls, enclosures or fences containing or facing hot tubs, spas, whirlpools, saunas, steam rooms, bathtubs, showers and indoor or outdoor swimming pools where the bottom exposed edge of the glazing is less than 60 inches (1524 mm) measured vertically above any standing or walking surface shall be considered a hazardous location. This shall apply to single glazing and all panes in multiple glazing.

Exception: Glazing that is more than 60 inches (1524 mm), measured horizontally and in a straight line, from the water's edge of a bathtub, hot tub, spa, whirlpool or swimming pool.

2406.4.6 Glazing adjacent to stairways and ramps. Glazing where the bottom exposed edge of the glazing is less than 60 inches (1524 mm) above the plane of the adjacent walking surface of stairways, landings between flights of stairs and ramps shall be considered a hazardous location.

Exceptions:

1. The side of a stairway, landing or ramp that has a guard complying with the provisions of Sections 1015 and 1607.8, and the plane of the glass is greater than 18 inches (457 mm) from the railing.
2. Glazing 36 inches (914 mm) or more measured horizontally from the walking surface.

2406.4.7 Glazing adjacent to the bottom stairway landing. Glazing adjacent to the landing at the bottom of a stairway where the glazing is less than 60 inches (1524 mm) above the landing and within a 60-inch (1524 mm) horizontal arc that is less than 180 degrees (3.14 rad) from the bottom tread nosing shall be considered a hazardous location.

Exception: Glazing that is protected by a guard complying with Sections 1015 and 1607.8 where the plane of the glass is greater than 18 inches (457 mm) from the guard.

2406.5 Fire department access panels. Fire department glass access panels shall be of [~~non-laminated~~] nonlaminated tempered glass. For insulating glass units, all panes shall be [~~non-laminated~~] nonlaminated tempered glass.

Exception: Fire department access panels that are openable and meeting size requirements of Section 903.2.11.1.

SECTION BC 2407 GLASS IN HANDRAILS AND GUARDS

2407.1 Materials. Glass used as structural balustrade panels ~~[in railings shall be constructed of either single fully tempered glass, laminated fully tempered glass or laminated heat strengthened glass. Glazing in railing material that conforms to the provisions of Section 2406.1.1. For all glazing types, the minimum nominal thickness shall be ¼ inch (6.4 mm). Fully tempered glass and laminated glass shall comply with Category II of CPSC CFR 1201, listed in Chapter 35.] and in-fill panels in railings shall be laminated glass constructed of fully tempered or heat-strengthened glass and shall comply with Category II or CPSC 16 CFR Part 1201 or Class A of ANSI Z97.1. For all glazing types, the minimum nominal thickness shall be ¼ inch (6.4 mm).~~

Exception: For Group R-3 occupancies, single fully tempered glass complying with Category II of CPSC 16 CFR Part 1201 or Class A of ANSI Z97.1 shall be permitted to be used in handrails and guardrails where there is no walking surface beneath them or the walking surface is permanently protected from the risk of falling glass.

2407.1.1 Loads. The panels and their support system shall be designed to withstand the loads specified in Section ~~[4607.7]~~ 1607.8. ~~[A safety factor of not less than four shall be used].~~ Glass guard elements shall be designed using a factor of safety of four.

2407.1.2 ~~[Support. Each]~~ Support and framing. Support and framing of glass used in handrails and guards shall comply with the requirements of Sections 2403.2 and 2403.3. In glass structural balustrade systems, each handrail or guard section shall be supported by ~~[a minimum of]~~ no fewer than three glass balusters or shall be otherwise supported to remain in place should one baluster panel fail. Glass balusters shall not be installed without an attached handrail or guard.

Exception: ~~[A top rail shall not be required where the glass balusters are laminated glass with two or more glass plies of equal thickness and the same glass type [when approved by the department]. The panels shall be designed to withstand the loads specified in Section 1607.7] An attached top rail or handrail is not required when panels are tested to remain in place as a barrier following impact or glass breakage in accordance with ASTM E2353, and designed to withstand the loads specified in Section 1607.8.~~

2407.1.3 Parking garages. Glazing materials shall not be installed in handrails or guards in parking garages except for pedestrian areas not exposed to impact from vehicles.

2407.1.4 Glazing in wind-borne debris regions. Glazing installed in in-fill panels or balusters in wind-borne debris regions shall comply with the following:

2407.1.4.1 ~~[Balusters]~~ Balusters and in-fill panels. Glass installed in exterior railing in-fill panels or balusters shall be laminated glass complying with Category II of CPSC 16 CFR Part 1201 or Class A of ANSI Z97.1.

2407.1.4.2 Glass supporting top rail. When the top rail is supported by glass, the assembly shall be tested according to the impact requirements of Section ~~[4609.1.3]~~ 1609.1.2. The top rail shall remain in place after impact.

SECTION BC 2408 GLAZING IN ATHLETIC FACILITIES

2408.1 General. Glazing in athletic facilities and similar uses subject to impact loads, which forms whole or partial wall sections or which is used as a door or part of a door, shall comply with this section.

2408.2 Racquetball and squash courts. Glazing in racquetball, squash courts and similar athletic facilities subject to impact loads shall comply with this section.

2408.2.1 Testing. Test methods and loads for individual glazed areas in racquetball and squash courts subject to impact loads shall conform to those of CPSC 16 CFR Part 1201 or ANSI Z97.1 [~~listed in Chapter 35~~], with impacts being applied at a height of 59 inches (1499 mm) above the playing surface to an actual or simulated glass wall installation with fixtures, fittings and methods of assembly identical to those used in practice.

Glass walls shall comply with the following conditions:

1. A glass wall in a racquetball or squash court, or similar use subject to impact loads, shall remain intact following a test impact.
2. The deflection of such walls shall be not [~~be~~] greater than 1½ inches (38 mm) at the point of impact for a drop height of 48 inches (1219 mm).

Glass doors shall comply with the following conditions:

1. Glass doors shall remain intact following a test impact at the prescribed height in the center of the door.
2. The relative deflection between the edge of a glass door and the adjacent wall shall not exceed the thickness of the wall plus ½ inch (12.7 mm) for a drop height of 48 inches (1219 mm).

2408.3 [~~Gymnasium~~ Gymnasiums and basketball courts. Glazing in multipurpose gymnasiums, basketball courts and similar athletic facilities subject to human impact loads shall comply with Category II of CPSC 16 CFR Part 1201 or Class A of ANSI Z97.1 [~~listed in Chapter 35~~].

SECTION BC 2409 GLASS IN WALKWAYS, ELEVATOR HOISTWAYS AND ELEVATOR CARS

2409.1 Glass walkways. Glass installed as floors, landings, stairs and in similar locations shall be designed and engineered by a registered design professional and the design shall include the applicable provisions of ASTM E 2751 and the load requirements of Chapter 16. Such assemblies shall comply with the fire-resistance rating and marking requirements of this code where applicable.

[2409.1] 2409.2 Glass in elevator hoistway enclosures. Glass in elevator hoistway enclosures and hoistway doors shall be laminated glass conforming to ANSI Z97.1 or CPSC 16 CFR Part 1201 and ASME A17.1, as modified by Appendix K of this code.

~~[2409.1.1] 2409.2.1 Fire-resistance-rated hoistways.~~ Glass installed in hoistways and hoistway doors where the hoistway is required to have a fire-resistance rating shall also comply with Section [715] 716.

~~[2409.1.2 Glass hoistway doors.~~ The glass in glass hoistway doors shall be not less than 60 percent of the total visible door panel surface area as seen from the landing side.]

~~[2409.2 Glass visions panels.~~ Glass in vision panels in elevator hoistway doors shall be permitted to be any transparent glazing material not less than ¼ inches (6.4 mm) in thickness conforming to Class A in accordance with ANSI Z97.1 or Category II in accordance with CPSC 16 CFR Part 1201. The area of any single vision panel shall not be less than 12 square inches (0.008 m²), and the total area of one or more vision panels in any hoistway door shall be not more than 40 square inches (0.026 m²). See ASME A17.1, as modified by Appendix K of this code for additional requirements.]

2409.3 Visions panels in elevator hoistway doors. Glass in vision panels in elevator hoistway doors shall be permitted to be any transparent glazing material not less than ¼ inch (6.4 mm) in thickness conforming to Class A in accordance with ANSI Z97.1 or Category II in accordance with CPSC 16 CFR Part 1201. Glass in vision panels in elevator hoistway doors shall also comply with ASME A17.1, Section 2.11.7, as modified by Appendix K of this code for additional requirements.

[2409.3] 2409.4 Glass in elevator cars. Glass in elevator cars shall be in accordance with ASME A17.1 section 2.14.1.8, as modified by Appendix K.

~~[2409.3.1] 2409.4.1 Glass types.~~ Glass in elevator car enclosures, glass elevator car doors and glass used for lining walls and ceilings of elevator cars shall be laminated glass conforming to Class A in accordance with ANSI Z97.1 or Category II in accordance with CPSC 16 CFR Part 1201. See ASME A17.1, as modified by Appendix K of this code for additional requirements.

~~[Exception: Tempered glass shall be permitted to be used for lining walls and ceilings of elevator cars provided:]~~

~~[1. The glass is bonded to a nonpolymeric coating, sheeting or film backing having a physical integrity to hold the fragments when the glass breaks;]~~

~~[2. The glass is not subjected to further treatment such as sandblasting, etching, heat treatment or painting that could alter the original properties of the glass; And]~~

~~[3. The glass is tested to the acceptance criteria for laminated glass as specified for Class A in accordance with ANSI Z97.1 or Category II in accordance with CPSC 16 CFR Part 1201.]~~

~~[2409.3.2 Surface area.~~ The glass in glass elevator car doors shall be not less than 60 percent of the total visible door panel surface area as seen from the car side of the doors.]

SECTION BC 2410
MARKING OF TRANSPARENT DOORS AND
FIXED ADJACENT TRANSPARENT [~~SIDELIGHTS~~] SIDELITES

~~[2410.1 Definitions. The following words and terms shall, for the purposes of this chapter and as used elsewhere in this code, have the meanings shown herein.]~~

~~[**SIDELIGHTS.** Fixed transparent panels which form part of or are immediately adjacent to and within 6 feet horizontally of the vertical edge of an opening in which transparent doors are located. A sidelight shall consist of transparent material in which the transparent area above a reference line 18 inches (457 mm) above the adjacent ground, floor or equivalent surface is 80 percent or more of the remaining area of the panel above such reference line.]~~

~~[**TRANSPARENT.** The property of a material which is not opaque and through which objects lying beyond are clearly visible.]~~

~~[**TRANSPARENT DOOR.** A door, manually or power actuated, fabricated of transparent material, in which the transparent area above a reference line 18 inches (457 mm) above the bottom edge of the door is 80 percent or more of the remaining area of the door above such reference line.]~~

~~[**TRANSPARENT SAFETY GLAZING MATERIALS.** Materials which will clearly transmit light and also minimize the possibility of cutting or piercing injuries resulting from breakage of the material. Materials covered by this definition include laminated glass, tempered glass (also known as heat treated glass, heat toughened glass, case hardened glass or chemically tempered glass), wired glass, and plastic glazing.]~~

~~[2410.2] **2410.1 Requirement.** Transparent doors and fixed adjacent [~~sidelights~~] sidelites shall be marked in accordance with [~~Section BC 2410.3 to 2410.5~~] Sections 2410.3 through 2410.4.~~

Exceptions:

1. One- and two-family dwellings.
2. Fixed adjacent transparent [~~sidelights~~] sidelites 20 inches (508 mm) or less in width with opaque stiles at least 1¾ inches (44 mm) in width.
3. Where the ground, floor or equivalent surface area in the path of approach to a fixed adjacent transparent [~~sidelight~~] sidelite from either side for a minimum distance of 3 feet (914 mm) from such [~~sidelight~~] sidelite is so arranged, constructed or designed as to deter persons from approaching such [~~sidelight~~] sidelite or a permanent barrier is installed in the path of approach, provided that:
 - 3.1. Decorative pools, horticultural planting or similar installations shall be considered as indicating that the ground, floor or equivalent surface area is not a path of approach.
 - 3.2. Planters, benches and similar barriers which are securely fastened to the floor or wall to prevent their removal shall be considered as blocking the path of approach provided they shall be not less than 18 inches (457 mm) in height from the ground,

floor or equivalent surface and extend across at least 2/3 of the total width of the glazed area of the sidelight.

4. Fixed adjacent transparent [~~sidelights~~] sidelites which are supported by opaque sill and wall construction of at least 18 inches (457 mm) above the ground, floor or equivalent surface immediately adjacent.
5. Display windows in any establishment, building or structure which fall within the definition of a [~~sidelight~~] sidelite if the top of the supporting sill and wall construction is not less than 18 inches (457 mm) above the ground, floor or equivalent surface immediately adjacent and the interior area is occupied with merchandise or similar displays to clearly indicate to the public that it is not a means of ingress or egress.
6. Opaque door pulls or push bars extending across at least two-thirds of the total width of the glazed area.

[2410.3] 2410.2 Locations. Transparent doors and fixed adjacent transparent [~~sidelights~~] sidelites shall be marked in two areas on the glass surface. One such area shall be located at least 30 inches (762 mm) but not more than 36 inches (914 mm) above the ground, floor or equivalent surface below the door or [~~sidelight~~] sidelite, and the other at least 60 inches (1524 mm) but not more than 66 inches (1676 mm) above the ground, floor or equivalent surface below the door or [~~sidelight~~] sidelite.

Exception: The use of horizontal separation bars, muntin bars or other equivalent bars at least one and 1½ inches (38 mm) in vertical dimension that extend across the total width of the glazed area and are located at least 40 inches (1016 mm) but not more than 50 inches (1270 mm) above the bottom of the door or [~~sidelight~~] sidelite is permitted in lieu of markings.

[2410.4] 2410.3 Design. The marking design shall be at least 4 inches (102 mm) in diameter if circular or 4 inches (102 mm) in its least dimension if elliptical or polygonal, or shall be at least 12 inches (305 mm) in horizontal dimension if the marking is less than 4 inches (102 mm) in its least dimension. In no event shall the vertical dimension of any marking including lettering be less than 1½ inches (38 mm) in height.

[2410.5] 2410.4 Materials. Markings may be comprised of, but are not limited to:

1. Muntin bars, separation bars or other equivalent bars;
2. Chemical etching;
3. Sandblasting;
4. Adhesive strips;
5. Decals; or
6. Paint, gilding or other opaque marking materials.

§ 25. Chapter 25 of the New York city building code, as amended by local law number 141 for the year 2013, sections 2501.1.1 and 2502.1 as amended by local law number 13 for the year 2014, section 2506.3 as added by local law number 13 for the year 2014, is amended to read as follows:

CHAPTER 25
GYPSUM BOARD, GYPSUM PANEL PRODUCTS AND PLASTER

SECTION BC 2501
GENERAL

2501.1 Scope.

~~[2501.1.1 General.]~~ Provisions of this chapter shall govern the materials, design, construction and quality of gypsum board, gypsum panel products, lath, gypsum plaster, cement plaster, ~~[and]~~ cement board and reinforced gypsum concrete.

~~[2501.1.2]~~ **2501.2 Performance.** Lathing, plastering, gypsum board and gypsum ~~[board]~~ panel product construction shall be done in the manner^[7] and with the materials^[7] specified in this chapter and the referenced standards listed in Chapter 35. When fire protection is required, such construction shall also comply with the provisions of Chapter 7.

~~[2501.1.3]~~ **2501.3 Other materials.** Other approved wall or ceiling coverings shall be permitted to be installed in accordance with the recommendations of the manufacturer and the approval of the commissioner.

SECTION BC 2502
DEFINITIONS

2502.1 Definitions. The following ~~[words and]~~ terms ~~[shall, for the purposes of this chapter and as used elsewhere]~~ are defined in ~~[this code, have the meanings shown herein.]~~ Chapter 2:

CEMENT BOARD. ~~[A fiber reinforced cementitious panel most commonly used under flooring or as a tile backing board. Cement board shall include discrete nonasbestos fiber cement interior substrate sheets or nonasbestos fiber mat reinforced cement substrate sheets.]~~

CEMENT PLASTER. ~~[A mixture of portland or blended cement, portland cement or blended cement and hydrated lime, masonry cement or plastic cement and aggregate and other approved materials as specified in this code.]~~

EXTERIOR SURFACES. ~~[Weather exposed surfaces.]~~

GYPSUM BOARD. ~~[Gypsum wallboard, gypsum sheathing, gypsum base for gypsum veneer plaster, exterior gypsum soffit board, predecorated gypsum board or water resistant gypsum backing board complying with the standards listed in Tables 2506.2, 2507.2 and Chapter 35.]~~

GYPSUM PANEL PRODUCTS.

GYPSUM PLASTER. [~~A mixture of calcined gypsum or calcined gypsum and lime and aggregate and other approved materials as specified in this code.~~]

GYPSUM VENEER PLASTER. [~~Gypsum plaster applied to an approved base in one or more coats normally not exceeding ¼ inch (6.4 mm) in total thickness.~~]

INTERIOR SURFACES. [~~Surfaces other than weather-exposed surfaces.~~]

WEATHER-EXPOSED SURFACES. [~~Surfaces of walls, ceilings, floors, roofs, soffits and similar surfaces exposed to the weather except the following:~~]

- [~~1. Ceilings and roof soffits enclosed by walls, fascia, bulkheads or beams that extend a minimum of 12 inches (305 mm) below such ceiling or roof soffits.~~]
- [~~2. Walls or portions of walls beneath an unenclosed roof area, where located a horizontal distance from an open exterior opening equal to at least twice the height of the opening.~~]
- [~~3. Ceiling and roof soffits located a minimum horizontal distance of 10 feet (3048 mm) from the outer edges of the ceiling or roof soffits.~~]

WIRE BACKING. [~~Horizontal strands of tautened wire attached to surfaces of vertical supports which, when covered with the building paper, provide a backing for cement plaster.~~]

SECTION BC 2503 RESERVED

SECTION BC 2504 VERTICAL AND HORIZONTAL ASSEMBLIES

2504.1 Scope. The following requirements shall be met where construction involves gypsum board, gypsum panel products or lath and plaster in vertical and horizontal assemblies.

2504.1.1 Wood framing. Wood supports for lath, gypsum board or gypsum [~~board~~] panel products, as well as wood stripping or furring, shall be not [~~be~~] less than 2 inches (51 mm) nominal thickness in the least dimension.

Exception: The minimum nominal dimension of wood furring strips installed over solid backing shall be not [~~be~~] less than 1 inch by 2 inches (25 mm by 51 mm).

2504.1.2 Studless partitions. The minimum thickness of vertically erected studless solid plaster partitions of ⅜-inch (9.5 mm) and ¾-inch (19.1 mm) rib metal lath [~~or~~], ½-inch-thick (12.7 mm) [~~long-length~~] gypsum lath [~~and gypsum~~], gypsum board [~~partitions~~] or gypsum panel product shall be 2 inches (51 mm).

SECTION BC 2505 SHEAR WALL CONSTRUCTION

2505.1 Resistance to shear (wood framing). [~~Wood-framed~~] Wood-frame shear walls sheathed with gypsum board, gypsum panel products or lath and plaster shall be designed and constructed in accordance with Section [~~2306.7 of this code~~] 2306.3 and are permitted to resist wind and seismic loads. Walls resisting seismic loads shall be subject to the limitations in Section 12.2.1 of ASCE 7.

2505.2 Resistance to shear (steel framing). Cold-formed [~~steel-framed~~] steel-frame shear walls sheathed with gypsum board or gypsum panel products and constructed in accordance with the materials and provisions of Section [~~2210.6 of this code~~] 2211.1.1 are permitted to resist wind and seismic loads. Walls resisting seismic loads shall be subject to the limitations in Section 12.2.1 of ASCE 7.

SECTION BC 2506 GYPSUM BOARD AND GYPSUM PANEL PRODUCT MATERIALS

2506.1 General. Gypsum board [~~materials~~], gypsum panel products and accessories shall be identified by the manufacturer's designation to indicate compliance with the appropriate standards referenced in this section and stored to protect such materials from the weather.

2506.2 Standards. Gypsum board [~~materials~~] and gypsum panel products shall conform to the appropriate standards listed in Table 2506.2 and Chapter 35 and, where required for fire protection, shall conform to the provisions of Chapter 7.

TABLE 2506.2
GYPSUM BOARD AND GYPSUM PANEL PRODUCTS MATERIALS AND
ACCESSORIES

MATERIAL	STANDARD
<u>Abuse resistant non-decorated interior gypsum panel products and fiber-reinforced cement panels</u>	<u>ASTM C 1629</u>
Accessories for gypsum board	ASTM C 1047
Adhesives for fastening gypsum wallboard	ASTM C 557
<u>Cold-formed steel studs and track, structural</u>	<u>AISI S200 and ASTM C 955, Section 8</u>
<u>Cold-formed steel studs and track, nonstructural</u>	<u>AISI S220 and ASTM C 645, Section 10</u>
Elastomeric joint sealants	ASTM C 920
[Exterior soffit board]	[ASTM C 934]
Fiber-reinforced gypsum panels	ASTM C 1278
Glass mat gypsum backing panel	ASTM C 1178
Glass mat gypsum panel <u>5</u>	ASTM C 1658
Glass mat gypsum substrate	ASTM C 1177
[Gypsum backing board and gypsum shaftliner board]	[ASTM C 442]
[Gypsum ceiling board]	[ASTM C 1395]
[Gypsum sheathing]	[ASTM C 79]
[Gypsum wallboard]	[ASTM C 36]
Joint reinforcing tape and compound	ASTM C 474; C 475
Nails for gypsum boards	ASTM C 514, F 547, F 1667
[Predecorated gypsum board]	[ASTM C 960]
Steel screws	ASTM C 954; C 1002
[Steel studs, load bearing]	[ASTM C 955]
[Steel studs, nonload bearing]	[ASTM C 645]
Standard specification for gypsum board	ASTM C 1396

MATERIAL	STANDARD
Testing gypsum and gypsum products	ASTM C 22; C 472; C 473
[Water resistant gypsum backing board]	[ASTM C 630]

2506.2.1 Other materials. Metal suspension systems for acoustical and lay-in panel ceilings shall conform with Section [803.9] 808.1.

2506.3 Mold resistance. Gypsum board or cement board, used in an assembly for the following areas, shall have a mold resistance rating of 10 in accordance with ASTM D3273:

1. Interior faces of exterior walls of basements, cellars, and other below grade rooms[;].
2. Walls and ceilings of spaces containing condensers, water tanks, water pumps, and pressure reduction valves[;].
3. Walls and ceilings of laundry rooms[;].
4. Portions of walls within 2 feet (610 mm) of kitchen sinks to a height of 4 feet (1219 mm) above the floor[;].
5. Portions of walls within 2 feet (610 mm) of kitchen stoves to a height of 4 feet (1219 mm) above the floor[;].
6. Walls of bathrooms that are not solely water closet compartments, other than walls specifically required to be cement board[;].
7. Walls and ceilings in service sink closets[;and].
8. Portions of walls within 2 feet (610 mm) of mop sinks or service sinks to a height of 4 feet (1219 mm) above the floor.

SECTION BC 2507 LATHING AND PLASTERING

2507.1 General. Lathing and plastering materials and accessories shall be marked by the manufacturer's designation to indicate compliance with the appropriate standards referenced in this section and stored in such a manner to protect them from the weather.

2507.2 Standards. Lathing and plastering materials shall conform to the standards listed in Table 2507.2 and Chapter 35 and, where required for fire protection, shall also conform to the provisions of Chapter 7.

**TABLE 2507.2
LATH, PLASTERING MATERIALS AND ACCESSORIES**

MATERIAL	STANDARD
Accessories for gypsum veneer base	ASTM C 1047
Blended cement	ASTM C 595
<u>Cold-formed steel studs and track, nonstructural</u>	<u>AISI S220 and ASTM C 645, Section 10</u>
<u>Cold-formed steel studs and track, structural</u>	<u>AISI S200 and ASTM C 955, Section 8</u>
Exterior plaster bonding compounds	ASTM C 932
[Gypsum base for veneer plasters]	[ASTM C 588]
Gypsum casting and molding plaster	ASTM C 59
Gypsum Keene's cement	ASTM C 61
[Gypsum lath]	[ASTM C 37]
Gypsum plaster	ASTM C 28
Gypsum veneer plaster	ASTM C 587
<u>Hydraulic cement</u>	<u>ASTM C 1157; C 1600</u>
Interior bonding compounds, gypsum	ASTM C 631
Lime plasters	ASTM C 5; C 206
Masonry cement	ASTM C 91
Metal lath	ASTM C 847
Plaster aggregates Sand Perlite Vermiculite	ASTM C 35; C 897 ASTM C 35 ASTM C 35
Plastic cement	ASTM C 1328
Portland cement	ASTM C 150
Steel screws	ASTM C 1002; C 954
[Steel studs and track]	[ASTM C 645; C 955]
Welded wire lath	ASTM C 933
Woven wire plaster base	ASTM C 1032

**SECTION BC 2508
GYPSUM CONSTRUCTION**

2508.1 General. Gypsum board, gypsum panel products and gypsum plaster construction shall be of the materials listed in Tables 2506.2 and 2507.2. These materials shall be assembled and installed in compliance with the appropriate standards listed in Tables 2508.1 and ~~[2511.1]~~ 2511.1.1, and Chapter 35.

**TABLE 2508.1
INSTALLATION OF GYPSUM CONSTRUCTION**

MATERIAL	STANDARD
Gypsum board <u>and gypsum panel products</u>	GA-216; ASTM C 840 [-ASTM C 1396]
Gypsum sheathing <u>and gypsum panel products</u>	ASTM C 1280
Gypsum [Board] <u>board</u> (Interior)	[ASTM C 36] <u>ASTM C 1396</u>
Gypsum [Board] <u>board</u> (Exterior)	[ASTM C 934] <u>ASTM C 1396</u>
Gypsum veneer base	ASTM C 844
Interior lathing and furring	ASTM C 841
Steel framing for gypsum [boards] <u>board and gypsum panel products</u>	ASTM C 754; C 1007

2508.2 Limitations. Gypsum wallboard or gypsum plaster shall not be used in any exterior surface where such gypsum construction will be exposed directly to the weather. Gypsum wallboard shall not be used where there will be direct exposure to water or continuous high humidity conditions beyond the published recommendations of the manufacturer. Gypsum sheathing shall be installed on exterior surfaces in accordance with ASTM C 1280.

2508.2.1 Weather protection. Gypsum wallboard, gypsum lath or gypsum plaster shall not be installed until weather protection for the installation is provided.

2508.3 Single-ply application. Edges and ends of gypsum board and gypsum panel products shall occur on the framing members, except those edges and ends that are perpendicular to the framing members. Edges and ends of gypsum board and gypsum panel products shall be in moderate contact except in concealed spaces where fire-resistance-rated construction, shear resistance or diaphragm action is not required.

2508.3.1 Floating angles. Fasteners at the top and bottom plates of vertical assemblies, or the edges and ends of horizontal assemblies perpendicular to supports, and at the wall line are permitted to be omitted except on shear resisting elements or fire-resistance-rated assemblies. Fasteners shall be applied in such a manner as not to fracture the face paper with the fastener head.

2508.4 Joint treatment. Gypsum board and gypsum panel product fire-resistance-rated assemblies shall have joints and fasteners treated.

Exception: Joint and fastener treatment need not be provided where any of the following conditions occur:

1. Where the gypsum board or the gypsum panel product is to receive a decorative finish such as wood paneling, battens, acoustical finishes or any similar application that would be equivalent to joint treatment.
2. On single-layer systems where joints occur over wood framing members.
3. Square edge or tongue-and-groove edge gypsum board (V-edge), gypsum panel products, gypsum backing board or gypsum sheathing.
4. On multilayer systems where the joints of adjacent layers are offset [~~from one to another~~].
5. Assemblies tested without joint treatment.

2508.5 Horizontal gypsum board or gypsum panel product diaphragm ceilings. Gypsum board or gypsum panel products shall be permitted to be used on wood joists to create a horizontal diaphragm ceiling in accordance with Table 2508.5.

**TABLE 2508.5
SHEAR CAPACITY FOR HORIZONTAL [~~WOOD-FRAMED~~] WOOD-FRAME GYPSUM BOARD
DIAPHRAGM CEILING ASSEMBLIES**

MATERIAL	THICKNESS OF MATERIAL (MINIMUM) (inches)	SPACING OF FRAMING MEMBERS [(MAXIMUM)] (inches)	SHEAR VALUE ^{a,b} [(plf of ceiling)] (PLF OF CEILING)	MINIMUM FASTENER SIZE
Gypsum board <u>or gypsum panel product</u>	1/2	16 o.c.	90	5d cooler or wallboard nail; 1 5/8-inch long; 0.086-inch shank; 15/64-inch head ^c
Gypsum board <u>or gypsum panel product</u>	1/2	24 o.c.	70	5d cooler or wallboard nail; 1 5/8-inch long; 0.086-inch shank; 15/64-inch head ^c

For SI: 1 inch = 25.4 mm, 1 pound per foot = 14.59 N/m.

- a. Values are not cumulative with other horizontal diaphragm values and are for short-term [~~loading due to~~] wind or seismic loading. Values shall be reduced 25 percent for normal loading.
- b. Values shall be reduced 50 percent in Seismic Design Categories D, E and F.
- c. 1 1/4-inch, No. 6 Type S or W screws are permitted to be substituted for the listed nails.

2508.5.1 Diaphragm proportions. The maximum allowable diaphragm proportions shall be 1 1/2:1 between shear resisting elements. Rotation or cantilever conditions shall not be permitted.

2508.5.2 Installation. Gypsum board or gypsum panel products used in a horizontal diaphragm ceiling shall be installed perpendicular to ceiling framing members. End joints of adjacent courses of gypsum board shall not occur on the same joist.

2508.5.3 Blocking of perimeter edges. [~~All perimeter~~] Perimeter edges shall be blocked using a wood member not less than 2-inch by 6-inch (51 mm by 152 mm) nominal dimension. Blocking material shall be installed flat over the top plate of the wall to provide a nailing surface not less than 2 inches (51 mm) in width for the attachment of the gypsum board or gypsum panel product.

2508.5.4 Fasteners. Fasteners used for the attachment of gypsum board or gypsum panel products to a horizontal diaphragm ceiling shall be as defined in Table 2508.5. Fasteners shall be spaced not more than 7 inches (178 mm) on center [~~(6-6)~~] at all supports, including perimeter blocking, and not more than $\frac{3}{8}$ inch (9.5 mm) from the edges and ends of the gypsum board or gypsum panel product.

2508.5.5 Lateral force restrictions. Gypsum board or gypsum panel products shall not be used in diaphragm ceilings to resist lateral forces imposed by masonry or concrete construction.

SECTION BC 2509 [~~GYPSUM BOARD IN~~] SHOWERS AND WATER CLOSETS

2509.1 Wet areas. Showers and public toilet walls shall conform to [~~Sections~~] Section 1210.2 [~~and 1210.3~~].

2509.2 Base for tile. [~~Glass mat water resistant gypsum backing panels, discrete nonasbestos fiber-cement interior substrate sheets or nonasbestos fiber-mat reinforced cement substrate sheets in compliance with ASTM C 1178, C 1288 or C 1325 and installed in accordance with manufacturer recommendations shall be~~] Materials used as a base for wall tile in tub and shower areas and wall and ceiling panels in shower areas shall be of materials listed in Table 2509.2 and installed in accordance with the manufacturer's recommendations. Water-resistant gypsum backing board shall be used as a base for tile in water closet compartment walls when installed in accordance with GA-216 or ASTM C 840 and [~~manufacturer~~] the manufacturer's recommendations. Regular gypsum wallboard is permitted under tile or wall panels in other wall and ceiling areas when installed in accordance with GA-216 or ASTM C 840.

**TABLE 2509.2
BACKERBOARD MATERIALS**

<u>MATERIAL</u>	<u>STANDARD</u>
<u>Glass mat water-resistant gypsum backing panel</u>	<u>ASTM C 1178</u>
<u>Discrete nonasbestos fiber cement interior substrate sheets</u>	<u>ASTM C 1288</u>
<u>Nonasbestos fiber cement flat sheets</u>	<u>ISO 8336, Category C</u>
<u>Nonasbestos fiber-mat reinforced cementitious backer unit</u>	<u>ASTM C 1325</u>

2509.3 Limitations. Water-resistant gypsum backing board shall not be used in the following locations:

1. Over a vapor retarder in shower or bathtub compartments.
2. Where there will be direct exposure to water or in areas subject to continuous high humidity.
- ~~3. On ceilings where frame spacing exceeds 12 inches (305 mm) o.c. for 1/2 inch thick (12.7 mm) water resistant gypsum backing board and more than 16 inches (406 mm) o.c. for 5/8 inch thick (15.9 mm) water resistant gypsum backing board.]~~

**SECTION BC 2510
LATHING AND FURRING FOR CEMENT PLASTER (STUCCO)**

2510.1 General. Exterior and interior cement plaster and lathing shall be done with the appropriate materials listed in Table 2507.2 and Chapter 35.

2510.2 Weather protection. Materials shall be stored in such a manner as to protect ~~[such materials]~~ them from the weather.

2510.3 Installation. Installation of these materials shall be in compliance with ASTM C 926 and ASTM C 1063.

2510.4 Corrosion resistance. Metal lath and lath attachments shall be of corrosion-resistant material.

2510.5 Backing. Backing or a lath shall provide sufficient rigidity to permit plaster applications.

2510.5.1 Support of lath. Where lath on vertical surfaces extends between rafters or other similar projecting members, solid backing shall be installed to provide support for lath and attachments.

2510.5.2 Use of gypsum backing board. Gypsum backing for cement plaster shall be in accordance with Section 2510.5.2.1 or 2510.5.2.2.

2510.5.2.1 Use of gypsum board as a backing board. Gypsum lath or gypsum wallboard shall not be used as a backing for cement plaster.

Exception: Gypsum lath or gypsum wallboard is permitted, with a water-resistive barrier, as a backing for self-furred metal lath or self-furred wire fabric lath and cement plaster where either of the following conditions occur:

1. On horizontal supports of ceilings or roof soffits.
2. On interior walls.

2510.5.2.2 [Use of gypsum] Gypsum sheathing backing. Gypsum sheathing is permitted as a backing for metal or wire fabric lath and cement plaster on walls. A water-resistive barrier shall be provided in accordance with Section 2510.6.

2510.5.3 Backing not required. Wire backing is not required under expanded metal lath or paperbacked wire fabric lath.

2510.6 Water-resistive barriers. Water-resistive barriers shall be installed as required in Section 1404.2 and, where applied over wood-based sheathing, shall include a water-resistive [~~vapor permeable~~] barrier with a performance at least equivalent to two layers of [~~Grade D paper~~] water-resistive barrier complying with ASTM E 2556, Type I. The individual layers shall be installed independently such that each layer provides a separate continuous plane and any flashing (installed in accordance with Section 1405.4), has a means for draining water that enters the assembly to the exterior.

Exception: Where the water-resistive barrier that is applied over wood-based sheathing has a water resistance equal to or greater than that of [~~60 minute Grade D paper~~] a water-resistive barrier complying with ASTM E 2556, Type II and is separated from the stucco by an intervening, substantially nonwater-absorbing layer or drainage space.

2510.7 Preparation of masonry and concrete. Surfaces shall be clean, free from efflorescence, sufficiently damp and rough for proper bond. If the surface is insufficiently rough, approved bonding agents or a portland cement dash bond coat mixed in proportions of not more than two parts volume of sand to one part volume of portland cement or plastic cement shall be applied. The dash bond coat shall be left undisturbed and shall be moist cured not less than 24 hours.

SECTION BC 2511 INTERIOR PLASTER

2511.1 General. Plastering gypsum plaster or cement plaster shall be not less than three coats where applied over metal lath or wire fabric lath and not less than two coats where applied over other bases permitted by this chapter.

Exception: Gypsum veneer plaster and cement plaster specifically designed and approved for one-coat applications.

2511.1.1 Installation. Installation of lathing and plaster materials shall conform [~~with~~] to Table [~~2511.1~~] 2511.1.1 and Section 2507.

**TABLE [2511.1] 2511.1.1
INSTALLATION OF PLASTER CONSTRUCTION**

MATERIAL	STANDARD
Cement plaster	ASTM C 926
Gypsum plaster	ASTM C 842
Gypsum veneer plaster	ASTM C 843
Interior lathing and furring (gypsum plaster)	ASTM C 841
Lathing and furring (cement plaster)	ASTM C 1063
Steel framing	ASTM C 754; C 1007

2511.2 Limitations. Plaster shall not be applied directly to fiber insulation board. Cement plaster shall not be applied directly to gypsum lath or gypsum plaster except as specified in Sections 2510.5.1 and 2510.5.2.

2511.3 Grounds. Where installed, grounds shall ensure the minimum thickness of plaster as set forth in ASTM C 842 and ASTM C 926. Plaster thickness shall be measured from the face of lath and other bases.

2511.4 Interior masonry or concrete. Condition of surfaces shall be as specified in Section 2510.7. Approved specially prepared gypsum plaster designed for application to concrete surfaces or approved acoustical plaster is permitted. The total thickness of base coat plaster applied to concrete ceilings shall be as set forth in ASTM C 842 or ASTM C 926. Should ceiling surfaces require more than the maximum thickness permitted in ASTM C 842 or ASTM C 926, metal lath or wire fabric lath shall be installed on such surfaces before plastering.

2511.5 Wet areas. Showers and public toilet walls shall conform to Sections 1210.2 and 1210.3. When wood frame walls and partitions are covered on the interior with cement plaster or tile of similar material and are subject to water splash, the framing shall be protected with an approved moisture barrier.

SECTION BC 2512 EXTERIOR PLASTER

2512.1 General. Plastering with cement plaster shall be not less than three coats when applied over metal lath or wire fabric lath or gypsum board backing as specified in Section 2510.5 and shall be not less than two coats when applied over masonry or concrete. If the plaster surface is to be completely covered by veneer or other facing material, or is completely concealed by another wall, plaster application need only be two coats, provided the total thickness is as set forth in ASTM C 926.

2512.1.1 On-grade floor slab. On wood [~~framed~~] frame or steel stud construction with an on-grade concrete floor slab system, exterior plaster shall be applied in such a manner as to cover, but not to extend below, the lath and paper. The application of lath, paper and flashing or drip screeds shall comply with ASTM C 1063.

2512.1.2 Weep screeds. A minimum 0.019-inch (0.48 mm) (No. 26 galvanized sheet gage), corrosion-resistant weep screed with a minimum vertical attachment flange of 3½ inches (89 mm) shall be provided at or below the foundation plate line on exterior stud walls in accordance with ASTM C 926. The weep screed shall be placed a minimum of 4 inches (102 mm) above the earth or 2 inches (51 mm) above paved areas and be of a type that will allow trapped water to drain to the exterior of the building. The water-resistive barrier shall lap the attachment flange. The exterior lath shall cover and terminate on the attachment flange of the weep screed.

2512.2 Plasticity agents. Only approved plasticity agents and approved amounts thereof shall be added to portland cement or blended cements. When plastic cement or masonry cement is used, no additional lime or plasticizers shall be added. Hydrated lime or the equivalent amount of lime putty used as a plasticizer is permitted to be added to cement plaster or cement and lime plaster in an amount not to exceed that set forth in ASTM C 926.

2512.3 Limitations. Gypsum plaster shall not be used on exterior surfaces.

2512.4 Cement plaster. Plaster coats shall be protected from freezing for a period of not less than 24 hours after set has occurred. Plaster shall be applied when the ambient temperature is higher than 40°F (4°C), unless provisions are made to keep cement plaster work above 40°F (4°C) during application and 48 hours thereafter.

2512.5 Second-coat application. The second coat shall be brought out to proper thickness, rodded and floated sufficiently rough to provide adequate bond for the finish coat. The second coat shall have no variation greater than ¼ inch (6.4 mm) in any direction under a 5-foot (1524 mm) straight edge.

2512.6 Curing and interval. First and second coats of cement plaster shall be applied and moist cured as set forth in ASTM C 926 and Table 2512.6.

**TABLE 2512.6
CEMENT PLASTERS^[a]**

COAT	MINIMUM PERIOD MOIST CURING	MINIMUM INTERVAL BETWEEN COATS
First	48 hours ^a	48 hours ^b
Second	48 hours	7 days ^c
Finish	—	Note c

- a. The first two coats shall be as required for the first coats of exterior plaster, except that the moist-curing time period between the first and second coats shall not be less than 24 hours. Moist curing shall not be required where job and weather conditions are favorable to the retention of moisture in the cement plaster for the required time period.
- b. Twenty-four-hour minimum interval between coats of interior cement plaster. For alternate method of application, see Section 2512.8.
- c. Finish coat plaster is permitted to be applied to interior cement base coats after a 48-hour period.

2512.7 Application to solid backings. Where applied over gypsum backing as specified in Section 2510.5 or directly to unit masonry surfaces, the second coat is permitted to be applied as soon as the first coat has attained sufficient hardness.

2512.8 Alternate method of application. The second coat is permitted to be applied as soon as the first coat has attained sufficient rigidity to receive the second coat.

2512.8.1 Admixtures. When using this method of application, calcium aluminate cement up to 15 percent of the weight of the portland cement is permitted to be added to the mix.

2512.8.2 Curing. Curing of the first coat is permitted to be omitted and the second coat shall be cured as set forth in ASTM C 926 and Table 2512.6.

2512.9 Finish coats. Cement plaster finish coats shall be applied over base coats that have been in place for the time periods set forth in ASTM C 926. The third or finish coat shall be applied with sufficient material and pressure to bond and to cover the brown coat and shall be of sufficient thickness to conceal the brown coat.

SECTION BC 2513 EXPOSED AGGREGATE PLASTER

2513.1 General. Exposed natural or integrally colored aggregate is permitted to be partially embedded in a natural or colored bedding coat of cement plaster or gypsum plaster, subject to the provisions of this section.

2513.2 Aggregate. The aggregate shall be applied manually or mechanically and shall consist of marble chips, pebbles or similar durable, moderately hard (three or more on the Mohs hardness scale), nonreactive materials.

2513.3 Bedding coat proportions. The bedding coat for interior or exterior surfaces shall be composed of one part portland cement and one part Type S lime; or one part blended cement and one part Type S lime; or masonry cement; or plastic cement[?] and a maximum of three parts of graded white or natural sand by volume. The bedding coat for interior surfaces shall be composed of 100 pounds (45.4 kg) of neat gypsum plaster and a maximum of 200 pounds (90.8 kg) of graded white sand. A factory-prepared bedding coat for interior or exterior use is permitted. The bedding coat for exterior surfaces shall have a minimum compressive strength of 1,000 pounds per square inch (psi) (6895 kPa).

2513.4 Application. The bedding coat is permitted to be applied directly over the first (scratch) coat of plaster, provided the ultimate overall thickness is a minimum of $\frac{7}{8}$ inch (22 mm), including lath. Over concrete or masonry surfaces, the overall thickness shall be a minimum of $\frac{1}{2}$ inch (12.7 mm).

2513.5 Bases. Exposed aggregate plaster is permitted to be applied over concrete, masonry, cement plaster base coats or gypsum plaster base coats installed in accordance with Section 2511 or 2512.

2513.6 Preparation of masonry and concrete. Masonry and concrete surfaces shall be prepared in accordance with the provisions of Section 2510.7.

2513.7 Curing of base coats. Cement plaster base coats shall be cured in accordance with ASTM C 926. Cement plaster bedding coats shall retain sufficient moisture for hydration (hardening) for 24 hours minimum or, where necessary, shall be kept damp for 24 hours by light water spraying.

SECTION BC 2514
REINFORCED GYPSUM CONCRETE

2514.1 General. Reinforced gypsum concrete shall comply with the requirements of ASTM C 317 and ASTM C 956.

2514.2 Minimum thickness. The minimum thickness of reinforced gypsum concrete shall be 2 inches (51 mm) except the minimum required thickness shall be reduced to 1½ inches (38 mm), provided the following conditions are satisfied:

1. The overall thickness, including the formboard, is not less than 2 inches (51 mm).
2. The clear span of the gypsum concrete between supports does not exceed 33 inches (838 mm).
3. Diaphragm action is not required.
4. The design live load does not exceed 40 pounds per square foot (psf) (1915 Pa).

2514.3 Limitations of use. Reinforced gypsum concrete shall not be used where exposed directly to the weather or where subject to frequent or continuous wetting. Precast units shall be protected by coverings or coatings from the weather and from contact with moisture during shipment and during storage at the work site.

§ 26. Chapter 26 of the New York city building code, as added by local law number 33 for the year 2007, sections 2602.1, 2603.3, 2603.4, 2603.5.1, 2603.5.2, 2603.5.4, 2603.5.7, 2603.8, 2603.9, 2604.1, 2604.2.1, 2604.2.2, 2604.2.3, 2604.2.4, 2606.4, 2606.7, 2606.10, 2606.12, 2607.4, 2607.5, 2608.1, 2608.2, 2609.3, 2610.7, 2611.1, 2613, and the figure in section 2603.8 as amended by local law number 141 for the year 2013, and section 2603.4.1.1 as amended by local law number 51 for the year 2014, is amended to read as follows:

CHAPTER 26
PLASTIC

SECTION BC 2601
GENERAL

2601.1 Scope. These provisions shall govern the materials, design, application, construction and installation of foam plastic, foam plastic insulation, plastic veneer, interior plastic finish and trim, ~~and~~ light-transmitting plastics and plastic composites, including plastic lumber. See Chapter 14 for requirements for exterior wall finish and trim.

2601.2 Exterior wall coverings. The use of plastics in exterior wall coverings is subject to the following limitations:

1. Exterior wall coverings containing plastics shall not be permitted on Type IV construction utilizing cross-laminated timber (CLT) or structural composite lumber (SCL) complying with Section 602.4.
2. Exterior wall coverings containing plastics shall not be permitted at exterior balconies and shall comply with Section 1406.3.

Exception: Combustible water-resistive barriers complying with Section 1403.5.1.

2601.2.1 Construction documents. Construction documents for exterior wall coverings required to be tested to NFPA 285 by this chapter shall comply with the requirements of Section 1401.2.

SECTION BC 2602 DEFINITIONS

2602.1 [General.] Definitions. ~~The following [words and terms shall, for the purposes of this chapter and as used elsewhere in this code, have the meanings shown herein.]~~ terms are defined in Chapter 2:

FIBER REINFORCED POLYMER. ~~[A polymeric composite material consisting of reinforcement fibers impregnated with a fiber binding polymer which is then molded and hardened.]~~

FIBERGLASS REINFORCED POLYMER. ~~[A polymeric composite material consisting of glass reinforcement fibers impregnated with a fiber binding polymer which is then molded and hardened.]~~

FOAM PLASTIC INSULATION. ~~[A plastic that is intentionally expanded by the use of a foaming agent to produce a reduced density plastic containing voids consisting of open or closed cells distributed throughout the plastic for thermal insulating or acoustical purposes and that has a density less than 20 pounds per cubic foot (pcf) (320 kg/m³).]~~

LIGHT-DIFFUSING SYSTEM. ~~[Construction consisting in whole or in part of lenses, panels, grids or baffles made with light transmitting plastics positioned below independently mounted electrical light sources, skylights or light transmitting plastic roof panels. Lenses, panels, grids and baffles that are part of an electrical fixture shall not be considered as a light diffusing system.]~~

LIGHT-TRANSMITTING PLASTIC ROOF PANELS. ~~[Structural plastic panels other than skylights that are fastened to structural members, or panels or sheathing, and that are used as light transmitting media in the plane of the roof.]~~

LIGHT-TRANSMITTING PLASTIC WALL PANELS. ~~[Plastic materials that are fastened to structural members, or to structural panels or sheathing, and that are used as light transmitting media in exterior walls.]~~

PLASTIC, APPROVED. ~~[Any thermoplastic, thermosetting or reinforced thermosetting plastic material that conforms to combustibility classifications specified in the section applicable to the application and plastic type.]~~

PLASTIC COMPOSITE.

PLASTIC GLAZING.~~[Plastic materials that are glazed or set in frame or sash and not held by mechanical fasteners that pass through the glazing material.]~~

PLASTIC LUMBER.

THERMOPLASTIC MATERIAL.~~[A plastic material that is capable of being repeatedly softened by increase of temperature and hardened by decrease of temperature.]~~

THERMOSETTING MATERIAL.~~[A plastic material that is capable of being changed into a substantially nonreformable product when cured.]~~

WOOD/PLASTIC COMPOSITE.

**SECTION BC 2603
FOAM PLASTIC INSULATION**

2603.1 General. The provisions of this section shall govern the requirements and uses of foam plastic insulation in buildings and structures.

2603.2 Labeling and identification. Packages and containers of foam plastic insulation and foam plastic insulation components delivered to the job site shall bear the label of an approved agency showing the manufacturer's name, ~~the~~ product listing, product identification and information sufficient to determine that the end use will comply with the code requirements.

2603.3 Surface-burning characteristics. Unless otherwise indicated in this section, foam plastic insulation and foam plastic cores of manufactured assemblies shall have a flame spread index of not more than 75 and a smoke-developed index of not more than 450 where tested in the maximum thickness intended for use in accordance with ASTM E 84 or UL 723. Loose fill-type foam plastic insulation shall be tested as board stock for the flame spread ~~index~~ and smoke-developed indexes.

Exceptions:

1. Foam plastic interior trim shall comply with the flame spread and smoke-developed indexes as provided for in Section 2604.2.
2. In cold storage buildings, ice plants, food plants, food processing rooms and similar areas, foam plastic insulation where tested in a thickness of 4 inches (102 mm) shall be permitted in a thickness up to 10 inches (254 mm) where the building is equipped throughout with an automatic fire sprinkler system in accordance with Section 903.3.1.1. The approved automatic sprinkler system shall be provided in both the room and that part of the building in which the room is located.
3. Foam plastic insulation that is a part of a Class A, B or C roof-covering assembly shall be exempt from the flame spread requirements of this section provided the assembly with the foam plastic insulation satisfactorily passes ~~FM 4450~~ NFPA 276 or UL 1256. The smoke-developed index shall not be limited for roof applications.
4. Foam plastic insulation greater than 4 inches (102 mm) in thickness shall have a maximum flame spread index of 75 and a smoke-developed index of 450 where tested at a minimum

thickness of 4 inches (102 mm), provided the end use is approved in accordance with Section 2603.9 using the thickness and density intended for use.

5. Foam plastic interior signs in covered mall buildings shall not be required to comply with the flame spread and smoke-developed indexes of this section, provided the signs comply with Section ~~[402.16]~~ 402.6.4.

2603.4 Thermal barrier. Except as provided for in Sections 2603.4.1 and 2603.9, foam plastic shall be changed per DOB separated from the interior of a building by an approved thermal barrier of 1/2-inch (12.7 mm) gypsum wallboard or equivalent thermal barrier material that will limit the average temperature rise of the unexposed surface to not more than 250°F (120°C) after 15 minutes of fire exposure, complying with the standard time-temperature curve of ASTM E 119 or UL 263. The thermal barrier shall be installed in such a manner that it will remain in place for 15 minutes based on FM 4880, UL 1040, NFPA 286 or UL 1715. Combustible concealed spaces shall comply with Section ~~[718]~~ 719 of this code.

Exception: Thermal barriers for exterior walls shall comply with Section 2603.5.2.

2603.4.1 Thermal barrier not required. The thermal barrier specified in Section 2603.4 is not required under the conditions set forth in Sections 2603.4.1.1 through ~~[2603.4.1.13]~~ 2603.4.1.14.

2603.4.1.1 Masonry or concrete construction. A thermal barrier is not required for foam plastic insulation installed in a masonry or concrete wall, floor or roof system where the foam plastic insulation is covered on each face by ~~[a minimum of]~~ not less than 1 inch (25 mm) thickness of masonry or concrete.

2603.4.1.2 Cooler and freezer walls. Foam plastic installed in a maximum thickness of 10 inches (254 mm) in cooler and freezer walls shall be permitted without thermal barrier, provided that the walls:

1. Have a flame spread index of 25 or less and a smoke-developed index of not more than 450, where tested in a minimum 4-inch (102 mm) thickness.
2. Have flash ignition and self-ignition temperatures of not less than 600°F and 800°F (316°C and 427°C), respectively.
3. Have a covering of not less than 0.032-inch (0.8 mm) aluminum or corrosion-resistant steel having a base metal thickness not less than 0.0160 inch (0.4 mm) at any point.
4. ~~[Are]~~ Be protected by an automatic sprinkler system in accordance with Section 903.3.1.1. Where the cooler or freezer is within a building, both the cooler or freezer and that part of the building in which it is located shall be sprinklered.

2603.4.1.3 Walk-in coolers. In nonsprinklered buildings, foam plastic having a thickness that does not exceed 4 inches (102 mm) and a maximum flame spread index of 75 is permitted without a thermal barrier in walk-in coolers or freezer units where the aggregate floor area does not exceed 400 square feet (37 m²) and the foam plastic is covered by a metal facing not less than 0.032-inch-thick (0.81 mm) aluminum or corrosion-resistant steel having a

minimum base metal thickness of 0.016 inch (0.41 mm). A thickness of up to 10 inches (254 mm) is permitted where protected by a thermal barrier.

2603.4.1.4 ~~[Exterior walls—one-story]~~ **Exterior walls-one story buildings.** For one-story buildings, foam plastic having a flame spread index of 25 or less, and a smoke-developed index of not more than 450, shall be permitted without thermal barriers in or on exterior walls in a thickness not more than 4 inches (102 mm) where the foam plastic is covered by a thickness of not less than 0.032-inch-thick (0.81 mm) aluminum or corrosion-resistant steel having a base metal thickness of 0.0160 inch (0.41 mm) and the building is equipped throughout with an automatic sprinkler system in accordance with Section 903.3.1.1.

2603.4.1.5 Roofing. ~~[In construction classes that permit wood sheathing, foam plastic insulation under a roof assembly or roof covering shall be permitted without a thermal barrier, provided]~~ A thermal barrier is not required for foam plastic insulation that is a part of a Class A, B or C roof-covering assembly that [it] is installed in accordance with the code and the manufacturer's instructions[-. It shall be] and is either constructed as described in Item 1 or tested as described in Item 2.

1. The roof assembly is separated from the interior of the building by wood structural panel sheathing not less than 0.47 inch (11.9 mm) in thickness bonded with exterior glue, with edges supported by blocking, tongue-and-groove joints or other approved type of edge support, or an equivalent material. [A thermal barrier is not required for foam plastic insulation that is a part of a Class A, B or C roof-covering assembly, provided the]
2. The assembly with the foam plastic insulation satisfactorily passes [FM 4450] NFPA 276 or UL 1256.

2603.4.1.6 Attics and crawl spaces. Within an attic or crawl space where entry is made only for service of utilities, foam plastic insulation shall be permitted without thermal barrier if protected against ignition by 1½-inch-thick (38 mm) mineral fiber insulation; ¼-inch-thick (6.4 mm) wood structural panel, particleboard or hardboard; ⅜-inch (9.5 mm) gypsum wallboard, corrosion-resistant steel having a base metal thickness of 0.016 inch (0.4 mm) ; 1½-inch thick (38 mm) self-supported spray-applied cellulose insulation in attic spaces only or other approved material installed in such a manner that the foam plastic insulation is not exposed. The protective covering shall be consistent with the requirements for the type of construction.

2603.4.1.7 Doors not required to have a fire protection rating. Where pivoted or side-hinged doors are permitted without a fire protection rating, foam plastic insulation, having aflame spread index of 75 or less and a smoke-developed index of not more than 450, shall be permitted as a core material without a thermal barrier where the door facing is of metal having a minimum thickness of 0.032-inch (0.8 mm) aluminum or steel having a base metal thickness of not less than 0.0 16 inch (0.4 mm) at any point.

2603.4.1.8 Exterior doors in buildings of Group R-2 or R-3. In occupancies classified as Group R-2 or R-3, foam-filled exterior entrance doors to individual dwelling units that do

not require a fire-resistance rating shall be permitted without a thermal barrier, provided that the doors are faced with aluminum, steel, fiberglass, wood or other approved materials.

2603.4.1.9 Garage doors. Where garage doors are permitted without a fire-resistance rating~~[7]~~ and foam plastic is permitted as a core material, provided that the door facing shall be metal having a minimum thickness of 0.032-inch (0.8 mm) aluminum or 0.010-inch (0.25 mm) steel or the facing shall be minimum 0.125-inch-thick (3.2 mm) wood. Garage doors having facings other than those described above shall be tested in accordance with, and meet the acceptance criteria of DASMA 107.

2603.4.1.9.1 Garage doors in one- and two-family dwellings. Garage doors using foam plastic insulation complying with Section 2603.3 in detached and attached garages associated with one- and two-family dwellings need not be provided with a thermal barrier.

2603.4.1.10 Siding backer board. Foam plastic insulation of not more than 2,000 British thermal units per square ~~[feet]~~ foot (Btu/sq. ft.) (22.7 MJ/m²) as determined by NFPA 259 shall be permitted as a siding backer board with a maximum thickness of ½ inch (12.7 mm) without a thermal barrier, provided it is separated from the interior of the building by not less than 2 inches (51 mm) of mineral fiber insulation or equivalent or where applied as insulation over existing wall construction.

2603.4.1.11 Interior trim. Foam plastic used as interior trim in accordance with Section 2604 shall be permitted without a thermal barrier.

2603.4.1.12 Interior signs. Foam plastic used for interior signs in covered mall buildings in accordance with Section ~~[402.16]~~ 402.6.4 of this code shall be permitted without a thermal barrier. Foam plastic signs that are not affixed to interior building surfaces shall comply with Chapter 8 of the *New York City Fire Code*.

2603.4.1.13 Type V construction. Foam plastic spray applied to a sill plate~~and~~, joist header ~~[øf]~~ and rim joist in Type V construction is permitted without a thermal barrier, subject to all of the following:

1. The maximum thickness of the foam plastic shall be ¾-inches (82.6 mm).
2. The density of the foam plastic shall be in the range of 1.5 to 2.0 pcf (24 to 32 kg/m³).
3. The foam plastic shall have a flame spread index of 25 or less and an accompanying smoke-developed index of 450 or less when tested in accordance with ASTM E 84 or UL 723.

2603.4.1.14 Floors. The thermal barrier specified in Section 2603.4 is not required to be installed on the walking surface of a structural floor system that contains foam plastic insulation when the foam is covered by a minimum nominal ½-inch-thick (12.7 mm) wood structural panel or approved equivalent. The thermal barrier specified in Section 2603.4 is required on the underside of the structural floor system that contains foam plastic insulation when the underside of the structural floor system is exposed to the interior of the building.

Exception: Foam plastic used as part of an interior floor finish.

2603.5 Exterior walls of buildings of any height. Exterior walls of buildings of Type I, II, III or IV construction of any height shall comply with Sections 2603.5.1 through 2603.5.7. Exterior walls of cold storage buildings required to be constructed of noncombustible materials, where the building is more than one story in height, shall ~~also~~ comply with the provisions of Sections 2603.5.1 through 2603.5.7. Exterior walls of buildings of Type V construction shall comply with Sections 2603.2, 2603.3 and 2603.4.

2603.5.1 Fire-resistance-rated walls. Where the wall is required to have a fire-resistance rating, data based on tests conducted in accordance with ASTM E 119 or UL 263 shall be provided to substantiate that the fire-resistance rating is maintained.

2603.5.2 Thermal barrier. Any foam plastic insulation shall be separated from the building interior by a thermal barrier meeting the following provisions ~~[of Section 2603.4]~~, unless special approval is obtained on the basis of Section 2603.9. For exterior walls, foam plastic shall be separated from the interior of a building by an approved thermal barrier of 5/8-inch (15.9 mm) Type X gypsum wallboard or equivalent thermal barrier material that will limit the average temperature rise of the unexposed surface to not more than 250°F (120°C) after 20 minutes of fire exposure, complying with the standard time-temperature curve of ASTM E 119 or UL 263. The thermal barrier shall be installed in accordance with criteria established by testing performed in accordance with FM 4880, UL 1040, NFPA 286 or UL 1715, where the thermal barrier shall remain in place for 20 minutes. Combustible concealed spaces shall comply with Section 718 of this code.

Exception: One-story buildings complying with Section 2603.4.1.4.

2603.5.3 Potential heat. The potential heat of foam plastic insulation in any portion of the wall or panel shall not exceed the potential heat expressed in Btu per square ~~[feet]~~ foot (mJ/m²) of the foam plastic insulation contained in the wall assembly tested in accordance with Section 2603.5.5. The potential heat of the foam plastic insulation shall be determined by tests conducted in accordance with NFPA 259 and the results shall be expressed in Btu per square ~~[feet]~~ foot (mJ/m²).

Exception: One-story buildings complying with Section 2603.4.1.4.

2603.5.4 Flame spread and smoke-developed indexes. Foam plastic insulation, exterior coatings and facings shall be tested separately in the thickness intended for use, but not to exceed 4 inches (102 mm), and shall each have a flame spread index of 25 or less and a smoke-developed index of 450 or less as determined in accordance with ASTM E 84 or UL 723.

Exception: Prefabricated or factory-manufactured panels having minimum 0.020-inch (0.51 mm) aluminum facings and a total thickness of ¼-inch (6.4 mm) or less are permitted to be tested as an assembly where the foam plastic core is not exposed in the course of construction.

2603.5.5 ~~[Test standard]~~ Vertical and lateral fire propagation. The exterior wall assembly shall be tested in accordance with and comply with the acceptance criteria of NFPA 285. NFPA 285 design documentation of the tested exterior wall assembly shall be included on the submitted construction documents complying with Section 2601.2.1.

[Exception:] Exceptions:

1. One-story buildings complying with Section 2603.4.1.4.
2. Wall assemblies where the foam plastic insulation is covered on each face by not less than 1 inch (25 mm) thickness of masonry or concrete and meeting one of the following:
 - 2.1. There is no airspace between the insulation and the concrete or masonry.
 - 2.2. The insulation has a flame spread index of not more than 25 as determined in accordance with ASTM E 84 or UL 723 and the maximum airspace between the insulation and the concrete or masonry is not more than 1 inch (25 mm).

2603.5.5.1 Fireblocking. Exterior wall coverings containing foam plastic insulation shall be fireblocked in accordance with Section 718.2.6.1.

2603.5.6 Label required. The edge or face of each piece, package or container of foam plastic insulation shall bear the label of an approved agency. The label shall contain the manufacturer's or distributor's identification, model number, serial number or definitive information describing the product or materials' performance characteristics and approved agency's identification.

2603.5.7 Ignition. Exterior walls shall not exhibit sustained flaming where tested in accordance with NFPA 268. Where a material is intended to be installed in more than one thickness, tests of the minimum and maximum thickness intended for use shall be performed.

Exception: Assemblies protected on the outside with one of the following:

1. A thermal barrier complying with Section [~~2603.4~~] 2603.5.2.
2. A minimum 1-inch (25 mm) thickness of concrete or masonry.
3. Glass-fiber-reinforced concrete panels of a minimum thickness of 3/8-inch (9.5 mm).
4. Metal-faced panels having minimum 0.019-inch-thick (0.48 mm) aluminum or 0.016-inch-thick (0.41 mm) corrosion-resistant steel outer facings.
5. A minimum 7/8-inch (22.2 mm) thickness of stucco complying with Section 2510.
6. A minimum 1/4-inch (6.4 mm) thickness of fiber-cement lap, panel or shingle siding complying with Sections 1405.16 and 1405.16.1 or 1405.16.2.

2603.5.8 Special inspection. Foam plastic insulation in exterior wall coverings shall be subject to special inspection in accordance with Chapter 17.

2603.6 Roofing assembly. Foam plastic insulation meeting the requirements of Sections 2603.2, 2603.3 and 2603.4 shall be permitted as part of a roof-covering assembly, provided the assembly with the foam plastic insulation is a Class A, B or C roofing assembly where tested in accordance with ASTM E 108 or UL 790.

2603.7 [Plenums. ~~Foam plastic insulation shall not be used as interior wall or ceiling finish in plenums except as permitted in Section 2604 or when protected by a thermal barrier in accordance with Section 2603.4.]~~ **Foam plastic insulation used as interior finish or interior trim in plenums.** Foam plastic insulation used as interior wall or ceiling finish or as interior trim in plenums shall exhibit a flame spread index of 75 or less and a smoke-developed index of 450 or less when tested in accordance with ASTM E 84 or UL 723 and shall comply with one or more of Sections 2603.7.1, 2603.7.2 and 2607.3.

2603.7.1 Separation required. The foam plastic insulation shall be separated from the plenum by a thermal barrier complying with Section 2603.4 and shall exhibit a flame spread index of 75 or less and a smoke-developed index of 450 or less when tested in accordance with ASTM E 84 or UL 723 at the thickness and density intended for use.

2603.7.2 Approval. The foam plastic insulation shall exhibit a flame spread index of 25 or less and a smoke-developed index of 50 or less when tested in accordance with ASTM E 84 or UL 723 at the thickness and density intended for use and shall meet the acceptance criteria of Section 803.1.2 when tested in accordance with NFPA 286. The foam plastic insulation shall be approved based on tests conducted in accordance with Section 2603.9.

2603.7.3 Covering. The foam plastic insulation shall be covered by corrosion-resistant steel having a base metal thickness of not less than 0.0160 inch (0.4 mm) and shall exhibit a flame spread index of 75 or less and a smoke-developed index of 450 or less when tested in accordance with ASTM E 84 or UL 723 at the thickness and density intended for use.

2603.8 Protection against termites. In areas where the probability of termite infestation is very heavy in accordance with Figure 2603.8, extruded and expanded polystyrene, polyisocyanurate and other foam plastics shall not be installed on the exterior face or under interior or exterior foundation walls or slab foundations located below grade. The clearance between foam plastics installed above grade and exposed earth shall be [~~at least~~] not less than 6 inches (152 mm).

Exceptions:

1. Buildings where the structural members of walls, floors, ceilings and roofs are entirely of noncombustible materials or preservative-treated wood.
2. An approved method of protecting the foam plastic and structure from subterranean termite damage is provided; or
3. On the interior side of basement and cellar walls.

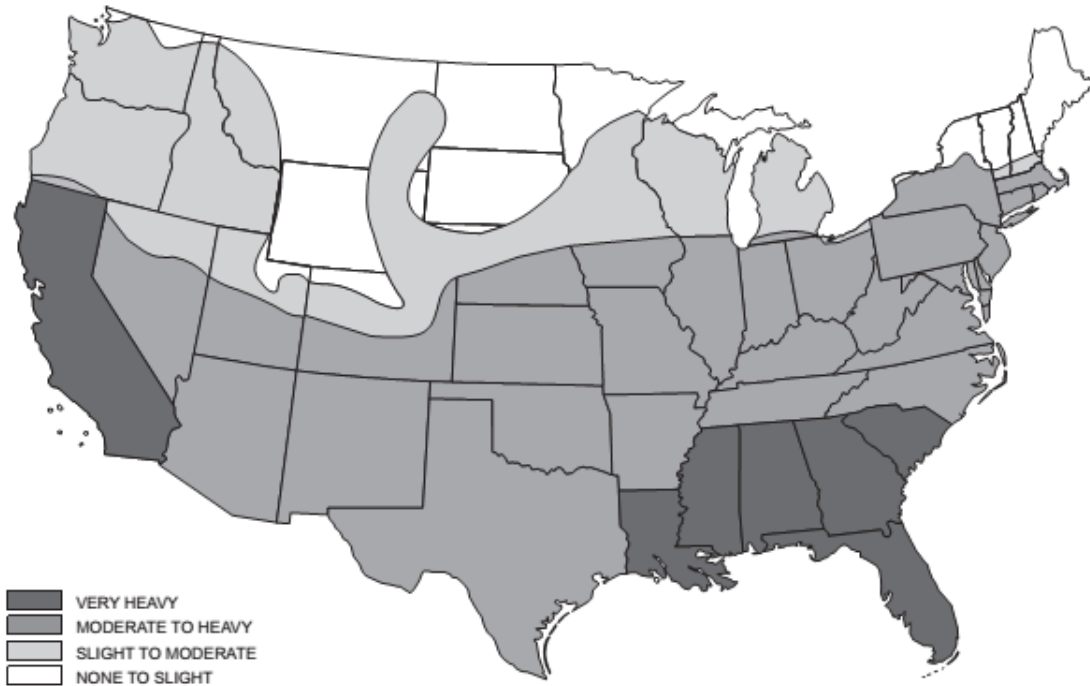

1.

**FIGURE 2603.8
TERMITE INFESTATION PROBABILITY MAP**

2603.9 Special approval. Foam plastic shall not be required to comply with the requirements of [Section] Sections 2603.4 [through 2603.7,] or 2603.6 where specifically approved by the department based on large-scale tests such as, but not limited to, NFPA 286 (with the acceptance criteria of Section [803.2] 803.1.2.1 of this code), FM 4880, UL 1040 or UL 1715. Such testing shall be related to the actual end-use configuration and be performed on the finished manufactured foam plastic assembly in the maximum thickness intended for use. Foam plastics that are used as interior finish on the basis of special tests shall also conform to the flame spread and smoke-developed index requirements of Chapter 8. Assemblies tested shall include seams, joints and other typical details used in the installation of the assembly and shall be tested in the manner intended for use.

2603.10 Wind resistance. Foam plastic insulation complying with ASTM C 578 and ASTM C 1289 and used as exterior wall sheathing on framed wall assemblies shall comply with ANSI/FS 100 for wind pressure resistance and withstand the loads indicated in Chapter 16 of this code.

2603.11 Cladding attachment over foam sheathing to masonry or concrete wall construction. Cladding shall be specified and installed in accordance with Chapter 14 and the cladding manufacturer's installation instructions or an approved design. Foam sheathing shall be attached to masonry or concrete construction in accordance with the insulation manufacturer's installation instructions or an approved design. Furring and furring attachments through foam sheathing shall be designed to resist design loads determined in accordance with Chapter 16, including support of cladding weight as applicable. Fasteners used to attach cladding or furring through foam sheathing to masonry or concrete substrates shall be approved for application into masonry or concrete material and shall be installed in accordance with the fastener manufacturer's installation instructions.

Exceptions:

1. Where the cladding manufacturer has provided approved installation instructions for application over foam sheathing and connection to a masonry or concrete substrate, those requirements shall apply.
2. For exterior insulation and finish systems, refer to Section 1408.
3. For anchored masonry or stone veneer installed over foam sheathing, refer to Section 1405.

2603.12 Cladding attachment over foam sheathing to cold-formed steel framing. Cladding shall be specified and installed in accordance with Chapter 14 and the cladding manufacturer's approved installation instructions, including any limitations for use over foam plastic sheathing, or an approved design. Where used, furring and furring attachments shall be designed to resist design loads determined in accordance with Chapter 16. In addition, the cladding or furring attachments through foam sheathing to framing shall meet or exceed the minimum fastening requirements of Sections 2603.12.1 and 2603.12.2, or an approved design for support of cladding weight.

Exceptions:

1. Where the cladding manufacturer has provided approved installation instructions for application over foam sheathing, those requirements shall apply.
2. For exterior insulation and finish systems, refer to Section 1408.
3. For anchored masonry or stone veneer installed over foam sheathing, refer to Section 1405.

2603.12.1 Direct attachment. Where cladding is installed directly over foam sheathing without the use of furring, cladding minimum fastening requirements to support the cladding weight shall be as specified in Table 2603.12.1.

**TABLE 2603.12.1
CLADDING MINIMUM FASTENING REQUIREMENTS FOR DIRECT
ATTACHMENT OVER FOAM PLASTIC SHEATHING TO SUPPORT CLADDING WEIGHT^a**

<u>CLADDING FASTENER THROUGH FOAM SHEATHING INTO:</u>	<u>CLADDING FASTENER TYPE AND MINIMUM SIZE^b</u>	<u>CLADDING FASTENER VERTICAL SPACING (inches)</u>	<u>MAXIMUM THICKNESS OF FOAM SHEATHING^c (inches)</u>					
			<u>16^o.c. fastener horizontal spacing</u>			<u>24^o.c. fastener horizontal spacing</u>		
			<u>Cladding weight</u>			<u>Cladding weight</u>		
			<u>3 psf</u>	<u>11 psf</u>	<u>25 psf</u>	<u>3 psf</u>	<u>11 psf</u>	<u>25 psf</u>
Steel framing (minimum penetration of steel thickness plus 3 threads)	#8 screw into 33 mil steel or thicker	6	3	3	1.5	3	2	DR
		8	3	2	0.5	3	1.5	DR
		12	3	1.5	DR	3	0.75	DR
	#10 screw into 33 mil steel	6	4	3	2	4	3	0.5
		8	4	3	1	4	2	DR
		12	4	2	DR	3	1	DR
	#10 screw into 43 mil steel or thicker	6	4	4	3	4	4	2
		8	4	4	2	4	3	1.5
		12	4	3	1.5	4	3	DR

For SI: 1 inch = 25.4 mm; 1 pound per square foot (psf) = 0.0479 kPa; 1 pound per square inch = 0.00689 MPa.

DR = design required; o.c. = on center.

a. Steel framing shall be minimum 33 ksi steel for 33 mil and 43 mil steel and 50 ksi steel for 54 mil steel or thicker.

b. Screws shall comply with the requirements of AISI S240.

c. Foam sheathing shall have a minimum compressive strength of 15 pounds per square inch in accordance with ASTM C 578 or ASTM C 1289.

2603.12.2 Furred cladding attachment. Where steel or wood furring is used to attach cladding over foam sheathing, furring minimum fastening requirements to support the cladding weight shall be as specified in Table 2603.12.2. Where placed horizontally, wood furring shall be preservative-treated wood in accordance with Section 2303.1.9 or naturally durable wood and fasteners shall be corrosion resistant in accordance Section 2304.10.5. Steel furring shall have a minimum G60 galvanized coating.

TABLE 2603.12.2
FURRING MINIMUM FASTENING REQUIREMENTS FOR
APPLICATION OVER FOAM PLASTIC SHEATHING TO SUPPORT CLADDING WEIGHT^a

<u>FURRING MATERIAL</u>	<u>FRAMING MEMBER</u>	<u>FASTENER TYPE AND MINIMUM SIZE^b</u>	<u>MINIMUM PENETRATION INTO WALL FRAMING (inches)</u>	<u>FASTENER SPACING IN FURRING (inches)</u>	<u>MAXIMUM THICKNESS OF FOAM SHEATHING⁴ (inches)</u>					
					<u>16² o.c. furring</u>			<u>24² o.c. furring</u>		
					<u>Cladding weight</u>			<u>Cladding weight</u>		
					<u>3 psf</u>	<u>11 psf</u>	<u>25 psf</u>	<u>3 psf</u>	<u>11 psf</u>	<u>25 psf</u>
Minimum 33 mil steel furring or minimum 1x wood furring	33 mil steel stud	#8 screw	Steel thickness plus 3 threads	12	3	1.5	DR	3	0.5	DR
				16	3	1	DR	2	DR	DR
				24	2	DR	DR	2	DR	DR
		#10 screw	Steel thickness plus 3 threads	12	4	2	DR	4	1	DR
				16	4	1.5	DR	3	DR	DR
				24	3	DR	DR	2	DR	DR
	43 mil or thicker steel stud	#8 Screw	Steel thickness plus 3 threads	12	3	1.5	DR	3	0.5	DR
				16	3	1	DR	2	DR	DR
				24	2	DR	DR	2	DR	DR
		#10 screw	Steel thickness plus 3 threads	12	4	3	1.5	4	3	DR
				16	4	3	0.5	4	2	DR
				24	4	2	DR	4	0.5	DR

For SI: 1 inch = 25.4 mm; 1 pound per square foot (psf) = 0.0479 kPa, 1 pound per square inch = 0.00689 MPa.

DR = design required; o.c. = on center.

- Wood furring shall be Spruce-Pine fir or any softwood species with a specific gravity of 0.42 or greater. Steel furring shall be minimum 33 ksi steel. Steel studs shall be minimum 33 ksi steel for 33 mil and 43 mil thickness and 50 ksi steel for 54 mil steel or thicker.
- Screws shall comply with the requirements of AISI S240.
- Where the required cladding fastener penetration into wood material exceeds 3/4 inch and is not more than 1 1/2 inches, a minimum 2-inch nominal wood furring shall be used or an approved design.
- Foam sheathing shall have a minimum compressive strength of 15 pounds per square inch in accordance with ASTM C 578 or ASTM C 1289.
- Furring shall be spaced not more than 24 inches on center, in a vertical or horizontal orientation. In a vertical orientation, furring shall be located over wall studs and attached with the required fastener spacing. In a horizontal orientation, the indicated 8-inch and 12-inch fastener spacing in furring shall be achieved by use of two fasteners into studs at 16 inches and 24 inches on center, respectively.

SECTION BC 2604 INTERIOR FINISH AND TRIM

2604.1 General. Plastic materials installed as interior finish or trim shall comply with Chapter 8. Foam plastics shall only be installed as interior finish where approved in accordance with the special provisions of Section 2603.9. Foam plastics that are used as interior finish shall also meet the flame

spread and smoke-developed index requirements for interior finish in accordance with Chapter 8. Foam plastics installed as interior trim shall comply with Section 2604.2.

2604.2 Foam plastic interior trim. Foam plastic used as interior trim shall comply with Sections 2604.2.1 through 2604.2.4.

2604.2.1 Density. The minimum density of the interior trim shall be 20 pcf (320 kg/m³).

2604.2.2 Thickness. The maximum thickness of the interior trim shall be ½-inch (12.7 mm) and the maximum width shall be 8 inches (204 mm).

2604.2.3 Area limitation. The interior trim shall not constitute more than 10 percent of the specific wall or ceiling area to which it is attached.

2604.2.4 Flame spread. The flame spread index shall not exceed 75 where tested in accordance with ASTM E 84 or UL 723. The smoke-developed index shall not be limited.

Exception: When the interior trim material has been tested as an interior finish in accordance with NFPA 286 and complies with the acceptance criteria in Section 803.1.2.1 of this code, it shall not be required to be tested for flame spread index in accordance with ASTM E 84 or UL 723.

SECTION BC 2605 PLASTIC VENEER

2605.1 Interior use. Where used within a building, plastic veneer shall comply with the interior finish requirements of Chapter 8.

2605.2 Exterior use. Exterior plastic veneer, other than plastic siding, shall be permitted to be installed on the exterior walls of buildings of any type of construction in accordance with all of the following requirements:

1. Plastic veneer shall comply with Section 2606.4.
2. Plastic veneer shall not be attached to any exterior wall to a height greater than 50 feet (15 240 mm) above grade.
3. Sections of plastic veneer shall not exceed 300 square feet (27.9 m²) in area and shall be separated by ~~[a minimum of]~~ not less than 4 feet (1219 mm) vertically.
4. Fireblocking complying with Section 718.2.6.1 shall be installed.

Exception: The area and separation requirements and the smoke-density limitation are not applicable to plastic veneer applied to buildings constructed of Type VB construction, provided the walls are not required to have a fire-resistance rating.

2605.3 Plastic siding. ~~[Plastic]~~ Polypropylene siding and vinyl siding shall comply with the requirements of Sections 1404 and 1405.

2605.4 Special inspection. Plastic veneers shall be subject to special inspection in accordance with Chapter 17.

SECTION BC 2606 LIGHT-TRANSMITTING PLASTICS

2606.1 General. The provisions of this section and Sections 2607 through 2611 shall govern the quality and methods of application of light-transmitting plastics for use as light-transmitting materials in buildings and structures. Foam plastics shall comply with Section 2603. Light-transmitting plastic materials that meet the other code requirements for walls and roofs shall be permitted to be used in accordance with the other applicable chapters of the code.

2606.2 Approval for use. Sufficient technical data shall be submitted to substantiate the proposed use of any light-transmitting material, as approved by the department and subject to the requirements of this section.

2606.3 Identification. Each unit or package of light-transmitting plastic shall be identified with a mark or decal satisfactory to the commissioner, which includes identification as to the material classification.

2606.4 Specifications. Light-transmitting plastics, including thermoplastic, thermosetting or reinforced thermosetting plastic material, shall have a self-ignition temperature of 650°F (343°C) or greater where tested in accordance with ASTM D 1929; a smoke-developed index not greater than 450 where tested in the manner intended for use in accordance with ASTM E 84 or UL 723, or a maximum average smoke density rating not greater than 75 where tested in the thickness intended for use in accordance with ASTM D 2843 and shall conform to one of the following combustibility classifications:

Class CC1: Plastic materials that have a burning extent of 1 inch (25 mm) or less where tested at a nominal thickness of 0.060 inch (1.5 mm), or in the thickness intended for use, in accordance with ASTM D 635[-].

Class CC2: Plastic materials that have a burning rate of 2½-inches per minute (1.06 mm/s) or less where tested at a nominal thickness of 0.060 inch (1.5 mm), or in the thickness intended for use, in accordance with ASTM D 635.

2606.5 Structural requirements. Light-transmitting plastic materials in their assembly shall be of adequate strength and durability to withstand the loads indicated in Chapter 16. Technical data shall be submitted to establish stresses, maximum unsupported spans and such other information for the various thicknesses and forms used as deemed necessary by the department.

2606.6 Fastening. Fastening shall be adequate to withstand the loads in Chapter 16. Proper allowance shall be made for expansion and contraction of light-transmitting plastic materials in accordance with accepted data on the coefficient of expansion of the material and other material in conjunction with which it is employed.

2606.7 Light-diffusing systems. Light-diffusing systems shall comply with Sections [~~2603.7.1 through 2603.7.5~~] 2606.7.1 through 2606.7.5. Light-diffusing systems shall not be installed in the following occupancies and locations:

1. Any room in which the net floor area per occupant is 20 square feet (1.86 m²) or less, or any room leading therefrom through which it is necessary for occupants to pass in order to reach the only exit.
2. Group I-2.
3. Group I-3.
4. [~~Vertical exit enclosures~~] Interior exit stairways, ramps and exit passageways.

2606.7.1 Support. Light-transmitting plastic diffusers shall be supported directly or indirectly from ceiling or roof construction by use of noncombustible hangers. Hangers shall be [~~at least~~] not less than No. 12 steel-wire gage (0.106 inch) galvanized wire or equivalent.

Exception: Light-transmitting plastic diffusers used in suspended acoustical ceiling systems shall conform with the support requirements as set forth in Section [~~803.9~~] 808.1.

2606.7.2 Installation. Light-transmitting plastic diffusers shall comply with Chapter 8 unless the light-transmitting plastic diffusers will fall from the mountings before igniting, at an ambient temperature of [~~at least~~] not less than 200°F (111°C) below the ignition temperature of the panels. The panels shall remain in place at an ambient room temperature of 175°F (79°C) for a period of not less than 15 minutes.

2606.7.3 Size limitations. Individual panels or units shall not exceed 10 feet (3048 mm) in length nor 30 square feet (2.79 m²) in area.

2606.7.4 Fire suppression system. In buildings that are equipped throughout with an automatic sprinkler system in accordance with Section 903.3.1.1, plastic light-diffusing systems shall be protected both above and below unless the sprinkler system has been specifically approved for installation only above the light-diffusing system. Areas of light-diffusing systems that are protected in accordance with this section shall not be limited.

2606.7.5 Electrical luminaires. Light-transmitting plastic panels and light-diffuser panels that are installed in approved electrical luminaires shall comply with the requirements of Chapter 8 unless the light-transmitting plastic panels conform to the requirements of Section 2606.7.2.

2606.8 Partitions. Light-transmitting plastics used in or as partitions shall comply with the requirements of Chapters 6 and 8.

2606.9 Bathroom accessories. Light-transmitting plastics shall be permitted as glazing in shower stalls, shower doors, bathtub enclosures and similar accessory units. Safety glazing shall be provided in accordance with Chapter 24.

2606.10 Awnings, patio covers and similar structures. Awnings constructed of light-transmitting plastics shall be constructed in accordance with provisions specified in Section 3105 and Chapter 32

for projections. Patio covers constructed of light-transmitting plastics shall comply with Section 2606. Light-transmitting plastics used in canopies at motor fuel-dispensing facilities shall comply with Section 2606, except as modified by Section ~~[406.5.3]~~ 406.7.2.

2606.11 Greenhouses. Light-transmitting plastics shall be permitted in lieu of plain glass in greenhouses.

2606.12 Solar collectors. Light-transmitting plastic covers on solar collectors having noncombustible sides and bottoms shall be permitted on buildings not over three stories above grade plane or 9,000 square feet (836.1 m²) in total floor area, provided the light-transmitting plastic cover does not exceed 33.33 percent of the roof area for CC1 materials or 25 percent of the roof area for CC2 materials.

Exception: Light-transmitting plastic covers having a thickness of 0.010 inch (0.3 mm) or less ~~[ø]~~ shall be permitted to be of any plastic material provided the area of the solar collectors does not exceed 33.33 percent of the roof area.

SECTION BC 2607 LIGHT-TRANSMITTING PLASTIC WALL PANELS

2607.1 General. Light-transmitting plastics shall be permitted to be used as wall panels in exterior walls, provided that the walls are not required to have a fire-resistance rating and the installation conforms to the requirements of this section. Such panels shall be erected and anchored on a foundation, waterproofed or otherwise protected from moisture absorption and sealed with a coat of mastic or other approved waterproof coating. Light-transmitting plastic wall panels shall ~~[also]~~ comply with Section 2606.

Exception: Light-transmitting plastics shall not be used as wall panels in exterior walls in occupancies in Groups A-1, A-2, H, I-2 and I-3.

2607.2 Installation. Exterior wall panels installed as provided for herein shall not alter the type of construction classification of the building.

2607.3 Height limitation. Light-transmitting plastics shall not be installed more than 75 feet (22 860 mm) above grade plane, except as allowed by Section 2607.5.

2607.4 Area limitation and separation. The maximum area of a single wall panel and minimum vertical and horizontal separation requirements for exterior light-transmitting plastic wall panels shall be as provided for in Table 2607.4. The maximum percentage of wall area of any story in light-transmitting plastic wall panels shall not exceed that indicated in Table 2607.4 or the percentage of unprotected openings permitted by Section 705.8, whichever is smaller.

Exceptions:

1. In structures provided with approved flame barriers extending 30 inches (760 mm) beyond the exterior wall in the plane of the floor, a vertical separation is not required at the floor except that provided by the vertical thickness of the flame barrier projection.

2. Veneers of approved weather-resistant light-transmitting plastics used as exterior siding in buildings of Type V construction in compliance with Section 1406.
3. The area of light-transmitting plastic wall panels in exterior walls of greenhouses shall be exempt from the area limitations of Table 2607.4 but shall be limited as required for unprotected openings in accordance with Section 705.8.

**TABLE 2607.4
AREA LIMITATION AND SEPARATION REQUIREMENTS FOR LIGHT-TRANSMITTING PLASTIC
WALL PANELS^a**

FIRE SEPARATION DISTANCE (feet)	CLASS OF PLASTIC	MAXIMUM PERCENTAGE AREA OF EXTERIOR WALL IN PLASTIC WALL PANELS	MAXIMUM SINGLE AREA OF PLASTIC WALL PANELS (square feet)	MINIMUM SEPARATION OF PLASTIC WALL PANELS (feet)	
				Vertical	Horizontal
Less than 6	—	Not Permitted	Not Permitted	—	—
6 or more but less than 11	CC1	10	50	8	4
	CC2	Not Permitted	Not Permitted	—	—
11 or more but less than or equal to 30	CC1	25	90	6	4
	CC2	15	70	8	4
Over 30	CC1	50	Not Limited	3 ^b	0
	CC2	50	100	6 ^b	3

For SI: 1 foot = 304.8 mm, 1 square foot = 0.0929 m².

- a. For combinations of plastic glazing and plastic wall panel areas permitted, see Section 2607.6.
- b. For reductions in vertical separation allowed, see Section 2607.4.

2607.5 Automatic sprinkler system. Where the building is equipped throughout with an automatic sprinkler system in accordance with Section 903.3.1.1, the maximum percentage area of exterior wall in any story in light-transmitting plastic wall panels and the maximum square footage of a single area given in Table 2607.4 shall be increased 100 percent, but the area of light-transmitting plastic wall panels shall not exceed 50 percent of the wall area in any story, or the area permitted by Section 705.8 for unprotected openings, whichever is smaller. These installations shall be exempt from height limitations.

2607.6 Combinations of glazing and wall panels. Combinations of light-transmitting plastic glazing and light-transmitting plastic wall panels shall be subject to the area, height and percentage limitations and the separation requirements applicable to the class of light-transmitting plastic as prescribed for light-transmitting plastic wall panel installations.

SECTION BC 2608 LIGHT-TRANSMITTING PLASTIC GLAZING

2608.1 Buildings of Type VB construction. Openings in the exterior walls of buildings of Type VB construction, where not required to be protected by Section 705, shall be permitted to be glazed or

equipped with light-transmitting plastic. Light-transmitting plastic glazing shall [also] comply with Section 2606.

2608.2 Buildings of other types of construction. Openings in the exterior walls of buildings of types of construction other than Type VB, where not required to be protected by Section 705, shall be permitted to be glazed or equipped with light-transmitting plastic in accordance with Section 2606 and all of the following:

1. The aggregate area of light-transmitting plastic glazing shall not exceed 25 percent of the area of any wall face of the story in which it is installed. The area of a single pane of glazing installed above the first story above grade plane shall not exceed 16 square feet (1.5 m²) and the vertical dimension of a single pane shall not exceed 4 feet (1219 mm).

Exception: Where an automatic sprinkler system is provided throughout in accordance with Section 903.3.1.1, the area of allowable glazing shall be increased to [~~a maximum of~~] not more than 50 percent of the wall face of the story in which it is installed with no limit on the maximum dimension or area of a single pane of glazing.

2. Approved flame barriers extending 30 inches (762 mm) beyond the exterior wall in the plane of the floor, or approved vertical panels not less than 4 feet (1219 mm) in height, shall be installed between glazed units located in adjacent stories.

Exception: Approved vertical panels not less than 3 feet (914 mm) in height or flame barriers extending 30 inches (762 mm) beyond the exterior wall shall be installed between glazed units located in adjacent stories in buildings equipped throughout with an automatic sprinkler system in accordance with Section 903.3.1.1.

3. Light-transmitting plastics shall not be installed more than 75 feet (22 860 mm) above grade level.

Exception: Buildings equipped throughout with an automatic sprinkler system in accordance with Section 903.3.1.1.

SECTION BC 2609 LIGHT-TRANSMITTING PLASTIC ROOF PANELS

2609.1 General. Light-transmitting plastic roof panels shall comply with this section and Section 2606. Light-transmitting plastic roof panels shall not be installed in Groups H, I-2 and I-3. In all other groups, light-transmitting plastic roof panels shall comply with any one of the following conditions:

1. The building is equipped throughout with an automatic sprinkler system in accordance with Section 903.3.1.1.
2. The roof construction is not required to have a fire-resistance rating by Table 601.
3. The roof panels meet the requirements for roof coverings in accordance with Chapter 15.

2609.2 Separation. Individual roof panels shall be separated from each other by a distance of not less than 4 feet (1219 mm) measured in a horizontal plane.

Exceptions:

1. The separation between roof panels is not required in a building equipped throughout with an automatic sprinkler system in accordance with Section 903.3.1.1.
2. The separation between roof panels is not required in low-hazard occupancy buildings complying with the conditions of Section 2609.4, Exception 2 or 3.

2609.3 Location. Where exterior wall openings are required to be protected by Section 705.8, a roof panel shall not be installed within 6 feet (1829 mm) of such exterior wall.

2609.4 Area limitations. Roof panels shall be limited in area and the aggregate area of panels shall be limited by a percentage of the floor area of the room or space sheltered in accordance with Table 2609.4.

Exceptions:

1. The area limitations of Table 2609.4 shall be permitted to be increased by 100 percent in buildings equipped throughout with an automatic sprinkler system in accordance with Section 903.3.1.1.
2. Low-hazard occupancy buildings, such as swimming pool shelters, shall be exempt from the area limitations of Table 2609.4, provided that the buildings do not exceed 5,000 square feet (465 m²) in area and have a minimum fire separation distance of 10 feet (3048 mm).
3. Greenhouses that are occupied for growing plants on a production or research basis, without public access, shall be exempt from the area limitations of Table 2609.4 provided they have a minimum fire separation distance of 4 feet (~~1219~~ 1220 mm).
4. Roof coverings over terraces and patios in Group R-3 occupancies shall be exempt from the area limitations of Table 2609.4.

**TABLE 2609.4
AREA LIMITATIONS FOR
LIGHT-TRANSMITTING PLASTIC ROOF PANELS**

CLASS OF PLASTIC	MAXIMUM AREA OF INDIVIDUAL ROOF PANELS (square feet)	MAXIMUM AGGREGATE AREA OF ROOF PANELS (percent of floor area)
CC1	300	30
CC2	100	25

For SI: 1 square foot = 0.0929 m².

**SECTION BC 2610
LIGHT-TRANSMITTING PLASTIC SKYLIGHT
GLAZING**

2610.1 Light-transmitting plastic glazing of skylight assemblies. Skylight assemblies glazed with light-transmitting plastic shall conform to the provisions of this section and Section 2606. Unit skylights glazed with light-transmitting plastic shall ~~[also]~~ comply with Section 2405.5.

Exception: Skylights in which the light-transmitting plastic conforms to the required roof-covering class in accordance with Section 1505.

2610.2 Mounting. The light-transmitting plastic shall be mounted above the plane of the roof on a curb constructed in accordance with the requirements for the type of construction classification, but ~~[at least]~~ not less than 4 inches (102 mm) above the plane of the roof. Edges of the light-transmitting plastic skylights or domes shall be protected by metal or other approved noncombustible material, or the light-transmitting plastic dome or skylight shall be shown to be able to resist ignition where exposed at the edge to a flame from a Class B brand as described in ASTM E 108 or UL 790. The Class B brand test shall be conducted on a skylight that is elevated to a height as specified in the manufacturer's instructions, but not less than 4 inches (102 mm).

Exceptions:

1. Curbs shall not be required for skylights used on roofs having a minimum slope of three units vertical in 12 units horizontal (25-percent slope) in occupancies in Group R-3 and on buildings with a nonclassified roof covering.
2. The metal or noncombustible edge material is not required where nonclassified roof coverings are permitted.

2610.3 Slope. Flat or corrugated light-transmitting plastic skylights shall slope ~~[at least]~~ not less than four units vertical in 12 units horizontal (4:12). Dome-shaped skylights shall rise above the mounting flange a minimum distance equal to 10 percent of the maximum ~~[span]~~ width of the dome but not less than 3 inches (76 mm).

Exception: Skylights that pass the Class B Burning Brand Test specified in ASTM E 108 or UL 790 shall have no minimum slope requirement.

2610.4 Maximum area of skylights. Each skylight shall have a maximum area within the curb of 100 square feet (9.3 m²).

Exception: The area limitation shall not apply where the building is equipped throughout with an automatic sprinkler system in accordance with Section 903.3.1.1 or the building is equipped with smoke and heat vents in accordance with Section 910.

2610.5 Aggregate area of skylights. The aggregate area of skylights shall not exceed 33¹/₃ percent of the floor area of the room or space sheltered by the roof in which such skylights are installed where Class CC1 materials are utilized, and 25 percent where Class CC2 materials are utilized.

Exception: The aggregate area limitations of light-transmitting plastic skylights shall be increased 100 percent beyond the limitations set forth in this section where the building is equipped throughout with an automatic sprinkler system in accordance with Section 903.3.1.1 or the building is equipped with smoke and heat vents in accordance with Section 910.

2610.6 Separation. Skylights shall be separated from each other by a distance of not less than 4 feet (1219 mm) measured in a horizontal plane.

Exceptions:

1. Buildings equipped throughout with an automatic sprinkler system in accordance with Section 903.3.1.1.
2. In Group R-3, multiple skylights located above the same room or space with a combined area not exceeding the limits set forth in Section 2610.4.

2610.7 Location. Where exterior wall openings are required to be protected in accordance with Section 705, a skylight shall not be installed within 6 feet (1829 mm) of such exterior wall.

2610.8 Combinations of roof panels and skylights. Combinations of light-transmitting plastic roof panels and skylights shall be subject to the area and percentage limitations and separation requirements of Section 2609 applicable to roof panel installations.

**SECTION BC 2611
LIGHT-TRANSMITTING PLASTIC INTERIOR SIGNS**

2611.1 General. Light-transmitting plastic interior wall signs shall be limited as specified in Sections 2611.2 through 2611.4. Light-transmitting plastic interior wall signs in covered and open mall buildings shall comply with Section [402.16] 402.6.4. Light-transmitting plastic interior signs shall also comply with Section 2606.

2611.2 Aggregate area. The sign shall not exceed 20 percent of the wall area.

2611.3 Maximum area. The sign shall not exceed 24 square feet (2.2 m²).

2611.4 Encasement. Edges and backs of the sign shall be fully encased in metal.

**SECTION BC 2612
PLASTIC COMPOSITES**

2612.1 General. Plastic composites shall consist of either wood/plastic composites or plastic lumber. Plastic composites shall comply with the provisions of this code and with the additional requirements of Section 2612.

2612.2 Labeling and identification. Packages and containers of plastic composites used in exterior applications shall bear a label showing the manufacturer's name, product identification and information sufficient to determine that the end use will comply with code requirements.

2612.2.1 Performance levels. The label for plastic composites used in exterior applications as deck boards, stair treads, handrails and guards shall indicate the required performance levels and demonstrate compliance with the provisions of ASTM D 7032.

2612.2.2 Loading. The label for plastic composites used in exterior applications as deck boards, stair treads, handrails and guards shall indicate the type and magnitude of the load determined in accordance with ASTM D 7032.

2612.3 Flame spread index. Plastic composites shall exhibit a flame spread index not exceeding 200 when tested in accordance with ASTM E 84 or UL 723 with the test specimen remaining in place during the test.

Exception: Materials determined to be noncombustible in accordance with Section 703.5.

2612.4 Termite and decay resistance. Plastic composites containing wood, cellulosic or any other biodegradable materials shall be termite and decay resistant as determined in accordance with ASTM D 7032.

2612.5 Construction requirements. Plastic composites shall be permitted to be used as exterior deck boards, stair treads, handrails and guards in buildings of Type VB construction.

2612.5.1 Span rating. Plastic composites used as exterior deck boards shall have a span rating determined in accordance with ASTM D 7032.

2612.6 Plastic composite decking, handrails and guards. Plastic composite decking, handrails and guards shall be installed in accordance with this code and the manufacturer's instructions.

[SECTION BC 2612]

[Fiber-reinforced polymer AND FIBERGLASS REINFORCED POLYMER]

SECTION BC 2613

Fiber-reinforced polymer

[2612.1] 2613.1 General. The provisions of this section shall govern the requirements and uses of [~~fiber reinforced polymer or fiberglass reinforced polymer~~] fiber-reinforced polymer in and on buildings and structures.

[2612.2] 2613.2 Labeling and identification. Packages and containers of [~~fiber reinforced polymer or fiberglass reinforced polymer~~] fiber-reinforced polymer and their components delivered to the job site shall bear the label of an approved agency showing the manufacturer's name, product listing, product identification and information sufficient to determine that the end use will comply with the code requirements.

[2612.3 Interior finish] 2613.3 Interior finishes. [~~Fiber reinforced polymer or fiber glass reinforced polymer used as interior finish~~] Fiber-reinforced polymer used as interior finishes, decorative materials or trim shall comply with Chapter 8.

2613.3.1 Foam plastic cores. Fiber-reinforced polymer used as interior finish and which contains foam plastic cores shall comply with Chapter 8 and this chapter.

~~[2612.4 Decorative materials and trim. Fiber reinforced polymer or fiberglass reinforced polymer used as decorative materials or trim shall comply with Section 806.]~~

~~[2612.5]~~ **2613.4 Light-transmitting materials.** ~~[Fiber reinforced polymer or fiberglass reinforced polymer]~~ Fiber-reinforced polymer used as light-transmitting materials shall comply with Sections 2606 through 2611 as required for the specific application.

~~[2612.6]~~ **2613.5 Exterior use.** ~~[Fiber reinforced]~~ Fiber-reinforced polymer ~~[or fiberglass reinforced polymer]~~ shall be permitted to be installed on the exterior walls of buildings of any type of construction when such polymers meet the requirements of Section 2603.5 ~~[and is fireblocked].~~ Fireblocking shall be installed in accordance with Section [717] 718. ~~[The fiber reinforced polymer or the fiberglass reinforced polymer shall be designed for uniform live loads as required in Table 1607.1 as well as for snow loads, wind loads and earthquake loads as specified in Sections 1608, 1609 and 1613, respectively.]~~

Exceptions:

1. ~~[When]~~ Compliance with Section 2603.5 is not required when all of the following conditions are met:
 - 1.1. ~~[When the area of the fiber reinforced polymer or the fiberglass reinforced polymer does not exceed 20 percent of the respective wall area, the fiber reinforced polymer or the fiberglass reinforced polymer shall have a flame spread index of 25 or less or when the area of the fiber reinforced polymer or the fiberglass reinforced polymer does not exceed 10 percent of the respective wall area, the fiber reinforced polymer or the fiberglass reinforced polymer shall have a flame spread index of 75 or less. The flame spread index requirement shall not be required for coatings or paints having a thickness of less than 0.036 inch (0.9 mm) that are applied directly to the surface of the fiber reinforced polymer or the fiberglass reinforced polymer.]~~ The fiber-reinforced polymer shall not exceed an aggregate total of 20 percent of the area of the specific wall to which it is attached, and no single architectural element shall exceed 10 percent of the area of the specific wall to which it is attached, and no contiguous set of architectural elements shall exceed 10 percent of the area of the specific wall to which they are attached.
 - 1.2. The fiber-reinforced polymer shall have a flame spread index of 25 or less. The flame spread index requirement shall not be required for coatings or paints having a thickness of less than 0.036 inch (0.9 mm) that are applied directly to the surface of the fiber-reinforced polymer.
 - 1.3. Fireblocking complying with Section [717.2.6] 718.2.6 shall be installed.
 - ~~[1.3.]~~ 1.4. ~~The [fiber reinforced]~~ fiber-reinforced polymer ~~[or the fiberglass reinforced polymer]~~ shall be installed directly to a noncombustible substrate or be separated from the exterior wall by one of the following materials: corrosion-resistant steel having a minimum base metal thickness of 0.016

inch (0.41 mm) at any point, aluminum having a minimum thickness of 0.019 inch (0.5 mm) or other approved noncombustible material.

~~[1.4. The fiber reinforced polymer or the fiberglass reinforced polymer shall be designed for uniform live loads as required in Table 1607.1 as well as for snow loads, wind loads and earthquake loads as specified in Sections 1608, 1609 and 1613, respectively.]~~

2. ~~[When]~~ Compliance with Section 2603.5 is not required when the fiber-reinforced polymer is installed on buildings that are 40 feet (12 190 mm) or less above grade~~[, the fiber reinforced polymer or the fiberglass polymer shall meet the requirements of Section 1406.2 and shall comply with]~~ when all of the following conditions are met:

2.1. The fiber-reinforced polymer shall meet the requirements of Section 1406.2.

2.2. Where the fire separation distance is 5 feet (1524 mm) or less, the area of the ~~[fiber reinforced]~~ fiber-reinforced polymer ~~[or the fiberglass reinforced polymer]~~ shall not exceed 10 percent of the wall area. Where the fire separation distance is greater than 5 feet (1524 mm), there shall be no limit on the area of the exterior wall coverage using ~~[fiber reinforced polymer or the fiber reinforced]~~ fiber-reinforced polymer.

~~[2.2.]~~ 2.3. The ~~[fiber reinforced]~~ fiber-reinforced polymer ~~[or the fiberglass reinforced polymer]~~ shall have a flame spread index of 200 or less. The flame spread index ~~[requirement shall not be required for]~~ requirements do not apply to coatings or paints having a thickness of less than 0.036 inch (0.9 mm) that are applied directly to the surface of the ~~[fiber reinforced]~~ fiber-reinforced polymer ~~[or the fiberglass reinforced polymer]~~.

~~[2.3.]~~ 2.4. Fireblocking complying with Section [717.2.6] 718.2.6 shall be installed.

~~[2.4. The fiber reinforced polymer or the fiberglass reinforced polymer shall be designed for uniform live loads as required in Table 1607.1 as well as for snow loads, wind loads and earthquake loads as specified in Sections 1608, 1609 and 1613, respectively.]~~

SECTION BC ~~[2613]~~ 2614 REFLECTIVE PLASTIC CORE INSULATION

~~[2613.1] 2614.1 General.~~ The provisions of this section shall govern the requirements and uses of reflective plastic core insulation in buildings and structures. Reflective plastic core insulation shall comply with the requirements of Section ~~[2613.2] 2614.2~~ and of one of the following: Section ~~[2613.3] 2614.3~~ or ~~[2613.4] 2614.4~~.

~~[2613.2] 2614.2 Identification.~~ Packages and containers of reflective plastic core insulation delivered to the job site shall show the manufacturer's or supplier's name, product identification and information sufficient to determine that the end use will comply with the code requirements.

~~[2613.3]~~ **2614.3 Surface-burning characteristics.** Reflective plastic core insulation shall have a flame spread index of not more than 25 and a smoke-developed index of not more than 450 when tested in accordance with ASTM E 84 or UL 723. The reflective plastic core insulation shall be tested at the maximum thickness intended for use ~~[and shall be tested using one of the mounting methods in Section 2613.3.1 or 2613.3.2].~~ Test specimen preparation and mounting shall be in accordance with ASTM E 2599.

~~[2613.3.1 Mounting of test specimen.~~ The test specimen shall be mounted on 2-inch high (51-mm) metal frames so as to create an air space between the unexposed face of the reflective plastic core insulation and the lid of the test apparatus.]

~~[2613.3.2 Specific testing.~~ A set of specimen preparation and mounting procedures shall be used which are specific to the testing of reflective plastic core insulation.]

~~[2613.4]~~ **2614.4 Room corner test heat release.** Reflective plastic core insulation shall comply with the acceptance criteria of Section 803.1.2.1 of this code when tested in accordance with NFPA 286 or UL 1715 in the manner intended for use and at the maximum thickness intended for use.

§ 27. Chapter 27 of the New York city building code, as amended by local law number 141 for the year 2013, is amended to read as follows:

CHAPTER 27 ELECTRICAL

SECTION BC 2701 GENERAL

2701.1 Scope. This chapter governs the electrical components, equipment and systems used in buildings and structures covered by this code. Electrical components, equipment and systems shall be designed and constructed in accordance with the provisions of the *New York City Electrical Code*.

SECTION BC 2702 EMERGENCY AND STANDBY POWER SYSTEMS

2702.1 Installation. Emergency power systems and standby power systems shall be installed in accordance with the *New York City Electrical Code*, NFPA 110 and NFPA 111.

2702.1.1 Fuel supply. Systems relying on fuel supplies shall have an on-premises fuel supply sufficient for not less than 6-hour full-demand operation of the system. However, natural gas from the public utility street main shall be permitted as the sole fuel supply for (i) emergency power systems serving Group R-2 occupancies ~~[and]~~, (ii) emergency power systems where permitted by Appendix G of this code, and (iii) standby power systems, provided that an outside gas cut-off valve separate from other gas services is installed in accordance with Section E.6 of Appendix E of the *New York City Fuel Gas Code*.

2702.1.2 Stationary generators. Stationary emergency and standby power generators required by this code shall be listed in accordance with UL 2200 ~~[and shall comply with Sections 2702.1.2.1 through 2702.1.2.3].~~

2702.1.2.1 Prohibited location. Emergency and standby power generators shall not be located in the same room as the main or primary electrical service equipment. Distribution associated with emergency and standby power systems shall not pass through the room containing the main or primary electrical service equipment.

2702.1.2.2 Enclosure. Emergency and standby generators within a building shall be located within a dedicated room separated by not less than 2-hour fire barriers constructed in accordance with Section 707 or horizontal assemblies constructed in accordance with Section 712, or both.

2702.1.2.2.1 Generator room contents. Equipment and fuel tanks located within the emergency generator room shall be limited to equipment and fuel tanks associated with the emergency and standby power systems. Piping within the room shall be limited to sprinkler piping.

Exceptions:

1. Uninterrupted conduits not associated with the emergency and standby power system may pass through the emergency generator room.
2. Piping associated with generator cooling systems may be located within the emergency generator room.

2702.1.2.3 Multiple generators. Multiple generators supplying emergency power system loads only, or supplying emergency power system equipment in combination with optional standby power loads as a common system[;] may be located in the same room. Such generators may also share a common room, fuel [supplies] supply and other common equipment and systems.

2702.1.3 Capacity. The emergency and standby power systems shall have capacity and ratings that supply all equipment required to be operational at the same time.

2702.1.4 Protection of fire pumps. Where electrically powered fire pumps are connected to the emergency power system, overcurrent protection and feeder conductors shall be provided in accordance with the *New York City Electrical Code*. Automatic transfer switches shall be located in the same room as the fire pump as an integral part of the pump controller.

2702.1.5 Special inspection. The installation of a required emergency or standby power system shall be subject to special inspection in accordance with Section [~~1704~~] 1705.

2702.1.6 Registration. Fuel-burning equipment for an emergency or standby power system shall be registered with the Department of Environmental Protection in accordance with the requirements of Section 24-109 of the *Administrative Code*.

2702.1.7 Automatic transfer devices and power system feeders. Automatic transfer devices, emergency generators and emergency or standby power system feeders shall comply with Sections 2702.1.7.1 through [~~2707.1.7.2.1~~] 2702.1.7.2.1.

2702.1.7.1 Prohibited location. All automatic transfer devices and ~~[emergency]~~-power system feeders that serve ~~[required]~~ emergency and required standby power system equipment shall not be located in the same room as the emergency power system equipment or the main or primary electrical service equipment. Where emergency and standby transfer devices are installed in accordance with Articles 700 and 701 of the *New York City Electrical Code*, automatic transfer devices for optional standby power systems shall not be installed in the same room.

2702.1.7.2 Enclosure. Any automatic transfer device that is not located at the load shall be located within a dedicated room separated by not less than 2-hour fire barriers constructed in accordance with Section 707 or horizontal assemblies constructed in accordance with Section 712, or both.

2702.1.7.2.1 Automatic transfer device room. Equipment located within the automatic transfer device room shall be limited to equipment associated with the emergency or standby power systems. Piping within the room shall be limited to sprinkler piping.

2702.2 Where required. Emergency and standby power systems shall be provided where required by this section.

2702.2.1 Group A occupancies. Emergency power shall be provided for voice/alarm communication systems in Group A occupancies in accordance with Section ~~[907.5.2.2.4]~~ 907.5.2.2.5.

2702.2.1.1 Prior code buildings. In prior code buildings, where a stationary generator is not otherwise required, the power source for emergency power to the voice/alarm communication system may be served by a gas generator or an uninterruptable power source (UPS) in accordance with the *New York City Electrical Code*.

2702.2.2 Smoke control systems. Standby power shall be provided for smoke control systems in accordance with Section 909.11.

2702.2.3 Exit signs. Emergency power shall be provided for exit signs in accordance with Section ~~[1011.5.3]~~ 1013.6.3.

2702.2.4 Means of egress illumination. Emergency power shall be provided for means of egress illumination in accordance with Section ~~[1006.3]~~ 1008.3.

2702.2.5 Accessible means of egress elevators. Standby power shall be provided for elevators that are part of an accessible means of egress in accordance with Section ~~[1007.4]~~ 1009.4.

2702.2.6 Horizontal sliding doors. Standby power shall be provided for horizontal sliding doors in accordance with Section ~~[1008.1.4.3]~~ 1010.1.4.3.

2702.2.7 Semiconductor fabrication facilities. Emergency power shall be provided for semiconductor fabrication facilities in accordance with Section ~~[415.8.10]~~ 415.11.10.

2702.2.8 Membrane structures. Standby power shall be provided for auxiliary inflation systems in accordance with Section 3102.8.2. Emergency power shall be provided for exit signs in tents and membrane structures.

2702.2.9 Hazardous materials. Emergency or standby power shall be provided in occupancies with hazardous materials in accordance with [~~Section 414.5.4 and~~] the *New York City Fire Code* and Section 414.5.2 of this code.

2702.2.10 Highly toxic and toxic materials. Emergency power shall be provided for occupancies with highly toxic or toxic materials in accordance with the *New York City Fire Code*.

2702.2.11 Organic peroxides. Standby power shall be provided for occupancies with organic peroxides in accordance with the *New York City Fire Code*.

2702.2.12 Pyrophoric materials. Emergency power shall be provided for occupancies with silane gas in accordance with the *New York City Fire Code*.

2702.2.13 Covered and open mall buildings. [~~Standby~~] Emergency power shall be provided for voice/alarm communication systems in covered and open mall buildings in accordance with Section [~~402.14~~] 402.7.4.

2702.2.14 High-rise buildings. Emergency and standby power shall be provided in high-rise buildings in accordance with [~~Sections 403.4.7 and~~] Section 403.4.8.

2702.2.15 Underground buildings. Emergency and standby power shall be provided in underground buildings in accordance with [~~Sections~~] Section 405.8[~~and 405.9~~].

2702.2.16 Group I-3 occupancies. Emergency power shall be provided for doors in Group I-3 occupancies in accordance with Section 408.4.2.

2702.2.17 Elevators. Standby power for elevators, including elevators provided to accommodate ambulance stretchers pursuant to Section 3002.4, shall be provided as set forth in Section 3003.1. [~~Controls, elevator cab light, ventilation and associated equipment required for elevator operation shall be connected to emergency power.~~]

2702.2.18 Airport traffic control towers. Standby power shall be provided in airport traffic control towers in accordance with Section [~~412.3.5~~] 412.3.9.

2702.2.19 Smokeproof enclosures and pressurized elevator [~~shaft~~] shafts. Standby power shall be provided for smokeproof enclosures as required by Section 909.20.6.2 and for pressurized elevator shafts provided in accordance with Section [~~708.14.2.5~~] 3006.1.

2702.2.20 Occupancy Groups B, E and R-1. Emergency and standby power shall be required [~~in~~] throughout those Group B, E and R-1 occupancies specified in this section:

1. Group B occupancies with occupied floor less than 75 feet (22 860 mm) above the lowest level of fire department vehicle access having a gross floor area over 15,000 square feet (1393.6 m²) [~~per~~] on each floor, or having a total gross floor area of 100,000 square feet (9290.3 m²) or more.

2. Group E occupancies with occupied floor less than 75 feet (22 860 mm) above the lowest level of fire department vehicle access having a gross floor area over 15,000 square feet (1393.6 m²) [~~per~~] on each floor, or having a total gross floor area of 100,000 square feet (9290.3 m²) or more.

3. All Group R-1 occupancies.

2702.2.20.1 Equipment requiring emergency power system. With respect to such Occupancy Groups B, E and R- 1, the following equipment, where such equipment is required by this code, shall be provided with an emergency power system:

1. Exit signs and means of egress illumination required by Chapter 10;
2. Elevator car lighting;
3. Emergency voice/alarm communications systems, including Fire Department in-building Auxiliary Radio Communication systems (ARCs) provided where required or installed voluntarily in accordance with Section [~~917~~] 916;
4. Automatic fire detection systems;
5. Fire alarm systems; and
6. Electrically powered fire pumps, including manual fire pumps, automatic fire pumps and sprinkler booster pumps.

2702.2.20.2 Equipment requiring standby power system. With respect to such Occupancy Groups B, E and R-1, the following equipment, where such equipment is required by this code, shall be provided with a standby power system:

1. Ventilating systems used for smoke venting or control;
2. Stair pressurization; [~~and~~]
3. At least three elevators in a building at one time with manual transfer to other elevators as required by Section 3003[~~-~~]; and
4. Power and lighting for the fire command center required by Section [~~403.4.5~~] 403.4.6.

2702.2.21 Continuously operating HVAC systems. Standby power systems shall be provided for fans or fan systems being designed in accordance with Section 607.5 of the *New York City Mechanical Code* and Section 717 of this code.

2702.2.22 Gas detection systems. Emergency power systems shall be provided for gas detection systems in accordance with Section 918.5.

2702.3 Maintenance. Emergency and standby power systems shall be maintained and tested in accordance with the *New York City Fire Code* and *New York City Electrical Code*.

2702.4 Required loads for optional standby power systems. In addition to any other loads, optional standby power systems shall be capable of providing power to the following ~~[systems]~~ standby and emergency power loads upon failure of the normal power supply ~~[or the emergency or standby power system]~~:

1. Emergency lighting;
2. Fire alarm systems; and
3. Elevators as follows:

~~[3.1]~~ 3.1. For Group R-2 occupancies in buildings greater than 125 feet (38 100 mm) in height, at least one elevator serving all floors, or one elevator per bank where different banks serve different portions of the building; or

~~[3.2]~~ 3.2. For all other buildings having occupied floors located more than 75 feet (22 860 mm) above the lowest level of fire department vehicle access, at least one elevator that serves all floors.

Exception: Backup power systems that provide backup power for non-accessory public telecommunications equipment, such as rooftop telecommunications antennas, cooling equipment, routers, etc., need not provide power to the standby and emergency power loads listed in this section.

2702.4.1 Additional optional standby power systems. Where a functioning emergency power system or required standby power system is in place and provides power to all required emergency or required standby power loads, any additional optional standby power system need not supply power to such emergency or required standby power loads.

2702.4.2 Compliance with NFPA 110 and UL 2200. Where an optional standby power system is required to supply emergency or required standby power loads, such power system shall comply with the UL 2200 listing and NFPA 110.

2702.4.3 Special inspection. Where an optional standby power system is required to supply emergency or required standby power loads, such power system shall be subject to special inspection in accordance with Section 1704.31 and the rules of the department.

§ 28. Chapter 29 of the New York city building code, as amended by local law number 141 for the year 2013, is amended to read as follows:

**CHAPTER 29
PLUMBING SYSTEMS**

**SECTION BC 2901
GENERAL**

2901.1 Scope. The *New York City Plumbing Code* shall govern the construction, erection, installation, alteration, repairs, relocation, replacement, addition to, use or maintenance of plumbing equipment and systems. Toilet and bathing rooms shall be constructed in accordance with Section 1210.

§ 29. Chapter 30 of the New York city building code, as added by local law number 33 for the year 2007, item 12 of section 3001.10 as amended by local law number 8 for the year 2008, sections 3003.1.1, 3003.1.2, 3003.1.3 and 3003.1.4 as amended by local law number 111 for the year 2013, sections 3001.11, 3002.8, 3007 and 3008 as added by, sections 3001.2, 3001.3, 3001.6, 3001.9, 3002.1, 3002.3, 3002.4, 3002.6, 3002.7, 3003.1, 3003.3.1, 3003.3.2, 3004, 3005.2.1, 3005.3.1 and 3006.4 as amended by, and sections 3009, 3010, 3011, 3012, 3013 and 3014 as renumbered and amended by local law number 141 for the year 2013, and section 3002.4.1 as amended by local law number 51 for the year 2014, is amended to read as follows:

**CHAPTER 30
ELEVATORS AND CONVEYING SYSTEMS**

**SECTION BC 3001
GENERAL**

3001.1 Scope. This chapter establishes the minimum safety requirements for and governs the design, construction, installation, alteration, maintenance, inspection, test and operation of elevators, dumbwaiters, escalators, moving walks, industrial lifts and loading ramps, mechanical parking equipment, console or stage lifts, power-operated scaffolds, amusement devices, platform lifts, and special hoisting and conveying equipment. This chapter and all the provisions of this code for new installations shall also apply to elevators in existing buildings moved to new hoistways. High-rise building elevators shall also conform to the provisions of Section 403 of this code.

Exception: Personnel and material hoists used for construction operations subject to the requirements of Chapter 33.

3001.2 Reference standards. Except as otherwise provided for in this code, the design, construction, installation, alteration, repair and maintenance of elevators and ~~other~~ conveying systems and their components shall conform to ASME A17.1/CSA B44 as modified by Appendix K, Chapter K1, ASME A17.2, ASME A17.3 as modified by Appendix K, Chapter K3, ASME A17.5, ASME A17.6, ASME A17.7/CSA B44.7, ASME A18.1, [~~ASME A17.3 as modified by Appendix K, Chapter K3, ASME A17.5, ~~ASME A17.1S as modified by Appendix K, Chapter K4,~~] ASME A90.1, ASME B20.1 as modified by Appendix K, Chapter K2, [~~ALI-ALCTV, and~~] ANSI A10.4, ANSI E1.46, BSR 1.42,~~

ANSI/ICC A117.1, and ASCE 24 for construction in [~~areas of special~~] flood hazard[;] areas established in Appendix G. Where this code makes reference to the nationally recognized standards ASME A17.1/CSA B44, ASME A17.3, and ASME B20.1, such standard(s) shall be as modified for New York City in accordance with Appendix K of this code.

3001.3 Accessibility. The following elevators and lifts shall conform to ICC A117.1:

1. Passenger elevators, including destination-oriented elevators, required to be accessible by Chapter 11;
2. Limited-Use/Limited-Application (LULA) elevators permitted to be installed on an accessible route pursuant to Section 1109.6.1;
3. Platform lifts permitted to be installed on an accessible route pursuant to Section 1109.7;~~[and]~~
4. Private residence elevators serving within an individual dwelling unit in Occupancy Groups R-2 and R-3 occupancies on an accessible route[-]; and
5. Elevators provided in accordance with Sections 3002.4.3.2 and 3002.4.3.3.

3001.4 Change in use. A change in use of an elevator from freight to passenger, passenger to freight, or from one freight class to another freight class shall comply with Section 8.7 of ASME A17.1/CSA B44.

3001.5 Piping or ductwork. No piping or ductwork [~~of any kind~~], except as permitted by ASME A17.1/CSA B44, Section 2.8, shall be permitted within hoistway or elevator enclosures except:

1. As required for the elevator installation; and
2. Low-voltage wiring less than 50 volts required for fire alarm systems required by this code.

3001.6 Elevator mirrors. A mirror shall be installed in each self-service passenger elevator in multiple dwellings. Such mirror shall be affixed and maintained in a manner sufficient to enable persons entering such elevator to view the inside thereof prior to entry to determine whether any person is in the elevator.

3001.7 Car switch operation. Elevators with car switch operation (manual operation) shall be provided with a signal system by means of which signals can be given from any landing whenever the elevator is desired at that landing.

3001.8 Prohibited devices. The following devices shall be prohibited:

3001.8.1 Manlifts. The installation of manlifts is prohibited.

3001.8.2 Sidewalk elevators. The installation of sidewalk elevators located outside the street line is prohibited.

3001.9 Approved equipment. All equipment listed in ASME A17.1[-]/CSA B44, Section 8.3 as modified by New York City Building Code, Appendix K, Chapter K1, shall be ~~approved by~~ listed by an approved agency in accordance with Section 28-113.2.3 of the *Administrative Code*, Section 8.3.1 of ASME A17.1/CSA B44, and the rules of the department, and shall be approved by the commissioner.

3001.10 Construction documents. Applications for elevator, escalator, moving walkway and stairway, dumbwaiter, and similar equipment shall contain construction documents that include the following:

1. The location of all machinery, switchboards, junction boxes, and reaction points, with loads indicated;
2. The details of all hoistway conditions including bracket spacing;
3. The estimated maximum vertical forces on the guide rails on application of the safety device;
4. In the case of freight elevators for Class B or C loading, the horizontal forces on the guide-rail faces during loading and unloading; and the estimated maximum horizontal forces in a postwise direction on the guide-rail faces on application of the safety device;
5. The size and weight per foot of any rail reinforcements where provided;
6. Compliance with the accessibility features of this code;
7. The details of capability of the withstanding forces (impact) on door entrance assembly and retaining devices;
8. The withstanding hourly fire rating of the hoistway and the hoistway door assembly;
9. The impact loads imposed on machinery and sheave beams, supports and floors or foundations;
10. The impact load on buffer supports due to buffer engagement at the maximum permissible speed and load;
11. Where compensation tie down is applied, the load on the compensation tie down supports; and
12. The total static and dynamic loads from the governor, buffer and tension system.

3001.11 Special provisions for prior code buildings. Prior code buildings shall be permitted to comply with Section 3001.11.1.

3001.11.1 Existing shafts. Elevator cabs installed in existing shafts shall be permitted to be smaller than that required by this chapter where necessary to fit in the existing shaft~~[, unless a larger cab size is otherwise mandated pursuant to Section 1101.3].~~

Exception: An existing elevator shaft shall be enlarged or a new elevator shaft shall be constructed to accommodate an elevator cab in compliance with Chapter 11 where the entire building is required to be accessible pursuant to either Item 1 of Section 1101.3.1, or Section 1101.3.2.

SECTION BC 3002 HOISTWAY ENCLOSURES

3002.1 Hoistway enclosure protection. Elevator, dumbwaiter and other hoistway enclosures shall be shaft enclosures complying with Section [708] 713.

3002.1.1 Definitions. The following terms are defined in Chapter 2:

HOISTWAY.

ZERO CLEARANCE VESTIBULE.

~~[3002.1.1]~~ **3002.1.2 Opening protectives.** Openings in hoistway enclosures shall be protected as required in Chapter 7.

Exception: The elevator car doors and the associated hoistway enclosure doors at the floor level designated for recall in accordance with Section 3003.2 shall be permitted to remain open during Phase I Emergency Recall Operation in accordance with ASME A17.1/CSA B44, as modified by Appendix K, Chapter K1.

~~[3002.1.2]~~ **3002.1.3 Hardware.** Hardware on opening protectives shall be of an approved type installed as tested, except that approved interlocks, mechanical locks and electric contacts, door and gate electric contacts and door-operating mechanisms shall be exempt from the fire test requirements.

3002.2 Number of elevator cars in a hoistway.

1. Where four or more elevator cars serve all or the same portion of a building, the elevators shall be located in ~~[at least]~~ not fewer than two separate hoistways. ~~[Not]~~
2. Where five or more elevators serve the same portion of a building, not more than four elevator cars shall be located in any single hoistway enclosure.
3. Elevators that service different ~~[risers]~~ risers shall be located in separate hoistways.

3002.3 Emergency signs. A sign shall be posted and maintained on every floor at the elevator landing. The sign shall read “IN FIRE EMERGENCY, DO NOT USE ELEVATOR. USE THE EXIT STAIRS.” The lettering shall be at least ½ inch (13 mm) block letters in red with white background or as otherwise approved by the commissioner. Such lettering shall be properly spaced to provide good legibility. The sign shall also contain a diagram showing the location where it is posted and the location and letter identification of the stairs on the floor. The sign shall be at least 10 inches by 12 inches (255 mm by 305 mm), located directly above a call button and securely attached to the wall or partition. The top of such sign shall not be ~~[above]~~ more than 6 feet (1829 mm) ~~[from]~~ above the floor level. The diagram on such sign may be omitted provided that signs containing such diagram are

posted in conspicuous places on the respective floor. In such case, the sign at the elevator landing shall be at least 2½ inches by 10 inches (64 mm by 254 mm) and the diagram signs shall be at least 8 inches by 12 inches (203 mm by 305 mm).

3002.3.1 Stair and elevator identification signs. Each stair and each bank of elevators shall be identified by an alphabetic letter. A sign indicating the letter of identification for the elevator bank shall be posted and maintained at each elevator landing directly above or as part of the sign specified in Section 3002.3. The stair identification sign shall be posted and maintained on the occupancy side of the stair door. The letter on the sign shall be at least 3 inches (76 mm) high, of bold type and of contrasting color from the background. Such signs shall be securely attached.

Exceptions:

1. The emergency sign shall not be required for elevators that are part of an accessible means of egress complying with Section ~~[4007.4]~~ 1009.4.
2. The emergency sign shall not be required for elevators that are used for occupant self-evacuation in accordance with Section 3008.

3002.4 Elevator required. In buildings five stories in height or more and buildings with four or more stories below grade plane, at least one elevator shall provide access to all floors.

3002.4.1 Standby power required for elevators. Standby power shall be provided to elevators in the following categories:

1. Elevator(s) in high-rise buildings covered by Section 403.1, other than Group R-2 occupancies, as required by Section ~~[403.4.8.1]~~ 403.4.8.4.1;
2. Elevator(s) in high-rise buildings in Group R-2 occupancies more than 125 feet (38 100 mm) in height, as required by Section ~~[403.4.8.2]~~ 403.4.8.4.2;
3. Elevator(s) in underground buildings, as required by Section ~~[405.4.3]~~ 405.8;
4. Elevator(s) in Groups B, E, and R-1 occupancies that are subject to Section 2702.2.20; and
5. Elevator(s) serving as accessible means of egress pursuant to Section ~~[4007.4]~~ 1009.4.

3002.4.2 Elevator car to accommodate ambulance stretcher. Where elevators are provided in buildings five or more stories above, or four or more stories ~~[in height or more,]~~ below grade plane, or underground buildings as described in Section 405.1, ~~[at least]~~ not fewer than one elevator subject to Section 3003.3 shall be provided with an elevator car of such a size and arrangement to accommodate an ambulance stretcher ~~[24 inches]~~ 24 inches by 84 inches (610 mm by 2134 mm), with not less than ~~[5 inch]~~ 5 inch (127 mm) radius corners, in the horizontal, open position and shall be identified by the international symbol for emergency medical services (star of life). The symbol shall ~~[not]~~ be not less than 3 inches (76 mm) ~~[high]~~ in height and shall be placed on both jambs of the hoistway entrances on each floor. Standby power shall be required for such an elevator if it serves a building subject to Section 3002.4.1.

Exceptions:

1. An elevator serving not more than one individual dwelling unit in a building[~~regardless of height and number of stories of such a building~~] pursuant to Section 3002.4.3.1 or 3002.4.3.2.
2. Limited-Use/Limited-Application (LULA) elevators (25 feet maximum rise).

3002.4.3 Elevator serving individual dwelling unit. Elevators provided in individual dwelling units in buildings in Occupancy Groups R-2 and R-3 shall comply with Section 3002.4.3.1 through 3002.4.3.3, as applicable.

3002.4.3.1 Maximum rise of 60 feet (18 288 mm). A private residence elevator with 60 feet (18 288 mm) of maximum rise shall be permitted to serve within an individual dwelling unit provided the elevator car is in compliance with ASME A17.1/CSA B44, and Section 3001.3 of this code.

3002.4.3.2 Rise of over 60 feet (18 288 mm) but not more than 75 feet (22 860 mm). An elevator with 60 feet (18 288 mm) but not more than 75 feet (22 860 mm) of maximum rise shall be permitted to serve within an individual dwelling unit provided the elevator car is in compliance with Parts 2 or 3 of ASME A17.1/CSA B44 and Section 3001.3 of this code even if it does not serve on an accessible route within the dwelling unit.

3002.4.3.3 Maximum rise of more than 75 feet (22 860 mm). A passenger elevator shall be required to serve within an individual dwelling unit where the maximum rise is over 75 feet (22 860 mm). Such elevator shall comply with ASME A17.1/CSA B44, and Sections 3001.3 and 3002.4.2 of this code even if it does not serve on an accessible route within the dwelling unit.

3002.5 Emergency doors. Where an elevator is installed in a single blind hoistway or on the outside of a building, there shall be installed in the blind portion of the hoistway or blank face of the building, an emergency door in accordance with ASME A17.1/CSA B44.

3002.6 Prohibited doors[~~].~~ Doors, other than hoistway doors and the elevator car door, shall be prohibited at the point of [~~access to~~] egress from an elevator car unless such doors are readily openable from the car side without a key, tool, special knowledge or effort.

3002.7 Common enclosure with stairway. Elevators shall not be in a common shaft enclosure with a stairway.

Exception: [~~Open~~] Elevators within open parking garages need not be separated from stairway enclosures.

3002.8 Glass in elevator enclosures. Glass in elevator enclosures shall comply with [~~Section 2409.1 and~~] ASME A17.1/CSA B44 and Section 2409.2 of this code.

3002.9 Plumbing and mechanical systems. Plumbing and mechanical systems shall not be located in an elevator hoistway enclosure.

Exceptions:

1. Floor drains, sumps and sump pumps shall be permitted at the base of the hoistway enclosure provided they are indirectly connected to the plumbing system.
2. Sprinklers shall be permitted when otherwise required.

**SECTION BC 3003
[ELEVATOR] EMERGENCY OPERATIONS**

3003.1 Standby power. In buildings and structures where standby power is required or furnished to operate an elevator, the operation shall be in accordance with Sections 3002.4.1 and 3003.1.1 through 3003.1.4.

3003.1.1 Manual transfer. Standby power shall be manually transferable to all elevators in each bank.

3003.1.2 One elevator. Where only one elevator is installed, the elevator shall automatically transfer to standby power within 60 seconds after failure of normal power.

3003.1.3 Two or more elevators. Where two or more elevators are controlled by a common operating system, all elevators shall automatically transfer to standby power within 60 seconds after failure of normal power where the standby power source is of sufficient capacity to operate all elevators at the same time. Where the standby power source is not of sufficient capacity to operate all elevators at the same time, all elevators shall transfer to standby power in sequence, return to the designated landing and disconnect from the standby power source. ~~[After all elevators have been returned to the designated level, at least three elevators shall remain operable from the standby power source.]~~ For buildings with multiple banks of elevators, at least one elevator from each bank shall remain operable from the standby power source.

3003.1.4 Venting. Where standby power is connected to elevators, the machine room ventilation or air conditioning shall be connected to the standby power source.

3003.2 Fire-fighters' emergency operation. Elevators shall be provided with Phase I emergency recall operation and Phase II emergency in-car operation ~~[in accordance with]~~ where required by ASME A17.1/CSA B44 as modified by Appendix K.

3003.3 Elevator in readiness. Requirements for elevator in readiness shall be as defined in Sections 3003.3.1 through 3003.3.2.

3003.3.1 Elevator in readiness for Fire Department emergency access[.]. Except as provided in Section 3003.3.2, in buildings five stories in height or more, underground buildings as described in Section 405.1, and high-rise buildings, ~~[all floors shall be served by at least one elevator that]~~ at least one elevator shall be kept available for immediate use by the Fire Department during all hours of the night and day, including holidays, Saturdays and Sundays. The elevator in readiness shall serve all floors of the building. For buildings where a Fire Service Access Elevator (FSAE) is provided, the FSAE shall serve all floors of the building. There shall be available at all times a person competent to operate the elevator. However, an attendant shall

not be required for buildings with occupied floors of 150 feet (45 720 mm) or less above the lowest level of the Fire Department vehicle access that have elevators with automatic or continuous pressure operation with keyed switches meeting the requirements of ASME A17.1/CSA B44 as modified by Appendix K so as to permit sole use of the elevators by the Fire Department.

3003.3.2 Number of elevators. A number of elevators shall be kept available at every floor for the sole use of the Fire Department as required by Sections 3003.3.2.1 and 3003.3.2.2. This requirement shall apply to the following types of buildings:

1. High-rise buildings with occupancies classified in Groups A, B, E, I, F, H, M and S;
2. Buildings with Group B occupancies with a gross area of 200,000 square feet (18 581 m²); and
3. Buildings with a main use or dominant occupancy in Group R-1 or R-2.

Exception: In buildings that are five stories or more in height but are not one of the types of buildings described in Items 1 through 3 in Section 3003.3.2, at least one elevator car in such buildings shall be kept available for sole use by the Fire Department.

3003.3.2.1 Three or fewer elevators. Where a floor is serviced by three or fewer elevator cars, every car shall be kept available for sole use by the Fire Department.

3003.3.2.2 More than three elevators. Where a floor is serviced by more than three elevator cars, at least three elevator cars with a total rated load capacity of not less than 6,000 pounds (2722 kg) shall be kept available for the sole use of the Fire Department. Such cars shall include not more than two cars that service all floors and at least one other car in another bank servicing that floor. If the total load capacity of all cars servicing the floor is less than 6,000 pounds (2722 kg), all such cars shall be kept available for sole use of the Fire Department.

3003.3.3 Operation and control. Elevators that are kept for the sole use of the Fire Department and that have automatic or continuous pressure operation shall be controlled by keyed switches meeting the requirements of ASME [47.1] A17.1/CSA B44.

3003.3.4 Other elevator cars. In high-rise buildings classified in Occupancy Groups A, B, E, F, H, I, M and S, in low-rise buildings classified in Occupancy Group B with a gross area of 200,000 square feet (18581 m²) or more and in buildings classified in Occupancy Group R-1 or R-2, all other automatically operated cars shall have manual operation capability.

**[SECTION BC 3004]
[HOISTWAY VENTING]**

[3004.1 Reserved.]

[3004.2 Reserved.]

[3004.3 Reserved.]

~~[3004.4 Plumbing and mechanical systems. Plumbing and mechanical systems shall not be located in an elevator shaft.]~~

~~[Exception: Floor drains sumps and sump pumps shall be permitted at the base of the shaft provided they are indirectly connected to the plumbing system.]~~

~~[3004.5 Control of smoke and hot gases. Hoistways of elevators shall be provided with any one of the following means to prevent the accumulation of smoke and hot gases in case of fire in accordance with Sections 3004.5.1 through 3004.5.4.]~~

~~[3004.5.1 Vents in the hoistway enclosures. Hoistway enclosures may be vented in accordance with the following:]~~

~~[1. Location of vents.]~~

~~[1.1. The vents in the side of the hoistway enclosure below the elevator machine room floor or in the roof of the hoistway shall open either directly to the outer air or through noncombustible ducts to the outer air.]~~

~~[1.2. The vents in the wall or roof of an overhead elevator machine room through the smoke hole in the top of the elevator hoistway shall be vented to the outer air through noncombustible ducts.]~~

~~[2. Area of vents. The area of vents in the hoistway or the elevator machine room and the smoke hole shall be not less than 3½ percent of the area of the hoistway nor less than 3 square feet (0.28 m²) for each elevator car, whichever is greater. Such vents shall comply with the following requirements:]~~

~~[2.1. Open vents. Of the total required vent area, not less than one third shall be permanently open or equipped with an openable hinged damper. The smoke hole shall be permanently open.]~~

~~[2.2. Closed vents. The two thirds closed portion of the required vent area either in the hoistway enclosure or in the elevator machine room may consist of windows or skylights glazed with annealed glass not more than 1/8 inch (3.2 mm) thick. A closed damper that opens upon the activation of a smoke detector placed at the top of the hoistway shall be considered closed.]~~

~~[Exception: The total required open vent area shall not be required to be permanently open where all of the vent openings automatically open upon detection of smoke in the elevator lobbies or hoistway, upon power failure (except when provided with a code compliant standby power supply from an approved standby power source) or upon activation of a manual override control. The manual override control shall be capable of opening and closing the vents and shall be located in an approved location.]~~

~~[3004.5.2 Mechanical ventilation of the hoistway enclosure. Hoistway enclosures may be mechanically vented. The system of mechanical ventilation shall be of sufficient capacity to exhaust at least 12 air changes per hour of the volume of such hoistways through a roof or an~~

approved location on an exterior wall other than the lot line wall. Such system shall comply with the following requirements:]

- [1. ~~The smoke detector shall be placed at the top of the hoistway and shall activate the mechanical ventilation system.~~]
- [2. ~~Such mechanical ventilation system shall not pass through the overnight sleeping areas of a hotel, multiple dwelling, hospital or similar buildings.~~]
- [3. ~~Such mechanical ventilation system shall be equipped with a manual shut off in or near the elevator control panel at the designated level.~~]

~~[3004.5.3 Air pressurization of hoistway enclosure. Hoistways may be air pressurized. Where such system is utilized, the air shall not cause erratic operation of the landing or car door equipment, traveling cables, selector tapes, governor ropes, compensating ropes, or any other components sensitive to excess movement or deflection.]~~

~~[3004.5.4 Alternate means. The commissioner may accept alternate means to prevent the accumulation of smoke and hot gases in the hoistways and machine rooms in case of fire.]~~

SECTION BC ~~[3005]~~ 3004 CONVEYING SYSTEMS

~~[3005.1] 3004.1 General. [~~Conveying systems~~] Escalators, moving walks, conveyors, and amusement devices shall comply with the provisions of [~~this section~~] Sections 3004.2 through 3004.5 as applicable.~~

~~[3005.2] 3004.2 Escalators and moving walks. Escalators and moving walks shall be constructed of approved noncombustible and fire-retardant materials. This requirement shall not apply to electrical equipment, wiring, wheels, handrails and the use of $\frac{1}{28}$ -inch (0.9 mm) wood veneers on balustrades backed up with noncombustible materials.~~

~~[3005.2.1] 3004.2.1 Enclosure. Escalator floor openings shall be enclosed with shaft enclosures complying with Section [~~708.~~] 713.~~

~~[3005.2.2] 3004.2.2 Escalators. Where provided in below-grade transportation stations, escalators shall have a clear width of not less than 32 inches [~~(813 mm) minimum~~] (813 mm).~~

Exception: The clear width is not required in existing facilities undergoing alterations.

~~[3005.3] 3004.3 Conveyors. Conveyors and [~~related equipment~~] conveying systems shall comply with ASME B20.1.~~

~~[3005.3.1] 3004.3.1 Enclosure. Conveyors and related equipment connecting successive floors or levels shall be enclosed with shaft enclosures complying with [~~the requirements of Section 708~~] Section 713.~~

~~[3005.3.2]~~ **3004.3.2 Conveyor safeties.** Power-operated conveyors, belts~~[,]~~ and other material-moving devices shall be equipped with automatic limit switches~~[, which]~~ that will shut off the power in an emergency and automatically stop all operation of the device.

~~[3005.4]~~ **3004.4 Reserved.**

~~[3005.5]~~ **3004.5 Amusement devices.** Amusement devices shall ~~[also]~~ comply with rules of the department.

SECTION BC ~~[3006]~~ 3005
MACHINERY SPACES, MACHINE ROOMS, CONTROL SPACES
AND CONTROL ROOMS

~~[3006.1]~~ **3005.1 Access.** An approved means of access shall be provided to elevator machine rooms ~~[and overhead machinery]~~, control rooms, control spaces and machinery spaces.

~~[3006.2 Venting.]~~ **3005.2 Temperature control.** Elevator machine rooms, machinery spaces that contain ~~[solid state equipment]~~ the driving machine, and control rooms or spaces that contain the operation or motion controller for elevator operation shall be provided with an independent ventilation or air-conditioning system to protect against the overheating of the electrical equipment. The system shall be capable of maintaining temperatures within the range established for the elevator equipment.

~~[3006.3]~~ **3005.3 Pressurization.** The elevator machine room ~~[serving]~~, control rooms or control space with openings into a pressurized elevator hoistway shall be pressurized upon activation of a heat or smoke detector located in the elevator machine room, control room or control space.

~~[3006.4]~~ **3005.4 Machine rooms ~~[and]~~, control rooms, machinery spaces, and control spaces.** Elevator machine rooms, control rooms, control spaces and machinery spaces shall be enclosed with fire barriers constructed in accordance with Section 707 or horizontal assemblies constructed in accordance with Section ~~[712]~~ 711, or both. The fire-resistance rating shall be not ~~[be]~~ less than the required rating of the hoistway enclosure served by the machinery. Openings in the fire barriers shall be protected with assemblies having a ~~[fire protection]~~ fire protection rating not less than that required for the hoistway enclosure doors.

Exception: ~~[Where]~~ For other than fire service access elevators and occupant evacuation elevators, where machine rooms ~~[and]~~, machinery spaces, control rooms and control spaces do not abut and have no openings to the hoistway enclosure they serve, the fire barriers constructed in accordance with Section 707 or horizontal assemblies constructed in accordance with Section ~~[712]~~ 711, or both, shall be permitted to be reduced to a 2-hour fire-resistance rating.

~~[3006.5 Sprinklers prohibited. Sprinklers are not permitted in elevator machine rooms.]~~ **3005.5 Sprinklers and shunt trip.** Sprinklers are not permitted in elevator machine rooms, machine spaces, control rooms and control spaces. Where elevator hoistways are protected with automatic sprinklers, a means installed in accordance with Section 21.4 of NFPA 72 as modified by Appendix Q shall be provided, where required, to disconnect automatically the main line power supply to the affected elevator prior to the application of water. This means shall not be self-resetting. The activation of

automatic sprinklers outside the hoistway, machine room, machinery space, control room or control space shall not disconnect the main line power supply.

[3006.6] 3005.6 Plumbing systems. Plumbing systems not related to elevator machinery shall not be located in elevator equipment rooms.

[3006.7] 3005.7 Elevator machinery noise control in multiple dwellings. Gear-driven machinery, gearless machinery, and motor generators located in an elevator machinery room or shaft on a roof, or on a floor other than a floor on grade, shall be supported on vibration isolator pads having a minimum thickness of ½ inch (12.7 mm).

SECTION BC 3006 **ELEVATOR LOBBIES AND HOISTWAY OPENING PROTECTION**

3006.1 Elevator, dumbwaiter and other hoistways. Elevator, dumbwaiter, and other hoistway enclosures shall be constructed in accordance with Section 713 and Chapter 30.

3006.1.1 Elevator lobby. Except as provided by Sections 403.6.1 and 403.6.2, an enclosed elevator lobby shall be provided in high-rise buildings at the following locations:

1. Elevators opening onto a fire-resistance-rated corridor, in all occupancy groups.
2. Elevators serving Group B occupancies. Elevators that serve four or more stories that contain space classified in occupancy Group B, inclusive of any lobby or entrance level, shall provide elevator lobbies at every level served by such elevator.

The lobby enclosure shall separate the elevator shaft enclosure doors from each floor by smoke partitions. In addition to the requirements in Section 710 for smoke partitions, doors protecting openings in the elevator lobby enclosure walls shall also comply with Section 710.5.2.3 and penetrations of the elevator lobby enclosure by ducts and air transfer openings shall be protected in accordance with Section 710.8. Elevator lobbies shall have at least one means of egress complying with Chapter 10 and other provisions within this code. Access to an exit on any story through an elevator lobby shall be permitted provided that access to at least one other required exit does not require passing through the elevator lobby.

Exceptions:

1. Enclosed elevator lobbies are not required at the street floor, provided the entire street floor is equipped with an automatic sprinkler system in accordance with Section 903.3.1.1.
2. Elevators not required to be located in a shaft in accordance with Section 712 are not required to have enclosed elevator lobbies.
3. Enclosed elevator lobbies are not required where zero-clearance doors are provided at the hoistway opening in accordance with Section 3002.6. Such doors shall be tested in accordance with UL 1784 without an artificial bottom seal.

4. Enclosed elevator lobbies are not required on floors with less than 2,500 square feet (232 m²), provided that the commissioner accepts an alternative design or construction method that accomplishes the purposes of this section, or provided that the commissioner determines that compliance with this section is impracticable in whole or in part, whereby the commissioner may authorize an exemption from the requirements of this section.
5. Enclosed elevator lobbies are not required on Group R-2 occupied floors.
6. Enclosed elevator lobbies are not required where the elevator hoistway is pressurized in accordance with Section 3006.1.2.
7. Enclosed elevator lobbies are not required where the elevator serves only open parking garages in accordance with Section 406.5.

3006.1.1.1 Areas of rescue assistance. Areas of rescue assistance shall be provided as required in Section 1009.6.

3006.1.2 Enclosed elevator lobby. Where elevator hoistway pressurization is provided in lieu of required enclosed elevator lobbies, the pressurization system shall comply with this section except as provided by Sections 403.6.1 and 403.6.2.

3006.1.2.1 Pressurization requirements. Elevator hoistways shall be pressurized to maintain a minimum positive pressure of 0.10 inches of water (25 Pa) and a maximum positive pressure of 0.25 inches of water (67 Pa) with respect to adjacent occupied space on all floors. This pressure shall be measured at the midpoint of each hoistway door, with all elevator cars at the floor of recall and all hoistway doors on the floor of recall open and all other hoistway doors closed. The opening and closing of hoistway doors at each level must be demonstrated during this test. The supply air intake shall be from an outside, uncontaminated source located a minimum distance of 20 feet (6096 mm) from any air exhaust system or outlet.

3006.1.2.2 Rational analysis. A rational analysis complying with Section 909.4 shall be submitted with the construction documents.

3006.1.2.3 Ducts for system. Any duct system that is part of the pressurization system shall be protected with the same fire-resistance rating as required for the elevator shaft enclosure.

3006.1.2.4 Fan system. The fan system provided for the pressurization system shall be as required by this section.

3006.1.2.4.1 Fire resistance. When located within the building, the fan system that provides the pressurization shall be protected with the same fire-resistance rating required for the elevator shaft enclosure.

3006.1.2.4.2 Smoke detection. The fan system shall be equipped with a smoke detector that will automatically shut down the fan system when smoke is detected within the system.

3006.1.2.4.3 Separate systems. A separate fan system shall be used for each elevator hoistway.

3006.1.2.4.4 Fan capacity. The supply fan shall either be adjustable with a capacity of at least 1,000 cfm (0.4719 m³/s) per door, or that specified by a registered design professional to meet the requirements of a designed pressurization system.

3006.1.2.5 Standby power. The pressurization system shall be provided with standby power from the same source as other required emergency systems for the building.

3006.1.2.6 Activation of pressurization system. The elevator pressurization system shall be activated upon activation of the building fire alarm system or upon activation of the elevator lobby smoke detectors. Where both a building fire alarm system and elevator lobby smoke detectors are present, each shall be independently capable of activating the pressurization system.

3006.1.2.7 Special inspection. Special inspection for performance shall be required in accordance with Section 909.18.8. System acceptance shall be in accordance with Section 909.19.

3006.1.2.8 Marking and identification. Detection and control systems shall be marked in accordance with Section 909.14.

3006.1.2.9 Control diagrams. Control diagrams shall be provided in accordance with Section 909.15.

3006.1.2.10 Control panel. A fire-fighter's smoke control panel complying with Section 909.16 shall be provided.

3006.1.2.11 System response time. Hoistway pressurization systems shall comply with the requirements for smoke control system response time in Section 909.17.

SECTION BC 3007 FIRE SERVICE ACCESS ELEVATOR

3007.1 General. Where required by Section 403.6.1, every floor of the building shall be served by a fire service access elevator complying with Sections 3007.1 through 3007.8. Except as modified in this section, the fire service access elevator shall be installed in accordance with this chapter and ~~[rules of the department.]~~ ASME A17.1/CSA B44 as modified by Appendix K, Chapter K1.

3007.2 Automatic sprinkler system. The building shall be equipped throughout ~~[by]~~ with an automatic sprinkler system in accordance with Section 903.3.1.1, except as otherwise permitted by Section 903.3.1.1.1 and as prohibited by Section 3007.2.1.

3007.2.1 Prohibited locations. Automatic sprinklers shall not be installed in elevator machine rooms, machinery spaces, control rooms, control spaces, and elevator hoistways of fire service access elevators.

3007.2.2 Sprinkler system monitoring. The sprinkler system shall have a sprinkler control valve supervisory switch and [~~waterflow~~] water-flow-initiating device provided for each floor that is monitored by the building's fire alarm system.

3007.3 Water protection. An approved method to prevent water from infiltrating into the hoistway enclosure from the operation of the automatic sprinkler system shall be provided:

1. Where an elevator lobby is provided in accordance with Section 3007.6, with respect to the automatic sprinkler system outside of the enclosed elevator lobby.
2. Where a corridor is provided in accordance with Section 3007.6, Exception 2, with respect to the automatic sprinkler system outside of the corridor and with respect to the automatic sprinklers inside the corridor that are beyond 10 feet (3048 mm) of the entrance to the hoistway enclosure of the fire service access elevator .
3. Where neither an enclosed elevator lobby nor a corridor is provided in accordance with Section 3007.6, Exception 3, with respect to the automatic sprinklers that are located beyond 10 feet (3048 mm) of the entrance to the hoistway enclosure of the fire service access elevator.

3007.4 Reserved.

3007.5 Hoistway enclosures. The fire service access elevator hoistway shall be located in a shaft enclosure complying with Section [~~708~~] 713.

3007.5.1 Structural integrity of hoistway enclosures. The fire service access elevator hoistway enclosure shall comply with Sections 403.2.3.1 through 403.2.3.4.

3007.5.2 Hoistway lighting. When [~~firefighters~~²] fire-fighters' emergency operation is active, the entire height of the hoistway shall be illuminated at not less than 1 [~~foot-candle~~] footcandle (11 lux) as measured from the top of the car of each fire service access elevator.

3007.6 Fire service access elevator lobby. The fire service access elevator shall open into a fire service access elevator lobby in accordance with Sections 3007.6.1 through 3007.6.5. Egress is permitted through the elevator lobby in accordance with Item 1 of Section [~~708.14.1~~] 1016.2.

Exceptions:

1. Where a fire service access elevator has two entrances onto a floor, the second entrance shall be permitted to open into an elevator lobby in accordance with Section [~~708.14.1~~] 3006.3.
2. A fire service access elevator lobby shall not be required on stories where the elevator opens to a corridor enclosed with a fire barrier, provided all doors opening onto such corridor are smoke and draft controlled doors complying with Section [~~715.4.3.1~~] 716.5.3.1 with the UL 1784 test conducted without the artificial bottom seal.
3. A fire service access elevator lobby shall not be required on stories that are [~~that are~~] less than 3,000 square feet [~~(914.4 m²)~~] (279 m²) containing only Group R-2 occupancies.

3007.6.1 Reserved.

3007.6.2 Lobby enclosure. The fire service access elevator lobby shall be enclosed with a smoke barrier having a fire-resistance rating of not less than [~~one hour~~] 1 hour, except that lobby doorways shall comply with Section 3007.6.3.

Exception: Enclosed fire service access elevator lobbies are not required at the levels of exit discharge.

3007.6.3 Lobby doorways. Other than doors to the hoistway, elevator control room[~~]~~ or elevator control space, each doorway to a fire service access elevator lobby shall be provided with a $\frac{3}{4}$ -hour fire door assembly complying with Section [~~715.4~~] 716.5. The fire door assembly shall [~~also~~] comply with the smoke and draft control door assembly requirements of Section [~~715.4~~] 716.5.3.1 with the UL 1784 test conducted without the artificial bottom seal.

3007.6.4 Lobby size. The enclosed fire service access elevator lobby shall be not less than 120 square feet (11 m²) in an area with a minimum dimension of 6 feet (1828 mm).

3007.6.5 Fire service access elevator symbol. A pictorial symbol of a standardized design designating which elevators are fire service access elevators shall be installed on each side of the hoistway door frame on the portion of the frame at right angles to the fire service access elevator lobby. The fire service access elevator symbol shall be designed as shown in Figure 3007.6.5 and shall comply with the following:

1. The fire service access elevator symbol shall be not less than 3 inches (76 mm) in height.
2. The helmet shall contrast with the background, with either a light helmet on a dark background or a dark helmet on a light background.
3. The vertical center line of the fire service access elevator symbol shall be centered on the hoistway door frame. Each symbol shall ~~be not~~ [~~be~~] less than 78 inches (1981 mm), and not more than 84 inches (2134 mm) above the finished floor at the threshold.



3 inches (76 mm)

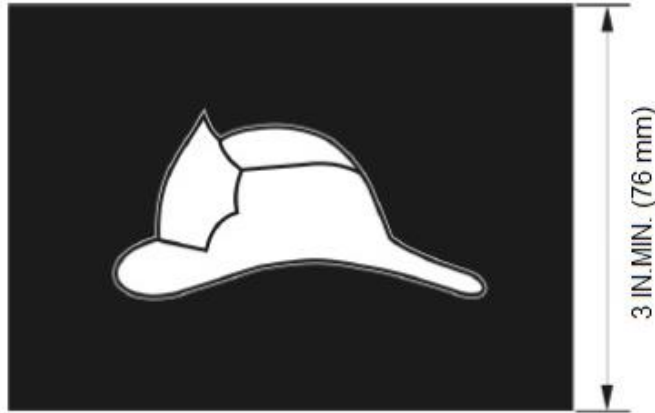

FIGURE 3007.6.5
FIRE SERVICE ACCESS ELEVATOR SYMBOL

3007.7 Elevator system monitoring. The fire service access elevator shall be continuously monitored at the fire command center by a standard emergency service interface system meeting the requirements of NFPA 72 as modified by Appendix Q.

3007.8 Electrical power. The following features serving each fire service access elevator shall be supplied by both normal power and Type 60/Class 6/Level 1 standby power:

1. Elevator equipment.
2. Elevator hoistway lighting.
3. Ventilation and cooling equipment for elevator [~~machine/control~~] machine rooms, control rooms, machine spaces and machinery/control spaces.
4. Elevator car lighting.

Exception: Standby power relying on natural gas as a fuel source need not be Class 6.

3007.8.1 Protection of wiring or cables. Wires or cables that are located outside of the elevator hoistway and machine room and that provide normal or standby power, control signals, communication with the car, lighting, heating, air conditioning, ventilation and fire-detecting systems to fire service access elevators shall be protected by construction having a fire-resistance rating of not less than 2 hours, shall be a circuit integrity cable having a fire-resistance rating of not less than 2 hours[;] or shall be protected by a listed electrical [~~circuit~~] protective system having a fire-resistance rating of not less than 2 hours.

Exception: Wiring and cables to control signals are not required to be protected provided that wiring and cables do not serve Phase II emergency in-car [~~operation~~] operations.

3007.9 Reserved.

SECTION BC 3008 OCCUPANT EVACUATION ELEVATORS

3008.1 General. Where elevators are to be used for occupant self-evacuation during fires, all passenger elevators for general public use shall comply with Sections 3008.1 through ~~[3008.11]~~ 3008.10. Where other elevators are used for occupant self-evacuation, ~~[they]~~ those elevators shall ~~[also]~~ comply with these sections.

3008.1.1 Additional exit stairway. Where an additional means of egress is required in accordance with Section 403.5.2, an additional exit stairway shall not be required to be installed in buildings provided with occupant evacuation elevators complying with Section 3008.1.

3008.1.2 Fire safety and emergency action plans. The building shall have approved fire safety and emergency action plans in accordance with the applicable requirements of the *New York City Fire Code*. The fire safety and emergency action plans shall incorporate specific procedures for the occupants using evacuation elevators.

~~[3008.2]~~ **3008.1.3 Operation.** The occupant evacuation elevators shall be used for occupant self-evacuation in accordance with the occupant evacuation operation requirements [set forth in rules of the department] as per ASME A17.1/CSA B44 as modified by Appendix K of this code and the building's fire safety and emergency action plans.

3008.2 Reserved.

3008.3 Automatic sprinkler system. The building shall be protected throughout by an approved, electrically-supervised automatic sprinkler system in accordance with Section 903.3.1.1, except as otherwise permitted by Section 903.3.1.1.1 and as prohibited by Section 3008.3.1.

3008.3.1 Prohibited locations. Automatic sprinklers shall not be installed in elevator machine rooms, machinery spaces, control rooms, control spaces~~[;]~~ and elevator hoistways of occupant evacuation elevators.

3008.3.2 Sprinkler system monitoring. The sprinkler system shall have a sprinkler control valve supervisory switch and water flow initiating device provided for each floor that is monitored by the building's fire alarm system.

3008.4 Water protection. An approved method to prevent water from infiltrating into the hoistway enclosure from the operation of the automatic sprinkler system outside the enclosed occupant evacuation elevator lobby shall be provided.

3008.5 Reserved.

3008.6 Hoistway enclosure protection. Occupant evacuation elevator hoistways shall be located in shaft enclosures complying with Section ~~[708]~~ 713.

3008.6.1 Structural integrity of hoistway enclosures. Occupant evacuation elevator hoistway enclosures shall comply with Sections 403.2.3.1 through 403.2.3.4.

3008.7 Occupant evacuation elevator lobby. The occupant evacuation elevators shall open into an elevator lobby in accordance with Sections 3008.7.1 through 3008.7.6. Egress is permitted through the elevator lobby in accordance with Item 1 of Section [708.14.1] 1016.2.

3008.7.1 Access to interior exit stairway or ramp. The occupant evacuation elevator lobby shall have direct access from the enclosed elevator lobby to an interior exit stairway or ramp.

Exception: Access to an interior exit stairway or ramp shall be permitted to be through a protected path of travel protected with smoke partitions complying with Section 711. The protected path shall be separated from the enclosed elevator lobby through an opening protected by a smoke and draft control assembly in accordance with Section [711.5.2] 716.5.3.

3008.7.2 Lobby enclosure. The occupant evacuation elevator lobby shall be enclosed with a smoke barrier having a fire-resistance rating of not less than 1 hour, except that lobby doorways shall comply with Section 3008.7.3.

Exception: Enclosed occupant evacuation elevator lobbies are not required at the levels of exit discharge.

3008.7.3 Lobby doorways. Other than doors to the hoistway, and elevator machine rooms, machinery spaces, control rooms, and control spaces within the lobby enclosure smoke barrier, each doorway to an occupant evacuation elevator lobby shall comply with the smoke and draft control assembly requirements of Section [711.5.2] 716.5.3.1 with the UL 1784 test conducted without the artificial bottom seal. Such doorway shall not be required to have a fire-resistance rating.

3008.7.3.1 Vision panel. A vision panel shall be installed in each door assembly protecting the lobby doorway. The vision panel shall consist of glazing and shall be located to furnish clear vision of the occupant evacuation elevator lobby.

3008.7.3.2 Door closing. Each door assembly protecting the lobby doorway shall be automatic closing upon receipt of any fire alarm signal from the emergency voice/alarm communication system serving the building.

3008.7.4 Lobby size. Each occupant evacuation elevator lobby shall have minimum floor area as follows:

1. The occupant evacuation elevator lobby floor area shall accommodate, at 3 square feet (0.28 m²) per person, not less than 25 percent of the occupant load of the floor area served by the lobby.
2. The occupant evacuation elevator lobby floor area [~~also~~] shall accommodate one wheelchair space of 30 inches by 48 inches (760 mm by 1220 mm) for each 50 persons, or portion thereof, of the occupant load of the floor area served by the lobby.

Exception: The size of lobbies serving multiple banks of elevators shall have the minimum floor area approved on an individual basis and shall be consistent with the building's fire safety and emergency action plans.

3008.7.5 Signage. An approved sign indicating elevators are suitable for occupant self-evacuation shall be posted on all floors adjacent to each elevator call station serving occupant evacuation elevators.

3008.7.6 Two-way communication system. A two-way communication system shall be provided in each occupant evacuation elevator lobby for the purpose of initiating communication with the fire command center or an alternate location approved by the Fire Department. The two-way communication system shall be designed and installed in accordance with Sections 1009.8.1 and 1009.8.2.

~~[3008.7.6.1 Design and installation. The two-way communication system shall be designed and installed in accordance with Sections 1007.8.1 and 1007.8.2.]~~

3008.8 Elevator system monitoring. The occupant evacuation elevators shall be continuously monitored at the fire command center or a central control point approved by the Fire Department and arranged to display all of the following information:

1. Floor location of each elevator car.
2. Direction of travel of each elevator car.
3. Status of each elevator car with respect to whether it is occupied.
4. Status of normal power to the elevator equipment, elevator machinery and electrical apparatus cooling equipment where provided, elevator machine room, control room and control space ventilation and cooling equipment.
5. Status of emergency or standby power system that provides backup power to the elevator equipment, elevator machinery and electrical cooling equipment where provided, elevator machine room, control room and control space ventilation and cooling equipment.
6. Activation of any fire alarm initiating device in any elevator lobby, elevator machine room, machine space containing a motor controller or electric driving machine, control space, control room or elevator hoistway.

3008.8.1 Elevator recall. The fire command center or an alternate location approved by the Fire Department shall be provided with the means to manually initiate a Phase I Emergency Recall of the occupant evacuation elevators in accordance with ~~[rules of the department]~~ ASME A17.1/CSA B44 as modified by Appendix K of this code.

3008.9 Electrical power. The following features serving each occupant evacuation elevator shall be supplied by both normal power and Type 60/Class 6/Level 1 standby power:

1. Elevator equipment.
2. Ventilation and cooling equipment for elevator ~~[machine/control]~~ machine rooms, control rooms, [and machinery/control] machinery and control spaces.
3. Elevator car lighting.

Exceptions:

1. Standby power relying on natural gas as a fuel source need not be Class 6.
2. Where Exception 2 of Section 403.5.2 is utilized, the standby power generating equipment need only be sized to satisfy the loads required to simultaneously operate those elevators identified in the timed egress analysis described in Exception 2.2.

3008.9.1 Protection of wiring or cables. Wires or cables that are located outside of the elevator hoistway, machine room, control room and control space and that provide normal or standby power, control signals, communication with the car, lighting, heating, air conditioning, ventilation and fire-detecting systems to ~~[fire service access]~~ occupant evacuation elevators shall be protected by construction having a fire-resistance rating of not less than 2 hours, or shall be circuit integrity cable having a fire-resistance rating of not less than 2 hours, or shall be protected by a listed electrical circuit protective system having a fire-resistance rating of not less than 2 hours.

Exception: Wiring and cables to control signals are not required to be protected provided that wiring and cables do not serve Phase II emergency in-car operation.

3008.10 Emergency voice/alarm communication system. The building shall be provided with an emergency voice/alarm communication system. The emergency voice/alarm communication system shall be accessible to the Fire Department. The system shall be provided in accordance with Section 907.5.2.2.

3008.10.1 Notification appliances. ~~[Nø]~~ Not fewer than one audible and one visible notification appliance shall be installed within each occupant evacuation elevator lobby.

3008.11 Hazardous material areas. No building areas shall contain hazardous materials exceeding the maximum allowable quantities per control area as addressed in Section 414.2.

SECTION BC 3009 SERVICE EQUIPMENT CERTIFICATES

3009.1 Required. No service equipment shall be placed in operation until a service equipment certificate of compliance has been obtained in accordance with the provisions of this code.

3009.2 Posting of inspection certificate. At the time a service equipment Certificate of Compliance is issued, an inspection certificate issued by the commissioner shall be posted. No such inspection certificate shall be issued for elevators that are not subject to periodic inspections pursuant to this code. The inspection certificate shall be in such form as the commissioner shall determine by rule and shall be posted in a frame with a transparent cover in the car of every passenger and freight elevator and on or near every escalator and moving walk and power-operated scaffold.

3009.2.1 Alternate posting locations. In lieu of posting the inspection certificate in those locations specified in this section, the inspection certificate may be kept in the on-site building manager's office. In such case, the building manager's office must be open during normal business hours. In addition, notice must be posted in each location listed in Section 3009.2 and kept in a frame with a transparent cover, or a plaque or on the car operating panel, with an

indelible inscription, stating that the inspection certificate is located in the building manager's office and identifying the location of such office.

3009.3 Temporary use certificates. The commissioner may issue temporary use certificates for any equipment or device regulated by this code, except power-operated scaffolds, provided that such partial use and operation may be made safely and without endangering public health, safety, and welfare and provided further that such temporary use certificate shall not be issued for a period of more than 30 calendar days, subject to renewal for additional 30-day periods at the discretion of the commissioner. Temporary use certificates for elevators shall also be conditioned upon compliance with the following:

1. The class of service to be permitted shall be designated on the temporary use certificate.
2. The hoistway shall be enclosed throughout in an enclosure complying with ASME A17.1/CSA B44 or with a temporary enclosure in accordance with the requirements for workers' elevators (temporary elevators) of the *Industrial Code of the State of New York*, No. 23.

3009.3.1 Posting of temporary use certificate. The temporary use certificate shall be posted in a conspicuous location on, or adjacent to, the device covered by the certificate and shall state that the device has not been finally approved by the commissioner.

SECTION BC 3010 ELEVATOR, AMUSEMENT AND OTHER DEVICE OPERATORS

3010.1 Elevator operators. With the exception of automatic operation elevators, [~~continuous pressure elevators and sidewalk elevators,~~] every passenger and freight elevator with a rise of more than one story shall be in the charge of a designated competent operator, who shall be at least 18 years old and selected with consideration of his or her abilities to perform his or her duties in a careful and competent manner. Such designated competent operator shall be instructed in the safe and proper operation of the equipment.

3010.2 Amusement device operators. Operators of amusement devices shall meet the requirements of rules of the department.

3010.3 Other device operators. Other devices regulated by this code shall, when deemed necessary by the commissioner to protect public safety, be in the charge of a designated competent operator conforming to such qualifications as the commissioner may prescribe, except that operators for workers' hoists shall be assigned as required by the applicable provisions of ANSI A10.4.

3010.4 Sanction for unlawful operation. If the commissioner finds that any person engaged in operating an elevator, amusement, or other device is not competent to operate the elevator, amusement or other device, the owner, agent or lessee of such elevator, amusement, or other device shall, upon notice from the commissioner, discontinue the operation of such device by such operator.

**SECTION BC 3011
ELEVATOR BEING SERVICED, REPAIRED, INSPECTED OR TESTED**

3011.1 Signage. When an existing or new automatic passenger elevator in any building or structure is being serviced, repaired, inspected or tested by an elevator company, or elevator personnel, and there are no elevator personnel available to remain in the elevator car, “CAUTION” sign tapes shall be placed across the car door jamb. One strip of “CAUTION” sign tape shall be placed at a height of 18 inches (457 mm) above the car floor and another strip of “CAUTION” sign tape shall be placed at a height of 54 inches (1372 mm) above the car floor.

3011.1.1 Sign tape. The “CAUTION” sign tape shall be 3 inches (76 mm) in width with the words “CAUTION – DO NOT ENTER” repeated every 6 inches (152 mm). The lettering shall be black on yellow background. The letters shall be at least 2 inches (51 mm) high. Caution tape may be replaced with OSHA approved elevator barricades.

3011.1.2 Elevator out of service. When an elevator is out of service with the car door open at a landing prior to the elevator personnel arriving, Sections 3011.1 and 3011.1.1 shall apply.

**SECTION BC 3012
ACCIDENTS**

3012.1 Accidents. The owner of any device regulated by this chapter shall promptly notify the commissioner of every accident involving injury to any person requiring the services of ~~[a physician]~~ Emergency Medical Service (EMS) or damage to property or to apparatus exceeding \$~~[1,000]~~ 5,000 on, about, or in connection with such equipment, before commencing any repairs and shall afford the commissioner every facility for investigating such accident or damage. The commissioner shall make an investigation immediately thereafter, and shall prepare a full and complete report of such investigation. Such report shall give in detail all material facts and information available and the cause or causes as far as they can be determined. Such report shall be a public record. When an accident involves the failure or destruction of any part of the construction or operating mechanism of such equipment, no such equipment shall be used until it has been made safe, and re-inspected by the commissioner. The commissioner may order the discontinuance of such equipment until a new service equipment certificate has been issued by him or her for its use. No part shall be removed from the premises of the damaged construction or operating mechanism until permission to do so has been granted by the commissioner.

**SECTION BC 3013
EXISTING INSTALLATIONS**

3013.1 General. Existing installations shall be modified in accordance with Appendix K, Chapter K3.

**SECTION BC 3014
INSPECTION AND TESTING**

3014.1 Elevators and conveying systems. Inspection and testing of elevators and conveying systems shall be in accordance with Appendix K, including Table N1. Refer to Chapter 3 of Title 28 of the ~~[Administrative Code]~~ Administrative Code for additional requirements.

3014.2 Amusement devices. Inspection and testing of amusement devices shall comply with rules of the department. Refer to Chapter 3 of Title 28 of the [~~Administrative Code~~] *Administrative Code* for additional requirements. Installation of amusement devices shall be subject to the requirements for special and progress inspections.

§ 30. Chapter 31 of the New York city building code, as amended by local law number 141 for the year 2013, section 3113, as added by local law number 105 for the year 2018, is amended to read as follows:

CHAPTER 31 SPECIAL CONSTRUCTION

SECTION BC 3101 GENERAL

3101.1 Scope. The provisions of this chapter shall govern special building construction including membrane structures, temporary structures, pedestrian walkways and tunnels, automatic vehicular gates, awnings, canopies, sun control devices, marquees, signs, telecommunications towers and antennas, swimming pools and enclosures, sidewalk cafés, and fences.

SECTION BC 3102 MEMBRANE STRUCTURES

3102.1 General. The provisions of [~~this section~~] Sections 3102.1 through 3102.8 shall apply to air-supported structures, air-inflated structures, membrane-covered cable structures, membrane-covered frame structures and tents, and tensile membrane structures, collectively known as membrane structures.

3102.1.1 Certificates of Occupancy. The duration of Certificates of Occupancy for air-inflated structures, air-supported structures, and tents [~~may~~] shall be limited in accordance with the requirements of Chapter 1 of Title 28 of the *Administrative Code*.

3102.1.2 Temporary installations. In addition to the requirements of Section 3102 of this code, temporary installations of air-supported structures, air-inflated structures, membrane-covered cable structures, tensile membrane structures, membrane-covered frame structures and tents, collectively known as membrane structures shall comply with the requirements of Article 111 of Chapter 1 of Title 28 of the [~~Administrative Code~~] *Administrative Code*.

3102.2 Definitions. The following terms [~~shall, for the purposes of this section and as used elsewhere in this code, have the meanings shown herein~~] are defined in Chapter 2:

AIR-INFLATED STRUCTURE. [~~A structure that uses air pressurized membrane beams, arches or other elements to enclose space. Occupants of such a structure do not occupy the pressurized area used to support the structure.~~]

AIR-SUPPORTED STRUCTURE. [~~A building wherein the shape of the structure is attained and maintained by elevated air pressure and occupants of the structure are within the elevated pressure area. Air supported structures are of two basic types:]~~

Double skin. [~~Similar to a single skin, but with an attached liner that is separated from the outer skin and provides an airspace which serves for insulation, acoustic, aesthetic or similar purposes.~~]

Single skin. [~~Where there is only the single outer skin and the air pressure is directly against that skin.~~]

CABLE-RESTRAINED, AIR-SUPPORTED STRUCTURE. [~~A structure in which the uplift is resisted by cables or webbings which are anchored to either foundations or dead men. Reinforcing cable or webbing is attached by various methods to the membrane or is an integral part of the membrane. This is not a cable supported structure.~~]

MEMBRANE-COVERED CABLE STRUCTURE. [~~A nonpressurized structure in which a mast and cable system provides support and tension to the membrane weather barrier and the membrane imparts stability to the structure.~~]

MEMBRANE-COVERED FRAME STRUCTURE. [~~A nonpressurized building wherein the structure is composed of a rigid framework to support a tensioned membrane which provides the weather barrier.~~]

NONCOMBUSTIBLE MEMBRANE STRUCTURE. [~~A membrane structure in which the membrane and all component parts of the structure are noncombustible.~~]

TENSILE MEMBRANE STRUCTURE.

TENT. [~~A nonpressurized membrane structure of a fabric weather barrier supported by poles and guys, in which the fabric weather barrier does not impart stability to the structure. Tents need not be fully enclosed on the sides.~~]

3102.3 Type of construction. Noncombustible membrane structures shall be classified as Type IIB construction. Noncombustible frame or cable-supported structures covered by an approved membrane in accordance with Section 3102.3.1 shall be classified as Type IIB construction. Heavy timber frame-supported structures covered by an approved membrane in accordance with Section 3102.3.1 shall be classified as Type IV construction. Other membrane structures shall be classified as Type V construction.

3102.3.1 Membrane and interior liner material. Membranes and interior liners shall be either noncombustible as set forth in Section [703.4] 703.5, or meet the fire propagation performance criteria of Test Method 1 or Test Method 2, as appropriate, of NFPA 701 and the manufacturer's test protocol.

3102.4 Allowable floor areas. The area of a membrane structure shall not exceed the limitations [~~set forth in Table 503, except as provided~~] specified in Section 506.

3102.5 Maximum height. Membrane structures shall not exceed one story nor shall such structures exceed the height limitations in feet [~~set forth in Table 503~~] specified in Section 504.3. Membrane structures may be erected above the roof of a building provided that such roof is of noncombustible construction required to have a fire-resistance rating.

Exception: Noncombustible membrane structures serving as roofs only.

3102.6 Mixed construction. Membrane structures shall be permitted to be utilized as specified in this section as a portion of buildings of other types of construction. Height and area limits shall be as specified for the type of construction and occupancy of the building.

3102.6.1 Noncombustible membrane. A noncombustible membrane shall be permitted for use as the roof or as a skylight of any building or atrium of a building of any type of construction~~[;]~~ provided ~~[#]~~ such membrane is [at least] not less than 20 feet (6096 mm) above any floor, balcony or gallery, and meets the fire classification requirements of Section 1505 for roof assemblies.

3102.6.1.1 Membrane. A membrane meeting the fire propagation performance criteria of Test Method 1 or Test Method 2, as appropriate, of NFPA 701 shall be permitted to be used as the roof or as a skylight on buildings of Type IIB, III, IV and V construction, provided ~~[#]~~ such membrane is [at least] not less than 20 feet (6096 mm) above any floor, balcony or gallery, and meets the fire classification requirements of Section 1505 for roof assemblies.

3102.7 Engineering design. Membrane structures, except tensile membrane structures, shall be designed and constructed to sustain dead loads; loads due to tension or inflation; live loads including wind, snow or flood and seismic loads and in accordance with Chapter 16 and Appendix G.

3102.7.1 Lateral restraint. For membrane-covered frame structures, the membrane shall not be considered to provide lateral restraint in the calculation of the capacities of the frame members.

~~[Exception:]~~ **3102.7.2 Design.** Tents, air-inflated structures, and air-supported structures shall be designed by either an alternate engineering design approved by the commissioner or as follows:

1. Tents. Tents shall be guyed, supported, and braced to withstand a wind pressure of 10 psf (478.8 Pa) of projected area of the tent. The poles and their supporting guys, stays, stakes, fastenings, etc., shall be of sufficient strength and attached so as to resist wind pressure of 20 psf (957.6 Pa) of projected area of the tent.
2. Air-inflated structures and air-supported structures.
 - 2.1 Air-inflated structures and air-supported structures shall be anchored to the ground or supporting structure by either ballast or positive anchorage, sufficiently and evenly distributed, and adequate to resist the inflation lift load, the aerodynamic lift load, and the drag (shear) load due to wind impact. The latter factors shall be based on a fastest mile wind speed of 70 mph (112.65 km/hr), and an estimated stagnation of not less than 0.5 q for structures on grade whose height is equal to, or less than, the width of the structure. For greater heights, or for elevated structures, increased anchorage shall be provided, justified by analytical and/or experimental data subject to approval by the commissioner.
 - 2.2 The skin of the structure shall be of such strength, and the joints so constructed, as to provide a minimum dead load strip tensile strength at 70°F (21°C) of four times the 70 mph (121.65 km/hr) design load (inflation and aerodynamic loading). The joints shall provide a dead load strip tensile strength of 160°F (71°C) of twice the 70 mph (121.65 km/hr) design load (i.e., a factor of safety of 4 and 2,

respectively). In addition, the material shall provide a trapezoidal tear strength of ~~[at least]~~ not less than 15 percent of the maximum design tensile load. Material and joint strengths shall be so certified by the manufacturer, justified by analytical and/or experimental data.

3102.7.3 Tensile membrane structures. The design and construction shall be in accordance with ASCE 55. The provisions of Sections 3102.1 through 3102.6 shall also apply.

3102.8 Inflation systems. Air-supported structures and air-inflated structures shall be provided with primary and auxiliary inflation systems to meet the minimum requirements of Sections 3102.8.1 through 3102.8.3.

3102.8.1 Equipment requirements. The primary inflation system shall consist of one or more blowers and shall include provisions for automatic control to maintain the required inflation pressures. Such system shall be so designed as to prevent ~~[over pressurization]~~ overpressurization of the system.

3102.8.1.1 Auxiliary inflation system. In addition to the primary inflation system, in structures exceeding 1,500 square feet (140 m²) in area, an auxiliary inflation system shall be provided with sufficient capacity to maintain the inflation of the structure in case of primary system failure. The auxiliary inflation system shall operate automatically when there is a loss of internal pressure and when the primary blower system becomes inoperative. Initiation of auxiliary inflation system shall be indicated by an audible and visual alert at the entrance or a regularly attended location.

3102.8.1.2 Blower equipment. Blower equipment shall meet all of the following requirements:

1. Blowers shall be powered by continuous-rated motors at the maximum power required for any flow condition as required by the structural design.
2. Blowers shall be provided with inlet screens, belt guards and other protective devices as required by the commissioner to provide protection from injury.
3. Blowers shall be housed within a weather-protecting structure.
4. Blowers shall be equipped with backdraft check dampers to minimize air loss when inoperative.
5. Blower inlets shall be located to provide protection from air contamination. The location of inlets shall be approved.

3102.8.2 Standby power. Wherever an auxiliary inflation system is required, an approved standby power-generating system shall be provided. However, notwithstanding Section 2702.1, the standby power-generating system shall be equipped with a suitable means for automatically starting the generator set upon failure of the normal electrical service and for automatic transfer and operation of all of the required electrical functions at full power within 60 seconds of such service failure. Standby power shall be capable of operating independently for ~~[a minimum of]~~

not less than 4 hours. Initiation of standby power shall be indicated by an audible and visual alert at the entrance or a regularly attended location.

3102.8.3 Support provisions. A system capable of supporting the membrane in the event of deflation shall be provided for in air-supported structures and air-inflated structures having an occupant load of 50 or more or where covering a swimming pool regardless of occupant load. Such support system shall be capable of maintaining the membranes [~~at least~~] not less than 7 feet (2134 mm) above the floor, seating area or surface of the water. When air-supported structures or air-inflated structures are used as a roof on Type I or II construction buildings, such support system shall be capable of maintaining the membranes not less than 20 feet (6096 mm) above the floor or seating area.

3102.9 Separation. No air-inflated structure, air-supported structure, or tent shall be erected closer than 20 feet (6096 mm) to any interior lot line nor closer than 30 feet (9144 mm) in any direction to an unprotected opening, required exterior stairway or corridor, or required exit door, on the same level or above the level of such structure. Such structure may abut another building on the same tax lot if the following conditions exist:

1. No unprotected openings or exits are located above or within 30 feet (9144 mm) of such structure.
2. No doors serving as a required exit are located between such structure and the abutted building.
3. The exterior wall of the abutted building meets the requirements of Section 705 for fire walls.

3102.10 Exits. In addition to the requirements of Chapter 10, travel distance to an exit from any point within a tent, air-supported structure, or air-inflated structure shall not exceed 75 feet (22 860 mm).

3102.10.1 Exit openings from tents. Exit openings from tents shall remain open unless covered by a flame-resistant curtain of a contrasting color to the tent. Such curtain shall be supported [~~at least~~] not less than 80 inches (2032 mm) above the floor level at the exit and, when open, no part of the curtain shall obstruct the exit.

3102.10.2 Exit openings from air-supported structures and air-inflated structures. Exit doors in air-supported structures and air-inflated structures shall close automatically against normal operational pressures. Opening force at the edge of such doors shall not exceed 15 pounds (6.80 kg), with the structure at operational pressure. Exit doors shall be located in frames constructed such that they will remain operative and support the weight of the pressurized membrane structure in a state of total collapse.

SECTION BC 3103 TEMPORARY STRUCTURES

3103.1 General. The provisions of [~~this section~~] Sections 3103.1 through 3103.4 shall apply to temporary tents, grandstands, platforms, reviewing stands, outdoor bandstands, stages and similar

miscellaneous structures erected for a period of 90 days or less. Such structures may be constructed of wood whether located inside or outside of the fire districts.

3103.1.1 Permit required. Temporary structures shall not be erected, operated or maintained for any purpose without obtaining a permit from the department in accordance with Section 28-111.1.1 of the *Administrative Code*.

Exception: No permit shall be required for:

1. The erection and use of temporary tents of less than 400 gross square feet (37 m²), for not more than 30 days.
2. The erection and use of temporary platforms, reviewing stands, outdoor bandstands, and similar miscellaneous structures that cover an area less than 120 square feet (11.16 m²), including connecting areas or spaces with a common means of egress or entrance, for not more than 30 days.

3103.2 Construction documents. A permit application and construction documents shall be submitted for each installation of a temporary structure. The construction documents shall include a site plan indicating the location of the temporary structure and information delineating the means of egress and the occupant load.

3103.3 Location. Temporary structures shall be located in accordance with the requirements of Table 602 based on the fire-resistance rating of the exterior walls for the proposed type of construction.

3103.4 Means of egress. Temporary structures shall conform to the means of egress requirements of Chapter 10 and shall have ~~[a maximum]~~ an exit access travel distance of 100 feet (30 480 mm) or less.

SECTION BC 3104 PEDESTRIAN WALKWAYS AND TUNNELS

3104.1 General. This section shall apply to connections between buildings such as pedestrian walkways or tunnels, located at, above or below grade level, that are used as a means of travel by persons. The pedestrian walkway shall not contribute to the building area or the number of stories or height of connected buildings.

3104.1.1 Application. Pedestrian walkways shall be designed and constructed in accordance with Sections 3104.2 through 3104.9. Tunnels shall be designed and constructed in accordance with Sections 3104.2 and 3104.10.

3104.2 Separate structures. ~~[Connected buildings]~~ Buildings connected by pedestrian walkways or tunnels shall be considered to be separate structures.

Exceptions:

1. Buildings that are on the same tax lot and considered as portions of a single building in accordance with Section 503.1.2.

2. For purposes of calculating the number of Type B units required by Chapter 11, structurally connected buildings and buildings with multiple wings shall be considered one structure.

3104.3 Construction. The pedestrian walkway shall be of a Construction Type that is at least equal to the higher type of the two buildings connected.

Exception: Exterior pedestrian walkways serving as a required exit shall be constructed of noncombustible materials and comply with the fire-resistance rating requirements as set forth in Chapter 7.

3104.4 Contents. Only materials approved by the department shall be located in the pedestrian walkway. Decorations may be permitted in accordance with the *New York City Fire Code*.

3104.5 Connections of pedestrian walkways to buildings. The connection of a pedestrian walkway to a building shall comply with Section 3104.5.1, 3104.5.2, 3104.5.3 or 3104.5.4.

Exception: Buildings that are on the same tax lot and considered as portions of a single building in accordance with Section 503.1.2.

~~[3104.5] 3104.5.1 Fire barriers [between pedestrian walkways and buildings]. [Walkways] Pedestrian walkways shall be separated from the interior of the building by not less than 2-hour fire barriers constructed in accordance with Section 707 and Sections 3104.5.1.1 through 3104.5.1.3. [or horizontal assemblies constructed in accordance with Section 712, or both. This protection shall extend vertically from a point 10 feet (3048 mm) above the walkway roof surface or the connected building roof line, whichever is lower, down to a point 10 feet (3048 mm) below the walkway and horizontally 10 feet (3048 mm) from each side of the pedestrian walkway. Openings within the 10 foot (3048 mm) horizontal extension of the protected walls beyond the walkway shall be equipped with devices providing a ¾ hour fire protection rating in accordance with Section 715.]~~

~~[Exception: On pedestrian walkways (i) having a maximum height above grade of three stories or 40 feet (12 192 mm), whichever is less; or (ii) where protected by sprinklers, five stories or 55 feet (16 764 mm), whichever is less, the walls separating the pedestrian walkway from a connected building and the openings within the 10 foot (3048 mm) horizontal extension of the protected walls beyond the walkway are not required to have a fire barrier by this section where any of the following conditions exist:]~~

3104.5.1.1 Exterior walls. Exterior walls of buildings connected to pedestrian walkways shall be 2-hour fire-resistance-rated. This protection shall extend not less than 10 feet (3048 mm) in every direction surrounding the perimeter of the pedestrian walkway.

3104.5.1.2 Openings in exterior walls of connected buildings. Openings in exterior walls required to be fire-resistance-rated in accordance with Section 3104.5.1.1 shall be equipped with opening protectives providing a not less than ¾-hour fire protection rating in accordance with Section 716.

3104.5.1.3 Supporting construction. The fire barrier shall be supported by construction as required by Section 707.5.1.

3104.5.2 Alternative separation. The wall separating the pedestrian walkway and the building shall comply with Section 3104.5.2.1 or 3104.5.2.2 where:

1. The distance between the connected buildings is more than [~~10 feet (3048 mm)~~] 30 feet (9144 mm).
2. The pedestrian walkway and connected buildings[~~, except for open parking garages,~~] are equipped throughout with an automatic sprinkler system in accordance with Section 903.3.1.1, and the roof of the walkway is not more than 55 feet (16 764 mm) above grade connecting to the fifth, or lower, story above grade plane, of each building.

Exception: Pedestrian walkways accessory to open parking garages need not be equipped with an automatic sprinkler system.

3104.5.2.1 Passage of smoke. The wall [~~is~~] shall be capable of resisting the passage of smoke [~~or is constructed~~].

3104.5.2.2 Glass. The wall shall be constructed of a tempered, wired or laminated glass wall and doors [~~subject to the following:~~] or glass separating the interior of the building from the pedestrian walkway. The glass shall be protected by an automatic sprinkler system in accordance with Section 903.3.1.1 that, when actuated, shall completely wet the entire surface of interior sides of the wall or glass. Obstructions shall not be installed between the sprinkler heads and the wall or glass. The glass shall be in a gasketed frame and installed in such a manner that the framing system will deflect without breaking (loading) the glass before the sprinkler operates.

[~~1.1. The wall or glass separating the interior of the building from the pedestrian walkway shall be protected by an automatic sprinkler system in accordance with Section 903.3.1.1 and the sprinkler system shall completely wet the entire surface of interior sides of the wall or glass when actuated.~~]

[~~1.2. The glass shall be in a gasketed frame and installed in such a manner that the framing system will deflect without breaking (loading) the glass before the sprinkler operates; and~~]

[~~1.3. Obstructions shall not be installed between the sprinkler heads and the wall or glass.~~]

3104.5.3 Open sides on walkway. [~~The~~] Where the distance between the connected buildings is more than [~~10 feet (3048 mm)~~] 30 feet (9144 mm), [~~and~~] the walls at the intersection of the pedestrian walkway and each building need not be fire-resistance-rated provided both sidewalls of the pedestrian walkway are [~~at least~~] not less than 50 percent open with the open area uniformly distributed to prevent the accumulation of smoke and toxic gases. The roof of the walkway shall be located not more than 40 feet (12 160 mm) above grade plane, and the walkway shall only be permitted to connect to the third or lower story of each building.

[3. Buildings are on the same tax lot, in accordance with Section 503.1.3.]

Exception: Where the pedestrian walkway is protected with a sprinkler system in accordance with Section 903.3.1.1, the roof of the walkway shall be located not more than 55 feet (16 764 mm) above grade plane and the walkway shall only be permitted to connect to the fifth or lower story of each building.

3104.5.4 Exterior walls greater than 2 hours. [4.] Where exterior walls of connected buildings are required by Section [704] 705 to have a fire-resistance rating greater than 2 hours, the walls at the intersection of the pedestrian walkway [shall] and each building need not be [equipped throughout with an automatic sprinkler system installed in accordance with Section 903.3.1.1.] fire-resistance-rated provided:

1. [5.] The pedestrian walkway [does not serve as a required exit] is equipped throughout with an automatic sprinkler system installed in accordance with Section 903.3.1.1.
2. The roof of the walkway is not located more than 55 feet (16 764 mm) above grade plane and the walkway connects to the fifth, or lower, story above grade plane of each building.

3104.6 Public way. Pedestrian walkways over a public way shall [also] comply with Chapter 32.

3104.7 Width. The unobstructed width of pedestrian walkways shall be not [be] less than 36 inches (914 mm). The total width shall be not [exceed] greater than 30 feet (9144 mm).

3104.8 Egress. Access shall be provided at all times to a pedestrian walkway that serves as a required exit. Doors satisfying the requirements of Chapter 10 shall enclose each end of such pedestrian walkway. The width of such pedestrian walkway shall be at least equal to the width of the doors opening onto such pedestrian walkway, but in no case less than 44 inches (1118 mm). The floor level at doors shall be the same as that of the connected building.

Exception: The floor level at doors of open pedestrian walkways shall be [at least] not less than 7½ inches (191 mm) below the level of the door. Where the requirements of Chapter 11 are applicable, [the] these differences in [levels] level shall be accommodated by means of ramps in compliance with the provisions of Chapter 11.

3104.9 Exit access travel. The length of exit access travel shall [not exceed] be 200 feet (60 960 mm) or less.

Exceptions:

1. Exit access travel distance on a pedestrian walkway equipped throughout with an automatic sprinkler system in accordance with Section 903.3.1.1 shall [not exceed] be 250 feet (76 200 mm) or less.
2. Exit access travel distance on a pedestrian walkway constructed with both sides [at least] not less than 50 percent open shall [not exceed] be 300 feet (91 440 mm) or less.

3. Exit access travel distance on a pedestrian walkway constructed with both sides ~~[at least]~~ not less than 50 percent open, and equipped throughout with an automatic sprinkler system in accordance with Section 903.3.1.1, shall ~~[not exceed]~~ be 400 feet (122 m) or less.

3104.10 Tunneled walkway. Separation between the tunneled walkway and the building to which it is connected shall be not ~~[be]~~ less than 2-hour fire-resistant construction and openings therein shall be protected in accordance with Table ~~[715.4]~~ 716.5.

SECTION BC 3105 AWNINGS, CANOPIES AND SUN CONTROL DEVICES

3105.1 General. Awnings, canopies, and sun control devices shall comply with the requirements of this section, the requirements of Chapter 32 for projections over public ways, and other applicable sections of this code.

Exception: Canopies projecting over public rights-of-way governed by Title 19 of the *Administrative Code* and rules of the *New York City Department of Transportation*.

3105.2 ~~[Definition]~~ Definitions. The following term ~~[shall, for the purposes of this section and as used elsewhere]~~ is defined in ~~[this code, have the meaning shown herein.]~~ Chapter 2:

RETRACTABLE AWNING. ~~[A retractable awning is a cover with a frame that retracts against a building or other structure to which it is entirely supported.]~~

SUN CONTROL DEVICE.

3105.3 Design and construction. Awnings, canopies, and sun control devices shall be designed and constructed to withstand wind or other lateral loads and live loads as required by Chapter 16 with due allowance for shape, open construction and similar features that relieve the pressures or loads. Structural members shall be protected to prevent deterioration. Awnings and canopies shall have frames of noncombustible material, covered with fabric that meets the fire propagation performance criteria of Test Method 1 or Test Method 2, as appropriate, of NFPA 701 or has a flame spread index not greater than 25 when tested in accordance with ASTM E 84 or UL 723, or covered in plastic in accordance with Section 2605, sheet metal, or other equivalent material, and shall be either fixed, retractable, folding or collapsible. Sun control devices shall be constructed of noncombustible materials.

3105.4 Reserved.

SECTION BC 3106 MARQUEES

3106.1 General. Marquees shall comply with this section and other applicable sections of this code. Marquees projecting beyond the street line shall also comply with the requirements of Chapter 32. Signs placed on marquees shall also comply with Section 3107.

3106.2 Thickness. The maximum height or thickness of a marquee measured vertically from its lowest to its highest point shall not be limited.

Exception: Marquees projecting beyond the street line shall meet the height and thickness requirements of Chapter 32.

3106.3 Roof construction. Where the roof or any part thereof is a skylight, the skylight shall comply with the requirements of Chapter 24. Every roof and skylight of a marquee shall be drained in accordance with the provisions of the *New York City Plumbing Code*.

3106.4 Location prohibited. Every marquee shall be so located as not to interfere with the operation of any exterior standpipe, and such that the marquee does not obstruct the clear passage of stairways or exit discharge from the building or the installation or maintenance of street lighting.

3106.5 Construction. A marquee shall be supported entirely from the building and constructed of noncombustible materials. Marquees shall be designed as required in Chapter 16. Structural members shall be protected to prevent deterioration.

SECTION BC 3107 SIGNS

3107.1 General. Signs shall be designed, constructed and maintained in accordance with Appendix H.

SECTION BC 3108 RADIO, TELEVISION, AND TELECOMMUNICATIONS TOWERS AND ANTENNAS

3108.1 General. Subject to the provisions of Chapter 16 and the requirements of Chapter 15 governing the fire-resistance ratings of buildings for the support of roof structures, radio, television, and telecommunications towers and antennas shall be designed and constructed as herein provided. All such towers and antennas shall be collectively referred to as “towers” for the purposes of this section. Towers shall be designed and constructed in accordance with the provisions of TIA-222.

Exceptions:

1. Exceptions related to seismic design in Section 2.7.3 of TIA-222 shall not apply;
2. The specified values for seismic coefficients S_s , S_1 and Site Factors F_a and F_v shall comply with Section 1613.3; and
3. The horizontal extent of Topographic Category 2, escarpments, shall be 16 times the height of the escarpment.

3108.2 Location and access. Towers shall be located and equipped with step bolts and ladders so as to provide ready access for inspection purposes. Guy wires or other accessories shall not cross or encroach upon any street or other public space, or over above-ground electric utility lines, or encroach upon any privately owned property without written consent of the owner of the encroached-upon property, space or above-ground electric utility lines. Towers shall be equipped with climbing and working facilities in compliance with TIA-222. See applicable OSHA, FCC and EPA regulations relating to limitations on access to tower sites.

3108.3 Construction. Towers shall be constructed of approved corrosion-resistant noncombustible material. The minimum type of construction of isolated radio towers not more than 100 feet (30 480 mm) in height shall be Type IIB.

3108.4 Loads. Towers shall be designed to resist wind loads in accordance with ~~[TIA/EIA 222]~~ TIA-222 and Chapter 16 of this code. The design criteria shall not be less stringent than required by Chapter 16. Consideration shall be given to conditions involving wind load on ice-covered sections.

3108.4.1 Dead load. Towers shall be designed for the dead load plus ice load.

3108.4.2 Wind load. Towers shall be provided with adequate foundations and anchorage designed to resist two times the calculated wind load.

3108.4.3 Earthquake load. Towers shall be provided with adequate foundations and anchorage designed to resist two times the calculated earthquake load.

3108.5 Grounding. Towers shall be permanently and effectively grounded in accordance with the *New York City Electrical Code*.

SECTION BC 3109

SWIMMING POOLS, SWIMMING POOL ENCLOSURES, AND SAFETY DEVICES

3109.1 General. Swimming pools, swimming pool enclosures, and swimming pool safety devices shall comply with the requirements of this section and other applicable sections of this code.

3109.2 Definitions. The following terms ~~[shall, for the purposes of this section and as used elsewhere in this code, have the meaning shown herein.]~~ are defined in Chapter 2:

BARRIER, TEMPORARY. ~~[An approved temporary fence, permanent fence, the wall of a permanent structure, any other structure, or any combination thereof that prevents access to the swimming pool by any person not engaged in the installation or construction of the swimming pool during its installation or construction.]~~

SWIMMING POOL. ~~[Any indoor or outdoor swimming, wading, spa, or special purpose pool.]~~

[Exceptions:]

- ~~[1. Portable, freestanding wading pools containing water less than 24 inches (610 mm) in depth.]~~
- ~~[2. Float tanks or relaxation tanks sized for use by one person at a time.]~~
- ~~[3. Pools used for religious purposes.]~~
- ~~[4. Spa pools used for prescribed medical therapy or rehabilitation and under medical supervision.]~~

SWIMMING POOL, PRIVATE. [~~A swimming pool that is accessory to a one- or two-family dwelling, or to a single dwelling unit of a multiple dwelling, and that is solely for the use of the occupants for noncommercial purposes.~~]

SWIMMING POOL, PUBLIC. [~~A swimming pool that is not a private swimming pool. Public swimming pools include swimming pools that are accessory to bathing establishments as such term is defined in the *New York City Health Code*, whether owned or operated by city agencies, or commercial interests or private entities, including, but not limited to, public or private schools, corporations, hotels, motels, camps, apartment houses, condominiums, country clubs, gymnasias and health establishments.~~]

3109.3 Pool [~~Safety and Accessibility~~] safety and accessibility. Public and private swimming pools shall comply with the requirements for safety and accessibility as provided in this section.

3109.3.1 Entrapment protection. Entrapment protection shall be provided in compliance with this section.

3109.3.1.1 Suction entrapment avoidance. Suction outlets shall be designed and installed in accordance with ANSI/APSP-7.

3109.3.2 Swimming pool and spa alarms. Swimming pool and spa alarms shall comply with Sections 3109.3.2.1 through 3109.3.2.4.

3109.3.2.1 Applicability. All swimming pools and spas shall be equipped with an approved pool alarm. Pool alarms shall comply with ASTM F 2208 and shall be installed, used and maintained in accordance with the manufacturer's instructions and this section.

Exceptions:

1. A hot tub or spa equipped with a safety cover that complies with ASTM F 1346.
2. A swimming pool (other than a hot tub or spa) equipped with an automatic power safety cover that complies with ASTM F 1346.

3109.3.2.2 Multiple alarms. A pool alarm must be capable of detecting entry into the water at any point on the surface of the swimming pool. If necessary to provide detection capability at every point on the surface of the swimming pool, more than one pool alarm shall be provided.

3109.3.2.3 Alarm activation. Pool alarms shall activate upon detecting entry into the water and shall sound poolside and inside the building.

3109.3.2.4 Prohibited alarms. The use of personal immersion alarms shall not be construed as compliance with this section.

3109.3.3 Water circulation, water treatment and drainage. The supply, circulation, treatment, and drainage of water for swimming pools shall meet the requirements of the *New York City Plumbing Code*.

3109.3.4 Electrical precautions. No overhead electrical conductors shall be installed within 15 feet (4572 mm) of any swimming pool. All metal fences, enclosures, or railings that might become electrically charged as a result of contact with broken overhead conductors or from any other cause near, or adjacent to, a swimming pool shall be grounded in accordance with the provisions of lightning protection in the *New York City Electrical Code*.

3109.3.5 Facilities for people with disabilities. Facilities for people with physical disabilities shall be provided where required by Chapter 11 of this code.

3109.4 Public swimming pools. Public swimming pools shall comply with the requirements for safety and accessibility as provided in Sections 3109.3 and 3109.4.

[Exceptions] Exception: A swimming pool with a power safety cover or a spa with a safety cover complying with ASTM F 1346.

3109.4.1 Barrier height and clearances. Public swimming pools shall be completely enclosed by a fence, wall, building, or other solid barrier, or any combination thereof, [~~at least~~] not less than 6 feet (1829 mm) in height. Openings in the enclosure and pedestrian access gates shall not permit the passage of a 4-inch-diameter (102 mm) sphere. The enclosure shall be equipped with self-closing and self-latching gates.

Exception: Enclosures shall be [~~at least~~] not less than 4 feet (1219 mm) in height when surrounding wading pools with water less than 24 inches (610 mm) in depth.

3109.4.2 Gates. Gates shall comply with Sections 3109.4.2.1 through 3109.4.2.3.

3109.4.2.1 Self-closing; opening configuration. All gates shall be self-closing. In addition, if the gate is a pedestrian access gate, the gate shall open outward, away from the pool.

3109.4.2.2 Self-latching; location of latch handle. All gates shall be self-latching, with the latch handle located within the enclosure (i.e., on the pool side of the enclosure) and [~~at least~~] not less than 40 inches (1016 mm) above grade. If the latch handle is located less than 54 inches (1372 mm) from the bottom of the gate, the latch handle shall be located [~~at least~~] not less than 3 inches (76 mm) below the top of the gate, and neither the gate nor barrier shall have any opening greater than 0.5 inch (12.7 mm) within 18 inches (457 mm) of the latch handle.

3109.4.2.3 Locking. All gates shall be securely locked with a key, combination or other child proof lock sufficient to prevent access to the swimming pool through such gate when the swimming pool is not in use or supervised.

3109.4.3 Other laws. In addition to the requirements of this section, any other, more stringent requirements for the construction and design of swimming pool and barriers that may be provided for in Article 165 of the *New York City Health Code*, as administered by the New York City Department of Health and Mental Hygiene, shall also be applicable.

3109.5 Private swimming pools. Private swimming pools shall comply with the requirements for safety and accessibility as provided in Section 3109.3 and this section.

Exception: An above-ground private swimming pool which has a maximum water depth of 4 feet (1219mm) and an area not exceeding 500 square feet (46.45 m²) that is accessory to an R-3 occupancy and is privately used for noncommercial purposes shall not be required to comply with Sections 3109.3.1, 3109.3.2, 3109.5.2, 3109.5.3 and 3109.5.4.

3109.5.1 Barrier height and clearances. The top of the barrier enclosing a private swimming pool shall be ~~[at least]~~ not less than 48 inches (1219 mm) above grade measured on the side of the barrier that faces away from the swimming pool. The ~~[maximum]~~ vertical clearance between grade and the bottom of the barrier shall be not greater than 2 inches (51 mm) measured on the side of the barrier that faces away from the swimming pool. Where the top of the pool structure is above grade, the barrier is authorized to be erected at grade level or mounted on top of the pool structure~~[-The maximum]~~, and the vertical clearance between the top of the pool structure and the bottom of the barrier shall be not greater than 4 inches (102 mm).

3109.5.1.1 Openings. Openings in the barrier shall not allow passage of a 4-inch-diameter (102 mm) sphere.

3109.5.1.2 Solid barrier surfaces. Solid barriers which do not have openings shall not contain indentations or protrusions except for normal construction tolerances and tooled masonry joints.

3109.5.1.3 Closely spaced horizontal members. Where the barrier is composed of horizontal and vertical members and the distance between the tops of the horizontal members is less than 45 inches (1143 mm), the horizontal members shall be located on the swimming pool side of the fence. Spacing between vertical members shall be not ~~[exceed]~~ greater than 1¾ inches (44 mm) in width. Where there are decorative cutouts within vertical members, spacing within the cutouts shall be not ~~[exceed]~~ greater than 1¾ inches (44 mm) in width.

3109.5.1.4 Widely spaced horizontal members. Where the barrier is composed of horizontal and vertical members and the distance between the tops of the horizontal members is 45 inches (1143 mm) or more, spacing between vertical members shall be not ~~[exceed]~~ greater than 4 inches (102 mm). Where there are decorative cutouts within vertical members, spacing within the cutouts shall be not ~~[exceed]~~ greater than 1¾ inches (44 mm) in width.

3109.5.1.5 Chain link dimensions. ~~[Maximum mesh]~~ Mesh size for chain link fences shall be not greater than a 2¼ inch square (57 mm square) unless the fence is provided with slats fastened at the top or the bottom ~~[which]~~ that reduce the openings to ~~[no]~~ not more than 1¾ inches (44 mm).

3109.5.1.6 Diagonal members. Where the barrier is composed of diagonal members, the ~~[spacing between parallel]~~ opening formed by the diagonal members shall be ~~[no more]~~ not greater than 1¾ inches (44 mm).

3109.5.1.7 Gates. Gates shall comply with Sections 3109.5.1.1 through 3109.5.1.6 and Sections 3109.5.1.7.1 through 3109.5.1.7.3.

3109.5.1.7.1 Self-closing; opening configuration. All gates shall be self-closing. In addition, if the gate is a pedestrian access gate, the gate shall open outward, away from the pool.

3109.5.1.7.2 Self-latching; location of latch handle. All gates shall be self-latching, with the latch handle located within the enclosure (i.e., on the pool side of the enclosure) and [~~at least~~] not less than 40 inches (1016 mm) above grade. In addition, if the latch handle is located less than 54 inches (1372 mm) from the bottom of the gate, the latch handle shall be located [~~at least~~] not less than 3 inches (76 mm) below the top of the gate, and neither the gate nor barrier shall have any opening greater than 0.5 inch (12.7 mm) within 18 inches (457 mm) of the latch handle.

3109.5.1.7.3 Locking. All gates shall be securely locked with a key, combination or other child proof lock sufficient to prevent access to the swimming pool through such gate when the swimming pool is not in use or supervised.

3109.5.1.8 Dwelling wall as a barrier. Where a wall of a dwelling serves as part of the barrier, one of the following shall apply:

1. Doors with direct access to the pool through that wall shall be equipped with an alarm that produces an audible warning when the door and/or its screen, if present are opened. The alarm shall be listed in accordance with UL 2017. The audible alarm shall activate within 7 seconds and sound continuously for a minimum of 30 seconds immediately after the door and/or its screen, if present, are opened and be capable of being heard throughout the house during normal household activities. The alarm shall automatically reset under all conditions. The alarm shall be equipped with a manual means, such as touchpad or switch, to temporarily deactivate the alarm for a single opening. Such deactivation shall last no more than 15 seconds. In dwellings not required to be accessible Type B units, the deactivation switch shall be located 54 inches (1372 mm) or more above the threshold of the door. In dwellings required to be accessible Type B units, the deactivation switch(es) shall be located at [~~54 inches (1372 mm) maximum and~~] 48 inches (1219 mm) [~~minimum~~] above the threshold of the door.
2. The swimming pool shall be equipped with a power safety cover which complies with ASTM F 1346.
3. The door providing access to the swimming pool from the dwelling shall open inward, away from the swimming pool, and shall be self-closing and have a self-latching device. The release mechanism of the self-latching device shall be located no less than 54 inches (1372 mm) from the bottom of the door. In dwellings required to be accessible Type B units, the release mechanism shall be located at 48 inches (1219 mm) above the threshold of the door.

3109.5.1.9 Pool structure as barrier. Where an above-ground private swimming pool structure is used as a barrier or where the barrier is mounted on top of the pool structure, and the means of access is a ladder or steps, then the ladder or steps either shall be capable of being secured, locked or removed to prevent access, or the ladder or steps shall be surrounded

by a barrier [~~which~~] that meets the requirements of Sections 3109.5.1.1 through 3109.5.1.8. [~~When~~] Where the ladder or steps are secured, locked or removed, any opening created shall not allow the passage of a 4-inch-diameter (102 mm) sphere.

3109.5.2 Indoor swimming pools. Walls surrounding indoor private swimming pools shall not be required to comply with Section 3109.5.1.8.

3109.5.3 Prohibited locations. Barriers shall be located so as to prohibit permanent structures, equipment or similar objects from being used to climb the barriers.

3109.5.4 Construction requirements. Private swimming pools shall be constructed so as to be water tight and easily cleaned. They shall be built of nonabsorbent materials with smooth surfaces and shall be free of open cracks and open joints.

3109.5.4.1 Walls. The walls of swimming pools shall be vertical for [~~at least~~] not less than the top 30 inches (762 mm) below the normal water level. The junctions between the side walls and the bottom shall be coved. A swimming pool overflow shall be provided meeting the requirements of the *New York City Plumbing Code*.

3109.5.4.2 Bottom slopes. The bottom of the swimming pool shall slope downward toward the main drains. The slope in shallow areas with depths less than 5 feet (1524 mm) shall not exceed 1 unit vertical in 12 units horizontal (8-percent slope). In portions of the swimming pool with depth greater than 5 feet (1524 mm), the slope shall not be steeper than 1 unit vertical in 3 units horizontal (33-percent slope).

3109.5.4.3 Ladders. There shall be a ladder or steps with handrails at the deep end and at the shallow end of every swimming pool. Ladders and steps shall have no-slip treads. All ladders shall be rigidly installed and shall be constructed of corrosion-resistant materials.

3109.5.4.4 Walkways. Every swimming pool shall have a walkway [~~at least~~] not less than 5 feet (1524 mm) wide around its entire perimeter. The walkway shall have a nonslip surface and shall be constructed to drain away from the swimming pool.

3109.5.4.5 Handholds. Every swimming pool shall be constructed so that either the overflow gutter, if provided, or the tops of the side walls afford a continuous handhold for bathers.

3109.5.4.6 Markings. Permanent markings showing the depth of the shallow end, break points, diving depth and deep end shall be provided so as to be visible from both inside and outside the swimming pool.

3109.5.4.7 Diving boards and towers. Diving towers shall be rigidly constructed and permanently anchored. The depth of the water below a diving board shall be [~~at least~~] not less than 102 inches (2591 mm) for a board 39 inches (991 mm) or less above the water. For a diving board more than 39 inches (991 mm) and not more than 118 inches (2997 mm) above the water, the depth of the water below the board shall be [~~at least~~] not less than 144 inches (3658 mm). For a diving board or platform more than 118 inches (2997 mm) above the water, the depth of the water below the board shall be [~~at least~~] not less than 192 inches (4877 mm).

Indoor swimming pools shall provide [~~at least~~] not less than 144 inches (3658 mm) overhead clearance above all diving boards.

3109.6 Temporary barriers. An outdoor swimming pool, including an in-ground, above[-]ground or on-ground pool, hot tub or spa shall be surrounded by a temporary barrier during installation or construction. Such barrier shall remain in place until a permanent fence in compliance with Section 3109.4 is provided for public swimming pools, or a barrier in compliance with Section 3109.5 is provided for residential private pools.

Exceptions:

1. Above-ground or on-ground residential swimming pools where the pool structure is the barrier in compliance with Section 3109.
2. Spas or hot tubs with a safety cover which complies with ASTM F 1346, provided that such safety cover is in place during the period of installation or construction of such hot tub or spa. The temporary removal of a safety cover as required to facilitate the installation or construction of a hot tub or spa during periods when at least one person engaged in the installation or construction is present is permitted.

3109.6.1 Height. The top of the temporary barrier shall be [~~at least~~] not less than 48 inches (1219 mm) above grade measured on the side of the barrier which faces away from the swimming pool.

3109.6.2 Replacement by a permanent barrier. A temporary barrier shall be replaced by a complying permanent barrier within either of the following periods:

1. 90 days of the date of issuance of the building permit for the installation or construction of the swimming pool; or
2. 90 days of the date of commencement of the installation or construction of the swimming pool.

3109.6.2.1 Replacement extension. Subject to the approval of the code enforcement official, the time period for completion of the permanent barrier may be extended for good cause, including, but not limited to, adverse weather conditions delaying construction.

**SECTION BC 3110
AUTOMATIC VEHICULAR GATES**

3110.1 General. Automatic vehicular gates shall comply with the requirements of [~~this section~~] Sections 3110.2 through 3110.4 and other applicable sections of this code.

3110.2 Definitions. The following term [~~shall, for the purposes of this section and as used elsewhere~~] is defined in [~~this code, have the meaning shown herein.~~] Chapter 2:

VEHICULAR GATE. [~~A gate that is intended for use at a vehicular entrance or exit and that is not intended for use by pedestrian traffic.~~]

3110.3 Vehicular gates intended for automation. Vehicular gates intended for automation shall be designed, constructed and installed to comply with the class of gate in accordance with the requirements of ASTM F 2200.

3110.3.1 Entrapment protection. Defined classes of gates shall be subject to the entrapment protection provisions per UL 325.

3110.4 Vehicular gate operators. Vehicular gate operators, when provided, shall be listed in accordance with UL 325.

SECTION BC 3111 SIDEWALK CAFÉS

3111.1 General. Sidewalk cafés provided beyond the building line shall comply with the requirements of this section, the New York City Zoning Resolution, the Commissioners of the Department of Consumer Affairs and Department of Transportation, and with the projection limitations of Chapter 32 of this code.

3111.2 Enclosures. Enclosed sidewalk cafés shall be constructed of noncombustible material. The walls of such enclosures shall not extend more than 8 feet (2438 mm) above the sidewalk. Light-transmitting plastic glazing complying with Section 2606 shall be permitted as glazing within such walls. Light-transmitting plastic skylight glazing complying with Section 2610 may be installed in the roofs of such enclosures.

3111.3 Awnings. Awnings supported entirely from the building may be placed over unenclosed sidewalk cafés provided they are [~~at least~~] not less than 8 feet (2438 mm) clear above the sidewalk and within the limits specified by the Commissioner of the Department of Consumer Affairs. Such awnings shall be in compliance with Section 3105 of this code.

3111.4 Obstructions prohibited. No part of any awning, enclosure, fixture, equipment or removable platform of a sidewalk café shall be located:

1. Beneath a fire escape so as to obstruct operation of fire escape drop ladders or counter-balanced stairs;
2. So as to obstruct any exit from a building;
3. So as to obstruct any cellar access hatch or areaway;
4. So as to interfere with any vent or other mechanical ventilation outlet or inlet; or
5. So as to interfere with or obscure any standpipe connections, hydrant or associated signage in any way that would hinder its use by the Fire Department.

Exception: Upon special application, the commissioner may permit an easily removable, prominently designated platform, designed in accordance with Section 3111.5, to cover a cellar entrance or areaway that is not used as a required means of egress.

3111.5 Removable platforms. Removable platforms of sidewalk cafés shall be constructed in accordance with the requirements of this section.

3111.5.1 Continuity. Removable platforms shall be constructed to provide for a continuous unbroken and level floor without openings or cracks so as to prevent any material or liquid from falling through to the area beneath.

3111.5.2 Maintenance. No papers, trash or other materials may be permitted to accumulate in the area beneath the floor of any removable platform.

3111.6 Accessibility. Sidewalk cafés and access thereto shall comply with Chapter 11.

3111.7 Assembly seating. Unless separated from seating inside the building by fire partitions complying with Section [708] 713, the seating for enclosed sidewalk cafés shall be added to that inside the building in order to determine whether a place of assembly certificate of operation is required.

3111.8 Rules. In addition to the requirements specified herein, the commissioner may promulgate such additional rules necessary to secure safety.

SECTION BC 3112 FENCES

3112.1 Permitted heights. Fences are permitted to be erected to a maximum height of 10 feet (3048 mm) above the ground.

Exceptions:

1. In residence districts, as established by the New York City *Zoning Resolution*, fences are permitted to be erected to a maximum height of 4 or 6 feet (1829 mm) above the ground, depending upon its location on the zoning lot.
2. Fences in residence districts used in conjunction with [~~nonresidence~~] nonresidential buildings and public playgrounds, excluding buildings accessory to dwellings, are permitted to be erected to a maximum height of 15 feet (4572 mm) above the ground.
3. Higher fences may be permitted by the commissioner where required for the enclosure of public playgrounds, school yards, parks, and similar public facilities.

SECTION BC 3113 PHOTOVOLTAIC PANELS AND MODULES

3113.1 General. Photovoltaic panels and modules shall comply with the requirements of this code, the New York City Electrical Code, the Zoning Resolution and the New York City Fire Code.

3113.1.1 Rooftop-mounted photovoltaic panels and modules. Photovoltaic panels and modules installed on a roof or as an integral part of a roof assembly shall comply with the requirements of the New York City Fire Code and Chapter 15 of this code.

SECTION BC 3114
[LARGE] LARGE WIND TURBINES

3114.1 General. Large wind turbines shall be designed and constructed in accordance with this section.

3114.2 Definitions. The following [~~words and~~] terms [~~shall for the purposes of this section have the meanings shown herein.~~] are defined in Chapter 2:

~~[Large]~~ **LARGE WIND TURBINE.** [~~A turbine with a swept area greater than 200 m².~~]

~~[large]~~ **LARGE WIND TURBINE TOWER.** [~~A structure that supports a large wind turbine.~~]

3114.3 Design standards. A large wind turbine shall be designed in accordance with standards adopted by rules of the commissioner. Such standards shall include but need not be limited to standards relating to the design of large wind turbines that are developed by the American Wind Energy Association, the New York State Energy Research and Development Authority, the California Energy Commission, the European Wind Turbine Certification, the British Wind Energy Association, the International Electrotechnical Commission, the National Renewable Energy Laboratory, or the Underwriters Laboratory.

3114.4 Wind speed. A large wind turbine shall be designed to withstand winds of up to and including 130 mph (58.1 m/s) or such higher wind load as may be specified in this code or the design standard for such turbine pursuant to Section 3114.3.

3114.5 Brakes and locks. Where necessary for public safety, the commissioner may require that a large wind turbine shall be equipped with a redundant braking system and a passive lock, including aerodynamic overspeed controls and mechanical brakes.

3114.6 Visual appearance. A large wind turbine shall be white, off-white, grey, or another non-obtrusive color specified by the commissioner.

3114.8 Access. Access to a large wind turbine shall be limited as follows:

1. Access to electrical components of a large wind turbine shall be prevented by a lock.
2. A large wind turbine tower shall not be climbable, except by authorized personnel, up to a height of 10 feet (3048 mm) measured from the base of such tower.

3114.9 Noise. A large wind turbine shall be designed to comply with the sound level limit of [~~section~~] Section 24-232.1 of the [~~Administrative Code~~] Administrative Code.

3114.10 Shadow flicker. The commissioner shall by rule establish shadow flicker limitations for large wind turbines for the purpose of limiting, to the extent practicable, such flicker on buildings adjacent to such turbines.

3114.11 Signal interference. The commissioner shall establish rules governing large wind turbines for purpose of minimizing, to the extent practicable, interference by such turbines with radio, telephone, television, cellular or other similar signals.

3114.12 Setback. No part of a large wind turbine or large wind turbine tower shall be located within a horizontal distance of a property line that is equal or less than one-half the height of such turbine, including such tower, measured from the base of such tower or, if there is no such tower, the base of such turbine.

Exception: A turbine or tower for which each owner of property adjacent to such property line has entered into a written agreement providing that such turbine or tower or a part thereof may be located closer to such property line than this section allows.

SECTION BC ~~3113~~ 3115 SMALL WIND TURBINES

~~[3113.1]~~ **3115.1 General.** In addition to other applicable requirements in this code, other law or rule, and established by the commissioner, small wind turbines shall be designed and constructed in accordance with this section.

~~[3113.2]~~ **3115.2 Definitions.** The following ~~[words and terms shall for the purposes of this section have the meanings shown herein.]~~ terms are defined in Chapter 2:

SMALL WIND TURBINE. ~~[A turbine with a swept area smaller than 200 m² that generates a voltage below 1000 V (AC) or 1500 V (DC).]~~

SMALL WIND TURBINE TOWER. ~~[A structure that supports a small wind turbine.]~~

~~[3113.3]~~ **3115.3 Design standards.** A small wind turbine shall be designed in accordance with standards adopted by rules of the commissioner. Such standards shall include but need not be limited to standards relating to the design of small wind turbines that are developed by the American Wind Energy Association, the New York State Energy Research and Development Authority, the California Energy Commission, the Small Wind Certification Council, the British Wind Energy Association, the International Electrotechnical Commission, the National Renewable Energy Laboratory, or the Underwriters Laboratory.

~~[3113.4]~~ **3115.4 Wind speed.** A small wind turbine shall be designed to withstand winds of up to and including 130 mph (58.1 m/s) or such higher wind load as may be specified in this code or the design standard for such turbine pursuant to Section 3113.3.

~~[3113.5]~~ **3115.5 Brakes and locks.** Where deemed necessary by the commissioner, a small wind turbine shall be equipped with a redundant braking system and a passive lock, including aerodynamic overspeed controls and mechanical brakes.

~~[3113.5.1]~~ **3115.5.1 Locking before hurricane or strong wind conditions.** If a hurricane or strong wind conditions are expected, the commissioner may order that small turbines equipped with passive locks be stopped and locked.

~~[3113.6]~~ **3115.6 Visual appearance.** A small wind turbine shall be white, off-white, grey, or another non-obtrusive color specified by the commissioner.

~~[3113.7]~~ **3115.7 Lighting.** A small wind turbine shall not be artificially lighted.

Exception: Lighting that is required by this code or other applicable laws or rules, provided that such lighting is shielded in accordance with rules promulgated by the commissioner.

[~~3113.8~~] **3115.8 Access.** Access to a small wind turbine shall be limited as follows:

1. Access to electrical components of a small wind turbine shall be prevented by a lock.
2. A small wind turbine tower shall not be climbable, except by authorized personnel, up to a height of 10 feet (3048 mm) measured from the base of such tower.

[~~3113.9~~] **3115.9 Noise.** A small wind turbine shall be designed in accordance with applicable sections of the New York City [~~noise control code~~] Noise Control Code.

[~~3113.10~~] **3115.10 Shadow flicker.** The commissioner shall by rule establish shadow flicker limitations for small wind turbines for the purpose of limiting, to the extent practicable, such flicker on buildings adjacent to such turbines.

[~~3113.11~~] **3115.11 Signal interference.** The commissioner shall establish rules governing small wind turbines for purpose of minimizing, to the extent practicable, interference by such turbines with radio, telephone, television, cellular or other similar signals.

[~~3113.12~~] **3115.12 Setback.** No part of a small wind turbine or small wind turbine tower shall be located within a horizontal distance of a property line that is equal or less than one-half the height of such turbine, including such tower, measured from the base of such tower or, if there is no such tower, the base of such turbine.

Exception: Turbines or towers for which each owner of property adjacent to such property line has entered into a written agreement providing that such turbine or tower or a part thereof may be located closer to such property line than this section allows.

§ 31. Chapter 32 of the New York city building code, as added by local law number 33 for the year 2007, sections 3201.9 and 3202.2.2.3 as added by and section 3202.4 as amended by local law number 109 for the year 2013, section 3202.2.1.9 as added by local law number 28 for the year 2012, sections 3201.2, 3201.8, 3202.1.3, 3202.2.1, 3202.2.1.1, 3202.2.1.2, 3202.2.1.4.3, 3202.2.1.4.5, 3202.2.1.4.6 as amended by and 3202.2.2.4, 3202.4.1 and 3202.5 as added by local law number 141 for the year 2013, is amended to read as follows:

CHAPTER 32 ENCROACHMENTS INTO THE PUBLIC RIGHT-OF-WAY

SECTION BC 3201 GENERAL

3201.1 Scope. The provisions of this chapter shall govern the encroachment of structures into the public right-of-way.

3201.1.1 Encroachments removable. All encroachments permitted beyond the street line by the provisions of this chapter shall be constructed so that they may be removed at any time without

endangering the structural safety or fire safety of the building except that footings as permitted under Section 3202.1.1 of this code need not be removable.

3201.2 Measurement. The projection of any structure or portion thereof shall be the distance measured horizontally from the lot line to the outermost point of the projection.

3201.3 Other laws. The provisions of this chapter shall not be construed to permit the violation of other laws regulating the use and occupancy of public property.

3201.3.1 Restrictions on construction and projections on certain streets, parkways, boardwalks and beaches. Notwithstanding the provisions of this chapter, it shall be unlawful to build, erect, or make areaways, steps or other encroachments or projections prohibited by Sections 19-131, 19-132, 19-135, 18-109, 18-112 and 18-113 of the *Administrative Code*.

3201.4 Drainage. Drainage water collected from a roof, awning, canopy or marquee, other than canvas and flexible material, and condensate from mechanical equipment shall not flow over a public walking surface.

3201.5 Permission revocable. Any permission, expressed or implied, permitting the construction of encroachments within the area of the street under the provisions of this chapter shall be revocable, except footings as permitted under Section 3202.1.1.

3201.6 Existing projections. Any part of a building that projects beyond a street line on January 1, 1938, may be maintained as constructed until its removal is directed in accordance with applicable law.

3201.7 Alteration of existing encroachments. Alterations to existing encroachments beyond the street line may be permitted in whole or in part, provided that such alterations conform with the requirements of this chapter.

3201.7.1 Fences, guards and railings. Elements of existing fences, guards and railings shall not be increased in height, thickness, spacing or opacity.

Exceptions:

1. Fences, guards and railings that are required to comply with other requirements of this code, including Chapters 10 and 16.
2. Buildings or structures designated by the Landmarks Preservation Commission, where such fences, guards or railings are approved by the Landmarks Preservation Commission.

3201.8 Definitions. [~~As used in this chapter, the~~] The following terms [~~shall have the following meanings~~] are defined in Chapter 2:

AREAWAY. [~~A space below grade adjacent to a building open to the outer air and enclosed by walls.~~]

CURB LINE. [~~The line coincident with the face of the street curb adjacent to the roadway.~~]

FOOTING. [~~A foundation element consisting of an enlargement of a foundation pier or foundation wall, wherein the soil materials along the side of and underlying the element may be visually inspected prior to and during its construction.~~]

PROJECTING SIGN. [~~A sign other than a wall sign, which projects from and is supported by a wall of a building or structure.~~]

SIGN. [~~Any letter, figure, character, mark, plane, point, marquee sign, design, poster, pictorial, picture, stroke, stripe, line, trademark, reading matter or illuminated service, which shall be constructed, placed, attached, painted, erected, fastened or manufactured in any manner whatsoever, so that the same shall be used for the attraction of the public to anyplace, subject, person, firm, corporation, public performance, article, machine or merchandise, whatsoever, which is displayed in any manner outdoors. Every sign shall be classified and conform to the requirements of that classification as set forth in this chapter.~~]

STREET. [~~A thoroughfare, including sidewalks and roadways, dedicated or devoted to public use by legal mapping or other lawful means, or a public way.~~]

STREET LINE. [~~A lot line separating a street from other land.~~]

VAULT. [~~Any space below the surface of a street, that is covered over, except those openings that are used exclusively as places for descending, by means of steps, to the cellar or basement of any building.~~]

3201.9 Department of Transportation approval. Any encroachment into the public right-of-way that exceeds the limitation provided for in this chapter shall require the approval of the Department of Transportation.

SECTION BC 3202 ENCROACHMENTS

3202.1 Encroachments below grade. Encroachments below grade shall comply with Sections 3202.1.1 through [3202.1.4] 3202.1.6.

3202.1.1 Footings. Exterior wall and column footings may be constructed to project beyond the street line not more than 12 inches (305 mm), provided that the top of the footing is not less than 8 feet (2438 mm) below the ground or sidewalk level. Foundation walls required to support permitted projections may be constructed to project not more than the permitted projection beyond the street line.

3202.1.1.1 Footings for temporary barriers or shields in [~~areas of special flood hazard~~] flood hazard areas or shaded X-Zones. In [~~areas of special flood hazard~~] flood hazard areas or shaded X-Zones, continuous footings for the support and attachment of temporary, removable dry floodproofing barriers or shields may be constructed to project beyond the street line not more than 12 inches (305 mm) both at grade and below grade.

3202.1.2 Vaults. Vaults may be permitted in accordance with the New York City Charter and [Chapter] Title 19 of the *Administrative Code*. Such vaults shall comply with the provisions of this code and other applicable laws and rules.

3202.1.3 Areaways. Areaways shall be protected by grates, guards or other approved means, subject to approval by the Commissioner of the Department of Transportation.

3202.1.4 Tunnels between buildings. Tunnels connecting buildings and projecting beyond street lines may be constructed subject to the approval of the Commissioner of the Department of Transportation. Such tunnels shall comply with the provisions of this code and other applicable laws and regulations.

3202.1.5 Sidewalk supports. Exterior foundation walls are permitted to be constructed with a ledge that projects beyond the street line not more than 4 inches (102 mm) to support sidewalk construction, provided that:

1. the top of the ledge is not more than 8 inches (203 mm) below the ground or sidewalk level; and
2. bottom of the ledge is not more than 24 inches (610 mm) below the ground or sidewalk level.

3202.1.6 Insulation. Insulation required to comply with the *New York City Energy Conservation Code* shall be permitted to encroach into the public right of way not more than 6 inches (152 mm) beyond the face of the structural element being insulated.

3202.2 Encroachments above grade. Encroachments into the public right-of-way above grade shall be prohibited except as provided for in Sections 3202.2.1 through [3202.2.3] 3202.2.5.

3202.2.1 Encroachments subject to the area limitations. Encroachments that are subject to area limitations are those elements listed in Sections 3202.2.1.1 through 3202.2.1.9, generally of an architectural character, that form an integral part of the building facade. The aggregate area of all such elements constructed to extend beyond the street line shall not exceed 10 square feet (0.93 m²) within any 10 feet (3048 mm) by 10 feet (3048 mm) square area of wall [~~except that a veneer may be applied to the entire facade of a building erected before December 6, 1968, if such veneer does not project more than 4 inches (102 mm) beyond the street line~~]. The area of any such projection shall be measured at that vertical plane, parallel to the wall, in which the area of the projection is greatest. This plane of measurement may be at the street line, the line of maximum projection or any point in between. For the purpose of measuring the projected area of a balcony, air spaces of less than 6 inches (152 mm) between closely spaced railing or guards elements shall contribute to the area of the projection.

[Exception:] Exceptions:

1. The aggregate area of all elements subject to area limitations that includes a balcony or associated railings and brackets shall not exceed 24 square feet (2.2 m²) in any 240 square foot (22.3 m²) area on a given story.

2. The aggregate area of elements on existing buildings or structures designated by the Landmarks Preservation Commission as landmarks or within historic districts shall not be limited provided that such elements are approved by the Landmarks Preservation Commission.

3202.2.1.1 Entrance details. Entrance details, including steps and doors when fully open, may be constructed to project beyond the street line not more than 18 inches (457 mm). Entrance steps that project beyond the street line shall be guarded at each end by railings at least 3 feet (914 mm) high or by other members of the entrance detail providing equivalent protection.

3202.2.1.2 Architectural details. Details such as cornices, eaves, bases, sills, headers, band course, opening frames, rustications, applied ornament or sculpture, grilles, windows when fully open, air conditioning units, and other similar elements may be constructed:

1. To project not more than 4 inches (102 mm) beyond the street line when less than 10 feet (3048 mm) above the ground or sidewalk level.
2. To project not more than 10 inches (254 mm) beyond the street line when more than 10 feet (3048 mm) above the ground or sidewalk level.

Exceptions:

1. Replacement or restoration of historical architectural details that are, or were[-];
 - 1.1. located more than 10 feet (3048 mm) above the sidewalk and that project more than 10 inches (254 mm), on existing buildings or structures designated by the Landmarks Preservation Commission, may be permitted provided they do not exceed the historic projections and provided that they are approved by the Landmarks Preservation Commission[-]; or
 - 1.2. located 10 feet (3048 mm) or less above the sidewalk, and that project more than 4 inches (102 mm), on existing buildings or structures designated by the Landmarks Preservation Commission, may be permitted provided they do not exceed the historic projections and provided that they are approved by the Landmarks Preservation Commission, and further provided that if the projection exceeds 18 inches (457 mm), the applicant demonstrates to the Department of Transportation's satisfaction that the replacement or restoration will not adversely impact the use of the public right of way.
2. New architectural details on new or existing buildings, additions or structures subject to the jurisdiction of the Landmarks Preservation Commission, that are more than 10 feet (3048 mm) above the sidewalk and that project more than 10 inches (254 mm) and no more than 3 feet (914 mm), may be permitted provided that the Landmarks Preservation Commission finds that the proposed

detail is appropriate to the historic character of the historic district or landmarked building, structure or site.

3202.2.1.3 Balconies. Balconies, including railings and supporting brackets, no parts of which are less than 10 feet (3048 mm) above the ground or sidewalk level, may be constructed to project not more than 2 feet 6 inches (762 mm) beyond the street line. When permitted by the provisions of this code, fire escapes that are part of a required exit may be constructed to project not more than 4 feet 6 inches (1372 mm) beyond the street line provided no part, including any movable ladder or stair, is lower than 10 feet (3048 mm) above the ground or sidewalk level when not in use.

3202.2.1.4 Marquees. Marquees may be constructed to project beyond the street line provided that they comply with Section 3106 and Sections 3202.2.1.4.1 through 3202.2.1.4.5.

3202.2.1.4.1 Height. Marquees shall receive structural support only from the building and shall be at least 10 feet (3048 mm) above the ground level or sidewalk.

3202.2.1.4.2 Projection. Marquees shall project no closer to the curb line than 2 feet (610 mm).

3202.2.1.4.3 Thickness. Marquees shall be no thicker nor shall the fascia be higher than 3 feet (914 mm) when measured vertically from its lowest to its highest point.

3202.2.1.4.4 Dimensions. Dimensions shall include all decoration but shall exclude any tension supports suspending the marquee from the wall.

3202.2.1.4.5 Occupancy restrictions. Marquees may be erected on:

1. Buildings of an essentially public nature, including but not limited to the following:
 - 1.1. Public buildings, including schools.
 - 1.2. Theatres.
 - 1.3. Hotels.
 - 1.4. Terminals.
 - 1.5. Large department stores.
 - 1.6. Supermarkets.
 - 1.7. Multiple dwellings.
 - 1.8. Office buildings
2. Warehouses or markets in one of the following established market areas:

2.1. Bronx.

- 2.1.1. Edgewater Road and Halleck Street between Lafayette Avenue and East Bay Avenue.
- 2.1.2. Lafayette Avenue between Edgewater Road and the Bronx River.
- 2.1.3. East Bay Avenue between Halleck Street and the Bronx River.
- 2.1.4. Hunt's Point Avenue between East Bay Avenue and the Bronx River.
- 2.1.5. Exterior Street between East 149th Street and East 157th Street.
- 2.1.6. Cromwell Avenue between East 150th Street and East [~~153rd~~] 153rd Street.
- 2.1.7. East 150th Street between Exterior Street and River Avenue.
- 2.1.8. Westchester Avenue between St. Ann's Avenue and Bergen Avenue.
- 2.1.9. Brook Avenue between East 150th Street and East 156th Street.
- 2.1.10. Bergen Avenue between East 149th Street and East 156th Street.
- 2.1.11. East 152nd Street between Bergen Avenue and Brook Avenue.
- 2.1.12. East [~~153rd~~] 153rd Street between Bergen Avenue and Brook Avenue.

2.2. Brooklyn.

- 2.2.1. North 6th Street between Berry Street and Wythe Avenue.

2.3. Manhattan.

- 2.3.1. John Street to Fulton Street between South Street and Front Street.
- 2.3.2. Fulton Street to Dover Street between South Street and Water Street.
- 2.3.3. South Street and Front Street between John Street and Dover Street.
- 2.3.4. Water Street between Fulton Street and Dover Street.
- 2.3.5. Horatio Street to West 14th Street between West Street and 9th Avenue.
- 2.3.6. West Street, Washington Street, Greenwich Street
- 2.3.7. 9th Avenue and 10th Avenue between Horatio Street and West 14th Street.

2.3.8. West 16th Street, north side, and West 17th Street, south side, between 10th Avenue and 11th Avenue.

2.3.9. West 24th Street to West 26th Street, south side, between 11th Avenue and 12th Avenue.

2.3.10. West 27th Street, north side, to West 28th Street between 11th Avenue and 12th Avenue.

2.3.11. 12th Avenue and St. Claire Place between 125th Street and 132nd Street.

2.3.12. 12th Avenue, west side, between 132nd Street and 133rd Street.

2.4. Queens.

2.4.1. 95th Avenue, north side, between Sutphin Boulevard and 148th Street.

3202.2.1.4.6 Change of occupancy. When the occupancy or use of a building with a marquee is changed to an occupancy or use for which a projecting marquee is not permitted, the marquee shall be removed.

Exception: For buildings subject to the jurisdiction of the Landmarks Preservation Commission, ~~[section]~~ Section 3202.2.1.4.6 shall not apply when the Landmarks Preservation Commission makes a determination that the removal of the marquee would be inappropriate to the architectural character of the building or historic district.

3202.2.1.4.7 Other agency approvals. An applicant wishing to erect a marquee shall provide proof that the Commissioners of the Departments of Transportation, Consumer Affairs, and Environmental Protection have not permitted the use of a space or structure on or under the sidewalk beneath the proposed marquee in such a manner that the construction of the proposed marquee shall interfere with the removal or repair of any such permitted use or structure.

3202.2.1.5 Light fixtures. Light fixtures that are supported entirely from the building may be constructed to project not more than 2 feet (610 mm) beyond the street line, provided no part of the fixture is less than 8 feet (2438 mm) above the ground or sidewalk level.

3202.2.1.6 Flagpoles. Flagpoles that are supported entirely from the building may be constructed to project not more than 18 feet (5486 mm) beyond the street line, but not closer than 2 feet (610 mm) to the curb line, provided that no part of the flagpole is less than 15 feet (4572 mm) above the ground or sidewalk level.

3202.2.1.7 Wall signs. Wall signs may be constructed to project not more than 12 inches (305 mm) beyond the street line when conforming to the requirements of this code and Section H111 of Appendix H.

3202.2.1.8 Projecting signs. All permitted projecting signs may be constructed to project not more than 10 feet (3048 mm) beyond the street line, but not closer to the curb line than 2 feet (610 mm), when conforming to the requirements of this code and Section H112 of Appendix H, and provided that no part of the sign is less than 10 feet (3048 mm) above the ground or sidewalk level.

Exceptions: Permanent projecting signs are prohibited on buildings in the areas indicated below:

1. Borough of Manhattan.
 - 1.1. Projecting signs. No permanent projecting sign shall be erected on any building on:
 - 1.1.1. 5th Avenue between Washington Square north and 110th Street;
 - 1.1.2. 34th Street between Park Avenue and 7th Avenue;
 - 1.1.3. Madison Avenue between 23rd Street and 96th Street;
 - 1.1.4. 57th Street between Lexington Avenue and Broadway;
 - 1.1.5. Vanderbilt Avenue between 42nd Street and 47th Street;
 - 1.1.6. Park Avenue between 32nd Street and 40th Street;
 - 1.1.7. Park Avenue between 45th Street and 96th Street;
 - 1.1.8. 33rd Street between Lexington Avenue and 5th Avenue;
 - 1.1.9. 35th through 41st Streets between Lexington Avenue and 5th Avenue;
 - 1.1.10. 43rd through 56th Streets between Lexington Avenue and 5th Avenue;
 - 1.1.11. 58th Street between Lexington Avenue and 5th Avenue;
 - 1.1.12. 60th Street between Lexington Avenue and 5th Avenue;
 - 1.1.13. Nassau Street between Wall Street and Frankfort Street; or
 - 1.1.14. John Street between Broadway and William Street.
 - 1.2. Illuminated projecting signs. No permanent illuminated projecting sign shall be erected on any building on:
 - 1.2.1. 72nd Street between Central Park West and River Drive.
2. Borough of Brooklyn.

- 2.1. Projecting signs. No permanent projecting sign shall be erected on any building on:
 - 2.1.1. Fulton Street between Flatbush Avenue and Joralemon Street and Willoughby Street.
- 2.2. Illuminated projecting signs. No permanent illuminated projecting sign shall be erected on any building on:
 - 2.2.1. Fulton Street between Flatbush Avenue and Prospect Street and Henry Street;
 - 2.2.2. Washington Street between Myrtle Avenue and Prospect Street;
 - 2.2.3. Court Street between Fulton Street and Livingston Street;
 - 2.2.4. Pierrepoint Street between Fulton Street and Clinton Street;
 - 2.2.5. Montague Street between Court Street and Clinton Street;
 - 2.2.6. Remsen Street between Court Street and Clinton Street; or
 - 2.2.7. Joralemon Street between Court Street and Clinton Street.

3202.2.1.9 Sun control devices. Sun control devices constructed in accordance with Section 3105 and supported entirely from the building may project beyond the street line not more than 2 feet 6 inches (762 mm), provided that no part of the sun control device is less than 8 feet (2438 mm) above the ground or sidewalk level. Any portion of a sun control device that is located over a sidewalk vault and is more than 10 inches (254 mm) beyond the street line and less than 40 feet above the ground or sidewalk shall be removable or retractable to less than 10 inches (254 mm) beyond the street line.

3202.2.2 Encroachments not subject to area limitations.

3202.2.2.1 Ramps. When a building erected prior to December 6, 1969, is altered to provide access to individuals who use wheelchairs, ramps constructed to provide such access may, with the approval of the commissioner, project beyond the street line for a distance of not more than 44 inches (1118 mm). Ramps shall comply with the applicable provisions of Chapter 11.

3202.2.2.2 Bridges between buildings. Bridges connecting buildings and projecting beyond street lines may be permitted in accordance with applicable law. Such bridges shall be of a construction class that is at least equal to the higher class of the two buildings connected and shall otherwise comply with the provisions of this code and other applicable laws and rules.

3202.2.2.3 Flood shield supports. In [~~areas of special flood hazard~~] flood hazard areas or shaded X-Zones, permanent attachments to building façades necessary for the support and attachment of temporary, removable dry floodproofing barriers or shields may be constructed to project beyond the street line for a distance of not more than 6 inches (152 mm).

3202.2.2.4 Curb cuts. The lowering of any curb or the change of grade of any sidewalk for the purpose of providing a driveway across such curb or sidewalk shall be constructed in accordance with the specifications prescribed in [~~Sections 406.7.6 and 406.7.7~~] Section 406.10. [~~All sidewalks and driveways or portions thereof that are structurally supported shall be designed for loads prescribed in Chapter 16.~~]

3202.2.2.4.1 Curb cut removal. Vehicular access curb cuts that can no longer serve as vehicular access across a curb or sidewalk, including where an existing building served by such a curb cut is demolished, shall be removed and the curb and sidewalk shall be restored in accordance with standards of the Department of Transportation. The commissioner may order such removal and restoration. The commissioner shall limit the length of any curb cut for the purpose of providing a driveway across such curb or sidewalk, when in the opinion of the commissioner the actual use or intended use of such driveway would endanger the public. Where the vehicular use of such driveway, in the opinion of the commissioner is dangerous to the public, the commissioner shall order the owner to discontinue use of such driveway and restore the curb and sidewalk in accordance with standards of the Department of Transportation. Upon the failure of the owner to comply with any of the orders provided for in Section 3202.2.2.4, in such cases where the restoration of such curb cuts are needed to facilitate department of transportation work, the commissioner may inform the commissioner of transportation of such failure to comply and may request the cooperation of the commissioner of transportation acting under his or her authority pursuant to [~~section~~] Section 2903(b)(7) of the New York City Charter in the enforcement of this section.

3202.2.3 Awnings. Awnings constructed in accordance with Section 3105 and supported entirely from the building may project beyond the street line as follows:

3202.2.3.1 Store front awnings. Store front awnings may project beyond the street line not more than 8 feet (2438mm), provided no part of the awning is less than 8 feet (2438 mm) above the ground or sidewalk level, except for a flexible valance which may be not less than 7 feet (2134 mm) above the ground or sidewalk level, and provided that the awning box or cover does not project more than 12 inches (305 mm).

3202.2.3.2 Awnings over windows or doors. Awnings over windows or doors may project beyond the street line not more than 5 feet (1524 mm), provided that no part of the awning is less than 8 feet (2438 mm) above the ground or sidewalk level.

~~[3202.2.5]~~ **3202.2.4 Fire department connections, caps or plugs.** Fire department connection swivels, caps and plugs including test headers shall be permitted to project beyond the street line as provided for in NFPA 14, as amended by Appendix Q of this code.

3202.2.5 Exterior wall covering systems for prior code buildings. For prior code buildings, exterior insulation and associated cladding systems (i.e. rain screens, EIFS, etc.) may be applied to the entire facade of a building provided such exterior wall covering system is needed to comply with the requirements of the *New York City Energy Conservation Code* and does not project more than 8 inches (203 mm) beyond the street line. Exterior wall coverings shall comply with Chapter 14.

Exceptions:

1. A veneer may be applied to the entire facade of a building erected before December 6, 1968, provided such veneer does not project more than 4 inches (102 mm) beyond the street line.
2. Exterior wall covering systems projecting not more than 10 inches (254 mm) beyond the street line shall be permitted to cover the façade of a prior code building provided they are located more than 10 feet (3048 mm) above grade and are necessary to comply with the *New York City Energy Conservation Code*.
3. The department may approve exterior wall covering systems projecting not more than 12 inches (305 mm) beyond the street line provided they are necessary to comply with the *New York City Energy Conservation Code*, are substantiated with engineering calculations demonstrating need and practical difficulty, and provided that the applicant demonstrates to the Department of Transportation's satisfaction that the projection of the wall covering system will not adversely impact the use of the public right of way.

3202.3 [Reserved.]

[3202.4] Temporary encroachments. Encroachments of temporary nature shall comply with Sections [3202.4.1 and 3202.4.3] 3202.3.1 through 3202.2.3.

[3202.4.1] 3202.3.1 Sidewalk cafés. Enclosures for sidewalk cafés, where permitted by the Commissioner of the Department of Consumer Affairs pursuant to applicable law and constructed in compliance with Section 3111, may be constructed beyond the street line.

[3202.4.2] 3202.3.2 [Storm] Temporary storm enclosures. ~~[Storm enclosures projecting not more than 18 inches (457 mm) beyond the street line]~~ Construction of temporary storm enclosures must comply with the requirements of this code, including the fire-resistance rating of the building to which it is appurtenant, and Chapter 11. Such enclosures may be permitted during the period between November 15 and the following April 15 and must be removed at the end of this period. [Such enclosures shall be removed at the end of this period. Construction of storm enclosures must comply with the requirements of this code including the fire resistance rating of the building to which it is appurtenant and Chapter 11 of this code.]

3202.3.2.1 Temporary storm enclosures for eating and drinking establishments. Provided a minimum clear unobstructed sidewalk width of 5 feet is maintained, temporary storm enclosures for eating and drinking establishments with a projection of not more than 25 square feet (2.32 m²) in area and door maneuvering clearances complying with Chapter 11, and related reference standards, including Section 404 (Doors and Doorways) of ICC A117.1, may be permitted.

3202.3.2.2 Temporary storm enclosures for other establishments. Temporary storm enclosures projecting not more than 18 inches (457 mm) beyond the street line may be permitted at other establishments.

~~[3202.4.3]~~ **3202.3.3 Temporary flood shields, stairs and ramps in ~~[areas of special flood hazard]~~ flood hazard areas and shaded X-Zones.** In ~~[areas of special flood hazard]~~ flood hazard areas and shaded X-Zones, temporary flood shields, stairs and ramps shall comply with Sections ~~[G308.6 and G308.7]~~ G308.9 and G308.10 of Appendix G of the *New York City Building Code* and shall be permitted in accordance with plans approved by the department subject to the following conditions:

1. Such flood shields, stairs and ramps shall project no more than one foot (305 mm) beyond the street line.
2. Such flood shields, stairs and ramps shall be removed in a timely manner after a flood event.

§ 32. Section BC 3301 of the New York city building code, as added by local law number 33 for the year 2007, section 3301.1, section 3301.2, and sections 3301.4 through 3301.8 as amended by local law number 141 for the year 2013, section 3301.3 as amended by local law number 81 for the year 2017, section 3301.9 as added by local law number 47 for the year 2013, and sections 3301.11.1.1 through 3301.11.1.3 and section 3301.11.1.5 as added by local law number 206 for the year 2017, section 3301.11.4 as amended by local law number 10 for the year 2020, section 3301.12 as added by local law number 204 for the year 2017, and section 3301.13 as added by local law number 81 for the year 2017, is amended to read as follows:

SECTION BC 3301 GENERAL

3301.1 Scope. The provisions of this chapter shall govern the conduct of all construction or demolition operations with regard to the safety of the public and property. For regulations relating to the safety of persons employed in construction or demolition operations, OSHA standards shall apply.

3301.1.1 Responsibility for safety. Nothing in this chapter shall be construed to relieve persons engaged in construction or demolition operations from complying with other applicable provisions of law, nor is it intended to alter or diminish any obligation otherwise imposed by law on any party engaged in a construction or demolition operation, including but not limited to the owner, construction manager, general contractor, sub [-] contractors, material men, registered design professionals, or other party to engage in sound design and engineering, safe construction or demolition practices, including but not limited to debris removal, and to act in a reasonable and responsible manner to maintain a safe construction or demolition site.

3301.1.2 Fire code. In addition to the requirements of this chapter, construction or demolition operations shall also be conducted in conformance with the *New York City Fire Code*.

3301.1.3 Manufacturer specifications. ~~[All equipment shall be used in accordance with the specifications of the manufacturer, where such specifications exist, and the requirements of this code. Where there is a discrepancy, the stricter requirement shall apply.]~~ See Section 3301.6.1.

3301.1.4 Sizes. All sizes and dimensions prescribed in this chapter are minimum requirements, unless otherwise specified. Lumber sizes are nominal or commercial except where stated otherwise.

3301.2 Safety measures and standards. Contractors, construction managers, and subcontractors engaged in construction or demolition operations shall institute and maintain all safety measures required by this chapter and provide all equipment or temporary construction installations necessary to safeguard the public and property affected by such contractor's operations.

3301.3 Site safety managers, coordinators and ~~[superintendent of construction]~~ construction superintendents. A site safety manager or site safety coordinator must be designated and present at the construction or demolition of a major building in accordance with Section 3310. A ~~[superintendent of construction]~~ construction superintendent is required for the construction or demolition of ~~[such other]~~ buildings as identified in Section 3301.13.3.

3301.4 Inspection. Structures, temporary construction installations, materials, operations, and equipment shall be inspected as required by this code, and records of such inspections shall be maintained as required by this code.

3301.4.1 Inspection of equipment where the code does not specifically require an inspection. Where this code does not ~~[provide for specific inspection criteria]~~ specifically require an inspection, any equipment, except hand tools, that would affect the safety of the public and property when operated shall be inspected by a competent person designated by the contractor using the equipment before the equipment is used at the site and on a periodic basis thereafter throughout the duration of the job. ~~[A record of such inspections shall be kept at the site.]~~ The results of the inspection shall be documented in an inspection checklist signed and dated by the competent person who performed the inspection.

3301.5 Unsafe conditions ~~[and equipment]~~. Any structure, temporary construction installation, material, operation, or equipment found to be defective or unsafe, and posing a risk to the public and property, shall be immediately secured and corrected, or removed from the site.

~~**[3301.6 Design, sizes, and capacity of materials, structures, temporary construction, and equipment.** Design, sizes, and capacities of materials, structures, temporary construction, and equipment shall be in accordance with the requirements of Sections 3301.6.1 through 3301.6.3.]~~

~~**[3301.6.1 Design.** Whenever design is specifically required by the provisions of this chapter, such design shall be in accordance with the requirements of this code and executed by, or under, the supervision of a registered design professional who shall cause his or her seal and signature to be affixed to such documents that may be required for the work.]~~

~~**[Exception:** Where this chapter specifically indicates that the design may be executed by another individual.]~~

~~[3301.6.2 Sizes. All sizes and dimensions prescribed in this chapter are minimum requirements. Lumber sizes are nominal or commercial except where stated otherwise.]~~

~~[3301.6.3 Capacity. No structure, temporary construction, or equipment shall be loaded in excess of its capacity as specified by the code, manufacturer, and/or designer. Where there is a discrepancy, the stricter standard shall apply.]~~

3301.6 Manufacturer specifications, design, and capacity. The permit holder, or where there is no permit holder, the contractor or other entity causing the work to be performed, shall ensure compliance with manufacturer specifications, design documents, and capacity restrictions in accordance with Sections 3301.6.1 through 3301.6.5 and other applicable sections of the code. Where there is a discrepancy between a manufacturer specification, design document, capacity restriction, or other applicable code section, the more stringent requirement shall apply.

3301.6.1 Manufacturer specifications. During construction or demolition operations, structures, building systems or components, temporary construction installations, materials, and equipment shall be installed, removed, and utilized in accordance with the specifications of their manufacturer, where such specifications exist.

3301.6.2 Design requirements. Whenever design is required by this chapter, the design shall be in accordance with the requirements of this code. This requirement does not alleviate any other design requirements imposed by law or the manufacturer.

3301.6.3 Designer. Where design is required by this chapter, the design shall be executed by or under the supervision of a registered design professional, who shall cause his or her seal and signature to be affixed to such documents that may be required for the work

Exception: Where this chapter specifically indicates that the design may be executed by another individual.

3301.6.4 Capacity. No structure, building system or component, temporary construction installation, material, or equipment, including any partially or fully completed element or section, shall be utilized in excess of its capacity.

3301.6.5 Design documents. Whenever design is required by this chapter, the design shall be indicated in plans and specifications and other written, graphic and pictorial documents that are prepared or assembled for describing the design, location, physical characteristics, and other elements of the project. Design documents shall be complete and of sufficient clarity to indicate the location and entire nature and extent of the work proposed, and shall show in detail that the work conforms to the provisions of this code and other applicable laws and rules.

3301.7 Documents to be ~~[kept]~~ maintained on site. Where this chapter requires documents, including but not limited to construction documents, submittal documents, shop drawings, inspection reports, logs, checklists, meeting records, pre-construction surveys, designation letters, site safety plans, fire safety and evacuation plans, tenant protection plans, occupant protection plans, or monitoring plans, copies of such documents shall be maintained at the site for the duration of the job and made available to the commissioner upon request. Copies of ~~[such aforementioned]~~ required construction documents or other design drawings shall also be maintained by the permit holder and

the designer. Copies of ~~[such aforementioned]~~ required inspection records, including but not limited to reports, logs, or checklists, shall also be maintained by the permit holder and the entity that performed the inspection. Copies of ~~[such aforementioned]~~ required plans shall also be ~~[kept]~~ maintained by the permit holder and the entity that developed the plan. Copies of all other documents required by this chapter shall also be maintained by the permit holder.

[Exception:] 3301.7.1 Other obligations. Where this chapter requires ~~[inspection reports, logs, checklists, site safety plans, fire safety and evacuation plans, tenant protection plans, occupant protection plans, or monitoring plans]~~ documents to be maintained by ~~[a]~~ another specified entity ~~[other than the permit holder],~~ such ~~[reports, logs, checklists, or plans]~~ documents shall be maintained by such specified entity.

3301.7.2 Manufacturer specifications. Where compliance with manufacturer specifications is required by this chapter, copies of such manufacturer specifications shall be available at the site and made available to the commissioner upon request. Manufacturer specifications that can be readily downloaded from the manufacturer's website or that are stored in an electronic format acceptable to the commissioner shall satisfy the requirements of this section. A serial number, make and model number, or other similar identification shall be maintained in a legible condition on the item for which the manufacturer specification is required such that the identification can be used to match the item to the manufacturer specification.

Exception: Where this chapter specifically requires that the manufacturer specifications for a specific item be physically maintained at the site, downloadable or electronically formatted manufacturer specifications will not satisfy the accessibility and availability requirements of this section.

3301.8 ~~[Accidents]~~ Incidents and damage to adjoining property. The department shall be notified immediately by the permit holder, or a duly authorized representative, of ~~[an accident]~~ any incident at a construction or demolition site, or of any damage to adjoining property caused by construction or demolition activity at the site. Where required by Section 3301.13.11 or Section 3310.8.2.1, incidents or damage to adjoining property shall instead be reported by the construction superintendent or the site safety manager or coordinator.

3301.8.1 Additional notifications. Nothing in this section shall diminish or relieve other notification requirements imposed by this chapter, including but not limited to, notifications by the site safety manager, site safety coordinator, concrete safety manager, or hoisting machine operator.

~~[3301.8.1]~~ **3301.8.2 Use and tampering prohibited.** Following an ~~[accident]~~ incident, no person shall permit any of the following without the permission of the commissioner, or without a lawful order from the New York ~~[City Police or Fire Department]~~ city police or fire department:

1. Use or operation of any equipment or structure damaged or involved in the ~~[accident]~~ incident; or
2. Removal or alteration of any equipment, structure, material, or evidence related to the ~~[accident]~~ incident.

Exception: Immediate emergency procedures taken to secure structures, temporary construction installations, operations, or equipment that pose a continued imminent danger or to facilitate assistance for persons who are trapped or who have sustained bodily injury.

3301.9 [~~Required signs~~] Signs at a construction or demolition site. Signs shall be posted at a construction or demolition site in accordance with Sections 3301.9.1 through [~~3301.9.5~~] 3301.9.8. It is the responsibility of the permit holder for the underlying construction or demolition work, or where there are no active permits, the building owner, to ensure such signs are posted and maintained at the site in accordance with Sections 3301.9.1 through 3301.9.8, and to ensure that such signs are updated in a timely fashion to reflect any revised information.

3301.9.1 Fence project information panel. Where a site is enclosed with a fence in accordance with Section 3307.7, a project information panel meeting the requirements of Sections 3301.9.1.1 through 3301.9.1.6 shall be posted. Required project information panels shall be in place throughout the duration that the fence remains at the site.

[Exceptions:] Exception:

- ~~[1. At a site where the project permit was issued or renewed prior to July 1, 2013, signs meeting the requirement of Section 3301.9.3 may be posted in lieu of a project information panel. Such signs shall be removed and a project information panel in accordance with the requirements of this section installed upon date of the first permit renewal on or after July 1, 2013.]~~
- ~~[2.] Project information panels at government-owned sites or at sites with government funding [5] may be modified in accordance with department rule.~~
- ~~[3. Signs posted at construction or demolition sites for one, two or three family dwellings may comply with Section 3301.9.3 in lieu of this section.]~~

3301.9.1.1 Project information panel content. Project information panels shall contain the following information:

1. A rendering, elevation drawing, or zoning diagram of the building exterior that does not contain logos or commercially recognizable symbols;
2. A title stating “Work in Progress:” and specifying the intended type(s) of zoning use(s) (e.g. Residential, Commercial, Manufacturing, Retail, Office, Hospital, School);
3. Anticipated project completion date;
4. The corporate name, address, and telephone number of the owner of the property;
5. Website address or phone number to contact for project information;
6. The corporate name and telephone number of the general contractor, or for a demolition site, the demolition contractor;
7. The statement, in both English and Spanish, “TO ANONYMOUSLY REPORT UNSAFE CONDITIONS AT THIS WORK SITE, CALL 311.”; and
8. A copy of the primary project permit, with accompanying text “To see other permits issued on this property, visit: www.nyc.gov/buildings.” The permit shall be laminated or encased in plastic covering to protect it from the elements or shall be printed directly onto the project information panel.

Exception: A rendering, elevation drawing, or zoning diagram of the building exterior is not required for demolition projects.

3301.9.1.2 Posting of project information panels. A project information panel shall be posted on the fence on each perimeter fronting a public thoroughfare. Where such perimeter is more than 150 feet (45 720 mm) in length, a project information panel shall be posted at each corner. Such panels shall be posted on the fence at a height of 4 feet (1219 mm) above the ground, with such distance measured from the ground to the bottom edge of the panel.

3301.9.1.3 Project information panel material. Project information panels shall be constructed out of a durable and weatherproof material such as vinyl, plastic, or aluminum, and such material shall be flame retardant in accordance with NFPA 701 or listed under UL 214.

3301.9.1.4 Project information panel specifications. Project information panels shall be 6 feet (1829 mm) wide and 4 feet (1219 mm) high, with the content required by Section 3301.9.1.1 arranged in accordance with Figures 3301.9.1.4(1) and 3301.9.1.4(2). The content required by Section 3301.9.1.1, Items 2 through 7, shall be written in the Calibri font or similar sans serif font style, with letters a minimum of 1 inch (25 mm) high, as measured by the upper case character. Such letters shall be white, on a blue background, with such blue color of a shade matching Pantone 296, or RGB 15, 43, 84, or CMYK 100, 88, 38, 35.

Exceptions:

1. The dimensions for a project information panel posted in conjunction with a demolition project shall be 2 feet 4 inches (711 mm) wide and 4 feet (1219 mm) high, in accordance with Figure 3301.9.1.4(1).
2. For construction sites with a street frontage less than 60 feet (18 288 mm), the dimensions for a project information panel, other than that posted in conjunction with a demolition project, shall be 55 inches (1397 mm) wide and 36.5 inches (927 mm) high, in accordance with Figure 3301.9.1.4(3).

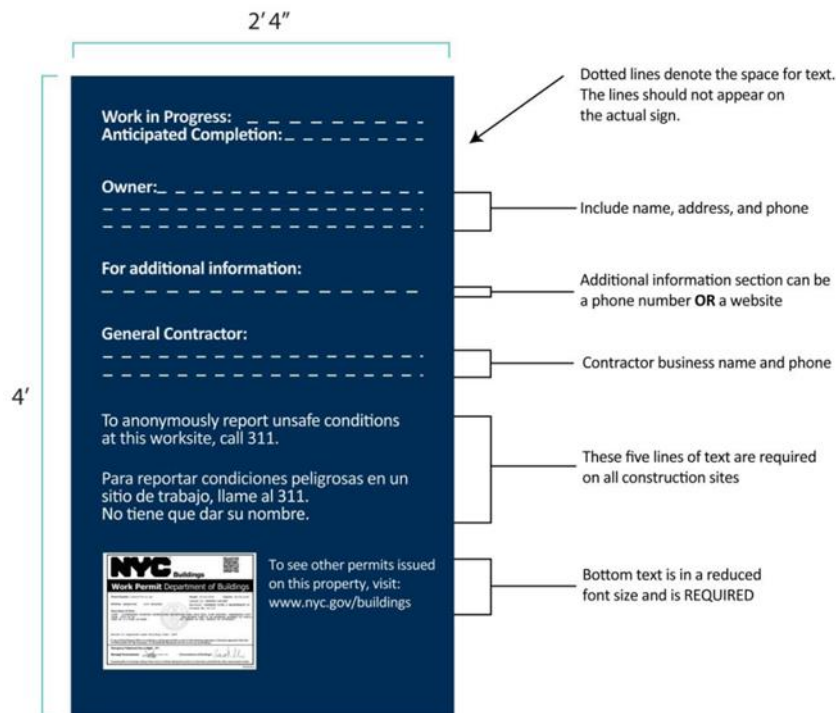

**FIGURE 3301.9.1.4(1)
FENCE PROJECT INFORMATION PANEL TEXT DETAIL**



**FIGURE 3301.9.1.4(2)
FENCE PROJECT INFORMATION PANEL LAYOUT**

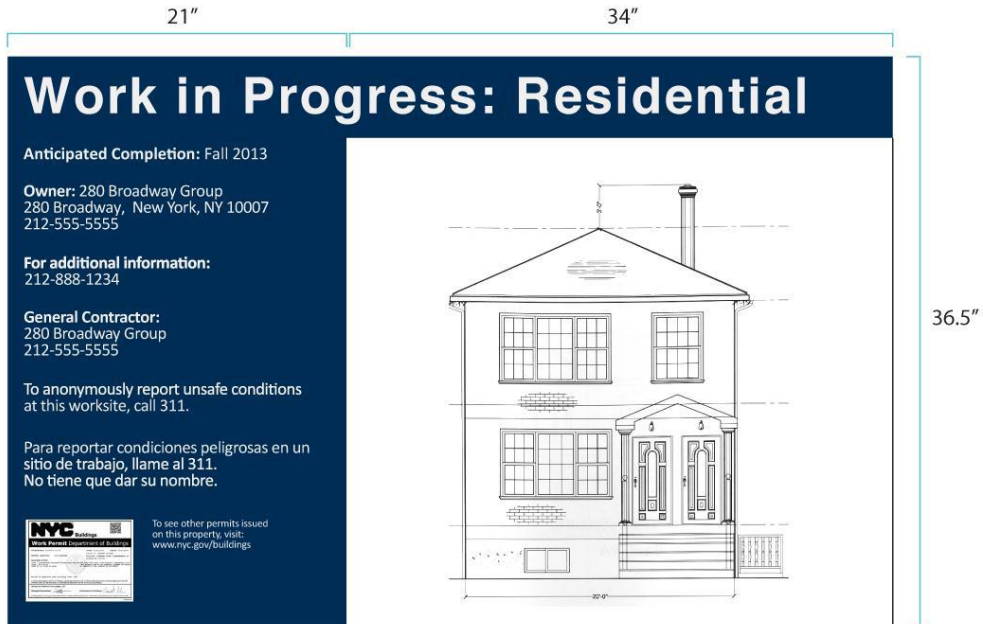

**FIGURE 3301.9.1.4(3)
FENCE PROJECT INFORMATION PANEL LAYOUT FOR SMALL LOTS**

3301.9.1.5 Updating content. When content required by Section 3301.9.1.1 changes, the project information panel shall be updated.

3301.9.1.6 Maintenance of project information panels. Project information panels shall be maintained so that the panel remains legible, securely attached, and free of sharp edges, protruding nails, or similar hazards. Content required by Section 3301.9.1.1 shall not be obscured by panel attachments, including but not limited to grommets or grommet holes.

3301.9.2 Sidewalk shed parapet information panel. Where a sidewalk shed is installed, a sidewalk shed parapet information panel meeting the requirements of Sections 3301.9.2.1 through 3301.9.2.6 shall be posted. Required sidewalk shed parapet information panels shall be in place throughout the duration that the sidewalk shed remains at the site.

[Exceptions:]

~~[1. At a site where the sidewalk shed permit was issued or renewed prior to July 1, 2013, signs meeting the requirement of Section 3301.9.4 may be posted in lieu of a sidewalk shed parapet panel. Such signs shall be removed and a sidewalk shed parapet panel in accordance with the requirements of this section installed upon date of the first permit renewal on or after July 1, 2013.]~~

~~[2. Signs posted at construction or demolition sites for one-, two- or three-family dwellings may comply with Section 3301.9.4 in lieu of this section.]~~

3301.9.2.1 Sidewalk shed parapet information panel content. Sidewalk shed parapet information panels shall ~~[comply with the requirements of either section 3301.9.2.1.1 or 3301.9.2.1.2., as applicable:]~~

~~**[3301.9.2.1.1 Sidewalk shed parapet panel content for sites not included in a best construction site management program.** Sidewalk shed parapet panels not included in a best construction site management program shall] contain the following information and be arranged in accordance with Figure 3301.9.2.1[(1)]:~~

- ~~1. The street address of the site;~~
- ~~2. Name (which may incorporate a logo) of the contractor responsible for the site or where there is no contractor, the name (which may incorporate a logo) of the owner of the site; and~~
- ~~3. The statement “For more information, visit www.nyc.gov/buildings.”~~

~~**[3301.9.2.1.2 Sidewalk shed parapet panel content for sites included in a best construction site management program.** In addition to the requirements of section 3301.9.2.1.1, for site maintained in accordance with a best construction site management program accepted by the commissioner as set forth in Section 3301.9.2.7, either the name or logo of such program, with the department’s program acceptance logo, may be placed on the sidewalk shed parapet panel in accordance with Figure 3301.9.2.1(2).]~~



FIGURE 3301.9.2.1(1)
SIDEWALK SHED PARAPET INFORMATION PANEL LAYOUT

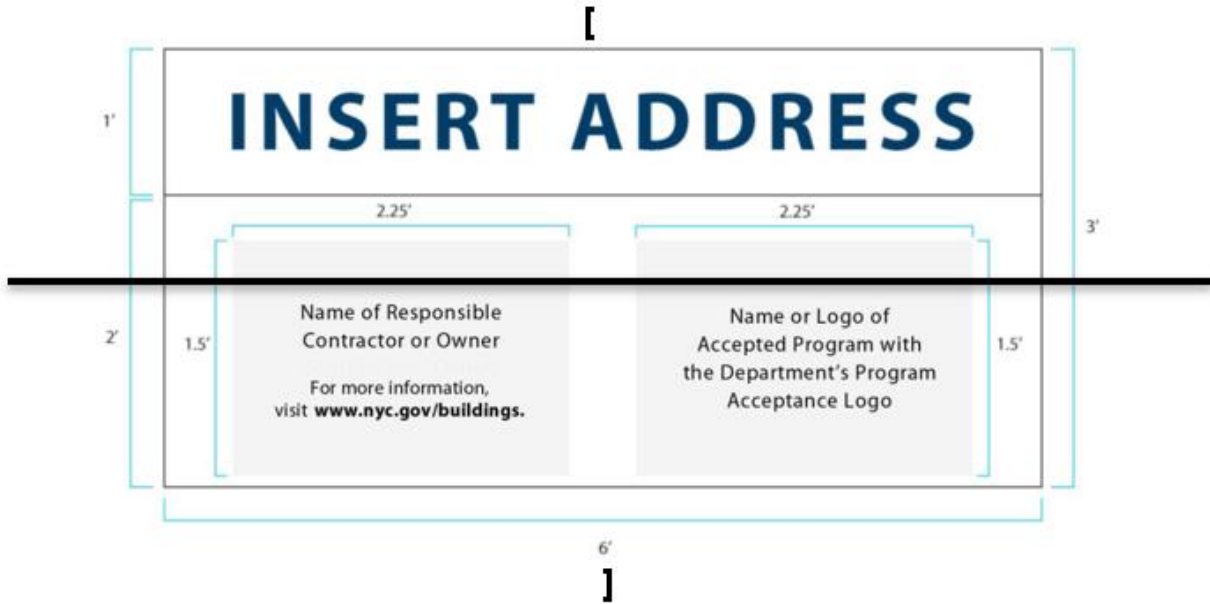

[FIGURE 3301.9.2.1(2)]
[SIDEWALK SHED PARAPET PANEL LAYOUT FOR ACCEPTED SITE MANAGEMENT PROGRAMS]

3301.9.2.2 Posting of sidewalk shed parapet information panels. Sidewalk shed parapet information panels shall be posted on the parapet that runs along the long axis of the sidewalk shed. Where a sidewalk shed extends along multiple street frontages, not including incidental extensions at a street corner, a parapet information panel shall be posted along each long axis. Such [~~sign~~] sidewalk shed parapet information panel:

1. Shall not be posted above or below the level of the parapet; and
2. [~~Shall be posted at least 3 feet (914 mm) and no more than 6 feet (1828 mm) from the left edge of the sidewalk shed parapet,~~] Shall be posted, as viewed from the perspective of an individual on the sidewalk opposite the long axis of the sidewalk shed and facing the sidewalk shed[~~;~~], in a location that is at least 3 feet (914 mm) but no more than 6 feet (1218 mm) to the right of the left edge of the sidewalk shed parapet, or where the sidewalk shed parapet extends beyond the projection of the property line, in a

location that is at least 3 feet (914 mm) but no more than 6 feet (1218 mm) to the right of the projection of the property line through the left side of the sidewalk shed; or

3. Where a project information panel in accordance with Section 3301.9.1 is posted on the fence, the horizontal center of the sidewalk shed parapet information panel shall be in line with a vertical plane drawn through the horizontal center of the project information panel [~~and the sidewalk shed parapet shall be posted~~] on the fence in accordance with Figure 3301.9.2.2.

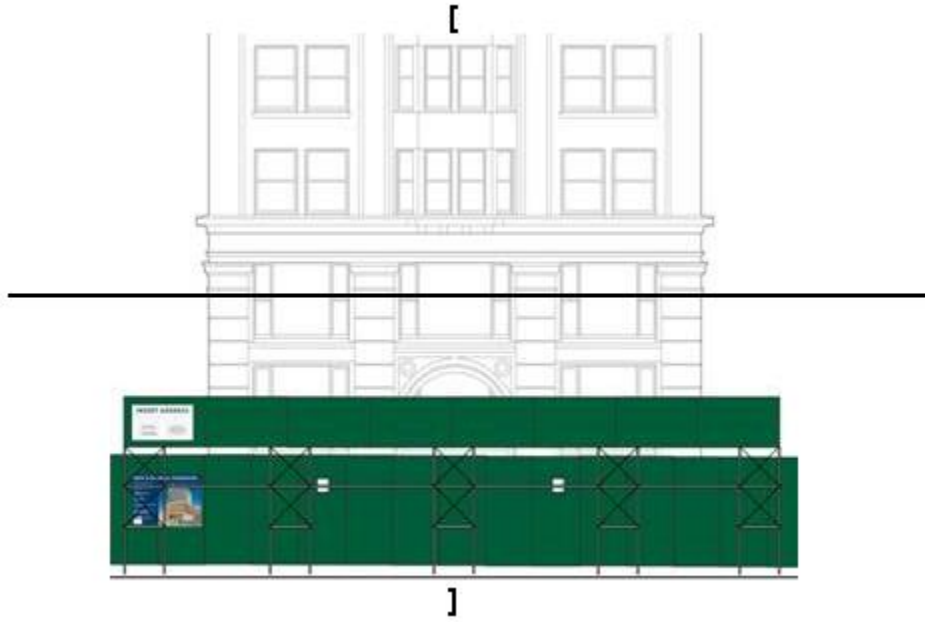



**FIGURE 3301.9.2.2
PANEL POSTING ELEVATION DIAGRAM**

3301.9.2.3 Sidewalk shed parapet information panel material. Sidewalk shed parapet information panels shall be constructed out of a durable and weatherproof material such as vinyl, plastic, or aluminum, and such material shall be flame retardant in accordance with NFPA 701 or listed under UL 214.

3301.9.2.4 Sidewalk shed parapet information panel specifications. Sidewalk shed parapet information panels shall be 3 feet (914 mm) high and 6 feet (1829 mm) wide, with the content required by Section 3301.9.2.1 arranged in accordance with [Figures 3301.9.2.1(1) or 3301.9.2.1(2)] Figure 3301.9.2.1. The sign shall have a white background. The content required by [~~item number 1 of~~] Section [3301.9.2.1.1] 3301.9.2.1 must be written in Calibri font or similar sans serif font style, and such letters shall be blue, with such blue color a shade matching Pantone 296, or RGB 15, 43, 84, or CMYK 100, 88, 38, 35.

3301.9.2.5 Updating content. When content required by Section 3301.9.2.1 changes, the sidewalk shed parapet information panel shall be updated.

3301.9.2.6 Maintenance of sidewalk shed parapet information panels. Sidewalk shed parapet information panels shall be maintained so that the panel remains legible, securely attached, and free of sharp edges, protruding nails, or similar hazards. Content required by Section 3301.9.2.1 shall not be obscured by sign attachments, including but not limited to grommets or grommet holes.

~~[3301.9.2.7 Best construction site management program. The department shall have the authority to create standards established by rule for the acceptance of a program that ensures best construction site management practices, and to set forth the basis and process for removal of such acceptance and for the removal of the program's name and logo from the sidewalk shed parapet panel located at a particular site.]~~

~~[3301.9.3 Existing fence signs and signs at construction or demolition sites for one-, two- or three-family dwellings. Where a site is enclosed with a fence in accordance with Section 3307.7, and a project information panel is not required in accordance with Section 3301.9.1, a sign or signs meeting the requirements of Section 3301.9.3.1 through 3301.9.3.3 shall be posted. Required signs shall be in place throughout the duration that the fence remains at the site.]~~

~~[3301.9.3.1 Sign content and posting. One or more signs needed to accommodate the following information shall be posted on the fence on each perimeter fronting a public thoroughfare at a height of no more than 12 feet (3658 mm) above the ground, with such distance measured from the ground to the top of the sign:]~~

~~[1. The name, address, and telephone number of the owner of the property;]~~

~~[2. The name, address, and telephone number of the general contractor, or for a demolition site, the demolition contractor; and]~~

~~[3. The statement, in both English and Spanish, "TO ANONYMOUSLY REPORT UNSAFE CONDITIONS AT THIS WORK SITE THAT ENDANGER WORKERS, CALL 311."]~~

~~[3301.9.3.2 Maintenance of fence signs. Fence signs shall be maintained so that the sign remains legible, securely attached, and free of sharp edges, protruding nails, or similar hazards.]~~

~~[3301.9.3.3 Fence sign specifications. Fence signs shall be constructed of 3/4 inch (19 mm) plywood or material of equivalent strength, durability and weatherproofing, including but not limited to sheet metal, aluminum, vinyl, or plastic. The letters on such signs shall be black on a white background. Such signs shall be no larger than that needed to accommodate the information required by Section 3301.9.3.1 in letters no less than 3 inches (76 mm) high.]~~

3301.9.3 Reserved.

~~[3301.9.4 Existing sidewalk shed signs and signs at construction or demolition sites for one-, two- or three-family dwellings. Where a sidewalk shed is installed, and a sidewalk shed parapet panel is not required in accordance with Section 3301.9.2, a sign readily visible from the street shall be posted on the parapet that runs along the long axis of the sidewalk shed. Such sidewalk shed sign shall be in place throughout the duration that the sidewalk shed remains at the site. Such sidewalk shed sign shall include:]~~

~~[1. The corporate name, address, and telephone number of the sidewalk shed permit holder;]~~

~~[2. The sidewalk shed permit number; and]~~

~~[3. The expiration date of the sidewalk shed permit.]~~

3301.9.4 Reserved.

3301.9.5 Other temporary signs required by law. ~~[Signs]~~ Other temporary signs required by law to be displayed at a construction or demolition site shall be posted within the site, readily visible to workers, and shall not be posted in any location readily visible to the public unless otherwise required by law.

3301.9.6 Obscured lawful signs. When a protective structure constructed in accordance with Section 3307 obscures from view a lawful and existing sign, a temporary sign may be posted on such protective structure. The temporary sign shall comply with the following requirements:

1. The temporary sign shall be securely fastened to the protective structure at a location directly in front of such business storefront;
2. The temporary sign shall be limited to a maximum height of 4 feet (1219 mm) and shall not exceed the square footage of the obscured lawful sign;
3. The temporary sign shall not project from the side or face of the protective structure;
4. When affixed to a sidewalk shed, the temporary sign shall not extend above or below the sidewalk shed parapet;
5. The temporary sign shall not be hung under the deck of a sidewalk shed or protective structure; and
6. Except where the sidewalk shed obscures a lawful projecting sign, the temporary sign shall not be placed on the end of a sidewalk shed that is perpendicular to the building.

3301.9.7 Other signs prohibited. Except as specified by Sections 3301.9.1 through 3301.9.6 or as otherwise authorized by law, no sign, information, pictorial representation, or any business or advertising message shall be posted on any construction or demolition equipment or temporary construction installation, including but not limited to, protective structures.

3301.9.8 Illuminated signs prohibited. No illuminated business or advertising sign shall be permitted on any construction or demolition equipment or temporary construction installation, including but not limited to, protective structures.

~~[**3301.10 Obscured lawful signs.** When a protective structure is constructed in accordance with Section 3307, a temporary sign may be posted on such protective structure when the structure is adjacent to any building and obscures from view a lawful and existing sign. The temporary sign shall comply with the following requirements:~~

- ~~[1. The temporary sign shall be securely fastened to the face of the protective structure at a location directly in front of such business storefront;~~

~~[2. No projecting temporary signs shall be permitted, and all temporary signs shall be limited to a maximum height of 4 feet (1219 mm), and when affixed to a sidewalk shed, shall not project above the parapet;]~~

~~[3. No temporary signs shall be permitted on the ends of any protective structure, unless the lawful and existing sign would otherwise be obscured from view by a deck or parapet of a sidewalk shed or bridge; and]~~

~~[4. No temporary signs shall project below the deck of any sidewalk shed.]~~

3301.10 Reserved.

3301.11 Site safety orientation and refresher. Each permit holder at a site that requires a site safety manager, site safety coordinator, or construction superintendent shall ensure that each construction or demolition worker employed or otherwise engaged at such site by the permit holder or performing subcontracted work for or on behalf of such permit holder receives a site safety orientation and refresher in accordance with the requirements of Sections 3301.11.1 through 3301.11.5.

3301.11.1 Site safety orientation. Each worker employed or otherwise engaged at such site by the permit holder or performing subcontracted work for or on behalf of such permit holder shall receive a site safety orientation before such worker commences any construction or demolition work at such site.

3301.11.2 Site safety refresher. Each worker employed or otherwise engaged at such site by the permit holder or performing subcontracted work for or on behalf of such permit holder shall receive a site safety refresher if such worker (i) has performed construction or demolition work at such site for one year or more and (ii) one year or more has elapsed since such worker received a site safety orientation or refresher with respect to such site.

3301.11.3 Site safety orientation and refresher to be conducted by qualified person. Site safety orientations and refreshers required by this section shall be conducted by a qualified person designated by the permit holder. Such qualified person shall have the ability to communicate with each worker who takes part in such orientation or refresher.

3301.11.4 Site safety orientation and refresher content. Site safety orientations and refreshers required by this section shall include a review of safety procedures at such site and any hazardous activities to be performed at such site. In addition, information pertaining to the site safety training required by Section 3321 shall be made available to each worker in the designated citywide languages, as such term is defined in Section 23-1101 of the *Administrative Code*, and any other language as may be required by rule of the department, in a form and manner established by the department.

3301.11.5 Records. A record of all orientations conducted for the site shall be maintained by the permit holder and kept at the site. Such record shall include for each such orientation or refresher:

1. The date and time of such orientation or refresher;
2. The name, title and company affiliations of each worker who participated; and

3. The name, title and company affiliation of the qualified person who conducted such orientation or refresher, along with such person's signature.

3301.12 Pre-shift safety meetings. Each permit holder at a site that requires a site safety manager, site safety coordinator, or construction superintendent shall ensure that each construction or demolition worker employed or otherwise engaged at such site by the permit holder or performing subcontracted work for or on behalf of such permit holder takes part in a safety meeting at the beginning of such worker's shift, but before such worker commences any construction or demolition work in such shift, in accordance with the requirements of Sections 3301.12.1 through 3301.12.3.

Exception: Where other sections of this code or rules promulgated thereunder specify pre-task or pre-shift meetings for specific types of work, those requirements shall instead apply.

3301.12.1 Pre-shift safety meeting to be conducted by a competent person. Pre-shift safety meetings shall be conducted at the beginning of each worker's shift, but before such worker commences any construction or demolition work in such shift, by a competent person designated by the permit holder, or where so authorized by the permit holder, by a competent person designated by the subcontractor. Such competent person shall have the ability to communicate with each worker who takes part in such meeting.

3301.12.2 Pre-shift safety meeting content. The pre-shift safety meeting shall include a review of activities and tasks to be performed during the shift, including specific safety concerns or risks associated with fulfilling such work.

3301.12.3 Records. The permit holder shall maintain, for each worker, a record of one pre-shift safety meeting per week. Such record shall include for each such meeting:

1. The date and time of each such meeting;
2. The name, title and company affiliation of each worker who participated; and
3. The name, title and company affiliation of the competent person who conducted such meeting, along with such person's signature.

3301.13 Scope. This section sets forth requirements for construction superintendents at certain construction or demolition sites.

3301.13.1 Site safety plan. For jobs that require the designation of a primary construction superintendent pursuant to Section 3301.13.3, a site safety plan that meets the applicable requirements of Article 110 of Chapter 1 of Title 28 of the *Administrative Code* shall be kept on site and made available to the department upon request.

3301.13.2 Definitions. For the purposes of this section, the following terms shall have the following meanings:

Approved documents. For the purpose of this section, approved documents include construction documents as defined by this code, and any and all documents that set forth the location and entire nature and extent of the work proposed with sufficient clarity and detail to show that the proposed work conforms to the provisions of this code and other applicable laws

and rules. In addition to construction documents, such documents include, but are not limited to, shop drawings, specifications, manufacturer's instructions and standards that have been accepted by the design professional of record or such other design professional retained by the owner for this purpose.

~~[**Construction superintendent.** An individual registered with the department and responsible for all duties as defined in this section.]~~

Job. A design and construction/demolition undertaking consisting of work at one building or structure, as well as related site improvements and work on accessory structures. A job may consist of one or more plan/work applications, and may result in the issuance of one or more permits.

Permit holder. The individual who receives the primary department-issued permit for the job.

3301.13.3 Designation of primary construction superintendent. The permit holder shall designate a primary construction superintendent, and notify the department of such designation, prior to the commencement of work, ~~[in a form and manner acceptable to the department,]~~ for the following types of jobs:

1. The construction of a new building;
2. The full demolition of an existing building;
3. An alteration to an existing building that involves one or more of the following:
 - 3.1 A vertical enlargement;
 - 3.2 A horizontal enlargement;
 - 3.3 The alteration or demolition of more than 50 percent of the gross floor area of the building during the course of work over any ~~[12-month]~~ 12-month period;
 - 3.4 The removal of one or more floors during the course of work over any ~~[12-month]~~ 12-month period;
 - 3.5 Work that requires a special inspection for underpinning; or
 - 3.6 Work that requires a special inspection for the protection of sides of excavations; or
4. Other jobs that pose an enhanced risk to the public and property, as determined by the commissioner.

Exceptions: Notwithstanding the above, a construction superintendent is not required for:

1. Work listed in Section 3310.1, for which a site safety manager or coordinator must be designated.
2. Work which solely involves the construction of a new 1-, 2-, or 3-family building.

3301.13.4 Change of designation. The permit holder must immediately notify the department[~~in a form and manner acceptable to the department,~~] of any permanent change to the primary construction superintendent.

3301.13.5 Alternate construction superintendent. In the event the primary construction superintendent is temporarily unable to perform their duties, an alternate construction superintendent, designated by the permit holder [~~and acceptable to and acting on behalf of the primary construction superintendent,~~] must [~~fulfill the duties of the primary construction superintendent~~] act in place of the primary construction superintendent and carry out all duties and responsibilities assigned to the construction superintendent by this chapter and rules promulgated by the commissioner. In the event that an alternate construction superintendent will be acting in place of the primary construction superintendent for a period longer than two consecutive weeks, the permit holder must notify the department[~~in a form and manner acceptable to the department,~~]-of such [~~change~~] circumstance.

3301.13.6 Limitations on the designation of primary or alternate construction superintendents. An individual may only be designated as a primary or alternate construction superintendent for that number of jobs for which he or she can adequately perform all required duties. No individual may be designated as the primary construction superintendent on more than ten jobs.

3301.13.7 Duties of construction superintendents. The duties of a construction superintendent shall include:

1. Acting in a reasonable and responsible manner to maintain a safe job site and [~~assure~~] ensure compliance with this chapter and any rules promulgated thereunder at each job site for which the construction superintendent is responsible;
2. To the extent that a registered design professional or special inspection agency is not responsible, the construction superintendent must [~~assure~~] ensure compliance with the approved documents at each job site for which the construction superintendent is responsible;
3. Fulfilling the duties of a superintendent of construction assigned by Chapter 1 of Title 28 of the *Administrative Code* at each job site for which the construction superintendent is responsible; and
4. Visiting each job site for which the construction superintendent is responsible each day when active work is occurring.

Exception: The construction superintendent is not required to be present at the site during the following activities, provided no other work is in progress:

1. Surveying that does not involve the disturbance of material, structure, or earth;
2. Use of a hoist exterior to the building to transport personnel only;

3. Use of a [~~material~~] hoist that is fully enclosed within the perimeter of the building to transport personnel or material;
4. [~~Finish trowelling of concrete floors;~~] Work limited to finish troweling of concrete floors;
5. [~~When personnel are provided for temporary heat, light, or water~~] Work limited to providing the site with temporary heat, light, or water; or
6. [~~Truck deliveries to the site where the sidewalk is closed and the entrance gate is within that closed sidewalk area.~~] Truck deliveries to the site, provided the delivery occurs within the site while the gate is closed and flagpersons are provided to direct traffic while the truck is entering and exiting the site.

3301.13.8 Inspection. Each time the construction superintendent visits a job site for which he or she is responsible, the construction superintendent must inspect all areas and floors where construction or demolition work, and ancillary activity, is occurring, and:

1. Verify work is being conducted in accordance with sound construction/demolition practices;
2. Verify compliance with the approved documents; and
3. Verify compliance with this [~~section~~] chapter and any rules promulgated thereunder.

3301.13.9 Correcting unsafe conditions. In the event the construction superintendent discovers work at a job site for which he or she is responsible that is not being conducted in accordance with sound construction/demolition practices, not in compliance with approved documents, or not in compliance with this [~~section~~] chapter and any rules promulgated thereunder, the construction superintendent must immediately notify the person or persons responsible for creating the unsafe condition, order the person or persons to correct the unsafe condition, and take all appropriate action to ensure the unsafe condition is corrected. Where an unsafe condition relates to an item which a registered design professional or special inspection agency is responsible for implementing or verifying, the construction superintendent must also notify the responsible registered design professional or special inspection agency of the unsafe condition. All such unsafe conditions, notices, orders, and corrective work must be recorded in the log required by Section 3301.13.13.

3301.13.10 Notification of conditions to the department. The construction superintendent must immediately notify the department[~~, in a form and manner acceptable to the department,~~] when he or she discovers, at any job site for which the construction superintendent is responsible, any of the conditions listed in Section 3310.8.2.1. Notification to the department does not relieve the construction superintendent of their obligations under Section 3301.13.9.

3301.13.11 Reporting of [~~accidents~~] incidents and damage to adjoining property. The construction superintendent must immediately notify the department[~~, in a form and manner acceptable to the department,~~] of any [~~accident~~] incident at any job site for which the construction

superintendent is responsible, or any damage to adjoining property caused by construction or demolition activity at the job site.

3301.13.12 Competent person. The construction superintendent must designate a competent person for each job site for which the construction superintendent is responsible and ensure such competent person is present at the designated job site at all times active work occurs. The designation of a competent person does not alter or diminish any obligation imposed upon the construction superintendent. The competent person must carry out orders issued by the construction superintendent; be able to identify unsanitary, hazardous or dangerous conditions; take prompt corrective measures to eliminate such conditions; immediately report to the construction superintendent [~~accidents~~] incidents at the job site or any damage to adjoining property caused by construction or demolition activity at the job site; and be able to effectively communicate workplace instructions and safety directions to all workers at the site.

3301.13.13 Log. The construction superintendent must maintain a log at each job site for which the construction superintendent is responsible. Such log must be made available to the commissioner upon request. The construction superintendent must complete such log prior to departing the job site and shall sign and date each day's log entry. [~~Such log must be organized and recorded in a form and manner acceptable to the department.~~] Such log must contain, at a minimum, the following information:

1. The presence of the construction superintendent at the job site as evidenced by their printed name and signature and a notation indicating the times of arrival at, and departure from the site, which must be recorded immediately after arriving at the site and immediately prior to leaving the site, respectively;
2. The general progress of work at the site, including a summary of that day's work activity;
3. The construction superintendent's activities at the site, including areas and floors inspected;
4. Any unsafe condition(s) observed pursuant to Section 3301.13.9, and the time and location of such unsafe condition(s);
5. Orders and notice given by the construction superintendent pursuant to Section 3301.13.9, including the names of individuals issued orders or notices, any refusals to comply with orders or respond to notices given, follow up action taken by the construction superintendent, and where the condition giving rise to the order or notice is corrected, the nature of the correction;
6. Any violations, stop work orders, or summonses issued by the department, including date issued and date listed or dismissed;
7. Any [~~accidents~~] incidents or damage to adjoining property caused by construction or demolition activity at the site; and
8. The name of the competent person designated in accordance with Section 3301.13.12, along with an accompanying signature of the competent person. If the construction

superintendent assigns a new competent person, the date and time of this change, along with the name of the new competent person, must be recorded, accompanied by the signature of the new competent person. If the construction superintendent is not at the site when this occurs, the new competent person must instead make the log entry, which the construction superintendent must sign and date upon his or her next visit to the job site.

3301.13.14 [~~Disciplinary actions. Construction superintendents are subject to the provisions of Section 28 401.19 of the *Administrative Code*.~~] **Reserved.**

3301.13.15 [~~Cooperation required. Construction superintendents must comply with the provisions of Section 28 401.20 of the *Administrative Code*.~~] **Reserved.**

3301.13.16 Obligation of others. Nothing in this [~~rule~~] section is intended to alter or diminish any obligation otherwise imposed by law on others, including but not limited to, the owner, permit holder, construction manager, general contractor, contractor, materialman, architect, engineer, land surveyor, site safety manager, site safety coordinator, concrete safety manager, or other party involved in a construction project to engage in sound engineering, design, and construction practices, and to act in a reasonable and responsible manner to maintain a safe job site.

~~[3301.13.17 Registration and qualifications of construction superintendents. Construction superintendents shall register with the department, in a form and manner acceptable to the department, and shall meet any qualifications set forth in rules by the department.]~~

3301.13.17 Licensing of construction superintendents. No person shall perform the duties and responsibilities of a construction superintendent, including but not limited to serving as a primary construction superintendent or as an alternate construction superintendent, unless such person is licensed as a construction superintendent in accordance with Article 428 of Title 28 of the *Administrative Code*.

3301.13.18 Release of the construction superintendent. The department may release the construction superintendent from the job when the construction superintendent demonstrates, to the satisfaction of the commissioner, that the job is substantially complete.

3301.14 Contractor shall inform personnel. General contractors and subcontractors shall state to their directly employed personnel at the construction or demolition site, prior to such directly employed person commencing work at the site, that they are to follow all safety regulations at all times and that they are required to obey and implement all orders and directives issued by the general contractor/subcontractor, the general contractor's/subcontractor's designee, the construction superintendent, and the worker's direct supervisor relating to safety requirements. Where a site safety manager or coordinator is required, the general contractor or subcontractor shall also state to their directly employed personnel at the site, prior to such directly employed person commencing work at the site, that the site safety manager or coordinator is responsible for monitoring compliance with laws and rules governing site safety; and shall inform their supervisory personnel at the site, prior to such supervisor commencing work at the site, of the name and responsibilities of the site safety manager or coordinator.

§ 33. Section BC 3302, as amended by local law number 141 for the year 2013, section 3302.1 as amended by local law number 219 for the year 2019, local law number 119 for the

year 2019, local law number 3 for the year 2018, and local law number 196 for the year 2017, is amended to read as follows:

SECTION BC 3302 DEFINITIONS

3302.1 Definitions. The following [~~words and terms shall, for the purposes of this chapter, have the following meanings:.~~] terms are defined in Chapter 2:

100-HOUR TRAINING PROGRAM. [~~A program that (i) includes 100 or more hours of training in technical subjects relating to a construction trade, including an apprenticeship program registered with the New York State Department of Labor, (ii) is approved by OSHA, the United States Department of Labor, the New York State Department of Education or the New York State Department of Labor and (iii) provides training that the department determines is equivalent to or exceeds the training required to comply with Section 3321.~~]

[~~**ACCIDENT.** An occurrence directly caused by construction or demolition activity or site conditions that result in one or more of the following:~~

- ~~8. A fatality to a member of the public; or~~
- ~~9. Any type of injury to a member of the public; or~~
- ~~10. A fatality to a worker; or~~
- ~~11. An injury to a worker that requires transport by emergency medical services or requires immediate emergency care at a hospital or offsite medical clinic; or~~
- ~~12. Any complete or partial structural collapse or material failure; or~~
- ~~13. Any complete or partial collapse or failure of pedestrian protection, scaffolding, hoisting equipment, or material handling equipment; or~~
- ~~14. Any material fall exterior to the building or structure.]~~

ACTIVELY PROCTORED ONLINE TRAINING. [~~Online training that satisfies each of the following conditions:~~

- ~~[1. The person responsible for conducting such training confirms the identification of the person taking such training in a manner established by the department.]~~
- ~~[2. While such training is being conducted, the site of such training is actively observed by or on behalf of the person responsible for conducting such training.]~~
- ~~[3. Such training complies with any other requirements the department establishes by rule.]~~

ADJUSTMENT (SCAFFOLD). [~~The calibration or modification of a scaffold, including any part or component, that does not meet the definition of installation, removal, repair, maintenance, or use, and does not constitute normal use or operation of the scaffold.]~~

[**ALTERATION.** See Section 28-101.5 of the *Administrative Code*.]

[**ARCHITECT.** See Section 28-101.5 of the *Administrative Code*.]

ARTICULATING BOOM CRANE. [A power-operated machine for lifting or lowering a load and moving it horizontally that utilizes a boom consisting of a series of folding pin-connected structural members, typically manipulated to extend or retract by power from hydraulic cylinders, with or without a hoisting mechanism integral to the machine.]

AXIS OF ROTATION. [The vertical axis around which the crane superstructure rotates.]

AXLE. [The shaft or spindle with which or about which a wheel rotates. On truck and wheel-mounted cranes, it refers to an automotive type of axle assembly, including housing, gearing, differential, bearings and mounting appurtenances.]

BASE (MOUNTING). [The base or carrier on which the rotating superstructure is mounted, such as a truck, crawler or platform.]

BEARER (PUTLOG). [A horizontal transverse scaffold member (which may be supported by legs or runners) upon which the scaffold platform rests and joins scaffold uprights, posts, poles, and similar members.]

BOOM (CRANE OR DERRICK). [A section or strut, of which the heel (lower end) is affixed to a base, carriage or support, and whose upper end supports a cable and sheaves where the load is lifted by means of wire rope and a hook.]

BOOM POINT. [The outward end of the top section of the boom, containing the hoist sheave assembly.]

BRAKE. [A device used for retarding or stopping motion by friction or power means.]

BUCKET HOIST. [A power or manually operated suspended bucket contained by guide rails used for raising or lowering material, exclusively and is controlled from a point outside the conveyance.]

CABLEWAY. [A power-operated system for moving loads in a generally horizontal direction in which the loads are conveyed on an overhead cable, track or carriage.]

CEMENTED SOIL (CHAPTER 33).

CERTIFICATE OF APPROVAL. [A certificate issued by the department upon review and approval of the engineering and testing of a specific make and model of hoisting equipment to ensure compliance with the applicable provisions of this code and its referenced standards.]

CERTIFICATE OF OPERATION. [A certificate issued by the department annually upon satisfactory inspection of the hoisting equipment holding a certificate of approval to ensure that the equipment continues to be in compliance with this code and its referenced standards.]

CERTIFICATE OF ON-SITE INSPECTION. [A certificate issued by the department based on a site-specific approval of the placement, founding and operation of hoisting equipment.]

CLAMSHELL. [A shovel bucket with two jaws that clamp together by their own weight when it is lifted by a closing line.]

CLIMBER CRANE.

[~~CLIMBING/JUMPING.~~ The raising or lowering of a tower or climber crane to different floors or levels of a building or structure.]

COHESIVE SOIL (CHAPTER 33).

COMMERCIAL TRUCK MOUNTED CRANE (BOOM TRUCK). [A crane consisting of a rotating superstructure (center post or turntable), boom, operating machinery, and one or more operator's stations mounted on a frame attached to a commercial truck chassis, usually retaining a payload hauling capability whose power source usually powers the crane. Its function is to lift, lower, and swing loads at various radii.]

COMPETENT PERSON. [One who is capable of identifying existing and predictable hazards in the surroundings or conditions that are unsanitary, hazardous or dangerous, and who has authorization to take prompt corrective measures to eliminate such hazards.]

COMPLETED STEEL FLOOR (CHAPTER 33).

CONCRETE WASHOUT WATER. [Wastewater from the rinsing of equipment used to mix, transport, convey, and/or place concrete. Such equipment shall include, but not be limited to, concrete buckets, concrete hose lines and pumps, boots, shovels, finishing tools, wheelbarrows, motorized concrete carts, concrete pour funnels and the chute of concrete mixer trucks.]

[Exceptions:

1. This term shall not include wastewater from the rinsing of equipment involved in the preparation, conveyance or application of concrete that is:
 - 1.1. mixed on site if the total quantity of concrete is less than or equal to one and one half cubic yards (1.146m³), or
 - 1.2. from bagged ready mix if the total quantity of concrete is less than or equal to sixty (60) eighty pound (36.287 kg) bags, or eighty (80) sixty pound (27.215 kg) bags, or the equivalent.
2. This term shall not include wastewater from the rinsing of the wheels, undercarriage or chassis of concrete mixer trucks.]

CONSTRUCTION. [The excavation, erection, alteration, and repair of buildings or any component parts, including all operations incidental thereto.]

CORNER SCAFFOLD (ANGLE SCAFFOLD). [A suspended scaffold consisting of an assembly of two or more platforms connected nonlineraly and designed and manufactured to fit around a corner or a projecting part of a building.]

COUNTERWEIGHT. [~~Weight used to supplement the weight of the machine in order to provide stability for lifting loads.~~]

CRANE. [~~A power operated machine for lifting or lowering a load and moving it horizontally which utilizes wire rope and in which the hoisting mechanism is an integral part of the machine. The definition of a crane shall also include articulating boom crane, regardless of whether it has a hoisting mechanism integral to the machine.~~]

CRAWLER CRANE. [~~A crane consisting of a rotating superstructure with a power plant, operating machinery, and boom, mounted on a base and equipped with crawler treads for travel. Its function is to lift, lower, and swing loads at various radii.~~]

CRITICAL PICK. [~~The attachment and detachment of loads from the hook of hoisting equipment used to hoist or lower loads on the outside of a building that involves one or more of the following:~~

- ~~1. An article that is at or above 95 percent of approved rated capacity of the hoisting equipment or rigging equipment;~~
- ~~2. An article that is asymmetrical and is not provided with standard rigging ears;~~
- ~~3. An article that has a wind sail area exceeding 500 square feet (46 m²);~~
- ~~4. A pick that may present an added risk because of clearance, drift, or other interference;~~
- ~~5. An article that is fragile or of thin shell construction and is not provided with standard rigging ears;~~
- ~~6. A pick that requires multiple power operated hoisting equipment (tandem pick); or~~
- ~~7. A pick that requires out of the ordinary rigging equipment, methods, or setup.]~~

CURB LEVEL.

DEBRIS. [~~Rubbish, waste, discarded material, or the remains of something broken down, demolished, or destroyed.~~]

DEBRIS NET or NETTING. [~~A netting of a fine mesh of a size and strength sufficient to catch debris, such as falling tools and materials.~~]

DEDICATED PILE DRIVER.

DEMOLITION. [~~Full or partial demolition.~~]

Full demolition. [~~The dismantling, razing, or removal of all of a building or structure, including all operations incidental thereto.~~]

Partial demolition. [~~The dismantling, razing, or removal of structural members, floors, interior bearing walls, and/or exterior walls or portions thereof, including all operations incidental thereto.~~]

DERRICK. [~~An apparatus consisting of a mast or equivalent member held at the end by guys or braces, with or without a boom, for use with a hoisting mechanism and operating ropes, for lifting or lowering a load and moving it horizontally.~~]

DEWATERING. [~~The removal of surface or ground water from a site by pumping or evaporation.~~]

DIRECT AND CONTINUING SUPERVISION. [~~See Section 28-401.3 of the *Administrative Code*.~~]

DIRECT EMPLOY. [~~See Section 28-401.3 of the *Administrative Code*.~~]

DISMANTLING. [~~The final process of taking apart, piece by piece, in a specific sequence, the components of a crane. Dismantling shall include climbing and jumping.~~]

DRUM. [~~The cylindrical member around which a rope is wound for raising and lowering the load or boom.~~]

DRY (SOIL, CHAPTER 33).

[~~**ENGINEER.** See Section 28-101.5 of the *Administrative Code*.~~]

EQUIPMENT. [~~Implements used to facilitate construction or demolition work.~~]

ERECTION. [~~The assembly and placement of crane sections and components into place, including all operations incidental thereto. Erection shall include climbing and jumping.~~]

EXCAVATION. [~~The removal of earth from its natural position; except for any incidental removal that occurs during the course of auguring, drilling, vibrating, or driving.~~]

FISSURED (SOIL, CHAPTER 33).

GRANULAR SOIL (CHAPTER 33).

GUARDRAIL SYSTEM (SCAFFOLD). [~~A vertical barrier as described in Section 3314.8 consisting of, but not limited to, toprails, midrails and posts, erected to prevent falling from a scaffold platform or walkway to lower levels.~~]

GUY. [~~A rope used to steady or secure the mast or other members in the desired position.~~]

HANDHELD DEVICE (DEMOLITION). [~~Equipment, mechanical or non-mechanical, utilized to physically demolish a building or structure, or elements of a building or structure, that is held, lifted, moved, and operated by a single person. A handheld device shall also include any item accessory to such equipment, including but not limited to a compressor, regardless of if such accessory item is held, lifted, moved, and operated by a single person. A handheld device does not include remote controlled equipment.~~]

HEAVY DUTY SCAFFOLD. [~~A supported scaffold capable of supporting loads of up to 75 pounds per square foot (366.15 kg/m²), and not more than those imposed by workers and heavy material, including but not limited to stone.~~]

HEAVY DUTY SIDEWALK SHED. [A sidewalk shed designed to carry a live load of at least 300 pounds per square foot (1465 kg/m²).]

HISTORIC STRUCTURE. [A building or structure which is a designated New York City landmark or interior landmark, is located within a designated New York City historic district, or is listed on the New York State or National Register of Historic Places.]

HOISTING EQUIPMENT. [Equipment used to raise and lower personnel and/or material with intermittent motion. Hoisting equipment does not include scaffolds, mast climbers, and elevators.]

HOISTING MACHINE. [A power-operated machine used for lifting or lowering a load, utilizing a drum and a wire rope, excluding elevators. This shall include but not be limited to a crane, derrick, cableway and hydraulic lifting system, and articulating booms.]

HOISTING MECHANISM. [A hoist drum and rope reeving system used for lifting and lowering loads.]

INDUSTRIAL ROPE ACCESS. [The use of rope access equipment in which a person descends or ascends on a rope, or traverses along a rope, and in which the ropes are used as the primary means of support and positioning. Industrial rope access does not include window washing.]

INCIDENT.

INSTALLING/INSTALLATION/INSTALL (SCAFFOLD). [The initial installation or reinstallation of a scaffold at a site.]

Initial installation (scaffold). [The initial assembly, set up, or placement of a scaffold at a site.]

Reinstallation (scaffold). [The addition, relocation, or removal of any part, component, or attachment to a scaffold at a site, including but not limited to counterweights, tie-backs, anchorages, or connections to the building or structure, that occurs subsequent to the initial installation, and which does not otherwise occur in an automated, automatic fashion, as part of the normal use of the scaffold.]

JIB. [An extension attached to the boom point to provide added boom length for lifting specified loads. The jib may be in line with the boom or offset to various angles in the vertical plane of the boom.]

JUMP (JUMPING or CLIMBING). [The process of adding or removing mast or tower sections to equipment that has already been erected.]

[LAY. That distance measured along a wire rope in which one strand makes one complete helical convolution about the core or center.]

LAYERED (SOIL, CHAPTER 33).

LIGHT DUTY SCAFFOLD. [A supported scaffold capable of supporting loads of up to 25 pounds per square foot (122.05 kg/m²), and not more than those imposed by workers and lightweight material, including but not limited to wood or paint.]

LIGHT DUTY SIDEWALK SHED. [~~A sidewalk shed designed to carry a live load of at least 150 pounds per square foot (732.3 kg/m²).~~]

LIMITED SITE SAFETY TRAINING (SST) CARD. [~~A card that is issued before the SST full compliance date, in a form and manner established by the department and that satisfies each of the following conditions:~~]

~~[1. Such card is issued by an SST provider to a person who submits an application to such provider demonstrating, in a form and manner established by the department, that such applicant satisfies the requirements of Item 1.1, 1.2 or 1.3:]~~

~~[1.1. Such applicant has successfully completed (i) an OSHA 10 hour class and (ii) 20 additional SST credits specified by the department, including eight SST credits relating to safeguarding against the dangers posed by falling workers and objects.]~~

~~[1.2. Such applicant has successfully completed an OSHA 30 hour class.]~~

~~[2. If such applicant completed the training to comply with Item 1.1, 1.2 or 1.3 but did not complete such training within the five years preceding submission of such application, such applicant has, in the one-year period preceding submission of such application, completed at least eight SST credits specified by the department.]~~

~~[3. Such card is issued by an SST provider who does not require applicants to submit any information except for (i) the information necessary to establish that the requirements in Item 1 have been satisfied, as specified by the department, (ii) a photograph of the applicant and (iii) such additional information as the department may allow by rule.]~~

~~[4. Such card expires on the day before the SST full compliance date and is not renewable.]~~

LOAD BLOCK, LOWER.

LOAD BLOCK, UPPER.

LOAD RATINGS. [~~Crane and derrick ratings in pounds (kilograms) established by the manufacturer in accordance with standards set forth in rules promulgated by the commissioner.~~]

LOAD RATING CHART. [~~A full and complete range of manufacturer's crane load ratings at all stated operating radii, boom angles, work areas, boom lengths and configurations, jib lengths and angles (or offset), as well as alternative ratings for use and nonuse of optional equipment on the crane, such as outriggers and extra counterweights, that affect ratings.]~~]

LOAD (WORKING). [~~The external load, in pounds (kilograms), applied to the crane or derrick, including the weight of auxiliary load attaching equipment, such as lower load blocks, shackles and slings.]~~]

~~**[LOWER LOAD BLOCK.** The assembly of hook or shackle, swivel, sheaves, pins and frame suspended by the hoisting ropes.]~~

MAINTENANCE (SCAFFOLD). [~~Regular or periodic upkeep as specified by the manufacturer to keep the scaffold, including all parts or components, in like new condition and safe working order, and that does not otherwise meet the definition of an installation, removal, or repair.~~]

MAJOR BUILDING. [~~An existing or proposed building 10 or more stories or 125 feet (38 100 mm) or more in height, or an existing or proposed building with a building footprint of 100,000 square feet (30 480 m²) or more regardless of height, or an existing or proposed building so designated by the commissioner due to unique hazards associated with the construction or demolition of the structure.~~]

MANUFACTURE DATE [~~(Crane)~~ (CRANE). [For a particular crane, the earlier of the following dates:]

[~~1. The date the crane was originally manufactured for its intended purpose.~~]

[~~2. The date that the oldest major component of the crane was originally manufactured.~~]

MAST CLIMBER. [~~A powered device consisting of an elevating platform mounted on a base or chassis and mast, that when erected is capable of supporting personnel, material, equipment and tools on a deck or platform that is capable of traveling vertically in infinitely adjustable increments to reach the desired work level.~~]

MATERIAL HANDLING EQUIPMENT. [~~A power or manually operated platform, bucket, car or cage that moves horizontally and is mainly used for transporting material during construction, alteration, repair or demolition of a building or structure.~~]

MATERIAL HOIST (MATERIAL HOISTING EQUIPMENT). [~~A power or manually operated platform, bucket, car or cage that moves vertically and is used for raising or lowering material exclusively during construction, alteration, repair or demolition of a building or structure, and is controlled from a point outside the conveyance.~~]

MECHANICAL DEMOLITION EQUIPMENT. [~~Mechanically driven or powered equipment that is utilized to physically demolish a building or structure, or elements of a building or structure, either within or exterior to the building or structure, or that is utilized to move debris or material within the building or structure. Mechanical demolition equipment shall not include mechanically driven or powered equipment that is utilized to move debris or material outside of the building or structure.~~]

MEDIUM DUTY SCAFFOLD. [~~A supported scaffold capable of supporting loads of up to 50 pounds per square foot (244.1 kg/m²), and not more than those imposed by workers and moderate material, including but not limited to brick and pipe.~~]

[~~MINOR ALTERATIONS.~~ See Section 105.4.2 of the *Administrative Code*.]

MOBILE CRANE. [~~A commercial truck mounted crane, crawler crane, wheel mounted crane (multiple control stations), or wheel mounted crane (single control station).~~]

MOBILE SCAFFOLD. [~~A powered or unpowered, portable, caster, track or wheel mounted supported scaffold.~~]

MOIST (SOIL, CHAPTER 33).

MULTIPOINT ADJUSTABLE SUSPENDED SCAFFOLD. [~~A suspended scaffold consisting of a platform(s) that is suspended by more than two ropes from overhead supports and equipped with a means to raise and lower the platform to the desired work levels.~~]

ORDINARY REPAIRS. [~~See Section 105.4.2 of the *Administrative Code*.~~]

OSHA. [~~The United States Department of Labor Occupational Safety and Health Administration.~~]

OSHA 10-HOUR CLASS. [~~A class that includes 10 or more hours in construction industry safety and health that is intended for workers and satisfies the following conditions:~~]

[~~1. Such class is (i) approved by OSHA and conducted in accordance with the OSHA outreach training program or (ii) an equivalent 10 or more hour class approved by the department.~~]

[~~2. Such class consists of in-person training, actively proctored online training or, if such training is conducted before the effective date of the local law that added this definition, online training.~~]

OSHA 30-HOUR CLASS. [~~A class that includes 30 or more hours in construction industry safety and health that is intended for supervisors and satisfies the following conditions:~~]

[~~1. Such class is (i) approved by OSHA and conducted in accordance with the OSHA outreach training program or (ii) an equivalent 30 or more hour class approved by the department.~~]

[~~2. Such class consists of in-person training, actively proctored online training or, if such training is conducted before the effective date of the local law that added this definition, online training.~~]

OUTRIGGER (CRANE). [~~Extendable or fixed members attached to the mounting base that rest on supports at the outer ends used to support the crane.~~]

OUTRIGGER (SCAFFOLD). [~~The structural member of a supported scaffold used to increase the base width of a scaffold in order to provide support for and increased stability of the scaffold.~~]

OUTRIGGER BEAM (THRUSTOUT). [~~The structural member of a suspended scaffold or outrigger scaffold that provides support for the scaffold by extending the scaffold point of attachment to a point out and away from the structure or building.~~]

OUTRIGGER SCAFFOLD. [~~A supported scaffold consisting of a platform resting on outrigger beams (thrustouts) projecting beyond the wall or face of the building or structure, the inboard ends of which are secured inside the building or structure.~~]

PERSONNEL HOIST. [~~A mechanism and its hoistway, equipped with a car that moves vertically on guide members, used for hoisting or lowering workers or workers and materials for the construction, alteration, or demolition of a building, structure, or other work.~~]

PILE DRIVER.

PLASTIC (SOIL, CHAPTER 33).

PLATFORM. [~~A work surface elevated above lower levels. Platforms can be constructed using individual wood planks, fabricated planks or fabricated decks.~~]

POWER BUGGIES. [~~An automotive vehicle designed or used for the transportation of materials on or about construction or demolition sites. It shall not include automobiles, motor trucks, general purpose tractors, or excavating or material handling machinery.~~]

QUALIFIED PERSON. [~~A person who, by possession of a recognized degree, certificate, or professional standing, or who by knowledge, training, and experience, has demonstrated his or her ability to solve or resolve problems related to the subject matter, the work, or the project.~~]

[REGISTERED DESIGN PROFESSIONAL. An architect or engineer.]

REMOVING/REMOVAL/REMOVE (SCAFFOLD). [~~The final process of taking apart a scaffold in a specific sequence and removing it from the site.~~]

REPAIR (SCAFFOLD). [~~Work performed to restore a scaffold, or any part or component, to like new condition and safe working order following decay, wear, or damage. The definition of repair shall also include the replacement of a part or component.~~]

REPLACEMENT (SCAFFOLD). [~~A repair involving the exchange or substitution of one part or component with another identical or similar part or component in order to restore a scaffold, or any part or component, to like new condition and safe working order following decay, wear, or damage.~~]

ROPE. [~~A continuous line of material comprised of a number of twisted or braided strands of fiber (natural or synthetic) or metal wire.~~]

ROTATING TELEHANDLER.

RUNBACK STRUCTURE. [~~A temporary system of hoistway landing runways, vertical supports and horizontal diaphragms designed to bridge between the hoistway and the parent structure and to transmit both vertical and horizontal loads to the supporting structure and/or foundation.~~]

SAFETY NETTING SYSTEM (SAFETY NETTING). [~~Debris or structural nets, installed vertically or horizontally, along with all supports, components, and connections.~~]

Horizontal safety netting. [~~A safety netting system, installed horizontally, consisting of structural netting lined with debris netting.~~]

Vertical safety netting. [~~A safety netting system, installed vertically, consisting of debris netting.~~]

SCAFFOLD. [~~Any temporary elevated platform and its supporting structure (including points of anchorage) used for supporting workers or workers and material, including but not limited to supported scaffolds, suspended scaffolds, and mobile scaffolds.~~]

SCAFFOLD CONTROLLING ENTITY. [~~The contractor or other entity that exercises responsibility for the site where the scaffold is located.~~]

SELF-ERECTING TOWER CRANE.

SHORE, MULTI-STAGE.

SINGLE-POINT ADJUSTABLE SUSPENDED SCAFFOLD. [~~A suspended scaffold consisting of a platform suspended by one rope from an overhead support and equipped with means to permit the movement of the platform to desired work levels.~~]

SITE SAFETY TRAINING (SST) CARD. [~~A card that is issued in a form and manner established by the department and that satisfies each of the following conditions:~~]

[~~1. Such card is issued by an SST provider to a person who submits an application to such provider demonstrating, in a form and manner established by the department, that such applicant satisfies the requirements of Item 1.1, 1.2 or 1.3:~~]

[~~1.1. Such applicant has successfully completed (i) an OSHA 10 hour class and (ii) 30-45 additional SST credits specified by the department, including eight SST credits relating to safeguarding against the dangers posed by falling workers and objects.~~]

[~~1.2. Such applicant has successfully completed (i) an OSHA 30 hour class and (ii) 10-25 additional SST credits specified by the department, including eight SST credits relating to safeguarding against the dangers posed by falling workers and objects.~~]

[~~1.3. Such applicant has successfully completed a 100-hour training program.~~]

[~~2. If such applicant completed the training to comply with Item 1.1, 1.2 or 1.3 but did not complete such training within the five years preceding submission of such application, such applicant has, in the one year period preceding submission of such application, completed at least eight SST credits specified by the department.~~]

[~~3. Such card is issued by an SST provider who does not require applicants to submit any information except for (i) the information necessary to establish that the requirements in Item 1 have been satisfied, as specified by the department, (ii) a photograph of the applicant and (iii) such additional information as the department may allow by rule.~~]

[~~4. Such card expires five years after issuance and is renewable upon a showing by the applicant that such applicant has, in the one year period preceding submission of such renewal application, successfully completed eight SST credits specified by the department.~~]

SITE SAFETY TRAINING (SST) CREDIT. [~~One hour of training that satisfies each of the requirements of Item 1, 2 and 3:~~]

[~~1. Such training relates to a topic identified by department rule.~~]

[~~2. If such training is conducted on or after the effective date of the local law that added this definition, such training is in-person training or actively proctored online training.~~]

[~~3. If such training is conducted on or after March 1, 2018, such training is conducted by an SST provider.~~]

SITE SAFETY TRAINING (SST) FULL COMPLIANCE DATE. [~~March 1, 2021.~~]

SITE SAFETY TRAINING (SST) PROVIDER. [~~An entity that satisfies the requirements of Items 1 and 2:~~]

[~~1. Such person satisfies the conditions of Item 1.1, 1.2, 1.3 or 1.4:~~]

[~~1.1. Such entity is a not-for-profit organization with a history of at least three years of experience in providing construction-related workforce development, construction-related education or site safety training, which may be demonstrated by submitting training logs to the department or in a form and manner otherwise determined by the department, and training offered by such entity is offered by a person who has (i) successfully completed all applicable OSHA or department requirements for conducting OSHA 10-hour classes and OSHA 30-hour classes and is authorized to conduct such classes and (ii) if such person is conducting training for SST credits other than training that is part of an OSHA 10-hour class or OSHA 30-hour class, such person demonstrates sufficient knowledge of this chapter in a form and manner established by the department. Such entity shall not be required to demonstrate any professional standing, approval, licensure, accreditation or certification, including approval, licensure, accreditation or certification pursuant to paragraph (2) of subdivision d of section 105-03 of subchapter E of chapter 100 of title 1 of the rules of the city of New York, as in effect on January 1, 2018, beyond showing that such entity and a person offering training on behalf of such entity satisfy the requirements set forth in the preceding sentence. Where the department provides content, developed in accordance with department-approved course requirements, for the delivery of SST credits, such entity shall deliver SST credits in accordance with such content. Where the department does not provide content for the delivery of SST credits, such entity shall be responsible for the development of content in accordance with department-approved course requirements. Such content and the delivery of such content may be subject to approval or audit by the department.]~~

[~~1.2. Such entity is providing training through a 100-hour training program.]~~

[~~1.3. Such entity has been approved by the department to conduct a 40-hour course approved by the department pursuant to Article 402 of Chapter 4 of Title 28 of the Administrative Code.]~~

[~~1.4. The department may establish by rule additional ways for an entity to satisfy the requirements of this Item 1. If the department elects to promulgate such rules, an entity shall be deemed to satisfy this Item 1 if such entity satisfies the requirements set forth in such rules or if such entity satisfies the requirements set forth in Item 1.1, 1.2 or 1.3.]~~

[~~2. On and after the SST full compliance date, such entity has certified to the department that such entity satisfies at least one of the following conditions:~~]

[~~2.1. Such entity has a language access plan for training that relates to SST credits such entity offers and such plan complies with requirements established by an agency or office designated by the mayor.]~~

~~[2.2. Such entity satisfies each of the following conditions:]~~

~~[2.2.1. Such entity is able to provide instruction in a language that students understand.]~~

~~[2.2.2. If a student's vocabulary is limited, such entity will accommodate that limitation.]~~

~~[2.2.3. A person offering training on behalf of such entity is fluent in the training language or will use translators or interpreters and any such translators or interpreters will have a background in occupational safety and health.]~~

SITE SAFETY TRAINING (SST) SECOND COMPLIANCE DATE. ~~[December 1, 2019, or, if the department publishes a finding by September 1, 2019, that there is insufficient capacity to provide the training required by Section 3321 of the New York city building code to the workers who would need such training, a later date established by the department, provided that such date is not later than June 1, 2020.]~~

SITE SAFETY TRAINING (SST) SUPERVISOR CARD. ~~[A card that satisfies each of the following conditions:]~~

~~[1. Such card is issued in a form and manner established by the department to a person who demonstrates that such person has an SST card and has successfully completed an OSHA 30-hour class.]~~

~~[2. Such card expires five years after issuance and is renewable upon a showing by the applicant that such applicant has, in the one year period preceding such submission of such renewal application, successfully completed 16 SST credits specified by the department.]~~

SITE SAFETY TRAINING (SST) TASK FORCE. ~~[The task force established pursuant to Section 28-103.28 of the Administrative Code.]~~

SOIL AND FOUNDATION WORK (SOIL OR FOUNDATION WORK). ~~[Excavation, fill, grading, augering, boring, or drilling, whether in soil or rock; or the installation or removal of foundations, piles, underpinning, sheeting, shoring, or supports of excavation.]~~

STABLE (ROCK, CHAPTER 33).

STAIR TOWER (SCAFFOLD STAIRWAY/TOWER).

STANDARD GUARDRAIL SYSTEM (SCAFFOLD). ~~[See "Guardrail system (scaffold)."]~~

STAND-OFF BRACKET (SUSPENDED SCAFFOLD).

STRIPPING OPERATIONS. ~~[Removal on the floor of any parts of the concrete formwork including shoring, bracing and other supports.]~~

STRUCTURAL NET (STRUCTURAL NETTING). ~~[A system of nets capable of complying with the prototype test described in ANSI A10.11.]~~

SUBMERGED SOIL (CHAPTER 33).

~~**SUPERSTRUCTURE.** [The rotating upper frame structure of the machine and the operating machinery mounted thereon.]~~

~~**SUPPORTED SCAFFOLD.** [One or more platforms supported by outrigger beams, brackets, poles, legs, uprights, posts, frames, including prefabricated frames that are mechanized but not motorized, or any similar rigid support, including back structures connecting hoistways to buildings, and including structures where sidewalk protection is constructed as an integral part of the apparatus.]~~

~~**SUSPENDED SCAFFOLD.** [One or more platforms suspended by ropes or other means from an overhead structure.]~~

~~**SUSPENDED SCAFFOLD FOREMAN.** [An individual, male or female, designated by and working under the direct and continuing supervision of a licensed master or special rigger, or a licensed master or special sign hanger, in accordance with the rules of the department.]~~

~~[**SUSTAINED WIND.** Winds with a 1 minute average duration lasting for a 1 hour period or longer.]~~

~~**SWING.** [Rotation of the superstructure for movement of loads in a horizontal direction about the axis of rotation.]~~

TELEHANDLER.

~~[**TEMPORARY CONSTRUCTION.** Bracing, shoring, or other elements not part of the permanent structure and which are installed to facilitate construction or demolition work.]~~

TEMPORARY CONSTRUCTION INSTALLATIONS.

~~**TEMPORARY SITE SAFETY TRAINING (SST) CARD.** [A card that is issued in a form and manner established by the department and that satisfies each of the following conditions:]~~

~~[1. Such card is issued by an SST provider to a person who demonstrates that such person has successfully completed an OSHA 10 hour class and who is a new entrant to the construction or demolition work force as determined by such provider pursuant to department rules.]~~

~~[2. Such card expires six months after issuance and is not renewable.]~~

~~**TOOL.** [See "Equipment."]~~

~~[**TOWER.** A vertical structural frame consisting of columns and bracing that are capable of supporting working and dynamic loads and transmitting them to the support(s).]~~

~~**TOWER CRANE.** [A power-operated hoisting machine that utilizes a vertical tower with a rotating superstructure and includes a load boom (jib) in order to lift or lower a load and move it horizontally.]~~

~~**TRANSIT.** [The moving or transporting of a crane from one job site to another.]~~

TRAVEL. [The function of the machine moving from one location to another on a job site.]

TRENCH.

TWO-POINT SUSPENDED SCAFFOLD (SWING STAGE). [A suspended scaffold consisting of a platform supported by hangers (stirrups) suspended by two ropes from overhead supports and equipped with means to permit the raising and lowering of the platform to desired working levels.]

TYPE A SOIL (CHAPTER 33).

TYPE B SOIL (CHAPTER 33).

TYPE C SOIL (CHAPTER 33).

UNCONFINED COMPRESSIVE STRENGTH (SOIL, CHAPTER 33).

UNENCLOSED PERIMETER. [Any exterior portion of a building that is not solidly enclosed with the permanent façade, including the windows; or any exterior edge of a roof that is not enclosed with its permanent parapet or guardrail.]

USE/USING (SCAFFOLD). [Any work or activity performed on or from the scaffold. In addition, for a suspended scaffold, the use of the scaffold shall include the operation of the scaffold at the site, provided during such operation any vertical or horizontal relocation of the scaffold does not require a modification to the counterweight, or does not require the placement, relocation, or removal of any anchorage, attachment, outrigger beam, tie back, or connection to the building or structure.]

WALKABLE FLOOR (CONCRETE CONSTRUCTION). [A floor where the concrete slab has been poured and the formwork stripped.]

WALKABLE FLOOR (PRECAST CONCRETE CONSTRUCTION). [A floor where the frame is erected and the precast concrete floor is fixed in place.]

WALKABLE FLOOR (STEEL CONSTRUCTION). [A floor where the frame is erected and the deck is tack welded or fixed in place.]

WHEEL MOUNTED CRANE (MULTIPLE CONTROL STATIONS). [A crane consisting of a rotating superstructure, operating machinery, and operator's station and boom, mounted on a crane carrier equipped with axles and rubber tired wheels for travel, a power source(s), and having separate stations for driving and operating. Its function is to lift, lower, and swing loads at various radii.]

WHEEL MOUNTED CRANE (SINGLE CONTROL STATION). [A crane consisting of a rotating superstructure, operating machinery, and boom, mounted on a crane carrier equipped with axles and rubber tired wheels for travel, a power source, and having a single control station for driving and operating. Its function is to lift, lower, and swing loads at various radii.]

WORKING DECK (CONCRETE CONSTRUCTION). [The level where the floor is being formed.]

WORKING DECK (DEMOLITION). [~~The level where the floor is being broken up.~~]

WORKING DECK (PRECAST CONCRETE CONSTRUCTION). [~~The level where the floor is being placed.~~]

WORKING DECK (STEEL CONSTRUCTION). [~~The floor where the metal decking and steel components are being placed before concrete is poured.~~]

§ 34. Section BC 3303, of the New York city building code, as amended by local law number 141 for the year 2013, section 3303.2.3.1 as amended by local law number 18 for the year 2014, section 3303.5.4 as amended by local law number 38 for the year 2015, section 3303.10 as amended by local law number 154 for the year 2017, section 3303.10.1 as amended by local law number 106 for the year 2019, and section 3303.10.2 as amended by local law number 116 for the year 2019, is amended to read as follows:

SECTION BC 3303 SAFEGUARDS AND MAINTENANCE OF SITE

3303.1 Scope. Sites shall be safeguarded and maintained in accordance with the provisions of this section to protect the public and property.

3303.2 Utilities. Utilities at a site shall meet the requirements of Sections 3303.2.1 through ~~3303.2.5~~ 3303.2.6.

3303.2.1 Existing services. The location of all existing utilities and service lines shall be determined and adequate measures taken, or devices provided, to safeguard the public and property before such utilities are disturbed.

3303.2.2 Maintaining essential services. See Section 3303.9.

3303.2.3 Electrical work. All temporary electrical equipment and wiring shall meet the requirements of the *New York City Electrical Code*, and shall be maintained in compliance with such requirements. Portions of permanent electrical installations may be used for temporary operations provided the requirements of the *New York City Electrical Code* are met.

3303.2.3.1 Temporary lighting for construction sites. Temporary lighting for construction sites shall use high-efficacy lamps with the following minimum efficacies:

1. 60 lumens per watt for lamps over 40 watts;
2. 50 lumens per watt for lamps over 15 watts but less than or equal to 40 watts; and
3. 40 lumens per watt for lamps 15 watts or less.

3303.2.4 Sanitary facilities. Sanitary facilities shall be provided during construction or demolition activities in accordance with the *New York City Plumbing Code*.

3303.2.5 Removing, relocating, or interrupting services. If any utility is to be removed, relocated, or have its service interrupted, the utility company or city agency affected shall be notified at least 72 hours in advance.

3303.2.6 Disconnecting, capping, and certifications. Prior to the removal of any service, the utility connection shall be disconnected and capped, and certifications to that effect issued by the representative utility company shall be filed with the department.

3303.3 Watchperson. Where an individual building being constructed or demolished has a footprint of between 5,000 square feet (1524 m²) and 40,000 square feet (12 192 m²), a competent watchperson shall be on duty at the site during all hours when operations are not in progress, from the time when the foundation is poured to when all work has concluded and the certificate of occupancy or temporary certificate of occupancy has been issued. Where the building has a footprint of more than 40,000 square feet (12 192 m²), at least one additional watchperson shall be on duty for each additional 40,000 square feet (12 192 m²) of building footprint, or fraction thereof. The watchperson shall be familiar with emergency notification procedures to the Fire Department, shall possess a valid security guard registration with the State of New York, shall hold a valid ~~[fire guard]~~ watchperson certificate from the Fire Department, and ~~[for a major building shall have completed the training required by Section 3310.10]~~ shall have completed a course that is at least 10-hours in length and approved by OSHA in construction industry safety and health.

Exceptions:

1. Where the square footage of the building footprint requires two or more watchpersons, the number of watchpersons may be reduced, subject to the approval of the commissioner, where:
 - 1.1. ~~[An alarm or]~~ A video monitoring system is in place, or where the layout of the building allows a continuous line of sight across the entire building; and
 - 1.2. At least one watchperson is provided.
2. The building is being actively monitored in accordance with a fire safety and evacuation plan approved by the Fire Department in accordance with the *New York City Fire Code*.

3303.4 Housekeeping. Housekeeping at a site shall be in accordance with Sections 3303.4.1 through ~~[3303.4.9]~~ 3303.4.11.

3303.4.1 Slipping and tripping hazards. Slipping and tripping hazards in areas used by the public shall be minimized in accordance with Sections 3303.4.1.1 and 3303.4.1.2.

3303.4.1.1 Maintenance of public areas. All areas used by the public shall be maintained free from ice, snow, grease, debris, equipment, materials, projections, tools, or other items, substances, or conditions that may constitute a slipping, tripping, or other hazard.

3303.4.1.2 Location of hose lines, wires, ropes, pipes, chains and conduits. Hose lines, wires, ropes, pipes, chains, and conduits shall be located so that they will not constitute a tripping hazard to the public. Where it is necessary to carry such across sidewalks, or any public way, they shall either be suspended at least 8 feet (2438 mm) above ground or, if left on the ground, suitable chamfered planks or a pedestrian bridge shall be provided to cover such.

3303.4.2 Containers. Sufficient containers, including but not limited to waste dumpsters, debris boxes, and skip boxes, shall be available for the storage of all debris or waste. Such containers shall comply with the following requirements:

1. Containers shall be made of metal, flame-retardant plastic, or other noncombustible material [~~acceptable to the commissioner~~]. [~~Such containers shall also comply with the following:~~]
- [1-] 2. Containers with wheels shall be secured at the end of the workday by rope, cable, or chocking at the wheels in order to prevent movement.
- [2-] 3. Containers shall not be placed at the edge of [~~the building~~] an unenclosed perimeter at any time, except when being moved from the floor or building.
- [3-] 4. Containers holding debris or waste shall be covered at the end of the workday and at any time when full to near the rim. [~~Containers~~] However, containers need not be covered when they are empty and not in use, or while stored in a fully enclosed space at the end of the workday and not full to near the rim.

Exception: Combustible debris shall not be permitted to accumulate and shall be removed from the site in accordance with Section 3303.5.1.

3303.4.3 Reserved.

3303.4.4 Control of debris. Control of debris during construction and demolition work shall include the [~~following~~] measures[~~;~~] specified in Sections 3303.4.4.1 through 3303.4.4.3.

[1-] **3303.4.4.1 Daily cleaning.** All [~~floors, roofs, and working decks~~] areas of the construction or demolition site shall be cleaned of debris at least daily[~~, and a daily inspection made by a competent person to verify such has occurred. If the building is a major building, such inspection shall be noted in the site safety log~~].

3303.4.4.2 Cleaning near unenclosed perimeters. Areas that are at least 10 feet (3048 mm) from an unenclosed perimeter, as measured in all directions from the unenclosed perimeter, shall be cleaned of debris periodically throughout the day.

Exception: In locations where unenclosed perimeter protection has been temporarily removed, the requirements of Section 3308.10 shall apply.

[2-] **3303.4.4.3 Securing debris that cannot be removed by the end of the shift.** Debris that cannot be removed from the site by the end of the shift shall be:

1. ~~[placed]~~ Placed in containers meeting the requirements of ~~[this section]~~ Section 3303.4.2; or
2. ~~[shall be secured]~~ Secured overnight to protect the public and property and shall be removed from the site or placed in containers meeting the requirements of Section 3303.4.2 at the beginning of the next shift. For demolition operations, debris stored overnight on grade or earth, and neatly piled to prevent dislodgement, tipping, or spillage, shall be considered to be in compliance with this section.

Exception: Combustible debris shall not be permitted to accumulate and shall be removed from the site in accordance with Section 3303.5.1.

3303.4.5 Storage and safeguarding of materials and equipment during construction or demolition. Material and equipment ~~[stored]~~ located at a site during construction or demolition operations shall comply with Sections 3303.4.5.1 and 3303.4.5.2.

3303.4.5.1 Open and exposed areas. ~~[When not being used, material]~~ Material or equipment located on a working deck, unenclosed floor, roof, ground area, or similar exposed area shall be secured ~~[against]~~ or otherwise safeguarded to prevent dislodgement by wind ~~[or], vibration,~~ accidental impact, or other means.

3303.4.5.2 Storage near unenclosed perimeters. ~~[All]~~ When not being used, material or equipment ~~[not being used]~~ shall be stored at least 10 feet (3048 mm) ~~[, measured along all horizontal dimensions,]~~ from all unenclosed perimeters ~~[of the building or structure,],~~ as measured in all directions from the unenclosed perimeter. ~~[Such material]~~ Material or equipment shall also be secured or safeguarded in accordance with the requirements of Section 3303.4.5.1.

Exceptions: Provided the material or equipment is secured against ~~[accidental movement]~~ dislodgement by wind, vibration, accidental impact, or other means, in lieu of the 10-foot (3048 mm) set[] back distance:

1. Material or equipment that weighs 750 pounds (340.2 kg) or more may be stored at least 5 feet (1524 mm) from the unenclosed perimeter.
2. Where the gross floor area is less than 1,000 square feet (~~[304.8]~~ 93 m²), material or equipment, regardless of weight, may be stored at least 5 feet (1524 mm) from the unenclosed perimeter.
3. Where located on a floor ~~[or working deck]~~ that is at or above the level of the horizontal safety netting in accordance with Section 3308, material or equipment may be stored at least 2 feet (610 mm) from the unenclosed perimeter.
4. Material related to concrete operations may overhang the unenclosed perimeter of the building or structure, provided:
 - 4.1. The material is banded with a minimum of two equally spaced bands to prevent dislodgement;

- 4.2. The material is braced and secured in place by positive means as indicated on the site safety plan, or where there is no site safety plan, in accordance with drawings prepared by a registered design professional;
- 4.3. The material overhangs by no more than one-third of its length;
- 4.4. The material is stored in an area designated on the site safety plan, or where there is no site safety plan, in an area designated on drawings prepared by a registered design professional;
- 4.5. Such designated area is broom swept and cleared of all materials, equipment, and debris prior to the temporary removal of the vertical netting and placement of overhanging material in the designated area;
- 4.6. The perimeter of such designated area, except for the perimeter along the unenclosed perimeter, is protected by vertical netting meeting the requirements of Section 3308.5 or an alternative system acceptable to the commissioner;
- 4.7. Horizontal safety netting meeting the requirements of Section 3308.6 is provided at a level not more than two stories or 30 feet (9144 mm) below the overhanging material, whichever is less, with such nets in place for the full time the material is overhanging, except that the nets may be pulled in at the immediate time the material is being hoisted or lowered where such nets would conflict with the hoisting or lowering operation; and
- 4.8. The material is relocated on the next workday.

3303.4.6 Storage of combustible material and equipment. Storage of combustible material and other material and equipment that may present a fire hazard shall comply with the *New York City Fire Code*.

3303.4.7 Storage near sidewalks, walkways, and pathways. Material stored adjacent to a sidewalk, walkway, or pathway that remains open to the public shall not be piled higher than 3 feet (914 mm), or where a solid fence or barrier is provided, to within one foot (305 mm) of the top of such fence or barrier. For the purposes of this section, the term “adjacent to” shall be any area that is within a horizontal distance that is equal to or less than the vertical height of the piled material.

Exception: Material stored within a dumpster or similar solid container, provided such material is not piled above the top of such dumpster or container.

3303.4.8 Machinery. All exposed, electrically charged, moving or otherwise dangerous parts of machines and construction or demolition equipment shall be located, guarded, shielded, or barricaded so as to prevent contact by the public.

3303.4.9 Internal combustion-powered equipment. In addition to the requirements of this chapter, the use of internal combustion-powered equipment shall comply with the *New York City Fire Code*.

3303.4.10 Stairs, hallways, and other means of egress. Stairs, hallways, pathways, and other means of egress, including but not limited to ladders used to facilitate access to a working level, shall not be encumbered by debris, material, or equipment.

3303.4.11 Daily inspection of housekeeping. A daily inspection shall be made by a competent person to verify compliance with the housekeeping requirements of Sections 3303.4.1 through 3303.4.10. If the building is a major building, the occurrence of this inspection shall be noted in the site safety log. If the building is not a major building but requires a construction superintendent, the occurrence of this inspection shall be noted in the construction superintendent's log.

3303.5 Removal of material and debris. Material and debris shall be removed in a manner that prevents injury or damage to the public or property.

3303.5.1 Removal of combustible debris. Combustible debris shall not be permitted to accumulate, and shall be removed from the site at reasonable intervals in accordance with the requirements of the *New York City Fire Code*.

3303.5.2 Dropping or throwing prohibited. No material, debris, or equipment shall be intentionally dropped or thrown from a building or structure.

3303.5.3 Clogging. Precautions shall be taken to prevent concrete or mortar washings, sand, grit, or any other material that would cause clogging from entering a sewer, ~~or~~ drain, vault, or subsurface structure. Concrete washout water shall also meet the requirements of Section 3303.15.

3303.5.4 Air pollution. The provisions of the *Air Pollution Control Code* shall apply in order to prevent dust from becoming airborne.

3303.5.5 Chutes. Chutes used in association with the removal of materials shall comply with Sections 3303.5.5.1 through 3303.5.5.5.

3303.5.5.1 Enclosures. Chute enclosures shall comply with the following requirements:

1. Material chutes that are at an angle of more than 45 degrees (0.79 rad) with the horizontal shall be entirely enclosed on all sides, except for openings at the floor levels for the receiving of materials. Such openings shall not exceed 48 inches (1219 mm) in height, measured along the wall of the chute, and all openings, except the top opening, shall be closed and secured when not in use.
2. Chutes at an angle of less than 45 degrees (0.79 rad) with the horizontal may be open on the upper side.

3303.5.5.2 Chute construction. Chute construction shall comply with the following requirements:

1. Every chute used to convey debris from a building or structure shall be rigidly supported and braced throughout its height.

[Chutes] 2. Non-manufactured chutes less than 24 inches (610 mm) in maximum dimension shall be constructed of not less than 1-inch (25.4 mm) (nominal) wood, or 1/8-inch thick (3.18 mm) steel, or a material of equivalent strength and durability acceptable to the commissioner. Chutes more than 24 inches (610 mm) in maximum dimensions shall be constructed of not less than 2-inch (51 mm) (nominal) wood, or 3/16-inch thick (4.76 mm) steel, or a material of equivalent strength and durability acceptable to the commissioner.

[2.] 3. Chutes shall be provided with a metal impact plate where material is forced to change direction while falling.

[3.] 4. A gate shall be provided at the lower end of every chute to control the loading of material into trucks and to close the chute at all other times. [Splash boards] ~~Splash boards~~ or baffles shall be erected to prevent materials from rebounding into the street or under the sidewalk shed.

[4.] 5. A bumper or curb at least 4 inches by 4 inches (102 by 102 mm) in section shall be provided at each chute opening where such opening is level with, or below, the floor or platform. Every space between the chute and the edge of the opening in the floor or platform shall be solidly planked.

6. Chutes that are over 75 feet (22 860 mm) in height, or utilized in Group I occupancy, shall also comply with the requirements of Section 3303.5.5.3.

~~[3303.5.5.3 Fire retardant construction. When used in the following applications, all chutes constructed of combustible material shall be covered on the exterior with corrugated steel sheeting having a minimum thickness of 24 gauge through their entire height. Alternatively, chutes shall be constructed of noncombustible material:~~

~~1. Chutes exceeding 75 feet (22 860 mm) in height.~~

~~2. Alteration, repair or partial demolition of buildings where the main use or dominant occupancy is in Group I.]~~

3303.5.5.3 Chute construction where the chute is over 75 feet in height, or utilized in Group I occupancy. Chutes that exceed 75 feet (22 860 mm) in height, or that are used in an occupied building where the main use or dominant occupancy is in Group I, shall either:

1. Be constructed of noncombustible material; or

2. Where constructed of combustible material, the combustible material of the chute shall be covered on the exterior of the chute with corrugated steel sheeting having a minimum thickness of 24 gauge through the entire height of the chute.

3303.5.5.4 Supports. All structural supports of material chutes shall be of noncombustible material.

3303.5.5.5 Design and permit. No chute shall be installed until a permit has been issued by the commissioner on the basis of drawings prepared by a registered design professional.

Exception: Design and permit is not required for a chute that ~~is~~ meets all of the following criteria:

1. ~~Installed~~ The chute is installed on the exterior of a building or structure at a height of 40 feet (12 192 mm) or less ~~in height~~ above the level of the adjoining ground;
2. ~~Has been designed by a manufacturer~~ The chute is a manufactured product and is installed in accordance with the manufacturer's ~~design~~ specifications; and
3. ~~Does~~ The chute does not attach to or impart a load on a scaffold.

3303.6 Escape hatches. Where portable fuel fired heaters or other heating equipment are used to provide temporary heating during the placing of concrete for a floor, an escape hatch shall be provided. ~~[The escape hatch shall extend from the floor where the concrete is being placed and through at least one story immediately below such floor.]~~ The escape hatch shall be located as near to the center of the building or structure as practical.

[Exception:] Exceptions:

1. An escape hatch is not required where either the concrete placement floor or heating floor is the ground floor.
2. An escape hatch is not required provided at least one permanent stairway is available for use on the floor where ~~such~~ the concrete ~~[placement]~~ is ~~[occurring and that such stairway is enclosed from the ceiling to the floor of the floor where such concrete placement is occurring and from the ceiling to the floor immediately below such floor with the permanent fire-rated enclosure for the stair or a]~~ being placed and the stair shaft is enclosed from the top of the floor where concrete is being placed to at least the top of the heating floor with either its permanent construction, a temporary smoke proof 1-hour fire rated assembly, or a 1-hour fireproof tarp wrapped tightly around the stair shaft so that no smoke can penetrate.

3303.6.1 Required ladders and ~~metal~~ shields. The escape hatch shall be constructed with at least two fixed, vertical ladders enclosed in a ~~metal~~ solid non-combustible shield. The ladders shall extend from a distance of 3 feet (914 mm) above the floor where the concrete is being placed to ~~either~~ at least ~~[two stories]~~ the story below the heating floor, or to the ground floor, whichever is less. The ~~metal~~ solid non-combustible shield shall enclose the ladders on all sides from the top of the floor where the concrete is being placed to at least the top of the heating floor ~~[next below]~~. The inside dimensions between faces of the shield shall be not less than 3 feet 8 inches (1118 mm).

Exception: Extension ladders may be utilized where the horizontal dimension between the faces of the shields is equal to or greater than one-quarter the height of the shaft.

3303.6.2 Shield space and decking. ~~[The space]~~ Any gap between the shield and the perimeter of the opening in the floor under construction and also between the shield and the perimeter of the opening in the ~~[floor next below]~~ heating floor shall be decked over with 2-inch (51 mm) or heavier planking covered with plywood or sheet metal so as to make the decking smoke tight. At the termination of the ladders, the opening in the floor shall be covered completely with 2-inch (51 mm) planking or other material of equivalent strength.

3303.7 Fire prevention and fire protection. Firefighting equipment, fire [] fighting access at the construction or demolition site, and the conduct of all construction or demolition operations affecting fire prevention and fire [] fighting shall comply with the *New York City Fire Code* and the provisions of Sections 3303.7.1 through ~~[3303.7.5]~~ 3303.7.7.

3303.7.1 Water supply. A water supply for fire protection shall be provided in accordance with the *New York City Fire Code*.

3303.7.1.1 Large footprint construction. For a building that has a footprint of 100,000 square feet (30 480 m²) or more, regardless of the height of the building, and the building is substantially enclosed, permanent or temporary fire hydrants available for fire department use shall be provided during the course of construction:

1. Within 50 feet (15 240 mm) of the main entrance; and
2. Along the perimeter of the building, with the hydrants located so that there is at least one hydrant along every 250 feet (76 200 mm) of building perimeter, and with no hydrant more than 50 feet (15 240 mm) from the exterior wall.

3303.7.2 Fire extinguishers. Fire extinguishers shall be provided in accordance with the *New York City Fire Code*.

3303.7.3 Smoking. Smoking shall be prohibited at all construction and demolition sites. No smoking signs shall be posted at the site in accordance with the provisions of the *New York City Fire Code*.

3303.7.4 Sprinkler systems. Existing sprinkler systems in buildings undergoing an alteration or demolition shall comply with the requirements of Section 3303.7.4.1 through 3303.7.4.3.

3303.7.4.1 Sprinklers during alteration. Existing sprinkler systems in buildings undergoing an alteration shall be maintained in accordance with Section 3303.9, except as provided in Section 3303.7.4.3. The red paint required pursuant to Section 903.6 ~~[of this code]~~ shall be maintained during any alteration operation.

3303.7.4.2 Sprinklers during demolition. When existing sprinkler systems with fire department hose connections are present in buildings undergoing full or partial demolition, such systems shall be maintained as a nonautomatic sprinkler system, except as provided in Section 3303.7.4.3. When demolition starts, the sprinkler risers shall be capped immediately below the floor being demolished so as to maintain the sprinkler system on all lower floors for Fire Department use. Cutting and capping of sprinklers during demolition work shall be performed only by a licensed master plumber or licensed master fire suppression piping

contractor who has obtained a permit for such work. Fire department hose connections shall be kept free from obstruction and shall be marked by a metal sign reading “Sprinkler Connection” and by a red light at night. The red paint required pursuant to Section 903.6 [~~of this code~~] shall be maintained during any demolition operations.

3303.7.4.3 Removal of damaged sprinklers. Requests for a variance from the sprinkler requirements of this section shall be limited to requests to remove a damaged or inoperable sprinkler system or a portion of such system in connection with demolitions or gut rehabilitations. Applications for construction document approvals for such requests shall be filed with the department by a registered design professional in accordance with the following procedure:

1. The filed application shall include a complete report prepared by the professional describing the extent of the damage and attesting as to why the system cannot be restored; and
2. The variance shall not be approved by the department without the concurrence of the Fire Department as follows:
 - 2.1. The applicant shall file the request for variance with the Fire Department;
 - 2.2. The Fire Department shall review and recommend any necessary safety measures required as a condition of granting the variance; and
 - 2.3. The applicant shall submit the Fire Department’s recommendation to the department along with proof of satisfactory implementation of such safety measures.

3303.7.5 Standpipe systems. Standpipe systems shall meet the requirements of Section 3303.8.

3303.7.6 Floor numbering and floor elevation. During new building construction, a vertical or horizontal enlargement, or a demolition operation that results in the removal of one or more floors in a building that is greater than 420 feet (128 m) in height above grade, or in any building, regardless of height, with non-sequential floor numbers, the following shall be provided:

1. A sign at each hoistway landing prominently displaying the designated floor number and elevation above grade.
2. A sign at each stair landing prominently displaying the designated floor number and elevation above grade.
3. A sign or other acceptable marking immediately adjacent to the standpipe hose outlet on each floor indicating the elevation above grade of the standpipe hose outlet and, in multi-zone standpipe buildings, the zone of the riser (low, mid, high).
4. A chart of the entire building listing the designated floor number and the elevation above grade of the standpipe hose outlet on each floor. The chart shall be posted in each construction elevator or hoist, and at such ground floor locations as specified in the *New York City Fire Code*.

3303.7.7 Special provisions for Type IV construction. In addition to the fire prevention and fire protection requirements imposed by this code, the *New York City Fire Code*, and other applicable law, the following provisions shall also apply during the construction of structures categorized as Type IV construction by Chapter 6 of this code.

3303.7.7.1 Interior exit stair enclosures. Notwithstanding the requirements of Section 3303.11, no wooden structural components shall be installed until the permanent stairs and interior exit stair enclosures have been constructed to a height of at least two floors above the topmost working deck, or to their full height, and enclosed with their permanent fire protected rated material. A temporary or permanent self-closing door that meets the requirements of Section 715 shall be installed at each level as soon as a walkable surface is in place at that floor level. Openings in the interior exit stair enclosures at levels where a walkable surface has not been placed shall be protected with guardrails that meet the requirements of Section 3308.7. The top of the interior exit stair enclosure, if not permanently enclosed, shall be covered with a tarp or other temporary weather protection. The stair shall be provided with temporary or permanent handrails. Permanent signs, markings, or anti-slip materials in the stairs are not required during construction.

3303.7.7.2 Standpipes. A permanent or temporary standpipe system meeting the requirements of Sections 905 and 3303.8 shall be provided in each interior exit stair enclosure and kept in a state of readiness at all times for use by firefighting personnel, even if the site does not otherwise trigger the standpipe requirements of Section 3303.8, Item 1. The standpipe system shall be in place prior to the installation of wooden structural components and shall serve all levels where the interior exit stair enclosure has been constructed. No standpipe shall be considered to be in a state of readiness unless it is painted red in accordance with the provisions of Section 905.11. The standpipe system shall be maintained as a dry system and provided with an air pressurized alarm system in accordance with Section 3303.8.1. Where the building will not be provided with a permanent standpipe at the end of construction, the temporary standpipe system shall be removed once the sprinkler system for the building has been signed off.

3303.7.7.3 Progressive installation of enclosures and fire protection elements. Fire-rated enclosures (e.g. corridors, fire compartmentalization, fire-rated doors), noncombustible exterior walls, heat detectors required by Section 3303.7.7.5, and sprinkler systems, if required for the building, shall be installed as soon as practical, and in no case shall they lag more than two floors below the topmost walkable surface. Sprinkler systems shall be temporary or permanent and shall be maintained as a dry system during construction. Openings in the façade for hoists or material loading platforms are permitted provided the opening is covered at the end of the shift with a flame resistant tarp made tight so that no smoke can penetrate.

3303.7.7.4 Temporary protection of structural connections. Where a structural connection between a girder and column is not provided with its permanent fire-rated enclosure or protection, it shall be protected by a temporary 1-hour rated enclosure or protection. Such temporary enclosure or protection shall be installed as soon as practical after the connection has been made, and no later than by the end of the shift.

3303.7.7.5 Heat detectors. Heat detectors shall be provided throughout the site. Such detectors shall send alerts to a dedicated monitoring location, either at the site or at a remote

location that is monitored continuously, including days, nights, weekends, and holidays. The monitor shall be familiar with emergency contact procedures, the locations of heat detectors at the site, and shall be able to alert the New York City Fire Department as necessary and provide the fire department with the location of any heat detector that has been activated.

3303.7.7.6 Watchperson. A watchperson meeting the requirements of Section 3303.3 shall be on duty during all times specified by Section 3303.3, even if the building has a footprint of less than 5,000 sq ft (1524 m²).

3303.7.7.7 Site safety orientation and refresher. The site safety orientation and refresher required by Section 3301.11 shall contain instruction on site specific fire hazards, fire safety safeguards, and fire safety procedures.

3303.7.7.8 Pre-shift safety meetings. The pre-shift safety meetings required by Section 3301.12 shall contain instruction on fire hazards, fire safety safeguards, and fire safety procedures applicable to the individual worker.

3303.7.7.9 Chutes. Chutes shall comply with the requirements of Section 3303.5.5.3 even if the building does not otherwise meet the trigger thresholds of Section 3303.5.5.3.

3303.7.7.10 Doors. Except when required to facilitate the active passage of personnel, material, debris, or equipment, fire rated doors shall be kept closed at all times, and all other doors shall be closed during non-working hours.

3303.7.7.11 Control of saw dust and combustible debris. Sawdust shall be vacuumed as operations proceed. Combustible debris, including but not limited to sawdust and scrap lumber, shall be removed from the site as required by Section 3303.5.1.

3303.7.7.12 Storage of lumber. During non-working hours, lumber shall be stored on the ground or street, or shall be stored in a fully enclosed room meeting its permanent fire rating. No more than 1920 ft³ (54.37 m³) of lumber shall be stored at the site at any one time.

Exception: Columns may be stored on the topmost working deck provided they are to be installed at the start of the next shift.

3303.8 Standpipe systems during construction, alteration or demolition. During construction, alteration or demolition operations, standpipe systems shall comply with the following:

1. When, during the course of the construction of a new building, the topmost working deck reaches a height of 75 feet (22 860 mm) or greater above the ground in a building for which a standpipe system will be required,~~[,]~~ a permanent or temporary standpipe system meeting the requirements of Section 905 shall be kept in a state of readiness at all times for use by fire ~~[-]~~ fighting personnel. The standpipe system shall serve all floors ~~[where the permanent stairs are required per Section 3303.11]~~ that are at least 4 stories or 40 feet (12 192 mm) below the topmost working deck, whichever is less. No standpipe shall be considered to be in a state of readiness unless it is painted red in accordance with the provisions of Section 905.11~~[of this code]~~. When freezing conditions may be encountered, the system in whole, or the part of the system subject to freezing conditions, shall be maintained as a dry system.

2. Existing standpipe systems in structures undergoing a full demolition shall be maintained as dry standpipes. At the commencement of demolition, the standpipe risers shall be capped above the outlet on the floor immediately below the floor being demolished so as to maintain the standpipe system on all lower floors for Fire Department use. Cutting and capping of standpipes during demolition work shall be performed only by a licensed master plumber or licensed master fire suppression piping contractor who has obtained a permit for such work. Standpipe hose, nozzles and spanners are not required to be maintained and may be removed at any time. The red paint required pursuant to Section 905.11 [~~of this code~~] shall be maintained during any demolition operations. All existing house check valves shall remain in place until completion of the demolition work.
3. When, during the course of the construction of a new building which will have a occupiable space at a depth of 75 feet (22 860 mm) or greater below the level of the ground in a building for which a standpipe system will be required, a permanent or temporary standpipe system meeting the requirements of Section 905 shall be installed and shall be kept in a state of readiness at all times for use by fire [-] fighting personnel. The standpipe system shall serve all stories below grade and shall be installed as soon as [~~a temporary or permanent stair is installed below grade~~] the foundation is in place and the first elevated slab has been erected. No standpipe shall be considered to be in a state of readiness unless it is painted red in accordance with the provisions of Section 905.11[~~of this code~~]. When freezing conditions may be encountered, the system in whole, or the part of the system subject to freezing conditions, shall be maintained as a dry system.
4. When, during the course of alteration or partial demolition operations in a building for which a standpipe system is required, the standpipe system shall be maintained in accordance with Section 3303.9. In an unoccupied building, an existing wet standpipe system may be maintained as a dry system subject to the approval of the commissioner and the commissioner of the fire department, and also provided the standpipe system is equipped with an air pressurized alarm system meeting the requirements of Section 3303.8.1. No standpipe shall be considered to be in a state of readiness unless it is painted red in accordance with the provisions of Section 905.11[~~of this code~~].
 - 4.1. If the alteration work results in the addition of new stories to the structure at a height of 75 feet (22 860 mm) or greater above the level of the ground, the requirements of Item 1 of this section shall apply to such new stories during the course of the alteration operation.
 - 4.2. If the alteration work results in the addition of new occupiable space at a depth of 75 feet (22 860 mm) or greater below the level of the ground, the requirements of Item 3 of this section shall apply to such new occupiable space below grade during the course of the alteration operation.

3303.8.1 Air pressurized alarm system for dry standpipe systems during construction or demolition operations. Dry standpipe systems utilized during construction or demolition operations shall be provided with an air pressurized alarm system as set forth in Items 1 through 5 below. The provisions of NFPA 14, Chapter 12, as modified in Appendix Q, shall also apply.

1. Full demolitions. In buildings and structures undergoing a full demolition, all existing standpipes shall be maintained in a state of readiness as a dry system in accordance with Item 2 of Section 3303.8 and shall be provided with an air pressurized alarm system.
2. New construction, alteration, and partial demolition. Where a dry standpipe system is utilized during new construction, alteration, or partial demolition operations, such standpipe system shall be provided with an air pressurized alarm system.
3. Submission of application. An application to install an air pressurized alarm system shall be filed by a registered design professional and a permit obtained by a licensed master plumber or licensed master fire suppression piping contractor. A licensed electrician shall obtain all required electrical permits in accordance with Chapter 3 of Title 27 of the *Administrative Code*.
4. Specifications. The following provisions shall apply to the air pressurized alarm system:
 - 4.1. Pressure. Pressure shall be maintained in the standpipe and cross connections at all times and shall not exceed 25 psig (172 kPag) by utilizing nitrogen or an air compressor with an air dryer. The supervisory pressure shall be as determined by a registered design professional.
 - 4.2. Automatic air pressurized alarm activation. The alarm shall be automatically activated when the pressure drops below the supervisory pressure or rises above the maximum pressure of 25 psig (172 kPag). When the alarm is activated, notification shall be made to the Fire Department in accordance with the *New York City Fire Code*, all work at the site shall cease, except as provided in Item 4.2.1, and an investigation of the entire standpipe system and air compressor shall be immediately performed to determine the cause of the alarm. Unless authorized by the Fire Department, no construction or demolition work shall resume until the standpipe system is repaired and the appropriate pressure is restored, except that any repairs to the standpipe system needed to restore the required pressure shall be undertaken immediately and the standpipe system restored as soon as possible. There shall be compliance with the requirements of the *New York City Fire Code* while the standpipe system is out of service. Upon completion of repairs to the standpipe system, a full inspection of such system shall be performed, which shall include, among other things, visually tracing the standpipe, including risers, cross connections and fire department connections to verify that no breach exists and checking all gauges of the standpipe system to ensure the standpipe system has been restored to a state of readiness.
 - 4.2.1. Notwithstanding the provisions of Item 4.2, the activation of the alarm shall not require the cessation of work necessary for the completion of concrete pouring operations in progress at the time of alarm activation, where such cessation would cause a cold joint that would impair the structural integrity of the finished construction. The continuation of such operations shall be permitted only until an orderly termination of such operations can be effectuated. The site safety manager or coordinator shall record the names and locations of any employees necessary for the completion of the concrete pouring operations and provide them to the Fire Department personnel who arrive on the scene.

- 4.3. Air compressor. The air compressor shall be designed to automatically cut in and cut out at the supervisory pressure and shall be tied into the standpipe system between the fire department connections and the house check valves. The air compressor shall utilize an air dryer during times when freezing conditions exist to condition the air entering the dry standpipe system.
- 4.4. Alarm. The standpipe alarm system shall utilize pressure switches and control equipment to annunciate a local audible alarm on site that can be heard during working and non-working hours. The audible signal of the horn shall be at least 15 dBA above the ambient noise level but no more than 110 dBA.
- 4.5. Power supply. The standpipe alarm system shall be connected to an active, dedicated power supply at all times.
- 4.6. Check valves. Check valves shall be installed to prevent water from entering the air compressor.
- 4.7. Locks and caps. All control valves shall be chained and locked in the appropriate position and shall be provided with capped outlets. All hose valves shall also be provided with capped outlets.
- 4.8. Fire Department connections. Three inch (76 mm) iron hose plugs with gaskets in Fire Department connection swivels shall be provided.
- 4.9. Drainage. Provisions shall be made to drain water in any trapped sections of the dry standpipe system that are subject to freezing.
- 4.10. Manual air release connection. A minimum 2.5-inch (64 mm) connection located immediately downstream of the fire department connection check valve shall be provided and piped to a location immediately adjacent to the fire department connections. This line shall be fitted with a 2.5-inch (64 mm) hose valve and shall allow for release of the pressurized air from the dry standpipe system. The number of air release valves provided shall be such that the air pressure shall be released in no more than 3 minutes, which shall be verifiable by an actual air release test performed at the time of the initial installation.
- 4.11. Construction documents. Plans shall identify all standpipe risers, cross connections, fire department connections, any intermediate check valves that have to be removed, proposed location of the air release connections, designation of the supervisory pressure, complete information regarding the alarm system, and procedures for the safe pressurization and depressurization of the system.
- 4.12. Signage. Signage shall be provided at all fire department connections indicating that the dry standpipe system is pressurized and showing the location of the manual air release.
- 4.13. Pressure gauges. A system of pressure gauges shall be installed at the compressor and at the most remote points of the system from the compressor.

5. Planned removal from service of standpipe system and standpipe air pressurized alarm. Whenever the standpipe system is to be placed out of service for the addition of a new section to the system, removal of an existing section as demolition operations progress, or other planned event, the standpipe alarm may be temporarily deactivated subject to compliance with the requirements of the *New York City Fire Code*. Where a site safety manager or coordinator is required by this code, all alarm activations, inspections, and repairs shall be logged into the log book maintained by such site safety manager or coordinator. If the standpipe system is not returned to a state of readiness and the alarm reactivated within 2 hours of such planned removal from service, all construction or demolition work at the site shall cease, unless otherwise approved by the Fire Department.

3303.8.2 Free from obstruction. Fire department hose connections shall be kept free from obstruction and shall be marked by a metal sign reading, “Standpipe Connection” and by a red light at night.

3303.8.3 Use of standpipes for purposes other than supplying water for firefighting. Standpipes may be used for a purpose other than to supply water for firefighting operations, including but not limited to supplying water or compressed air for construction or demolition operations, subject to the approval of the Fire Department and provided at least one standpipe riser is maintained at all times for firefighting operations. Where the standpipe is used to supply water for construction or demolition operations and freezing conditions may occur, the standpipe shall be completely drained after use to prevent freezing.

3303.9 Elements to be maintained in existing buildings. Required means of egress, existing structural elements, fire protection devices, and sanitary safeguards shall be maintained at all times during construction or demolition operations in existing buildings. Required means of egress shall not be obstructed in any manner that would destroy the full effectiveness of such means of egress.

Exception: Where adequate alternate provisions are provided in accordance with the requirements of this code, or where the element is temporarily or permanently disconnected, removed, or demolished in accordance with the requirements of this code and of the agency or authority having jurisdiction to temporarily or permanently disconnect, remove, or demolish such element. Such alternative means, disconnection, removal, or demolition shall be shown on the approved plans. Fire protection systems, including but not limited to sprinklers, standpipes, and fire alarms, shall only be taken out of service in accordance with the requirements of the *New York City Fire Code*.

3303.10 Operations in occupied buildings. When construction or demolition activity occurs in an occupied building, barricades, signs, drop cloths, and other protective means shall be installed and maintained as necessary to provide reasonable protection for the occupants against hazard and nuisance. Such protective means shall be indicated on an occupant protection plan, or where a tenant protection plan is required by Section 3303.10.1, on a tenant protection plan.

3303.10.1 Tenant protection plan. In buildings containing any occupied dwelling units, including newly constructed buildings that are partially occupied where work is still ongoing within the building, all alteration, construction, or partial demolition work shall be performed in accordance with a tenant protection plan as required by Article 120 of Title 28 of the *Administrative Code*.

3303.10.2 Inspections of tenant protection plan. The owner shall notify the department in writing at least 72 hours prior to the commencement of any work requiring a tenant protection plan. The department shall conduct an inspection of 10 percent of such sites within seven days after the commencement of such work to verify compliance with the tenant protection plan. The department shall conduct follow up inspections of such sites every 180 days until such construction is completed to verify compliance with the building code and tenant protection plan. Thereafter, the department shall conduct an inspection within 10 days of receipt of a complaint concerning such work.

3303.10.3 Enforcement of tenant protection plan. If work is not being performed in accordance with the tenant protection plan, the commissioner may issue a stop work order pursuant to ~~[section]~~ Section 28-207.2 of the ~~[administrative code]~~ Administrative Code.

3303.11 Stairs during construction or demolition. ~~[During construction and demolition stairs shall comply with the following:]~~ Stairs shall meet the requirements of Section 3303.11.1 through 3303.11.3 during construction or demolition work.

~~[1. During the course of construction of a new building, or in spaces being added to an existing building, at least one permanent stair shall be brought to within a distance of 40 feet (12 192 mm) or 4 floors below the working deck at all times. In all other locations where permanent stairs will be required, a temporary or permanent stair shall be brought to within a distance of 40 feet (12 192 mm) or 4 floors below the working deck at all times.]~~

~~[2.]~~ **3303.11.1 Existing stairs.** Stairs in an existing building undergoing alteration or a partial demolition shall be maintained in accordance with Section 3303.9. Stairs in a building undergoing a full demolition shall comply with Section 3306.9.9.

3303.11.2 Stairs during building construction or enlargements. During new building construction or the enlargement of an existing building, stairs shall be provided at all locations where a permanent stair will be required and shall serve all floors. At least one of the provided stairs must be of permanent construction for its full length; in all other locations, the stairs may be of temporary or permanent construction.

Exceptions:

1. Where a floor is open to the public, all stairs required for egress from the floor must be of their permanent construction from that floor to the ground level.
2. Stairs are not required where the floor is closed to the public and the floor is less than 4 stories or 40 feet (12 192 mm) below the topmost working deck, whichever is less.
3. During the construction or enlargement of a building whose primary structural system consists of structural steel, where it is not feasible to provide one or more permanent stairs to serve all floors that are at least 4 stories or 40 feet (12 192 mm) below the topmost working deck, whichever is less, all stairs shall be of their permanent construction up to the level of the topmost completed steel floor, and temporary stairs, acceptable to the commissioner, shall be brought up in all locations to serve all remaining floors that are at least 4 stories or 40 feet (12 192 mm) below the topmost

working deck, whichever is less. At a minimum, the temporary stairs shall be made of non-combustible material, be equipped with adequate handrails, be provided with landings that are level with the adjoining floor, and have riser height and tread depths that are uniform, within ¼ inch (6 mm), for each flight of stairs.

[3-] **3303.11.3 Lighted and kept free of obstructions.** All stairs in a building undergoing construction or demolition shall be lighted at all times, and shall be kept free of equipment, debris, and material in accordance with Section 3303.4.10.

3303.12 Elevators and hoists during construction or demolition. Elevators and hoists [~~during construction or demolition work~~] shall meet the requirements of Sections 3303.12.1 through 3303.12.5 during construction or demolition work.

3303.12.1 [~~Publically~~] Publicly accessible floors. Existing elevators serving [~~publically~~] publicly accessible floors in a building undergoing construction or demolition work shall be maintained in accordance with Section 3303.9.

3303.12.2 Floors closed to the public. [~~All~~] When required by Sections 3303.12.2.1 through 3303.12.2.4, floors closed to the public in a new or existing building undergoing construction or demolition work shall be served by, at least, either:

1. An elevator provided with Phase I and Phase II recall meeting the requirements of Chapter 30, which shall be kept in readiness at all times for Fire Department use; or
2. A hoist meeting the requirements of Section 3318, which shall be available at all times for [~~fire department~~] Fire Department use.

[~~Exceptions~~] **Exception:** An elevator or hoist is not required during the course of construction or demolition [~~for:~~] of [~~1- A~~] a building that does not require a permanent elevator.

[~~2- Floors that are located within a vertical distance of seven stories or 75 feet (22 860 mm) or less from the working deck.~~]

3303.12.2.1 Initial installation of an elevator or hoist during the construction or enlargement of a building whose height will exceed 75 feet. During the construction or enlargement of a building, once the topmost working deck exceeds 75 feet (22 860 mm) in height above the lowest level of the ground, all floors that are closed to the public and within 40 feet (12 192 mm) above the lowest level of the ground shall be served by an elevator or hoist meeting the requirements of this section. Where this measurement lands between floors, the measurement shall be rounded such that the elevator or hoist is brought up to serve the higher floor.

3303.12.2.2 Increasing the height of the elevator or hoist during the construction or enlargement of a building. During the construction or enlargement of a building, when the topmost working deck exceeds 75 feet (22 860 mm) in height above the lowest level of the ground and subsequent to complying with Section 3303.12.2.1, all floors that are closed to the public and that are at least 4 stories or 48 feet (14 630 mm) below the topmost working

deck, whichever is less, or for a building whose primary structural system consists of structural steel, at least 4 stories or 64 feet (19 507 mm) below the topmost working deck, whichever is less, shall be served by an elevator or hoist meeting the requirements of this section. However, no more than two weeks after the topmost working deck has become a walkable floor, a hoist or elevator meeting the requirements of this section shall be brought up to serve all remaining floors in the building that are closed to the public.

3303.12.2.3 During demolition. During the demolition of a building where one or more floors are removed from the building, all floors in the building that are closed to the public and that are more than 7 stories or 75 feet (22 860 mm) below the topmost working deck, whichever is less, shall be served by an elevator or hoist meeting the requirements of this section.

3303.12.2.4 Other instances. During the alteration of a building that would require a permanent elevator and where the scope of work does not constitute an enlargement or involve the removal of one or more floors from the building, all floors in the building that are closed to the public shall be served by an elevator or hoist meeting the requirements of this section.

3303.12.3 Deep excavations. Where the proposed lowest level of a building with a footprint of 10,000 square feet (~~[3048 m]~~ 929 m²) or greater is constructed at a depth greater than 75 feet (22 860 mm), a hoist meeting the requirements of Section 3318 shall be available at all times for Fire Department use once [such floor has been poured and set] the foundation is in place and the first elevated slab has been erected. The hoist shall serve the level at grade and all stories below grade.

Exception: Subject to the approval of the commissioner, alternate means available at all times for Fire Department use, including but not limited to a vehicular ramp, shall be provided.

3303.12.4 Converting elevators. Where an existing elevator is converted from passenger or freight use, the department shall be notified in accordance with the requirements of Chapter 30.

3303.12.5 Hoist travel. If the travel of the hoist cannot be increased or decreased to fulfill the requirements of this section due to inclement weather, it shall be increased by the end of the next working day.

3303.12.6 Stretcher accommodation. Where a hoist is provided, it must be capable of accommodating two standing individuals and a stretcher that is 84 inches in length by 24 inches in width (2134 mm by 610 mm).

3303.13 Interrupted or abandoned and discontinued operations. ~~[Sites where]~~ Where construction or demolition work has been interrupted or abandoned and discontinued, the owner of the site shall [be] ensure the site is secured, protected, and maintained to safeguard the public and property, and that the site is in [accordance] compliance with the requirements of Sections 3303.13.1 through 3303.13.3.

3303.13.1 Fencing. A fence meeting the requirements of Section ~~[3307]~~ 3307.7 shall be maintained throughout the duration of time that operations at the site are interrupted or abandoned and discontinued.

3303.13.2 Safety monitoring plan. Where work has been interrupted or abandoned and discontinued for a period of at least three months, a safety monitoring plan satisfactory to the commissioner shall be prepared by a qualified person on behalf of the owner of the property and submitted to the department by the owner. Such safety monitoring plan shall be specific to the site, shall identify safeguards to be instituted and maintained to secure the site, and shall specify monitoring to be performed during the duration of suspension of work. The ~~[site]~~ owner of the property shall be ~~[monitored in accordance]~~ responsible for ensuring compliance with such plan.

3303.13.3 Filling and grading. Where work has been interrupted or abandoned and discontinued for a period of at least three months, all open excavations shall be filled and graded to eliminate all steep slopes, holes, obstructions or similar sources of hazard. Fill shall consist of clean, noncombustible material. The final surface shall be graded in such a manner as to drain the lot, eliminate pockets in the fill, and prevent the accumulation of water without damaging any foundations on the premises or on adjoining property.

Exception: Filling and grading is not required for abandoned, discontinued, or interrupted excavations that are:

1. Secured in accordance with Section 3303.13.2, and
2. Inspected periodically by an engineer to verify continued stability of the excavation, with a record of such inspections signed, sealed, and dated by the engineer.

3303.14 Water conditions. The requirements of Sections 3303.14.1 through 3303.14.5 shall be followed to control the accumulation of water.

3303.14.1 Drainage. No condition shall be created as a result of construction or demolition operations that will interfere with natural surface drainage. Water courses, drainage ditches, etc., shall not be obstructed by debris, refuse, waste building materials, earth, stones, tree stumps, branches, or other ~~[debris]~~ objects that may interfere with surface drainage or cause the impoundment of surface waters.

~~[3303.14.1]~~ **3303.14.2 Protection of foundations.** Provision shall be made to prevent the accumulation of water or water damage to any foundations on the premises or to adjoining property.

~~[3303.14.2]~~ **3303.14.3 Drainage of excavations.** All excavations shall be drained, and the drainage shall be maintained as long as the excavation continues or remains. Where necessary, pumping shall be used, provided proper permits are obtained from the New York City Department of Environmental Protection.

~~[3303.14.3]~~ **3303.14.4 Clogging.** The requirements of Section 3303.5.3 shall apply.

3303.14.5 Dewatering. The contractor or other entity performing the soil or foundation work shall dewater the site, as needed, for the progress of the work, and shall take all necessary measures to prevent settlement, slope failure, and damage to buildings, structures, and property affected by the dewatering operations.

3303.14.5.1 Dewatering plan. Where dewatering is performed to drawdown or control the level of the water table, the dewatering operation shall proceed in accordance with a site specific plan developed by a registered design professional. The dewatering plan must incorporate all the conditions and findings identified in the geotechnical report required by Section 1803.6, the evaluation analysis required by Section 1817, and the preconstruction survey required by Section 3309.4.3. At a minimum, the plan shall indicate:

1. Height of the water table, including all seasonal fluctuations;
2. Anticipated schedule of dewatering operations;
3. The location of wells, settlement tanks, observation points, and dewatering equipment;
4. Maximum discharge;
5. Permissible drawdown outside of the limits of the excavation;
6. Thresholds for anticipated settlement;
7. Thresholds for anticipated lateral movement; and
8. The program to monitor and control water table drawdown and settlement/movement of affected structures, property, and temporary construction installations. Program criteria to be specified shall include, but not be limited to, the monitoring frequency, plan to periodically test the discharge from the pumps to determine if the water being extracted contains unanticipated fine grain soil or sand, plan to account for fluctuations in the water table (due to seasonal conditions, weather, or other factors), reporting requirements for the monitoring program, and procedures to be implemented when thresholds are exceeded.

3303.15 Concrete washout water. Concrete washout water shall not be allowed to enter any sewer, catch basin, drain, or body of water or to leach into the ground.

3303.15.1 Collection and containment. All concrete washout water shall be collected and contained in or on the concrete mixer truck or in pre-manufactured watertight containers specifically designed and fabricated for the purpose of collecting and containing concrete washout water on-site. Such containers shall be of sufficient quantity and size to accommodate all rinsing operations required on-site so as not to delay the timely return of concrete ready mix trucks to the concrete plant and shall be protected from breach or overflow at all times.

3303.15.2 Location. Rinsing operations and concrete washout water containers shall not be located less than 30 feet from any sewer, drain, catch basin, or body of water without the written approval of the commissioner.

3303.15.3 Disposal. Collected concrete washout water shall be transported off site for treatment and disposal or contained on site until completely evaporated. Any hardened concrete remaining after evaporation shall be disposed of, reused or recycled.

~~[3303.16 Contractors sheds and offices. Contractors sheds and offices located within 30 feet (9144 mm) of new construction, existing buildings, or another contractor shed or office shall be made of metal or other noncombustible material.]~~

~~[**Exception:** Contractor sheds and offices located within a building and protected from weather may use fire-retardant treated wood, provided the shed does not exceed one story in height and 120 square feet (36.58 m²) in area and is at least 30 feet (9144 mm) from another shed.]~~

3303.16 Worker sheds, contractor sheds, contractor offices, and similar structures. Worker sheds, contractor sheds, contractor offices, and similar structures shall:

1. Be provided with a hardwire or battery powered smoke detector that meets the requirements of this code and the *New York City Fire Code*;
2. Be equipped with an automatic sprinkler system or a non-water automatic fire-extinguishing system, including a dry-chemical extinguishing system, that meets the requirements of this code and the *New York City Fire Code*, when the shed or office is installed or predominantly used to facilitate work at a building that requires an automatic sprinkler system;
3. Meet the door width, travel distances, and occupancy load requirements of Chapter 10 of the building code; and
4. Be constructed to comply with either 4.1, 4.2, or 4.3:
 - 4.1. Meet the requirements of this code for Types I or II fire-resistance-rated construction where:
 - 4.1.1. Located within a building or structure; or
 - 4.1.2. Located 30 feet (9144 mm) or less from another building or structure within the fire district.
 - 4.2. Meet the requirements of this code for Type III fire-resistance-rated construction where:
 - 4.2.1. Located outside of a building or structure; and
 - 4.2.2. Located more than 30 feet (9144 mm) from another building or structure within the fire district.
 - 4.3. Meet the requirements of this code for Type III fire-resistance-rated construction where:
 - 4.3.1. Located outside of a building or structure; and
 - 4.3.2. Located outside of the fire district.

3303.16.1 Permit required. No worker shed, contractor shed, contractor office, or similar structure shall be

installed until a permit for the shed or office has been issued by the commissioner in accordance with the requirements of Chapter 1 of Title 28 of the *Administrative Code*.

Exception: A permit is not required for a worker shed, contractor shed, contractor office, or similar structure that does not exceed 1 story in height and 120 square feet (36.58 m²) in area, and further provided that the shed, office or similar structure is located more than 30 feet (9144 mm) from another shed, or office, or similar structure.

3303.16.2 Utility hookups. No electrical, plumbing, or other utility hook up shall be made to a worker shed, contractor shed, contractor office, or similar structure until a permit for the hookup has been issued by the commissioner in accordance with the requirements of Chapter 1 of Title 28 of the *Administrative Code*. Where required by Chapter 4 of Title 28 of the *Administrative Code*, the utility hookup must be made by or under the direct and continuing supervision of a licensed individual.

§ 35. Section BC 3304 of the New York city building code, as amended by local law number 141 for the year 2013, section 3304.3.3 as amended by local law number 65 for the year 2018, is amended to read as follows:

SECTION BC 3304 SOIL AND FOUNDATION WORK

3304.1 Scope. The provisions of this section shall apply to all soil and foundation work, including but not limited to drilling or excavations made for the purposes of taking earth, sand, gravel, rock, or other material, as well as to soil and foundation work related to accessory uses such as garages, pools, and decks, and also to the underpinning or bracing of buildings or structures, in order to safeguard the public and property from such work. In addition to the requirements of this section, the applicable sections of Chapter 18 shall also apply to soil and foundation work.

Exceptions: This section shall not apply to:

1. Soil or foundation work not related to the underpinning or bracing of an existing building or structure, and which is performed in connection with utility or infrastructure work occurring within a public right of way, including but not limited to the construction, alteration, maintenance, repair, or demolition of bridges, streets, sidewalks, highways, railroads, subways, water tunnels, or utility lines.
2. Soil or foundation work on cemetery grounds for burials.
3. Soil or foundation work performed within an industrial or commercial quarry, plant, or yard and not related to the construction or demolition of a building or structure on the property of such quarry, plant, or yard.

3304.1.1 Measurements. The depth of all soil and foundation work shall be measured from the level of the adjacent ground surface to the lowest point of the soil and foundation work. The height of all soil and foundation work shall be measured from the level of the adjacent ground surface to the highest point of the soil and foundation work. Where soil and foundation work occurs within

a basement or cellar, the soil and foundation work shall be measured from the level of the adjacent slab.

3304.1.2 Safety of the public and property. Soil and foundation work shall be performed and, as necessary, supported, in a manner to prevent injury to the public, damage to property, or collapse, subsidence, or uncontrolled loss of earth or rock.

~~[3304.2 Support of excavation drawings. The sides of all excavations, including related or resulting embankments, shall be supported as specified on drawings. Such drawings shall be site specific and shall clearly illustrate all related protection and support of the excavation, including but not limited to sloping, stepping, sheeting, shoring, bracing, guardrail systems, and fences as required by Section 3304.4, with all dimensions indicated. Such drawings shall also indicate any utilities or public infrastructure impacted by the excavation. The drawings shall be prepared by a registered design professional who has demonstrated knowledge or experience in the design of retaining structures or bracing systems for the support of excavation.]~~

[Exceptions:]

~~[1. Drawings for the support of excavation are not required for an excavation:]~~

~~[1.1. — That occurs 5 feet (1524 mm) or less in depth, provided:]~~

~~[1.1.1. The excavation also occurs more than 5 feet (1524 mm) from all footings and foundations; or]~~

~~[1.1.2. Where the excavation occurs within five feet (1524 mm) or less from a footing or foundation, such excavation does not occur below the level of the footing or foundation.]~~

~~[1.2. — Where the sides of the excavation are sloped not steeper than 45 degrees (0.79 rad) or stepped so that the average slope is not steeper than 45 degrees (0.79 rad) with no step more than 5 feet (1524 mm) high, provided such slope or step begins at least five feet (1524 mm) from all footings and foundations.]~~

~~[1.3. — Where a trench box is utilized in accordance with the manufacturer's specifications, provided the manufacturer specifications are available onsite.]~~

~~[2. Support of excavation drawings can be prepared by a qualified person for an excavation occurring in conjunction with the construction or demolition of an exterior in-ground pool, provided such pool is an accessory to a one-two-or three-family home, is limited to 400 square feet (121.92 square meters) in area, and provided that the distance from the edge of the pool to any building, structure, or lot line is greater than the depth of the deepest portion of the pool.]~~

~~[3. Where demolition drawings are required by Section 3306.5, separate support of excavation drawings for the removal of the foundation are not required, provided such detail is shown on the demolition drawings.]~~

3304.2 Permit. A permit shall be obtained prior to the commencement of soil or foundation work when required by Chapter 1 of Title 28 of the *Administrative Code*.

3304.3 Notification. Prior to the commencement of soil or foundation work, notification shall be provided as follows.

3304.3.1 Notification of the department. No soil or foundation work within the property line shall commence unless the permit holder, or where there is no permit holder the person causing the soil or foundation work to be made, notifies the department, via phone or electronically, at least 24 hours, but no more than 48 hours prior to the commencement of such work. The notification shall state the date that such soil or foundation work is to commence and include a “Call before you dig” confirmation number verifying compliance with the notification requirements of Section 3304.3.7. Should the notification date fall on a weekend or official holiday, the permit holder, or where there is no permit holder the person causing the soil or foundation work to be made, shall notify the department on the last business day before the commencement date.

In the event that the soil or foundation work does not begin on the date provided in the notification to the department, the permit holder, or where there is no permit holder the person causing the soil or foundation work to be made, shall notify the department of its cancellation not more than 24 hours prior to but no later than the date for which the soil or foundation work was scheduled. Should the cancellation date fall on a weekend or an official holiday, the permit holder, or where there is no permit holder the person causing the soil or foundation work to be made, shall notify the department on the next business day after the intended commencement date. The permit holder, or where there is no permit holder the person causing the soil or foundation work to be made, shall notify the department of a new intended commencement date pursuant to the provisions above.

~~[The commissioner may issue a stop work order if there is a failure to provide notice as required in this section and if the work is found to violate any of the provisions of this code, the *New York City Zoning Resolution*, or other applicable laws or rules. Upon the issuance of such stop work order, the work shall be stopped for a minimum of three business days to enable the department to take any other appropriate action to ensure that the earthwork is being performed in a safe manner. The earthwork shall not recommence until the stop work order has been lifted.]~~

Exceptions: Notification to the department is not required for the following:

1. Hand excavation work that extends less than 5 feet (1524 mm) [~~or less~~] in depth and is 2 feet (610 mm) or more from an existing footing or foundation. This exception shall not apply to any hand excavation work performed anywhere in existing or demolished basements or cellars that adjoin existing foundations.
2. Excavations for a geotechnical investigation that do not exceed 10 feet (3048 mm) in length, width, or diameter, and that are conducted under the supervision of a registered design professional.

3. Emergency work performed by the Department of Housing Preservation and Development (HPD) or other agency as directed by the commissioner or work on unsafe buildings performed by HPD or other agency pursuant to a precept.
4. Soil or foundation work related to gardening or landscaping work, provided no excavation occurs to a depth [~~greater than~~] of 5 feet or greater (1524 mm); and either:
 - 4.1. The excavation occurs more than 5 feet (1524 mm) from all footings and foundations; or
 - 4.2. Where the excavation occurs within 5 feet (1524 mm) or less from a footing or foundation, such excavation does not occur below the level of the footing or foundation.
5. Soil or foundation work related to the pouring of a slab or pavement, provided no excavation to a depth greater than 2 feet (610 mm) occurs in conjunction with such work.
6. Where notification is required by Section 3306.3, separate notification for the removal of a foundation is not required.

3304.3.2 Notification of adjoining property owners. When an excavation to a depth of 5 feet to 10 feet (1524 mm to 3048 mm) is to be made within 10 feet (3048 mm) of an adjacent footing or foundation, or when any excavation over 10 feet (3048 mm) is to be made anywhere on a site, the person causing the excavation to be made shall provide written notice to the owners of the adjoining property not less than 10 days prior to the scheduled starting date of the excavation. The written notice shall provide a description of the work to be performed, the timeframe and schedule, [~~and~~] the contact information of the person causing the excavation to be made, and the contact information of the department.

Exception: Notification is not required where the excavation is set back from the edge of the adjacent footing or foundation or adjoining property by a ratio of 2 horizontal to 1 vertical, as measured from the deepest point of the excavation.

3304.3.3 Notification to the Department of Environmental Protection. Whenever soil or foundation work, for any purpose, is proposed to a depth greater than 50 feet (15 240 mm) in the borough of the Bronx or on or north of 135th Street in the borough of Manhattan, or greater than 100 feet (30 480 mm) is proposed in the borough of Brooklyn, Queens, or Staten Island or south of 135th Street in the borough of Manhattan, the owner of the premises, engineer, architect or contractor shall notify the New York City Department of Environmental Protection prior to commencement of such activity in accordance with Section 24-367 of the [~~Administrative Code~~] Administrative Code and any rules promulgated thereunder. The issuance of any permit or approval by the department shall not relieve the applicant, owner, engineer, architect or contractor of the obligation to comply with any notification or permitting requirements of the New York City Department of Environmental Protection. Whether or not a permit is required from the department for work, including but not limited to drilling for borings or geothermal wells, the owner of the premises, engineer, architect or contractor shall still comply with the

notification and permitting requirements of the New York City Department of Environmental Protection.

3304.3.4 Excavations requiring permit from the New York State Department of Environmental Conservation. Whenever ~~[drilling or excavation]~~ soil or foundation work is planned deeper than 500 feet (152 m) below grade, a permit may be required from the New York State Department of Environmental Conservation. The issuance of any permit or approval by the department shall not relieve the applicant of the obligation to comply with any approval or permitting requirements of the New York State Department of Environmental Conservation. Whenever any drilling for borings or geothermal wells is planned, the owner of the premises or the contractor shall notify the New York State Department of Environmental Conservation prior to commencement of such activity to determine if a permit is necessary.

3304.3.5 Notification ~~[and permit requirements]~~ and approval of the New York City Transit Authority, the Metropolitan Transportation Authority, and the Port Authority of New York and New Jersey. Whenever an excavation of any depth is proposed within 200 feet (60 960 mm) of any ~~[subway or tunnel]~~ facility, infrastructure, or property under the jurisdiction of the New York City Transit Authority, the Metropolitan Transportation Authority, or the Port Authority of New York and New Jersey, including but not limited to rail and subway lines, stations, station entrance and access points, bridges, tunnels, bus depots, access roads, fan plants, pump rooms, substations, shops and yards, duct lines, and easements, an approval ~~[and permit]~~ shall be obtained from such authority having jurisdiction. The owner of the premises or the contractor shall notify the authority having jurisdiction prior to commencement of any such activity. The issuance of any permit or approval by the department shall not relieve the applicant of the obligation to comply with any approval ~~[or permitting]~~ requirements of the New York City Transit Authority, the Metropolitan Transportation Authority, or the Port Authority of New York and New Jersey.

3304.3.6 Notification and permit requirements of the New York City Fire Department. Soil or foundation work that is to be done with the use of explosives shall also be subject to the notification and permit requirements set forth in the *New York City Fire Code*.

3304.3.7 Call before you dig notification. “Call before you dig” notification shall be provided in accordance with the requirements of 16 NYCRR Part 753. The notification must address all street frontages associated with the soil and foundation work.

3304.4 Protection of sides of excavations. The sides of excavations shall be protected in accordance with the requirements of Sections 3304.4.1 through 3304.4.6.

~~[3304.4.1 Support of excavation. The sides of all excavations, including related or resulting embankments, that are 5 feet (1524 mm) or greater in depth or height shall be supported in accordance with one or more of the following means. Where required by Section 3304.2, such means shall be indicated on drawings:]~~

- ~~[1. Sheeting, shoring, bracing, or by other retaining structures as may be necessary to prevent the sides of the excavation from caving in before permanent supports are provided. Such methods of protection shall be subject to special inspection in accordance with the provisions of Chapter 17; or]~~

~~[2. Excavation sides sloped not steeper than 45 degrees (0.79 rad) or stepped so that the average slope is not steeper than 45 degrees (0.79 rad) with no step more than 5 feet (1524 mm) high, provided such slope or step does not endanger any structure or temporary construction, including subsurface structures. Slopes or steps steeper than 45 degrees (0.79 rad), or steps more than 5 feet (1524 mm) high shall be permitted only where the registered design professional preparing the drawings required by Section 3304.2 determines, based upon the completion of a geotechnical investigation report acceptable to the commissioner, that the slopes or steps will be stable.]~~

~~[**Exception:** For a rock cut excavation, no protection is required, provided a registered design professional determines the rock cut will not be subject to shearing and will not otherwise be unstable before permanent supports are provided. Otherwise, the rock cut shall be stabilized in accordance with drawings prepared by the registered design professional.]~~

3304.4.1 Support of excavation construction documents. Means of supporting excavations, including related or resulting embankments, rock faces, and soil slopes, shall be indicated on construction documents. Such means of supporting excavations shall be installed and maintained in accordance with the construction documents. The construction documents shall be prepared by a registered design professional who has demonstrated knowledge or experience in the design of retaining structures or bracing systems for the support of excavation. Where the excavation exceeds 20 feet (6096 mm) in depth, the registered design professional shall be a New York State licensed professional engineer.

Exceptions: Construction documents indicating the means of supporting the excavation are not required if:

1. The excavation meets the conditions specified in Items 1.1 through 1.4:

1.1. Is less than 5 feet (1524 mm) in depth;

1.2. Occurs above the level of the water table;

1.3. Occurs more than 5 feet (1524 mm) from all streets, sidewalks, tunnels, railroad tracks, public right of ways, and retaining walls; and

1.4. Occurs either:

1.4.1. More than 5 feet (1524 mm) from all footings and foundations; or

1.4.2. When within 5 feet (1524 mm) or less from a footing or foundation, does not extend below the level of the footing or foundation.

2. The excavation meets the conditions specified in Items 2.1 through 2.3:

2.1. Occurs more than 5 feet (1524 mm) from all footings, foundations, streets, sidewalks, tunnels, railroad tracks, public right of ways, and retaining walls;

2.2. Does not exceed 20 feet (6096 mm) in depth; and

2.3. Either:

2.3.1. The slope of the excavation does not exceed 1.5 horizontal to 1 vertical (34 degrees measured from the horizontal), with no benching allowed; or

2.3.2. A registered design professional determines the soil type, and the excavation is properly sloped or benched for the soil type in accordance with the requirements of Section 3304.4.2. Determination of the soil type shall be based upon a site specific evaluation, and documentation of the determination, signed and sealed by the registered design professional, shall be kept at the site.

3. A trench box is utilized in accordance with the manufacturer’s specifications, provided a physical copy of the manufacturer specifications are available onsite.

4. It is a trench that complies with Table 3304.4.1, including all notes to the table.

5. The excavation is performed in conjunction with the installation or removal of an exterior in-ground pool, provided such pool is an accessory to a one-or two-family home, is limited to 400 square feet (121.92 square meters) in area, and further provided that the distance from the edge of the pool to any building, structure, or lot line is greater than the depth of the deepest portion of the pool.

6. Where demolition drawings are required by Section 3306.5, separate support of excavation construction documents for the removal of the foundation are not required, provided the details required for a support of excavation drawing are instead shown on the demolition drawings.

TABLE 3304.4.1
MINIMUM SIZES OF TIMBER BRACING AND TIMBER SHEET PILING FOR TRENCHES NOT EXCEEDING 10 FEET (3048 MM) IN DEPTH AND 15 FEET (4572 MM) IN WIDTH

<u>Depth of trench</u>	<u>Width of trench</u>	<u>Nominal size of cross bracing at 6 feet (1829 mm) horizontal spacing</u>	<u>Shoring</u>
<u>Up to 10 ft (3048 mm)</u>	<u>Up to 9 ft (2743 mm)</u>	<u>6 in x 8in (152 mm x 203 mm)</u>	<u>Sheet Piling, 2 ft x 6 ft (610 mm x 1829 mm), spaced tight, and</u> <u>Wales, 12 in x 12 in (305 mm x 305 mm), with 5 ft (1524 mm) maximum vertical spacing</u>
	<u>Up to 15 ft (4572 mm)</u>	<u>8in x 8in (203 mm x 203 mm)</u>	

Notes to Table 3304.4.1:

1. All timber or equivalent substitute to have bending strength of 850 psi or above.
2. The depth of the trench shall be considered the depth from top of grade, not top of shoring structure should a portion of the support of excavation be by benching or sloping methods.
3. Table shall not be utilized if any of the following are met:
 - a. Trench exceeds the specified dimensions.
 - b. Stored material or structures are present within a distance equal to the depth of the trench.

- c. Equipment surcharge loading exceeds 20,000 lb (9071.85 kg).
- d. Surcharge load exceeds 2 ft (610 mm).
- e. Cross bracing is subject to any vertical load that meets or exceeds a load equivalent to a 240-lb (109 kg) gravity load distributed over the center 12 ft (305 mm) in of the bracing member.

3304.4.1.1 Content of support of excavation construction documents. Support of excavation construction documents shall, at a minimum:

1. Be specific to the site;
2. Be fully dimensioned;
3. Account for the entire scope of work;
4. Indicate all items required by Section 107.8;
5. Indicate soil or rock type and bearing capacity;
6. Indicate the water table elevation;
7. Indicate if dewatering is needed, and if a dewatering plan is required by Section 3303.14.5, note that a dewatering plan is required and the depth at which the dewatering plan must be put into effect. Further, where a dewatering plan is required by Section 3303.14.5, note the depth at which work must stop if a dewatering plan has not been provided; such depth must be equal to or shallower than the depth specified for the dewatering plan to be put into effect;
8. Indicate the support of excavation, including but not limited to sloping, benching, sheeting, shoring, and bracing;
9. For an excavation in rock, any supplemental support of the rock face;
10. Indicate all structures, utilities, infrastructure, and subsurface structures impacted by the soil or foundation work;
11. Indicate the design load imposed for temporary construction installations, material, and equipment, including but limited to sidewalk sheds, scaffolds, runback structures, cranes, excavators, and stored or piled material, and note that all temporary construction installations or equipment that will impose a load on the support of excavation in excess of the design load imposed must be reviewed for acceptability by the designer of the support of excavation;
12. Indicate the sequence of the excavation operation and the installation and removal of the support of excavation, including all relevant phasing, and including the depth at which support of excavation must be installed;
13. Account for the provisions of Section 3304.4.5;
14. Reference the monitoring plan, where a monitoring plan is required;

15. Specify required inspections and inspection intervals for the support of excavation, including special inspections; and

16. Where slurry is utilized to support the excavation, the information required by Section 3304.12 shall also be indicated.

3304.4.1.2 Geotechnical analysis and relevant reports. The support of excavation construction documents shall be developed based upon site specific testing and analysis performed by a registered design professional who has demonstrated knowledge or experience in geotechnical evaluation. The support of excavation construction documents must incorporate all the conditions and findings identified in the geotechnical report required by Section 1803.6, the evaluation analysis required by Section 1817, and the preconstruction survey required by Section 3309.4.3.

~~[3304.4.2 Rainstorms. See Section 3304.5.1.]~~

3304.4.2 Limitation on sloping and benching. Where sloping or benching is utilized to support an excavation, the slope or bench step shall be appropriate for conditions at the site, including but not limited to soil type, environmental conditions, and surcharge loads. In no case shall the maximum slope or bench step for an excavation that is 5 feet (1524 mm) or greater in depth exceed the values specified in Table 3304.4.2. For layered soil conditions, the most restrictive value among the soil types present at the excavation location shall be utilized unless otherwise specified by the registered design professional and indicated on the construction documents required by Section 3304.4.1.

Exception: The limitations of Table 3304.4.2 shall not apply to excavations made in Class 1a, 1b, or 1c rock, as classified by Chapter 18, provided the geotechnical report required by Section 1803.6 substantiates the safety of the proposed slope, cut, or bench step, and further provided that the resulting slope, cut, or bench step, as well as any supplemental support of the rock face, is indicated on the construction documents required by Section 3304.4.1.

TABLE 3304.4.2
MAXIMUM ALLOWABLE SLOPES AND STEPS

<u>SOIL TYPE</u>	<u>MAXIMUM ALLOWABLE SLOPES (Horizontal: Vertical)</u>	<u>MAXIMUM ALLOWABLE BENCH STEP</u>
<u>Type A soil</u>	<u>1:1 (45°)</u>	<u>5 feet (1524 mm)</u>
<u>Type B soil</u>	<u>1:1 (45°)</u>	<u>4 feet (1219 mm)</u>
<u>Type C soil</u>	<u>1½:1 (34°)</u>	<u>Not allowed</u>

3304.4.3 Fence. Every site with an excavation shall be enclosed with a fence that meets the requirements of Section 3307.7.

3304.4.4 Guardrail system. All open edges of an excavation that are 6 feet (1829 mm) or greater in depth shall be protected by a guardrail system meeting the requirements of Sections 3308.7.1 through 3308.7.5, or by a solid enclosure at least 3 feet 6 inches (1067 mm) high. For the purpose of a guardrail system installed in accordance with this section to protect the open edge of an excavation, the term “floor” in Sections 3308.7.1 through 3308.7.5 shall mean “ground.”

Exceptions:

- ~~[1. The toeboard, when installed in conjunction with such excavation guardrail system, shall consist, at a minimum, of 1 inch × 6 inches (25 mm by 152 mm) lumber or metal plank and shall be at least 5½ inches (140 mm) high.]~~
- ~~[2.]~~ 1. ___ A toeboard is not required where the sheeting, shoring, bracing, or any other support of excavation extends at least ~~[5½ inches (140 mm)]~~ 3½ inches (89 mm) above the top of the excavation.
- ~~[3.]~~ 2. ___ guardrail system or a solid enclosure is not required where access to the adjoining area is precluded.
- ~~[4.]~~ 3. ___ A guardrail system or a solid enclosure is not required where side slopes are three horizontal by one vertical (33-percent slope) or flatter.
- 4. In lieu of a guardrail system, wells, pits, excavation shafts, or similar excavations may be protected by an adequate cover capable of supporting, without failure, at least twice the weight of persons, equipment, and materials that may be imposed on the cover at any one time, or where located in roadways and vehicular aisles, at least twice the maximum axle load of the largest vehicle expected to cross over the cover. The cover shall be secured when installed so as to prevent accidental displacement by the wind, equipment, or persons, and shall be color coded or marked with the word "HOLE" or "COVER" to provide warning of the hazard.
- 5. The edges of ramps shall be protected in accordance with Section 3315.

3304.4.4.1 Openings. To provide necessary openings for intermittent operations, one or more sections of the guardrail system or solid enclosure may be hinged or supported in sockets. When supported in sockets, rails shall be so constructed that they cannot be jolted out. A button or hook may be used to hold the guardrail system or solid enclosure in a fixed position. ~~[Substantial]~~ As an alternative to hinged or socketed sections, substantial chains or ropes may be used to guard such openings in such guardrail system or solid enclosure. Where so used, the chains or ropes shall ~~[be taut at the same]~~ meet the tautness and height requirements as the rails of ~~[the]~~ a standard guardrail system.

3304.4.5 Placing of soil or foundation work equipment and excavated material. Excavated material and superimposed loads, including but not limited to equipment and trucks used for soil or foundation work, shall not be placed closer to the edge of the excavation than a distance equal to one and one-half times the depth of such excavation unless the sides of the excavation have been sloped or sheet piled (or sheeted) and shored to withstand the lateral force imposed by such superimposed loads, or ~~[a]~~ the registered design professional has determined the side of the excavation can adequately support the load imposed, with such support or determination shown on ~~[drawings]~~ construction documents required by Section ~~[3304.2]~~ 3304.4.1. In the case of open excavations with side slopes, the edge of excavation shall be taken as the ~~[toe]~~ top of the slope.

3304.4.6 Installation of protection. Required protection for the sides of the excavation shall be installed as the excavation advances. The placement of permanent structures or fill in areas requiring support of excavation shall not begin until the support of excavation has been completed for such areas.

3304.5 Inspections. Soil and foundation work shall be inspected in accordance with the requirements of Sections 3304.5.1 ~~[through 3304.5.3]~~ and 3304.5.2.

3304.5.1 Rainstorms. All sides or slopes of excavations or embankments shall be inspected after rainstorms, or any other hazard-increasing event, and safe conditions shall be restored.

~~[3304.5.2 Support of excavation. Methods employed to protect the sides of excavations meeting the requirements of Item 1 of Section 3304.4.1 shall be subject to special inspections in accordance with Chapter 17.]~~

~~[3304.5.3 Slurry. The requirements of Section 3304.12 shall apply.]~~

3304.5.2 Special inspections. Special inspections shall be performed in accordance with Chapter 17.

3304.6 Retaining walls. The requirements of ~~[Section]~~ Article 305 of Title 28 of the *Administrative Code*, as well as Sections 1806 and 3309 of the building code shall apply as applicable.

3304.7 Access. Every excavation shall be provided with at least one safe means of ingress and egress that is kept available at all times. For a trench that has a depth of 4 feet (1219 mm) or greater, and with a width of 15 feet (4572 mm) or less, as measured between the soil, forms, or structure at the bottom of the trench, one or more stairways, ladders, ramps, or other safe means of ingress and egress shall be located in the trench so as to require no more than 25 feet (7620 mm) of lateral travel.

3304.8 Drainage. The requirements of Section 3303.14 shall apply.

3304.9 Utilities. The requirements of Section 3303.2 shall apply.

3304.10 Dewatering. ~~[The person causing the soil or foundation work to be performed shall dewater the site, as needed, for the progress of the work. Measures shall be taken to prevent settlement, slope failure, and damage to adjacent buildings, structures, and property affected by dewatering operations.]~~ The requirements of Section 3303.14 shall apply.

3304.11 Underpinning requirements. The requirements of Section 1814 and Section 3309 shall apply.

3304.12 Slurry. Where slurry is utilized to support an excavation, trench, or ~~[drill or bore hole]~~ drilled or bored hole, slurry mix proportions and installation procedures shall be provided by a registered design professional on signed and sealed design and installation procedures. The installation procedures shall account for all imposed loads, including those from the earth, adjacent structures, and adjacent equipment. ~~[The use of slurry to support excavations shall be subject to special inspection in accordance with Section 1704.20. Where such construction methods are used to install foundation elements, the new foundation elements installed as part of such operations shall be subject to special inspection as a permanent installation in accordance with the applicable sections of this chapter, including but not limited to special inspection for concrete, and welding.]~~ Where construction documents are required for the support of excavation by Section 3304.4.1, slurry mix proportions, slurry installation procedures, and slurry parameters necessary for stability, including but not limited to viscosity, unit weight, fluid loss, sand content, and pH, shall be indicated on such construction documents. The use of slurry to support excavations shall be subject to special inspection in accordance with Chapter 17.

§ 36. Section BC 3305 of the New York city building code, as added by local law number 141 for the year 2013, is amended to read as follows:

SECTION BC 3305 MATERIAL PLACEMENT AND INSTALLATION

3305.1 Scope. ~~[The placement and installation of structural steel, concrete formwork, aluminum, and masonry shall be in accordance with the requirements of this section.]~~ Materials shall be placed and installed in accordance with the requirements of this section and in a manner such that the safety of the public and property will not be endangered.

3305.1.1 Handling and storing materials. Materials to be placed or installed shall be handled and stored in such a manner as to prevent damage to the material, including but not limited to:

1. Being shipped and handled in a manner to avoid permanent deformation to the material or damage to protective coatings;
2. Being protected against corrosion that results in a loss of structural integrity; and
3. Not being dropped, thrown, or dragged.

3305.1.2 Rigging. The requirements of Section 3316.9 and rules promulgated by the commissioner shall apply to the conduct of all rigging operations.

3305.2 Structural steel assembly. Structural steel assembly shall be in accordance with the requirements of AISC 360 and the requirements of Chapter 22 and Sections 3305.2.1 through 3305.2.8 of this code.

~~3305.2.1 Shop drawings.~~ ~~[Shop drawings shall include the location of oversized, short slotted, and long slotted holes.]~~ The requirements of Section 2205.3.1 shall apply.

3305.2.2 Field connections. The requirements of Section ~~[2205.6.2]~~ 2205.3.2 shall apply.

~~3305.2.3 [Handling and storing materials.~~ ~~Structural steel members shall not be dropped, thrown, or dragged. All structural steel members shall be shipped and handled in a manner to avoid injury to protective coatings or permanent deformations of the members. Materials shall be protected against damage and corrosion that results in a loss of section.]~~ **Repair of damage.** Any ~~[injury]~~ damage to protective coatings shall be repaired prior to the application of fireproofing, the placement of concrete around the steel, or any other action that would otherwise conceal the steel. Any loss of section, bends, crimps or other evidence of permanent deformations shall be ~~[straightened]~~ repaired by methods approved by the registered design professional of record or the piece shall be rejected.

~~[3305.2.4 Placing of structural members.~~ ~~During the placing of a structural member, the load shall not be released from the hoisting rope until the member is securely supported.]~~

~~[3305.2.4.1 Open web steel joists.~~ ~~Open web steel joists that are hoisted singly shall be transferred from their place of storage directly to their permanent location and safely secured. No load shall be placed on open web steel joists until they are permanently fastened in place or otherwise secured in accordance with methods approved by the registered design professional of record.]~~

3305.2.4 Open web steel joists. The placement and installation of open web steel joists shall comply with the requirements of Sections 3305.2.4.1 through 3305.2.4.3.

3305.2.4.1 Attached to support structure. Open web steel joists shall be attached to the support structure, at least at one end on both sides of the seat, immediately upon placement in the final erection position and before additional joists are placed.

Exception: Open web steel joists that have been pre-assembled into panels with bridging shall be attached to the structure at each panel corner with sufficient bolted or welded connections before the hoisting cables are released.

3305.2.4.2 Connection to bays. Connections of individual open web steel joists to steel structures in bays of 40 feet (12 192 mm) or more shall be fabricated to allow for field bolting of connections during erection.

Exception: Open web steel-joists that have been pre-assembled into panels.

3305.2.4.3 Landing and placing loads. The landing and placing of loads on open web steel joists shall be in accordance with the following requirements:

1. No load shall be placed on open web steel joists until they are permanently fastened in place or otherwise secured in accordance with methods approved by the registered design professional of record, and the special inspector responsible for the open web steel joists has signed and dated a report indicating compliance with the requirements of this item.
2. During the construction period, the contractor shall ensure that all loads placed on the steel are distributed so as not to exceed the carrying capacity of any open web steel joist.
3. Except as provided in item number 5 below, no construction loads are allowed on the steel joists until all bridging is installed and anchored and all joist-bearing ends are attached.
4. The weight of a bundle of joist bridging shall not exceed a total of 1,000 pounds (454 kg). A bundle of joist bridging shall be placed on a minimum of three steel joists that are secured at one end. The edge of the bridging bundle shall be positioned within 1 foot (305 mm) of the secured end.
5. No bundle of decking may be placed on steel joists until all bridging has been installed and anchored and all joist bearing ends attached, unless all of the following conditions are met:
 - 5.1. The contractor has first determined from a qualified person and documented in a site-specific erection plan that the structure or portion of the structure is capable of supporting the load;
 - 5.2. The bundle of decking is placed on a minimum of three steel joists;
 - 5.3. The joists supporting the bundle of decking are attached at both ends;
 - 5.4. At least one row of bridging is installed and anchored;
 - 5.5. The total weight of the bundle of decking does not exceed 4,000 pounds (1816 kg); and
 - 5.6. Placement of the bundle of decking shall be in accordance with item number 6 below.
6. The edge of the construction load shall be placed within 1 foot (305 mm) of the bearing surface of the joist end.

3305.2.5 [Tag lines. While structural members or assemblies are being hoisted, a tag line or tag lines shall be used, as needed, to prevent uncontrolled movement.] **Reserved.**

3305.2.6 Erection of trusses. Trusses shall be braced or guyed, as necessary, for the safety of the structure.

3305.2.7 Erection of frames. Structural frames shall be properly braced with shores, guyed cables, turnbuckles, or other devices, as necessary, for the safety of the structure.

3305.2.8 Permanent flooring and steel erection in tiered buildings. The permanent floors of such buildings or other structures shall be installed as soon as possible as the erection of structural steel members progresses. In no case shall there be more than eight stories, floors or equivalent levels or 120 feet (36 576 mm), whichever is less, between the working deck and the uppermost permanent floor.

Exception: Where otherwise designed, in accordance with the approved construction documents, by the registered design professional of record.

3305.3 Concrete formwork. Concrete formwork shall be in accordance with the requirements of Sections 3305.3.1 through 3305.3.7.

3305.3.1 General requirements. The design, fabrication and erection of forms shall comply with the requirements of Sections 3305.3.1.1 through 3305.3.1.6.

3305.3.1.1 Safe support of loads. Formwork, including all related braces, shoring, framing, and auxiliary construction, shall be proportioned, erected, supported, braced, and maintained so that it will safely support all vertical and lateral loads that might be applied until such loads can be supported by the permanent construction.

3305.3.1.2 Vertical and lateral loads. Vertical and lateral loads shall be carried to the ground by the formwork system, by the new construction after it has attained adequate strength for that purpose, or by existing structures. Forms and their supports shall be designed so as not to damage previously placed structures.

3305.3.1.2.1 Use of existing structures to support vertical or lateral loads. The use of existing structures to support vertical or lateral loads imposed by concrete construction operations shall require an evaluation by a registered design professional of the adequacy of the existing structure [for] to support the loads to be imposed [by a registered design professional]. The registered design professional shall prepare design drawings documenting the findings of the evaluation, indicate the location of formwork elements, and the interface between the formwork and the existing structure. Concrete operations that utilize a stay form adjacent to a party wall, that place concrete against insulation in a seismic gap, or that utilize similar methods shall be assumed to impose a load on an existing structure, and shall always require an evaluation by a registered design professional in accordance with the requirements of this section.

3305.3.1.3 Bracing. Forms shall be properly braced or tied together so as to maintain position and shape, and shall conform to the sizes and shapes of members as shown on the design drawings.

3305.3.1.4 Ramps, runways and platforms. Ramps, runways, and platforms utilized in connection with concrete placement shall comply with Section 3315.

3305.3.1.5 Design. Concrete formwork shall be designed in accordance with Section 3305.3.2.

3305.3.1.6 Forms for prestressed and post-tensioned concrete. Forms for prestressed and post-tensioned concrete members shall be designed and constructed to permit movement of the member without damage during application of the prestressing or ~~[post-tensioned force]~~ post-tensioning forces, or during installation of the prestressing steel.

3305.3.2 Design of concrete formwork. Design of formwork, including but not limited to forms, proprietary formwork products, shores, and shoring foundations, shall comply with ACI 318, Section ~~[6.4.5]~~ 26.11, and the requirements of Sections 3305.3.2.1 through 3305.3.2.8 of this code.

3305.3.2.1 Design drawings. Site-specific formwork design drawings prepared by a registered design professional shall be required in the following cases:

1. For concrete formwork in a structure classified as a major building; [Ø]
2. Wherever the shore or form height exceeds 14 feet (4267 mm); [Ø]
3. Wherever the total vertical load on the forms exceeds 150 pounds per square foot (732 kg/m²); [Ø]
4. Wherever power buggies are used; [Ø]
5. Wherever multi-stage shores are used; [Ø]
6. Wherever the slab thicknesses or beam heights equal or exceed 10 inches (254 mm); [Ø]
7. Wherever there are concentrated loads exceeding 2000 pounds (907 kg) imposed on the formwork; or
8. Wherever there are loads imposed on existing structures in accordance with Section 3305.3.1.2.1.

Exception: Design drawings prepared by a registered design professional are not required for formwork installed in conjunction with slabs supported directly on grade or footings where such slab or footing does not impart any load on an adjacent structure.

3305.3.2.2 Vertical loads. Vertical loads shall include the total dead and live loads. Dead load shall include the weight of the formwork plus the weight of the reinforcement and fresh concrete. Live load shall allow for the weight of the workers and equipment, with allowance for impact, but in no case shall be less than 20 pounds per square foot (98 kg/m²).

3305.3.2.3 Lateral concrete pressure. Design of forms, ties and bracing shall satisfy the minimum lateral pressures of fresh concrete specified in Table 3305.3.2.3. Maximum rate of placement shall be shown on the design drawings.

3305.3.2.4 External [lateral] loads. Braces and shores shall be designed to resist all external [lateral] loads, including, but not limited to, wind, cable tensions, inclined supports, dumping of concrete, and starting and stopping of equipment. In no case shall the assumed value of lateral load [~~due to wind, dumping of concrete, and equipment~~] acting in any direction at each floorline be less than 100 plf applied along the edge or 2 percent of total dead load of the floor, whichever is greater. Except for foundation walls that are poured against a rigid backing, wall forms shall be designed for a minimum lateral load of 10 pounds per square foot (49 kg/m²), and bracing for wall forms shall be designed for a lateral load of at least 100 pounds per linear foot (148.8 kilograms per linear meter) of wall, applied at the top. The lateral load acting on walls greater than 14 feet (4267 mm) high shall be determined by analysis of conditions applicable to the site and building.

**TABLE 3305.3.2.3
MINIMUM LATERAL PRESSURES TO BE ASSUMED FOR FRESH CONCRETE WEIGHING 150
POUNDS PER CUBIC FOOT^{a,b,c}**

Type of Work	Minimum Lateral Pressure Assumed (psf)	Limitations
Columns: Ordinary work with normal internal vibration	$p = 150 + (9000R/T)$	Maximum 3,000 psf or 150 <i>h</i> , whichever is less
Walls: Rate of placement at 7 feet per hour or less	$p = 150 + (9000R/T)$	Maximum 2,000 psf or 150 <i>h</i> , whichever is less
Walls: Rate of placement at greater than 7 feet per hour	$p = 150 + (43400/T) + (2800R/T)$	Maximum 2,000 psf or 150 <i>h</i> , whichever is less
Slabs	$p = 150h$	None

For SI: 1 inch = 25.4 mm, 1 foot per second = 0.305 m/s, 1 pound per cubic foot = 16.02 kg/m³, 1 pound per square foot = 4.882 kg/m², °C = (°F - 32)/1.8.

where:

R = rate of placement, feet per hour.

T = temperature of concrete in the forms, °F.

h = height of fresh concrete above point considered, feet.

- a. Allowances for change in lateral pressure shall be made for concrete weighing other than 150 pcf; for concrete containing pozzolanic additions or cements other than Type I, for concrete having slumps greater than 6 inches, or for concrete consolidated by revibration or external vibration of forms.
- b. Where retarding admixtures are employed under hot weather conditions, an effective value of temperature less than that of the concrete in the forms shall be used in the above formula.
- c. If retarding admixtures are used in cold weather, the lateral pressure may be assumed as that exerted by a fluid weighing 150 pcf.

3305.3.2.5 Special loads. The formwork shall be designed for any special conditions of construction likely to occur, such as asymmetrical placement of concrete, impact of machine-delivered concrete, uplift and concentrated loads.

3305.3.2.6 Shoring and bracing. Shoring and bracing shall comply with Sections 3305.3.2.6.1 through 3305.3.2.6.4.

3305.3.2.6.1 Approval. When patented or commercial devices that are not susceptible to design are used for shoring, bracing, or splicing, they shall be approved by the commissioner.

3305.3.2.6.2 Splices. Splices shall develop the full strength of the spliced members.

3305.3.2.6.3 Bracing. Where shore height exceeds 10 feet (3048 mm), or when necessary to provide structural stability, diagonal bracing shall be provided. Struts, anchored into masonry or to panel joints of adjacent braced bays may be used to prevent buckling of individual members not supported by the diagonal bracing, but bracing an entire tier of shores with struts without diagonal bracing shall be prohibited unless the system can be demonstrated to be braced by other rigid construction.

3305.3.2.6.4 Unbraced length of shores. The unbraced length of shores shall not exceed the maximum length determined in accordance with the requirements of this code for the structural material used.

3305.3.2.7 Foundations. Foundations for shores more than 10 feet (3048 mm) high and supported on the ground shall be designed by a registered design professional.

3305.3.2.8 Settlement. Formwork shall be so constructed that vertical adjustments can be made to compensate for take-up and settlements. Wedges, jacks or other positive means shall be provided for this purpose.

3305.3.3 Formwork inspection and observation. Formwork shall be inspected and observed in accordance with the requirements of Sections 3305.3.3.1 [~~and 3305.3.3.2~~] through 3305.3.3.3.

3305.3.3.1 Inspection by contractor. Formwork, including shores, reshores, braces and other supports, shall be inspected prior to placement of reinforcing steel to verify the adequacy and proper installation of the formwork, and where construction documents and form design drawings are provided, that [they conform] the formwork conforms to the construction documents and form design drawings. Subsequently, during and after concreting, periodic inspections shall be performed to detect incipient problems, and the elevations, camber, and vertical alignment of formwork systems shall be inspected using tell-tale devices. Such inspections shall be performed by a qualified person designated by the contractor; nothing shall prohibit the concrete safety manager from performing such inspection where so designated. [~~Subsequently, inspections shall be performed by such person periodically during the placement of concrete. During and after concreting, the elevations, camber, and vertical alignment of formwork systems shall be inspected using tell-tale devices. A record of all such inspections shall be kept at the site available to the commissioner.~~] The results of such inspections shall be documented in an inspection report signed and dated by the qualified person who performed the inspection. The names of the persons responsible for such inspections and the foreman in charge of the formwork shall be posted in the field office.

3305.3.3.2 Formwork observation. In addition to the inspections by the contractor required pursuant to Section 3305.3.3.1, visual observations of the formwork for the general conformance with the design intent shall be performed by:

1. The formwork designer;
2. An employee of the formwork designer under his or her direct supervision;
3. A registered design professional retained by the formwork designer; or
4. An employee of such retained registered design professional under the direct supervision of such retained registered design professional.

Exceptions: Formwork observation pursuant to Section 3305.3.3.2 shall not be required for:

1. Formwork that does not require design drawings pursuant to Section 3305.3.2.1; and
2. One- two- and three-family dwellings and accessory uses to such buildings.

3305.3.3.2.1 Intervals. Formwork shall be observed at intervals permitting observation of representative configurations throughout the project duration. The formwork designer shall maintain a log of such observations at the construction site. At a minimum, observations shall be made:

1. Immediately after formwork related incidents or violations are issued; and
2. When concrete construction operations are significantly modified such as changes to form materials, concrete placement cycle, or form and support layout prior to use of the change.

3305.3.3.2.2 Discrepancies from the formwork design. Where the individual performing the formwork observation pursuant to Section 3305.3.3.2 discovers a discrepancy from the formwork design, such discrepancy shall be immediately brought to the attention of the concrete contractor. The concrete contractor shall be responsible for correcting the discrepancy. In addition, the site safety manager, site safety coordinator, and concrete safety manager, as applicable, shall be notified of discrepancies from the formwork design that relate to site safety. Follow-up observations to confirm corrective action has been taken shall be made by the formwork designer or his or her qualified designee pursuant to Section 3305.3.3.2.

3305.3.3.2.3 Hazardous formwork conditions. Where an observed formwork condition hazardous to life, safety, or health is not immediately corrected by the responsible contractor, the formwork designer or his or her qualified designee pursuant to Section 3305.3.3.2 shall immediately report such hazardous formwork condition and such failure to correct the hazardous formwork condition to the commissioner.

3305.3.3.3 Special inspection. The requirements of Chapter 17 shall apply.

3305.3.4 Construction. Concrete formwork, including but not limited to forms, shores, and shoring foundations, shall be constructed in conformance with the design drawings, where such drawings are required by Section 3305.3.2.1, and shall also be constructed to comply with the requirements of Sections 3305.3.4.1 through 3305.3.4.5.

3305.3.4.1 Field-constructed lap splices. Field-constructed lap splices, other than approved devices, shall not be used more often than for every other shore under slabs or for every third shore under beams and shall develop the full strength of the members. Such spliced shores shall be uniformly distributed throughout the work. Splices shall not be located near the midheight of the shores unless lateral support is provided, nor midway between points of lateral support.

3305.3.4.2 Vertical shores. Vertical shores incorporated in multi-stage shores shall be set plumb and in alignment with lower tiers so that loads from upper tiers are transferred directly to the lower tiers, or adequate transfer members shall be provided. Provision shall be made to transfer the lateral loads to the ground or to completed construction of adequate strength. Vertical shores shall be so erected that they cannot tilt, and shall have firm bearing. Inclined shores and the bearing ends of all shores shall be braced against slipping or sliding. The bearing surfaces shall be cut square and have a tight fit at splices.

3305.3.4.3 Runways. Runways for moving equipment shall be provided with struts or legs as required and shall be supported directly on the formwork or structural member and not on the reinforcement.

3305.3.4.4 Unsafe conditions. Any unsafe condition or necessary adjustment revealed by inspection shall be remedied immediately. If, during construction, any weakness develops and the formwork shows any undue settlement or distortion, the work shall be stopped, the affected construction removed if permanently damaged, and the formwork strengthened.

3305.3.4.5 ~~[Perimeter formwork]~~ Formwork interconnection. Horizontal formwork deck panels and beam formwork ~~[located within 16 feet (4877 mm) from the building perimeter]~~ shall be positively ~~[attached]~~ connected to all formwork support systems ~~[at a minimum]~~. Connections located within 16 feet (4877 mm) from the building perimeter shall be installed continuously throughout the day as the formwork is installed and shall be in place prior to the end of the shift.

3305.3.5 Removal of forms and shoring. The removal of forms and shoring shall comply with the requirements of Sections 3305.3.5.1 through 3305.3.5.6.

3305.3.5.1 Removal schedule. Before starting construction, the contractor shall develop a procedure and schedule for removal of shores and installation of reshores and for calculating the loads transferred to the structure during the process.

3305.3.5.1.1 Data and analysis. The structural analysis and concrete strength data used in planning and implementing form removal and reshoring shall be furnished by the registered design professional responsible for the removal schedule to the commissioner when so requested.

3305.3.5.1.2 Support and removal. No construction loads shall be supported on, nor any shoring removed from, any part of the structure under construction except when that portion of the structure in combination with the remaining forming and shoring system has sufficient strength to support safely its weight and the loads placed thereon.

3305.3.5.1.3 Concrete strength. Sufficient strength shall be demonstrated by structural analysis of the proposed loads, the strength of the forming and shoring system, and concrete strength data. Concrete strength data shall be based on tests of field-cured cylinders ~~[or, when approved by the commissioner, on other procedures for evaluating concrete strength]~~. As an alternative, the concrete strength is permitted to be estimated using the maturity method performed in accordance with ASTM C1074, provided that the strength is at least 500 psi (3447.38 kPa) higher than the specified compressive strength necessary for formwork or shoring removal, as applicable. Other procedures for evaluating concrete strength are also permitted when approved by the commissioner.

3305.3.5.2 Construction loads. No construction loads exceeding the combination of superimposed dead load plus specified live load shall be supported on any unshored portion of the structure under construction, unless analysis indicates adequate strength to support such additional loads.

3305.3.5.3 Prestressed members. Form supports for prestressed concrete members shall not be removed until sufficient prestressing has been applied to prestressed members to carry their dead load, ~~and~~ anticipated construction loads, and prestress transfer forces.

3305.3.5.4 Manner of removal. Forms shall be removed in such a manner as to ~~[assure]~~ ensure the complete safety of the public and property.

3305.3.5.5 Shores support. Where the structure as a whole is supported on shores, beam and girder sides, columns and similar vertical forms may be removed after the concrete is sufficiently hard to withstand damage from the removal. In no case shall the supporting forms or shoring be removed until the members have acquired sufficient strength to safely support ~~[safely]~~ their weight and the load thereon.

3305.3.5.6 Control tests. The results of control tests, including concrete cylinder specimens prepared in accordance with ASTM C 31, cast-in-place cores, or other device that will produce test specimens representative of the condition of the concrete in place, of suitable size and proportions, and approved by the registered design professional of record shall be evidence that the concrete has attained sufficient strength or the strength as may be specified on the drawings.

3305.3.6 Reshoring. Reshoring shall be provided to support the construction where forms and shores are stripped before the concrete has attained sufficient strength to support the superimposed loads due to construction above. Reshoring shall comply with Sections 3305.3.6.1 through 3305.3.6.8.

3305.3.6.1 Reshores limitations. Reshores shall comply with the requirements of Sections 3305.3.6.1.1 through 3305.3.6.1.7.

3305.3.6.1.1 Secureness of reshores. Reshores of wood or metal shall be screw adjusted or jacked and locked and wedged to make them secure. Reshores shall not be jacked or screwed so tightly that they preload the floor below or remove the normal deflection of the slab above.

3305.3.6.1.2 Reshores in proximity to unenclosed perimeters. Reshores within 10 feet (3048 mm) of an unenclosed perimeter of a building shall be secured to prevent them from falling off the building.

3305.3.6.1.3 Wedges. Wedges shall not be used within 10 feet (3048 mm) of the façade or at such other locations as determined by the commissioner.

3305.3.6.1.4 Stresses. In no case shall shores be so located as to alter the pattern of stresses determined in the original structural analysis or to induce tensile stresses where reinforcing bars are not provided.

3305.3.6.1.5 Angle to surface. Reshores shall be perpendicular to the surface that they are supporting.

3305.3.6.1.6 Adjusting devices. Adjusting devices shall not be used if heavily rusted, bent, dented, rewelded or having broken weldments or other defects.

3305.3.6.1.7 Metal shoring and accessory parts. Metal shoring and accessory parts shall be fully operative when in use.

3305.3.6.2 Site safety provisions. Reshoring shall comply with the requirements of Sections 3305.3.6.2.1 through 3305.3.6.2.3.

3305.3.6.2.1 Emergency. Extra shores or material and equipment that might be needed in an emergency shall be furnished.

3305.3.6.2.2 Stripping. Care shall be taken while stripping is underway to [~~insure~~] ensure that material does not fall off the building.

3305.3.6.2.3 Building materials. Building materials shall be properly piled and tied or contained.

3305.3.6.3 Bracing. Lateral bracing shall be provided during reshoring operations, and reshores shall be located as close as practical to the same position on each floor to provide continuous support from floor to floor.

3305.3.6.4 Reshoring beam and girder construction. Where reshoring of beam and girder construction is required, the forms shall not be removed from more than one girder at a time, and the girder shall be reshored before any other supports are removed. After the supporting girders are reshored, the form shall be removed from one beam with its adjacent slabs and the beam shall be reshored before any other supports are removed. Slabs spanning 10 feet (3048 mm) or more shall be reshored along the centerline of the span.

3305.3.6.5 Reshoring flat slabs. Where reshoring of flat-slab construction is required, the formwork cannot be stripped until the concrete has acquired sufficient strength to safely support its weight and the load thereon, or temporary preshores are provided supporting the slab at intervals of no more than 8 feet (2438 mm) on center to be replaced by reshores prior to placing concrete on the floor above. Reshores must be installed and remain in place until the concrete reaches full or sufficient strength to sustain the superimposed loads to which the concrete will be subjected.

3305.3.6.6 Stripping operation. Debris generated as a result of stripping operations shall be immediately contained and removed at reasonable intervals. Stripping operations on concrete structures shall not be performed more than three stories below the story being formed.

3305.3.6.7 Prestressed construction. Solid safety shields shall be provided at end anchorages of prestressing beds, or where necessary, for protection against breakage of prestressing strands, cables, or other assemblies during prestressing or casting operations.

3305.3.6.8 Reshoring schedule. A signed and sealed reshoring schedule shall be provided and maintained at the construction site whenever reshoring is employed.

Exception: A separate reshoring schedule is not required when the required reshoring information is covered on the approved construction documents prepared by the applicant of record.

3305.3.7 Alternate methods. The contractor may submit alternate methods of stripping, shoring, reshoring, and strength control for approval by the registered design professional of record, subject to review by the commissioner.

3305.4 Precast concrete construction. Precast concrete members shall be adequately braced and supported during erection to ensure proper alignment and structural integrity until permanent connections are completed.

3305.4.1 Cracking or deflections. Any cracking or deflections inconsistent with the design drawings observed during handling shall be subject to assessment by a registered design professional prior to erection.

3305.4.2 Design of temporary shores. Temporary shores shall be designed by a registered design professional.

~~[3305.4]~~ **3305.5 Aluminum erection.** In addition to the requirements of Section 2002, the erection of aluminum used for structural purposes shall comply with the requirements of Sections ~~[3305.4.1]~~ 3305.5.1 through ~~[3305.4.4]~~ 3305.5.4.

~~[3305.4.1 Plumb.~~ All framework shall be carried up true and plumb.] **3305.5.1 Reserved.**

~~[3305.4.2]~~ **3305.5.2 Temporary bracing.** Temporary bracing shall be provided to support all loads imposed upon the framework during construction that are in excess of those for which the framework was designed.

~~[3305.4.3]~~ **3305.5.3 Temporary connections.** As erection progresses, the work shall be securely bolted or welded to resist all dead loads, wind, and erection stresses.

~~[3305.4.4]~~ **3305.5.4 Alignment.** The structure shall be properly aligned before riveting, permanent bolting, or welding is performed.

~~[3305.5]~~ **3305.6 Masonry erection.** The requirements of Section ~~[2104.6]~~ 2104.5 shall apply.

3305.7 Wood construction. The requirements of Section 2304 shall apply.

§ 37. Section BC 3306 of the New York city building code, as amended by local law number 141 for the year 2013, is amended to read as follows:

SECTION BC 3306 DEMOLITION

3306.1 Scope. All full demolition and partial demolition operations shall be performed in accordance with the requirements of this section so that the safety of the public and property will not be endangered by demolition operations.

3306.2 Protection of pedestrians and adjoining property. Demolition operations shall not commence until the applicable pedestrian and adjoining property protection is in place as required by Sections 3307, 3308, and 3309. In addition, safety zones and measures to prevent access shall be implemented as required by Sections 3306.2.1 and 3306.2.2.

~~[3306.2.1 Safety zone. A safety zone shall be provided around all demolition areas to prevent persons other than workers from entering such zone. Where demolition occurs on the exterior of a building, such zone shall be approved by the commissioner prior to the commencement of demolition.]~~

3306.2.1 Preventing access. The permit holder, or where there is no permit holder, the person causing the demolition work to be performed, shall institute and maintain measures to prevent persons other than workers from entering areas where demolition work is occurring, debris is stored, or equipment is located.

3306.2.2 Safety zone for exterior demolition. Where demolition work occurs on the exterior of a building, the permit holder, or where there is no permit holder, the person causing the demolition work to be performed, shall institute and maintain a safety zone around the site to prevent persons other than workers from entering such safety zone. Where the safety zone precludes access to the entire demolition site, it shall be considered to satisfy the requirements of Section 3306.2.1.

Exception: A safety zone is not required for the following types of work. Relief from the safety zone requirements does not grant relief from applicable pedestrian and adjoining property protection required by Sections 3307, 3308, and 3309, nor from the requirements of Section 3306.2.1.

1. Demolition work whose scope is limited to a minor alteration or ordinary repair, and is accomplished without any mechanical demolition equipment, other than handheld devices.
2. Work whose scope is limited to the alteration, maintenance, or repair of a façade, and which does not constitute a façade recladding as defined in rules promulgated by the commissioner, and is accomplished without any mechanical demolition equipment, other than handheld devices.
3. Demolition work accomplished without any mechanical demolition equipment, other than handheld devices, provided the entire exposure where demolition work is to occur is covered by either:
 - 3.1. A supported scaffold with netting and guardrails in accordance with Section 3314.8; or
 - 3.2. A site specific engineered enclosure system in accordance with Section 3309.17.

3306.2.2.1 Approval of the commissioner. Where a safety zone is required by Section 3306.2.2, it shall be approved by the commissioner.

3306.2.2.2 Size of safety zone for mechanical demolition. Where mechanical demolition equipment, other than handheld devices, is to be used for the full or partial demolition of a building, the safety zone shall be equal to or greater than half the height of the building to be demolished; such safety zone may be reduced by the same ratio as the building is being demolished.

~~[**Exception:** Approval of the commissioner is not required for a safety zone established for demolition on the exterior of a building, provided the work is a minor alteration or ordinary repair and is accomplished without any mechanical demolition equipment, other than handheld devices.]~~

3306.3 Notification. The permit holder shall notify the department and adjoining [~~building~~] property owners prior to the commencement of full and partial demolition operations in accordance with Sections 3306.3.1 and 3306.3.2.

Exceptions:

1. Notification to the department or adjoining property owners is not required for partial demolition operations limited to the interior components of a building provided no mechanical demolition equipment, other than handheld devices, are used.
2. Notification to the department or adjoining property owners is not required for partial demolition that occurs on the exterior of a building, provided such work is a minor alteration or ordinary repair, and is accomplished without any mechanical demolition equipment, other than handheld devices.

3306.3.1 Notification of the department. The permit holder shall notify the department via phone or electronically at least 24 hours, but no more than 48 hours prior to the commencement

of such work. If the notification date falls on a weekend or official holiday, the permit holder shall notify the department on the last business day before the commencement date.

3306.3.2 Notification of adjoining property owners. Adjoining property owners shall be notified of upcoming demolition operations in writing not less than 10 days prior to the scheduled starting date of the demolition. The written notice shall provide a description of the work to be performed, the timeframe and schedule, and contact information of the person causing the demolition work and of the department. Demolition or removal work that is to be done with the use of explosives shall also be subject to the notification requirements set forth in the *New York City Fire Code*.

3306.4 Mechanical demolition equipment. Where mechanical demolition equipment, other than handheld devices, is to be used in the full or partial demolition of a building or structure, or is to be used within a structure to remove debris or move material, approval of the commissioner for the use of the mechanical demolition equipment must be obtained prior to the commencement of demolition operations.

Exception: Approval of the commissioner is not required where the structure has been demolished to grade and mechanical equipment, located on the ground or a slab on grade, is utilized to remove the slab or foundation of the structure or to remove debris or move material.

3306.5 Submittal documents for demolition. Full and partial demolition operations shall be conducted in accordance with submittal documents. Such submittal documents shall comply with Sections 3306.5.1 through ~~[3306.5.3]~~ 3306.5.7.

Exceptions: Section 3306.5 shall not apply to:

1. Demolitions performed as emergency work pursuant to Section 28-215.1 of the *Administrative Code* when such work is monitored by a qualified person with experience in demolition operations who is employed by the city agency that has been directed to perform or arrange for the performance of such work. If the department or such city agency determines that there is a need for supervision of the work by a registered design professional, such city agency shall retain a registered design professional or cause a registered design professional to be retained to supervise the demolition operations.
2. The full demolition of a detached one-, two-, or three-family dwelling, or both halves of a semi-detached one-, two-, or three-family dwelling, or a detached accessory ~~[use]~~ structure to a one-, two-, or three-family dwelling, provided such dwelling or accessory ~~[use]~~ structure is three stories or fewer in height, and also provided that the demolition is to be accomplished without any mechanical demolition equipment, other than handheld devices.
- ~~[3. The removal, with mechanical demolition equipment, of foundations and landscaping elements, including but not limited to foundation walls, slabs, stoops, driveways, or pools supporting or accessory to a detached or semi-detached one-, two-, or three-family dwelling.]~~
- ~~[4.]~~ 3. The full demolition of a fully detached building that is three stories or fewer and with a floor area of 5,000 square feet (464.5 m²) or less per story, provided such demolition is to

be accomplished without any mechanical demolition equipment, other than handheld devices.

4. The removal, with mechanical demolition equipment, of the remaining slab or foundation of a structure described in exemption 2 or 3 above once the structure has been demolished to grade, or the removal of landscaping elements, on grade parking or driveways, or pools that are accessory to a structure described in exemption 2 or 3 above, provided during all such removal work the mechanical demolition equipment is located on the ground or a slab on grade.
5. Partial demolition operations accomplished without any mechanical demolition equipment, other than handheld devices, provided such work is a minor alteration or ordinary repair.
6. Demolition operations that do not require a permit.

3306.5.1 Required documents. Submittal documents shall be approved by the department before demolition work begins. Such submittal documents shall be signed, sealed, and submitted by a registered design professional and shall contain, at a minimum, the following:

1. Basic structure of the building, or portion thereof, to be demolished, including general sizes and types of main structural members and an identification of the general structural lateral system;
2. A statement that the condition of the existing structure to be demolished has been assessed and a determination regarding whether it is a weakened structure in accordance with Section 3306.7;
3. Plans, sections, and details of the building, or portion thereof, to be demolished clearly showing the extent and sequence of the demolition[;], including, but not limited to:
 - 3.1. Work involving a full demolition, a demolition performed in conjunction with work that meets the requirements of Article 101.4.5 of Title 28 of the *Administrative Code*, a demolition that results in the demolition of more than 50 percent of the gross floor area of the building during the course of work over any 12-month period, or a demolition that results in the removal of one or more floors during the course of work over any 12-month period, a clear and detailed demolition sequence provided in narrative and illustrated in the plans shall also be provided. All phases shall be designated by a number or letter to clearly depict the required sequence of the work. Structural stability must be demonstrated through all phases of demolition. A “preparation phase” must be included indicating but not limited to the following: glass removal, sealing of windows, removal of equipment/fixtures, and cutting of services. A note must indicate that any required permits for termination of services will be obtained, including necessary Fire Department and Department of Buildings variances.
 - 3.2. Work involving a full demolition, or for a partial demolition that razes a portion of a building to grade, plan and section views detailing the end-of-demolition conditions, including any remaining foundation elements and means of stabilizing those elements

and the adjoining property via complete backfill, berms, shoring/bracing, or a similar approved method, shall be provided.

3.3. Work involving a demolition that involves the removal of foundation elements, a detailed section showing the elevation of the footings of the building being demolished as it relates to the footings of all adjoining property shall be provided.

3.4. Work involving a demolition that involves an excavation component or the removal of foundation elements, a sequence showing coordination between the demolition work and the installation of sheeting, shoring, bracing, underpinning, berming, backfill, or other methods of supporting excavations and/or adjoining property shall be provided.

~~[2-]~~ 4. Bracing, ~~and~~ shoring, and other stabilization measures necessary to support all demolition operations, and adjoining ground, or structures, as needed, through all sequences of the demolition. If shoring, bracing, or other stabilization measures must be taken prior to demolition, a clear and detailed sequence of this work, along with clear identification that this work is required to be performed prior to the start of any demolition activity shall be included;

5. Where interior walls are to be demolished, a statement shall be provided indicating that the removal of the interior walls has been coordinated with the load capacity of the exterior walls and floors;

6. Partitions required for the stability of the structure or required for egress shall be clearly indicated on the plans, and the sequence of operations shall indicate when the partitions can be safely removed;

~~[3-]~~ 7. Where mechanical demolition equipment, other than handheld devices, is to be used, a listing and description of all such proposed equipment to be used in the demolition, including the scope of equipment work and positioning of equipment on the existing structure. The description of the equipment shall include the gross weight of the equipment and calculations showing the adequacy of the existing structure to support loads imposed by such equipment. Any conditions imposed on the use or position of the equipment must be noted. If more than one piece of demolition equipment is proposed to be used at the same time, the effect of the simultaneous loads imposed on the existing structure shall be described and investigated. The plans may allow for alternate types of equipment within the same weight range and type. Such alternatives must be listed on the plans. A list of cranes to be utilized, if applicable, must also be provided, including their location along with a note that any department-required permit for the crane shall be obtained; ~~and~~

~~[4-]~~ 8. A description of compliance with the applicable provisions of Sections 3306.8 and 3306.9 of this code[-];

9. A statement regarding whether the building where demolition operations are to occur shares a party wall or party foundation with an adjoining structure;

10. For demolition work that occurs on the exterior of a building, or for demolition operations that will disturb elements shared between buildings, including but not limited to party walls

- or party foundations, the adjoining properties shall be indicated, with property lines, addresses, block and lot numbers, stories and heights of all buildings, and horizontal offset dimensions of all adjacent structures from the property lines of structure being demolished and from the structure clearly shown. Any encroachments on adjoining property, including but not limited to fencing, barriers, or safety zones, along with a note stating that permission shall be obtained from the adjoining property owner, shall also be clearly indicated;
11. Pedestrian protection, unenclosed perimeter protection, or adjoining property protection installed in accordance with Sections 3307, 3308, or 3309, including but not limited to, as applicable:
 - 11.1. Fencing/gates, including type, location, and dimensions, as well as the location of the project information sign on the fence;
 - 11.2. Sidewalk sheds, including locations and dimensions;
 - 11.3. Supported scaffolding and netting, including heights above the building being demolished, details of anchorage to building, and netting type; and
 - 11.4. Adjoining roof, mechanical equipment, and yard protection, including types, locations, and dimensions.
 12. The boundaries of the demolition work zone and demolition safety zone, as required by Section 3306.2, and the method of defining those zones and preventing access (e.g. fencing, barriers, etc.);
 13. All means and methods of debris removal from the point of demolition to the public roadway (carting), including openings in floors, chutes, etc, as well as the location of any debris sorting operation and barriers to separate the operation from other demolition activity;
 14. Means of egress for all phases of the demolition;
 15. The elevator or hoist in readiness, if required;
 16. Measures to protect, stabilize, and brace, as necessary, fire escapes, cornices, flues, and chimneys;
 17. Where fire separation elements are to be breached or diminished during demolition operations in an occupied building, or between adjoining occupied or unoccupied buildings, temporary measures to maintain fire separation;
 18. The methods of remediating adjoining lot line walls, including weatherproofing, repair, floor-to-wall anchorage, etc.;
 19. A listing of required special inspections;
 20. Application numbers for associated filings (e.g. fencing, pedestrian protection, adjoining property protection, scaffolding, netting, underpinning, support of excavation, etc.); and

21. Reference to the monitoring plan, when a monitoring plan is required by Section 3306.12.

~~[**Exception:** For a partial demolition using mechanical demolition equipment, the bracing and shoring details required by Item 2 above may be included on signed and sealed shop drawings to be kept on site, separate and apart from the submittal documents, provided the allowance for shop drawings is designated on the submittal documents.]~~

3306.5.1.1 Submittal documents for full or partial demolition using mechanical equipment other than handheld. Submittal documents for full or partial demolition using mechanical equipment other than handheld shall be signed, sealed and submitted by a registered design professional.

3306.5.2 Maintenance of submittal documents. The approved set of submittal documents shall be kept at the site at all times and be accessible for inspection in accordance with Section 3301.7. It shall be a violation of this code to use mechanical equipment, whether handheld or other than handheld, to perform full or partial demolitions unless the approved submittal documents required by Section 3306.5.1 are available for inspection. Failure to make submittal documents available on site may result in the issuance of a stop work order.

3306.5.3 Filing requirements. Where submittal documents are required in connection with full or partial demolition in accordance with Section 3306.5, applications shall be filed by the registered design professional in accordance with Article 104 of Chapter 1 of Title 28 of the *Administrative Code* and shall be approved prior to issuance of the work permit.

3306.5.4 Assessment of structure to be demolished. Submittal documents required by Section 3306.5 shall be based upon an assessment of the structure where demolition operations are to occur. The assessment shall be performed by a registered design professional. The assessment shall, at a minimum, consist of an interior and exterior physical inspection of the structure where demolition operations are to occur, in which all areas to be demolished are accessed during the inspection. The results of the assessment shall be documented in an assessment report prepared by the person who performed the assessment. If the assessment was performed by a registered design professional other than the registered design professional who prepares the submittal documents, the report shall be provided to the registered design professional who prepares the submittal documents.

3306.5.5 Assessment of adjoining structures. Where a bearing masonry or wood framed building shares a party wall or party foundation with a building that is to undergo a full demolition, a demolition performed in conjunction with work that meets the requirements of Section 101.4.5 of Title 28 of the *Administrative Code*, a demolition that results in the demolition of more than 50 percent of the gross floor area of the building during the course of work over any 12-month period, or a demolition that results in the removal of one or more floors during the course of work over any 12-month period, the submittal documents required by Section 3306.5 shall be based upon an assessment of such bearing masonry or wood framed building. The assessment shall be performed by a registered design professional. The assessment shall, at a minimum, consist of an interior and exterior visual inspection of the structure where demolition operations are to occur. The results of the assessment shall be documented in an assessment report prepared by the person who performed the assessment. If the assessment was performed by a registered design professional other than the registered design professional who prepares the

submittal documents, the report shall be provided to the registered design professional who prepares the submittal documents.

3306.5.6 Review of pertinent plans and records. Submittal documents required by Section 3306.5 shall be based upon a review of all pertinent plans and records of the structure where demolition operations are to occur. In addition, where a building is to undergo a full demolition, a demolition performed in conjunction with work that meets the requirements of Section 101.4.5 of Title 28 of the *Administrative Code*, a demolition that results in the demolition of more than 50 percent of the gross floor area of the building during the course of work over any 12-month period, or a demolition that results in the removal of one or more floors during the course of work over any 12-month period, the submittal documents shall further be based upon a review of all pertinent plans and records of all adjoining structures. The review shall be performed by the registered design professional who prepares the submittal documents.

3306.5.7 Incorporate all other relevant reports. The demolition submittal documents must incorporate all the conditions and findings identified in the geotechnical report when such report is required by Section 1803.6, the evaluation analysis when such analysis is required by Section 1817, the assessment reports required by Section 3306.5.4 and 3306.5.5, and the preconstruction survey when such survey is required by Section 3309.4.3.

3306.6 Special inspection. Demolition shall be subject to special inspection in accordance with Chapter 17.

3306.7 Demolition of weakened structures. Where a structure to be demolished has been partially wrecked or weakened by fire, flood, explosion, age, or other causes, it shall be shored or braced to the extent necessary to permit orderly full demolition or partial demolition without collapse. The necessary measures to ensure a safe demolition shall be determined by the owner's registered design professional and shall be approved by the commissioner.

Exception: Shoring or bracing are not required for the full demolition of a building, subject to the approval of the commissioner, provided:

1. The demolition is conducted with mechanical demolition equipment, other than handheld devices; and
2. No demolition operation occurs, or equipment is located, within the structure of the building.

3306.8 Demolition sequence. Any structural member that is being dismembered shall not support any load other than its own weight. No wall, chimney, or other structural part shall be left in such condition that it may collapse or be toppled by wind, vibration or any other cause. The method of removal of any structural member shall not destabilize remaining members. All handling and movement of material or debris shall be controlled such that it will not develop unaccounted impact loads on the structure.

3306.8.1 Structural steel, reinforced concrete, and heavy timber buildings. Structural steel, reinforced concrete, and heavy timber buildings, or portions thereof, shall be demolished column

length-by-column length and tier-by-tier. Structural members shall be chained or lashed in place to prevent any uncontrolled swing or drop.

Exception: Where the design applicant who prepared the submittal documents required by Section 3306.5 has demonstrated the adequacy of alternate means of demolition through plans, calculations, or the establishment of safety zones, as appropriate, the commissioner may accept such alternative means of demolition.

3306.8.2 Masonry buildings with wooden floors. Demolition of masonry buildings with wooden floors shall comply with the following requirements:

1. Demolition of walls and partitions shall proceed in a systematic manner, and all work above each tier of floor beams shall be completed before any of the supporting structural members are disturbed.
2. Sections of masonry walls shall not be loosened or permitted to fall in such masses as to affect the carrying capacity of floors or the stability of structural supports.
3. No section of masonry wall with a height [~~more than 22 times its~~] to thickness ratio greater than 22 shall be permitted to stand without [~~bracing~~] the wall being braced. Such bracing shall be designed by a registered design professional.

3306.9 Safeguards. Demolition shall be conducted in accordance with the requirements of Sections 3306.9.1 through [~~3306.9.14~~] 3306.9.16.

3306.9.1 Utilities and service lines. The requirements of Section 3303.2 shall apply.

3306.9.2 Party wall exits, fire exits. The requirements of Section 3303.9 shall apply.

3306.9.3 Dust. Dust producing operations shall be wetted down to the extent necessary to control the dust.

3306.9.4 Water accumulation. The requirements of Section 3303.14 shall apply.

3306.9.5 Temporary elevators and standpipe systems. The requirements of Sections 3303.8 and 3303.12 shall apply.

3306.9.6 Sprinkler systems. The requirements of Section 3303.7.4 shall apply.

3306.9.7 Use of explosives. The use of explosives in demolition operations shall conform to the requirements and limitations imposed by the *New York City Fire Code* and Section 3312.

3306.9.8 Hazards to be removed. Prior to the commencement of demolition operations, hazards shall be removed in accordance with Sections 3306.9.8.1 through 3306.9.8.4.

3306.9.8.1 Combustible content. Prior to the commencement of demolition operations, the area authorized to be demolished by the work permit shall be thoroughly cleaned of combustible content and debris, including but not limited to building contents and exterior finishes, down to the structural elements.

3306.9.8.2 Asbestos. Prior to the commencement of demolition operations, all asbestos shall be removed from the area authorized to be demolished by the department work permit, and certification to that effect shall be filed with the department and the Department of Environmental Protection. Such asbestos removal shall be in accordance with Section 28-106 of the *Administrative Code* and rules promulgated by the commissioner of the Department of Environmental Protection.

3306.9.8.3 Glass. Prior to the commencement of demolition operations, all glass located in the area authorized to be demolished by the work permit, including but not limited to glass in windows, doors, skylights, and fixtures, shall be removed.

Exception: Demolition operations relating to the alteration, maintenance, or repair of a façade.

3306.9.8.4 Steam and fuel. Prior to the commencement of demolition operations, all pipes, tanks, boilers, or similar devices containing steam or fuel and located in the area authorized to be demolished by the work permit shall be purged of such steam or fuel.

Exception: Pipes, tanks, boilers, or similar devices containing steam or fuel located in the area authorized to be demolished by the work permit and which will not be disturbed during the course of the demolition operation may, in lieu of being purged, be safeguarded so as to prevent their being damaged during the course of demolition operations.

3306.9.9 Stairs. All enclosed vertical shafts and stairs shall be maintained enclosed at all floors except the [~~uppermost~~] topmost floor being demolished, and all work on the [~~uppermost~~] topmost floor shall be completed before stair and shaft enclosures on the floor below are disturbed. All hand rails and banisters shall be left in place until actual demolition of such floor is in progress.

3306.9.10 Floors. The safeguards of Sections 3306.9.10.1 through 3306.9.10.3 shall apply to demolition operations involving floors.

3306.9.10.1 Bearing partitions and headers. No bearing partition shall be removed from any floor until the floor framing system on the floor above has been removed and lowered. All header beams and headers at stair openings and chimneys shall be carefully examined and, where required, shall be shored from the cellar floor through successive floors. All operations shall be continually monitored by a qualified person designated by the permit holder as the work progresses to detect any hazards that may develop.

3306.9.10.2 Floor openings not to aggregate more than 25 percent of the gross floor area. Openings in any floor shall not aggregate more than 25 percent of the area of that floor unless it can be shown by submission from a registered design professional to the satisfaction of the commissioner that larger openings will not impair the stability of the structure.

3306.9.10.3 [~~Protection of floor~~] Covering of floor openings. Floor openings used for the removal of debris shall comply with Section 3306.9.12.1. Every opening not used for the removal of debris in any floor shall be clearly marked and solidly planked over by planking not less than 2 inches (51 mm) in thickness, or equivalent solid material, [~~and~~] laid close.

3306.9.11 Storage of material. Material shall not be stored on catch platforms, working platforms, floors, or stairways of any structure, except that any one floor of a building to be demolished may be used for the temporary storage of material when such floor can be evaluated by a registered design professional and proven to be of adequate strength to support one and one-half times the load to be superimposed. Such evaluation by the registered design professional shall be maintained by the permit holder and made available to the department upon request.

3306.9.11.1 Avoid interference. Storage spaces shall not interfere with access to any stairway or passageway, and suitable barricades shall be provided so as to prevent material from sliding or rebounding into any space accessible to the public. All material shall be safely stored or piled in such storage locations in a manner that will not overload any part of the structure or create any hazard.

[3306.9.11.1] 3306.9.11.2 Examination of connections. Before any material is stored on any floor, the existing flooring adjacent to bearing walls, shear walls, beams and columns shall be removed and the connections of the floor framing system to the bearing walls, shear walls, beams and columns shall be carefully examined by a competent person designated by the permit holder to ascertain their condition and adequacy to support such material. If the connections are found to be in poor condition or inadequate to support the stored material, no material shall be deposited on the floor until these connections are shored from the cellar floor through each successive floor or otherwise strengthened to safely support such material.

[3306.9.11.2] 3306.9.11.3 Removal of floor slabs for storage. In buildings of noncombustible construction, floor slabs to an elevation of not more than 25 feet (7620 mm) above the legally established curb level may be removed to provide temporary storage for debris, provided that:

1. The stored debris is piled with sufficient uniformity to prevent lateral displacement of interior walls or columns as determined by a registered design professional.
2. The height of the piled material will not burst the exterior walls due to horizontal loading as determined by a registered design professional.
3. The operation does not otherwise endanger the stability of the structure.

[3306.9.11.3] 3306.9.11.4 Cellar or basement storage. Debris stored in the cellar or basement shall not be piled above the level of the adjacent exterior grade unless the demolition contractor provides sheet-piling, shoring, bracing, or such other means necessary to insure the stability of the walls and to prevent any wall from collapsing due to horizontal loading created by the debris as determined by a registered design professional. Where debris is stored against a party wall, the requirements of Section **[3306.9.11.4] 3306.9.11.5** shall also apply.

[3306.9.11.4] 3306.9.11.5 Examination of party walls. Party walls shall be carefully examined by a competent person designated by the permit holder to ascertain the condition and adequacy of the party wall prior to the placement of any material that will impose a load upon such party wall. If the party wall is to be found to be in poor condition or inadequate to support the stored material, no material shall be deposited on the floor until the party wall is

shored or otherwise strengthened as determined by a registered design professional to safely support such material.

3306.9.12 Removal of material. Debris, bricks, and similar material shall be removed through openings in the floors of the structure, or by means of chutes, buckets, or hoists that comply with the provisions of this chapter.

3306.9.12.1 [~~Protection of floor~~] Floor openings used for the removal of debris. Every opening in a floor used for the removal of debris shall be tightly enclosed with a shaftway, extending from floor to floor, with such shaftway enclosed with:

1. Planking not less than 2 inches (51 mm) in thickness, or equivalent solid material; or
2. Where the opening is used for the removal of noncombustible material, wire mesh may be utilized in lieu of planking, provided such mesh is not less than number 18 [~~gage~~] gauge wire mesh, with openings in the wire no longer than ½ inch (13 mm), and also provided that the wire mesh is securely attached, in accordance with drawings developed by a registered design professional, to the shaftway so that the wire mesh enclosure in any location does not deflect more than 2 inches (51 mm) when a force of at least 200 pounds (890 n) is applied along any horizontal portion of such wire mesh enclosure.

Exceptions:

1. In buildings not more than six stories or 75 feet (22 860 mm) in height, whichever is less, a shaftway is not required. Instead openings in the floor shall be clearly marked and solidly planked over while not in use by planking not less than 2 inches (51 mm) in thickness, or equivalent solid material, and laid close.
2. A shaftway is not required at the working deck. Instead, openings in the working deck shall be clearly marked and solidly planked over while not in use by planking not less than 2 inches (51 mm) in thickness, or equivalent solid material, [~~and~~] laid close.

3306.9.12.1.1 Temporary removal of protection. Wherever [~~such protection~~] a shaftway or planking required by Section 3306.9.12.1 has been temporarily removed to permit debris removal, the floor opening shall be protected by a guardrail system that meets the requirements of Sections 3308.7.1 through 3308.7.5. Such protection required by Section 3306.9.12.1 shall be promptly replaced in position upon the ceasing of such work at the end of each workday.

3306.9.12.2 Protection of wall openings. In any buildings more than 25 feet high (7620 mm), any window or other exterior wall opening that is within 20 feet (6096 mm) of a floor opening used for the passage of debris from levels above shall be solidly boarded up or otherwise substantially covered, unless such window or opening is so located as to preclude the possibility of any person being injured by material that may fall from such window or opening.

3306.9.12.3 Chutes. Chutes used in association with the removal of materials shall comply with Section 3303.5.5.

3306.9.13 Rodent extermination. A licensed exterminator shall effectively treat the premises for rodent extermination as per the requirements of the Department of Health and Mental Hygiene.

Exception: Partial demolition operations.

3306.9.14 Chimneys. Where brick or masonry chimneys cannot be safely toppled or dropped, all materials shall be dropped down on the inside of such chimneys.

3306.9.15 Partitions. Partitions required for the stability of the structure or required for egress, as identified in the submittal documents required by Section 3306.5, shall be clearly marked prior to the commencement of demolition operations. Such partitions shall not be removed until a competent person designated by the permit holder has determined the demolition sequence, as identified in the submittal documents, has reached the point the partitions can be safely removed, and authorizes their removal.

3306.9.16 Temporary weather protection. Temporary weather protection shall be installed and maintained by the demolition contractor, as necessary, to protect building systems or elements that may be susceptible to exposure to the weather during periods where the permanent weather protection has been breached, diminished, or is not yet in place. Such building systems or elements include, but are not limited to, walls, party walls, roofs, areas of missing brick, loose lain brick, and exposed electrical conduit.

3306.10 Removal of foundations and slabs. Where a building, or any portion, has been demolished to grade, the floor slab or foundation of such building, or portion, shall be removed and the site backfilled to grade.

Exceptions:

1. Cellar floors may remain provided the cellar floor slab is broken up to the extent necessary to provide ground drainage and prevent accumulation of water, and also provided that all fixtures or equipment that would cause voids in the fill are removed.
2. Where portions of a foundation, underpinning, or similar elements, other than a cellar floor, are to remain and be covered with backfill, a waiver approved by the commissioner shall be obtained. Drawings prepared by a registered design professional depicting the remaining buried structure shall be submitted with the waiver request.
3. Where a floor slab or foundation is to remain and not be backfilled, a waiver approved by the commissioner shall be obtained. Such request for waiver shall be accompanied by a statement and drawings prepared by a registered design professional demonstrating the necessity for retaining the existing floor slab or foundation for future construction or site remediation, as well as demonstrating positive cellar drainage to an approved place of disposal.

3306.10.1 Evaluation of fill on adjoining foundations. Where the installation of fill will impart a load on an adjoining foundation, a registered design professional shall evaluate the foundation prior to the placement of the fill. If necessary, sheeting, shoring, or bracing shall be provided as indicated by the registered design professional.

3306.11 Completion of demolition operations. All work required for structural stability and permanent waterproofing of adjacent buildings must be completed prior to demolition sign-off.

3306.12 Monitoring of adjoining structures during demolition. Where a bearing masonry or wood framed building shares a party wall or party foundation with a building that is to undergo a full demolition, a demolition performed in conjunction with work that meets the requirements of Section 101.4.5 of Title 28 of the *Administrative Code*, a demolition that results in the demolition of more than 50 percent of the gross floor area of the building during the course of work over any 12-month period, or a demolition that results in the removal of one or more floors during the course of work over any 12-month period, such bearing masonry or wood framed building shall be monitored during the demolition operation. The monitoring shall be in accordance with a monitoring plan prepared or accepted by the registered design professional who prepared the submittal documents in accordance with Section 3306.5. The monitoring plan shall be acceptable to the commissioner and shall include but not be limited to, the monitoring frequency, reporting requirements for the monitoring program, anticipated movement and settlement thresholds, and procedures to be implemented when thresholds are exceeded.

3306.13 Additional monitoring required by the commissioner. When, in the opinion of the commissioner, a demolition operation poses a potential hazard to an adjacent building, elevations of the building under demolition or the adjacent building, or both, shall be recorded or other monitoring procedures shall be implemented by a registered design professional at intervals of 24 hours or less as determined by the commissioner to ascertain if movement has occurred.

§ 38. Section BC 3307 of the New York city building code, as amended by local law number 141 for the year 2013, is amended to read as follows:

SECTION BC 3307 PROTECTION OF PEDESTRIANS

3307.1 Scope. Pedestrians shall be protected during construction or demolition activities as required by this section and by the Department of Transportation.

3307.2 Streets, including bicycle lanes and sidewalks, as well as walkways[;] and pathways. Streets, including bicycle lanes and sidewalks, as well as walkways and pathways, either within the public way or within a site, shall meet the requirements of Sections 3307.2.1 through 3307.2.6, and the requirements of the Department of Transportation.

3307.2.1 Obstruction of streets, including bicycle lanes and [øø] sidewalks. The requirements of the Department of Transportation shall apply with regard to the closing of streets [øø], including bicycle lanes and sidewalks, or to the obstruction of any part thereof.

3307.2.2 Temporary public walkway in the street. Where authorized by the Department of Transportation, a temporary walkway open to the public may be provided in the street in front of the site. Such temporary walkway shall be protected in accordance with the requirements of the Department of Transportation. Department of Transportation authorization is required where a temporary walkway and a temporary or permanent bicycle lane will share the same space.

3307.2.3 Temporary public walkway within the site. Where authorized by the commissioner, a temporary walkway open to the public may be provided through a site that is otherwise fenced and closed to the public. Such temporary walkway shall be:

1. Protected by a sidewalk shed, or where acceptable to the commissioner, provided with overhead protection and lighting equivalent to that afforded by a sidewalk shed;
2. Enclosed along the side facing the site with a solid fence that meets the requirements of Section 3307.7. Where the sidewalk shed or equivalent overhead protection extends beyond ~~[the height of the fence]~~ 8 feet (2438 mm) in height, the fence shall extend to the top of the overhead protection, or the gap between the top of the fence and the overhead protection shall be enclosed with a wire screen comprised of not less than number 18 [gage] gauge wire mesh, or equivalent synthetic netting that is flame retardant in accordance with NFPA 701, with openings in the wire or synthetic mesh no larger than ½ inch (13 mm) in the vertical or horizontal dimensions and ¾ inch (19 mm) in any other dimension; and
3. Enclosed along the side facing the street ~~[with a wire screen comprised of not less than number 18 gage wire mesh, or equivalent synthetic netting, with openings in the wire or synthetic mesh no larger than ½ inch (13 mm), or where a special hazard exists, protected]~~ in accordance with Section 3307.4.7.

3307.2.4 Pathways. Where a means of ingress/egress to ~~[the property remains]~~ a building or structure remains open to the public during the course of construction or demolition, [walkways, pathways, and similar areas within the property line that provide a path of travel between the required means of ingress/egress and the public sidewalk or temporary walkway shall remain open.] an adequate pathway shall be provided between such means of ingress/egress and the sidewalk, or in lieu of the sidewalk, the temporary public walkway provided in accordance with Section 3307.2.2.

3307.2.5 Foot bridges. Where foot bridges are utilized as part of a sidewalk, walkway, or pathway, they shall be provided with guardrails for the entire length, and shall have cleats to prevent slipping. Where planks are used to pave the walkway of the foot bridge, the planks shall be laid close and securely fastened to prevent displacement. Planks shall be of uniform thickness, and all exposed ends of ramps shall be provided with beveled fillers to eliminate tripping hazards.

3307.2.6 Requirements for sidewalks, temporary walkways, foot bridges, and pathways. Sidewalks, walkways, foot bridges, and pathways that remain open to the public shall be accessible and shall be provided with:

1. A continuous clear path, free of obstruction, at least 5 feet (1524 mm) in width;

2. A durable walking surface capable of supporting all imposed loads and in no case shall the design live loads be less than 150 pounds per square foot (~~[732.3]~~ 732.4 kg/m²);
3. ~~[Mirrors at all blind corners;]~~ Mirrors at locations where a pedestrian's or bicyclist's view is obstructed, including but not limited to blind corners, blind turns, and points where fencing or similar barriers project into a sidewalk, temporary walkway, foot bridge, or pathway;
4. For a temporary walkway or foot bridge where there is a change in elevation along the walkway or ~~[footbridge]~~ foot bridge, a ramp with a running slope not steeper than one unit vertical in 12 units horizontal (8-percent slope) with a level landing at least 5 feet long at the top and bottom of each run, and if there is a total rise greater than 6 inches (152 mm), handrails; and
5. For a temporary walkway or foot bridge where the running slope of such walkway or foot bridge is steeper than one unit vertical in 20 units horizontal (5-percent slope) and there is a total rise greater than 6 inches (152 mm), handrails.

Exception: Where it is not possible to provide the continuous clear path to the extent required by Item 1 above, the sidewalk, temporary walkway, or pathway shall be kept open to the extent required by the Department of Transportation, and shall also ~~[as well as]~~ comply with applicable provisions of ICC A117.1, the *ADA Accessibility Guidelines for Buildings and Facilities* and/or the *ADA Accessibility Guidelines for Pedestrian Facilities in the Public Right-of-Way*, as applicable.

3307.3 Sidewalk sheds and fences. Sidewalk sheds shall be provided as required by Section 3307.6. Fences shall be provided as required by Section 3307.7.

3307.4 Warning signs, personnel, and barriers. Warning signs, personnel, or barriers shall be provided to protect the public from hazards generated by construction or demolition activity in or adjacent to a public way as set forth in Sections 3307.4.1 through 3307.4.7.

3307.4.1 Obstructions and openings. Obstructions or openings located in a public way shall be marked and guarded by barriers, flags, or signs in accordance with the requirements of the Department of Transportation.

3307.4.2 Dangerous areas. In areas where special danger to the public exists, including but not limited to vehicle entrances and exits, hoisting areas, points of storage of explosives or highly flammable material, blasting areas, or discharge ends of chutes, descriptive warning signs shall be provided in accordance with the requirements of the Department of Transportation.

3307.4.3 Vehicular traffic. Whenever any work is being performed over, on, or in close proximity to a highway, street, or similar public way, control and protection of traffic shall be provided by barriers, signals, signs, flagperson, or other devices, equipment, and personnel in accordance with the requirements of the Department of Transportation.

3307.4.4 Areas open to persons other than workers. A flagperson shall be provided whenever intermittent operations are conducted on, or adjacent to, areas open to use by persons other than

workers, or when dangerous operations, such as blasting, may affect such areas. Where required by the Department of Transportation, designated personnel shall also be provided in addition to flag persons.

3307.4.5 Additional signs. In addition to the requirements of this section, information panels and signs shall also be provided as required by ~~[Sections]~~ Section 3301.9 ~~[and 3301.10].~~

3307.4.6 Prohibited signs. ~~[No illuminated business or advertising sign shall be permitted on any protective structure required by this section. Other than as specified in Sections 3301.9 or 3301.10 there shall be no sign, information, pictorial representation, or any business or advertising messages posted on a sidewalk shed, bridge, fence, or other protective structure listed in this section that is erected at the construction or demolition site.] See Section 3301.9.~~

~~[3307.4.7 Work or storage zones. Where work or storage related to the construction or demolition of a building or structure is occurring adjacent to a sidewalk shed or equivalent overhead protection, and such area is not closed with a fence in accordance with Section 3307.7 or a permanent façade, a solid barrier extending at least 4 feet (1219 mm) in height from the level of the ground shall be provided. The space between the top of the barrier and the deck of the overhead protection shall be enclosed with a wire screen comprised of not less than number 18 gage wire mesh, or equivalent synthetic netting, with openings in the wire or synthetic mesh no larger than ½ inch (13 mm).]~~

~~[**Exception:** In the area where a material hoist, personnel hoist, hoistway, or chute is located, the solid barrier shall extend from level of the ground to the deck of the overhead protection.]~~

3307.4.7 Work or storage zones. Where work or storage related to the construction or demolition of a building or structure is occurring adjacent to a sidewalk shed or equivalent overhead protection, and such work or storage area is not contained within the enclosed and fenced area of the site as specified in Section 3307.7, fencing, barriers, or netting complying with items 1, 2, or 3 of this section shall be provided to separate the sidewalk, walkway, foot bridge, or pathway from the work or storage area.

1. In an area where a material hoist, personnel hoist, hoistway, chute, or hoisting zone is located, a solid opaque fence or barrier shall be provided. Such fence or barrier shall be securely attached to the sidewalk shed or equivalent overhead structure, and shall extend from the level of the ground to the deck of the sidewalk shed or equivalent overhead protection.
2. In an area where a special hazard exists, including but not limited to areas of high pile storage or areas where operations that produce sparks or debris are occurring, such as cutting or grinding, a fence or barrier shall be provided. Such fence or barrier shall be securely attached to the sidewalk shed or equivalent overhead structure, and shall extend from the level of the ground to the deck of the sidewalk shed or equivalent overhead protection. Portions of the fence or barrier at a height of 4 feet (1219 mm) or less shall be comprised of solid opaque material. Portions of the fence or barrier above a height of 4 feet (1219 mm) shall be comprised of material sufficient to protect the public from the special hazard and shall be transparent so as to allow a clear view into and from the area protected by the sidewalk shed or equivalent overhead protection, for example, chain link

fencing, neatly framed panels consisting of nonfrangible acrylic paneling, or wire screen comprised of not less than number 18 gauge wire mesh, or equivalent synthetic netting that is flame retardant in accordance with NFPA 701, with openings in the wire or synthetic mesh no larger than ½ inch (13 mm) in the vertical or horizontal dimensions and ¾ inch (19 mm) in any other dimension.

3. In all other instances, one of the following shall be provided:

3.1 A chain link fence that is at least 8 feet (2438 mm) high;

3.2 A solid barrier that is at least 32 inches (813 mm) high, topped by a chain link fence extending to a height of at least 8 feet (2438 mm) above the level of the ground; or

3.3 A wire screen comprised of not less than number 18 gauge wire mesh, or equivalent synthetic netting that is flame retardant in accordance with NFPA 701, with openings in the wire or synthetic mesh no larger than ½ inch (13 mm) in the vertical or horizontal dimensions and ¾ inch (19 mm) in any other dimension. Such wire screen or synthetic netting shall extend from the ground to a height of at least 8 feet (2438 mm) above the level of the ground and shall be securely attached to the sidewalk shed or equivalent overhead protection. A solid barrier that is at least 32 inches (813 mm) high may be installed in lieu of bringing the netting fully to the ground, provided the bottom of the netting is also securely attached to the solid barrier.

3307.5 Watchperson and flagperson. Watchpersons shall be provided as required by Section 3303.3. Flagpersons shall be provided as required by Section 3307.4.

3307.6 Sidewalk sheds. Sidewalk sheds shall be provided as required by this section to protect pedestrians from construction or demolition operations.

3307.6.1 Permit. No sidewalk shed shall be installed without a permit in accordance with the requirements of Chapter 1 of Title 28 of the *Administrative Code*.

3307.6.2 Where required. A sidewalk shed shall be installed and maintained to protect all sidewalks, walkways, and pathways within the property line of a site, and all public sidewalks that abut the property, as follows:

1. When such sidewalk, walkway, or pathway is to be located immediately below a scaffold, mast climber, or chute. The sidewalk shed shall be installed prior to the installation of such equipment and shall not be removed until such equipment has been dismantled and/or removed from the area being protected;
2. When a structure higher than 40 feet (12 192 mm) or greater is to be constructed, and the sidewalk, walkway, or pathway is within a perpendicular distance from the new structure that is equal to or less than half the height of the new structure. The sidewalk shed shall be installed when the structure reaches the planned height of the shed. Such shed shall not be removed until the structure is enclosed, all exterior work has been completed and the sash is glazed above the second story, the façade has been cleaned down, and all

exterior chutes, scaffolds, mast climbers, and hoisting equipment have been dismantled and removed from the site;

3. When a portion of a façade over 40 feet (12 192 mm) above curb level is to be constructed, altered, maintained, or repaired, or a vertical or horizontal enlargement is to occur at a height over 40 feet (12 192 mm) above curb level, and the sidewalk, walkway, or pathway is within a perpendicular distance from the structure that is equal to or less than half the height of such façade work or vertical or horizontal enlargement. The sidewalk shed shall be installed prior to the commencement of work at a height greater than 40 feet (12 192 mm) above curb level. Such shed shall not be removed until the building is enclosed, all exterior work has been completed and the sash is glazed above the second story, the façade has been cleaned down, and all exterior chutes, scaffolds, mast climbers, and hoisting equipment have been dismantled and removed from the site; or
4. When a structure higher than 25 feet (7620 mm) is to undergo a full demolition, or when exterior partial demolition, other than that performed in conjunction with the construction, alteration, maintenance, or repair of a façade, is to occur at a height greater than 25 feet (7620 mm) above curb level, and the sidewalk, walkway, or pathway is within a perpendicular distance from the structure that is equal to or less than half the height of the demolition work. The sidewalk shed shall be installed prior to the commencement of demolition work. Such shed shall remain in place until the building has been razed to the height of the shed, or where the building is not being fully demolished, until all demolition work has been completed and all exterior chutes, scaffolds, mast climbers, and hoisting equipment have been dismantled and removed from the site.

Exceptions: Except where specifically required by the commissioner to protect the public from unique hazards at the site, sidewalk sheds are not required for:

1. Sidewalks, walkways, and pathways, or portions thereof, that are closed [~~for their full width,~~] to the public[;].
2. Temporary walkways in accordance with Section 3307.2.3 that are provided with lighting and overhead protection equivalent to that afforded by a sidewalk shed[;].
3. Inspections, including a façade inspection, provided no work occurs during the inspection[;].
4. Sign hanging occurring by or under the direct and continuing supervision of a licensed sign hanger[;].
5. Window washing[;].
6. Work confined to the roof of an existing building, provided ~~the~~ that:

6.1 The edge of the roof is enclosed to a height of 42 inches (1067 mm) with a solid parapet [~~or vertical safety netting meeting the requirements of Section 3308.5; or~~];

- 6.2 Such parapet is of sufficient strength to resist accidental impact during construction;
- 6.3 The work does not exceed the height of the parapet or is set back from the edge of the roof at a distance that is equal to or greater than half the height of the work; and
- 6.4 No work occurs on the parapet itself, and no material is placed or stored on the parapet during the course of the work.
7. Subject to the approval of the commissioner, work of limited scope and duration provided that:
- 7.1 During the course of the work the area immediately under the work zone is temporarily closed to the public by means of barriers, cones, or caution tape, and flagpersons are provided to direct pedestrian traffic;
- 7.2 At the end of the day the façade of the building is left in a safe condition and fully enclosed; and
- 7.3 There is compliance with Section 3307.2.1.
8. Locations where a cantilevered platform has been installed, provided that:
- 8.1 The cantilevered platform is approved by the commissioner;
- 8.2 The cantilevered platform provides overhead protection equivalent to a sidewalk shed; and
- 8.3 The cantilevered platform is installed below the level of work to be performed, excluding work performed at the first story.
9. Areas along an exposure that are located more than 5 feet (1524 mm) beyond those required for compliance with Item 1 of Section 3307.6.2, provided that:
- 9.1 The work is limited to the alteration, maintenance, or repair of a façade, and does not constitute a façade recladding as defined in rules promulgated by the commissioner; and
- 9.2 The entire exposure where façade work is to occur is covered by either:
- 9.2.1 A supported scaffold with netting and guardrails in accordance with Section 3314.8; or
- 9.2.2. A site specific engineered enclosure system in accordance with Section 3309.17.

3307.6.3 Area to be protected. The decking of the sidewalk shed shall extend [~~the~~]:

1. The full length of the area that falls within the zone specified in Section 3307.6.2, plus an additional 5 feet (1524 mm) beyond such length, or to within 18 inches (457 mm) of the curb line, whichever is less; or where the sidewalk shed is installed to protect against an unenclosed façade, work, or equipment that is greater than 100 feet (30 480 mm) above the ground, the decking of the sidewalk shed shall extend the full length of the area that falls within in the zone specified in Section 3307.6.2, plus an additional 20 feet (6096 mm) on both ends beyond such length, or to within 18 inches (457 mm) of the curb line, whichever is less.
2. ~~The [decking of the sidewalk shed shall also extend the]~~ full width of the sidewalk, walkway, or pathway that ~~[remains open to the public]~~ falls within the zone specified in Section 3307.6.2, except for a clearance to avoid existing obstructions, not to exceed 18 inches (457 mm) along the curb [and not to exceed 1 inch (25 mm) along the face of the building or structure].

Exceptions:

1. ~~[Where the sidewalk shed is installed to protect against an unenclosed façade, work, or equipment that is greater than 100 feet (30 480 mm) above the ground, the shed shall protect the full length of the area specified in Section 3307.6.2, plus an additional 20 feet (6096 mm) on both sides beyond such length, or to the curb line, whichever is less.]~~ Where it is not possible to bring the deck tightly against the face of an abutting building, structure, or fence, the deck shall be brought to within 1 inch (25 mm) of the face of such building, structure, or fence, with the resulting gap sealed or covered by material of sufficient manner and strength capable of trapping falling debris.
2. Openings in the deck to avoid tree trunks and branches, provided such opening is brought as close to the tree as practical without damaging the tree.

3307.6.4 Design and construction of sidewalk sheds. Sidewalk sheds shall be designed and constructed in accordance with the requirements of Sections 3307.6.4.1 through 3307.6.4.11.

3307.6.4.1 [Designer] Design required. All sidewalk sheds shall be designed by a registered design professional. The sidewalk shed design shall be detailed on plans developed by the registered design professional. The plans shall be specific to the site and shall, at a minimum, include a plan view and an elevation view, with full dimensions, detailing:

1. The site;
2. The sidewalk shed;
3. Design load of the sidewalk shed (e.g. light duty, heavy duty);
4. All obstructions at the site that may interfere with the sidewalk shed, including but not limited to those listed in Section 3307.6.4.9;
5. Dunnage, blocking, or other founding material for the sidewalk shed, including details necessary to satisfy the requirements of Item 2.3 of Section 3307.6.4.10;

6. Anchorage of the sidewalk shed to the sidewalk or building, if necessary;
7. Materials or items to be placed or stored on the sidewalk shed, if authorized, in accordance with the requirements of Section 3307.6.4.2.2;
8. Any items connected to or attached to the sidewalk shed;
9. Locations, dimensions, and connection details of all signage, including parapet information panels, to be installed on the sidewalk shed; and
10. Location of any scaffolds and reference to a related application, if applicable.

~~[Exception: Sidewalk sheds that conform to a design approved by the commissioner or the Board of Standards and Appeals, provided the shed is installed at the site in accordance with the standard design.]~~

3307.6.4.2 Design loads. All sidewalk sheds shall be designed as a heavy duty sidewalk shed to carry a live load of at least 300 pounds per square foot (~~[1464.6 kg/m²]~~ 1464.7 kg/m²). However, where the shed is installed to protect from work performed at a height of less than 100 feet (30 480 mm) above the ground, the sidewalk shed may be designed as a light duty sidewalk shed to carry a live load of at least 150 pounds per square foot (~~[732.3]~~ 732.4 kg/m²), provided that no item is stored or placed upon the shed.

3307.6.4.2.1 Wind and other loads. The effect of wind and other loads on the sidewalk shed, and any item placed or attached on or to the shed, shall be considered in the design in accordance with Chapter 16.

3307.6.4.2.2 Storage. Storage on sidewalk sheds shall be as follows:

1. No item shall be stored or placed upon a sidewalk shed designed as a light duty sidewalk shed under Section 3307.6.4.2.
2. ~~[No material shall]~~ Material may be stored or placed upon a sidewalk shed designed as a heavy duty sidewalk shed under Section 3307.6.4.2, ~~[unless the~~ provided conditions 2.1 through 2.4 are met:
 - 2.1. The shed is designed for such storage, with such areas of storage or placement clearly designated on the drawings.
 - 2.2. Where an item is to be stored or placed upon a heavy duty sidewalk shed, and such storage or placement is not in excess of 150 pounds per square foot (~~[732.3]~~ 732.4 kg/m²) on any square foot area of the sidewalk shed, the design live load of 300 pounds per square foot (~~[1464.6 kg/m²]~~ 1464.7 kg/m²) need not be increased.
 - 2.3. Where an item is to be stored or placed upon a heavy duty sidewalk shed, and such storage or placement is in excess of 150 pounds per square foot (~~[732.3]~~ 732.4 kg/m²) on any square foot area of the sidewalk shed, such shed shall be designed to carry:

[2-1] 2.3.1. The live load of 300 pounds per square foot (~~[1464.6 kg/m]~~ 1464.7 kg/m²) required of a heavy duty sidewalk shed; and

[2-2] 2.3.2. The load of the item to be placed or stored upon the shed, minus 150 pounds per square foot (~~[732.3]~~ 732.4 kg/m²).

2.4. The decking of the sidewalk shed does not consist of light-transmitting plastic material.

3307.6.4.3 Materials. Sidewalk sheds shall be constructed out of wood, steel, or other material possessing equivalent strength and suitability.

3307.6.4.4 Vertical members and beams. Vertical members and beams of the sidewalk shed shall conform with the following:

1. Vertical members and beams shall be adequately braced and connected to prevent displacement or distortion of the framework.
2. The vertical members of the sidewalk shed shall be plumb, with a tolerance of L/100, with “L” measured as the distance from the ground to the first [~~X-brace~~] cross brace or bottom of the beam.
3. Vertical members shall not be placed into the street unless approved by the Department of Transportation and protected in accordance with Department of Transportation requirements.
4. Vertical members placed on the sidewalk shall not be placed closer than 18 inches (455 mm) from the face of the [~~curbline~~] curb line.
5. Vertical members shall be placed at least 7 feet (2134 mm) from the edge of a curb cut or vehicular access point, or where placed closer, the vertical members nearest the curb cut or vehicular access point shall be protected against displacement by vehicles, or shall be identified with high visibility marking.
6. Vertical members, cross bracing, struts, and similar lateral support shall be placed in such a manner that the sidewalk, walkway, or pathway continues to comply with the requirements of Section 3307.2.6 and avoids interference in accordance with Section 3307.6.4.9.
7. Where the sidewalk shed is installed in conjunction with the construction of a new major building, a horizontal span of at least 10 feet (3048 mm), as measured down the length of the sidewalk, walkway, or pathway, shall be provided between all vertical members, except where a shorter span is needed to avoid the curb or obstructions in accordance with Section 3307.6.4.9; and all cross bracing, struts, and similar lateral support between vertical members shall be placed a minimum of 8 feet (2438 mm) above the level of the sidewalk, walkway, or pathway. However, cross bracing, struts, and similar lateral support between vertical members may be placed lower where it is installed to guard against a tripping hazard in accordance with Item 2.5 of Section

3307.6.4.10. Mast sections, box towers, or similar elements used as vertical members shall, for the purposes of this item, be considered to be one vertical member, provided its base does not exceed 24 inches by 24 inches (610 x 610 mm). In the alternative, a sidewalk shed that is of a model whose prototype won a design competition recognized by the city may be installed instead.

8. Where the decking of the sidewalk shed consists of light-transmitting plastic material, all cross bracing, struts, and similar lateral support between vertical members shall be placed a minimum of 8 feet (2438 mm) above the level of the sidewalk, walkway, or pathway. However, cross bracing, struts, and similar lateral support between vertical members may be placed lower where it is installed to guard against a tripping hazard in accordance with Item 2.5 of Section 3307.6.4.10.

3307.6.4.5 Deck. The deck of the sidewalk shed shall conform with the following:

1. The deck shall consist of 2-inch (51 mm) thick wood plank or equivalent material, ~~and~~ or shall consist of light-transmitting plastic material, which shall include an anti-slip walking surface integral to the material or as an applied coating.
2. The deck shall be capable of sustaining the loads required by Section 3307.6.4.2.
3. The deck shall be solid, or shall consist of planking or panels laid close and made tight.
4. ~~[Where the edge of the sidewalk shed abuts a building or structure, the decking shall be brought tight to the face of the building or structure. Exception: Where it is not possible to bring the deck tightly against the face of the building or structure, the deck shall be brought to within 1 inch (25 mm) of the face of the building or structure, with the resulting gap sealed or covered by material of sufficient manner and strength capable of trapping falling debris.]~~ Where wood plank is used, corrugated metal or equivalent material shall be installed under the deck to catch fine grain material.
5. The deck of the sidewalk shed shall be brought tight to the face of any abutting building, structure, or fence, except for permissible gaps in accordance with Section 3307.6.3.

3307.6.4.6 Parapet. A vertical parapet at least 3 feet 6 inches (1067 mm) high, but no more than 4 feet (1219 mm) high, as measured from the deck of the sidewalk shed, shall be constructed along all edges of the sidewalk shed. Such parapet shall consist of ~~[solid plywood, corrugated metal, a galvanized wire screen consisting of not less than No. 16 steel wire gauge with a ½ inch (13 mm) debris mesh, or other equivalent material, and]~~ galvanized wire screen not less than No. 16 steel wire gauge with a ½ inch (13 mm) mesh. Parapets shall be securely attached to the shed with braced uprights. Parapet braces shall be made of metal. Temporary removal of a portion of the parapet is permitted for the handling of material, provided the parapet is immediately restored at the end of the handling operation.

Exceptions:

1. A parapet is not required along the edge of the sidewalk shed that abuts a building or structure.
2. A parapet is not required along the edge of a sidewalk shed that abuts an area that is closed to the public.
- ~~3. In lieu of a vertical parapet, angled protection of identical construction to a parapet that inclines outward at an angle of 45 degrees (0.79 rad) may be utilized provided such protection is securely attached to the deck, and provided the angled protection extends to a point that intersects a line drawn 3 feet 6 inches (1067 mm) above the level of the deck.]~~
3. Where the sidewalk shed is installed in conjunction with the full or partial demolition of a building or structure, other than work limited to a façade project, the parapet shall consist of plywood or other equivalent solid material.
4. Where a sign, including a parapet information panel, is installed on a sidewalk shed, the parapet backing for the sign may consist of plywood or other equivalent solid material.

3307.6.4.7 Height. The passageway under the shed shall have a minimum clear ceiling height of 8 feet (2438 mm).

Exception: Lights that extend no more than 8 inches (203 mm) below the level of the deck shall be excluded from the clear ceiling height measurement.

3307.6.4.8 Lighting. Sidewalk shed lighting shall be in conformance with the following:

1. The underside of sidewalk sheds shall be illuminated at all times either by daylight or electric light. The level of illumination shall be uniformly distributed along the entire length of the shed with a minimum of 1 foot-candle (11 lux) measured at the level of the walking surface with a minimum luminous efficacy of 45 lumens per watt or greater and be rated to operate at temperatures of 5°F (-15°C) and higher.
2. All lamps shall be enclosed in water-resistant and vandal-resistant fixtures, and all lamps, wiring, and accessory components shall conform to the requirements of the *New York City Electrical Code*.
3. Photosensors may be used to control electric lighting according to the amount of daylight available. All photosensors shall be equipped for fail-safe operation ensuring that if the sensor or control fails, the lamps will provide the lighting levels required by this section.

3307.6.4.9 Avoid interference. Sidewalk sheds shall be installed and located so to not unreasonably obstruct, either visually or physically, traffic, curb cuts, curb ramps, vehicular access points, street lighting poles, traffic lights or signs, fire hydrants, fire department connections, water sampling stations, bus shelters, or other street furniture, trees, adjacent

show windows, [ø] means of ingress/egress, subway entrances, or access points to vaults, manholes, or other underground structures.

3307.6.4.10 Founding. Sidewalk shed founding shall be in accordance with the following:

1. The surface upon which the shed [rests] ultimately bears, such as the street, sidewalk, or ground, shall be capable of supporting the design loads of the sidewalk shed, including any item placed or stored upon the shed, without damage, settlement, or deformation to such surface.
2. Vertical members of the sidewalk shed shall bear upon base plates, mud sills, dunnage, or other adequate firm foundation. Such items shall be:
 - 2.1. Made of suitable firm material. Supports such as barrels, boxes, loose brick, loose stone, hollow block, or other unstable materials shall not be used.
 - 2.2. Capable of transmitting and distributing the load imposed by the sidewalk shed vertical member to the underlying surface.
 - 2.3. Secured against movement in any direction. When consisting of several pieces of material, such as multiple wood blocks, the material shall be nailed or otherwise positively connected together to prevent dislodgement. When more than 1 inch (25 mm) thick, the material shall be nailed or otherwise positively connected to the sidewalk shed vertical member.
 - 2.4. Installed in such a manner that the sidewalk shed vertical member is fully supported across all horizontal dimensions.
 - 2.5. Installed in such a manner that no portion extends more than 1.5 inches (38 mm) beyond any horizontal edge of the sidewalk shed vertical member, or where it extends beyond such distance, is adequately guarded or barricaded to prevent tripping hazards; the installation of cross bracing, struts, and similar lateral support between the corresponding vertical members of the sidewalk shed will satisfy this requirement.

3307.6.4.11 Color. Sidewalk sheds erected on or after July 1, 2013, shall [~~be painted the color of hunter green.~~] meet the following color requirements:

1. Solid parapet panels shall be hunter green.
2. Mesh parapet panels shall be hunter green or metallic gray.
3. Portions of parapet panel framing members visible to the public shall be hunter green. This includes side and back portions of such parapet panel framing members that may be visible through mesh panels.
4. Vertical members, cross bracing, and other metallic components shall be hunter green or metallic gray.

Exception: Sidewalk sheds that are of a model whose prototype won a design competition recognized by the city may be white in color.

3307.6.5 Installation, adjustment, maintenance, repair, use, inspection, and removal of sidewalk sheds. Sidewalk sheds shall be installed, adjusted, maintained, repaired, used, inspected, and removed in accordance with the following requirements.

3307.6.5.1 Safe condition. Sidewalk sheds shall be maintained in a safe condition and used in a manner that eliminates hazards to the public. Any hazardous conditions or defects discovered with the sidewalk shed shall immediately be brought to the attention of the permit holder for the shed.

3307.6.5.2 Supervision of installation, adjustment, repair, and removal. The installation, adjustment, repair, or removal of a sidewalk shed shall be performed under the supervision of a competent person designated by the permit holder for the sidewalk shed.

3307.6.5.3 Responsibility for maintenance and use. Sidewalk sheds shall be maintained and used by the general contractor, or where there is no general contractor, the contractor causing the work to be performed, or where there is no active work, the building owner.

3307.6.5.4 Storage or placement of items. No item shall be stored or placed upon a sidewalk shed unless such shed has been designed for such storage or placement in accordance with Section 3307.6.4.2.2. Where such shed has been so designed, items shall be stored or placed only in the area designated on the drawings for storage. Any item placed or stored upon a sidewalk shed shall be secured in a manner to prevent dislodgement, displacement by wind, and shall be distributed so as not to exceed the design limits of the sidewalk shed.

3307.6.5.5 Cleaning. The decks of sidewalk sheds shall be broom swept and cleaned of material daily while active work is occurring at the site.

3307.6.5.6 Sharp edges. Where located in an area that could pose a danger to the public, bolts and screws without a cap, and sharp edges, shall be protected to prevent injury to the public.

3307.6.5.7 Installation inspection. Upon completion of the installation of a sidewalk shed, the shed shall be inspected by a qualified person designated by the designer, the permit holder for the shed, or a third party acceptable to both the designer and the permit holder to verify that the sidewalk shed is in a safe condition and has been installed in accordance with drawings and the requirements of this chapter. ~~[Following the inspection, the qualified person who inspected the sidewalk shed shall prepare, sign, and date an installation inspection report. A new installation inspection report shall be prepared each time the sidewalk shed is reinstalled at the site.]~~

3307.6.5.8 Periodic inspection. ~~[Six months following the initial installation inspection, and every six months thereafter, the sidewalk shed shall be inspected by a qualified person designated by the designer, the permit holder for the shed, or a third party acceptable to both the designer and the permit holder to verify that the sidewalk shed is in a safe condition and is in compliance with drawings and the requirements of this chapter. Following the inspection, the qualified person who inspected the sidewalk shed shall prepare, sign, and date an~~

~~inspection report.] A periodic inspection of the sidewalk shed shall be performed six months following the last installation, adjustment, or repair inspection required by Section 3307.6.5.7 or 3307.6.5.9, or where no such inspection has occurred within six months, six months following the last periodic inspection. The periodic inspection shall be performed by a qualified person designated by the designer, the permit holder for the shed, or a third party acceptable to both the designer and the permit holder to verify that the sidewalk shed is in a safe condition and is in compliance with drawings and the requirements of this chapter.~~

3307.6.5.9 Inspection following an adjustment or repair. Following a repair or adjustment at a site, the sidewalk shed shall be inspected by a qualified person designated by the designer, the permit holder for the shed, or a third party acceptable to both the designer and the permit holder to verify the adequacy of the repair or adjustment and to verify the sidewalk shed is in a safe condition and is in compliance with drawings and the requirements of this chapter. ~~[The results of the inspection shall be recorded, signed, and dated by the person who performed the inspection.]~~

3307.6.5.10 Daily inspection. Sidewalk sheds shall be visually inspected daily by a person designated by the general contractor, or where there is no general contractor, the contractor causing the work to be performed, or where there is no active work, by the building owner to verify[=] compliance with Items 1 through 5 of this section.

1. The lights are functioning;
2. No brace or rail is hanging unattached at one or more ends;
3. No portions of the support structure are disconnected;
4. No section of parapet is missing; and
5. All legs remain on their support and are supported to the ground, and any wood blocking is free of visible rot.

Exception: The inspections for a scaffold suspended or supported above a sidewalk shed shall be in accordance with Section 3314.

~~[**3307.6.5.10.1 Daily inspection report.** A written record of such inspections shall be maintained by the contractor or owner, with such record signed and dated by the person who performed the inspection. Defects discovered as a result of the inspection shall immediately be brought to the attention of the permit holder for the shed.]~~

3307.6.5.11 Inspection reports. The results of an inspection required by Sections 3307.6.5.7 through 3307.6.5.10 shall be recorded in an inspection report that is prepared, signed, and dated by the person who performed the inspection. In lieu of compliance with the requirements of Section 3301.7, copies of the inspection reports required by Sections 3307.6.5.7 through 3307.6.5.10 shall be maintained at the site by the general contractor, or where there is no general contractor, the contractor causing the work to be performed, or where there is no active work, by the building owner.

3307.6.5.12 Discovery of defects. Defects discovered during the course of performing an inspection required by Sections 3307.6.5.7 through 3307.6.5.10 shall immediately be brought to the attention of the permit holder for the shed.

[3307.6.5.11] **3307.6.5.13 Notification of removal.** The permit holder for the shed shall notify the department no more than two business days following the complete removal of a sidewalk shed.

3307.6.5.14 Signage. Only signage, including parapet information panels, allowed by Section 3301.9, and indicated on the sidewalk shed design drawings in accordance with Section 3307.6.4.1, shall be installed on the sidewalk shed. Sidewalk shed signage shall only be installed, adjusted, maintained, repaired, and removed by the permit holder for the shed or an entity authorized by the permit holder.

3307.7 Fences. All sites where a new building is being constructed, or a building is being demolished to grade, shall be enclosed with a fence. Fences shall also be installed to fully or partially enclosed sites, as necessary, where there exists an open excavation, an unenclosed portion of a building accessible at grade, or other hazard to the public. Such fences shall be at least 8 feet (2438 mm) high, built solid for their entire length, out of wood or other suitable material, and shall be returned at the ends to the extent necessary to effectively close off the site.

Exceptions: The commissioner may approve the use of a chain link fence to:

1. Secure a site where work has been interrupted or abandoned and discontinued, and a registered design professional has certified that all construction or demolition equipment and material that pose a hazard to the safety of the public and property have been removed from the site or safely secured. Prior to the resumption of work, the chain link fence shall be replaced by a solid fence meeting the requirements of this section.
2. Secure portions of a site where a one-, two-, or three-family building that is 40 feet (12 192 mm) or less in height, or a commercial building 40 feet (12 192 mm) or less in height, is being constructed or demolished and such building is setback at least 15 feet (4572 mm) from sidewalks or spaces accessible to the public and 5 feet (1524 mm) from adjoining buildings or structures.

3307.7.1 Location of fence. Where the fence is installed to fully enclose a site, the fence shall be constructed along the inside edge of the sidewalk or walkway and along the edges of the property line. Where a fence is installed to partially enclose a site, the fence shall be installed as necessary to prevent public access to any excavation or unenclosed portion of the building accessible at grade. Fences shall be installed and located so to not unreasonably obstruct, either visually or physically, traffic, curb cuts, curb ramps, vehicular access points, street lighting poles, traffic lights or signs, fire hydrants, fire department connections, water sampling stations, bus shelters, or other street furniture, trees, [ø] means of ingress/egress, or access points to vaults, manholes, or other underground structures.

Exceptions:

1. Fences may encroach onto the sidewalk in accordance with Department of Transportation requirements.
2. A fence is not required to be installed along the party wall of an adjoining property, provided no material is stored along such wall during the course of work.

3307.7.2 Gates. Gates shall be sliding or shall swing into areas not accessible to the public, and shall be provided only where required for access to the site or to facilitate the work. Gates shall consist of the same material and construction as the rest of the fence. Gates shall be kept closed at all times except during actual loading and unloading operations, when individuals or vehicles are actively entering or leaving the site, or as needed to facilitate active work around the gate.

Exception: Where approved by the commissioner, chain link gates may be utilized in a solid fence.

3307.7.3 Viewing panels. Viewing panels shall be provided in solid fences erected on or after July 1, 2013, at a rate one for every 25 linear feet (7.6 m) per frontage, with a minimum of one per frontage. Viewing panels shall be 12 inches by 12 inches (305 by 305 mm) in size and shall be blocked with [~~plexiglass or an equivalent nonfrangible material~~] nonfrangible acrylic paneling or equivalent material. The top of the viewing panel shall be located no more than 6 feet (1829 mm) above the level of the ground, and the bottom of the viewing panel shall be located no less than 3 feet (914 mm) above the level of the ground.

3307.7.4 Chain link fences or gates. Where a chain link fence or gate is utilized, the following requirements shall apply:

1. The fence or gate shall be made of new materials or, where salvaged, the fence shall be in good condition;
2. The fence posts shall be of galvanized steel pipe of a diameter that provides rigidity. Posts shall be suitable for setting in concrete footings, for driving into the ground, or for inserting in precast concrete blocks. Such posts shall be spaced in a manner that maintains the required rigidity to form a safe exterior fence;
3. The fence or gate shall be constructed of woven, galvanized steel wire mesh and shall be of sufficient strength and rigidity to prevent access to the site; and
4. The fence or gate shall be covered with an opaque sturdy cloth “windscreen” fabric or equivalent netting at all locations. Fabric or equivalent netting shall be securely attached to the fence or gate in accordance with manufacturer specifications. The fabric, or equivalent netting, and the fence shall be maintained in a neat, rigid and taut appearance.

3307.7.5 Design of fences. Fence installations shall be designed by a registered design professional. The effect of wind on the fence shall be considered in the design in accordance with Chapter 16.

[Exceptions:]

[1.] **Exception:** Fences installed in connection with the construction or demolition of a one-, two-, or three-family building that is 40 feet (12 192 mm) or less in height.

~~[2. Fences that conform to a standard design approved by the commissioner provided the fence is installed at the site in accordance with the standard design.]~~

3307.7.6 Installation and removal of fences. Fences required by this section shall be installed prior to the commencement of work. Such required fences shall not be removed until:

1. The site has been filled and graded and all hazards to the public removed; or
2. The façade has been enclosed, with all doors and windows installed, and all exterior work, except for incidental work including but not limited to landscaping, painting, weatherproofing, or installation of signs or fixtures, has been completed.

3307.7.7 Condition of fences. All fences and related windscreens or netting shall be installed, adjusted, repaired, and maintained in a sound condition, free of protruding or loose nails, wood, or metal, and with posts in an upright position restrained to prevent the fence from leaning or overturning.

3307.7.8 Inspection of fences. Fences and related windscreens or netting shall be visually inspected at least once a week, or where a sidewalk shed is installed at the site, daily, by a person designated by the general contractor, or where there is no general contractor, the contractor causing the work to be performed, or where there is no active work, by the building owner to verify the fence and related windscreens or netting remains in a safe condition in accordance with Section 3307.7.7.

3307.7.8.1 Inspection reports. The results of the inspection shall be recorded in an inspection report that is prepared, signed, and dated by the person who performed the inspection. In lieu of compliance with the requirements of Section 3301.7, copies of the inspection report shall be maintained at the site by the general contractor, or where there is no general contractor, the contractor causing the work to be performed, or where there is no active work, by the building owner.

3307.7.8.2 Discovery of defects. Defects discovered during the course of performing the inspection shall immediately be brought to the attention of the permit holder for the fence.

~~[3307.7.8]~~ **3307.7.9 Color.** Fences erected on or after July 1, 2013, shall be painted hunter green.

Exception: Where the sidewalk shed installed at the site is of a model whose prototype won a design competition recognized by the city, the fence may be painted the same color as the shed.

3307.8 Maintaining Department of Transportation pedestrian and bicyclist protection in place. Notwithstanding other provisions of law, pedestrian and bicyclist protection required by the Department of Transportation shall be maintained in place and kept in good order for the entire length of time pedestrians and/or bicyclists may be endangered.

3307.9 Removing protection at conclusion of work. Public property shall be left in as good a condition following the completion of the construction or demolition work as it was before such work was commenced. Except where otherwise required by this code, the owner or the owner's agent shall, upon the completion of the construction or demolition work, immediately remove all sidewalk sheds, fences, guard rails, temporary walkways, material, and other obstructions in or adjacent to the public way.

3307.10 Facilitating city work. In the event a duly authorized city agency must repair, maintain, or install city property, including but not limited to intersection control signs, electrical equipment, traffic signals, lane markings, sewer and water manholes, bus shelters, street lighting, other street furniture, or fire hydrants, at a location where pedestrian protection required by this chapter is located[;], such pedestrian protection shall be removed as directed by the department of buildings as long as the removal is deemed to be safe and, if necessary, suitable appropriate pedestrian protection that does not interfere with the work of such city agency is installed.

§ 39. Section BC 3308 of the New York city building code, as added by local law number 141 for the year 2013, is amended to read as follows:

SECTION BC 3308
[PROTECTION OF UNENCLOSED PERIMETERS] UNENCLOSED PERIMETER PROTECTION

3308.1 Scope. [~~Safety netting systems and guardrail systems shall be provided as required by this section to protect unenclosed perimeters.~~] Protection shall be provided along unenclosed perimeters as required by this section and rules promulgated by the commissioner, including but not limited to safety netting systems, guardrail systems, cocoon systems, climbing formwork, and enclosure panels. Except where this section authorizes the temporary removal of unenclosed perimeter protection, no work shall occur, nor shall materials be stored on any level where required unenclosed perimeter protection is not installed.

3308.2 Permit. [~~A permit is not required for the installation of safety netting systems and guardrail systems that are in accordance with this section. A permit is required for alternative methods granted under Section 3308.8, including but not limited to cocoon systems, climbing formwork, and enclosure panels.~~] A permit is required for the installation of unenclosed perimeter protection.

Exceptions: A permit is not required for:

1. Vertical safety netting systems that are in accordance with Sections 3308.5;
2. Horizontal safety netting systems that are in accordance with Section 3308.6; or
3. Guardrail systems that are in accordance with Section 3308.7.

3308.3 [~~Safety netting design~~] Design and documentation of unenclosed perimeter protection. [~~Safety netting~~] Unenclosed perimeter protection shall be designed and provided with documentation in accordance with Sections 3308.3.1 through 3308.3.5.

Exception: The requirements of Sections 3308.3.1, and 3308.3.3 through 3308.3.5, shall not apply to guardrail systems. The requirements of Section 3308.7 shall apply to guardrail systems.

3308.3.1 Design. [~~Safety netting systems~~] Unenclosed perimeter protection shall be designed by a registered design professional to meet temporary loads, including but not limited to wind, as prescribed in Chapter 16. The registered design professional shall take the supporting structure into account when designing the installation and shall include details of connections, anchorages, and supports. The minimum loads for vertical net cables required by Section 3308.5.3 need not be added to wind loads in determining the maximum lateral force, but in no event shall the maximum design load for the cables be less than that required by Section 3308.5.3. A reduction in the surface area due to the openings in vertical or horizontal net fabric or partially enclosed perimeter panel is permitted provided that the force at design wind speed is derived from manufacturers' test data or other testing or methods acceptable to the commissioner.

3308.3.2 Site safety plans. Details of the [~~safety netting system~~] unenclosed perimeter protection shall also be shown on the site safety plan, where such plan is required by [~~Section 3310~~] this chapter.

3308.3.3 Make and model. The make and model of [~~vertical and horizontal netting~~] unenclosed perimeter protection, along with the connections and supports, shall be acceptable to the registered design professional responsible for the design of the [~~safety netting systems~~] unenclosed perimeter protection in accordance with Section 3308.3.1. The make and model, along with acceptance of the make and model by such registered design professional, shall be indicated as a note on the drawings, or in the form of a signed, sealed, and dated letter from such registered design professional that is kept with the drawings.

3308.3.4 Flame retardant. Vertical and horizontal safety netting used for unenclosed perimeter protection shall be flame retardant in accordance with NFPA 701. Documentation of such shall be provided by the manufacturer and shall be noted on the drawings by the registered design professional responsible for the design of the safety netting systems in accordance with Section 3308.3.1, or shall be recorded by such registered design professional in the form of a signed, sealed, and dated letter from such registered design professional, with such letter kept with the drawings.

3308.3.5 Tensile strength. The tensile strength for the structural net utilized in connection with [~~the~~] a horizontal safety netting system shall be noted on the drawings by the registered design professional responsible for the design of the safety netting systems in accordance with Section 3308.3.1, or shall be recorded by such registered design professional in the form of a signed, sealed, and dated letter from such registered design professional, with such letter kept with the drawings. Where required by Section 3308.6.3, the strength shall be confirmed by testing; the results of the test shall be documented in the form of a signed, sealed, and dated letter from the registered design professional responsible for the design of the safety netting systems in accordance with Section 3308.3.1. Such letter shall be kept with the drawings.

3308.4 Responsibility and supervision. The permit holder for the project, or where a permit is required by Section 3308.2, the [~~permit~~] holder of such permit, shall be responsible for complying with the requirements of Section 3308. A competent person designated by such responsible permit holder shall supervise the installation, reinstallation, [~~inspection~~] adjustment, maintenance, repair,

and temporary or permanent removal of all [safety netting systems and guardrail systems] unenclosed perimeter protection, along with any support, connection, or component~~[, or alternative methods granted under Section 3308.8].~~ The inspection of unenclosed perimeter protection shall be conducted in accordance with the requirements of Section 3308.9.3.

[Exception: Where this section requires another entity to perform an inspection.]

3308.5 Vertical safety netting systems. Vertical safety netting shall be installed, ~~[and]~~ maintained ~~[to cover]~~, and provided along all unenclosed perimeters.

Exceptions:

1. Vertical safety netting is not required ~~[at the]~~ for:
 - 1.1. ~~[Story]~~ The story at grade, provided it is less than 6 feet (1829 mm) above the level of the adjoining ground or structure; or
 - 1.2. The working deck; or
 - 1.3. Any story in concrete construction where the formwork has not been stripped, provided such floor is no more than four stories or 40 feet (12 192 mm) below the working deck, whichever is less; or
 - 1.4. Any story in steel construction where the concrete slab has not been [poured] placed, provided that no work, other than steel erection or metal deck placement, is occurring on that story.
2. Vertical safety netting is not required at a ~~[level]~~ location where a supported scaffold ~~[covers the full width of the unenclosed perimeter,]~~ has been installed provided the scaffold is decked ~~[and flush against]~~ even with the building at such level where the unenclosed perimeter exists, with no gap between the scaffold deck and the building deck greater than 3 inches (76 mm), and also provided that the scaffold is provided with netting and guardrails in accordance with Section 3314.8.
3. Vertical safety netting is not required to protect an unenclosed window opening, provided such window opening is enclosed with a sill not less than ~~[2] 3~~ feet 6 inches (~~[762] 1067~~ mm) in height ~~[and protected with vertical mullions or piers with a maximum opening of 5 feet (1524 mm) and a noncorrosive wire cable capable of withstanding a load of at least 200 pounds (890 n) applied in any direction except upward].~~
4. Vertical safety netting is not required for a building whose final height will be no more than 4 stories or 40 feet (12 192 mm) ~~[or less]~~ in height, whichever is less.
5. Vertical safety netting is not required for a minor alteration or ordinary repair.
6. Vertical safety netting is not required at a location where an equivalent alternative system acceptable to the commissioner, including but not limited to cocoon systems, climbing formwork, or enclosure panels, has been installed.

3308.5.1 Openings. The largest opening area for debris netting when used vertically shall not be larger than 1 square inch (~~[25.4]~~ 645 mm²), with no opening larger than 1 inch (25 mm) in the vertical or horizontal dimensions and 1 ½ inch (38 mm) in any other dimension.

3308.5.2 Height. Where required, vertical safety netting shall extend to cover all openings in the unenclosed perimeter to a height of at least 60 inches (1524 mm) above the floor or, where installed at the roof level, the roof.

3308.5.3 Cables. Vertical safety netting shall be secured to noncorrosive wire cable capable of withstanding a load of at least 200 pounds (90.7 kg) applied in any direction except upward. The cables shall be located at a height of 60 inches (1524 mm), 42 inches (1067 mm), 21 inches (533 mm), and 0 inches (0 mm) above the level of the floor or, where installed at the roof level, the roof. Where the vertical safety netting extends above 60 inches (1524 mm) in height, a cable shall also be placed at the top of the netting, with intermediate cables between the 60 inch (1524 mm) cable and the top cable as needed to satisfy the design requirements of Section 3308.3.

Exceptions: In lieu of a cable:

1. At 60 inches (1524 mm) or above, a toprail made of wood, pipe, or structural angle meeting the requirements of Section 3308.7.3.
2. At 42 inches (1067 mm) and 21 inches (533 mm), midrails made of wood, pipe, or structural angle meeting the requirements of Section 3308.7.3.
3. At 0 inches (0 mm), a toeboard meeting the requirements of Sections 3308.7.2 and 3308.7.3, provided the net is secured to the toeboard.

3308.5.3.1 Zero cable. Zero cables shall be secured to the deck and be maintained in contact with the deck such that debris cannot accumulate nor pass beneath the cable.

3308.5.4 Taut systems. Where the vertical safety netting relies upon a taut system, the net and cables shall be maintained taut. A positive tensioning system such as a turnbuckle shall be provided to keep the cable taut.

3308.5.5 Friction connections. Wood installations that utilize a friction connection are not permitted.

~~[3308.5.6 Temporary removal. Vertical safety netting may be temporarily removed in the immediate area where active loading or unloading operations are occurring, or where perimeter work is occurring, provided that:]~~

- ~~[1. A controlled access zone is established to prevent unauthorized personnel from entering the area where the nets are removed; and]~~
- ~~[2. Immediately prior to the removal of the nets the floor is broom swept and cleared of all material, equipment, and debris to a distance of at least 10 feet (3048 mm), in all directions, from the area where the vertical nets will be removed.]~~

~~[Exceptions: The following material does not have to be removed to a distance of at least 10 feet (3048 mm), in all directions:]~~

~~[1. Material and equipment related to the loading or unloading operation or perimeter work.]~~

~~[2. Stored materials in accordance with Section 3303.4.5.2.]~~

~~[3308.5.6.1 Restoring nets. The vertical safety nets shall be reinstalled immediately following the end of active loading or unloading operations, or active work, or at the end of the workday, whichever occurs sooner.]~~

3308.5.6 Temporary removal. The requirements of Section 3308.10 shall apply.

3308.5.6.1 Supplemental requirement for removal of toeboard or zero cable. The toeboard or zero cable may be temporarily removed to facilitate the placement and curing of a concrete floor slab, provided no other work occurs on such floor, and provided an alternative measure is utilized to secure the bottom of the netting as close to the deck as practical.

3308.5.7 Permanent removal. Vertical safety netting systems may be removed from floors where the façade has been installed and all such openings in the façade, including for windows, have been permanently enclosed to a height of at least 60 inches (1524 mm) above the floor. Vertical safety netting systems may be removed from the roof where the final parapet or guardrail has been installed.

3308.6 Horizontal safety netting systems. Horizontal safety netting shall meet the requirements of Sections 3308.6.1 through 3308.6.4.

3308.6.1 Where required. Horizontal safety netting shall be installed and maintained as follows.

3308.6.1.1 During construction. When, during the course of new building construction, or during the vertical or horizontal enlargement of an existing building, the ~~[uppermost]~~ topmost walkable floor reaches a height of six stories or 75 feet (22 860 mm), whichever is less, above the level of the ground or an adjoining roof, horizontal safety netting shall be provided at a level not more than two stories or 30 feet (9144 mm), whichever is less, below:

1. In concrete structures: the stripping floor; or
2. In steel structures: at the ~~[uppermost]~~ topmost story where the concrete floor slab has been ~~[poured]~~ placed.

Exception: When tarpaulins encase one or more floors immediately below the finished concrete floor in order to maintain temporary heat, the horizontal netting may be located no more than three floors below the finished concrete floor.

3308.6.1.2 During demolition. When the demolition of the exterior walls or the roof of a building occurs at a height greater than ~~[6]~~ six stories or 75 feet (22 860 mm), whichever is less, horizontal safety netting shall be provided at a level not more than two stories or 30 feet

(9144 mm), whichever is less, below the story from which the exterior walls and roof are being removed.

Exception: Demolition of exterior walls only for the purposes of the alteration, maintenance, or repair of a façade shall be in accordance with Section 3308.6.1.3.

3308.6.1.3 During façade [~~construction,~~] alteration, maintenance, or repair. Where unique hazards associated with the [~~construction,~~] alteration, maintenance, or repair of a façade exist to the public and property, horizontal safety netting shall be provided as required by the commissioner.

3308.6.1.4 Alternative systems. Alternative systems may be used in lieu of horizontal safety netting in accordance with the requirements of Sections 3308.6.1.4.1 or 3308.6.1.4.2.

3308.6.1.4.1 Supported scaffold alternative. [~~In lieu of horizontal safety netting in accordance with Sections 3308.6.1.1 through 3308.6.1.3, a supported scaffold may be utilized provided such supported scaffold covers the full width of the unenclosed perimeter,~~] Horizontal safety netting is not required at a location where a supported scaffold has been installed provided the scaffold is decked [and flush against] even with the building at the level where [work is occurring,] the horizontal safety net would otherwise be required to be installed and all levels above where the horizontal nets would otherwise be required, with no gap between the scaffold deck and the building deck greater than 3 inches (76 mm), and also provided that the scaffold is provided with netting and guardrails in accordance with Section 3314.8.

3308.6.1.4.2 Other alternative systems. Horizontal safety netting is not required at a location where an equivalent alternative system acceptable to the commissioner, including but not limited to cocoon systems or climbing formwork, covers the full height of the unenclosed perimeter at and above all levels where horizontal nets are required.

3308.6.1.5 Hoisting area. Where approved by the commissioner, horizontal safety netting may be omitted in designated crane, derrick, or hoisting areas.

3308.6.1.6 Temporary removal. [~~Horizontal safety netting may be temporarily removed in the immediate area where active loading or unloading operations are occurring, or where perimeter work is occurring, or to relocate the nets to a higher level, provided that no concrete work, including formwork placement or stripping, no structural steel placement or assembly, and no work within 10 feet (3048 mm) from an unenclosed perimeter of the building occurs on levels above the horizontal safety netting. Horizontal safety nets shall be reinstalled immediately following the end of active loading or unloading operations, or active work, or at the end of the workday, whichever occurs sooner.] The requirements of Section 3308.10 shall apply.~~

3308.6.1.7 Permanent removal. Horizontal safety netting systems may be permanently removed as follows:

1. Horizontal safety netting systems installed for the construction of a building in accordance with Section 3308.6.1.1 may be removed after all concrete has been

[poured] placed at the highest level and all concrete stripping work at the highest level has been completed.

2. Horizontal safety netting systems installed for the demolition of a building in accordance with Section 3308.6.1.2 may be removed after the demolition has progressed to within six stories or 75 feet (22 860 mm), whichever is less, above the ground or adjoining roof level.
3. Horizontal safety netting systems installed for façade work in accordance with Section 3308.6.1.3 may be removed after all façade work above the level of the nets has been completed.

3308.6.2 Horizontal safety netting systems requirements. Horizontal safety netting systems shall meet the requirements of Sections 5, 6.3, 6.4, 6.5, 6.6, 7, 8, 10.1, 10.4, 10.5, 10.6, 10.7, 11, and 13 of [~~ANSI/ASSE~~] ANSI/ASSP A10.11, as modified as follows.

3308.6.2.1 Personnel net. Throughout the standard, the term “personnel net” shall be amended to read “structural net.”

3308.6.2.2 Should and shall. Throughout the standard, the term “should” shall be amended to read “shall.”

3308.6.2.3 Entanglement. The phrase, “and to minimize entanglement of the persons head, arms, and legs when arresting the fall,” shall be deleted from Section 6.3 of [~~ANSI/ASSE~~] ANSI/ASSP A10.11.

3308.6.2.4 Arresting a fall. The phrase “when arresting a fall,” shall be deleted from Section 6.4 of [~~ANSI/ASSE~~] ANSI/ASSP A10.11.

3308.6.2.5 Size of debris net openings. Section 6.6 of [~~ANSI/ASSE~~] ANSI/ASSP A10.11 shall be amended by adding a new sentence at the end of the section, as follows, “However, in no case shall the largest opening area for debris netting when used horizontally be larger than ½ square inch (~~[12.7]~~ 323 mm²), with no opening larger than ½ inch (13 mm²) in the vertical or horizontal dimensions and ¾ inch (19 mm) in any other dimension.”

3308.6.2.6 Projection of nets. The phrase, “as to capture falling personnel” in Section 10.6 of [~~ANSI/ASSE~~] ANSI/ASSP A10.11 shall be amended to read “as to capture falling material.”

3308.6.2.7 Supports. The phrase, “or personnel” in Section 10.7 of [~~ANSI/ASSE~~] ANSI/ASSP A10.11 shall be amended to read, “or material.”

3308.6.2.8 Inspection. Section 11.1 of [~~ANSI/ASSE~~] ANSI/ASSP A10.11 shall be deleted in its entirety and replaced with the following, “Horizontal safety netting systems shall be inspected in accordance with Section 3308.9.3.”

3308.6.2.9 Dates tested. The phrase “Dates inspected” in Item 5 of Section 11.4 of [~~ANSI/ASSE~~] ANSI/ASSP A10.11 shall be amended to read “Dates tested”.

3308.6.2.10 Moving. Section 11.4 of ~~[ANSI/ASSE]~~ ANSI/ASSP A10.11 shall be amended to add a new Item 9, which shall read, “Dates nets were moved to a higher or lower level.”

3308.6.2.11 Cleaning. Section 13.2 of ~~[ANSI/ASSE]~~ ANSI/ASSP A10.11 shall be deleted and replaced with the following: “Horizontal safety netting shall not be used for storing material. Horizontal netting shall be cleaned, at least daily, to remove any items that fall into the nets.”

3308.6.3 Tensile strength test. The tensile strength of netting mesh and/or twine of a structural net utilized in conjunction with a horizontal safety netting system shall be confirmed by testing in accordance with ASTM D 5034 or ASTM D 5035. The testing criteria shall be developed by the registered design professional who designed the safety netting system in accordance with Section 3308.3. Such testing shall occur prior to the installation of the net at the site for any net that has previously been used, and for any net that has been installed at the site for two years and every two years thereafter. Nets that do not meet the specified tensile strength as required by Section 3308.3.5 shall not be utilized or shall be replaced.

3308.6.4 Identification of nets. Structural netting shall be identified in accordance with Section 7 of ~~[ANSI/ASSE]~~ ANSI/ASSP A10.11. Debris netting shall be identified by a letter or other documentation from the manufacturer stating the description and model. The identification for structural netting and debris netting shall be kept at the site until the netting is removed.

3308.7 Guardrail system. A guardrail system shall be installed, ~~and~~ maintained ~~[to protect], and provided along~~ all unenclosed perimeters.

Exceptions: A guardrail system is not required at:

1. The story at grade, provided that it is less than 6 feet (1829 mm) above the level of the adjoining ground or structure.
2. ~~[Levels]~~ Locations where vertical safety netting is installed in accordance with Section 3308.5.
3. ~~[Levels]~~ Locations where a supported scaffold ~~[covers the full width of the unenclosed perimeter,]~~ has been installed provided the scaffold is decked ~~[and flush against]~~ even with the building at such level where the unenclosed perimeter exists, with no gap between the scaffold deck and the building deck greater than 3 inches (76 mm), and also provided that the scaffold is provided with netting and guardrails in accordance with Section 3314.8.
4. Locations where an equivalent alternative system acceptable to the commissioner, including but not limited to cocoon systems, climbing formwork, or enclosure panels, has been installed.

3308.7.1 Components. Guardrail systems shall include a toprail, midrail, toeboard, and posts.

3308.7.2 Height of railings and toeboard. Toprails, midrails, and toeboards shall be located as follows:

1. The top of the toprail shall be located at a height of 39 to 45 inches (991 and 1143 mm) above the floor.
2. The midrail shall be located at a height approximately midway between the toprail and the floor, or where more than one midrail is utilized, each shall be located equidistant from each other, the floor, and the toprail.
3. The toeboard shall be at least 3 ½ inches (89 mm) high and shall be installed so that there is not more than a ¼ inch (6 mm) gap between the floor and the bottom of the toeboard.

Exception: When conditions warrant, the height of the toprail may exceed the 45-inch (1143 mm) height provided additional midrails are installed so that there is no vertical gap larger than 24 inches (610 mm) between any toeboard, midrail, or toprail.

3308.7.3 Dimensions and materials. Toprails, midrails, toeboards, and posts shall have the following dimensions and be constructed out of the following materials:

1. Toprails shall, at a minimum, consist of:
 - 1.1. 2 inch by 4 inch (51 mm by 102 mm) 1500 [~~lb-ft/in²~~] foot pounds per square inch (1.05 kgf/mm²) fiber (stress grade) construction grade lumber;
 - 1.2. 1 ½ inch (38 mm) nominal diameter (~~[schedule]~~ Schedule 40) pipe;
 - 1.3. 2 inch by 2 inch by [~~3/8th~~] 3/8th inch [~~(51x51x10mm)~~] (51 mm by 51 mm by 10 mm) structural angle; or
 - 1.4. ¼ inch (6 mm) diameter [~~non-corrosive~~] noncorrosive wire cable made of mild plow steel.
2. Midrails shall, at a minimum, consist of:
 - 2.1. 1 inch by 6 inch (25 mm by 152 mm) 1500 [~~lb-ft/in²~~] foot pounds per square inch (1.05 kgf/mm²) fiber (stress grade) construction grade lumber;
 - 2.2. 1 ½ inch (38 mm) nominal diameter (~~[schedule]~~ Schedule 40) pipe;
 - 2.3. 2 inch by 2 inch by [~~3/8th~~] 3/8th inch [~~(51x51x10mm)~~] (51 mm by 51 mm by 10 mm) structural angle; or
 - 2.4. ¼ inch (6 mm) diameter [~~non-corrosive~~] noncorrosive wire cable made of mild plow steel.
3. Toeboards shall, at a minimum, consist of:
 - 3.1. 1 inch by [~~6~~] 4 inch (25 mm by [~~152~~] 102 mm) lumber; or
 - 3.2. Metal plank at least 3½ inches (89 mm) high.

4. Toprails, midrails, and toeboards shall be securely fastened to upright posts spaced not more than 8 feet (2438 mm) apart. Such posts shall, at a minimum, consist of:
 - 4.1. 2 inch by 4 inch (51 mm by 102 mm) 1500 [~~lb-ft/in²~~] foot pounds per square inch (1.05 kgf/mm²) fiber (stress grade) construction grade lumber;
 - 4.2. 1½ inch (38mm) nominal diameter (~~[schedule]~~ Schedule 40) pipe;
 - 4.3. 2 inch by 2 inch by [~~3/8th~~] 3/8 inch [~~(51x51x10mm)~~] (51 mm by 51 mm by 10 mm) structural angle; or
 - 4.4. A building column.

Exceptions:

1. Guardrail systems designed by a registered design professional capable of withstanding, without failure:
 - 1.1. A force of at least 200 pounds (890 [N]) applied within 2 inches (51 mm) of the top edge, in any outward or downward direction, at any point along the top edge. Where the force is applied in a downward direction, the top edge shall not deflect more than 6 inches (152 mm) and in no case to a height less than 39 inches (991 mm) above the floor; and
 - 1.2. A load of at least 50 pounds (222 [N]) applied in any downward or horizontal direction at any point along the toeboard.
2. Posts supporting wire cable top rails and mid rails, as well as the toeboards utilized in connection with such wire cable top rails and mid rails, may be spaced more than 8 feet (2438 mm) apart provided that the posts are spaced such that where a force of 200 pounds (890 [N]) is applied in a downward direction along the top edge, the top edge shall not deflect more than 6 inches (152 mm) and in no case to a height less than 39 inches (991 mm) above the floor.

3308.7.4 Horizontal gap. The guardrail system shall be installed so that there exists no horizontal gap larger than 1 inch (25 mm) as measured along the perimeter of the building from the edge of the guardrail system to any building column or façade.

3308.7.5 Tensioning system. When made of wire cable, top rails and mid rails shall be provided with a positive tensioning system, such as a turnbuckle, to keep the cable taut.

3308.7.6 Dislodgement. Guardrail systems shall be secured to prevent dislodgement by impact or wind.

~~[3308.7.7 Temporary removal. Guardrail systems may be temporarily removed in the immediate area where active loading or unloading operations are occurring, or where perimeter work is occurring, provided that:]~~

- ~~[1. A controlled access zone is established to prevent unauthorized personnel from entering the area where the guardrail system is removed; and]~~
- ~~[2. Immediately prior to the removal of the guardrail system the floor is broom swept and cleared of all materials and equipment to a distance of at least 10 feet (3048 mm), in all directions, from the area where the guardrail system will be removed, except for material and equipment related to the loading or unloading operation or perimeter work or stored in accordance with Section 3303.4.5.2.]~~

~~[3308.7.7.1 Restoring guardrails. The guardrail system shall be reinstalled immediately following the end of active loading or unloading operations, or active work, or at the end of the workday, whichever occurs sooner.]~~

~~[Exception: Where material overhangs overnight in accordance with Section 3303.4.5.2.]~~

3308.7.7 Temporary removal. The requirements of Section 3308.10 shall apply.

3308.7.8 Permanent removal. Guardrail systems installed to protect unenclosed perimeters may be removed where vertical safety netting systems meeting the requirements of Section 3308.5 have been installed.

~~[**3308.8 Modifications and alternative systems.** The commissioner may, based upon a written request from a registered design professional, modify the requirements for safety netting systems and guardrail systems required by this section, including but not limited to the installation of alternative systems, provided such modification or alternative system meets or exceeds the level of safety afforded to the public and property by safety netting systems and guardrail systems installed in accordance with this section.]~~

~~[**3308.8.1 Request content.** A request submitted under Section 3308.8 shall include:]~~

~~[1. Details of the modification or alternative system to be utilized;]~~

~~[2. Any stipulations;]~~

~~[3. Demonstration that the request meets or exceeds the level of safety afforded to the public and property by safety netting systems and guardrail systems installed in accordance with this section;]~~

~~[4. Where applicable, a description of the practical difficulty of complying with code requirements;]~~

~~[5. Where applicable, a reference to the site safety monitoring program; and]~~

~~[6. Where an alternative system is proposed, a minimum level of inspection in accordance with the recommendations of the manufacturer of the alternative system.]~~

3308.8 Modifications. The commissioner may, based upon a written request from a registered design professional, modify the requirements for unenclosed perimeter protection in accordance with Section 28-103.3 of the *Administrative Code*.

3308.9 Unenclosed perimeter protection inspection, use, adjustment, maintenance, and repair. ~~[Safety net systems, guardrail systems, and alternative systems authorized under Section 3308.8]~~ Unenclosed perimeter protection shall be inspected, used, adjusted, maintained, repaired, and replaced in accordance with the design drawings, manufacturer ~~[recommendations]~~ specifications, and the requirements of this code. Where there is a discrepancy, the stricter standard shall apply.

3308.9.1 Safe condition. ~~[Safety net systems, guardrail systems, and alternative systems authorized under Section 3308.8]~~ Unenclosed perimeter protection shall be maintained in a safe condition and used in a manner that eliminates hazards to the public and property. Any hazardous conditions or defects discovered with such shall immediately be brought to the attention of the responsible permit holder under Section 3308.4.

3308.9.2 Precautions. Precautions shall be taken to prevent ~~[safety net systems, guardrail systems, and alternative systems authorized under Section 3308.8]~~ unenclosed perimeter

protection from being damaged by sunlight, abrasion, sand, rust, welding, cutting operations, chemicals, and airborne contaminants, where such systems are susceptible to damage by such.

3308.9.3 Inspections. [~~Safety net systems, guardrail systems, and alternative systems authorized under Section 3308.8~~] Unenclosed perimeter protection shall be inspected for compliance with this code, manufacturer specifications, and required drawings at least daily, as well as before and after each removal and restoration in accordance with Section 3308.10.3, and after each impact loading event, installation, reinstallation, adjustment, maintenance, or repair of [~~such,~~] the unenclosed perimeter protection or any part or component of such. Where the job requires a site safety manager or coordinator in accordance with Section 3310, the inspection shall be performed by the site safety manager or coordinator, and a written record of such inspection maintained as part of the site safety log. Where the job does not require a site safety manager or coordinator, the inspection shall be performed by a competent person designated by the permit holder in accordance with Section 3308.4, with a record of such inspection prepared, initialed, and dated by such competent person.

3308.9.4 Removing from service. [~~Safety net systems, guardrail systems, and alternative systems authorized under Section 3308.8~~] Unenclosed perimeter protection showing signs of mildew, corrosion, wear, tears, breaks, frays, damage, or deterioration that may substantially affect the strength of such shall be immediately removed from service.

3308.9.5 Repair. Repairs to [~~safety net systems, guardrail systems, and alternative systems authorized under Section 3308.8~~] unenclosed perimeter protection shall be in accordance with the specifications of the manufacturer of such and shall provide the original manufacturer factor of safety, or where [~~none exists~~] manufacturer specifications do not exist, shall be repaired in accordance with specifications developed by the registered design professional responsible for the design of the [~~safety netting systems~~] unenclosed perimeter protection in accordance with Section 3308.3.1.

Exception: Structural nets and debris nets shall not be repaired.

3308.9.6 Vacuum cleaning. Areas in the vicinity of operations related to the installation, reinstallation, adjustment, maintenance, repair, temporary removal, or permanent removal of unenclosed perimeter protection systems that produce or typically produce small debris shall be vacuumed as the operation progresses. Examples of operations that produce small debris include, but are not limited to, the installation or removal of fasteners for a vertical netting system, chipping to expose curtain wall clips, preparation of the slab to install or receive exterior walls, and chopping or core drilling at perimeter for mechanical risers. Vacuum equipment shall be tethered or otherwise secured to prevent the equipment from falling.

3308.10 Temporary removal of unenclosed perimeter protection. Unenclosed perimeter protection, or portions thereof, may be temporarily removed in the immediate area where active loading or unloading operations are occurring, or to the extent necessary to facilitate active work at the perimeter, including but not limited to inspections or the relocation of unenclosed perimeter protection to a higher level, provided there is compliance with the following items:

1. All material, equipment, and debris on the floor is secured against dislodgement by wind or accidental impact;

2. A controlled access zone is established to prevent unauthorized personnel from entering the area where the unenclosed perimeter protection has been removed;
3. Prior to removal the floor is cleared of all material, equipment, and debris to a distance of at least 10 feet (3048 mm) in all directions from the area where the unenclosed perimeter protection is to be removed, except for material or equipment that is related to the active loading or unloading operation or active work at the perimeter, or that is stored in accordance with Section 3303.4.5.2;
4. Immediately prior to removal the floor is broom-swept to a distance of at least 10 feet (3048 mm) in all directions from the area where the unenclosed perimeter protection is to be removed and, in addition, areas in the immediate vicinity of the unenclosed perimeter protection are vacuumed, including areas around zero cables, toeboards, and spaces where trapped debris may have accumulated;
5. During removal operations areas are vacuumed as required by Section 3308.9.6;
6. A competent person supervises the operation as required by Section 3308.10.2;
7. Where vertical safety netting, guardrails, or equivalent alternative systems are removed, the removal does not extend past the column bays where the active loading or unloading operations are occurring or where active work at the perimeter is occurring; and
8. Where horizontal safety netting or equivalent alternative systems are removed, none of the following types of work occurs at or above the level where the horizontal safety netting or equivalent alternative system has been removed:
 - 8.1. Concrete work, including formwork placement or stripping;
 - 8.2. Structural steel placement or assembly; or
 - 8.3. Any other work within 10 feet (3048 mm) from an unenclosed perimeter of the building.

3308.10.1 Restoring unenclosed perimeter protection. Unenclosed perimeter protection shall be reinstalled immediately following the end of the active loading or unloading operation or active work at the perimeter, or at the end of the shift, whichever occurs sooner. Immediately prior to restoring a guardrail system, vertical netting system, or equivalent alternative system, areas in the vicinity of the edge shall be vacuumed, and other areas to a distance of at least 10 feet (3048 mm), in all directions from the area where the unenclosed perimeter protection is removed, shall be broom-swept. Vacuum equipment shall be tethered or otherwise secured to prevent the equipment from falling.

Exceptions:

1. Where material overhangs overnight in accordance with Section 3303.4.5.2, guardrails shall be reinstalled the next work day immediately following the relocation of the material.
2. Where a toeboard or zero cable has been temporarily removed to facilitate the placement and curing of a concrete floor slab, the toeboard or zero cable shall be reinstalled as soon as practical.

3308.10.2 Competent person. The competent person designated in accordance with Section 3308.4 shall supervise the temporary removal and reinstallation of unenclosed perimeter protection, including all ancillary activities, such as preparing the area for the removal of the unenclosed perimeter protection, and shall ensure compliance with the requirements of Section 3308.10.

3308.10.3 Inspection. An inspection shall be performed immediately prior to the removal of unenclosed perimeter protection to verify compliance with the provisions of Section 3308.10. An inspection shall be performed immediately prior to restoring a guardrail system, vertical netting system, or equivalent alternative system to verify compliance with the cleaning provisions of Section 3308.10.1. An inspection shall be performed immediately after unenclosed perimeter protection is restored to verify compliance with this code, manufacturer specifications, and required drawings. These inspections shall be performed by the site safety manager, site safety coordinator, or competent person in accordance with Section 3308.9.3, and recorded in accordance with Section 3308.9.3.

§ 40. Section BC 3309 of the New York city building code, as amended by local law number 141 for the year 2013, section 3303.9.1 as amended by local law 97 for the year 2017, is amended to read as follows:

**SECTION BC 3309
PROTECTION OF ADJOINING PROPERTY**

3309.1 Protection required. Adjoining public and private property, including persons thereon, shall be protected from damage and injury during construction or demolition work [~~in accordance with the requirements of this section~~]. Protection must be provided for footings, foundations, party walls, chimneys, skylights and roofs as specified by this section. Provisions shall also be made to control water run-off and erosion during construction or demolition activities. Where the New York City Department of Environmental Protection has issued a stormwater construction permit for a covered development project, such run-off and erosion controls shall be installed and maintained in accordance with the rules of the Department of Environmental Protection and this code.

3309.1.1 Notification. Where a construction or demolition project will require access to adjoining property in accordance with this section, written notification shall be provided to the adjoining property owner at least 60 calendar days prior to the commencement of work. Such

notification shall describe the nature of work, estimated schedule and duration, details of inspections or monitoring to be performed on the adjoining property, protection to be installed on the adjoining property, and contact information for the project. Where no response is received, a second written notification shall be made no more than 45 calendar days, and not less than 30 calendar days, prior to the commencement of work.

3309.2 License to enter adjoining property. The responsibility of affording any license to enter adjoining property shall rest upon the owner of the adjoining property involved; and in case any tenant of such owner fails or refuses to permit the owner to afford such license, such failure or refusal shall be a cause for the owner to dispossess such tenant through appropriate legal proceedings for recovering possession of real property. Nothing in this chapter shall be construed to prohibit the owner of the property undertaking construction or demolition work from petitioning for a special proceeding pursuant to Section 881 of the *Real Property Actions and Proceedings Law*.

3309.3 Physical examination. When permission to enter upon adjoining property has been obtained, a physical examination of such property shall be conducted by the person causing the construction or demolition operations prior to the commencement of the operations and at reasonable periods during the progress of the work. Observed conditions shall be recorded by the person causing the construction or demolition operations, and such records shall be made available to the department upon request.

3309.4 Soil or foundation work affecting adjoining property. Whenever soil or foundation work occurs, regardless of the depth of such, the person who causes such to be made shall, at all times during the course of such work and at his or her own expense, preserve and protect from damage any adjoining structures, including but not limited to footings and foundations, provided such person is afforded a license in accordance with the requirements of Section 3309.2 to enter and inspect the adjoining buildings and property, and to perform such work thereon as may be necessary for such purpose. If the person who causes the soil or foundation work is not afforded a license, such duty to preserve and protect the adjacent property shall devolve to the owner of such adjoining property, who shall be afforded a similar license with respect to the property where the soil or foundation work is to be made.

3309.4.1 Additional safeguards during excavation. The following additional requirements shall apply during excavation:

1. The person causing the excavation shall support the vertical and lateral load of the adjoining structure by proper foundations, underpinning, or other equivalent means where the level of the foundations of the adjoining structure is at or above the level of the bottom of the new excavation.
2. Where the existing adjoining structure is below the level of the construction or demolition, provision shall be made to support any increased vertical or lateral load on the existing adjoining structure caused by the construction or demolition.
3. Where the construction or demolition will result in a decrease in the frost protection for an existing foundation below the minimums established in Section [~~1805.3.1~~] 1809.3.1,

the existing foundation shall be modified as necessary to restore the required frost protection.

3309.4.2 Support of party walls. Where a party wall will be affected by excavation, regardless of the depth, the person who causes the excavation to be made shall preserve such party wall at his or her own expense so that it shall be, and shall remain, in a safe condition. Where an adjoining party wall is intended to be used by the person causing an excavation to be made, and such party wall is in good condition and sufficient for the uses of the existing and proposed buildings, it shall be the duty of such person to protect such party wall and support it by proper foundations, so that it shall be and remain practically as safe as it was before the excavation was commenced.

3309.4.3 Preconstruction survey. No excavation work to a depth of 5 feet to 10 feet (1524 mm to 3048 mm) within 10 feet (3048 mm) of an adjacent building, or an excavation over 10 feet (3048 mm) anywhere on the site shall commence until the person causing an excavation to be made has documented the existing conditions of all adjacent buildings in a preconstruction survey. In addition to the preconstruction survey, a geotechnical report in accordance with Section 1803.6, and an evaluation analysis in accordance with Section 1817, shall be prepared when required by Chapter 18.

3309.4.4 Monitoring. During the course of excavation work the following shall be monitored in accordance with Section 3309.16:

1. Buildings that are within a distance from the edge of the excavation that is equal to or less than the maximum depth of the excavation.
2. Historic structures that are contiguous to or within a lateral distance of 90 feet (27 432 mm) from the edge of the lot where an excavation is occurring.

Exception: Monitoring is not required for excavations to a depth of five feet (1523 mm) or less, provided:

1. The excavation occurs more than 5 feet (1524 mm) from all footings and foundations;
or
2. Where the excavation occurs within five feet (1524 mm) or less from a footing or foundation, such excavation does not occur below the level of the footing or foundation.

3309.4.5 Potential hazard. When, in the opinion of the commissioner, a potential hazard exists as a result of soil or foundation work, elevations of the adjacent buildings shall be recorded or other monitoring procedures shall be implemented by a registered design professional at intervals of 24 hours or less as determined by the commissioner to ascertain if movement has occurred.

3309.5 Underpinning or alternate methods of support of buildings and adjacent property. Whenever underpinning or an alternate method of support of buildings and adjacent property is required to preserve and protect an adjacent property from construction, demolition, or excavation

work, the person who causes such work shall, at his or her own expense, underpin or otherwise support the adjacent building and property provided such person is afforded a license in accordance with the requirements of Section 3309.2 to enter and inspect the adjoining buildings and property, and to perform such work thereon as may be necessary for such purpose. If the person who causes the construction, demolition, or excavation work is not afforded a license, such duty to preserve and protect the adjacent property shall devolve to the owner of the adjoining property, who shall be afforded a similar license with respect to the property where the construction, demolition, or excavation is to be performed.

3309.6 Subsurface operations affecting adjacent properties. Whenever subsurface operations, other than excavation or fill, are conducted that may impose loads or movements on adjoining property, including but not limited to the driving of piles, compaction of soils, or soil solidification, the effects of such operations on adjoining property and structures shall be monitored in accordance with Section 3309.16.

Exception: Monitoring during underpinning or alternate methods of support of buildings and adjacent property shall be in accordance with Section ~~[1814]~~ 1817.

3309.6.1 Change in ground water level. Where placement of a foundation will cause changes in the ground water level under adjacent buildings, the effects of such changes on the stability and settlement of the adjacent foundations shall be investigated and provision shall be made to prevent damage to such buildings.

3309.6.2 Potential hazard. When, in the opinion of the commissioner, a potential hazard exists as a result of subsurface operations, elevations of the adjacent buildings shall be recorded by a registered design professional at intervals of 24 hours or less as determined by the commissioner to ascertain if movement has occurred.

3309.7 Retaining structures. ~~[When the regulation of a lot requires the ground on such lot to be raised or lowered and kept higher than the ground of the adjoining lot, provided the ground of such adjoining lot is not maintained at a grade lower than in conformity with the street or streets on which it is situated; or where an excavation has been made or a fill placed on any lot meeting the curb level requirements; and the adjoining land is maintained at a grade in conformity with or lower than the streets or streets on which it is situated; and is without permanent structures other than frame sheds or similar structures, a retaining structure shall be constructed for the safe support of adjoining ground, unless the bank between the adjoining properties is maintained at a safe angle of repose. Any necessary retaining wall shall be built and maintained jointly by the owners on each side, unless otherwise agreed to by both owners.]~~ The requirements of Article 305 of Chapter 3 of Title 28 of the *Administrative Code* shall apply to the regulation of retaining structures.

~~[3309.7.1 Surplus retaining structures. Where any owner maintains his or her ground either higher or lower than the legal regulation prescribed in the *Administrative Code*, the surplus retaining structure that may be necessary to support such height or provide for such excavation shall be made at the sole expense of such owner, and any additional thickness that may be required shall be built on the land of such owner.]~~

~~[3309.7.2 Removal of retaining structures. Any retaining structure erected as provided above, standing partly on the land of each owner, may be removed by either owner when the original reason for the erection of such retaining structure ceases to exist.]~~

3309.8 Adjoining walls. When any construction or demolition operation exposes or breaches an adjoining wall, including load bearing and nonload-bearing walls as well as party walls and non party walls, the person causing the construction or demolition operation shall, at his or her own expense, perform the following:

1. Maintain the structural integrity of such walls and adjoining structure, and have a registered design professional investigate the stability and condition of the wall and adjoining structure, and take all necessary steps to protect such wall and structure.
2. Maintain all required fire exits and passageways or provide substitutions meeting the requirements of this code.
3. Cut off close to the walls all beams in party walls, remove stub ends without weakening existing masonry, clean beam pockets of loose mortar, bend over all wall anchors at the beam ends in the standing wall, and brick-up all open beam holes with sound brick and ~~[ement]~~ compatible mortar.
4. During demolition operations, where the floor beams of the adjacent building bear on the party wall, the person causing the demolition shall ascertain that such beams are anchored into the wall and, where such anchorage is lacking, shall provide anchorage or otherwise brace the standing wall.
5. During demolition operations, all nonload-bearing chimney breasts, projections and any other debris exposed on party walls shall be examined and monitored by the person causing the demolition. Removal of such items shall be made under the supervision of a registered design professional only if the stability of the adjacent building or structure will not be affected. All openings shall be bricked up flush on the ~~[exterior]~~ exposed side of the party wall. All masonry that is in poor condition shall be pointed and patched.

3309.9 Weatherproof integrity of adjoining buildings. Where the waterproof integrity of an adjoining wall or building has been impaired due to construction or demolition operations, the person causing the construction or demolition operations shall, at his or her own expense, provide all necessary measures to permanently waterproof the adjoining wall or building in order to establish or restore the weatherproof integrity of such adjoining wall or building. This shall include, but is not limited to:

1. Bending over and flashing all roofing material of adjoining buildings;
2. Sealing and permanently waterproofing all doors or other openings in party walls;
3. Properly sealing all cornices, where cut;
4. Pointing up and making waterproof any walls and parapets and any walls that have been disturbed;

5. Removing all exposed furring, lath, and plaster on party walls; and
6. Removing, replacing, and firmly anchoring any loose wall material.

3309.10 Protection of roofs. Whenever any building is to be constructed or demolished above the roof of an adjoining building, it shall be the duty of the person causing such work to protect from damage at all times during the course of such work and at his or her own expense the roof, skylights, other roof outlets, and equipment located on the roof of the adjoining building, and to use every reasonable means to avoid interference with the use of the adjoining building during the course of such work, provided such person causing such work is afforded a license in accordance with the requirements of Section 3309.2 to enter and inspect the adjoining building and perform such work thereon as may be necessary for such purpose; otherwise, the duty of protecting the roof, skylights, other roof outlets, and equipment on the roof of the adjoining building shall devolve upon the owner of such adjoining building.

Adjoining roof protection shall be secured to prevent dislodgement by wind. Where construction or demolition work occurs at a height of at least 48 inches (1219 mm) above the level of the adjoining roof, adjoining roof protection shall consist of 2 inches (51 mm) of flame-retardant foam under 2 inches (51 mm) of flame-retardant wood plank laid tight and covered by flame-retardant plywood, or shall consist of equivalent protection acceptable to the commissioner, and shall ~~[extend to a distance of at least 20 feet (508 mm) from the edge of the building being constructed or demolished.]~~ cover all areas of the adjoining roof that are within a horizontal distance from the building being constructed or demolished equal to the height of the highest working level of the building being constructed or demolished, to a maximum of 20 feet (6096 mm), or to a greater maximum when ordered by the commissioner due to a unique hazard at the site.

Exceptions:

1. Adjoining roof protection is not required along an exposure where a site specific engineered enclosure system that is acceptable to the commissioner and meets the requirements of Section 3309.17 has been installed to cover the entire exposure where work is occurring.
2. Where vents, equipment, or similar obstructions are present on the roof, the roof protection shall be elevated to avoid interference, or an equivalent elevated system, designed by a registered design professional, shall be installed.
3. Occupiable spaces on an adjoining roof, such as a roof terrace, observation deck, rooftop bar, or residential balcony, that will not be closed during the work, shall instead be protected in accordance with Section 3309.13.

3309.11 Protection of trees. No trees outside the property line within the public right-of-way shall be disturbed or removed without the permission of the commissioner of the department of parks and recreation. Protection meeting the requirements of the department of parks and recreation shall be provided for all such trees, and written notification shall also be made to the department of parks and recreation at least 48 hours prior to commencement of such work.

3309.11.1 Deleterious, caustic, or acid materials. No deleterious, caustic, or acid materials shall be dumped or mixed within 10 feet (3048 mm) of any tree within the public right-of-way, nor shall salt for the removal of ice or snow be applied when runoff will drain to a tree within the public right-of-way.

Exceptions:

2. Mixing, delivery, or placement of concrete from a concrete mixer or concrete truck.
3. Application of de-icing materials as necessary to prevent slipping and tripping hazards in areas accessible to the public during periods where freezing conditions are to be encountered.

3309.12 Protection of chimneys. Any person having the duty to alter or maintain chimneys of any adjoining building under and pursuant to the provisions of this code, the *New York City Mechanical Code*, the *New York City Fuel Gas Code*, or other applicable laws and rules shall be afforded a license in accordance with the requirements of Section 3309.2 to enter and inspect such adjoining building and perform such work thereon as may be necessary for such purpose; otherwise, such duty shall devolve upon the owner of such adjoining building.

3309.13 Protection of adjoining equipment and spaces. Whenever a [~~major~~] building is constructed or demolished, [~~and provided such work requires a site safety plan in accordance with Section 3310,~~] it shall be the duty of the person causing such work to protect from damage, at all times during the course of such work and at his or her own expense, all mechanical, electrical, and similar equipment on the adjoining property [~~that are within 20 feet (508 mm) from an unenclosed perimeter of the major building~~], and to protect all [~~publically~~] publicly accessible spaces on the adjoining property [~~that are within 20 feet (508 mm) from an unenclosed perimeter of the major building~~], and also to use every reasonable means to avoid interference with the use of such equipment and spaces during the course of such construction or demolition work, provided such person causing such work is afforded a license in accordance with the requirements of Section 3309.2 to enter and inspect the adjoining property and perform such work thereon as may be necessary for such purpose; otherwise, the duty of protecting such adjoining equipment and spaces shall devolve upon the owner of such adjoining property.

Adjoining equipment and space protection shall be secured to prevent dislodgement by wind. Where the construction or demolition work requires a site safety plan in accordance with Section 3301.13 or 3310 and access to the equipment or space is not precluded, adjoining equipment and space protection shall be designed to provide a level of overhead protection equivalent to that provided by a sidewalk shed in accordance with Section 3307, and shall cover all adjoining equipment or spaces that are within a horizontal distance from the building being constructed or demolished equal to the height of the highest working level of the building being constructed or demolished, to a maximum of 20 feet (6096 mm), or to a greater maximum when ordered by the commissioner due to a unique hazard at the site.

[~~Exception:~~] Exceptions:

1. Equipment on an adjoining roof shall be protected in accordance with Section 3309.10.

2. Adjoining equipment and space protection is not required along an exposure where a site specific engineered enclosure system, acceptable to the commissioner, and meeting the requirements of Section 3309.17, has been installed to cover the entire exposure where work is occurring.

3309.14 Protection of windows. Whenever exterior construction or demolition work occurs, and such work results in an unenclosed perimeter, it shall be the duty of the person causing such work to protect from damage, at all times during the course of such work and at his or her own expense, all windows on adjoining private property that face such work and are 20 feet (508 mm) or less from an unenclosed perimeter, provided such person causing such work is afforded a license in accordance with the requirements of Section 3309.2 to enter and inspect the adjoining property and perform such work thereon as may be necessary for such purpose; otherwise, the duty of protecting the adjoining windows shall devolve upon the owner of such adjoining building.

Where the window provides required means of natural lighting, natural ventilation, or egress, such protection shall not be allowed to interfere with such required means.

Exceptions: Window protection is not required for:

1. Minor alterations and ordinary repairs.
2. Work performed on a one-, two- or three-family detached house or accessory use to such.
3. ~~[Where all]~~ Locations where the unenclosed [perimeters are] perimeter of the building under construction or demolition is protected along the entire exposure by vertical netting that meets the requirements of Section 3308.5, [or an approved alternate system, that extends to cover the full height and width of the unenclosed perimeter; or a supported scaffold covers the full width of the unenclosed perimeter, provided the scaffold is decked and flush against the building at such level where the unenclosed perimeter exists, with no gap between the scaffold and the building greater than 3 inches (76 mm), and also provided that the scaffold is provided with netting and guardrails in accordance with Section 3314.8.] supported scaffolding provided with guardrails and netting in accordance with Section 3314.8, or an equivalent alternative system acceptable to the commissioner.

3309.15 Modifications and alternate methods. The commissioner may, in accordance with Section 28-103.3 of the Administrative Code, and based upon a written request from a registered design professional, modify the requirements for adjoining property protection required by this section, including but not limited to authorizing the installation or use of alternative methods[; ~~provided such modification or alternative method meets or exceeds the level of surveying, monitoring, inspection, or protection, as applicable, afforded to the public and property by this section, and also provided the insurance requirements of Sections 103 and 105 of Title 28 of the Administrative Code are satisfied] of surveying, monitoring, inspection, or protection.~~

~~[3309.15.1 Request content.~~ A request submitted under Section 3309.15 shall include:

1. ~~Details of the modification or alternative methods to be utilized;~~

- ~~2. Any stipulations;~~
- ~~3. Demonstration that the request meets or exceeds the level of surveying, monitoring, inspection, or protection, as applicable, afforded to the public and property by this section;~~
- ~~4. Where applicable, a description of the practical difficulty of complying with code requirements;~~
- ~~5. Where applicable, a reference to the site safety monitoring program; and~~
- ~~6. Where such request is made because an adjoining property owner has not afforded a license in accordance with the requirements of Section 3309.2, the request shall contain a notarized letter from the owner of the property where the project is to commence, or a duly authorized representative, certifying notification has been made to seek a license in accordance with the requirements of Section 3309.1.1.]~~

3309.16 Monitoring plan. Where monitoring is required by Section 3309, such monitoring shall be in accordance with a monitoring plan developed by a registered design professional and acceptable to the commissioner. The monitoring plan shall be specific to the structures to be monitored and operations to be undertaken, and shall specify the scope and frequency of monitoring, acceptable tolerances, and reporting criteria for when tolerances are exceeded. Monitoring plans shall also comply with the applicable requirements of Chapter 18 and Sections 3303, 3304, and 3306.

3309.17 Site specific engineered enclosure system. Site specific engineered enclosure systems authorized by this section shall meet the following requirements:

1. The engineered enclosure system shall be designed by a registered design professional. The design shall be specific to the site and shall meet all temporary load requirements, including but not limited to wind, as prescribed in Chapter 16;
2. The engineered enclosure system shall be acceptable to the commissioner;
3. The engineered enclosure system shall be positioned exterior of the building under construction or demolition and shall cover all areas along the exposure where work is occurring or openings in the building are present;
4. The lowest horizontal level of the engineered enclosure system shall be designed to meet the design loads required for a sidewalk shed in accordance with Section 3307.6.4.2, shall be positioned such that it is located at or below the lowest level of work and openings in the building along the exposure, and shall be brought tight to the face of the building under construction or demolition, except that a gap, not to exceed 1 inch (25 mm), along the face of the building is permissible, provided the resulting gap is sealed or covered by material of sufficient manner and strength capable of trapping falling objects;
5. The vertical surfaces of the engineered enclosure system shall be covered fully by material capable of stopping material or debris generated by the work. Such vertical covering shall be brought tight to the face of the engineered enclosure system. Where necessary to control

material or debris, the material shall be rigid and solid, or shall, at a minimum, be a rigid galvanized welded wire screen of not less than No. 16 steel wire gauge, with no opening larger than ½ inch (13 mm) in the vertical or horizontal dimensions and ¾ inch (19 mm) in any other dimension, backed by fine debris netting located interior of the steel wire screen;

6. The engineered enclosure system shall be installed, inspected, repaired, maintained, adjusted, used, and removed as indicated on the plans for the engineered enclosure system. Inspections shall be performed, at a minimum, following each installation or reinstallation, each day while in use, periodically while not in use, prior to forecasted inclement weather events, and subsequent to inclement weather events; and
7. A controlled access zone, acceptable to the commissioner, or protection in accordance with Sections 3309.10 or 3309.13, shall be provided to protect the adjoining property whenever the engineered enclosure system is installed or removed, and when otherwise warranted during repairs, maintenance, or adjustments. Such controlled access zone or protection shall be indicated on the plans for the engineered enclosure system.

§ 41. Section BC 3310 of the New York city building code, as amended by local law number 141 for the year 2013, section 3310.10 as amended by local law number 196 for the year 2017, and section 3310.10.1 as amended by local law number 206 for the year 2017, is amended to read as follows:

**SECTION BC 3310
REQUIREMENTS FOR THE CONSTRUCTION OR
DEMOLITION OF MAJOR BUILDINGS**

3310.1 Scope. This section shall apply to:

1. The construction of a new major building;
2. The vertical or horizontal enlargement of a major building;
3. The full or partial demolition of a major building;
4. The alteration, maintenance, or repair of a façade of a major building, provided the building is more than 14 stories or 200 feet (60 960 mm) in height, whichever is less, and also provided the façade work requires a sidewalk shed to be installed; and
5. Any construction or demolition work, including the alteration, maintenance, or repair of a façade, in a building so designated by the commissioner.

Exception: The requirements of this section shall not apply to partial demolition operations limited to the interior components of a major building, provided no mechanical demolition equipment, other than handheld devices, are used.

3310.1.1 Applicability of other laws. Nothing contained herein shall diminish or supersede any other applicable city, state, or federal regulation. Nothing in this section shall relieve persons engaged in construction or demolition work of their obligations under this chapter, including but not limited to Sections 3301.1 and 3301.2, or from complying with other applicable provisions of law.

3310.2 Major buildings. See the definition of “Major building” in [~~Section 3302~~] Chapter 2.

3310.3 Site safety plan. No permit shall be issued for the type of work listed in Section 3310.1 until a site safety plan that meets the requirements of Article 110 of Chapter 1 of Title 28 of the *Administrative Code* has been approved by the department.

3310.4 Site safety monitoring program. For a project that requires a site safety plan, the general contractor shall enact and maintain a site safety monitoring program to implement such site safety plan. The site safety monitoring program shall, at a minimum, comply with Sections 3310.5 through 3310.10.

Exception: Subject to the approval of the commissioner, a site safety monitoring program may be waived, reduced, or modified in accordance with Section 3310.11.

3310.5 Site safety manager or coordinator to be designated. One or more site safety managers shall be designated, as necessary, to [~~ensure~~] monitor compliance with the site safety plan and all site safety requirements as specified in this chapter and rules promulgated by the commissioner. Such site safety manager or managers shall be designated by the owner, agent, construction manager, or general contractor. All such entities shall agree to designate one such site safety manager as the primary site safety manager, or where there is only one site safety manager, such manager shall automatically be designated as the primary site safety manager. Such site safety manager(s) shall be certified by the department in accordance with Article 402 of Chapter 4 of Title 28 of the *Administrative Code.*

[~~Exception:~~] Exceptions:

1. One or more site safety coordinators, certified by the department in accordance with the requirements of Article 403 of Chapter 4 of Title 28 of the *Administrative Code*, may be designated in lieu of a site safety manager for the construction, vertical or horizontal enlargement, or full or partial demolition of a major building, provided such building:

~~[1.]~~ 1.1. Is less than 15 stories or 200 feet (60 960 mm) in height, whichever is less;
and

~~[2.]~~ 1.2. Has a building footprint of 100,000 square feet (30 480 m²) or less.

2. Façade or roof projects that comply with Section 3310.12.

3310.5.1 Notification to the department of the primary manager or coordinator. The department shall be notified of the primary site safety manager or coordinator prior to the commencement of work. In the event that an alternate site safety manager or coordinator will be acting [~~as~~] in place of the primary site safety manager or coordinator for a period longer than two

consecutive weeks, the department must be so notified. Any permanent change of the primary site safety manager or coordinator requires immediate notification to the department.

3310.5.2 Presence at the site. For the construction or alteration of a building, the ~~[primary]~~ site safety manager or coordinator shall be present at the site during all times while active work is occurring and through all phases of work, beginning with excavation and continuing until the building is enclosed and the sidewalk shed removed.

For the demolition of a building, the ~~[primary]~~ site safety manager or coordinator shall be present at the site during all times while active work is occurring and through all phases of work, beginning with the removal of any glass, asbestos, or façade and, for a full demolition, continuing until the site has been backfilled to grade, or for a partial demolition until the building is enclosed and the sidewalk shed removed.

Exceptions:

1. The ~~[primary]~~ site safety manager or coordinator is not required to be present at the site during the following activities, provided no other work is in progress~~[-]~~:
 - 1.1 Surveying that does not involve the disturbance of material, structure, or earth;
 - 1.2 Use of a hoist exterior to the building to transport personnel only;
 - 1.3 Use of a ~~[material]~~ hoist that is fully enclosed within the perimeter of the building to transport personnel or material;
 - 1.4 ~~[Finish trowelling of concrete floors;]~~ Work limited to finish troweling of concrete floors;
 - 1.5 ~~[When personnel are provided for temporary heat, light, or water]~~ Work limited to providing the site with temporary heat, light, or water; or
 - 1.6 ~~[Truck deliveries to the site where the sidewalk is closed and the entrance gate is within that closed sidewalk area.]~~ Truck deliveries to the site, provided the delivery occurs within the site while the gate is closed and flagpersons are provided to direct traffic while the truck is entering and exiting the site.
2. Subject to the approval of the commissioner, the requirement for a site safety manager, or where a site safety coordinator is authorized by this code, a site safety coordinator, may be waived entirely, or reduced to a part time basis with such part time basis determined by the commissioner, in accordance with Section 3310.11.

3310.5.3 ~~[Acting primary]~~ Alternate site safety manager or coordinator. Where the primary site safety manager or coordinator is unable to be at the site, an alternate site safety manager or coordinator shall act [as] in place of the primary site safety manager or coordinator and carry out all duties and responsibilities assigned to the site safety manager or coordinator by this chapter and rules promulgated by the commissioner. Such shall be recorded in the site safety log as

required by Section 3310.8.4.2, and where required by Section 3310.5.1 notification shall be provided to the department.

3310.5.4 Limitation on primary site safety manager or coordinator serving at another site.

No site safety manager or coordinator designated as the primary site safety manager or coordinator at a site shall serve as a site safety manager or coordinator at any other site.

Exceptions:

1. A site safety manager or coordinator designated as the primary site safety manager or coordinator at a site may serve as a ~~[nonprimary]~~ non-primary site safety manager or coordinator at another site, provided there is no work requiring the presence of such individual in accordance with Section 3310.5.2 occurring at the site for which the individual has been designated as the primary site safety manager or coordinator.
2. ~~[Subject to the approval of the commissioner, a]~~ A site safety manager ~~[or coordinator]~~ may be designated as the primary site safety manager ~~[or coordinator at]~~ for two or more sites, provided all sites ~~[have had their requirement for a primary site safety manager or coordinator reduced by the commissioner to a part time basis in accordance with Section 3310.14]~~ meet the criteria set forth in Section 3310.12.

3310.6 Reserved.

3310.7 Contractor shall inform personnel. ~~[General contractors and subcontractors shall state to their directly employed personnel at the construction or demolition site, prior to such directly employed person commencing work at the site, that they are to follow all safety regulations at all times and that they are required to obey and implement all orders and directives relating to safety requirements issued by the general contractor/subcontractor or the general contractor's/subcontractor's designee. Where a site safety manager or coordinator is required, the general contractor or subcontractor shall also state to their directly employed personnel at the site, prior to such directly employed person commencing work at the site, that the site safety manager or coordinator is responsible for monitoring compliance with laws and rules governing site safety; and shall inform their supervisory personnel at the site, prior to such supervisor commencing work at the site, of the name and responsibilities of the site safety manager or coordinator. Nothing in this section shall relieve persons engaged in construction or demolition work from their obligations under this chapter, including but not limited to Sections 3301.1 and 3301.2, and from complying with other applicable provisions of law.]~~ The requirements of Section 3301.14 shall apply.

3310.8 Site safety manager's and coordinator's duties. The site safety manager or coordinator shall monitor compliance with the safety requirements of this chapter and any rules promulgated thereunder by performing the duties required by Sections 3310.8.1 through ~~[3310.8.6]~~ 3310.8.5 and by performing all other safety duties assigned by the owner or general contractor to meet legal requirements.

3310.8.1 Meetings. The site safety manager or coordinator shall, at a minimum, meet on a weekly basis with the designated representative of each subcontractor to ascertain that all subcontractors are complying with the applicable provisions of this chapter.

3310.8.2 Notification of violations. In the event the site safety manager or coordinator discovers a violation of this chapter and any rules promogulated thereunder, he or she shall immediately notify the person or persons responsible for creating the violation, whether these persons are employed by the general contractor or by subcontractors. If the site safety manager or coordinator is unable to obtain the cooperation of these persons in correcting the violation, he or she shall immediately inform the direct supervisor of the person or company responsible for creating the violation and request that the supervisor order the necessary corrective action. If such supervisor is not present at the site or is otherwise unavailable, the site safety manager or coordinator shall notify any other supervisory personnel of the permit holder or any other responsible manager or officer of the permit holder. All such violations and corrective work shall be recorded in the daily log.

3310.8.2.1 Notification of conditions to the department. The site safety manager or coordinator shall immediately notify the department directly if he or she discovers any of the following conditions in the routine performance of the job:

1. A person is operating a crane, derrick, or hoisting equipment on the site without a permit and refuses to desist from operating the equipment;
2. A crane is being operated by an unlicensed operator and such unlicensed operator refuses to desist from operating the crane;
3. No flagperson is present during crane operation where required by this chapter;
4. Sidewalk sheds required by the site safety plan are not in place during construction or demolition activity;
5. Permits have not been issued for the sidewalk sheds;
6. The designer and/or supplier of sidewalk sheds has not certified that the sheds have been erected in accordance with the approved drawings;
7. Any [~~accident as defined by this chapter~~] incident has occurred;
8. Required standpipe is not in place at each story below the construction or demolition floor;
9. Required standpipe valves are not in place at each story below the construction or demolition floor;
10. Required standpipe is not capped;
11. Required standpipe is not connected to a water source or fire department connection;
12. Required standpipe fire department hose connection is obstructed;
13. Required standpipe fire department hose connections are not marked by a red light and a sign reading, "Standpipe Connection";

14. A breach exists in the required standpipe risers, cross connections, or fire department connections;
15. The standpipe alarm activates; [ø]
16. ~~[When a building over 75 feet (22.86 m) is being constructed or demolished and at least one elevator in a state of readiness or one hoist is not available for Fire Department access per Section 3303.12.]~~ Stairs are not provided in accordance with Section 3303.11; or
17. An elevator or hoist is not available in accordance with Section 3303.12.

3310.8.2.1.1 Responsibility. Upon proper notification to the department of the existence of any of the above-noted circumstances, any responsibility the site safety manager or coordinator has under this code arising out of, relating to, or as a result of the existence of that circumstance, shall cease.

~~[**3310.8.3 Inspections.** It shall be the responsibility of the site safety manager or coordinator to inspect personally, on a regular basis throughout the day while active work is occurring, the site to ensure compliance with the requirements of this chapter. At a minimum, inspections shall consist of those prescribed in rules promulgated by the commissioner, with such inspections performed personally by an individual certified by Chapter 4 of Title 28 of the *Administrative Code* as a site safety manager or coordinator.]~~

~~[**3310.8.3.1 Site safety manager or coordinator standpipe inspection responsibilities.** The site safety manager or coordinator shall, at a minimum, in accordance with rules promulgated by the department, conduct daily checks to ensure that a standpipe system is available and in a state of readiness at all times for use by firefighting personnel, by verifying:~~

- ~~1. That valves are in place at each story below the construction floor;~~
- ~~2. That standpipes are connected to a water source or fire department connection; and~~
- ~~3. That fire department hose connections are free from obstruction and are marked by a red light and sign that reads, "Standpipe Connection."]~~

~~[**3310.8.3.1.1 Weekly checks.** The site safety manager or coordinator shall also, in accordance with such rules, conduct weekly checks to verify that no breach exists by visually tracing the standpipe, including risers, cross connections and fire department connections.]~~

~~[**3310.8.3.1.2 Record of inspections.** A record of all such inspections shall be maintained by such site safety manager or coordinator in the site safety log.]~~

3310.8.3 Inspections. Site safety inspections shall be performed and documented as required by Sections 3310.8.3.1 through 3310.8.3.4.

3310.8.3.1 Spot checks. The safety manager or coordinator shall personally perform spot checks of the site on a regular basis throughout the day for compliance with the site safety plan, the requirements of this chapter, and any rules promulgated thereunder.

3310.8.3.2 Enumerated inspections. The following inspections shall be performed by the site safety manager or coordinator, or by one or more individuals designated by the site safety manager or coordinator and certified as a site safety manager or coordinator in accordance with Chapter 4 of Title 28 of the *Administrative Code*:

1. Daily, weekly, and other checks as specified in rules promulgated by the commissioner.
2. Daily checks to ensure that a standpipe system is available and in a state of readiness at all times for use by firefighting personnel by verifying:
 - 2.1. That valves are in place at each story below the construction floor;
 - 2.2. That standpipes are connected to a water source or fire department connection; and
 - 2.3. That fire department hose connections are free from obstruction and are marked by a red light and sign that reads, "Standpipe Connection."
3. Weekly checks to verify that no breach exists in the standpipe system by visually tracing the standpipe, including risers, cross connections and fire department connections.

3310.8.3.3 Delegation. Nothing in this code shall be read to prohibit the site safety manager from delegating enumerated inspections to an individual certified as a site safety coordinator at a site where a primary site safety manager is required; however, the site safety manager or coordinator may not delegate their general responsibility to perform spot checks of the site throughout the day. Delegation does not relieve the site safety manager or coordinator from the responsibility to ensure such inspections are adequately performed.

3310.8.3.4 Record of inspections. A record of all such inspections shall be maintained by such site safety manager or coordinator in the site safety log in accordance with Section 3310.8.4.

3310.8.4 Site safety log. A site safety log shall be maintained and kept at the site. The log, or where there is more than one log, the logs in total, shall, at a minimum, contain the following information:

1. Date and location of inspections performed in accordance with Section 3310.8.3;
2. Date and names of individuals met with to satisfy the requirements of Section 3310.8.1;
3. Any unsafe acts and/or conditions, and dates and locations of said unsafe acts and/or conditions;

4. Companies and representatives notified of unsafe acts and/or conditions;
5. Dates of notification of unsafe acts and/or conditions;
6. Dates of correction of unsafe acts and/or conditions and nature of correction;
7. Any [~~accident as defined by this chapter~~] incident;
8. Any violations, stop work orders, or summonses issued by the department, including date issued and date lifted or dismissed;
9. Dates and location where horizontal and vertical safety netting have been installed, replaced and/or repaired;
10. Date horizontal safety netting is removed; [~~and~~]
11. Date when building reaches a height of 75 feet (22 860 mm)[~~-~~]; and
12. Date when the building is topped off.

3310.8.4.1 Recording inspections in the site safety log. Inspections shall be recorded by the end of the day by the site safety manager or coordinator who performed the inspection. The site safety log, or where there is more than one log, each individual log, shall be completed and signed by the site safety manager or coordinator, and if the inspection is performed by another individual, by the site safety manager or coordinator who performed the inspection [~~and by the site safety manager or coordinator designated as the primary site safety manager or coordinator in accordance with Section 3310.5.1~~].

Exception: Where a part time site safety manager or coordinator is approved by the commissioner in accordance with Section 3310.11, the site safety manager or coordinator shall sign the log when he or she arrives at the site and leaves the site, and all entries in the site safety log shall be completed and signed prior to leaving the site.

3310.8.4.2 Recording change in site safety manager or coordinator. If at any point during the day an alternate site safety manager or coordinator acts as the primary site safety manager, this shall be noted in the log, and the [~~acting primary~~] alternate site safety manager shall log in. If a site safety manager or coordinator is relieved of his or her responsibilities at the site, or a site safety manager or coordinator leaves the site for any reason, this shall be indicated in the site safety log, and another site safety manager or coordinator shall assume the duties of such relieved or absent site safety manager or coordinator by signing in.

3310.8.5 Permit log. Any equipment brought onto the job that requires permits, as well as a description of the equipment, where it is to be located, permit number, issue and expiration date of the permit, and certificate of inspection, if required, shall be entered on a separate permit log that shall be maintained at the site by the site safety manager or coordinator and kept at the site.

3310.8.6 [~~Reasonable prudence. In addition to the above requirements, the site safety manager or coordinator shall use reasonable prudence to ensure that safety is maintained at the site as job conditions dictate.~~] **Reserved.**

3310.9 Additional site safety personnel. The following additional personnel shall be employed to oversee concrete operations at a major building and such other classes of buildings or operations as the commissioner may designate by rule. These personnel shall coordinate directly with the [primary] site safety manager or coordinator [~~designated in accordance with Section 3310.5.1~~]. In all instances, the [~~designated primary~~] site safety manager or coordinator retains responsibility for ensuring compliance with the provisions of Section 3310 of this code and all applicable rules, and for signing the site safety log. The name and contact information of the additional site safety personnel shall be recorded in the site safety log.

3310.9.1 Concrete safety manager. A concrete safety manager shall be designated by the concrete contractor at those sites where the concrete portion of the project involves the pouring of a minimum of 2,000 cubic yards of concrete or such lesser amount as the commissioner may determine by rule. Concrete safety managers shall have five years of experience in concrete operations and shall have satisfactorily completed, within the five calendar years prior to registration, a thirty hour course approved by the commissioner that is sufficient to qualify the individual as a competent person under OSHA standards to oversee concrete operations, including such topics as formwork design, construction and stripping operations, rebar handling, and rigging. Concrete safety managers shall register with the department in the same manner as construction superintendents, and shall provide evidence of meeting the eligibility requirements set forth herein. No person shall perform the duties of a concrete safety manager without being registered as such with the department. The commissioner shall promulgate rules establishing the duration that such registration shall be valid and the requirements for renewal of the registration. The concrete safety manager shall be present during all concrete operations. For purposes of this section, “concrete operations” shall mean the pouring of concrete and the construction and stripping of concrete forms and related activities as specified by the commissioner.

3310.10 Orientation and training. All workers employed at a major building site shall receive orientation and training as required by this section and [~~section~~] Section 3321.

3310.10.1 Orientation. The requirements of Section 3301.11 shall apply.

3310.11 Modifications to the site safety monitoring program. The commissioner may, based upon a written request from a registered design professional, waive, reduce, or modify the requirements for the site safety monitoring program for a job of a limited scope or duration[~~, provided such waiver, reduction, or modification is not detrimental to the safety of the public and property, or that alternative means of protection for the public and property meeting or exceeding those afforded by this section are provided. A submission under this section may include, but not be limited to, a request to reduce or modify the type or frequency of inspections performed by the site safety manager or coordinator, or to allow a part time site safety manager or coordinator, or to waive the requirement for a site safety manager or coordinator.~~] in accordance with Section 28-103.3 of the Administrative Code.

[~~**3310.11.1 Request content.** A request submitted under Section 3310.11 shall include:~~]

[~~1. Details of the modification or alternative methods to be utilized;~~]

[~~2. Any stipulations;~~]

- ~~[3. A description of the work to be undertaken, for example:]~~
- ~~[3.1. Type of work;]~~
 - ~~[3.2. Anticipated sequence and schedule;]~~
 - ~~[3.3. The anticipated number of suspended scaffold drops;]~~
 - ~~[3.4. Material handling and hoisting activities to be undertaken and equipment to be utilized;]~~
 - ~~[3.5. The extent of demolition activities and equipment to be utilized;]~~
 - ~~[3.6. Impact on the standpipe or sprinklers;]~~
 - ~~[3.7. Use of welding, torches, or similar equipment;]~~
 - ~~[3.8. Proximity to adjoining buildings or areas accessible to the public.]~~
- ~~[4. Demonstration that the request is not detrimental to the safety of the public and property, or that alternative means of protection for the public and property meet or exceed those afforded by this section are provided;]~~
- ~~[5. A description of the practical difficulty of complying with the site safety monitoring program requirements set forth in Section 3310;]~~
- ~~[6. Where the request is to reduce or modify the type or frequency of inspections performed by the site safety manager or coordinator, a proposed alternative list of site safety inspections;]~~
- ~~[7. Where the request is to allow a part time site safety manager or coordinator, a proposed schedule for the site safety manager or coordinator, as well as a proposed list of duties and site safety inspections to be performed by the site safety manager or coordinator while he or she is present at the site; and]~~
- ~~[8. Where the request involves a waiver of the site safety monitoring program or a request to allow a part time site safety manager or coordinator, a signed, dated, and notarized affidavit from a contractor or licensee stating he or she will be responsible for ensuring compliance with the site safety provisions of this code at the site at all times the site safety manager or coordinator is not present, with emergency contact information for such contractor or licensee provided.]~~

3310.12 Façade projects. Where authorized in accordance with rules promulgated by the commissioner for a project whose scope is limited to the alteration, maintenance, or repair of a façade or roof, the inspection, documentation, reporting, and other activities required by Sections 3310.5 through 3310.9 may instead be assigned to a qualified person. The qualified person shall also perform all other duties assigned by rules promulgated by the commissioner. The qualified person shall work under the direct and continuing supervision of a site safety manager, or a licensed master or special

rigger, and shall meet all training and experience prerequisites established by rules promulgated by the commissioner.

§ 42. Section BC 3311 of the New York city building code, as amended by local law number 141 for the year 2013, is amended to read as follows:

**SECTION BC 3311
EXPLOSIVE POWERED AND PROJECTILE TOOLS**

3311.1 Scope. Explosive powered tools, including but not limited to powder-actuated tools and projectile tools, used in connection with the construction or demolition of a building or structure shall be in accordance with the requirements of this section.

3311.2 Projectile tools. Projectile tools shall comply with the requirements of Sections 3311.2.1 through 3311.2.3.

3311.2.1 Basic requirements. Design and construction of the tool must be such as to safely retain all internal pressures that may occur during its operation. The discharge mechanism shall be such that the projectile cannot be discharged by dropping the tool. The discharge mechanism shall be such that the discharge of each projectile shall be dependent on a separate and distinct act by the operator, and all safety features shall be durable.

A tool shall have such other characteristics as the commissioner may find necessary. Such other characteristics may include devices and materials external to the tool itself but associated with its function, and may also include, in respect to high velocity projectile tools, the basic requirements set forth above for explosive powered tools that discharge projectiles with comparable velocities.

3311.2.2 Maintenance. Every projectile tool shall be properly maintained. No such tool shall be used if any part necessary to retain internal pressures or to prevent accidental discharge of a projectile is not in sound and operable condition.

3311.2.3 Operation. The operation of projectile tools shall comply with the following:

1. A projectile tool shall be operated only by an authorized operator who shall be the owner, lessee, or other person having custody of the tool, or any other person whom he or she may authorize to operate it.
2. While a projectile tool is in the care and custody of an authorized operator, no other person shall handle or in any way utilize or modify it.
3. No authorized operator of a projectile tool shall leave it unattended while it is in a condition to discharge a projectile.
4. No person shall use a projectile tool for any purpose other than that for which it was manufactured.
5. No person shall point a projectile tool at another person or hold it at an angle that allows the projectile to fly free.

6. No person shall use a projectile tool in such a way as to endanger persons who may be in the vicinity.

3311.3 Explosive powered tools. The provisions of ANSI A10.3, as modified in Section 3311.4, shall apply to explosive powered tools, including but not limited to powder-actuated tools. The storage, handling and use of explosives shall also comply with the *New York City Fire Code* and Section 3307.4.2.

3311.4 Modifications to ANSI A10.3. The text of ANSI A10.3 shall be modified as indicated in Sections 3311.4.1 through 3311.4.12.

3311.4.1 ANSI A10.3, Section 4.2.2. Delete Sections 4.2.2.2, 4.2.2.3 and 4.2.2.4 in their entirety and modify Section 4.2.2.1 to read as follows:

4.2.2.1 Medium-velocity tools, indirect-acting (piston) type, as defined in Section 3, shall not be used.

3311.4.2 ANSI A10.3, Section 4.2.3. Delete Sections 4.2.3.2, 4.2.3.3 and 4.2.3.4 in their entirety and modify Section 4.2.3.1 to read as follows:

4.2.3.1 High velocity tools, direct-acting or indirect-acting type, as defined in Section 3, shall not be used.

3311.4.3 ANSI A10.3, Section 4.3. Delete Section 4.3 in its entirety.

3311.4.4 ANSI A10.3, Section 5.5. Add a new section 5.5 to read as follows:

5.5 Selection of load. No employer shall knowingly furnish to an employee for use in a tool any cartridge or load not suitable for safe use in that tool, whether by reason of excessive power, improper design or poor material. The operator shall use due care to select the proper cartridges or power loads, or other means of controlling the force of the explosion so that the tool develops no more than the necessary pressure to bring about the desired penetration. In doing so, the operator shall be guided by the manufacturer's specifications.

5.5.1 Proper load. When doubt exists as to proper load, the operator shall make a trial shot to test the surface and the strength of the material to be penetrated. The trial shot shall be made with the lowest power level and then increasing strength until a proper fastening is made. During this test, the operator and all bystanders shall adhere to all safety rules including but not limited to, wearing goggles and hard hats required for the job.

3311.4.5 ANSI A10.3, Section 7.9. Add the following sentence at the beginning of Section 7.9:

7.9 The operator shall always verify the thickness and type of material into which the stud, pin or fastener is to be driven.

3311.4.6 ANSI A10.3, Section 9.4. Add a new section 9.4 to read as follows:

9.4 Storage of power loads shall be in accordance with the requirements of the *New York City Fire Code* and regulations of the Fire Department.

3311.4.7 ANSI A10.3, Section 10.3.1. Add a new Section 10.3.1 to read as follows:

10.3.1 The authorized instructors' card shall list the specific models of powder-actuated tools for which training may be given.

3311.4.8 ANSI A10.3, Section 10.6. Add a new section 10.6 to read as follows:

10.6 All authorized instructors shall hold a Certificate of Fitness issued by the Fire Department.

3311.4.9 ANSI A10.3, Section 11.4.1. Add a new section 11.4.1 to read as follows:

11.4.1 The qualified operator's card shall list the specific models of powder-actuated tools that may be used.

3311.4.10 ANSI A10.3, Section 11.6. Add a new Section 11.6 to read as follows:

11.6 All qualified operators shall hold a Certificate of Fitness issued by the Fire Department.

3311.4.11 ANSI A10.3, Section 12. Delete Section 12 in its entirety and add a new Section 12 to read as follows:

12 Equipment acceptance.

12.1 Powder-actuated tools using ammunition (power loads) shall be approved by the commissioner or other approved agency.

12.2 Labeling. A certificate or label indicating that the tool is approved shall be attached to the toolbox or operator's manual and shall be made available for inspection upon request of the commissioner.

3311.4.12 ANSI A10.3, Section 13. Add a new Section 13 to read as follows:

13 Fire Department requirements.

13.1 The requirements of the *New York City Fire Code* and regulations of the Fire Department shall apply.

§ 43. Section BC 3313 of the New York city building code, as amended by local

law number 33 for the year 2007, is amended to read as follows:

**SECTION BC 3313
FLAMMABLE AND COMBUSTIBLE MIXTURES,
COMPRESSED GASES, AND OTHER HAZARDOUS
MATERIALS**

3313.1 General. The transportation, handling, storage, installation, connection, ventilation, and use of all volatile flammable oils, flammable and combustible mixtures, compressed gases, and other

hazardous materials shall comply with the *New York City Fire Code*, and shall also be safeguarded in accordance with the requirements of Section 3307.4.2.

§ 44. Section BC 3314 of the New York city building code, as added by local law number 141 for the year 2013, section 3314.20 as amended by chapter 18 of the laws of 2016, is amended to read as follows:

SECTION BC 3314 SCAFFOLDS

3314.1 Scope. Scaffolds utilized in conjunction with the construction or demolition of a building or structure shall be erected and maintained in accordance with the requirements of this section so that the safety of public and property will not be endangered by falling material, debris, or equipment, or by collapse of the scaffold.

Exceptions:

1. The requirements of this section shall not apply to window washing equipment permanently anchored to the building and subject to the jurisdiction of the New York State Department of Labor. However, this exemption shall not apply when such equipment is used for activities other than window washing.
2. Mast climbers are only required to comply with the requirements of Section 3314.19.

3314.1.1 Height. For the purposes of this section, the height of a scaffold shall be measured from the base of the scaffold to the top of the uppermost vertical member of the scaffold, with any temporary structure, but not any permanent structure, on which the scaffold rests included in the height measurement.

3314.2 Permit. Prior to the installation and use of a scaffold, the contractor or licensee who is to install the scaffold, or a designated representative of the installer, shall obtain a permit for such scaffold. The permit requirements of this section are independent of the design requirements of Section 3314.3. Sections 3314.3.1 through 3314.3.4 may require a scaffold to be designed even if Section 3314.2 does not require a permit for such scaffold.

Exceptions:

1. A permit is not required for a two-point, single tier, suspended scaffold suspended from a parapet using C-hooks.
2. A permit is not required for a suspended scaffold provided Items 2.1 through 2.3 are complied with:
 - 2.1. The scaffold is installed and used in conjunction with a construction, alteration, or demolition project that holds a valid permit from the department for such project;
 - 2.2. The site is closed to the public and enclosed with a fence in accordance with Section [3307] 3307.7; and

- 2.3. The installation, use, and removal of the scaffold is confined within the site or over an area protected by sidewalk sheds or roof protection.
3. ~~[Window washing equipment that is permanently anchored to the building or structure by a davit.]~~ A permit is not required for a single tier nonadjustable suspended scaffold whose platform is 40 square feet (3720 mm²) or less in size.
4. A permit is not required for a supported scaffold, provided Items 4.1 through 4.6 are complied with:
 - ~~[4.1]~~ 4.1 The scaffold is not an outrigger scaffold (thrust out);
 - ~~[4.2]~~ 4.2 No hoisting equipment with a manufacturer's rated capacity greater than 2,000 pounds (907 kg) will be located on the scaffold;
 - ~~[4.3]~~ 4.3 The scaffold will not be loaded, or designed to be loaded, in excess of 75 pounds per square foot (366.15 kg/m²) (e.g. a light duty scaffold, a medium duty scaffold, or a heavy duty scaffold); ~~[and]~~
 - ~~[4.4]~~ 4.4 The scaffold is less than 40 feet (12 192mm) in height[-];
 - 4.5 Side-arm or end-arm scaffold brackets are used exclusively for the support of workers; and
 - 4.6 Where the scaffold has a height-to-base ratio (including outriggers supports, if used) of more than four to one (4:1), it is restrained in accordance with Section 3314.9.1.

3314.3 Design. Scaffolds shall be designed~~[, as follows.]~~ in accordance with Sections 3314.3.1 through 3314.3.4. The design requirements of this section are independent of the permit requirements of Section 3314.2. Sections 3314.3.1 through 3314.3.4 may require a scaffold to be designed even if Section 3314.2 does not require a permit for such scaffold.

3314.3.1 Supported scaffolds and outrigger scaffolds (thrust out). Supported scaffolds and outrigger scaffolds (thrust out) shall be designed by a registered design professional. Where the scaffold is to be located upon a sidewalk shed, the requirements of Section 3307.6.4.2.2 shall also apply.

Exception: Design is not required for a supported scaffold, provided Items 1 through 6 are complied with:

1. The scaffold is not an outrigger scaffold (thrust out);
2. No hoisting equipment with a manufacturer's rated capacity greater than 2,000 pounds (907kg) will be located on the scaffold;
3. The scaffold will not be loaded, or designed to be loaded, in excess of 75 pounds per square foot (366.15 kg/m²) (e.g. a light duty scaffold, a medium duty scaffold, or a heavy duty scaffold);

4. The scaffold is less than 40 feet (12 192mm) in height;
5. Side-arm or end-arm scaffold brackets are used exclusively for the support of workers; and

~~[6. The scaffold is a light duty scaffold, a medium duty scaffold, or a heavy duty scaffold.]~~

6. Where the scaffold has a height-to-base ratio (including outriggers supports, if used) of more than four to one (4:1), it is restrained in accordance with Section 3314.9.1.

3314.3.2 Suspended scaffolds. Suspended scaffolds shall be designed by a registered design professional.

Exceptions:

1. Design is not required for a single tier nonadjustable suspended scaffold whose platform is 40 square feet [~~(12 192 mm²)~~] (3720 mm²) or less in size.
2. In lieu of a registered design professional, a two-point, single tier, suspended scaffold may be designed by a licensed rigger provided Items 2.1 and 2.2 are complied with and either Items 2.2.1 or 2.2.2 are complied with:
 - 2.1. The scaffold or scaffold outrigger beam or suspension member support structure is not anchored to the building or structure, other than tiebacks; and
 - 2.2. The scaffold will not be loaded, or designed to be loaded, in excess of 75 pounds per square foot (366.15 kg/m²); and either
 - 2.2.1. The scaffold utilizes c-hooks; or
 - 2.2.2. The distance from floor or roof on which the support structure is located to the top of the outrigger beam or suspension member support structure is less than 15 feet (4572 mm).
3. In lieu of a registered design professional or a licensed rigger, a two-point, single tier, suspended scaffold meeting the requirements of Item 2 of these exceptions that is used exclusively for sign hanging work may be designed by a licensed sign hanger.

3314.3.3 Drawings. Where design is required by this section, the drawings shall be specific to the site and shall, at a minimum, include a plan view and an elevation view, with full dimensions, detailing:

1. The scaffold and location of the scaffold;
2. The base structure (e.g. roof and parapet, sidewalk shed);
- ~~[2.]~~ 3. Connections and attachments to the base structure, including but not limited to anchorages, fastenings, tie-ins, tie-backs, and lifelines;

- [3-] 4. Any temporary or permanent structural modifications required to the base structure;
- [4-] 5. Netting with specific type and manufacturer indicated, overhead protection, or any other equipment attached to the scaffold. The effect of wind on the netting shall be accounted for in the design of the scaffold;
- [5-] 6. Any hoisting equipment located on the scaffold;
- [6-] 7. Platform levels, support centers, and offsets, along with the maximum number of levels to be loaded simultaneously and the maximum loads to be imposed;
8. Temporary construction, such as platforms, runback structures, other scaffolds, mast climbers, cranes, derricks, hoists, horizontal netting, cocoon systems, climbing formwork, sidewalk sheds, fences, and barricades that may present interference for the scaffold;
- [7-] 9. For a suspended scaffold, ropes, number of clips, and counterweights, ~~[as well as]~~ outrigger beams, c-hooks, or other support devices, blocking, saddles, or equivalent, and the rated load of the scaffold motor (hoist) as established by the manufacturer;
- [8-] 10. ~~For a suspended scaffold [that], the location of the scaffold during out of service periods, and if the scaffold will not be lowered to the street, [or deck of the] sidewalk shed, building setback, equivalent adequate structure, or ground [at the end of the shift] during out of service periods,~~ how the scaffold will be secured while work is not being performed; ~~[and]~~
- [9-] 11. ~~For a supported scaffold, structural members, as well as the founding of the scaffold, including but not limited to sidewalk sheds, floors, roofs, or ground[-];~~
12. References to related job numbers (e.g. the sidewalk shed upon which the scaffold rests, the underlying permit for façade or construction work); and
13. Where anchors are utilized:
- 13.1. Type of anchor and manufacturer of anchor;
- 13.2. Procedures for the installation, maintenance, and use of the anchor as specified by the manufacturer of the anchor; and
- 13.3. Procedures for the testing and inspection of the anchor as specified by the manufacturer of the anchor, as well as special inspection requirements when special inspection is required by Chapter 17.

3314.3.4 Loads imposed. ~~[Where a supported scaffold sits on a sidewalk shed or other temporary structure, the scaffold drawings shall be accompanied by a loads imposed letter signed, sealed, and dated by a registered design professional. The letter shall detail the loads to be imposed by the scaffold onto the base structure and indicate that the registered design professional has reviewed the adequacy of the base structure to sustain the load imposed.]~~ Where a supported scaffold requiring design in accordance with Section 3314.3.1 imparts a load on a temporary or

permanent structure, including but not limited to a sidewalk shed, roof, setback, or vault, the design drawings required by Section 3314.3.3 shall either be:

1. Sealed and stamped “reviewed for loads imposed” by the registered design professional responsible for the underlying structure and contain a note signed and sealed by such registered design professional indicating that either no structural modifications are required to the underlying structure, or indicating that structural modifications to the underlying structure have been incorporated into the drawings for the underlying structure;
2. Accompanied by a signed and sealed letter from the registered design professional responsible for the underlying structure indicating that he or she has reviewed the scaffold drawings for loads imposed on the underlying structure, with the drawing numbers and drawing dates referenced, and a statement indicating that either no structural modifications are required to the underlying structure, or indicating that structural modifications to the underlying structure have been incorporated into the drawings for the underlying structure;
or
3. For a project where there is no registered design professional responsible for the underlying structure, a signed and sealed letter from the registered design professional who developed the design drawings required by Section 3314.3.3 indicating that he or she has investigated the underlying structure, and a statement indicating that either no structural modifications are required to the underlying structure, or indicating that structural modifications to the underlying structure have been incorporated into the plans required by Section 3314.3.3.

3314.4 Installation, inspection, repair, maintenance, adjustment, use, and removal of scaffolds.

Scaffolds shall be installed, inspected, repaired, maintained, adjusted, used, and removed in accordance with the specifications of the manufacturer, where such specifications exist, and the requirements of Sections 3314.4.1 through 3314.4.8.

3314.4.1 Installation and removal. Scaffolds shall be installed and removed in accordance with the requirements of Sections 3314.4.1.1 through 3314.4.1.5. Where modifications to the base structure are required to support the scaffold, the scaffold shall not be installed until such modifications have been completed.

3314.4.1.1 Supervision of suspended scaffold installation and removal. Suspended scaffolds shall be installed and removed by or under the direct and continuing supervision of a licensed rigger.

Exceptions: In lieu of direct and continuing supervision by a licensed rigger:

1. The installation and removal of a suspended scaffold utilized exclusively for sign hanging work may be performed by or under the direct and continuing supervision of a licensed sign hanger.
2. The installation and removal of a suspended scaffold may be supervised by a competent person designated by the scaffold permit holder, or where there is no

scaffold permit holder, designated by the scaffold controlling entity, provided such scaffold is installed and removed in conjunction with:

- 2.1. The construction of a new building;
 - 2.2. The full demolition of an existing building;
 - 2.3. The vertical or horizontal enlargement of an existing building; or
 - 2.4. The alteration, maintenance, or repair of a façade of a major building where a site safety plan is required by Section 3310.3.
3. The lateral relocation of a wheel or track mounted scaffold and tiebacks may be supervised by a competent person designated by the scaffold controlling entity, provided the design developed by the registered design professional allows for such relocation, and also provided such lateral relocation occurs without the addition or removal of any part, component, attachment, counterweight, anchorage, or connection to the base building or structure, other than tie-backs so long as such tie-backs are placed as designated on the approved plan.

3314.4.1.2 Supervision of supported scaffold installation and removal. The installation and removal of a supported scaffold shall be supervised by a competent person designated by the contractor installing or removing the scaffold.

3314.4.1.3 Supervisor to be present at the site. The licensee or competent person supervising the installation or removal of a scaffold shall be present at the site during all installation and removal work and shall have the ability to communicate with all individuals involved in the installation or removal work. Where only one person is installing or removing a scaffold, such person shall be deemed to be the supervisor present at the site and must have the qualifications and training required by this chapter to serve as a supervisor for such work.

Exception: The licensed rigger or sign hanger does not have to be present at the site, provided a suspended scaffold foreman is present at the site during all installation and removal work and provided such suspended scaffold foreman has the ability to communicate with all individuals involved in the installation or removal work.

3314.4.1.4 Training. All individuals involved in the installation or removal of a supported scaffold or an adjustable suspended scaffold, including the person supervising such work, shall have been trained as required by Section 3314.4.5.

3314.4.1.5 Notification of adjustable suspended scaffold installation and removal. Prior to the initial installation of the adjustable suspended scaffold at a site, and prior to the final removal of the adjustable suspended scaffold at a site, the department shall be notified at least 24 hours, but not more than 48 hours, prior to such installation or removal. Should the notification date fall on a weekend or official holiday, the notification shall be made on the last business day before the commencement date of the installation or removal. Such notification:

1. Where the installation or removal occurs under the direct and continuing supervision of a licensed rigger or sign hanger, shall be made by such licensee; or
2. Where the installation or removal does not occur under the direct and continuing supervision of a licensed rigger or sign hanger, shall be made by the designer of the scaffold.

3314.4.2 Use of scaffolds. Scaffolds shall be used in accordance with the requirements of Sections 3314.4.2.1 through 3314.4.2.5.

3314.4.2.1 Supervision of suspended scaffold use. Suspended scaffolds shall be used by or under the direct and continuing supervision of a licensed rigger.

Exceptions:

1. In lieu of direct and continuing supervision by a licensed rigger, the use of a suspended scaffold utilized exclusively for sign hanging work may be performed by or under the direct and continuing supervision of a licensed sign hanger.
2. In lieu of direct and continuing supervision by a licensed rigger, the use of a suspended scaffold may be supervised by a competent person designated by the scaffold controlling entity, provided such scaffold is used in conjunction with:
 - 2.1. The construction of a new building;
 - 2.2. The full demolition of an existing building;
 - 2.3. The vertical or horizontal enlargement of an existing building; or
 - 2.4. The alteration, maintenance, or repair of a façade of a major building where a site safety plan is required by Section 3310.3.
3. Where a scaffold is used by or under the direct and continuing supervision of a licensed rigger, a registered design professional who is not in the direct employ of the licensee or business of the licensee may ride on a suspended scaffold to perform inspections provided the registered design professional:
 - 3.1. Does not perform construction, maintenance, repair, or demolition work from the scaffold;
 - 3.2. Does not operate the scaffold; and
 - 3.3. Is familiar with the use of the scaffold, safety equipment, and emergency procedures.
4. Where a scaffold is used by or under the direct and continuing supervision of a licensed rigger, a specialty crew who is not in the direct employ of the licensee or business of the licensee may use the suspended scaffold, provided:

- 4.1. The work requires a specialty trade, including but not limited to work with hazardous materials or chemicals;
- 4.2. The crew is in accordance with rules promulgated by the commissioner; and
- 4.3. The members of the crew are approved by the commissioner.

3314.4.2.2 Supervision of supported scaffold use. The use of a supported scaffold shall be supervised by a competent person designated by the scaffold controlling entity.

3314.4.2.3 Installer who is not the scaffold controlling entity. Where the contractor or licensee that installed the scaffold is not the scaffold controlling entity, the installer shall have no supervisory responsibility for the use of the scaffold.

3314.4.2.4 Supervisor to be present at the site. The licensee or competent person supervising the use of a scaffold shall be present at the site during all times the scaffold is in use and shall have the ability to communicate with all individuals using the scaffold; however, such supervisor does not need to be on the scaffold.

Exception: The licensed rigger or sign hanger does not have to be present at the site, provided a suspended scaffold foreman is present at the site during all times the scaffold is in use and provided such suspended scaffold foreman has the ability to communicate with all individuals using the scaffold. Such suspended scaffold foreman does not need to be on the scaffold.

3314.4.2.5 [Users] Training. All individuals using a supported scaffold or an adjustable suspended scaffold, including the person supervising such use, shall have been trained as required by Section 3314.4.5.

3314.4.3 Inspections. Scaffolds shall be inspected in accordance with the requirements of Sections 3314.4.3.1 through 3314.4.3.6.

3314.4.3.1 Inspection prior to the installation of a suspended scaffold. Prior to the installation of a suspended scaffold, all suspended scaffold support devices, including but not limited to outrigger beams and C-hooks, along with the support surface/structure upon which they rest (e.g. roof, parapet), shall be inspected by a qualified person. The qualified person shall:

1. Where the installation or removal occurs under the direct and continuing supervision of a licensed rigger or sign hanger, be designated by such licensee; or
2. Where the installation or removal does not occur under the direct and continuing supervision of a licensed rigger or sign hanger, be designated by the designer of the scaffold.

Exception: An inspection is not required for a [~~non-adjustable~~] nonadjustable suspended scaffold that, pursuant to Section 3314.3.2, is not required to be designed.

3314.4.3.1.1 Special provision for parapet clamps. Where parapet clamps are to be utilized, the qualified person who inspects the support surface/structure as required by Section 3314.4.3.1 shall be a registered design professional. The registered design professional shall confirm, based on the inspection and evaluation of the support surface/structure, that the support surface/structure is capable of supporting the loads to be imposed, including any eccentric load introduced by the parapet clamp.

3314.4.3.1.2 Documentation of parapet clamp inspection and evaluation. Documentation of the inspection and evaluation required by Section 3314.4.3.1.1 shall be included with the installation inspection report required by Section 3314.4.3.2.1. Such documentation shall be signed, sealed, and dated by the registered design professional that performed the inspection and evaluation.

3314.4.3.2 Installation inspection for suspended scaffolds. Upon completion of the installation of a suspended scaffold, the scaffold, all components of and attachments to the scaffold, and all supports and anchorages of the scaffold shall be inspected prior to use to verify that they are in a safe condition and, where design is required, installed in accordance with the design drawings. The individual performing the inspection shall have completed the training required by Section 3314.4.5.3 and shall be:

1. Where the scaffold was designed by a licensed rigger or sign hanger, or installed by or under the direct and continuing supervision of a licensed rigger or sign hanger:
 - 1.1. The licensee; or
 - 1.2. A suspended scaffold foreman; or
2. Where the scaffold was not designed by a licensed rigger or sign hanger, or installed by or under the direct and continuing supervision of a licensed rigger or sign hanger:
 - 2.1. The scaffold designer;
 - 2.2. An employee of the scaffold designer under his or her direct supervision;
 - 2.3. A registered design professional retained by the scaffold designer; or
 - 2.4. An employee of such retained registered design professional under the direct supervision of such retained registered design professional.

Exceptions: An installation inspection is not required for:

1. A nonadjustable suspended scaffold that, pursuant to Section 3314.3.2, is not required to be designed; or
2. The lateral relocation of a wheel or track mounted scaffold and tiebacks, provided the design developed by the registered design professional allows for such relocation, and also provided such lateral relocation occurs without the addition or removal of any part, component, attachment, counterweight, anchorage, or connection to the base building or structure, other than tie-backs. Following such

lateral relocation, the scaffold, and any re-installed tie-back, shall be inspected and documented under the requirements of Section 3314.4.3.4.

3314.4.3.2.1 Installation inspection report. The results of the inspection shall be documented in an installation inspection report signed and dated by the person who performed the inspection. The scaffold shall not be used until it has passed such inspection and the installation inspection report has been completed.

Exception: An installation inspection report is not required for a nonadjustable suspended scaffold that, pursuant to Section 3314.3.2, is not required to be designed.

3314.4.3.3 Installation inspection for supported scaffolds. Upon completion of the installation of a supported scaffold, the scaffold, all components of and attachments to the scaffold, and all supports and anchorages of the scaffold, shall be inspected prior to use to verify that they are in a safe condition and, where design is required, installed in accordance with the design drawings. Such inspection shall be performed by a qualified person who has completed the training required by Section 3314.4.5.1 and who is designated by the designer, the installer, or a third party acceptable to both the designer and the installer. The results of the inspection shall be documented in an installation inspection report signed and dated by the person who performed the inspection. The scaffold shall not be used until it has passed such inspection and the installation inspection report has been completed.

Exceptions:

1. Where additional components or attachments are installed to an existing supported scaffold, or where existing deck planking or guardrails are relocated to a different level or location, the installation inspection and installation inspection report shall be limited to such components or attachments and related anchorages.
2. An inspection and report is not required for a supported scaffold that, pursuant to Section 3314.3.1, is not required to be designed.

3314.4.3.4 Pre-shift inspection for a suspended scaffold. Suspended scaffolds shall be inspected prior to each shift, and after any occurrence which could affect a scaffold's structural integrity, in accordance with a pre-shift inspection checklist that meets the requirements of Section 3314.4.3.4.2. The scaffold shall not be used until it has passed such inspection and the results have been documented on the checklist. The checklist shall be kept at the site by the scaffold controlling entity.

Exception: A pre-shift inspection is not required for a nonadjustable suspended scaffold that, pursuant to Section 3314.3.2, is not required to be designed.

3314.4.3.4.1 Responsibility for performing the inspection and signing the checklist. The inspection required by Section 3314.4.3.4 shall be performed by, and the checklist required by Section 3314.4.3.4.2 shall be signed and dated by, the licensee, suspended scaffold foreman, or competent person who is onsite and responsible for supervising the scaffold under the provisions of Section 3314.4.2.4. Such individual shall have completed the training required by Section 3314.4.5.3.

3314.4.3.4.2 Pre-shift inspection checklist contents. The pre-shift inspection checklist shall be based on the manufacturer requirements for the inspection of the scaffold, where such requirements exist, and shall, at a minimum, include an inspection prior to each shift to verify the scaffold [remains], all components of and attachments to the scaffold, and all supports and anchorages of the scaffold, remain in a safe condition for use, and shall also include a comprehensive inspection following high winds. Such checklist shall be:

1. Where the scaffold was designed by a licensed rigger or sign hanger, or installed by or under the direct and continuing supervision of a licensed rigger or sign hanger, developed by the licensee; or
2. Where the scaffold was not designed by a licensed rigger or sign hanger, or installed by or under the direct and continuing supervision of a licensed rigger or sign hanger, developed by the registered design professional who designed the scaffold.

Exception: A pre-shift inspection checklist is not required for a nonadjustable suspended scaffold that, pursuant to Section 3314.3.2, is not required to be designed.

3314.4.3.5 Pre-shift inspection for a supported scaffold. Prior to each shift, and after any occurrence which could affect a scaffold's structural integrity, the supported scaffold shall be inspected by the competent person supervising the use of the scaffold in accordance with Section 3314.4.2.2 to verify the scaffold [remains], all components of and attachments to the scaffold, and all supports and anchorages of the scaffold, remain in a safe condition for use. Such competent person shall have completed the training required by Section 3314.4.5.2. The results of the inspection shall be documented in a pre-shift inspection report signed and dated by the person who performed the inspection. The scaffold shall not be used until it has passed such inspection and the pre-shift inspection report has been completed.

Exception: An inspection report is not required for a supported scaffold that is not required to be designed under Section 3314.3.1.

3314.4.3.6 Inspection following a site repair or adjustment. Following a repair or adjustment to a scaffold at a site, the portion adjusted or repaired shall be inspected by the person who supervised the adjustment or repair in accordance with Sections 3314.4.6 or 3314.4.7 to verify the adequacy of such adjustment or repair. A description of the adjustment or repair, and the results of the inspection, shall be recorded, signed, and dated by such supervisor and kept with the inspection report required by Sections 3314.4.3.4 or 3314.4.3.5. The scaffold shall not be used until it has passed such inspection and the results of the inspection have been documented.

Exceptions:

1. The scaffold may be used prior to the inspection where authorized in accordance with Section 3314.4.4.7.
2. An inspection and report is not required for a nonadjustable suspended scaffold that, pursuant to Section 3314.3.2, is not required to be designed.

3314.4.4 Safeguards. The safeguards required by Sections 3314.4.4.1 through [3314.4.4.8] 3314.4.4.12 shall be observed at all times.

3314.4.4.1 Safe working order. Scaffolds, including all components of and attachments to the scaffold, and all supports and anchorages of the scaffold, shall be provided to the site in a safe working order by their respective owner, with no known hazardous conditions, defective repairs, or maintenance problems that could compromise the safety of the public and property. All scaffolds shall be kept in a safe condition at the site by the scaffold controlling entity. Every damaged or weakened scaffold shall be immediately repaired or secured and shall not be used until satisfactory repairs have been completed, and the scaffold is inspected under the provisions of Section 3314.4.3.

3314.4.4.2 Loads. At no time shall a scaffold be loaded beyond the capacity of the scaffold or the ground or structure upon which it rests or is supported. Loads shall not be concentrated so as to cause stresses in excess of the allowable values designated for the applicable material described in this code.

3314.4.4.3 Capacity. Scaffolds shall meet the following capacity requirements.

3314.4.4.3.1 Scaffold and components. Each scaffold, and its components, shall be capable of supporting, without failure, its own weight and at least four times the maximum intended load applied or transmitted to it. Where applicable, scaffolds and their connections to the building or structure shall be designed to meet the anticipated loads during construction or demolition work, including wind loads as prescribed in Chapter 16.

3314.4.4.3.2 Suspension rope on nonadjustable suspended scaffolds. Each suspension rope, including connecting hardware, used on nonadjustable suspended scaffolds shall be capable of supporting, without failure, at least six times the maximum intended load applied or transmitted to the rope.

3314.4.4.3.3 Suspension rope on adjustable suspended scaffolds. Each suspension rope, including connecting hardware, used on adjustable suspension scaffolds shall be capable of supporting, without failure, at least six times the maximum intended load applied or transmitted to that rope with the scaffold operating at the rated load of the hoist.

3314.4.4.3.4 Direct connections to roofs, floors, and counterweights. Direct connections to roofs and floors, and counterweights used to balance adjustable suspension scaffolds, shall be capable of resisting at least four times the tipping moment imposed by the scaffold operating at the rated load of the hoist.

3314.4.4.4 Stable and secure. The scaffold and all materials and equipment located on or used from the scaffold shall be kept stable and secure at all times to prevent the scaffold from losing balance, overturning, or collapsing, and to prevent any object from falling from the scaffold.

3314.4.4.5 Dislodgement. Material and equipment susceptible to dislodgment shall not be stored on a scaffold while work is not being performed.

3314.4.4.6 Winds. Where sustained winds or wind gusts at the site exceed 30 miles per hour, the installation, repair, maintenance, adjustment, use, [and] operation, and removal of scaffolds located on the roof or setback of a building, exterior to a building or structure, on a working deck, or in an area with an unenclosed perimeter shall cease and the scaffold shall be secured. If the manufacturer or designer of the scaffold recommends work to cease at a lower wind speed, such recommendation shall instead apply. Wind speed shall be determined based on data from the nearest United States weather bureau reporting station, or an anemometer located at the site, freely exposed to the wind, and calibrated in accordance with ASTM D5096[-02]. No scaffold installation, repair, maintenance, adjustment, use, operation, or removal work shall commence where the weather forecast indicates the work will not be able to be safely completed and the scaffold secured before sustained winds or wind gusts exceed the thresholds established by this section.

3314.4.4.7 Use during installation, repairs, maintenance, adjustments, or removal. Only personnel, materials, and uses authorized by the person responsible for supervising the installation, repair, maintenance, adjustment, or removal of a scaffold shall be located on and using the scaffold during such work.

3314.4.4.8 Noncombustible construction. With the exception of the planking, the following scaffolds shall be constructed of noncombustible materials:

1. Exterior scaffolds exceeding 75 feet (22 860 mm) in height.
2. Interior scaffolds exceeding 21 feet [~~(6.4 m)~~] (6401 mm) in height.
3. All scaffolds used in the alteration, repair, or partial demolition of buildings in Occupancy Groups I-1 to I-4.

3314.4.4.9 Capacity identification for suspended scaffolds. Suspended scaffold motors shall contain a plate from the manufacturer of the motor indicating the rated load of the motor. Swaged attachments or spliced eyes on wire suspension ropes shall be tagged in accordance with the requirements of Section 3314.11.8. Identification required by this section shall be maintained so as to be legible during the life of the element. Missing or illegible identification shall be replaced by a qualified person in accordance with the requirements of the manufacturer of the component or the testing entity authorized by Section 3314.11.8.

3314.4.4.10 Prohibition on shore or lean-to scaffolds. The use of shore or lean-to scaffolds is prohibited.

3314.4.4.11 Accumulation of debris. Debris shall not be allowed to accumulate on platforms.

3314.4.4.12 Precautions while working around powerlines. The clearance between scaffolds and power lines shall be as specified in Table 3314.4.4.12. Scaffolds shall not be erected, used, dismantled, altered, or moved such that they or any conductive material handled on them might come closer to exposed and energized power lines than as specified in Table 3314.4.4.12.

Exception: Scaffolds and materials may be closer to power lines than specified in Table 3314.4.4.12 where such clearance is necessary for performance of work, and only after the utility company, or electrical system operator, has been notified of the need to work closer and the utility company, or electrical system operator, has deenergized the lines, relocated the lines, or installed protective coverings to prevent accidental contact with the lines.

**TABLE 3314.4.4.12
MINIMUM DISTANCES FROM POWER LINES**

<u>Insulated Lines</u>		
<u>Voltage</u>	<u>Minimum distance</u>	<u>Alternatives</u>
<u>Less than 300 volts</u>	<u>3 feet (914 mm)</u>	<u>Two times the length of the line insulator, but never less than 10 feet (3048 mm).</u>
<u>300 volts to 50 kilovolts</u>	<u>10 feet (3048 mm)</u>	
<u>More than 50 kilovolts</u>	<u>10 feet (3048 mm) plus 0.4 inches (10 mm) for each 1 kilovolt over 50 kilovolts.</u>	
<u>Uninsulated Lines</u>		
<u>Voltage</u>	<u>Minimum distance</u>	<u>Alternatives</u>
<u>Less than 50 kilovolts</u>	<u>10 feet (3.1 m)</u>	<u>Two times the length of the line insulator, but never less than 10 feet (3048 mm).</u>
<u>More than 50 kilovolts</u>	<u>10 feet (3.1 m) plus 0.4 inches (10 mm) for each 1 kilovolt over 50 kilovolts.</u>	

3314.4.5 Training. Only those who are qualified to install, adjust, maintain, repair, use, or remove a scaffold, and are trained in accordance with the requirements of this section, shall perform such work or supervise such work. No person shall knowingly permit or cause an individual who does not have the experience and training required by this section to install, adjust, modify, repair, use, or remove a scaffold.

3314.4.5.1 Training for supported scaffold installers, adjusters, repairers, maintainers, [inspectors,] or removers. Workers who install, adjust, repair, maintain, [inspect,] or remove a supported scaffold that is 40 feet (12 192 mm) or more in height, including the person supervising such, shall, at a minimum, have completed a department-approved training program or course that is at least 32 hours long and shall complete a department-approved 8-hour refresher program or course every 4 years thereafter. Workers who install, adjust, repair, maintain, or remove a sidewalk shed that provides a base for a supported scaffold that is 40 feet (12 192 mm) or more in height, including the person supervising such, are subject to the above requirements.

Exceptions:

1. The installation, adjustment, maintenance, repair, or removal of a supported scaffold performed by an employee of a public utility, including the person supervising such, where such supported scaffold is located within the interior of a structure owned or operated by such utility, and when such utility has a training safety program or course of not less than 32 hours for its employees who perform such scaffold work.

2. Where existing supported scaffold deck planking or guardrails are being relocated to a different level of the scaffold in accordance with the design, such may be performed by individuals who have completed the training required by Section 3314.4.5.2.

3314.4.5.2 Training for supported scaffold users. Individuals who use a supported scaffold, including the person supervising such, shall, at a minimum, have completed a department-approved training program or course that is at least 4 hours long and, every four years thereafter, retake the 4-hour training program or course.

Exceptions:

1. Employees of a public utility performing work while using a supported scaffold, including the person supervising such, provided that such employees are trained to be able to recognize the hazards associated with the type of supported scaffold being used and to understand the procedures to control those hazards.
2. A registered design professional who has not completed the training may use a supported scaffold to perform inspections provided the registered design professional does not perform construction, maintenance, repair, or demolition work from the scaffold.
3. The use of a stair tower/scaffold stairway/scaffold stair tower that is not connected to a scaffold work platform and is dedicated to providing temporary ingress or egress to the building or structure.

3314.4.5.3 Training for suspended scaffold supervisors. Individuals who exercise supervisory responsibility in accordance with the requirements of Sections 3314.4.1 through 3314.4.4 for the installation, adjustment, repair, maintenance, use, or removal of a suspended scaffold shall, at a minimum, have completed a department-approved training program or course that is at least 32 hours long and, four years following completion of the 32-hour program or course, and every four years thereafter, complete a department-approved 8-hour refresher program or course.

Exception: Individuals supervising the installation, adjustment, modification, repair, use, or removal of a single tier nonadjustable suspended scaffold whose platform is 40 square feet (3720 mm²) or less in size.

3314.4.5.4 Training for suspended scaffold installers, adjusters, repairers, maintainers, users, [~~inspectors,~~] or removers. Individuals who install, adjust, repair, maintain, use, [~~inspect,~~] or remove a suspended scaffold shall, at a minimum, have completed a department-approved training program or course that is at least 16 hours long and, four years following completion of the 16-hour program or course, and every four years thereafter, complete a department-approved 8-hour refresher program or course.

Exceptions:

1. A registered design professional who has not completed the training may ride on a suspended scaffold to perform inspections provided the registered design professional does not perform construction, maintenance, repair, or demolition work from the scaffold, or operate the scaffold, and provided the registered design professional is familiar with the use of the scaffold, safety equipment, and emergency procedures.
2. Individuals who install, adjust, repair, maintain, use, or remove a single tier nonadjustable suspended scaffold [~~including the person supervising such use~~] whose platform is 40 square feet (3720 mm²) or less in size.
3. A person who possesses a valid challenge examination certificate issued prior to January 1, 2014, need not take a new 16-hour initial program or course but shall be required to complete the 8-hour refresher program or course every 4 years, beginning from the date of enactment of this code.

3314.4.5.5 Course providers. Training programs or courses required by this section shall be conducted by a registered New York State Department of Labor apprenticeship training program or by an educational institution or school chartered, licensed or registered by the New York State Department of Education or by a provider approved by the department and presented by an instructor acceptable to the commissioner.

3314.4.5.6 Course curriculums. All training programs or courses required by this section shall be based on the scaffold requirements of this chapter and shall include, but not be limited to, instruction on the type of scaffold the training covers and associated hazards, common causes of scaffold [~~accidents~~] incidents and steps to avoid such [~~accidents~~] incidents, scaffold components, scaffold connections to a structure, scaffold inspection, the maximum intended load and load-handling capacities of scaffolds, and the prevention of overload conditions. Curriculums for scaffold users shall be focused on the proper use of the scaffold. Curriculums for scaffold installers, adjusters, maintainers, repairers, and removers shall be focused on the proper execution of such work. Curriculums in excess of eight hours in length shall include a significant portion of hands-on training.

3314.4.5.7 Evaluation. Successful completion of a training program or course that is more than 4 hours in length shall be based upon a written performance evaluation. For courses that are 16 hours or greater in length, successful completion shall also be based upon passage of a hands-on performance evaluation.

3314.4.5.8 Certificate card. Successful completion of the training program or course shall be evidenced by a wallet size certificate card issued by the training provider and acceptable to the commissioner. Such certificate card shall be readily available to the commissioner upon request and shall contain, at a minimum, the name and photograph of the individual to whom it was issued, as well as any other information required pursuant to rules promulgated by the commissioner for a department approved training course.

3314.4.5.9 Grace period. For individuals who fail to complete the required refresher program or course within any 4 year period, a refresher program or course shall be considered timely if completed within 1 year after the expiration date of the last previously completed initial or refresher program or course. During such period, such individual shall not perform or supervise any activity for which the lapsed training is required to perform or supervise such activity until such individual has successfully completed such refresher program or course. Where more than 1 year has lapsed, such individual shall be required to successfully recomplete the initial training program or course.

3314.4.6 Adjustments. Scaffolds, all components of and attachments to the scaffold, and all supports and anchorages of the scaffold installed at a site shall be adjusted under the supervision of a competent person designated by the contractor or licensee who installed the scaffold. Individuals who perform adjustments, and the person supervising such, shall be trained in accordance with Section 3314.4.5. Following the adjustment, the scaffold shall be inspected in accordance with Section 3314.4.3.6.

Exception: Where a sidewalk shed provides the base for a supported scaffold, the sidewalk shed shall be adjusted in accordance with the requirements of Section 3307.6.

3314.4.7 Repairs. Scaffolds, all components of and attachments to the scaffold, and all supports and anchorages of the scaffold installed at a site shall be repaired under the supervision of a competent person designated by the equipment owner. Individuals who perform repairs, and the person supervising such, shall be trained in accordance with Section 3314.4.5. Following the repair, the scaffold shall be inspected in accordance with Section 3314.4.3.6.

Exceptions:

1. Where a sidewalk shed provides the base for a supported scaffold, the sidewalk shed shall be repaired in accordance with the requirements of Section 3307.6.
2. Components and attachments may be replaced under the supervision of a competent person designated by the contractor or licensee who installed the scaffold.

3314.4.8 Maintenance. Scaffolds, all components of and attachments to the scaffold, and all supports and anchorages of the scaffold installed at a site shall be maintained in a good condition by a qualified person designated by the scaffold controlling entity. Individuals maintaining a scaffold shall have been trained in accordance with Section 3314.4.5. Individuals who maintain an adjustable suspended scaffold hoist shall also have been trained and authorized by the manufacturer of the scaffold hoist. A description of the maintenance shall be recorded, signed, and dated by the person who performed the maintenance and kept with the inspection checklist or report required by Sections 3314.4.3.4 or 3314.4.3.5.

Exceptions:

1. Where a sidewalk shed provides the base for a supported scaffold, the sidewalk shed shall be maintained in accordance with the requirements of Section 3307.6.

2. A description of the maintenance is not required for a nonadjustable suspended scaffold that, pursuant to Section 3314.3.2, is not required to be designed.

3314.5 Platform construction. Platforms on all working levels of a scaffold shall be fully planked or decked between the front uprights and the guardrail system supports in accordance with Sections 3314.5.1 through [3314.5.6] 3314.5.7.

Exception: Platforms used solely as walkways or used solely by workers installing or removing the scaffold shall be planked to the extent necessary to ensure the safety of the public and property.

3314.5.1 Platform spacing. Each platform unit (e.g., scaffold plank, fabricated plank, fabricated deck, or fabricated platform) shall be installed so that the space between adjacent units and the space between the platform and the uprights is no more than 1 inch (25 mm) wide except where a qualified person can demonstrate that a wider space is necessary.

3314.5.2 Maximum span for wood plank. All lumber used in scaffolds or their supports shall be at least equal in strength and quality to construction grade lumber in accordance with Section 2301. See Table 3314.5.2 for the maximum span for scaffold planks.

**TABLE 3314.5.2
MAXIMUM PERMISSIBLE SPANS FOR 2-INCH PLANK USED ON SCAFFOLDS**

MATERIAL	FULL THICKNESS UNDRESSED LUMBER			LUMBER OF NOMINAL THICKNESS		
	25	50	75	25	50	75
Working Load (psf)	25	50	75	25	50	75
Permissible Span (ft)	10	8	6	8	6	5

For SI: 1 inch = 25.4 mm, 1 pound per square foot = 47.88 Pa, 1 foot = 304.8 mm.

3314.5.3 Minimum overhang. The end of a platform shall extend over the centerline of its support a minimum of 6 inches (152 mm) unless cleated or otherwise restrained by hooks or equivalent means.

3314.5.4 Maximum cantilever. The maximum cantilever shall be as follows.

3314.5.4.1 Ten feet or less. The end of a platform 10 feet (3048 mm) or less in length shall not extend over the centerline of its support more than 12 inches (305 mm) unless the platform and its tiedown are designed by a qualified person or the platform has guardrails to prevent access to the cantilevered end.

3314.5.4.2 More than ten feet. The end of a platform more than 10 feet (3048 mm) in length shall not extend over the centerline of its support more than 18 inches (457 mm) unless the platform and its tiedown are designed by a qualified person or the platform has guardrails to prevent access to the cantilevered end.

3314.5.5 Platform tiedown. All platforms shall be tied down or otherwise positively restrained by hooks or equivalent means to prevent dislodgment in all directions.

3314.5.6 Platform deflection. Platforms shall not deflect more than 1/60 of the span when loaded.

3314.5.7 Unsuitable platforms. Unstable objects shall not be used as working platforms.

3314.6 Footings and anchorage. The footings and anchorage for every scaffold shall be sound and rigid, capable of carrying the maximum load without [~~excessive~~] settlement or deformation and secure against movement in any direction. Supports such as barrels, boxes, loose brick, loose stone, or other unstable materials shall not be used.

3314.6.1 Safe points of anchorage. Safe points of anchorage include structural members of a building. Window washing anchors, window frames, mullions, handrails, standpipes, vents and other piping systems, electrical conduit, counterweights or similar elements shall not be used as anchors or braceback points.

Exception: Window washing anchor points that are part of the base building structure may be utilized as an anchor or braceback point for a scaffold, subject to the approval of the commissioner. The anchor points shall be inspected by a registered design professional prior to use to verify their ability to support all loads imposed. At the end of the job, the anchor points shall be restored to their original condition, any damage repaired, and inspected by a registered design professional to verify such. A report verifying such restoration and inspection shall be prepared by the registered design professional and submitted to the department.

3314.6.2 Lifeline anchorage. [~~Lifeline anchorage~~] Vertical lifelines shall be fastened to a fixed safe point of anchorage[;] and shall be independent of the scaffold [~~and shall be protected from sharp edges and abrasion~~]. Horizontal lifelines shall only be utilized where the individual who designed the scaffold in accordance with Section 3314.3 has determined vertical lifelines are not feasible (for example, lower platforms of a multi-level suspended scaffold). Where utilized, horizontal lifelines shall be secured to two or more structural members of the scaffold, or they may be looped around both suspension and independent suspension lines (on scaffolds so equipped) above the hoist and brake attached to the end of the scaffold. Horizontal lifelines shall not be attached only to the suspension ropes. Vertical and horizontal lifelines shall be protected from sharp edges and abrasion.

3314.6.3 Lifelines and suspension ropes. [~~Lifelines~~] Vertical lifelines, tiebacks, and suspension ropes shall each be attached to a different point of anchorage.

3314.6.4 Scaffolds supported on structure. Loads from supported and suspended scaffolds imposed on an existing roof or floor or similar structure shall:

1. Not be concentrated so as to cause stresses in excess of the allowable values designated for the applicable material described in this code; or
2. Be distributed with dunnage or shoring so as to prevent such load from exceeding the allowable values designated for the applicable material described in this code.

3314.7 Outrigger beams. Outrigger beams shall be made of structural metal or equivalent strength material and shall be restrained to prevent movement.

3314.7.1 Overhang. The overhang of outrigger beams shall not exceed that specified by the design and the inboard length of beam shall be at least one and one-half times the outboard length unless otherwise designed by a registered design professional.

3314.7.2 Placement. Outrigger beams shall be placed so that the suspension ropes will hang vertically.

3314.7.3 Outrigger beam end of suspension ropes. Suspension ropes shall be securely fastened to the outrigger beams by steel shackles, thimbles, or equivalent means.

3314.7.4 Load end of wire suspension ropes. The load end of wire suspension ropes shall be equipped with proper size thimbles and secured by eyesplicing or equivalent means. Where applicable, such equivalent means shall be in accordance with Section 3314.11.8.

3314.8 Guardrail system and debris netting. The open sides and ends of scaffold platforms shall be provided with a guardrail system that meets the requirements of Section 3314.8.1 and debris netting that meets the requirements of Section 3314.8.2.

Exceptions:

1. A guardrail system and debris netting are not required while the scaffold is being installed or removed but shall be in place before the scaffold is used.
2. A guardrail system and debris netting is not required along the edge of a scaffold facing a building or structure, provided the distance from the edge of the scaffold platform to the face of the building or structure is:
 - 2.1. For an outrigger scaffold, 3 inches [~~(80 mm)~~] (76 mm) or less;
 - 2.2. For a scaffold used in conjunction with plastering and lathing operations, 18 inches [~~(460 mm)~~] (457 mm) or less; or
 - 2.3. For all other scaffolds, 14 inches [~~(360 mm)~~] (356 mm) or less.
3. [~~Notwithstanding the provisions of Sections 3308.6.1.4 and 3314.9.4, debris~~] Debris netting is not required [along the perimeter of] for a scaffold [provided such perimeter] where the scaffold is [set back] set back from all adjoining property and areas that remain open to the public at a distance that is equal to or greater than half the height of scaffold, except where the scaffold is installed to provide an alternative to demolition safety zones, sidewalk sheds, safety netting, or adjoining property protection in accordance with Sections 3306, 3307, 3308, 3309, or the scaffold is installed at the edge of an unenclosed perimeter in accordance with Section 3314.9.4.
4. [~~Notwithstanding the provisions of Sections 3308.6.1.4 and 3314.9.4, debris~~] Debris netting is not required for a scaffold [which] that does not require a design in accordance with Section 3314.3, except where the scaffold is installed to provide an alternative to

demolition safety zones, sidewalk sheds, safety netting, or adjoining property protection in accordance with Sections 3306, 3307, 3308, or 3309, or the scaffold is installed at the edge of an unenclosed perimeter in accordance with Section 3314.9.4.

5. A guardrail system and debris netting is not required for a supported scaffold whose topmost platform is 6 feet (1829 mm) or less above the level of the ground or floor, except as otherwise required by Section 3314.9.4.

3314.8.1 Guardrail system. Where required by Section 3314.8, the guardrail system for a scaffold shall meet the requirements of Section 3308.7.1 through 3308.7.7.

Exceptions: For the purposes of this section:

1. The term “floor” in Sections 3308.7.1 through 3308.7.7 shall mean “platform.”
2. The height of the toprail, as prescribed in Section 3308.7.2, may be as low as 38 inches (965 mm) in a guardrail system utilized in connection with a scaffold, and such toprail may deflect to a height of not less than 38 inches (965 mm) when designed in accordance with Exception 1 to Section 3308.7.3.
3. Alternate guardrail systems under Exception 1 to Section 3308.7.3 may be designed by the designer of the scaffold or the manufacturer of the scaffold to be capable of withstanding, without failure, a force of at least:
 - 3.1. For toprails or equivalent members, a force applied in any downward or horizontal direction at any point along its top edge of at least 100 pounds (445 [N]) for guardrail systems installed on single-point adjustable suspended scaffolds or two-point adjustable suspended scaffolds, and at least 200 pounds (890 [N]) for guardrail systems installed on all other scaffolds.
 - 3.2. For midrails, screens, mesh, intermediate vertical members, solid panels, or equivalent members, a force applied in any downward or horizontal direction at any point along the midrail or other member of at least 75 pounds (333 [N]) for guardrail systems with a minimum 100 pound (445 [N]) toprail capacity, and at least 150 pounds (666 [N]) for guardrail systems with a minimum 200 pound (890 [N]) toprail capacity.
 - 3.3. For toeboards, a force of at least 50 pounds (222 [N]) applied in any downward or horizontal direction at any point along the toeboard.
4. ~~When~~ Where intermediate supports, such as ballisters or additional rails are used, they shall not be more than 19 inches (483 mm) apart.

3314.8.2 Debris netting. Where required by Section 3314.8, the scaffold shall be enclosed with a debris netting consisting of a wire screen comprised of not less than number 18 ~~gauge~~ gauge wire mesh, or equivalent synthetic netting that is flame retardant in accordance with NFPA 701, with openings in the wire or synthetic mesh no larger than ½ inch (13 mm) in the vertical or horizontal dimensions and ¾ inch (19 mm) in any other dimension. Such netting shall be securely

attached to the scaffold and shall enclose all open sides, ends, and bottom of the scaffold for the full height of all platform levels where work is occurring~~[-, or when on the upper level of a supported scaffold or when on a suspended scaffold, to the height of the toprail]~~. The effect of wind on the netting shall be accounted for in the design of the scaffold, where such design is required by Section 3314.3.

[Exception:] Exceptions:

1. Netting is not required to protect the bottom of the scaffold platform provided the netting is securely fastened to the scaffold deck and the scaffold platform planks are laid tight or the deck of the scaffold is solid.
2. Where netting is provided on the upper level of a supported scaffold, or when provided on a suspended scaffold, the netting need only extend to the height of the toprail.
3. Where the scaffold is installed as an alternative to sidewalk sheds, vertical nets, or adjoining property protection in accordance with Sections 3307, 3308, and 3309 respectively, the netting shall enclose the scaffold for its full height.

3314.9 Supported scaffold. Supported scaffolds shall meet the requirements of Sections 3314.9.1 through 3314.9.4[;].

3314.9.1 Height-to-base ratio. A supported scaffold with a height-to-base ratio (including outriggers supports, if used) of more than four to one (4:1) shall be restrained from ~~[tip ping]~~ tipping by guying, tying, bracing or equivalent means as follows:

1. Guys, ties, or braces shall be installed at locations where horizontal members support both inner and outer legs.
2. Guys, ties, or braces shall be installed ~~[according to the manufacturer's recommendations, or as designed in accordance with Section 3314.3, or at a minimum,]~~ in accordance with the design drawings required by Section 3314.3, or where design is not required, in accordance with the manufacturer's specifications. If design is not required and there are no manufacturer's specifications, the first guy, tie or brace shall be installed at a horizontal member and not more than a distance [4] four times the least plan dimension from the base support and be repeated vertically at locations of horizontal members every 20 feet (6096 mm) or less thereafter for scaffolds 3 feet (914 mm) wide or less, and every 26 feet (7925 mm) or less thereafter for scaffolds greater than 3 feet (914 mm) wide. In every instance, the capacity of requirements of Section 3314.4.4.3 shall apply, which may necessitate guys, ties or braces being installed at smaller intervals.
3. The top guy, tie, or brace shall be placed no further than four times the least plan dimension from the top. Such guys, ties, or braces shall be installed at each end of the scaffold and at horizontal intervals not to exceed 30 feet (9144 mm) measured from one end (not both) towards each other.

[3-] 4. Guys, ties, braces, or outriggers shall be used to prevent tipping of supported scaffolds in all circumstances where an eccentric load, such as a cantilevered work platform, is applied or is transmitted to the scaffold.

3314.9.2 Foundation. Supported scaffold poles, legs, posts, frames and uprights shall bear on base plates and mud sills or other adequate firm foundation to distribute the weight of the scaffold into the ground, structure, or sidewalk shed upon which it rests. Unstable objects shall not be used to support scaffolds or platform units.

3314.9.3 Plumb. Supported scaffold poles, legs, posts, frames, and uprights shall be plumb and braced to prevent swaying and displacement. The tolerance shall not exceed $L/100$, where L is the distance measured from the ground or grade elevation to the first [~~X-brace~~] cross brace or bottom of the first bearer or frame horizontal member.

3314.9.4 Supported scaffolds at the edge. Supported scaffolds located on a floor, working deck, or roof and located within a distance from the edge of the roof or an unenclosed perimeter that is equal to or less than [4.5] one and one-half times the height of the scaffold shall:

1. Be positively anchored or tied-back, and with all wheels or rollers secured by rope, cable, or chocking at the wheels in order to prevent movement; and
2. Have all sides of the scaffold facing an unenclosed perimeter or the edge of a roof within a distance that is equal to or less than [4.5] one and one-half times the height of the scaffold provided with guardrails and debris netting in accordance with Section 3314.8; or
3. Have all material and equipment susceptible to dislodgement, and not being actively held by a person, secured in a manner to prevent dislodgement by wind or accidental impact.

Exception: The above requirements shall not apply where vertical safety netting that meets the requirements of Section 3308.5, or an approved alternate system, extends to cover the full height and width of all unenclosed perimeters within a distance from the scaffold equal to or less than [4.5] one and one-half times the height of the scaffold.

3314.10 Suspended scaffold. Suspended scaffolds shall meet the requirements of Sections 3314.10.1 through [3314.10.11] 3314.10.14.

3314.10.1 Suspended elements to be kept vertical and parallel. Suspended scaffolds shall be installed and used in such a manner that the ropes or similar suspension elements are vertical and/or in a plane parallel to the wall at all times.

Exception: Ropes or similar suspension elements do not have to be vertical and/or in a plane parallel to the wall provided such occurs in accordance with design drawings prepared by a registered design professional. Such design drawings shall be based on an investigation of the support surface/structure (e.g. roof, parapet) and anchorage of the scaffold conducted by such registered design professional. A signed, sealed, and dated report prepared by the registered design professional documenting such investigation shall accompany the design drawings.

3314.10.2 Support. All suspended scaffold support devices, such as outrigger beams, C-hooks, parapet clamps, and similar devices shall be supported by surfaces/structures (e.g. roof, parapet) capable of supporting at least [4] four times the load imposed on them by the scaffold operating at the rated load of the hoist. The support shall be inspected prior to installation in accordance with the requirements of Section 3314.4.3.1.

3314.10.3 Outrigger beam location. Outrigger beams shall be placed perpendicular to the face of the building or structure.

Exception: Where a licensed rigger or registered design professional can demonstrate to the commissioner's satisfaction that it is not possible to place an outrigger beam perpendicular to the face of the building or structure, the outrigger beam may be placed at a different angle, provided opposing angle tiebacks are used.

3314.10.4 Outrigger beam stabilization. The inboard ends of the suspended scaffold outrigger beam shall be stabilized by bolts or other direct connections to the floor or roof deck, or they shall have their inboard ends stabilized by counterweights.

Exception: Multipoint adjustable suspended scaffolds shall not be stabilized by counterweights.

3314.10.5 Outrigger beams secured by tiebacks. Outrigger beams which are not stabilized by bolts or other direct connections to the floor or roof deck shall be secured by tiebacks.

~~[3314.10.5]~~ **3314.10.6 Outrigger beam installation.** Outrigger beams shall be installed with all bearing supports perpendicular to the beam centerline and shall set and maintain the web in a vertical position. The shackle or clevis with which the rope is attached to the outrigger beam shall be placed directly over the centerline of the stirrup.

~~[3314.10.6]~~ **3314.10.7 Counterweight material.** Only those items specifically designed as counterweights shall be used to counterweight scaffold systems. Counterweights shall be made of a nonflowable material. Sand, gravel and similar materials that can be easily dislocated shall not be used. Construction materials such as, but not limited to, masonry units and rolls of roofing felt, shall not be used as counterweights.

~~[3314.10.7]~~ **3314.10.8 Counterweight securement.** Counterweights shall be secured by mechanical means to the outrigger to prevent accidental dislodgment.

~~[3314.10.8]~~ **3314.10.9 Counterweight removal.** Counterweights shall not be removed from an outrigger beam until the scaffold is disassembled.

3314.10.10 Tiebacks. Tiebacks shall be equivalent in strength to the suspension ropes. Tiebacks shall be secured to a structurally sound anchorage on the building or structure in accordance with Section 3314.6.

~~[3314.10.9]~~ **3314.10.11 Horizontal tieback location.** Horizontal tiebacks shall be installed perpendicular to the face of the building or structure, or opposing angle tiebacks shall be installed. Single tiebacks installed at an angle are prohibited.

~~[3314.10.10]~~ **3314.10.12 Support devices.** Suspended scaffold support devices, such as C-hooks, cornice hooks, roof hooks, roof irons, parapet clamps or other similar devices shall meet the following requirements:

1. Support devices shall be made of steel, wrought iron or materials of equivalent strength.
2. Such devices shall be supported by bearing blocks.
3. Support devices shall be secured against movement by tiebacks installed perpendicular to the face of the building or structure or by opposing angle tiebacks installed and secured to a structurally sound point of anchorage as prescribed in Section 3314.6.
4. Tieback rope shall be at least equal in strength to the suspension rope.

~~[3314.10.11]~~ **3314.10.13 Securing suspended scaffolds.** At the end of the shift, and when otherwise required by Section 3314.4.4.6, the suspended scaffold shall be cleared of all equipment and material susceptible to dislodgement and shall be lowered to the street, ~~[or deck of the]~~ sidewalk shed, or other location specified in the design drawings required by Section 3314.3.3, or shall be secured to the roof, ~~[or]~~ building, or other structure in accordance with the design drawings required by Section 3314.3.3.

3314.10.14 Stand-off brackets prohibited. The installation or use of a stand-off bracket is prohibited.

3314.11 Suspension rope. Suspension ropes on suspended scaffolds shall meet the requirements of Section 3314.11.1 through 3314.11.8.

3314.11.1 Wraps of rope. When winding drum hoists are used on a suspended scaffold, they shall contain not fewer than four wraps of the suspension rope at the lowest point of scaffold travel. When other types of hoists are used, the suspension ropes shall be long enough to allow the scaffold to be lowered to the level below without the rope end passing through the hoist, or the rope end shall be configured or provided with means to prevent the end from passing through the hoist.

~~[3314.11.1]~~ **3314.11.2 Repaired rope.** The use of repaired wire rope as suspension rope is prohibited.

~~[3314.11.2]~~ **3314.11.3 Rope replacement.** Ropes shall be replaced or removed if any of the following conditions exist, and as otherwise prescribed by rule of the department:

1. Any physical damage that impairs the function and strength of the rope.
2. Presence of kinks that might impair the tracking or wrapping of the rope around the drums or sheaves.
3. Presence of abrasion, corrosion, scrubbing, ~~[flattening]~~ flattening or peening causing the loss of more than one-third of the original diameter of the outside wires.
4. Heat damage caused by a torch or any damage caused by contact with electrical wires.

5. Evidence that the secondary brake has been activated during an overspeed condition and has engaged the suspension rope.

~~[3314.11.3]~~ **3314.11.4 Shielding.** Suspension ropes shall be shielded from heat-producing processes.

~~[3314.11.4]~~ **3314.11.5 Corrosive substances.** When acids or other corrosive substances are used on a scaffold, the ropes shall be shielded, treated to protect against corrosive substances, or made of a material that will not be damaged by the corrosive substance being used.

~~[3314.11.5]~~ **3314.11.6 Suspended scaffold welding precautions for arcing prevention.** Precautions shall be taken to prevent the possibility of arcing through the suspension wire rope during welding operations.

~~[3314.11.5.1]~~ **3314.11.6.1 Insulated thimble.** An insulated thimble shall be used to attach each suspension wire rope to its hanging support. Excessive suspension wire rope and any additional independent lines from grounding shall be insulated.

~~[3314.11.5.2]~~ **3314.11.6.2 Insulating material.** The suspension wire rope shall be covered with insulating material extending at least 4 feet (1219 mm) above the hoist. If there is a tail line below the hoist, it shall be insulated to prevent contact with the platform. The portion of the tail line that hangs free below the scaffold shall be guided or retained or both so that it does not become grounded.

~~[3314.11.5.3]~~ **3314.11.6.3 Protective covers.** Each hoist shall be covered with insulated protective covers.

~~[3314.11.5.4]~~ **3314.11.6.4 Grounding conductor.** In addition to a work lead attachment required by the welding process, a grounding conductor shall be connected from the scaffold to the structure. The size of the connector shall be at least the size of the welding process work lead, and this conductor shall not be in series with the welding process or the work piece.

~~[3314.11.5.5]~~ **3314.11.6.5 Disconnected grounding lead.** If the scaffold grounding lead is disconnected at any time, the welding machine shall be shut off or the welding lead shall be removed from the scaffold.

~~[3314.11.5.6]~~ **3314.11.6.6 Welding rod or lead.** An active welding rod or uninsulated welding lead shall not be allowed to make contact with the scaffold or its suspension system.

~~[3314.11.6]~~ **3314.11.7 Wire rope clips.** Wire rope clips used on suspended scaffolds shall be in accordance with Sections 3114.11.7.1 through 3314.11.7.4.

3314.11.7.1 Minimum number of clips to be installed. ~~[When]~~ Where wire clips are used on suspended scaffolds, there shall be a minimum of three wire rope clips installed a minimum of six rope diameters apart.

3314.11.7.2 Installed to manufacturer specifications. The clips shall be installed according to the manufacturer's specifications.

3314.11.7.3 Retightening of clips. The clips shall be retightened to the manufacturer's specifications after initial loading. ~~[U-bolt clips shall not be used at the point of suspension.]~~ Clips shall be inspected and retightened to the manufacturer's specifications at the start of each work shift thereafter.

3314.11.7.4 U-bolt clips. When U-bolt clips are used, the U-bolt shall be placed over the dead end of the rope and the saddle shall be placed over the live end of the rope.

Exception: U-bolt clips shall not be used at the point of suspension.

3314.11.8 Swaged attachments or spliced eyes. Swaged attachments or spliced eyes on wire suspension ropes shall not be used unless they are made by the wire rope manufacturer or a qualified person. Where swaged attachments or spliced eyes are made by a qualified person, a representative sample of the assembly shall be tested under the supervision of a licensed rigger or a registered design professional to confirm the assembly will supply the clamping force specified by the wire rope manufacturer or the manufacturer of the hardware. Swaged attachments or spliced eyes shall be provided with a tag by the wire rope manufacturer or the testing entity indicating the capacity of the assembly.

Exception: J-bolts shall be designed by a manufacturer and installed in accordance with the manufacturer's specifications.

3314.12 Wood pole scaffolds. Wood pole scaffolds shall meet the requirements of Sections 3314.12.1 through 3314.12.9.

3314.12.1 Standard designs. All wood pole scaffolds 40 feet (12 192 mm) high or less shall be constructed in accordance with the minimum nominal sizes and maximum spacings shown in Tables 3314.12.1 (1) through 3314.12.1 (6). Wood pole scaffolds more than 40 feet (12 192 mm) high shall be designed in accordance with Section 3314.3.

TABLE 3314.12.1(1)
MINIMUM SIZE AND MAXIMUM SPACING OF MEMBERS OF SINGLE WOOD POLE LIGHT DUTY
SCAFFOLDS

UNIFORMLY DISTRIBUTED LOAD					
NOT TO EXCEED 25 psf					
Max. height of scaffold (ft)	20'	40'	60'	75'	
Poles or uprights (min)	2" × 4"	3" × 4"	4" × 4"	Top 60' 4" × 4"	Lower Sect. 4" × 6"
Pole foundation (min)	2" × 9"				
Max. pole spacing (longitudinal)	10'-0"				
Max. width of scaffold	5'-0"				
Bearers or putlogs (min)	3" × 4" or 2" × 6" (on edge)				
Ledgers (minimum)	1" × 6" (on edge)				
With 6'-0" pole space	1" × 6" (on edge)				
With 10'-0" pole space	1¼" × 9" (on edge)				
Vertical spacing of ledgers (max)	7'-0"				
Nonsupporting stringers	1" × 4"				
Tie-ins	1" × 4"				
Bracing	1" × 4"				
Planking	1¼" × 9"				
Not more than 6' span	1¼" × 9"				
Up to 10' span	2" × 9"				
Toeboards	1" × 6"				
Guardrails	2" × 4"				

Note: For SI: 1 inch = 25.4 mm, 1 foot = 304.8 mm, 1 pound per square foot = 47.88 Pa.

TABLE 3314.12.1(2)
MINIMUM SIZE AND MAXIMUM SPACING OF MEMBERS OF SINGLE WOOD POLE MEDIUM DUTY
SCAFFOLDS

UNIFORMLY DISTRIBUTED LOAD					
NOT TO EXCEED 50 psf					
Max. height of scaffold	20'	40'	60'	75'	
Poles or uprights (min)	3" × 4" or 2" × 6"	4" × 4"	4" × 6"	Top 60' 4" × 4"	Lower Sect. 4" × 6"
Pole foundation (min)	2" × 9"				
Max. pole spacing (longitudinal)	8'-0"				
Max. width of scaffold	5'-0"			8'-0"	
Bearers or putlogs (min)	3" × 4" or 2" × 6" (on edge)			3" × 5" or 2" × 9" (on edge)	
Max. spacing of bearers or putlogs	8'-0"				
Ledgers (minimum)	2" × 9" (on edge)				
Vertical spacing of ledgers (max)	7" × 0"				
Nonsupporting stringers	1" × 6" or 1¼" × 4"				
Tie-ins	1" × 6"				
Bracing	1" × 6"				
Planking	1¼" × 9"				
Not more than 6' span	2" × 9"				
Up to 8' span	2" × 9"				
Toeboards	2" × 9"				
Guardrails	2" × 4"				

Note: For SI: 1 inch = 25.4 mm, 1 foot = 304.8 mm, 1 pound per square foot = 47.88 Pa.

TABLE 3314.12.1(3)
MINIMUM SIZE AND MAXIMUM SPACING OF MEMBERS OF SINGLE WOOD POLE HEAVY DUTY
SCAFFOLDS

UNIFORMLY DISTRIBUTED LOAD					
NOT TO EXCEED 75 psf					
Max. height of scaffold	20'	40'	60'	75'	
Poles or uprights (min)	3" × 4" or 2" × 6"	4" × 4"	4" × 6"	Top 60' 4" × 6"	Lower Sect. 6" × 6"
Pole foundation (min)	2" × 9"				
Max. pole spacing (longitudinal)	6'-0"				
Max. width of scaffold	5'-0"			8'-0"	
Bearers or putlogs (min)	3" × 5"			3" × 6" or 2" × 9"	
Max. spacing of bearers or putlogs	6'-0"				
Ledgers (minimum)	2" × 9" (on edge)				
Vertical spacing of ledgers (max)	7" × 0"				
Nonsupporting stringers	2" × 4"				
Tie-ins	1" × 6"				
Bracing	1" × 6"				
Planking	2" × 9"				
Toeboards	2" × 9"				
Guardrails	2" × 4"				

Note: For SI: 1 inch = 25.4 mm, 1 foot = 304.8 mm, 1 pound per square foot = 47.88 Pa.

TABLE 3314.12.1(4)
MINIMUM SIZE AND MAXIMUM SPACING OF MEMBERS OF INDEPENDENT WOOD POLE LIGHT
DUTY SCAFFOLDS

UNIFORMLY DISTRIBUTED LOAD					
NOT TO EXCEED 25 psf					
Max. height of scaffold (ft)	20'	40'	60'	75'	
Poles or uprights (min)	2" × 4"	3" × 4" or 2" × 6"	4" × 4"	Top 60' 4" × 4"	Lower Sect. 4" × 6"
Pole foundation (min)	2" × 9"				
Max. pole spacing (longitudinal)					
With 1 ¼" × 9" ledgers	6'-0"				
With 2" × 9" ledgers	10'-0"				
Max. pole spacing (transverse)	10'-0" ^a				
Ledgers (min)	1 ¼" × 9" (on edge) or 2" × 9"				
Vertical spacing of ledgers (max)	7'-0"				
Bearers (min)	1 ¼" × 9" (on edge)				
Non-supporting stringers	1" × 4"				
Bracing	1" × 4"				
Planking					
Not more than 6' span	1 ¼" × 9"				
Up to 8' span	2" × 9"				
Toeboards	1" × 6"				
Guardrails	2" × 4"				

Note: For SI: 1 inch = 25.4 mm, 1 foot = 304.8 mm, 1 pound per square foot = 47.88 Pa.

a. Total base dimension in both directions to be at least 25 percent of height.

**TABLE 3314.12.1(5)
MINIMUM SIZE AND MAXIMUM SPACING OF MEMBERS OF INDEPENDENT WOOD POLE
MEDIUM DUTY SCAFFOLDS**

UNIFORMLY DISTRIBUTED LOAD NOT TO EXCEED 50 psf					
Max. height of scaffold (ft)	20'	40'	60'	75'	
Poles or uprights (min)	3" × 4" or 2" × 6"	4" × 4"	4" × 6"	Top 60' 4" × 6"	Lower Sect. 6" × 6"
Pole foundation (min)	2" x 9"				
Max. pole spacing (longitudinal)	8'-0"				
Max. pole spacing (transverse)	10'-0" ^a				
Ledgers (min)	2" × 9" (on edge)				
Vertical spacing of ledgers (max)	6'-0"				
Bearers (min)	2" × 9" (on edge)				
Non-supporting stringers	1¼" × 4" or 1" × 6"				
Bracing	1" × 6"				
Planking					
Not more than 6' span	1¼" × 9"				
Up to 6' span	2" × 9"				
Toeboards	2" × 9"				
Guardrails	2" × 4"				

Note: For SI: 1 inch = 25.4 mm, 1 foot = 304.8 mm, 1 pound per square foot = 47.88 Pa.

a. Total base dimension in both directions to be at least 25 percent of height.

TABLE 3314.12.1(6)
MINIMUM SIZE AND MAXIMUM SPACING OF MEMBERS OF INDEPENDENT WOOD POLE
HEAVY DUTY SCAFFOLDS

UNIFORMLY DISTRIBUTED LOAD					
NOT TO EXCEED 75 psf					
Max. height of scaffold (ft)	20'	40'	60'		
Poles or uprights (min)	4" × 4"	4" × 4"	4" × 6"	Top 60' 4" × 6"	Lower Sect. 6" × 6"
Pole foundation (min)	2" × 9"				
Max. pole spacing (longitudinal)	6'-0" ^a				
Max. pole spacing (transverse)	10'-0" ^a				
Ledgers (min)	2" × 9" (on edge)				
Vertical spacing of ledgers (max)	5'-0"				
Bearers (min)	2" × 9" (on edge)				
Non-supporting stringers	1¼" × 9"				
Bracing	1" × 6"				
Planking	2" × 9"				
Toeboards	2" × 9"				
Guardrails	2" × 4"				

Note: For SI: 1 inch = 25.4 mm, 1 foot = 304.8 mm, 1 pound per square foot = 47.88 Pa.

a. Total base dimension in both directions to be at least 25 percent of height.

3314.12.2 Erection and removal. When a new working level is desired, the existing planks shall be left undisturbed until the new working level is framed. As the platform level is abandoned with the progress of the work, all members other than the planking, railing and toeboards shall be left intact. When removing a scaffold, the sequence of removing the members shall be the reverse of that used in erection.

3314.12.3 Materials and construction for wood pole scaffolds. Wood pole scaffold materials and construction shall comply with the following requirements:

1. All lumber used in wood pole scaffolds or their supports shall be at least equal in strength and quality to construction grade lumber in accordance with Section 2301.
2. All lumber and timber shall be fastened at the various joints with sufficient nails or bolts of a suitable size to produce a secure joint capable of withstanding the design load. Table 3314.12.3 provides minimum requirements for size and number of nails. All nails shall be driven full length.
3. Any other suitable material, or dimensions other than those indicated, may be used for wood pole scaffold construction provided it is at least equivalent in strength and suitability to the comparable wood scaffold it is designed to replace, and approval of the commissioner has been obtained.

**TABLE 3314.12.3
SIZE AND NUMBER OF NAILS REQUIRED FOR SCAFFOLD CONSTRUCTION**

Thickness of Smaller Member (inches)	Trade Size of Nail	Length of Nail (inches)
1	8d	2 ½
2	20d	4
3	60d	6
4	-	8
Width of Smaller Member (inches)		Minimum Number of Nails Required
4		2
6		3
8		4
10		5
12		5

3314.12.4 Poles. Wooden scaffold poles shall be plumb and the foot ends shall be secured against lateral movement. Where wood poles are spliced, the squared end of the upper section shall bear uniformly on the squared end of the lower section and the two ends shall be rigidly fastened together with two or more wood splice plates, each at least 4 feet (1219 mm) in length. The plates shall be placed at right angles to each other, shall overlap the abutting ends of the pole equally, and shall have a combined sectional area not less than 50 percent of the cross sectional area of the pole. Splicing of adjacent poles shall be staggered. Splices shall be close to ledgers, but so located as not to interfere with the fastenings.

3314.12.5 Bracing. Wood pole scaffolds shall be braced and stayed to prevent movement away from the building. Diagonal or equivalent bracing shall be provided to prevent the poles from moving in a direction parallel to the building face and shall be so installed that every spliced section of every pole is braced to adjacent poles.

3314.12.6 Planking. Planking shall comply with Items 1 through 3.

1. Where planks are butted end to end, parallel putlogs or bearers shall be provided not more than 8 inches (203 mm) apart so that the butted ends rest on separate putlogs or bearers. Ends shall be nailed or cleated.
2. Where platform planks are used with overlapping ends, the ends of both the upper and lower planks shall overlap the putlog or bearer by at least 6 inches (152 mm).
3. Planks shall be laid close together and shall be of sufficient length to extend over three bearers.

3314.12.7 Connections. Ledgers shall not be spliced between poles but shall overlap the poles at each end by at least 4 inches (102 mm). Where ledgers lap each other, bearing-blocks attached to the pole shall be provided to support the ledger.

3314.12.7.1 Braces. The ends of all wooden braces shall overlap the nailed fastenings by an amount sufficient to prevent the ends of the braces from splitting.

3314.12.8 Putlogs for single pole scaffolds. All putlogs shall be set with the greater dimension vertical and shall be long enough to project beyond the outer edge of the poles by at least 12 inches (305 mm). Putlogs shall be supported on the ledger and located against the side of the poles and fastened to either the pole or the ledger. The other end of the putlog shall rest in the wall of the building, with at least a 4 inch (102 mm) bearing, and shall not be notched or cut down, except for light duty scaffolds, which may be notched or cut down to fit into a space made by the removal of a brick. In such cases, the notch shall be made on the top of the putlog just deep enough to permit it to be inserted in the hole in the wall.

3314.12.9 Bearers for independent pole scaffolds. Bearers shall be set with their greater dimensions vertical, and shall be long enough to project over the ledgers beyond the outer row of poles by at least 12 inches (305 mm) and beyond the inner row of poles by at least 2 inches (51 mm). Bearers shall be supported on the ledgers, located against the sides of the poles and fastened to the ledgers.

3314.13 Fabricated frame scaffolds. Fabricated frame scaffolds shall meet the requirements of Sections 3314.13.1 through 3314.13.3.

3314.13.1 Bracing. Frames and panels shall be braced by cross, horizontal or diagonal braces or a combination thereof, which secure vertical members together laterally.

3314.13.2 Vertical joining. Frames and panels shall be joined together vertically by coupling or stacking pins or equivalent means. Where uplift can occur, the frames or panels shall be locked together vertically by pins or equivalent means.

3314.13.3 Frame scaffold brackets. Brackets used to support cantilevered loads shall be seated with side-brackets parallel to the frame and end-brackets at 90 degrees (1.57 rad) to the frames shall not be bent or twisted from these positions and shall be used only to support light duty loads ~~[as defined in Section 3302.1]~~ of up to 25 pounds per square foot (122.05 kg/m²), unless the design provisions of Section 3314.3 have been met.

3314.14 Outrigger scaffolds (thrust out). Outrigger scaffolds (thrust out) shall not be used for loading in excess of 50 pounds per square foot (244.1 kg/m²) (medium duty).

3314.14.1 Outrigger beams. The fulcrum point of the beam shall rest on a secure bearing at least 6 inches (152 mm) in each horizontal dimension. The beam shall be secured against movement and shall be securely braced against tipping at both the fulcrum point and the inboard end.

3314.14.2 Inboard supports. The inboard ends of outrigger beams shall be securely fixed to resist all vertical, horizontal and torsional forces. Pull-out tests for adhesive and expansions anchors, if used, shall be approved by the commissioner.

3314.15 Two-point adjustable suspended scaffolds. Two-point adjustable suspended scaffolds shall meet the requirements of Sections 3314.15.1 through 3314.15.7.

3314.15.1 Width and support. Two-point adjustable suspended platforms shall be at least 20 inches (508 mm) but not more than 36 inches (914 mm) in width unless designed by a registered design professional. Each end of the platform shall be supported by a stirrup or hanger that meets the requirements of Section 3315.15.2, and the platform shall be securely fastened thereto. Not more than two hangers or stirrups shall be used to support one scaffold.

3314.15.2 Hangers or stirrups. Hangers or stirrups shall be of steel or wrought iron. Each such hanger shall be formed to properly fit the platform and the hoist mechanism. The hanger or stirrup shall be placed at least 6 inches (152 mm) but not more than 18 inches (457 mm) from the end of the platform ~~[unless the manufacturer specifies otherwise]~~.

Exception: Alternative spacing from the end of the platform may be utilized where the manufacturer so specifies and such alternative spacing is indicated on design drawings developed by a registered design professional.

3314.15.3 Fiber suspension rope. The use of fiber rope shall be limited to light duty two-point adjustable suspended scaffolds. Fiber rope shall be at least equivalent in strength and suitability to [³/₄] ¾-inch (19 mm) grade #1 unspliced manila rope.

3314.15.3.1 Corrosive substances. Fiber rope susceptible to damage from corrosive substances shall not be permitted for or near any work involving the use of corrosive substances.

3314.15.3.2 Upper block. Fiber rope shall not be used where the upper block is more than 100 feet (30 480 mm) or ten stories, whichever is less, above the ground or roof setback.

3314.15.3.3 Fit. All blocks shall fit the size of rope they carry, and shall be constructed so as not to chafe the rope.

3314.15.4 Combination. Two or more two-point adjustable suspended scaffolds shall not be combined into one by bridging the distance between them or by any other form of connection.

3314.15.5 Number of workers. Not more than two [~~workers~~] people shall be permitted [~~to work~~] on one scaffold at one time except where the scaffold is designed to hold more. Written permission from the commissioner shall be required for more than two [~~workers~~] people on the scaffold.

3314.15.6 Device to raise, lower, and hold the scaffold. Every two-point adjustable suspended scaffold shall be equipped with a device to raise, lower or hold the scaffold in position.

3314.15.7 Platforms. The platforms of every two-point adjustable suspended scaffold shall be ladder-type, plank-type, beam-type, light-metal type, or another type acceptable to the commissioner.

3314.16 Corner and angle scaffolds. Corner and angle scaffolds shall comply with the requirements of Sections 3314.16.1 through 3314.16.4.

3314.16.1 Motors. As many motors as needed shall be provided to maintain the stability of the platform under all operating conditions.

3314.16.2 Maximum number of people. The number of people allowed on a corner or angle scaffold shall not be more than the number of motors required to keep the scaffold stable, unless otherwise designed by a registered design professional.

3314.16.3 Additional information. In addition to the information required by Section 3314.3, corner and angle scaffolds shall also contain load capacity and distribution charts and a certification from the registered design professional that he/she has reviewed the manufacturer's design calculations and testing or prepared sufficient calculations of his/her own and found them to conform to this code.

3314.16.4 Inspection. The equipment setting for corner and angle scaffolds shall be inspected by the department prior to its use. Additional inspection by the department shall be required each time the equipment is moved to a different position.

3314.17 Multiple-point adjustable suspended scaffolds. Multiple-point adjustable suspended scaffolds shall comply with the following:

1. All multiple-point adjustable suspended scaffolds shall be supported by wire ropes. The use of fiber ropes is not permitted;
2. Provision shall be made to prevent supports from slipping off the ends of outrigger beams;
3. Platform bearers shall be of metal; and
4. During raising or lowering, the levels of the various sections of the scaffolds shall be kept uniform and the differential height between sections shall be minimized.

3314.18 Manually propelled, free-standing scaffolds. All manually propelled free-standing scaffolds shall meet the following requirements:

1. Work platforms shall be tightly planked for the full width of the scaffold, except for necessary entrance openings. Planks shall be secured in place;
2. Platforms shall have a guardrail system;
3. Where a ladder is used to approach a platform, the ladder shall be secured to the scaffold;
4. Handholds shall be provided for safe passage from the ladder to the platform;
5. Unless temporarily braced to an adjacent structure, the ratio of the platform height to the least base dimension shall be such as to ~~[assure]~~ ensure stability, but in no case shall such height be more than four times the least base dimension;
6. Provisions shall be made to prevent the scaffold from falling during movement from one location to another;
7. While the scaffold is in use, it shall rest upon a stable footing and shall stand plumb. The casters or wheels shall be locked in position; and
8. While the scaffold is being moved, no person shall be permitted to ride on it, and all tools, equipment and material shall be removed.

3314.19 Mast ~~[climber]~~ climbers. Mast climbers shall be designed, constructed, permitted, installed, adjusted, maintained, repaired, used, operated, inspected, and removed in accordance with rules promulgated by the commissioner.

3314.20 Public housing construction projects. No scaffolding permit issued for construction projects on public housing developments provided by the New York city housing authority shall be renewed unless the commissioner determines that such scaffolding is being used as part of an ongoing construction project. The commissioner shall promulgate such rules and regulations as shall be necessary to implement the provisions of this section.

An "ongoing" construction project" shall mean any construction project during which persons employed in construction work are utilizing such scaffolding at least two days per week, or have utilized such scaffolding for at least two days per week at any time over the course of the six months immediately preceding a request to renew a scaffolding permit.

§ 45. Section BC 3315 of the New York city building code, as amended by local law number 141 for the year 2013, is amended to read as follows:

SECTION BC 3315
STRUCTURAL RAMPS, RUNWAYS, AND PLATFORMS

3315.1 Ramps and runways. Ramps and runways (including elevated walkways) shall comply with the requirements of Sections 3315.1.1 through ~~3315.1.6~~ 3315.1.7, as well as rules promulgated by the commissioner.

3315.1.1 Construction. All runways and ramps shall be constructed, braced and supported to resist lateral displacement and all vertical loads, including impact.

3315.1.2 For motor vehicle use. Runways and ramps for the use of motor vehicles may consist of an earthfill or may be structurally supported. Such runways and ramps shall have a clear width of not less than 12 feet (3658 mm) with ~~timber~~ solid curbs or barriers at least 8 inches by 8 inches (203 mm by 203 mm) placed parallel to, and secured to, the sides of the runway or ramp. The flooring of structurally supported ramps shall consist of no smaller than 3-inch (76 mm) planking full size, undressed, or equivalent material, with spans designed for the loads to be imposed. Runways and ramps used by both motor vehicles and persons must also comply with requirements for runways and ramps used by persons. Runways and ramps dedicated exclusively to motor vehicles do not have to comply with requirements for runways and ramps used by persons.

3315.1.3 For use ~~of workers~~ by persons. Runways and ramps ~~[for the use of workers]~~ used by persons shall be at least ~~[1-foot-6-inches (457 mm)]~~ 2 feet (610 mm) in clear width. Where used for wheelbarrows, handcarts, or hand-trucks, runways and ramps shall be at least 3 feet (914 mm) in clear width. Flooring shall consist of at least 2-inch (51 mm) planking spanning as permitted by Table 3314.5.2, laid close, butt-joined and securely fastened.

3315.1.4 Slope limitations. Ramps shall have a slope not steeper than one in four. If the slope is steeper than one in eight, the ramp shall be provided with cleats spaced not more than 14 inches (356 mm) apart and securely fastened to the planking to afford a foothold. Spaces in the cleats may be provided for the passage of the wheels of vehicles. The total rise of a continuous ramp used by ~~[workers]~~ persons carrying material or using wheelbarrows, hand-carts, or hand-trucks shall not exceed 12 feet (3658 mm) unless broken by horizontal landings at least 4 feet (1219 mm) in length.

3315.1.5 Guardrail required. A guardrail meeting the requirements of ~~[Section]~~ Sections 3308.7.1 through [Section] 3308.7.7 shall be provided in any of the following circumstances:

1. ~~[On all edges of the runway or ramp that are located more than 5 feet (1524 mm) above the ground or floor; and]~~ Where an unprotected side or edge is 6 feet (1829 mm) or more above the ground, floor, or other lower level;
2. Along any portion of the runway or ramp that is used by persons and abuts motor vehicle traffic[-]; or
3. Along any portion of the runway or ramp where a person may thereby be exposed to harm from adjoining machinery, electrical equipment, or other hazardous equipment.

For the purposes of ~~[this section]~~ Section 3315.1.5, the term “floor” in Sections 3308.7.1 through 3308.7.7 shall mean “runway or ramp.”

3315.1.6 Netting required. Where it is possible for the public to pass under, or next to, runways or ramps, the space between the top rail and the toeboard shall be enclosed with a wire screen ~~[composed]~~ comprised of not less than ~~[No.]~~ number 18 ~~[steel wire gage]~~ gauge wire mesh, or equivalent synthetic netting that is flame retardant in accordance with NFPA 701, with openings in the wire or synthetic mesh no larger than ½ inch (13 mm) in the vertical or horizontal dimensions and ¾ inch (19 mm) in any other dimension.

3315.1.7 Signage required. At every access point to a runway or ramp, a sign shall be posted indicating whether the runway or ramp, or a portion thereof, is intended for use by motor vehicles or by persons.

3315.2 Platforms. Platforms shall comply with the requirements of Sections 3315.2.1 through 3315.2.3.

3315.2.1 Planking. Platforms ~~[used as working areas, or for the unloading of wheelbarrows, hand trucks, or carts]~~ shall have a floor consisting of at least 2-inch (51 mm) planking spanning as permitted by Table 3314.5.2. ~~[Platforms for the use of motor trucks shall have a floor of at least 3-inch (76 mm) planking, full size, undressed or equivalent materials with spans designed for the loads to be imposed.]~~ Planking shall be laid close and shall be butt-joined and securely fastened.

Exceptions:

1. Where the platform is to be used to support loads in excess of 75 psf (366.2 kg/m²), or is intended for a use as specified in rules promulgated by the commissioner, the platform shall be designed by a registered design professional.
2. Where the platform is to be used by motorized equipment, including but not limited to trucks, power buggies, fork lifts, or scissor lifts, the platform shall be designed by a registered design professional.

3315.2.2 Guardrail required. A guardrail meeting the requirements of ~~[Section]~~ Sections 3308.7.1 through [Section] 3308.7.7 shall be provided ~~[on all open sides of platforms located more than 5 feet (1524 mm) above the ground or floor.]~~ in any of the following circumstances:

1. Where an unprotected side or edge is 6 feet (1829 mm) or more above the ground, floor, or other lower level;
2. Along any portion of the runway or ramp that abuts motor vehicle traffic; or
3. Along any portion of the runway or ramp where a person may thereby be exposed to harm from adjoining machinery, electrical equipment, or other hazardous equipment.

For the purposes of ~~[this section]~~ Section 3315.2.2, the term “floor” in Sections 3308.7.1 through 3308.7.7 shall mean “platform.”

Exception: In lieu of a guardrail, the side of the platform used for the loading or unloading of vehicles may be protected by a ~~[timber]~~ solid curb or barrier at least 8 inches by 8 inches (203 mm by 203 mm) for motor trucks or 4 inches by 4 inches (102 mm by 102 mm) for wheelbarrows and hand-trucks.

3315.2.3 Netting required. Where it is possible for the public to pass under, or next to, platforms, the space between the top rail and the toeboard shall be enclosed with a wire screen ~~[composed]~~ comprised of not less than ~~[No.]~~ number 18 ~~[steel-wire-gage]~~ gauge wire mesh, or equivalent synthetic netting that is flame retardant in accordance with ~~[NFPA]~~ NFPA 701, with openings in the wire or synthetic mesh no larger than ½ inch (13 mm) in the vertical or horizontal dimensions and ¾ inch (19 mm) in any other dimension.

3315.3 Special requirements where ~~[power buggies are]~~ motorized equipment is used. Runways, ramps, platforms, and other surfaces upon which ~~[power buggies are]~~ motorized equipment, including but not limited to trucks, power buggies, fork lifts, or scissor lifts, is operated shall also meet the following minimum requirements:

~~[1. They shall be designed by a qualified person.]~~

~~[2. They shall be able to sustain, without failure, at least four times the maximum live load for which they are intended.]~~

~~[3.]~~ 1. The minimum width, inside of curbs or barriers, for any ramp, runway, or platform shall be 2 feet (610 mm) wider than the outside width of any ~~[power buggy]~~ motorized equipment operated thereon without passing, and 3 feet (914 mm) wider than twice such ~~[buggy]~~ motorized equipment width in the places where passing occurs.

~~[4.]~~ 2. All runways shall be essentially level transversely.

~~[5.]~~ 3. Curbs or barriers shall be furnished along all ~~[buggy]~~ motorized equipment traffic paths that are nearer than 10 feet (3048 mm) horizontally to any unenclosed area, shaft, or other open space into which or through which a fall of more than 12 inches (305 mm) from such surface is possible, except as set forth in numbered Item ~~[7]~~ 5.

~~[6.]~~ 4. Where curbs or barriers are not required because the ~~[buggy]~~ motorized equipment is operated on a surface ~~[not over]~~ up to 12 inches (305 mm) above another surface, the lower surface shall be strong enough to sustain the loaded vehicle in the event of a fall thereon.

~~[7.]~~ 5. Curbs or barriers may be omitted at actual dumping points more than 12 inches (305mm) above other surfaces if the edge over which dumping occurs is provided with bumpers or other means that will effectively stop the ~~[buggy]~~ motorized equipment from running over the edge while dumping.

~~[8.]~~ 6. Curbs or barriers must be at least 7 inches (178 mm) high, securely fastened, and capable of resisting side impact, and shall be equivalent to at least 2 inch by 8 inch (51 mm

by 203 mm) plank set on edge against uprights securely fastened and braced at not more than 4-foot (1219 mm) intervals.

§ 46. Section BC 3316 of the New York city building code, as added by local law number 33 for the year 2007, section 3316.9 as added by local law 141 for the year 2013, is amended to read as follows:

SECTION BC 3316
HOISTING EQUIPMENT AND MATERIAL HANDLING EQUIPMENT

3316.1 Scope. Hoisting equipment and material handling equipment shall meet and be used in accordance with the requirements of this section and rules promulgated by the commissioner. Material hoists and bucket hoists shall also meet the requirements of Section 3317, personnel hoists shall also meet the requirements of Section 3318, and cranes and derricks shall also meet the requirements of Section 3319. Certain material handling equipment listed in Section 3320 shall also meet the requirements of that section.

Exceptions: The requirements of this section, as well as Sections 3317 through 3320, shall not apply to:

1. Scaffolds. Scaffolds shall comply with the requirements of Section 3314. However, hoisting equipment utilized on scaffolds shall be subject to the requirements of this section.
2. Mast climbers. Mast climbers shall comply with rules promulgated by the commissioner. However, hoisting equipment utilized on mast climbers shall be subject to the requirements of this section.
3. Elevators. Elevators shall comply with the requirements of Chapter 30.
4. Hoisting equipment and material handling equipment, including but not limited to cranes or derricks, used in industrial or commercial plants or yards, other than those used for the construction or demolition of the facility.
5. Hoisting equipment and material handling equipment on ships or barges, including but not limited to floating cranes, floating derricks, and cranes and derricks used on floating equipment.
6. An automotive wrecker, tow truck, or mechanic's truck with a hoisting device when used to clear vehicular wrecks, haul vehicles, or used in activities related to the maintenance and repair of construction- or demolition-related vehicular equipment. However, this exception shall not apply to the use of such equipment to perform other tasks, including but not limited to hoisting earthwork equipment for the purpose of placing or extracting the earthwork equipment from an excavation.
7. Helicopters. Helicopter lifts shall require a permit from the fire department.

8. Tree trimming or tree removal equipment. However, this exception shall not apply to the use of hoisting equipment capable of lifting or lowering other loads, including but not limited to a crane utilized in conjunction with tree trimming or tree removal.

3316.2 Requirements. Hoisting equipment and material handling equipment, including [its] supports and runback structures, shall be installed, operated, used, and maintained to eliminate hazard to the public or to property. ~~[It shall be unlawful to operate any such equipment that is not provided with a positive means for preventing the unauthorized operation of such machine. The means whereby such machines may be made inoperative shall be accepted by the department.]~~

~~[3316.3 Notification of hoisting accidents. The owner or person directly in charge of any hoisting equipment shall immediately notify the commissioner following any accident involving hoisting equipment. Following an incident, no person shall permit either of the following, without the permission of the commissioner:~~

1. ~~Use of such hoisting equipment; or~~
2. ~~Removal of the hoisting equipment or any part thereof from the area of the job site.]~~

3316.3 Notification of incidents involving hoisting equipment or material handling equipment. The requirements of Section 3301.8 shall apply.

3316.3.1 Additional notification requirement for hoisting machines. In addition to the requirements of Section 3301.8, the operator of a hoisting machine shall immediately notify the department, in a form and manner acceptable to the commissioner, of any incident involving the use of the hoisting machine, or of any damage to adjoining property caused by the use of the hoisting machine.

3316.4 Permit for power operated hoisting equipment. ~~[Permits for hoisting equipment shall comply with the requirements of Sections 3316.4.1 through 3316.4.5.]~~ No power operated hoisting equipment, including supports and runback structures, shall be installed until the equipment user has obtained a permit in accordance with the requirements of Chapter 1 of Title 28 of the *Administrative Code*.

Exceptions:

1. A hoisting equipment permit is not required for equipment that is exempted from the requirements of Sections 3316.1 or 3319.1.
2. A hoisting equipment permit is not required for equipment, other than a crane, derrick, bucket hoist, material hoist, personnel hoist, or industrial rope access equipment, used exclusively to make deliveries to the site or service the site, and not used to perform construction or demolition work.
3. A hoisting equipment permit is not required for a power-operated, nonguided hoist with a maximum capacity of one ton or less and installed on new construction, or on alterations where the operation of the hoist is confined within the property and the site is protected in accordance with Section 3307.

4. A hoisting equipment permit issued under the provisions of this section is not required for cranes and derricks. Permits for cranes and derricks shall be in accordance with Section 3319.3.

~~[3316.4.1 Acceptance of equipment. Hoists and all premanufactured runback structures shall be approved for use by the commissioner or other agency acceptable to the commissioner.]~~

~~[Exception: Cranes and derricks shall meet the requirements of Section 3319.3.]~~

~~[3316.4.2 Posting of permits. Permits, or duplicates of the permits, shall be posted in a conspicuous location in the car or on the equipment.]~~

~~[3316.4.3 Construction documents. Copies of the written permit application and approved construction documents shall be kept at the site and made available to the commissioner upon request.]~~

~~[3316.4.4 Permit signage. Following the receipt of a permit to install a hoist, the permit holder shall post a sign that meets the requirements of Section 3301.9.6. Such sign shall be clearly visible from the street.]~~

~~[3316.4.5 Other temporary signage. Other than as specified in Section 3301.10, there shall be no information, pictorial representation, or any business or advertising messages posted on the hoisting equipment or runback structure.]~~

3316.5 Design, ~~construction~~ installation, and inspection. Hoisting equipment and material handling equipment, including [its] supports and runback structures, shall be designed, ~~constructed~~ installed, and inspected in accordance with the manufacturer's specifications, the requirements of this code, and rules promulgated by the commissioner. If there is a discrepancy, the stricter requirement shall be met.

3316.6 Rope inspection and replacement. All ropes used in hoisting equipment and material handling equipment shall meet the inspection and replacement requirements specified in the manufacturer's specifications, the requirements of this code, and rules promulgated by the commissioner. If there is a discrepancy, the stricter requirement shall be met.

3316.7 Operation. ~~[Only operators designated by the person causing such hoisting equipment to be used shall operate such hoisting machinery. Operators and signalmen/signalwomen shall be qualified for the operation they perform. The operator shall be responsible for making the machine inoperative before he or she leaves the machine.]~~ Hoisting equipment and material handling equipment, including supports and runback structures, shall be operated in accordance with the manufacturer's specifications, the requirements of this code, and rules promulgated by the commissioner. If there is a discrepancy, the stricter requirement shall be met.

~~[3316.7.1 Use. Hoisting equipment, its supports and runback structures shall be operated in compliance with the manufacturing specifications, the requirements of this code, and rules promulgated by the commissioner. If there is a discrepancy, the stricter requirement shall be met.]~~

3316.7.1 Operators and signalpersons. Operators and signalpersons shall be qualified for the operation they perform. Only operators designated by the equipment user shall operate hoisting equipment and material handling equipment. Operators of hoisting machines shall be licensed where required by Article 405 of Title 28 of the *Administrative Code*. Signalpersons shall be trained or certified where required by Section 3316.9.2 of this code. Operators of hoisting equipment and material handling equipment shall familiarize themselves with manufacturer specifications and applicable plans for the hoisting equipment prior to operating the hoisting equipment at the site and whenever such specifications or plans are revised or amended.

3316.7.2 Use during installation, jumping, dismantling or alteration. Personnel and building materials connected with or related to the building project shall not be moved by the ~~hoist~~ hoisting equipment or material handling equipment while ~~it~~ such equipment is being installed, jumped, dismantled, or altered.

3316.7.3 Preventing unauthorized operation. It shall be unlawful to operate any hoisting equipment or material handling equipment that is not provided with a positive means for preventing the unauthorized operation of such equipment. The means whereby the equipment may be made inoperative shall be acceptable to the department.

3316.7.4 Securing equipment. The operator of the hoisting equipment or material handling equipment shall park and secure the equipment at the end of the shift and as weather or site conditions otherwise warrant. The operator of the hoisting equipment or material handling equipment shall make the equipment inoperative before leaving the equipment.

3316.7.5 Loading. Loading of hoisting equipment and material handling equipment shall be conducted in accordance with the following requirements:

1. The equipment shall not be loaded in excess of the rated load specified by the manufacturer. When necessary, allowable loads shall be reduced to take into account effects of wind, ground condition, and operating speed.
2. Rated load capacities shall be conspicuously posted or displayed on the equipment. Load charts shall be accessible to the operator at all times and to the commissioner upon request.
3. All loads shall be properly trimmed and secured to prevent the dislodgment of any part during raising, lowering, swinging or transit.
4. Suspended loads shall be securely slung and properly balanced before they are set in motion.
5. The operator shall ascertain the weight of the load prior to lifting or lowering the load.

3316.7.6 Refueling. Refueling of hoisting equipment and material handling equipment shall be conducted in accordance with the following requirements:

1. The engine shall be stopped during refueling, except as otherwise provided in rules promulgated by the commissioner.

2. Open lights, flames, or spark-producing devices shall be kept at a safe distance while refueling an internal combustion engine.
3. No person shall smoke or carry lighted smoking material in the immediate vicinity of the refueling area.
4. “No smoking” signs shall be conspicuously posted in all fueling or fuel storage areas.
5. Fuel shall be kept in containers that meet the requirements of the New York City Fire Department.
6. All other requirements of the New York City Fire Department and the New York City Department of Environmental Protection shall be satisfied.

3316.7.7 Work area control. The equipment user shall provide and maintain measures, including but not limited to warning signs, barriers, or flagpersons, to prevent the public from coming into contact with or passing under hoisting equipment or material handling equipment.

Exception: For cranes or derricks, the work area shall be controlled in accordance with rules promulgated by the commissioner.

3316.7.8 Wind and weather. Hoisting equipment located on the roof or setback of a building, exterior to a building or structure, on a working deck, or in an area with an unenclosed perimeter, is subject to the following wind and weather restrictions.

Exception: Cranes and derricks shall not be subject to the requirements of this section. Wind and weather restrictions for cranes and derricks shall be in accordance with the requirements of Section 3319.13 and rules promulgated by the commissioner.

3316.7.8.1 Start of work. No operator of hoisting equipment shall start a pick when:

1. The wind speed exceeds 30 mph (3-second gust), the threshold specified by the manufacturer of the hoisting equipment, or the threshold indicated on plans, whichever is lower; or
2. As otherwise warranted by weather conditions or weather forecasts.

3316.7.8.2 In-service. During picks it is the responsibility of the operator of the hoisting equipment to safely bring the pick to a stop and safely land the load when:

1. The wind speed exceeds 30 mph (3-second gust), the threshold specified by the manufacturer of the hoisting equipment, or the threshold indicated on plans, whichever is lower; or
2. As otherwise warranted by weather conditions or weather forecasts.

3316.7.8.3 Out-of-service. At the end of the shift, or as weather conditions otherwise warrant, the operator of the hoisting equipment must properly park or secure the hoisting equipment

for occurring or forecasted winds in accordance with the specifications of the manufacturer of the hoisting equipment and applicable plans.

3316.7.8.4 Assembly/disassembly. The assembly/disassembly of hoisting equipment, including but not limited to the installation, jumping, or dismantling of the hoisting equipment, shall not begin when:

1. The wind speed exceeds 30 mph (3-second gust), the threshold specified by the manufacturer of the hoisting equipment to be assembled/disassembled, the threshold specified by the manufacturer of the assist equipment, or the threshold indicated on plans, whichever is lower;
2. The wind speed is forecast to exceed 30 mph (3-second gust), the threshold specified by the manufacturer of the hoisting equipment to be assembled/disassembled, the threshold specified by the manufacturer of the assist equipment, or the threshold indicated on plans, whichever is lower, before the assembly/disassembly operation can be safely completed and the hoisting equipment and all assist equipment can be parked and secured; or
3. As otherwise warranted by weather conditions or weather forecasts.

3316.7.8.5 Determining wind speed. Wind speed shall be determined based on data from the nearest United States weather bureau reporting station, or an anemometer located at the site, freely exposed to the wind, and calibrated in accordance with ASTM D5096-02.

Exception: For cranes and derricks, the requirements of Section 3319.13 shall apply.

3316.7.8.6 Assist equipment. The requirements of Sections 3316.7.8.1 through 3316.7.8.5 shall also apply to assist equipment utilized in conjunction with the assembly/disassembly of hoisting equipment.

3316.8 Maintenance and repair. Hoisting equipment and material handling equipment, including [its] supports and runback structures, shall be maintained and repaired in compliance with the [manufacturing] manufacturer's specifications, the requirements of this code, and rules promulgated by the commissioner. If there is a discrepancy, the stricter requirement shall be met.

3316.9 Rigging. The [~~attachment and detachment of articles from hoisting equipment used to hoist or lower articles~~] hoisting or lowering of any suspended article on the outside of [a] any building in the city shall be performed in accordance with the requirements of Sections 3316.9.1 through 3316.9.3.

3316.9.1 Supervision. The hoisting or lowering of any suspended article on the outside of any building in the city shall be performed by or under the direct and continuing supervision of a licensed rigger.

Exceptions:

1. In lieu of a licensed rigger, the hoisting or lowering of a sign may be performed by or under the direct and continuing supervision of a licensed sign hanger.

2. Suspended scaffold operations shall meet the requirements of Section 3314.
3. In lieu of a licensed rigger, the hoisting or lowering of [~~articles~~] any suspended article on the outside of [~~a~~] any building in the city may be performed by or under the supervision of a competent person designated by the contractor using the equipment provided the following conditions are met:
 - 3.1 The hoisting or lowering occurs in conjunction with:
 - 3.1.1 The construction of a new building;
 - 3.1.2 The full demolition of an existing building;
 - 3.1.3 The vertical or horizontal enlargement of an existing building; or
 - 3.1.4 The alteration, maintenance, or repair of a façade of a major building where a site safety plan is required by Section 3310.3.
 - 3.2 All individuals involved in the work are certified or trained in accordance with Section 3316.9.2, where such certification or training is required;
 - 3.3 The hoisting or lowering does not meet the definition of industrial rope access;
 - 3.4 The article being hoisted or lowered is not a boiler or tank;
 - 3.5 The article being hoisted or lowered is not related to the assembly, jumping, or disassembly of a tower [~~or climber~~] crane; and
 - 3.6 Where the hoisting or lowering operation meets the definition of a critical pick, such critical pick is:
 - 3.6.1 Performed in accordance with a plan developed by either a:
 - 3.6.1.1 Licensed master rigger; or
 - 3.6.1.2 Registered design professional who has demonstrated knowledge or experience with safe loads and computation thereof, types of rigging, size and strength of ropes, cables, blocks, and any other rigging equipment to be used during the critical pick; and
 - 3.6.2 Immediately prior to the pick, onsite verification is made to ensure conformance with the plan by either:
 - 3.6.2.1 The licensed master rigger who developed the plan;
 - 3.6.2.2 The registered design professional who developed the plan; or

3.6.2.3 A registered design professional employed by and working under the direct supervision of the registered design professional who developed the plan.

4. Where the hoisting or lowering is performed under the direct and continuing supervision of a licensed rigger, a specialty crew who is not in the direct employ of the licensee or business of the licensee may be utilized, provided:
 - 4.1 The work requires a specialty trade, including but not limited to work with hazardous materials or chemicals;
 - 4.2 The crew is in accordance with rules promulgated by the commissioner; and
 - 4.3 The members of the crew are approved by the commissioner.

3316.9.1.1 Supervisor. The individual supervising the hoisting or lowering in accordance with Section 3316.9.1 shall:

1. Be present at the site during all times articles are being [~~attached or detached~~] rigged for hoisting or lowering or are being hoisted or lowered;
2. Have the ability to communicate with all individuals involved with such work; and
3. Be in the line of sight of either the:
 - 3.1 Attaching operation;
 - 3.2 Detaching operation, or
 - 3.3 The hoisting equipment.

3316.9.2 Certification or training. All [~~individuals who attach or detach articles from the hook of hoisting equipment in conjunction with~~] members of the rigging crew engaged in the hoisting or lowering of [an] any suspended article on the outside of [a] any building in the city, the supervisor of such individuals, and signalpersons communicating with such individuals, shall[~~eighteen months after the effective date of this section,~~] either:

1. Possess a valid certification for both rigging and signaling. The certification shall be [from an organization] acceptable to the commissioner and issued by a rigging and signaling certification program that is accredited by the National Commission for Certifying Agencies (NCCA) or the American National Standards Institute (ANSI). The certification shall be valid for a term of no more than five years before it has to be renewed and shall cover areas including, but not limited to, the inspection and use of rigging hardware, basic rigging techniques, signaling, and hazards associated with rigging. The certification for a supervisor shall, in addition to the foregoing, include calculations and problem solving with respect to rigging; or
2. Have completed an initial department-approved training course, and four years following the completion of the initial training course, and every four years thereafter, complete a

department-approved refresher course. The courses shall be in accordance with the following:

- 2.1 The initial training course for [~~individuals who attach or detach articles from the hook of hoisting equipment and~~] members of the rigging crew, including signalpersons communicating with such crew, shall be, at a minimum, 16 hours long, with the refresher course, at a minimum, 8 hours long. The initial training course for a supervisor shall be, at a minimum, 32 hours long, with the refresher course, at a minimum, 16 hours long.
- 2.2 The training course shall be conducted by a registered New York State Department of Labor apprenticeship training program or by an educational institution or school chartered, licensed or registered by the New York State Department of Education or by a provider approved by the department and presented by an instructor acceptable to the commissioner.
- 2.3 Training courses and refresher courses shall cover areas including, but not limited to, the inspection and use of rigging hardware, basic rigging techniques, signaling, and hazards associated with rigging. The training course and refresher course for a supervisor shall, in addition to the foregoing, include calculations and problem solving with respect to rigging. The training course and refresher course, both for crew members and supervisors, shall include a significant portion of hands on training.
- 2.4 Successful completion of the initial training course and refresher course shall be based upon passage of a written and a practical exam.
- 2.5 Successful completion of the initial training course and refresher course shall be evidenced by a wallet size certificate card issued by the training provider and acceptable to the commissioner. Such certificate card shall be readily available to the commissioner upon request and shall contain, at a minimum, the following information:
 - 2.5.1 The name of the individual to whom it was issued;
 - 2.5.2 A photograph of the individual to whom it was issued; and
 - 2.5.3 Any other information required pursuant to rules promulgated by the commissioner for a department approved training course.
- 2.6 For individuals who fail to complete the required refresher course within any 4 year period, a refresher course shall be considered timely if completed within 1 year after the expiration date of the last previously completed initial or refresher course. During such period, such individual shall not perform or supervise any activity for which the lapsed training is required to perform or supervise such activity until such individual has successfully completed such refresher course. Where more than 1 year has lapsed, such individual shall be required to successfully recomplete the initial training course.

Exceptions: Training or certification is not required for:

1. Individuals working under the direct and continuing supervision of a licensed rigger or sign hanger.
2. The loading or unloading of a material delivery truck provided the material is loaded or unloaded only between the ground and the truck, or vice versa, and also provided that the material is not raised more than 12 feet (3658 mm) above the bed of the truck during the loading or unloading process.
3. The use of hoisting equipment that has a manufacturer's rated capacity of 2,000 pounds (907 kg) or less.
4. The use of equipment that is exempted from the requirements of Section 3316.1 or Section 3319.1 of the building code.
5. The use of industrial rope access equipment, which shall instead meet the requirements of Section 3316.9.3.

3316.9.3 Industrial rope access. Any person using industrial rope access methods to descend or ascend outside a building, including the individual supervising such, must be certified by either the Society of Professional Rope Access Technicians ("SPRAT") or the Industrial Rope Access Trade Association ("IRATA"), or an equivalent acceptable to the department. Only hand tools, securely attached to a person, may be carried by such person during the use of industrial rope access methods. Any other tools or equipment must be separately hoisted or lowered.

3316.10 Special provisions for cableways. The construction, installation, inspection, maintenance, and use of cableways shall be in accordance with rules promulgated by the commissioner.

§ 47. Section BC 3317 of the New York city building code, as added by local law number 33 for the year 2007, is amended to read as follows:

SECTION BC 3317 MATERIAL HOISTS AND BUCKET HOISTS

3317.1 Scope. Material hoists and bucket hoists shall meet and be used in accordance with the requirements of this section, ~~and~~ Section 3316, and rules promulgated by the commissioner.

Exception: Equipment that is exempted from the requirements of Section 3316.1.

~~[**3317.2 Permit.** The equipment user or his or her designated representative shall obtain a written permit issued by the commissioner on the basis of construction documents, drawings and specifications prior to erecting or installing all power-operated, material hoists, including any runback structure or supports.]~~

~~[**Exception:** Power-operated, nonguided material hoists with a maximum capacity of one ton or less and installed on new construction, or on alterations where the operation of the hoist is confined within the property and the site is protected in accordance with Section 3307.]~~

3317.2 Permit. Material hoists and bucket hoists shall require a permit in accordance with Section 3316.4.

3317.3 Design~~[,]~~ and inspection [~~and operation~~]. Material hoists, bucket hoists and their components shall be designed~~[,]~~ and inspected~~[, and operated]~~ in accordance with rules promulgated by the commissioner.

3317.4 Construction. Material hoists, bucket hoists and their components shall be constructed in compliance with the manufacturing specifications, the requirements of this code, and rules promulgated by the commissioner. If there is a discrepancy, the stricter requirement shall be met.

Upon completion of the installation of the hoisting equipment and/or its runback structure, an inspection report verifying that the hoist has been installed in accordance with the design drawings, construction documents and specifications shall be prepared by the designer, installer or an approved inspection agency designated by both the designer and installer.

3317.5 Operation. Notwithstanding any other provision of law, material hoists with a manufacturer's capacity over one ton shall be operated only by persons holding a Class A or B hoisting machine operators license except during installation, jumping, dismantling or alteration operations.

3317.6 Making safety devices inoperative. No person shall at any time make any required safety device or electrical protective device inoperative except when necessary during tests, inspections, and maintenance.

Immediately upon completion of the tests, inspections, and maintenance, such devices shall be restored to their normal operating condition in conformance with the applicable requirements of this section.

§ 48. Section BC 3318 of the New York city building code, as added by local law number 33 for the year 2007, is amended to read as follows:

SECTION BC 3318 PERSONNEL HOISTS

3318.1 Scope. Personnel hoists shall meet and be used in accordance with the requirements of this section, ~~[and]~~ Section 3316, and rules promulgated by the commissioner.

Exception: Equipment that is exempted from the requirements of Section 3316.1.

3318.2 Permit. ~~[The equipment user or his or her designated representative shall obtain a written permit issued by the commissioner on the basis of construction documents, drawings and specifications prior to erecting or installing all power operated, material hoists, including any runback structure or supports.]~~ Personnel hoists shall require a permit in accordance with Section 3316.4.

3318.3 Design and inspection. Personnel hoists and their components shall be designed and inspected in accordance with rules promulgated by the commissioner.

3318.4 Construction. Personnel hoists and their components shall be constructed in compliance with the manufacturer's specifications, this code, and rules promulgated by the commissioner. If there is a discrepancy, the stricter requirement shall be met.

Upon completion of the installation of the hoisting equipment and/or its runback structure, an inspection report verifying that the hoist has been installed in accordance with the design drawings, construction documents and specifications shall be prepared by the designer, installer or third-party designated by both the designer and installer and acceptable to the commissioner.

3318.5 Operation. Personnel hoists and their components shall be operated in accordance with this code and rules promulgated by the commissioner.

When the hoist is equipped with manual controls, the hoist shall be operated by a [competent] qualified operator. Only the operator authorized by the equipment user shall operate the hoist.

~~[3318.5.1]~~ **3318.6 Making safety devices inoperative.** No person shall at any time make any required safety device or electrical protective device inoperative except when necessary during tests, inspections and maintenance.

Immediately upon completion of the tests, inspections and maintenance, such devices shall be restored to their normal operating condition in conformance with the applicable requirements of this section.

§ 49. Section BC 3319 of the New York city building code, as added by local law number 33 for the year 2007, section 3319.8 as added by local law number 46 for the year 2008, section 3319.2, item 9 of section 3319.8.1, items 1 and 4 of section 3319.8.8, and sections 3319.8.2 and 3319.8.3 as amended by local law 14 for the year 2018, section 3319.9 as added by local law number 45 for the year 2008, section 3319.10 as added by local law number 44 for the year 2008, section 3319.11 as added by local law number 77 for the year 2017, section 3319.12 as added by local law number 79 for the year 2017 and renumbered by local law number 13 for the year 2018, a section 3319.13 as added by local law number 3 for the year 2018, a section 3319.13 as added by local law number 13 for the year 2018, is amended to read as follows:

SECTION BC 3319 CRANES AND DERRICKS

3319.1 Scope. ~~[The construction, installation, inspection, maintenance and use of cranes and derricks shall be in conformance with the requirements of this section, Section 3316, and with rules promulgated by the commissioner.]~~ Cranes and derricks shall meet and be used in accordance with the requirements of this section, Section 3316, and rules promulgated by the commissioner.

Exceptions: The requirements of this section shall not apply to:

1. Equipment that is exempted from the requirements of Section 3316.1.
2. Material delivery trucks when used to load and unload material, provided such material is loaded or unloaded only between the ground and the truck, or vice versa, and also provided that the material is not raised more than 12 feet (3658 mm) above the bed of the truck during the loading or unloading process.
3. Excavation or earth-moving equipment, including but not limited to power shovels, excavators, wheel loaders, backhoes, loader backhoes, and truck loaders. However, this exception shall not apply when such equipment is used to lift or lower a suspended load more than 12 feet (3658 mm) above the level of the ground. This exception further shall not apply to equipment designed primarily to lift or lower a suspended load, including but not limited to a mobile crane with a clamshell.
4. Excavation or earth-moving equipment equipped with a pile driving attachment. However, this exception shall not apply when such equipment is configured to lift or lower a suspended load not related to the pile driving operation. This exception further shall not apply to dedicated pile drivers, nor shall it apply to equipment designed primarily to lift or lower a suspended load, including but not limited to a mobile crane with a pile driving attachment.
5. Drilling equipment, including but not limited to augers, churn-drills, dedicated drilling rigs, and excavators equipped with a drilling attachment. However, this exception shall not apply when such equipment is configured to lift or lower a suspended load not related to the drilling operation. This exception further shall not apply to equipment designed primarily to lift or lower a suspended load, including but not limited to a mobile crane with a drilling attachment.
6. Digger derricks used in conjunction with the installation, alteration, maintenance, or removal of electric or telecommunication transmission/distribution lines and associated equipment.
7. Demolition equipment, including but not limited to vertical concrete chippers and high reach demolition equipment. However, this exception shall not apply when such equipment is configured to lift or lower a suspended load. This exception further shall not apply to equipment designed primarily to lift or lower a suspended load, including but not limited to a crane assisting with demolition operations.
8. Powered industrial trucks (forklifts). However, this exception shall not apply when such equipment is used to lift or lower a suspended load.
9. Aerial work platforms, including but not limited to vehicle-mounted aerial devices for lifting personnel, and self-propelled elevating work platforms. However, this exception shall not apply when such equipment is configured to both lift or lower a suspended load and function as an aerial work platform. This exception further shall not apply to

equipment designed primarily to lift or lower a suspended load, including but not limited to a mobile crane equipped with a manbasket.

10. Concrete pumping equipment not capable of lifting or lowering any suspended loads.

11. Machinery that hoists by using a come-a-long or chainfall.

12. Roustabouts.

3319.2 Personnel. Personnel shall comply with Sections 3319.2.1 through 3319.2.3.

3319.2.1 Hoisting machine operators. The hoisting machine operator shall be licensed as required by Chapter 4 of Title 28 of the [~~Administrative Code~~] Administrative Code.

3319.2.2 Riggers. Rigging work must be supervised in accordance with Section 3316.9.1 and where required, riggers must be licensed in accordance with Chapter 4 of Title 28 of the [~~Administrative Code~~] Administrative Code.

3319.2.3 Lift directors. Lift directors shall be designated, and perform the duties assigned to them, in accordance with rules promulgated by the commissioner. Such duties shall include, but not be limited to, ensuring compliance with approved plans, traffic and pedestrian controls, and weather restrictions.

~~[3319.3 Requirements. No owner or other person shall authorize or permit the operation of any crane or derrick without a certificate of approval, a Certificate of Operation and a Certificate of On-site Inspection.]~~

[Exceptions:

- ~~1. The requirements of this section shall not apply to excavating or earth-moving equipment, except cranes used with clamshells.~~
- ~~2. The requirements of this section shall not apply to cranes or derricks performing an emergency use pursuant to the lawful order of the head of any department.~~
- ~~3. The requirements of this section shall not apply to mobile cranes, including jibs and any other extensions to the boom not exceeding 50 feet (15 240 mm) in length and with a manufacturer's rated capacity of 3 tons (2722 kg) or less.~~
- ~~4. The requirements of this section shall not apply to mobile cranes, including jibs and any other extensions, exceeding 50 feet (15 240 mm) but not exceeding 135 feet (41 148 mm) in length, and with a manufacturer's rated capacity of 3 tons (2722 kg) or less, except that a Certificate of Operation, as provided for in Section 3319.5, shall be required. The requirement for a Certificate of Operation shall not apply to such a crane used exclusively as a man basket. The commissioner may, by rule, exempt other mobile cranes of limited size from any or all requirements of this section.~~
- ~~5. The requirements of this section shall not apply to hoisting machines permanently mounted on the bed of material delivery trucks that are used exclusively for loading and~~

~~unloading such trucks, provided that the length of boom does not exceed the length of the truck bed by more than 5 feet (1524 mm) and that any material transported thereon shall not be raised more than 2 feet (610mm) in the unloading process. Operators of such equipment shall be exempt from licensing requirements described in Chapter 4 of Title 28 of the *Administrative Code*.~~

- ~~6. The requirements of this section shall not apply to cranes or derricks used in industrial or commercial plants or yards not used for the construction of the facility. Floating cranes, floating derricks, and cranes and derricks used on floating equipment shall also be exempt from the requirements of this section. Operators of such equipment shall be exempt from the licensing requirements described in Chapter 4 of Title 28 of the *Administrative Code*.~~
- ~~7. The requirements of this section shall not apply to augurs, churn drills and other drilling equipment not used for hoisting any objects. Operators of such equipment shall be exempt from the licensing requirements described in Chapter 4 of Title 28 of the *Administrative Code*.~~
- ~~8. The requirements of this section shall not apply to derricks having a maximum rated capacity not exceeding 1 ton (907 kg).~~
- ~~9. The requirements of this section shall not apply to mechanic's truck with a hoisting device when used in activities related to the maintenance and repair of construction-related equipment.~~
- ~~10. The requirements of this section shall not apply to articulating boom cranes that do not have an integral hoisting mechanism, and that are used exclusively for loading and unloading of trucks or trailers, provided that the length of boom does not exceed 135 feet (41 148 mm) and that any material transported thereon shall not be raised more than 100 feet (30 480 mm) in the unloading process. Operators of such equipment shall be exempt from licensing requirements described in Chapter 4 of Title 28 of the *Administrative Code*.]~~

3319.3 Certificates required. No owner, equipment user, or other person shall authorize or permit the use or operation of a crane or derrick that does not possess and/or is not in conformance with a certificate of approval, certificate of operation, and certificate of on-site inspection. The certificates are valid only if the conditions and statements contained in the approved application are complied with, and the crane or derrick is used or operated in conformance with the provisions of this code and the rules applicable thereto.

Exceptions: The requirement for a certificate of approval, certificate of operation, and a certificate of on-site inspection shall not apply to the following:

1. Cranes or derricks performing an emergency use pursuant to the lawful order of the head of any department.
2. Cranes or derricks with a manufacturer's rated capacity of 1 ton (907 kg) or less.

3. Mobile cranes, including jibs and any other extensions to the boom, not exceeding 50 feet (15 240 mm) in length and with a manufacturer's rated capacity of 3 tons (2722 kg) or less.
4. Mobile cranes, including jibs and any other extensions to the boom, exceeding 50 feet (15 240 mm) but not exceeding 135 feet (41 148 mm) in length, and with a manufacturer's rated capacity of 3 tons (2722 kg) or less, except that a certificate of operation, as provided for in Section 3319.5, shall be required.
5. Mobile cranes of a limited size and capacity, or performing a limited use, and exempted from the requirements for a certificate of approval, certificate of operation, or a certificate of on-site inspection in accordance with rules promulgated by the commissioner.

3319.4 Certificate of ~~[Approval]~~ approval. Certificates of ~~[Approval]~~ approval shall comply with the following:

1. The manufacturer~~[-]~~ or owner, or a designated representative of the manufacturer or owner, of a crane or derrick for which a ~~[Certificate of Approval]~~ certificate of approval is sought, or for which an existing certificate of approval is to be amended, shall file an application for such ~~[Certificate of Approval]~~ certificate of approval or amendment, and provide such information as set forth in rules promulgated by the commissioner.
2. Upon the department's approval of the application described in Item 1 above, the department shall issue a ~~[Certificate of Approval]~~ certificate of approval for the equipment ~~[and an approval of the submitted load rating chart]~~. The manuals, load rating charts, and other information submitted with the application are considered part of the certificate of approval.
3. ~~[A new Certificate of Approval shall be required when a crane or derrick is modified or altered to increase the boom length, jibs or any extensions to the boom beyond the maximum approval length or when the load ratings are increased.]~~ The certificate of approval shall be required to be amended when a crane or derrick is modified or altered to:
 - 3.1 Increase the boom length, jibs, or any extensions to the boom beyond the maximum approval length;
 - 3.2 Increase the load ratings beyond the maximum approval; or
 - 3.3 As otherwise specified in accordance with rules promulgated by the commissioner.

3319.5 Certificate of ~~[Operation]~~ operation. Certificates of ~~[Operation]~~ operation shall comply with the following:

- ~~[1. The commissioner shall issue the initial Certificate of Operations for the crane or derrick with Certificate of Approval upon satisfactory inspection and test indicating that such crane or derrick is in a safe operating condition. The initial Certificate of Operations shall expire 1 year from the date of issuance.]~~
- ~~[2. The owner of a crane or derrick covered by the Certificate of Operations shall renew the Certificate of Operations each year.]~~

~~[3. If the owner of the covered crane or derrick applies for renewal of a certificate of operation within not more than 60 nor less than 30 days prior to the date of its expiration, such owner may continue to use the covered crane or derrick until the department grants or denies a new certificate.]~~

~~[4. When a crane or derrick configuration is changed to increase the boom length, jibs or any extensions to the boom beyond the maximum approval length or when the load ratings are increased, a new Certificate of Operations shall be required. In such a case, the crane or derrick may not be operated until the new Certificate of Operations is obtained.]~~

~~[5. An application for a new certificate of operation shall be submitted when attachments that affect the stability or structure of the crane or derrick are added. Calculations and load rating charts as required by rules promulgated by the commissioner shall be submitted with the renewal request.]~~

1. The owner, or his or her designated representative, of a crane or derrick for which an initial certificate of operation is sought, or for which an existing certificate of operation is intended to be amended or renewed, shall file an application for such certificate of operation and provide such information as set forth in rules promulgated by the commissioner.

2. The commissioner shall issue, renew, or amend a certificate of operation upon satisfactory inspection and testing indicating that such crane or derrick is in a safe operating condition.

3. A certificate of operation shall be valid for a period of one year; except that:

3.1 For a crane or derrick meeting conditions established in accordance with rules promulgated by the commissioner, the certificate of operation shall expire at the end of the job.

3.2 For a crane or derrick which possesses a certificate of operation that expires annually, the owner of the crane or derrick may continue to use the crane or derrick until the department renews or denies the certificate of operation, provided the owner applied to renew the certificate of operation within not more than 60 nor less than 30 days prior to the date of its expiration.

4. The renewal fee for the certificate of operation shall be charged annually, except for a crane or derrick meeting conditions established in accordance with rules promulgated by the commissioner, the fee shall be charged at intervals prescribed in the rule.

5. When a component, as defined in rules promulgated by the commissioner, is replaced or added to the crane or derrick, the certificate of operation shall be amended to reflect such change.

6. A certificate of operation is also required to be amended when otherwise specified in rules promulgated by the commissioner.

7. No crane or derrick subject to one or more of the conditions listed in items 5 or 6 above shall operate until an amended certificate of operation has been issued by the department.

3319.6 Certificate of ~~[On-site Inspection]~~ on-site inspection. Certificates of on-site inspection shall comply with the following:

- ~~[1. The equipment user, or his or her designated representative, shall obtain a Certificate of On-site Inspection for the use of any crane or derrick used for construction or demolition purposes at each job site. Such application for the Certificate of On-site Inspection shall include information set forth in rules promulgated by the commissioner.]~~
- ~~[2. Upon approval of the application, a copy of such approval shall be given to the applicant. It shall be unlawful to operate the equipment that is the subject of the approval until it has been inspected and found to be satisfactory by the department as set forth in rules promulgated by the commissioner. Upon inspection and a finding of satisfactory compliance, the approval shall be deemed a Certificate of On-site Inspection, which shall expire one year from the date of issuance. A Certificate of On-site Inspection may be renewed in accordance with rules promulgated by the commissioner.]~~
- ~~[3. The Certificate of On-site Inspection is valid only if the conditions and statements contained in the approved application are complied with, and the crane or derrick is operated in conformance with the provisions of this section and the rules applicable thereto.]~~
- ~~[4. A Certificate of On-site Inspection is not required for cranes or derricks performing work exempted from such requirement by rules promulgated by the commissioner.]~~

1. An engineer, designated by the equipment user of a crane or derrick for which an initial certificate of on-site inspection is sought, or for which an existing certificate of on-site inspection is intended to be amended or renewed, shall file an application for such certificate of on-site inspection and provide such information as set forth in rules promulgated by the commissioner.
2. The commissioner shall issue, renew, or amend a certificate of on-site inspection upon satisfactory inspection and testing indicating that such crane or derrick is configured and located in accordance with the approved application.
3. A certificate of on-site inspection shall be valid for a period of one year, or until the end of the job, whichever is less.

3319.7 Temporary certificates. The commissioner may issue temporary ~~[Certificates of Approval]~~ certificates of approval, operation, ~~[and]~~ or on-site inspection for any crane or derrick during the pendency of an application for ~~[Certificates of Approval and operation upon inspection and upon such]~~ the certificate and upon inspection, analysis, and testing as the commissioner may deem necessary. The commissioner may place appropriate restrictions on a crane or derrick operating under a temporary certificate, and may revoke such temporary certificates if the underlying application is denied.

3319.8 Special provisions for tower ~~[and climber]~~ cranes. Tower ~~[and climber]~~ cranes shall comply with the ~~[following]~~ requirements of Sections 3319.8.1 through 3319.8.8.

Exceptions: The requirements of Sections 3319.8.1 through 3319.8.8 shall not apply to:

1. The installation of a tower crane foundation, anchor stool, and first mast section, provided such installations are in accordance with rules promulgated by the commissioner.
2. The assembly or disassembly of a self-erecting tower crane, provided the assembly/disassembly proceeds in accordance with rules promulgated by the commissioner.

3319.8.1 Plan for the erection, jumping, [climbing,] and dismantling of tower [or climber] cranes. An erection, jumping, [climbing] and dismantling plan for tower [or climber] cranes, other than truck and crawler mounted tower cranes, shall be submitted to the department by a licensed engineer. The plan must be prepared by a licensed engineer in conjunction with a licensed rigger and must be in compliance with the manufacturer's recommendation for erection, jumping, [climbing,] or dismantling of the specific crane where such manufacturer's recommendations exist. The plan must be filed with the certificate of on-site inspection application as required by Section 3319.3. No erection, jumping, [climbing,] or dismantling of a tower [or climber] crane shall take place without the prior issuance of a certificate of on-site inspection by the cranes and derricks unit. The plan shall include the following:

1. Identification of the equipment proposed to be used[;], including all machines proposed to be used in the erection or dismantling;
2. A detailed identification of the assemblies and components required for the erection and dismantling of the equipment;
3. Location of the equipment, sidewalk sheds (or Department of Transportation street closing permits, if applicable), surrounding buildings, protection for their roofs and the pick-up points, loads, and radius of swing of all loads. In addition, the safe load from the approved load radius chart shall be submitted for lift radius;
4. A weight list of all assemblies and components proposed to be lifted. Components are to be clearly marked with their weight painted on the assembly or stamped on metal tags attached to the assembly. The manufacturer of the [climber or] tower crane shall certify the weight of assemblies and components. Alternately, in lieu of painted weight markings or metal tags, or when the manufacturer's certification is not available, the licensed engineer applicant shall certify an erection, jumping, [climbing] or dismantling weight list indicating how such weights were determined;
5. The center of gravity of all asymmetrical components shall be located and shown;
6. A sequence of operation detailing the erection, jumping, [climbing,] and dismantling, along with the rigging materials to be used in such operations;
7. The certification of the calibration as required in Item 6 of Section 3319.8.8; and
8. Cranes or derricks located either within the lot line or on the street and used to erect, jump, [climb,] or dismantle a tower [or climber] crane shall be indicated[;].

[9. ~~The names and contact information of the licensed master, climber or tower crane rigger, and the rigger foreman, along with the name and contact information of the company performing the erection, dismantling, climbing and/or jumping work.~~]

3319.8.2 Safety coordination meeting. The ~~[general contractor]~~ equipment user must hold a safety coordination meeting prior to the initial erection, as well as the dismantling or initial jump down, of a ~~[climber or]~~ tower crane. No work related to the erection, ~~[climbing,]~~ jumping or dismantling of the tower ~~[or climber]~~ crane may be performed without the safety coordination meeting having taken place. The following parties must be present at the safety coordination meeting:

1. ~~[General contractor]~~ Equipment user or designee;
2. Professional engineer of record for the crane or designee;
3. Licensed master~~[,]~~ or tower ~~[or climber]~~ crane rigger and rigger foreman;
4. Site safety manager or coordinator, if required for the job by Chapter 33 of ~~[the]~~ this code;
5. Licensed crane operator and oiler; and
6. Any other parties the department deems necessary.

3319.8.3 Pre-jump safety meeting. The ~~[general contractor]~~ equipment user must coordinate a pre-jump safety meeting no more than 24 hours prior to each instance of a tower ~~[or climber]~~ crane jump ~~[or climb]~~. No work related to the jumping ~~[or climbing]~~ of the tower ~~[or climber]~~ crane may be performed without the pre-jump safety meeting having taken place. The following parties must be present at the pre-jump safety meeting:

1. ~~[General contractor]~~ Equipment user or designee;
2. Licensed master~~[,]~~ or tower ~~[or climber]~~ crane rigger and rigger foreman;
3. Site safety manager or coordinator, if required for the job by Chapter 33 of ~~[the building]~~ this code;
4. Licensed crane operator and oiler;
5. “Jumping” crew and back-up personnel;
6. Flagman/woman where required;
7. Signalman/woman and communications personnel; and
8. Any other parties the department deems necessary.

~~[3319.8.4 Department notification.~~

~~**3319.8.4.1 Meeting notifications.** The general contractor must notify the department at least 48 hours in advance of any safety coordination meeting or pre-jump safety meeting. No work related to the erecting, jumping, climbing, or dismantling of the tower or climber crane is to be performed without prior notice of the meeting having been given to the department.~~

~~**3319.8.4.2 Time schedule.** A time schedule including date and time of day that the erection, jumping, climbing, or dismantling is proposed to take place shall be provided as soon as it is known by the general contractor.]~~

3319.8.4 Department notification. The equipment user shall notify the department at least 48 hours in advance of the erection, jumping, or dismantling of a tower crane. No work related to the erecting, jumping, or dismantling of the tower crane is to be performed without such notification having been given to the department. The notification shall include the following information:

1. A time schedule including date and time of day that the erection, jumping, or dismantling is proposed to take place;
2. The names and contact information of the licensed master or tower crane rigger; and
3. The name and contact information of the company performing the erection, dismantling, or jumping work.

3319.8.5 Safety coordination and pre-jump safety meeting topics. The following topics are to be covered during safety coordination and pre-jump safety meetings:

1. Scope of work;
2. Roles and responsibilities;
3. Rigging to be used and the specific sequence of operations;
4. Inspection of all rigging equipment, materials, and tools prior to work;
5. Review of all equipment, including but not limited to, collars, ties, and bolts;
6. Permit validity;
7. Qualifications and training of personnel;
8. Relevant weather warnings;
9. Compliance with the manufacturer's manual; and
10. Softening mechanisms, if using nylon slings.

3319.8.6 Meeting log. The [~~general contractor~~] equipment user, or his or her designee, and/or the company erecting, jumping, [~~climbing,~~] or dismantling the tower [~~or climber~~] crane shall keep a log on site and available to the department at all times that shall include:

1. The dates and times of all safety coordination meetings and pre-jump safety meetings held;
2. The names, titles, and company affiliations of all those present at the meetings;
3. A summary of what was discussed during each meeting, including specific tasks and the name of the person to whom they were assigned;
4. A list of the decisions made at the meeting; and
5. Certification of worker training pursuant to Section 3319.10.

3319.8.7 Inspection and certification by the engineer of record. Prior to jumping [~~or climbing~~] a tower [~~or climber~~] crane, the engineer of record for the crane must provide the department with a certified, signed, and sealed report stating that:

1. He or she (or his or her designee) has inspected the crane installation prior to the pre-jump safety meeting, and providing the date of inspection;
2. He or she has found no hazardous conditions during the crane inspection or any other condition within his or her purview that adversely affects the safety of erection, dismantling, [~~climbing,~~] or jumping operations;
3. The crane is installed according to the plans approved by the department as well as in accordance with the manufacturer's specifications to the extent applicable; and
4. The appropriate technical testing records for the crane, including torque, plumb, and magnetic particle or other appropriate reports comply with safety requirements and with the manufacturer's specifications.

3319.8.8 Erection, jumping, [~~climbing,~~] and dismantling operations. The erection, jumping, [~~climbing,~~] and dismantling operations for tower [~~and climber~~] cranes shall be subject to the following requirements:

1. The licensed master, tower [~~or climber~~] crane rigger, and the rigger foreman[~~;~~] shall be present at the [~~job~~] site during erection, jumping, [~~climbing,~~] and dismantling of the tower [~~or climber~~] crane;
2. Cranes or derricks located either within the lot line or on the street, and used to erect, jump, [~~climb,~~] or dismantle tower [~~or climber~~] cranes, shall be subject to certificate of on-site inspection requirements;
3. A load radius chart approved by department shall be posted in the cabin of the crane;
4. The approved erection, jumping, [~~climbing,~~] or dismantling procedure and sequence, with weights of assemblies and components clearly marked, shall be given by the equipment user to the licensed operator of the crane or derrick and to the rigger prior to commencement of the work;

5. No tower [~~or climber~~] crane shall be placed, erected or disassembled in any roadway, sidewalk, or street unless a permit is first obtained from the New York City Department of Transportation;
6. All accepted or approved installed safety devices on a crane involved in the erection, jumping, [~~climbing,~~] or dismantling procedure shall have been calibrated within the time period provided by department rules or manufacturer's specifications; and
7. The safety devices of the tower [~~or climber~~] crane shall be inspected by the licensed crane operator as part of the inspection procedure.

3319.9 Slings. Slings shall be used in accordance with the following requirements and any rules promulgated by the commissioner.

3319.9.1 Use of [~~nylon~~] synthetic slings in conjunction with [~~climber or~~] tower crane erection, jumping, [~~climbing,~~] and dismantling. [~~Nylon~~] Synthetic slings shall only be used in conjunction with [~~climber or~~] tower crane erection, jumping, [~~climbing,~~] and dismantling if the manufacturer's manual specifically states or recommends the use of [~~nylon~~] synthetic slings. [~~Nylon~~] Synthetic slings shall not be used unless softening mechanisms have been applied to all sharp edges.

3319.9.2 Discarded rope. Discarded rope shall not be used for slings.

3319.10 Worker training. The training of workers engaged in the erection, jumping, or dismantling of a tower crane, including the licensed rigger and the rigger foreman, shall be in accordance with the requirements of Section 3319.10.1 and 3319.10.2.

Exceptions: The requirements of this section shall not apply to:

1. The installation of a tower crane foundation, anchor stool, and first mast section.
2. The assembly or disassembly of a self-erecting tower crane, provided workers engaged in the assembly/disassembly operation have been trained in accordance with rules promulgated by the commissioner.

3319.10.1 Training Requirements. All workers engaged in the erection, jumping, [~~climbing,~~ rigging,] or dismantling of a [~~climber or~~] tower crane, including the licensed rigger and the rigger foreman, shall have satisfactorily completed a department-approved training course of not less than thirty hours. Such course shall, at a minimum, include instruction on fall protection, crane assembly and disassembly, pre-lift planning, weights and materials, the use of slings, lifting/lowering loads, signaling and other proper means of communication with the crane operator, crane and hoist inspections, rigging requirements, and generally how to avoid [~~accidents~~] incidents with cranes and hoists. The commissioner may by rule identify additional types of cranes for which such training is necessary. Any person who, within the three years prior to the effective date of this section, has successfully completed at least a thirty-hour training course need not take a second thirty-hour course, provided such person can provide to the department a dated certificate as set forth in this section evidencing completion of such a training course. Such person shall, however, take a department-approved eight-hour re-certification

course within three years of the initial course and every three years thereafter. Successful completion of the training or re-certification course shall be evidenced by a dated certificate issued by the provider of the training or re-certification course. The certificate shall include such information as specified by the department by rule. The certificate, or a valid wallet card version thereof, shall be readily available to the commissioner upon request.

3319.10.1.1 Training providers. Such training or refresher course shall be conducted (i) pursuant to a registered New York state department of labor training program, or (ii) by a provider approved by the department.

3319.10.2 Certification. Prior to erecting, jumping, [~~climbing~~] or dismantling the [~~climber or~~] tower crane, or other crane type the commissioner specifies by rule, the master[~~, climber~~] or tower crane rigger shall certify in the meeting log, described in Section 3319.8.6, that the rigger foreman and all other members of the “jumping crew” and back-up personnel have satisfactorily completed all training requirements.

3319.11 Crane location device. No crane operation that requires a certificate of on-site inspection, and other such types of crane operations where identified in rules promulgated by the commissioner, shall commence unless the crane is equipped with a global positioning system, or other similar device, that is approved by the department and capable of transmitting the location of the crane to which it is attached to the department. Where no such system or device has been approved by the department, (i) no crane operation subject to the provisions of this section shall commence until after the department has been notified by the equipment user, in a form and manner approved by the commissioner, of the date upon which the crane will arrive at the site, and (ii) upon the conclusion of the work, the equipment user shall also notify the department, in a form and manner approved by the commissioner, of the date of the departure of the crane from the site.

Exception: Crane operations that utilize tower [~~or climber~~] cranes and require submission of an erection, jumping, [~~climbing~~] and dismantling plan to the department by a licensed engineer.

3319.12 Crane event recorder. No certificate of operation for a crane shall be issued or renewed on or after January 1, 2019, unless the crane is equipped with an event recorder that is supplied by the crane manufacturer, or by a dealer, distributor, vendor, or third-party authorized crane manufacturer.

Exception: Cranes where the manufacturer certifies to the department that an event recorder cannot be installed on the crane due to a technological limitation.

3319.12.1 Data to be recorded. At a minimum, the event recorder shall collect the following data:

1. Crane configuration;
2. Any overload condition;
3. Status of limit switches; and
4. Operator overrides.

3319.12.2 Data to be made available to commissioner upon request. Data collected by the event recorder shall be made available to the commissioner upon request.

3319.13 Measuring wind. Wind speed during crane or derrick operations shall be determined in accordance with the requirements of Table 3319.13. Options 1, 2, and 3 in Table 3319.13 shall be in accordance with the requirements of Sections 3319.13.1 through 3319.13.3, respectively.

**Table 3319.13
Wind measurement requirements for cranes and derricks**

Equipment type		Allowable options		
		Option 1: Anemometer on the crane or derrick	Option 2: Anemometer at the site	Option 3: Nearest weather station
Certificate of on-site inspection or supervision by a licensed master rigger required	Crane with lattice boom, jib, or mast (and not a pile driver or clamshell)	Yes	No (Except may utilize if anemometer on crane malfunctions)	No
	Crane utilizing only a telescoping boom	Yes	Yes	Yes
	Crane utilizing only an articulating boom	Yes	Yes	Yes
	Pile driver	Yes	Yes	Yes
	Clamshell	Yes	Yes	Yes
	Derrick	Yes	Yes	No
A crane, derrick, pile driver, or clamshell that does not require a certificate of on-site inspection or supervision by a licensed master rigger		Yes	Yes	Yes

3319.13.1 Option 1: Anemometer on the crane or derrick. An anemometer provided by the crane or derrick manufacturer, or an entity acceptable to such manufacturer, and installed at the top of the boom or at the location specified by such manufacturer. The anemometer must measure a 3-second gust wind. A real time display of the anemometer must be available to the hoisting machine operator in the crane cab or at the operator’s station. Such anemometer is to be considered an operational aid and must be checked prior to each shift as required by department rules.

Exception: Where the manufacturer is no longer in business, or the manufacturer or an entity acceptable to such manufacturer is unable to provide the anemometer, the anemometer may be approved by the department.

3319.13.2 Option 2: Anemometer at the site. An anemometer located at a high point of the site approximate to the height and location of the crane or derrick boom/jib, freely exposed to the wind, and calibrated in accordance with ASTM D5096-02. The anemometer must measure a 3-second gust wind. A real time display of the anemometer must be available to the hoisting machine operator at the operator's station, or a person designated by the hoisting machine operator must be provided to monitor the display and alert the hoisting machine operator when measurements near, meet, or exceed the thresholds specified in the approved wind action plan. Such anemometer is to be considered an operational aid and must be checked prior to each shift as required by department rules.

3319.13.3 Option 3: Nearest weather station. The most recent gust wind speed reported at the nearest National Weather Service weather station. The equipment user must establish a system to ensure the hoisting machine operator is notified when reported wind gusts near, meet, or exceed the thresholds specified in the approved wind action plan. An acceptable system may include engaging a metrological service to provide a text or similar alert to a person designated by the equipment user when wind thresholds are neared, met, or exceeded, and have such designated person notify the hoisting machine operator.

[3319.13] 3319.14 Age limitations for cranes. Only cranes having an age of less than 25 years from the manufacture date may be used in New York City. Notwithstanding the provisions of Section 3319.5, the certificate of operation for a crane with an age greater than 25 years from the manufacture date shall be deemed to have expired.

Exceptions:

1. A crane with an age of 25 years or greater from the manufacture date that is (i) in use on a project on January 1, 2019 or (ii) not in use on January 1, 2019, but for which an application for a certificate of on-site inspection has been approved as of January 1, 2019, may continue to be used until completion of the project for which it is being used or the project for which such certificate of onsite inspection was issued.
2. Where a crane with an age of less than 25 years from the manufacture date at the time the department approved the application for a certificate of on-site inspection is being used on a project and will reach an age of 25 years or greater from the manufacture date during such project, such crane may be used for the duration of that project or until it reaches 28 years of age, whichever occurs earlier.
3. The commissioner may approve the use of a crane with an age of 25 years or greater from the manufacture date for up to a maximum of five years, not to exceed 30 years from the manufacture date, when records as required by rule of the department are deemed sufficient by the commissioner to establish that such crane meets the manufacturer's standards for use.
4. This section shall not apply to equipment used for pile driving or clamshell work.

§ 50. Section BC 3320 of the New York city building code, as added by local law

number 33 for the year 2007, is amended to read as follows:

SECTION BC 3320
ADDITIONAL REQUIREMENTS FOR CERTAIN MATERIAL HANDLING
EQUIPMENT

3320.1 Scope. ~~[Material handling equipment shall meet and be used in accordance with the requirements of this section.]~~ Conveyors, trucks, power buggies, lift and fork trucks, hand propelled vehicles, mixing machines, and jacks shall meet and be used in accordance with the requirements of this section, Section 3316, and rules promulgated by the commissioner.

Exception: Equipment that is exempted from the requirements of Section 3316.1.

~~[**3320.2 Requirements.** Material handling equipment shall be installed, operated, and maintained to eliminate hazard to the public or to property. It shall be unlawful to operate any such equipment that is not provided with a positive means for preventing the unauthorized operation of such machine. The means whereby such machines may be made inoperative shall be acceptable to the commissioner.]~~

3320.2 Reserved.

~~[**3320.3 Operation.** Only operators designated by the person causing such machinery to be used shall operate material handling machinery. Operators and signalmen/signalwoman shall be experienced at the operation they perform. The operator shall be responsible for making the machine inoperative before he or she leaves the machine.]~~

~~[**3320.3.1 Loading.** Loading of material handling equipment shall be conducted in accordance with the following requirements:~~

- ~~1. Material handling equipment shall not be loaded in excess of the rated load specified by the manufacturer. When necessary, manufacturer load ratings shall be reduced to take into account effects of wind, ground condition and operating speed.~~
- ~~2. Rated load capacities and required charts shall be conspicuously posted on all material handling equipment or on the site and shall be available to the commissioner at all times.~~
- ~~3. All loads shall be properly trimmed to prevent the dislodgment of any part during raising, lowering, swinging or transit.~~
- ~~4. Suspended loads shall be securely slung and properly balanced before they are set in motion.]~~

~~[**3320.3.2 Refueling.** Refueling of material handling equipment shall be conducted in accordance with the following requirements:~~

- ~~1. The engine shall be stopped during refueling, except as otherwise provided in rules promulgated by the commissioner.~~
- ~~2. Open lights, flames, or spark producing devices shall be kept at a safe distance while refueling an internal combustion engine.~~

3. ~~No person shall smoke or carry lighted smoking material in the immediate vicinity of the refueling area.~~
4. ~~“No smoking” signs shall be conspicuously posted in all fueling or fuel storage areas.~~
5. ~~Fuel shall be kept in containers that meet the requirements of the Fire Department.~~
6. ~~All other requirements of the Fire Department shall be satisfied.]~~

3320.3 Reserved.

~~[3320.4 Notification of accidents involving material handling equipment. The owner or person directly in charge of any material handling equipment shall immediately notify the commissioner following any accident involving material handling equipment. In such a case, no person shall permit either of the following without the permission of the commissioner:~~

1. ~~Use of such material handling equipment; or~~
2. ~~Remove of the material handling equipment or any part thereof from the area of the job site.]~~

3320.4 Reserved.

3320.5 Conveyors. Conveyors shall meet the requirements of Sections 3320.5.1 through 3320.5.3.

3320.5.1 Walkways. Walkways along belt conveyors or bucket conveyors shall be kept free of materials and, where 5 feet (127 mm) or more above the ground, shall be provided with a ~~[standard guardrail and standard toeboard]~~ guardrail system that meets the requirements of ~~[Section 3307.8]~~ Sections 3308.7.1 through 3308.7.7 along the outside of the walkway. The ~~[standard guardrail and standard toeboard]~~ guardrail system may be omitted on the side toward the belt if the walkway is located adjacent to the conveyor.

3320.5.2 Trippers. Where trippers are used to control discharge, a device for throwing the belt or bucket drive into neutral shall be installed at each end of the runway.

3320.5.3 Spillage. Where conveyor belts cross any traveled way, trays shall be installed to catch spillage and overhead protection shall be provided for persons or traffic passing beneath.

3320.6 Trucks. Trucks shall meet the requirements of Sections 3320.6.1 and 3320.6.2.

3320.6.1 Maintenance. All parts and accessories of trucks shall be kept in repair. Brakes shall be maintained so that the vehicle with full load may be held on any grade that may be encountered on the job. Provision shall be made for the immediate application of wheel blocks to trucks traversing ramps steeper than one in ten.

3320.6.2 Loading. Trucks shall not be loaded beyond the manufacturer’s rated capacity, nor beyond the legal load limit, where applicable. The loads shall be trimmed before the truck is set in motion to prevent spillage. Loads that project beyond the sides of the truck, or that may be dislodged in transit, shall be removed or securely lashed in place.

3320.7 Power buggies. Power buggies shall meet the requirements of Sections 3320.7.1 and 3320.7.2.

3320.7.1 Responsibilities of employers and workers. Employers and workers shall have the following responsibilities regarding power buggies:

1. Every [~~person~~] contractor causing a power buggy to be used shall provide trained and [~~competent~~] qualified operators and shall carry out or enforce all provisions of this section pertaining to the use, operation and maintenance thereof.
2. No person other than the operator assigned by the employer shall operate a power buggy. A power buggy shall be in the charge and custody of the operator assigned, and no other person shall in any way interfere with or handle it, nor shall the operator cause or permit any other person to do so.
3. No power buggy shall be operated unless it is in good operating condition and is so constructed that it is stable under conditions of normal use.

3320.7.2 Operation and construction. Power buggies shall be operated and constructed in accordance with the requirements of Sections 3320.7.2.1 through 3320.7.2.4.

3320.7.2.1 Brakes. Every power buggy shall be provided with brakes and tire surfaces capable of bringing it to a full stop within 25 feet (635 mm) on a level surface that is similar to the one on which it will be used and at full rated load and maximum design speed. Brakes shall be capable of being fixed in engagement to hold the full load stationary on a 25 percent grade.

3320.7.2.2 Accidental starting. All movement controls of every power buggy shall be so arranged or shielded that they cannot be inadvertently engaged or the buggy accidentally set in motion.

3320.7.2.3 Parking on grades. No power buggy shall be left unattended on any grade sufficiently steep to cause it to coast if free of engine and brake resistance.

3320.7.2.4 Use on ramps, runways and platforms. Power buggies shall not be used on ramps, runways, or platforms that do not meet the requirements of Section 3315.

3320.8 Lift and fork trucks. Lift and fork trucks shall meet the requirements of Sections 3320.8.1 through 3320.8.4.

3320.8.1 Load capacity. A metal plate with readily legible etched or stamped figures giving the capacity rating in pounds shall be attached to every lift or fork truck.

3320.8.2 Maintenance. All parts and accessories of lift or fork trucks shall be kept in repair and with brakes adequate to maintain the fully loaded vehicle on any grade that may be encountered on the job.

3320.8.3 Loading. No lift or fork truck shall be loaded beyond its capacity rating. No hand-operated pallet truck loaded so that any point on the load is at a greater height than 4 feet 6 inches (114 mm) above the floor shall be moved by pushing unless handled by two persons.

3320.8.4 Prohibited use. No lift or fork truck shall be in motion when the loaded forks are elevated higher than necessary to clear obstructions, except as may be required for positioning, picking up, or depositing the load.

3320.9 Hand propelled vehicles. Hand propelled vehicles shall be constructed and braked to withstand the loads to be carried and shall be maintained in repair. Vehicles with loose parts shall not be used.

3320.10 Mixing machines. Where the public may have access to the working area near charging skips, [standard] guardrails [~~that meet the requirements of Section 3307.8~~] or other adequate protection in accordance with the New York City Department of Transportation shall be erected to enclose the area under the raised skip and the mixing machine. Each time before raising or lowering the charging skip, the operator shall ascertain that no one is in the danger zone.

3320.11 Jacks. Jacks shall meet the requirements of Sections 3320.11.1 through 3320.11.5.

3320.11.1 Marking. The rated capacity of every jack shall be legibly marked in a prominent location on the jack by casting or stamping. The manufacturer shall designate the intended supporting point of the load and the maximum permissible length of lever and force applied.

3320.11.2 Overtravel to be limited. Every jack shall, where practicable, be provided with a positive stop to prevent overtravel; otherwise an indicator to clearly show overtravel shall be provided on the jack.

3320.11.3 Maintenance. Lubrication and operation of jacks shall be in accordance with the recommendations of the manufacturer.

3320.11.4 Foundations. Jacks shall rest on a firm, level foundation adequate to support the load.

3320.11.5 Blocking required. When the object has been lifted to the desired height, blocking or cribbing shall be immediately placed under it if the jack does not have built-in safety devices such as stop-rings, locknuts or place-in cylinder sleeves.

~~[3320.12 Cableways. The construction, installation, inspection, maintenance and use of cableways shall be in conformance with rules.]~~

§ 51. Chapter 35 of the New York city building code, as added by local law number 141 for the year 2013, is REPEALED, and a new Chapter 35 is added to read as follows:

CHAPTER 35
REFERENCED STANDARDS

SECTION BC 3501
GENERAL

3501.1 General. This chapter lists the standards that are referenced in various sections of this document. The standards are listed herein by the promulgating agency of the standard, the standard identification, the effective date and title and the section or sections of this document that reference the standard.

3501.2 Subsequent additions, modifications or deletions. Refer to the rules of the department for any subsequent additions, modifications or deletions that may have been made to these standards in accordance with Section 28-103.19 of the *Administrative Code*.

3501.3 Applicability. The application of the referenced standards shall be as specified in Section 102.4.

SECTION BC 3502
STANDARDS

<u>AA</u>	<u>Aluminum Association</u> <u>1525 Wilson Boulevard, Suite 600</u> <u>Arlington, VA 22209</u>	
<u>Standard reference number</u>	<u>Title</u>	<u>Referenced in code section number</u>
<u>ADM—15</u>	<u>Aluminum Design Manual: Part 1—A Specification for Aluminum Structures</u>	<u>1604.3.5,</u> <u>1705.33.1,</u> <u>2002.1</u>
<u>ASM 35—00</u>	<u>Aluminum Sheet Metal Work in Building Construction</u> <u>(Fourth Edition)</u>	<u>2002.1</u>

<u>AAMA</u>	<u>American Architectural Manufacturers Association</u> <u>1827 Waldon Office Square, Suite 550</u> <u>Schaumburg, IL 60173</u>	
<u>Standard reference number</u>	<u>Title</u>	<u>Referenced in code section number</u>
<u>1402—09</u>	<u>Standard Specifications for Aluminum Siding, Soffit and Fascia</u>	<u>1404.5.1</u>
<u>AAMA/WDMA/CSA 101/I.S.2/A440—11</u>	<u>North American Fenestration Standard/Specifications for Windows, Doors and Skylights</u>	<u>1709.5.1,</u> <u>2405.5</u>

<u>AASHTO</u>	<u>American Association of State Highway and Transportation Officials</u> <u>444 N Capitol Street NW, Suite 249</u> <u>Washington, DC 20001</u>	
<u>Standard reference number</u>	<u>Title</u>	<u>Referenced in code section number</u>
<u>T318—15</u>	<u>Standard Method of Test for Water Content of Freshly Mixed Concrete Using Microwave Oven Drying</u>	<u>1905.6.2.1,</u> <u>1905.6.3.6</u>

<u>ACI</u>	<u>American Concrete Institute</u> <u>38800 Country Club Drive</u> <u>Farmington Hills, MI 48331</u>	
<u>Standard reference number</u>	<u>Title</u>	<u>Referenced in code section number</u>
<u>216.1—14</u>	<u>Code Requirements for Determining Fire Resistance of Concrete and Masonry Construction Assemblies</u>	<u>Table 721.1(2),</u> <u>722.1</u>
<u>301—10</u>	<u>Specification for Structural Concrete</u>	<u>1812.1.1,</u> <u>1905.2.4,</u> <u>1905.3.5.2,</u> <u>1905.6.3.7</u>
<u>306R—10</u>	<u>Guide to Cold Weather Concreting</u>	<u>Table 1904.4.2</u>
<u>318—14*</u> <u>*As modified in Section 1908</u>	<u>Building Code Requirements for Structural Concrete</u>	<u>406.7.3,</u> <u>722.2.4.3,</u> <u>1604.3.2,</u> <u>Table 1613.5,</u> <u>Table 1705.2,</u> <u>Table 1705.3,</u> <u>1705.3.1,</u>

<u>ACI</u>	<u>American Concrete Institute</u> <u>38800 Country Club Drive</u> <u>Farmington Hills, MI 48331</u>	
<u>Standard reference number</u>	<u>Title</u>	<u>Referenced in code section number</u>
		<u>1705.37,</u> <u>1809.5.7.2,</u> <u>1809.6,</u> <u>Table 1810.2.13,</u> <u>Table 1810.8,</u> <u>1810.9.1.1,</u> <u>1810.9.2,</u> <u>1810.9.2.1,</u> <u>1811.6.3.2,</u> <u>1811.6.3.2.2,</u> <u>1812.1.2.5.1,</u> <u>1812.1.2.5.2,</u> <u>1812.7.4.1,</u> <u>1812.8.3,</u> <u>1812.8.4, 1901.2,</u> <u>1901.3, 1901.5,</u> <u>1902.1, 1903.1,</u> <u>1903.5, 1903.6,</u> <u>1903.6.1,</u> <u>1903.6.2, 1903.7,</u> <u>1903.8, 1904.1,</u> <u>1904.2, 1904.3,</u> <u>1904.4, 1904.4.1,</u> <u>1904.5, 1905.1,</u> <u>1905.1.1,</u> <u>1905.1.4, 1905.2,</u> <u>1905.3, 1905.4,</u> <u>1905.5, 1905.6,</u> <u>1905.6.5.5,</u> <u>1905.6.6,</u> <u>1905.8.3,</u> <u>1905.11.3,</u> <u>1906.1, 1906.2,</u> <u>1906.3, 1906.4,</u> <u>1907.1, 1907.2,</u> <u>1907.4.1,</u> <u>1907.5.2.1,</u> <u>1907.5.2.2,</u> <u>1907.6, 1907.7.1,</u> <u>1907.7.2,</u>

<u>ACI</u>	<u>American Concrete Institute</u> <u>38800 Country Club Drive</u> <u>Farmington Hills, MI 48331</u>	
<u>Standard reference number</u>	<u>Title</u>	<u>Referenced in code section number</u>
		<u>1907.7.3,</u> <u>1907.7.4,</u> <u>1907.7.5,</u> <u>1907.7.6, 1907.8,</u> <u>1907.9, 1907.10,</u> <u>1907.11,</u> <u>1907.12,</u> <u>1907.13, 1908.1,</u> <u>1908.1.1,</u> <u>1908.1.2,</u> <u>1908.1.3,</u> <u>1908.1.4,</u> <u>1908.1.5,</u> <u>1908.1.6,</u> <u>1908.1.7,</u> <u>1908.1.8,</u> <u>1908.1.9,</u> <u>1908.1.10,</u> <u>1909.1, 1912.2,</u> <u>1912.3.1, 2108.3,</u> <u>2206.1, 2206.3,</u> <u>3305.3.2</u>
<u>530—13</u>	<u>Building Code Requirements for Masonry Structures</u>	<u>1705.4.1,</u> <u>1705.4.3</u>
<u>530.1—13</u>	<u>Specifications for Masonry Structures</u>	<u>Table 1705.4.1,</u> <u>Table 1705.4.3,</u> <u>2105.1</u>

<u>AISC</u>	<u>American Institute of Steel Construction</u> <u>One East Wacker Drive, Suite 700</u> <u>Chicago, IL 60601-18021</u>	
<u>Standard reference number</u>	<u>Title</u>	<u>Referenced in code section number</u>
<u>ANSI/AISC</u> <u>303—16</u>	<u>Code of Standard Practice for Steel Buildings and Bridges</u>	<u>2203.1, 2205.3.1</u>

<u>AISC</u>	<u>American Institute of Steel Construction</u> <u>One East Wacker Drive, Suite 700</u> <u>Chicago, IL 60601-18021</u>	
<u>Standard reference number</u>	<u>Title</u>	<u>Referenced in code section number</u>
<u>ANSI/AISC 341—16</u>	<u>Seismic Provisions for Structural Steel Buildings</u>	<u>1705.2.4.1,</u> <u>1705.2.4.2,</u> <u>1705.2.5,</u> <u>1705.2.5.2,</u> <u>2205.2.1.1,</u> <u>2205.2.1.2,</u> <u>2205.2.2,</u> <u>2206.2.1, 2206.3</u>
<u>ANSI/AISC 360—16</u>	<u>Specification for Structural Steel Buildings</u>	<u>722.5.2.2.1,</u> <u>1604.3.3,</u> <u>Table 1705.2,</u> <u>1705.2.3,</u> <u>Table 1810.8,</u> <u>2203.2, 2205.1,</u> <u>2205.1.1,</u> <u>2205.2.1.1,</u> <u>2205.3, 2205.3.2,</u> <u>2205.3.3, 2206.1,</u> <u>2206.3, 3305.2</u>

<u>AISI</u>	<u>American Iron and Steel Institute</u> <u>25 Massachusetts Avenue, NW Suite 800</u> <u>Washington, DC 20001</u>	
<u>Standard reference number</u>	<u>Title</u>	<u>Referenced in code section number</u>
<u>AISI S100—16</u>	<u>North American Specification for the Design of Cold-formed Steel Structural Members</u>	<u>1908.1.5, 2203.1,</u> <u>2203.2, 2210.1,</u> <u>2210.2</u>
<u>AISI S220—15</u>	<u>North American Standard for Cold-formed Steel Framing-Nonstructural Members</u>	<u>2203.1, 2203.2,</u> <u>2211.2,</u> <u>Table 2506.2,</u> <u>Table 2507.2</u>
<u>AISI S230—15</u>	<u>Standard for Cold-formed Steel Framing-Prescriptive Method for One- and Two-family Dwellings,</u>	<u>1609.1.1,</u> <u>1609.1.1.1,</u> <u>2211.1.2</u>

<u>AIISI</u>	<u>American Iron and Steel Institute</u> <u>25 Massachusetts Avenue, NW Suite 800</u> <u>Washington, DC 20001</u>	
<u>Standard reference number</u>	<u>Title</u>	<u>Referenced in code section number</u>
<u>AIISI S240—15</u>	<u>North American Standard for Cold-Formed Steel Structural Framing, 2015</u>	<u>Table 1705.2.6,</u> <u>2203.1, 2203.2,</u> <u>2211.1,</u> <u>2211.1.1.1,</u> <u>2211.1.3.3,</u> <u>Table 2603.12.1,</u> <u>Table 2603.12.2</u>
<u>AIISI S400—15/S1—16</u>	<u>North American Standard for Seismic Design of Cold-formed Steel Structural Systems, 2015, with Supplement 1, dated 2016</u>	<u>1604.3.3,</u> <u>Table 1613.5</u>

<u>AMCA</u>	<u>Air Movement and Control Association International</u> <u>30 West University Drive</u> <u>Arlington Heights, IL 60004</u>	
<u>Standard reference number</u>	<u>Title</u>	<u>Referenced in code section number</u>
<u>540—13</u>	<u>Test Method for Louvers Impacted by Wind Borne Debris</u>	<u>1609.1.2.1</u>

<u>ANSI</u>	<u>American National Standards Institute</u> <u>25 West 43rd Street, Fourth Floor</u> <u>New York, NY 10036</u>	
<u>Standard reference number</u>	<u>Title</u>	<u>Referenced in code section number</u>
<u>A10.3—06*</u> <u>*As modified in Section 3311.4</u>	<u>Safety Requirements for Powder-actuated Fastening Systems</u>	<u>3311.3, 3311.4,</u> <u>3311.4.1,</u> <u>3311.4.2,</u> <u>3311.4.3,</u> <u>3311.4.4,</u> <u>3311.4.5,</u> <u>3311.4.6,</u> <u>3311.4.7,</u> <u>3311.4.8,</u> <u>3311.4.9,</u> <u>3311.4.10,</u> <u>3311.4.11,</u> <u>3311.4.12</u>

<u>ANSI</u>	<u>American National Standards Institute</u> <u>25 West 43rd Street, Fourth Floor</u> <u>New York, NY 10036</u>	
<u>Standard reference number</u>	<u>Title</u>	<u>Referenced in code section number</u>
<u>A10.4—16</u>	<u>Safety Requirements for Personnel Hoists on Construction & Demolition Sites</u>	<u>3001.2, 3010.3</u>
<u>ANSI/ASSP A10.11—10*</u> <u>*As modified in Section 3308.6.2</u>	<u>Safety Requirements for Personnel and Debris Nets</u>	<u>202 (STRUCTURAL NET), 3302.1, 3308.6.2, 3308.6.2.3, 3308.6.2.4, 3308.6.2.5, 3308.6.2.6, 3308.6.2.7, 3308.6.2.8, 3308.6.2.9, 3308.6.2.10, 3308.6.2.11, 3308.6.4</u>
<u>A13.1—2007</u>	<u>Scheme for the Identification of Piping Systems</u>	<u>415.11.6.5, 903.6, 905.11</u>
<u>A108.1A—99</u>	<u>Installation of Ceramic Tile in the Wet-set Method, with Portland Cement Mortar</u>	<u>2103.2.3</u>
<u>A108.1B—99</u>	<u>Installation of Ceramic Tile, quarry Tile on a Cured Portland Cement Mortar Setting Bed with Dry-set or Latex-Portland Mortar</u>	<u>2103.2.3</u>
<u>A108.4—99</u>	<u>Installation of Ceramic Tile with Organic Adhesives or Water-cleanable Tile-setting Epoxy Adhesive</u>	<u>2103.2.3.6</u>
<u>A108.5—99</u>	<u>Installation of Ceramic Tile with Dry-set Portland Cement Mortar or Latex-Portland Cement Mortar</u>	<u>2103.2.3.1, 2103.2.3.2</u>
<u>A108.6—99</u>	<u>Installation of Ceramic Tile with Chemical-resistant, Water Cleanable Tile-setting and -grouting Epoxy</u>	<u>2103.2.3.3</u>
<u>A108.8—99</u>	<u>Installation of Ceramic Tile with Chemical-resistant Furan Resin Mortar and Grout</u>	<u>2103.2.3.4</u>
<u>A108.9—99</u>	<u>Installation of Ceramic Tile with Modified Epoxy Emulsion Mortar/Grout</u>	<u>2103.2.3.5</u>
<u>A108.10—99</u>	<u>Installation of Grout in Tilework</u>	<u>2103.2.3.7</u>
<u>A118.1—16</u>	<u>American National Standard Specifications for Dry-set Portland Cement Mortar</u>	<u>2103.2.3.1</u>

<u>ANSI</u>	<u>American National Standards Institute 25 West 43rd Street, Fourth Floor New York, NY 10036</u>	
<u>Standard reference number</u>	<u>Title</u>	<u>Referenced in code section number</u>
<u>A118.3—13</u>	<u>American National Standard Specifications for Chemical-resistant, Water-cleanable Tile-setting and -grouting Epoxy and Water Cleanable Tile-setting Epoxy Adhesive</u>	<u>2103.2.3.3</u>
<u>A118.4—16</u>	<u>American National Standard Specifications for Latex-Portland Cement Mortar</u>	<u>2103.2.3.2, 2103.3.2.4</u>
<u>A118.5—99</u>	<u>American National Standard Specifications for Chemical Resistant Furan Mortar and Grouts for Tile Installation</u>	<u>2103.2.3.4</u>
<u>A118.6—10</u>	<u>American National Standard Specifications for Cement Grouts for Tile Installation</u>	<u>2103.2.3.7</u>
<u>A118.8—99</u>	<u>American National Standard Specifications for Modified Epoxy Emulsion Mortar/Grout</u>	<u>2103.2.3.5</u>
<u>A136.1—08</u>	<u>American National Standard Specifications for Organic Adhesives for Installation of Ceramic Tile</u>	<u>2103.2.3.6</u>
<u>A137.1—12</u>	<u>American National Standard Specifications for Ceramic Tile</u>	<u>202 (PORCELAIN TILE)</u>
<u>A190.1—17</u>	<u>Standard for Wood Products - Structural Glued Laminated Timber</u>	<u>2303.1.3, 2306.1</u>
<u>A208.1—16</u>	<u>Particleboard</u>	<u>2303.1.8, 2303.1.8.1</u>
<u>E1.42—18</u>	<u>Entertainment Technology - Design, Installation, and Use of Orchestra Pit Lifts</u>	<u>3001.2</u>
<u>E1.46—18</u>	<u>Standard for the Prevention of Falls from Theatrical Stages and raised Performance Platforms</u>	<u>3001.2</u>
<u>Z97.1—14</u>	<u>Safety Glazing Materials Used in Buildings—Safety Performance Specifications and Methods of Test</u>	<u>2406.1.2, 2406.2, Table 2406.2(2), 2406.3.1, 2407.1, 2407.1.4.1, 2408.2.1, 2408.3, 2409.2, 2409.3, 2409.4.1</u>
<u>Z535.1—06</u>	<u>Safety Colors</u>	<u>1024.3.1, 1025.6.2</u>
<u>Z535.2—11</u>	<u>Environmental and Facility Safety Signs</u>	<u>K1</u>

<u>APA</u>	<u>APA-Engineered Wood Association</u> <u>7011 South 19th</u> <u>Tacoma, WA 98466</u>	
<u>Standard reference number</u>	<u>Title</u>	<u>Referenced in code section number</u>
<u>ANSI/A 190.1—17</u>	<u>Standard for Wood Products - Structural Glued Laminated Timber</u>	<u>2303.1.3, 2306.1</u>
<u>ANSI/APA PRP 210—14</u>	<u>Standard for Performance-Rated Engineered Wood Siding</u>	<u>2303.1.5, 2304.7, 2306.3</u>
<u>ANSI/APA PRR 410—16</u>	<u>Standard for Performance-Rated Engineered Wood Rim Boards</u>	<u>2303.1.13</u>
<u>APA PDS—12</u>	<u>Panel Design Specification</u>	<u>2306.1</u>
<u>APA PDS Supplement 1—14</u>	<u>Design and Fabrication of Plywood Curved Panels</u>	<u>2306.1</u>
<u>APA PDS Supplement 2—14</u>	<u>Design and Fabrication of Plywood-lumber Beams</u>	<u>2306.1</u>
<u>APA PDS Supplement 3—14</u>	<u>Design and Fabrication of Plywood Stressed-skin Panels</u>	<u>2306.1</u>
<u>APA PDS Supplement 4—14</u>	<u>Design and Fabrication of Plywood Sandwich Panels</u>	<u>2306.1</u>
<u>APA PDS Supplement 5—14</u>	<u>Design and Fabrication of All-plywood Beams</u>	<u>2306.1</u>
<u>ANSI/APA PRG 320—18</u>	<u>Standard for Performance-Rated Cross-Laminated Timber</u>	<u>Table 1705.5.6, 2303.1.4</u>
<u>EWS R540—13</u>	<u>Builders Tips: Proper Storage and Handling of Glulam Beams</u>	<u>2306.1</u>
<u>EWS S475—16</u>	<u>Glued Laminated Beam Design Tables</u>	<u>2306.1</u>
<u>EWS S560—14</u>	<u>Technical Note: Field Notching and Drilling of Glued Laminated Timber Beams</u>	<u>2306.1</u>
<u>EWS T300—16</u>	<u>Glulam Connection Details</u>	<u>2306.1</u>
<u>EWS X440—08</u>	<u>Product Guide: Glulam</u>	<u>2306.1</u>

<u>API</u>	<u>American Petroleum Institute</u> <u>200 Massachusetts Avenue NW</u> <u>Suite 1100</u> <u>Washington, DC 20001-5571</u>	
<u>Standard reference number</u>	<u>Title</u>	<u>Referenced in code section number</u>
<u>API Specification 5CT—2018</u>	<u>Casing and Tubing, 10th Ed, June 2018</u>	<u>1811.7.1.2</u>
<u>API Specification 5L—2018</u>	<u>Line Pipe 46th Ed, April 2018</u>	<u>1811.7.1.2</u>
<u>API Recommended Practice 13B-1—2019</u>	<u>Recommended Practice for Field Testing Water-based Drilling Fluids, 5th Ed, May 2019</u>	<u>1812.1.1.2.3</u>

<u>APSP</u>	<u>The Association of Pool & Spa Professionals</u> <u>2111 Eisenhower Avenue</u> <u>Alexandria, VA 22314</u>	
<u>Standard reference number</u>	<u>Title</u>	<u>Referenced in code section number</u>
<u>ANSI/APSP 7—06</u>	<u>Standard for Suction Entrapment Avoidance in Swimming Pools, Wading Pools, Spas, Hot Tubs and Catch Basins</u>	<u>3109.3.1.1</u>

<u>AREMA</u>	<u>American Railway Engineering and Maintenance-of-Way Association</u> <u>10003 Derekwood Lane, Suite 210</u> <u>Lanham, Maryland 20706</u>	
<u>Standard reference number</u>	<u>Title</u>	<u>Referenced in code section number</u>
<u>AREMA—2020</u>	<u>Manual for Railway Engineering</u>	<u>1607.10.5</u>

<u>ASABE</u>	<u>American Society of Agricultural and Biological Engineers</u> <u>2950 Niles Road</u> <u>St. Joseph, MI 49085</u>	
<u>Standard reference number</u>	<u>Title</u>	<u>Referenced in code section number</u>
<u>EP 484.2 June 1998 (R2008)</u>	<u>Diaphragm Design of Metal-clad, Wood-frame Rectangular Buildings</u>	<u>2306.1</u>
<u>EP 486.2 OCT 2012</u>	<u>Shallow-post Foundation Design</u>	<u>2306.1</u>
<u>EP 559.1 2016</u>	<u>Design Requirements and Bending Properties for Mechanically Laminated Wood Assemblies</u>	<u>2306.1</u>

<u>ASCE/ SEI</u>	<u>American Society of Civil Engineers</u> <u>Structural Engineering Institute</u> <u>1801 Alexander Bell Drive</u> <u>Reston, VA 20191-4400</u>	
<u>Standard reference number</u>	<u>Title</u>	<u>Referenced in code section number</u>
<u>5—13</u>	<u>Building Code Requirements for Masonry Structures</u>	<u>1405.6, 1405.6.2, 1405.10, 1705.4.1, Table 1705.4.1, 1705.4.3, Table 1705.4.3</u>
<u>6—13</u>	<u>Specification for Masonry Structures</u>	<u>1405.6.1, Table 1705.4.1, Table 1705.4.4, 2105.1</u>
<u>7—16*</u> <u>*As modified in Chapter 16</u>	<u>Minimum Design Loads and Associated Criteria for Buildings and Other Structures with Supplement No. 1</u>	<u>202 (FLOODPROOFING, DRY; MAXIMUM CONSIDERED EARTHQUAKE GEOMETRIC MEAN (MCEG) PEAK GROUND ACCELERATION; RISK-TARGETED MAXIMUM CONSIDERED EARTHQUAKE</u>

<u>ASCE/</u> <u>SEI</u>	<u>American Society of Civil Engineers</u> <u>Structural Engineering Institute</u> <u>1801 Alexander Bell Drive</u> <u>Reston, VA 20191-4400</u>	
<u>Standard</u> <u>reference</u> <u>number</u>	<u>Title</u>	<u>Referenced</u> <u>in code</u> <u>section number</u>
		<u>(MCER) GROUND</u> <u>MOTION RESPONSE</u> <u>ACCELERATION),</u> <u>909.10.6, 1602.1,</u> <u>1604.3,</u> <u>TABLE 1604.3,</u> <u>1604.4, 1604.5,</u> <u>TABLE 1604.5,</u> <u>1604.5.2,</u> <u>1604.8.2, 1604.9,</u> <u>1605.1, 1605.2.1,</u> <u>1605.3.1,</u> <u>1605.3.1.2,</u> <u>1607.8.1,</u> <u>1607.8.1.1,</u> <u>1607.8.1.2,</u> <u>1607.9, 1608.1,</u> <u>1608.3, 1609.1.1,</u> <u>1609.1.2,</u> <u>1609.1.6.1,</u> <u>1609.1.6.2,</u> <u>1609.5.3,</u> <u>1609.7.1, 1611.2,</u> <u>1612.1, 1613.1,</u> <u>1613.3.1,</u> <u>1613.3.2,</u> <u>1613.3.3,</u> <u>1613.3.4.1,</u> <u>1613.3.4.1.1,</u> <u>1613.3.5,</u> <u>1613.3.5.1,</u> <u>1613.3.5.2,</u> <u>1613.4, 1613.5,</u> <u>TABLE 1613.5,</u> <u>1613.6, 1614.1,</u> <u>1705.12, 1705.13,</u> <u>1801.2.1,</u> <u>1810.9.1.1,</u> <u>1810.9.2.2,</u>

<u>ASCE/</u> <u>SEI</u>	<u>American Society of Civil Engineers</u> <u>Structural Engineering Institute</u> <u>1801 Alexander Bell Drive</u> <u>Reston, VA 20191-4400</u>	
<u>Standard</u> <u>reference</u> <u>number</u>	<u>Title</u>	<u>Referenced</u> <u>in code</u> <u>section number</u>
		<u>1810.9.2.4,</u> <u>1811.6.3.2.1,</u> <u>1811.6.3.2.2,</u> <u>1816.2.1, 1901.2,</u> <u>1905.1.1,</u> <u>1905.1.2,</u> <u>1905.1.8,</u> <u>1908.1.1,</u> <u>1908.1.2,</u> <u>1908.1.5,</u> <u>1908.1.6, 2209.1,</u> <u>2210.2, 2304.6.1,</u> <u>TABLE 2306.3(3),</u> <u>TABLE 2308.7.5,</u> <u>2404.1, 2505.1,</u> <u>2505.2, 2506.2.1,</u> <u>G104.2.3.2,</u> <u>G304.2, G402</u>
<u>8—17</u>	<u>Standard Specification for the Design of Cold-formed</u> <u>Stainless Steel Structural Members</u>	<u>1604.3.3, 2210.1,</u> <u>2210.2</u>
<u>19—16</u>	<u>Structural Applications of Steel Cables for Buildings</u>	<u>2208.1</u>

<u>ASCE/</u> <u>SEI</u>	<u>American Society of Civil Engineers</u> <u>Structural Engineering Institute</u> <u>1801 Alexander Bell Drive</u> <u>Reston, VA 20191-4400</u>	
<u>Standard</u> <u>reference</u> <u>number</u>	<u>Title</u>	<u>Referenced</u> <u>in code</u> <u>section number</u>
<u>24—14*</u> <u>*As modified in</u> <u>Appendix G</u>	<u>Flood Resistant Design and Construction</u>	<u>202</u> <u>(DESIGN FLOOD</u> <u>ELEVATION),</u> <u>3001.2, G101.3,</u> <u>G102.1, G103.1,</u> <u>G104.2.1,</u> <u>G104.2.3.1,</u> <u>G104.2.3.2,</u> <u>G107.2, G107.3,</u> <u>G301.1, G303.3,</u> <u>G303.4, G303.5,</u> <u>G303.8, G304.1,</u> <u>G304.1.1,</u> <u>G304.1.2, G304.2,</u> <u>G304.3,</u> <u>G304.4.1.1,</u> <u>G305.2, G307.1,</u> <u>G307.2, G307.3,</u> <u>G308.1, G308.3,</u> <u>G308.5, G308.6,</u> <u>G308.7, G309.1,</u> <u>G310.3, G310.6</u>
<u>29—14</u>	<u>Standard Calculation Methods for Structural Fire</u> <u>Protection</u>	<u>722.1</u>
<u>32—17</u>	<u>Design and Construction of Frost Protected Shallow</u> <u>Foundations</u>	<u>1809.3.1</u>
<u>49—12</u>	<u>Wind Tunnel Testing for Buildings and Other Structures</u>	<u>1609.1.6.3</u>
<u>55—10</u>	<u>Tensile Membrane Structures</u>	<u>3102.7.3</u>

<u>ASME</u>	<u>American Society of Mechanical Engineers</u> <u>Two Park Avenue</u> <u>New York, NY 10016-5990</u>	
<u>Standard reference number</u>	<u>Title</u>	<u>Referenced in code section number</u>
<u>ASME/A17.1—13*</u> <u>CSA B44—2013</u> <u>*As modified in Appendix K</u>	<u>Safety Code for Elevators and Escalators</u>	<u>907.3.3, 911.1.6, 1009.4, 1607.10.1, 2409.2, 2409.3, 2409.4, 2409.4.1 3001.2, 3001.4, 3002.1.2, 3002.4.3.1, 3002.4.3.2, 3002.4.3.3, 3002.5, 3002.8, 3003.2, 3003.3.1, 3007.1, 3008.1.3, 3008.8.1, 3009.3, K1</u>
<u>A17.2—2014</u>	<u>Guide for Inspection of Elevators, Escalators & Moving Walks</u>	<u>3001.2,</u>
<u>A17.3—2015*</u> <u>*As modified in Appendix K</u>	<u>Safety Code for Existing Elevators And Escalators</u>	<u>3001.2, K3</u>
<u>A17.5—2013</u>	<u>Elevator and Escalator Electrical Equipment</u>	<u>3001.2</u>
<u>A17.6—2010</u>	<u>Standard for Elevator Suspension, Compensation, and Governor Systems</u>	<u>3001.2</u>
<u>A17.7—2007/ CSA B44—07</u>	<u>Performance-Based Safety Code for Elevators and Escalators</u>	<u>3001.2</u>
<u>A18.1—2014</u>	<u>Safety Standard for Platform Lifts and Stairway Chairlifts</u>	<u>1109.7.1, 1109.7.1.1, 3001.2</u>
<u>A90.1—09</u>	<u>Safety Standard for Belt Manlifts</u>	<u>3001.2</u>
<u>B16.18—2012</u>	<u>Cast Copper Alloy Solder Joint Pressure Fittings</u>	<u>909.13.1</u>
<u>B16.22—2001(R2010)</u>	<u>Wrought Copper and Copper Alloy Solder Joint Pressure Fittings</u>	<u>909.13.1</u>
<u>B20.1—2015*</u> <u>*As modified in Appendix K</u>	<u>Safety Standard for Conveyors and Related Equipment</u>	<u>3001.2, 3004.3</u>
<u>B31.3—2012</u>	<u>Process Piping</u>	<u>415.11.6</u>

<u>ASTM</u>	<u>ASTM International</u> <u>100 Barr Harbor Drive</u> <u>West Conshohocken, PA 19428-2959</u>	
<u>Standard reference number</u>	<u>Title</u>	<u>Referenced in code section number</u>
<u>A6/A6M—14</u>	<u>Standard Specification for General Requirements for Rolled Structural Steel Bars, Plates, Shapes and Sheet Piling</u>	<u>1811.7.1,</u> <u>1811.7.3,</u> <u>1811.7.6</u>
<u>A36/A36M—14</u>	<u>Specification for Carbon Structural Steel</u>	<u>1811.7.1</u>
<u>A153/A153M—16a</u>	<u>Specification for Zinc Coating (Hot-dip) on Iron and Steel Hardware</u>	<u>2304.10.5</u>
<u>A240/A240M—13A</u>	<u>Standard Specification for Chromium and Chromium-nickel Stainless Steel Plate, Sheet and Strip for Pressure Vessels and for General Applications</u>	<u>Table 1507.4.3(1)</u>
<u>A252—10</u>	<u>Specification for Welded and Seamless Steel Pipe Piles</u>	<u>1811.7.1,</u> <u>1811.7.1.2,</u> <u>1812.6.1</u>
<u>A283/A283M—13</u>	<u>Specification for Low and Intermediate Tensile Strength Carbon Steel Plates</u>	<u>1811.7.1,</u> <u>1812.6.1</u>
<u>A416/A416M—15</u>	<u>Specification for Steel Strand, Uncoated Seven-wire for Prestressed Concrete</u>	<u>1811.6.3.1,</u> <u>1815.3</u>
<u>A463/A463M—10</u>	<u>Standard Specification for Steel Sheet, Aluminum-coated, by the Hot-dip Process</u>	<u>Table 1507.4.3(2)</u>
<u>A572/A572M—15</u>	<u>Specification for High-strength Low-alloy Columbium-Vanadium Structural Steel</u>	<u>1811.7.1</u>
<u>A588/A588M—15</u>	<u>Specification for High-strength Low-alloy Structural Steel with 50 ksi (345 MPa) Minimum Yield Point with Atmospheric Corrosion Resistance</u>	<u>1811.7.1</u>
<u>A615/A615M—15ae1</u>	<u>Specification for Deformed and Plain Billet-steel Bars for Concrete Reinforcement</u>	<u>1812.7.2.1,</u> <u>1812.8.1</u>
<u>A653—15</u>	<u>Specification for Steel Sheet, Zinc-coated or Zinc-iron Alloy-coated Galvannealed by the Hot-dip Process</u>	<u>2304.10.5.1</u>
<u>A653/A653M—11</u>	<u>Specification for Steel Sheet, Zinc-coated Galvanized or Zinc-iron Alloy-coated Galvannealed by the Hot-dip Process</u>	<u>Table 1507.4.3(1),</u> <u>Table 1507.4.3(2)</u>

<u>ASTM</u>	<u>ASTM International</u> <u>100 Barr Harbor Drive</u> <u>West Conshohocken, PA 19428-2959</u>	
<u>Standard reference number</u>	<u>Title</u>	<u>Referenced in code section number</u>
<u>A690/A690M—13a</u>	<u>Standard Specification for High-strength Low-alloy Nickel, Copper, Phosphorus Steel H-piles and Sheet Piling with Atmospheric Corrosion Resistance for Use in Marine Environments</u>	<u>1811.7.1</u>
<u>A706/A706M—15</u>	<u>Specification for Low-alloy Steel Deformed and Plain Bars for Concrete Reinforcement</u>	<u>1705.3.1,</u> <u>1903.5.2, 2107.3</u>
<u>A722/A722M—15</u>	<u>Specification for Uncoated High-strength Steel Bar for Prestressing Concrete</u>	<u>1812.7.2.1,</u> <u>1812.8.1, 1815.3</u>
<u>A755/A755M—2011</u>	<u>Specification for Steel Sheet, Metallic-coated by the Hot-dip Process and Prepainted by the Coil-coating Process for Exterior Exposed Building Products</u>	<u>Table 1507.4.3(1),</u> <u>Table 1507.4.3(2)</u>
<u>A792/A792M—10</u>	<u>Specification for Steel Sheet, 55% Aluminum-zinc Alloy-coated by the (Hot-dip)Process</u>	<u>Table 1507.4.3(1),</u> <u>Table 1507.4.3(2)</u>
<u>A875/A875M—13</u>	<u>Standard Specification for Steel Sheet Zinc-5 percent, Aluminum Alloy-coated by the (Hot-dip) Process</u>	<u>Table 1507.4.3(2)</u>
<u>A822—04a(2010)</u>	<u>Standard Specification for Filled Epoxy-Coated Seven-Wire Prestressing Steel Strand</u>	<u>1815.3</u>
<u>A924/A924M—13</u>	<u>Standard Specification for General Requirements for Steel Sheet, Metallic-coated by the Hot-dip Process</u>	<u>Table 1507.4.3(1)</u>
<u>B42—10</u>	<u>Specification for Seamless Copper Pipe, Standard Sizes</u>	<u>909.13.1</u>
<u>B43—09</u>	<u>Specification for Seamless Red Brass Pipe, Standard Sizes</u>	<u>909.13.1</u>
<u>B68—11</u>	<u>Specification for Seamless Copper Tube, Bright Annealed (Metric)</u>	<u>909.13.1</u>
<u>B88—09</u>	<u>Specification for Seamless Copper Water Tube</u>	<u>909.13.1</u>
<u>B101—12</u>	<u>Specification for Lead-coated Copper Sheet and Strip for Building Construction</u>	<u>1404.5.3,</u> <u>Table 1507.2.9.2,</u> <u>Table 1507.4.3(1)</u>
<u>B209—10</u>	<u>Specification for Aluminum and Aluminum Alloy Steel and Plate</u>	<u>Table 1507.4.3(1)</u>

<u>ASTM</u>	<u>ASTM International</u> <u>100 Barr Harbor Drive</u> <u>West Conshohocken, PA 19428-2959</u>	
<u>Standard reference number</u>	<u>Title</u>	<u>Referenced in code section number</u>
<u>B251—10</u>	<u>Specification for General Requirements for Wrought Seamless Copper and Copper-alloy Tube</u>	<u>909.13.1</u>
<u>B280—08</u>	<u>Specification for Seamless Copper Tube for Air Conditioning and Refrigeration Field Service</u>	<u>909.13.1</u>
<u>B370—12</u>	<u>Specification for Copper Sheet and Strip for Building Construction</u>	<u>1404.5.2,</u> <u>Table 1507.2.9.2,</u> <u>Table 1507.4.3(1)</u>
<u>B695—04(2016)</u>	<u>Standard Specification for Coatings of Zinc Mechanically Deposited on Iron and Steel</u>	<u>2304.10.5.1,</u> <u>2304.10.5.3</u>
<u>C5—10</u>	<u>Specification for Quicklime for Structural Purposes</u>	<u>Table 2507.2</u>
<u>C22/C22M-00(2010)</u>	<u>Specification for Gypsum</u>	<u>Table 2506.2</u>
<u>C27—98 (2013)</u>	<u>Specification for Classification of Fireclay and High-alumina Refractory Brick</u>	<u>2111.6, 2111.9</u>
<u>C28/C28M—10</u>	<u>Specification for Gypsum Plasters</u>	<u>Table 2507.2</u>
<u>C31/C31M—15</u>	<u>Practice for Making and Curing Concrete Test Specimens in the Field</u>	<u>Table 1705.8.1</u> <u>1905.1.3,</u> <u>1905.6.3.3,</u> <u>1905.6.3.3.1,</u> <u>1905.6.3.8,</u> <u>1905.6.4.2,</u> <u>3305.3.5.6</u>
<u>C33/C33M—13</u>	<u>Specification for Concrete Aggregates</u>	<u>722.3.1.4,</u> <u>722.4.1.1.3</u>
<u>C35/C35M—1995(2009)</u>	<u>Specification for Inorganic Aggregates for Use in Gypsum Plaster</u>	<u>Table 2507.2</u>
<u>C39/C39M—14a</u>	<u>Test Method for Compressive Strength of Cylindrical Concrete Specimens</u>	<u>1812.1.1.2.2,</u> <u>1905.6.3.3.3,</u> <u>1911.5.2,</u> <u>1911.10.3</u>
<u>C42/C42M—13</u>	<u>Standard Test Method for Obtaining and Testing Drilled Cores and Sawed Beams of Concrete</u>	<u>1905.6.5.2,</u> <u>1911.5.1,</u> <u>1911.10,</u> <u>1911.10.1</u>
<u>C55—2011</u>	<u>Specification for Concrete Building Brick</u>	<u>Table 722.3.2</u>

<u>ASTM</u>	<u>ASTM International</u> <u>100 Barr Harbor Drive</u> <u>West Conshohocken, PA 19428-2959</u>	
<u>Standard reference number</u>	<u>Title</u>	<u>Referenced in code section number</u>
<u>C59/C59M—00 (2011)</u>	<u>Specification for Gypsum Casting Plaster and Molding Plaster</u>	<u>Table 2507.2</u>
<u>C61/C61M—00 (2011)</u>	<u>Specification for Gypsum Keene’s Cement</u>	<u>Table 2507.2</u>
<u>C67—13</u>	<u>Test Methods of Sampling and Testing Brick and Structural Clay Tile</u>	<u>721.4.1.1.1</u>
<u>C73—10</u>	<u>Specification for Calcium Silicate Brick (Sand-lime Brick)</u>	<u>Table 722.3.2</u>
<u>C90—13</u>	<u>Specification for Loadbearing Concrete Masonry Units</u>	<u>Table 722.3.2</u>
<u>C91—12</u>	<u>Specification for Masonry Cement</u>	<u>Table 2507.2</u>
<u>C94/C94M—15</u>	<u>Specification for Ready-Mixed Concrete</u>	<u>110.3.1, 1905.1.3, 1905.6.3.8, 1905.8.2</u>
<u>C138/C138M—17a</u>	<u>Standard Test Method for Density (Unit Weight) Yield and Air Content (Gravimetric) of Concrete</u>	<u>1812.1.1.2.3, 1905.6.3.6</u>
<u>C140—13</u>	<u>Test Method Sampling and Testing Concrete Masonry Units and Related Units</u>	<u>722.3.1.2</u>
<u>C143—15a</u>	<u>Standard Test Method for Slump of Hydraulic-cement Concrete</u>	<u>1905.6.3.6</u>
<u>C150—15</u>	<u>Specification for Portland Cement</u>	<u>Table 1904.4.2</u> <u>Table 2507.2</u>
<u>C172/C172M—14a</u>	<u>Practice for Sampling Freshly Mixed Concrete</u>	<u>Table 1705.3</u> <u>1905.6.3.2</u>
<u>C173/C173M—14</u>	<u>Standard Test Method for Air Content of Freshly Mixed Concrete by the Volumetric Method</u>	<u>1905.6.3.6</u>
<u>C199—84 (2016)</u>	<u>Test Method for Pier Test for Refractory Mortars</u>	<u>2111.6, 2111.9, 2113.12</u>
<u>C206—13</u>	<u>Specification for Finishing Hydrated Lime</u>	<u>Table 2507.2</u>
<u>C208—12</u>	<u>Specification for Cellulosic Fiber Insulating Board</u>	<u>Table 1508.2,</u> <u>2303.1.6</u>
<u>C216—13</u>	<u>Specification for Facing Brick (Solid Masonry Units Made from Clay or Shale)</u>	<u>Table 721.1(2),</u>

<u>ASTM</u>	<u>ASTM International</u> <u>100 Barr Harbor Drive</u> <u>West Conshohocken, PA 19428-2959</u>	
<u>Standard reference number</u>	<u>Title</u>	<u>Referenced in code section number</u>
<u>C231/C231M—14</u>	<u>Standard Test Method for Air Content of Freshly Mixed Concrete by the Pressure Method</u>	<u>1905.6.3.6</u>
<u>C260/C260M—10a(2016)</u>	<u>Standard Specification for Air-entraining Admixtures for Concrete</u>	<u>1905.3.4</u>
<u>C270—14a</u>	<u>Specification for Mortar for Unit Masonry</u>	<u>2103.2.4</u>
<u>C315—07(2016)</u>	<u>Specification for Clay Flue Liners and Chimney Pots</u>	<u>2111.9,</u> <u>2113.11.1,</u> <u>Table 2113.16(1),</u> <u>Table 2113.16(2)</u>
<u>C317/C317M—00(2010)</u>	<u>Specification for Gypsum Concrete</u>	<u>2514.1</u>
<u>C330/C330M—2014</u>	<u>Specification for Lightweight Aggregates for Structural Concrete</u>	<u>202 (CONCRETE,</u> <u>LIGHTWEIGHT</u> <u>AGGREGATE;</u> <u>CONCRETE, SAND-</u> <u>LIGHTWEIGHT),</u> <u>1905.1.4</u>
<u>C331/C331M—2010</u>	<u>Specification for Lightweight Aggregates for Concrete Masonry Units</u>	<u>722.3.1.4,</u> <u>722.4.1.1.3</u>
<u>C406/C406M—2010</u>	<u>Specification for Roofing Slate</u>	<u>1507.7.5</u>
<u>C472—99 (2009)</u>	<u>Specification for Standard Test Methods for Physical Testing of Gypsum, Gypsum Plasters and Gypsum Concrete</u>	<u>Table 2506.2</u>
<u>C473—12</u>	<u>Test Method for Physical Testing of Gypsum Panel Products</u>	<u>Table 2506.2</u>
<u>C474—13</u>	<u>Test Methods for Joint Treatment Materials for Gypsum Board Construction</u>	<u>Table 2506.2</u>
<u>C475/C475M—12</u>	<u>Specification for Joint Compound and Joint Tape for Finishing Gypsum Board</u>	<u>Table 2506.2</u>
<u>C476—18</u>	<u>Specification for Grout for Masonry</u>	<u>202 (GROUT)</u>
<u>C 494—13</u>	<u>Standard Specification for Chemical Admixtures for Concrete</u>	<u>1905.3.4</u>

<u>ASTM</u>	<u>ASTM International</u> <u>100 Barr Harbor Drive</u> <u>West Conshohocken, PA 19428-2959</u>	
<u>Standard reference number</u>	<u>Title</u>	<u>Referenced in code section number</u>
<u>C511—13</u>	<u>Standard Specification for Mixing Rooms, Moist Cabinets, Moist Rooms, and Water Storage Tanks Used in the Testing of Hydraulic Cements and Concretes</u>	<u>1905.6.3.3.2</u>
<u>C514—04(2009)e1</u>	<u>Specification for Nails for the Application of Gypsum Board</u>	<u>Table 721.1(2),</u> <u>Table 721.1(3),</u> <u>Table 2506.2</u>
<u>C516—08</u>	<u>Specifications for Vermiculite Loose Fill Thermal Insulation</u>	<u>722.3.1.4,</u> <u>722.4.1.1.3</u>
<u>C547—12</u>	<u>Specification for Mineral Fiber Pipe Insulation</u>	<u>Table 721.1(2),</u> <u>Table 721.1(3)</u>
<u>C549—06(2012)</u>	<u>Specification for Perlite Loose Fill Insulation</u>	<u>722.3.1.4,</u> <u>722.4.1.1.3</u>
<u>C552—12b</u>	<u>Standard Specification for Cellular Glass Thermal Insulation</u>	<u>Table 1508.2</u>
<u>C 557—03 (2009)</u>	<u>Specification for Adhesives for Fastening Gypsum Wallboard to Wood Framing</u>	<u>Table 2506.2</u>
<u>C578—12b</u>	<u>Standard Specification for Rigid, Cellular Polystyrene Thermal Insulation</u>	<u>Table 1508.2,</u> <u>2603.10</u>
<u>C587—04(2009)</u>	<u>Specification for Gypsum Veneer Plaster</u>	<u>Table 2507.2</u>
<u>C595/C595M—14e1</u>	<u>Specification for Blended Hydraulic Cements</u>	<u>Table 1904.4.2,</u> <u>Table 2507.2</u>
<u>C618—12a</u>	<u>Specification for Coal Fly Ash and Raw or Calcined Natural Pozzolan for Use in Concrete</u>	<u>Table 1904.4.2</u>
<u>C631—09</u>	<u>Specification for Bonding Compounds for Interior Gypsum Plastering</u>	<u>Table 2507.2</u>
<u>C 635—00*</u> <u>*As modified in</u> <u>Appendix R</u>	<u>Specification for the Manufacture, Performance and Testing of Metal Suspension Systems for Acoustical Tile and Lay-in Panel Ceilings</u>	<u>808.1.1.1, R101.1,</u> <u>R102.1, R102.2,</u> <u>R102.3, Q102.1</u>

<u>ASTM</u>	<u>ASTM International</u> <u>100 Barr Harbor Drive</u> <u>West Conshohocken, PA 19428-2959</u>	
<u>Standard reference number</u>	<u>Title</u>	<u>Referenced in code section number</u>
<u>C 636—96*</u> <u>*As modified in Appendix R</u>	<u>Practice for Installation of Metal Ceiling Suspension Systems for Acoustical Tile and Lay-in Panels</u>	<u>808.1.1.1, R101.1, R103.1, R103.2, R103.3, R103.4, R103.5, R103.6, R103.7, R103.8, R103.9, R103.10, R103.11, R103.12, R103.13, R103.14</u>
<u>C645—13</u>	<u>Specification for Nonstructural Steel Framing Members</u>	<u>Table 2506.2, Table 2507.2</u>
<u>C685—11</u>	<u>Standard Specification for Concrete Made by Volumetric Batching</u>	<u>1905.8.2</u>
<u>C726—12</u>	<u>Standard Specification for Mineral Roof Insulation Board</u>	<u>Table 1508.2</u>
<u>C728—05(2013)</u>	<u>Standard Specification for Perlite Thermal Insulation Board</u>	<u>Table 1508.2</u>
<u>C744—11</u>	<u>Specification for Prefaced Concrete and Calcium Silicate Masonry Units</u>	<u>Table 722.3.2</u>
<u>C754—11</u>	<u>Specification for Installation of Steel Framing Members to Receive Screw-attached Gypsum Panel Products</u>	<u>Table 2508.1, Table 2511.1.1</u>
<u>C836/C836M—12</u>	<u>Specification for High-solids Content, Cold Liquid-applied Elastomeric Waterproofing Membrane for Use with Separate Wearing Course</u>	<u>1507.15.2</u>
<u>C840—11</u>	<u>Specification for Application and Finishing of Gypsum Board</u>	<u>Table 2508.1, 2509.2</u>
<u>C841—03(2008)E1</u>	<u>Specification for Installation of Interior Lathing and Furring</u>	<u>Table 2508.1, Table 2511.1.1</u>
<u>C842—05(2010)E1</u>	<u>Specification for Application of Interior Gypsum Plaster</u>	<u>Table 2511.1.1, 2511.3, 2511.4</u>
<u>C843—99 (2012)</u>	<u>Specification for Application of Gypsum Veneer Plaster</u>	<u>Table 2511.1.1</u>
<u>C844—04(2010)</u>	<u>Specification for Application of Gypsum Base to Receive Gypsum Veneer Plaster</u>	<u>Table 2508.1</u>

<u>ASTM</u>	<u>ASTM International</u> <u>100 Barr Harbor Drive</u> <u>West Conshohocken, PA 19428-2959</u>	
<u>Standard reference number</u>	<u>Title</u>	<u>Referenced in code section number</u>
<u>C845/C845M—12</u>	<u>Standard Specification for Expansive Hydraulic Cement</u>	<u>Table 1904.4.2</u>
<u>C847—12</u>	<u>Specification for Metal Lath</u>	<u>Table 2507.2</u>
<u>C887—13</u>	<u>Specification for Packaged, Dry Combined Materials for Surface Bonding Mortar</u>	<u>2103.2.2</u>
<u>C897—05(2009)</u>	<u>Specification for Aggregate for Job-Mixed Portland Cement-based Plaster</u>	<u>Table 2507.2</u>
<u>C920—11</u>	<u>Standard for Specification for Elastomeric Joint Sealants</u>	<u>Table 2506.2</u>
<u>C926—13</u>	<u>Specification for Application of Portland Cement-based Plaster</u>	<u>2510.3,</u> <u>Table 2511.1.1,</u> <u>2511.3, 2511.4,</u> <u>2512.1, 2512.1.2,</u> <u>2512.2, 2512.6,</u> <u>2512.8.2, 2512.9,</u> <u>2513.7</u>
<u>C932—06 (2013)</u>	<u>Specification for Surface-applied Bonding Compounds for Exterior Plastering</u>	<u>Table 2507.2</u>
<u>C933—13</u>	<u>Specification for Welded Wire Lath</u>	<u>Table 2507.2</u>
<u>C946—10</u>	<u>Specification for Construction of Dry-stacked, Surface-bonded Walls</u>	<u>2103.2.2,</u> <u>2109.2.2</u>
<u>C954—11</u>	<u>Specification for Steel Drill Screws for the Application of Gypsum Panel Products or Metal Plaster Bases to Steel Studs from 0.033 inch (0.84 mm) to 0.112 inch (2.84 mm) in Thickness</u>	<u>Table 2506.2,</u> <u>Table 2507.2</u>
<u>C955—11C</u>	<u>Standard Specification for Load-bearing Transverse and Axial Steel Studs, Runners Tracks, and Bracing or Bridging, for Screw Application of Gypsum Panel Products and Metal Plaster Bases</u>	<u>Table 2506.2,</u> <u>Table 2507.2</u>
<u>C956—04(2010)</u>	<u>Specification for Installation of Cast-in-place Reinforced Gypsum Concrete</u>	<u>2514.1</u>
<u>C957—10</u>	<u>Specification for High-solids Content, Cold Liquid-applied Elastomeric Waterproofing Membrane with Integral Wearing Surface</u>	<u>1507.15.2</u>

<u>ASTM</u>	<u>ASTM International</u> <u>100 Barr Harbor Drive</u> <u>West Conshohocken, PA 19428-2959</u>	
<u>Standard reference number</u>	<u>Title</u>	<u>Referenced in code section number</u>
<u>C989/C989M—13</u>	<u>Standard Specification for Slag Cement for Use in Concrete and Mortars</u>	<u>Table 1904.4.2</u>
<u>C1002—07</u>	<u>Specification for Steel Self-piercing Tapping Screws for the Application of Gypsum Panel Products or Metal Plaster Bases to Wood Studs or Steel Studs</u>	<u>Table 2506.2,</u> <u>Table 2507.2</u>
<u>C1007—11a</u>	<u>Specification for Installation of Load Bearing (Transverse and Axial) Steel Studs and Related Accessories</u>	<u>Table 2508.1,</u> <u>Table 2511.1.1</u>
<u>C1029—13</u>	<u>Specification for Spray-applied Rigid Cellular Polyurethane Thermal Insulation</u>	<u>1507.14.2</u>
<u>C1032—06(2011)</u>	<u>Specification for Woven Wire Plaster Base</u>	<u>Table 2507.2</u>
<u>C1047—10A</u>	<u>Specification for Accessories for Gypsum Wallboard and Gypsum Veneer Base</u>	<u>Table 2506.2,</u> <u>Table 2507.2</u>
<u>C1063—12D</u>	<u>Specification for Installation of Lathing and Furring to Receive Interior and Exterior Portland Cement-based Plaster</u>	<u>2510.3,</u> <u>Table 2511.1.1,</u> <u>2512.1.1</u>
<u>C1064/C1064M—17</u>	<u>Standard Test Method for Temperature of Freshly Mixed Hydraulic-cement Concrete</u>	<u>1905.6.3.6</u>
<u>C1074—19</u>	<u>Standard Practice for Estimating Concrete Strength by the Maturity Method</u>	<u>3305.3.5.1.3</u>
<u>C1088—13</u>	<u>Specification for Thin Veneer Brick Units Made from Clay or Shale</u>	<u>Table 721.1(2)</u>
<u>C1157/C1157M—11</u>	<u>Standard Performance Specification for Hydraulic Cement</u>	<u>Table 1904.4.2,</u> <u>Table 2507.2</u>
<u>C1167—11</u>	<u>Specification for Clay Roof Tiles</u>	<u>1507.3.4</u>
<u>C1177/C1177M—08</u>	<u>Specification for Glass Mat Gypsum Substrate for Use as Sheathing</u>	<u>Figure 722.5.1(2),</u> <u>Figure 722.5.1(3),</u> <u>Table 1508.2,</u> <u>Table 2506.2</u>
<u>C1178/C1178M—11</u>	<u>Specification for Coated Mat Water-resistant Gypsum Backing Panel</u>	<u>Figure 722.5.1(2),</u> <u>Figure 722.5.1(3),</u> <u>Table 2506.2,</u> <u>Table 2509.2</u>

<u>ASTM</u>	<u>ASTM International</u> <u>100 Barr Harbor Drive</u> <u>West Conshohocken, PA 19428-2959</u>	
<u>Standard reference number</u>	<u>Title</u>	<u>Referenced in code section number</u>
<u>C1186—08(2012)</u>	<u>Specification for Flat Fiber Cement Sheets</u>	<u>1404.10,</u> <u>1405.16.1,</u> <u>1405.16.2</u>
<u>C1240—14</u>	<u>Standard Specification for Silica Fume Used in Cementitious Mixtures</u>	<u>Table 1904.4.2</u>
<u>C1261—10</u>	<u>Specification for Firebox Brick for Residential Fireplaces</u>	<u>2111.6, 2111.9</u>
<u>C1278M—07a(2011)</u>	<u>Specification for Fiber-reinforced Gypsum Panels</u>	<u>Figure 722.5.1(2),</u> <u>Figure 722.5.1(3),</u> <u>Table 1508.2,</u> <u>Table 2506.2</u>
<u>C1280—13</u>	<u>Specification for Application of Exterior Gypsum Panel Products for Use as Sheathing</u>	<u>Table 2508.1,</u> <u>2508.2</u>
<u>C1283—11</u>	<u>Practice for Installing Clay Flue Lining</u>	<u>2113.9.1, 2113.12</u>
<u>C1288—99 (2010)</u>	<u>Standard Specification for Discrete Nonasbestos Fiber-cement Interior Substrate Sheets</u>	<u>Table 2509.2</u>
<u>C1289—13E1</u>	<u>Standard Specification for Faced Rigid Cellular Polyisocyanurate Thermal Insulation Board</u>	<u>Table 1508.2,</u> <u>2603.10</u>
<u>C1313/C1313M—12</u>	<u>Standard Specification for Sheet Radiant Barriers for Building Construction Applications</u>	<u>1509.4</u>
<u>C1325—08b</u>	<u>Standard Specification for Nonasbestos Fiber-mat Reinforced Cement Backer Units</u>	<u>Table 2509.2</u>
<u>C1328/C1328M—12</u>	<u>Specification for Plastic (Stucco Cement)</u>	<u>Table 2507.2</u>
<u>C1364—10B</u>	<u>Standard Specification for Architectural Cast Stone</u>	<u>2103.1</u>
<u>C 1371—04a(2010)e1</u>	<u>Standard Test Method for Determination of Emittance of Materials Near Room Temperature Using Portable Emissometers</u>	<u>1504.9</u>
<u>C1386—07</u>	<u>Specification for Precast Autoclaved Aerated Concrete (AAC) Wall Construction Units</u>	<u>202</u> <u>(AUTOCLAVED</u> <u>AERATED</u> <u>CONCRETE (AAC)),</u> <u>2102.1,</u>

<u>ASTM</u>	<u>ASTM International</u> <u>100 Barr Harbor Drive</u> <u>West Conshohocken, PA 19428-2959</u>	
<u>Standard reference number</u>	<u>Title</u>	<u>Referenced in code section number</u>
<u>C1396M/C1396M—13</u>	<u>Specification for Gypsum Board</u>	<u>Table 2506.2,</u> <u>Table 2508.1</u> <u>Figure 722.5.1(2),</u> <u>Figure 722.5.1(3)</u>
<u>C1492—03(2009)</u>	<u>Standard Specification for Concrete Roof Tile</u>	<u>1507.3.5</u>
<u>C 1549—09</u>	<u>Standard Test Method for Determination of Solar Reflectance Near Ambient Temperature Using a Portable Solar Reflectometer</u>	<u>1504.9</u>
<u>C1600/C 1600M—11</u>	<u>Standard Specification for Rapid Hardening Hydraulic Cement</u>	<u>Table 2507.2</u>
<u>C1629/</u> <u>C1629M—06(2011)</u>	<u>Standard Classification for Abuse-resistant Nondecorated Interior Gypsum Panel Products and Fiber-reinforced Cement Panels</u>	<u>403.2.3.1,</u> <u>403.2.3.2,</u> <u>403.2.3.4</u>
<u>C1658/C1658M—12</u>	<u>Standard Specification for Glass Mat Gypsum Panels</u>	<u>Figure 722.5.1(2),</u> <u>Figure 722.5.1(3),</u> <u>Table 2506.2</u>
<u>C1670—16</u>	<u>Standard Specification for Adhered Manufactured Stone Masonry Veneer Units</u>	<u>2103.1</u>
<u>D25—12(2017)</u>	<u>Specification for Round Timber Piles</u>	<u>1811.5.1,</u> <u>1811.5.4,</u> <u>2303.1.12</u>
<u>D41—05</u>	<u>Specification for Asphalt Primer Used in Roofing, Dampproofing and Waterproofing</u>	<u>Table 1507.10.2</u>
<u>D43—00(2006)</u>	<u>Specification for Coal Tar Primer Used in Roofing, Dampproofing and Waterproofing</u>	<u>Table 1507.10.2</u>
<u>D56—05(2010)</u>	<u>Test Method for Flash Point By Tag Closed Tester</u>	<u>202 (FLASHPOINT)</u>
<u>D86—2012</u>	<u>Test Method for Distillation of Petroleum Products at Atmospheric Pressure</u>	<u>202</u> <u>(BOILING POINT)</u>
<u>D93—2012</u>	<u>Test Method for Flash Point By Pensky-Martens Closed Cup Tester</u>	<u>202 (FLASHPOINT)</u>
<u>D225—07</u>	<u>Specification for Asphalt Shingles (Organic Felt) Surfaced with Mineral Granules</u>	<u>1507.2.5</u>

<u>ASTM</u>	<u>ASTM International</u> <u>100 Barr Harbor Drive</u> <u>West Conshohocken, PA 19428-2959</u>	
<u>Standard reference number</u>	<u>Title</u>	<u>Referenced in code section number</u>
<u>D226/D226M—09</u>	<u>Specification for Asphalt-saturated Organic Felt Used in Roofing and Waterproofing</u>	<u>1404.2, 1505.2, 1507.2.3, 1507.3.3, 1507.5.3, 1507.6.3, 1507.7.3, Table 1507.8, 1507.8.3, 1507.9.3, 1507.9.5, Table 1507.10.2, 1507.17.3, 1507.17.4.1</u>
<u>D227/D227M—03(2011)E1</u>	<u>Specification for Coal-tar-saturated Organic Felt Used in Roofing and Waterproofing</u>	<u>Table 1507.10.2</u>
<u>D312—00 (2006)</u>	<u>Specification for Asphalt Used in Roofing</u>	<u>Table 1507.10.2</u>
<u>D448—08</u>	<u>Standard Classification for Sizes of Aggregate for Road and Bridge Construction</u>	<u>1507.12.3, 1507.13.3</u>
<u>D450—07</u>	<u>Specification for Coal-tar Pitch Used in Roofing, Dampproofing and Waterproofing</u>	<u>Table 1507.10.2</u>
<u>D635—10</u>	<u>Test Method for Rate of Burning and/or Extent and Time of Burning of Plastics in a Horizontal Position</u>	<u>2606.4, H107.1.1, H117.4</u>
<u>D692/D692M—15</u>	<u>Standard Specification for Coarse Aggregate for Bituminous Paving Mixtures</u>	<u>1913.2</u>
<u>D1073—16</u>	<u>Standard Specification for Fine Aggregate for Asphalt Paving Mixtures</u>	<u>1913.2</u>
<u>D1143/D1143M—07(2013)e1</u>	<u>Standard Test Methods for Deep Foundations Under Static Axial Compressive Load</u>	<u>1810.4.1.3, 1810.4.1.5.1, 1814.4.1</u>
<u>D1227—95 (2007)</u>	<u>Specification for Emulsified Asphalt Used as a Protective Coating for Roofing</u>	<u>Table 1507.10.2, 1507.15.2</u>
<u>D1557—12e1</u>	<u>Test Method for Laboratory Compaction Characteristics of Soil Using Modified Effort (56,000 ft-lb/ ft³ (2,700 KN m/m³))</u>	<u>1806.2.2</u>
<u>D1586—18</u>	<u>Specification for Penetration Test and Split-barrel Sampling of Soils</u>	<u>1613.3.4.1, 1803.5</u>

<u>ASTM</u>	<u>ASTM International</u> <u>100 Barr Harbor Drive</u> <u>West Conshohocken, PA 19428-2959</u>	
<u>Standard reference number</u>	<u>Title</u>	<u>Referenced in code section number</u>
<u>D 1587—15</u>	<u>Standard Practice for Thin-walled Tube Sampling of Fine-Grained Soils for Geotechnical Purposes</u>	<u>1803.5</u>
<u>D 1761—12</u>	<u>Test Method for Mechanical Fasteners in Wood</u>	<u>1712.1.1,</u> <u>1712.1.2,</u> <u>1712.1.3</u>
<u>D1863/D1863M—05(2011)E1</u>	<u>Specification for Mineral Aggregate Used on Built-up Roofs</u>	<u>Table 1507.10.2</u>
<u>D1929—12</u>	<u>Test Method for Determining Ignition Temperature of Plastics</u>	<u>402.6.4.4,</u> <u>1407.11.2.1,</u> <u>2606.4</u>
<u>D1970/D1970M—2013</u>	<u>Specification for Self-adhering Polymer Modified Bituminous Sheet Materials Used as Steep Roof Underlayment for Ice Dam Protection</u>	<u>1507.2.3</u> <u>1507.2.4,</u> <u>1507.2.9.2,</u> <u>1507.3.9,</u> <u>1507.5.7,</u> <u>1507.8.8,</u> <u>1507.9.9,</u> <u>1507.17.4.1</u>
<u>D 2113—14</u>	<u>Standard Practice for Rock Core Drilling and Sampling of Rock for Site Investigation</u>	<u>1803.5</u>
<u>D2166—16</u>	<u>Standard Test Method for Unconfined Compressive Strength of Cohesive Soil</u>	<u>1613.3.4.1</u>
<u>D2178—04</u>	<u>Specification for Asphalt Glass Felt Used in Roofing and Waterproofing</u>	<u>Table 1507.10.2</u>
<u>D2216—19</u>	<u>Test Method for Laboratory Determination of Water (Moisture) Content of Soil and Rock by Mass</u>	<u>1613.3.4.1</u>
<u>D2487—2017</u>	<u>Practice for Classification of Soils for Engineering Purposes (Unified Soil Classification System)</u>	<u>Table 1610.1,</u> <u>1803.3</u>
<u>D2626/D2626M—04(2012)E1</u>	<u>Specification for Asphalt Saturated and Coated Organic Felt Base Sheet Used in Roofing</u>	<u>1507.3.3,</u> <u>Table 1507.10.2</u>
<u>D2822/D2822M—05(2011)E1</u>	<u>Specification for Asphalt Roof Cement, Asbestos Containing</u>	<u>Table 1507.10.2</u>
<u>D2823/D2823M—05(2011)E1</u>	<u>Specification for Asphalt Roof Coatings, Asbestos Containing</u>	<u>Table 1507.10.2</u>

<u>ASTM</u>	<u>ASTM International</u> <u>100 Barr Harbor Drive</u> <u>West Conshohocken, PA 19428-2959</u>	
<u>Standard reference number</u>	<u>Title</u>	<u>Referenced in code section number</u>
<u>D2824—06(2012)E1</u>	<u>Standard Specification for Aluminum-Pigmented Asphalt Roof Coating, Nonfibered, Asbestos Fibered and Fibered without Asbestos</u>	<u>Table 1507.10.2</u>
<u>D2843—10</u>	<u>Test for Density of Smoke from the Burning or Decomposition of Plastics</u>	<u>2606.4</u>
<u>D2850—15</u>	<u>Standard Test Method for Unconsolidated-Undrained Triaxial Compression Test on Cohesive Soils</u>	<u>1613.3.4.1</u>
<u>D2898—10 (2017)</u>	<u>Test Methods for Accelerated Weathering of Fire-retardant-treated Wood for Fire Testing</u>	<u>1505.1, 2303.2.4, 2303.2.6</u>
<u>D3019—08</u>	<u>Specification for Lap Cement Used with Asphalt Roll Roofing, Nonfibered, Asbestos Fibered and Nonasbestos Fibered</u>	<u>Table 1507.10.2</u>
<u>D3161/D3161M—13</u>	<u>Test Method for a Wind Resistance of Asphalt Shingles (Fan Induced Method)</u>	<u>1504.1.1, Table 1504.1.1, 1507.17.8</u>
<u>D3200—74 (2017)</u>	<u>Standard Specification and Test Method for Establishing Recommended Design Stresses for Round Timber Construction Poles</u>	<u>2303.1.12</u>
<u>D3201—2013</u>	<u>Test Method for Hygroscopic Properties of Fire-retardant Wood and Wood-based Products</u>	<u>2303.2.7</u>
<u>D3273—12</u>	<u>Standard Test Method for Resistance to Growth of Mold on the Surface of Interior Coatings in an Environmental Chamber</u>	<u>2506.3</u>
<u>D3278—1996 (2011)</u>	<u>Test Methods for Flash Point of Liquids by Small Scale Closed-cup Apparatus</u>	<u>202 (FLASHPOINT)</u>
<u>D3441—2016</u>	<u>Standard Test Method for Mechanical Cone Penetration Testing of Soils</u>	<u>1803.5.2</u>
<u>D3462/D3462M—10A</u>	<u>Specification for Asphalt Shingles Made from Glass Felt and Surfaced with Mineral Granules</u>	<u>1507.2.5</u>
<u>D3468—99 (2006) e01</u>	<u>Specification for Liquid-applied Neoprene and Chlorosulfonated Polyethylene Used in Roofing and Waterproofing</u>	<u>1507.15.2</u>
<u>D3679—11</u>	<u>Specification for Rigid Poly (Vinyl Chloride) (PVC) Siding</u>	<u>1404.9, 1405.14</u>

<u>ASTM</u>	<u>ASTM International</u> <u>100 Barr Harbor Drive</u> <u>West Conshohocken, PA 19428-2959</u>	
<u>Standard reference number</u>	<u>Title</u>	<u>Referenced in code section number</u>
<u>D3689—07(2013)E1</u>	<u>Test Methods for Deep Foundations Under Static Axial Tensile Load</u>	<u>1810.4.2.1,</u> <u>1814.4.2</u>
<u>D3737—2018</u>	<u>Practice for Establishing Allowable Properties for Structural Glued Laminated Timber (Glulam)</u>	<u>2303.1.3</u>
<u>D3746—85 (2008)</u>	<u>Test Method for Impact Resistance of Bituminous Roofing Systems</u>	<u>1504.7</u>
<u>D3747—79 (2007)</u>	<u>Specification for Emulsified Asphalt Adhesive for Adhering Roof Insulation</u>	<u>Table 1507.10.2</u>
<u>D3909/D3909M—97b (2012)e1</u>	<u>Specification for Asphalt Roll Roofing (Glass Felt) Surfaced with Mineral Granules</u>	<u>1507.2.9.2,</u> <u>1507.6.5,</u> <u>Table 1507.10.2</u>
<u>D3957—09 (2015)</u>	<u>Standard Practices for Establishing Stress Grades for Structural Members Used in Log Buildings</u>	<u>2303.1.11</u>
<u>D 3966—07(2013)E1</u>	<u>Standard Test Methods for Deep Foundations Under Lateral Loads</u>	<u>1810.4.3,</u> <u>1810.4.3.3</u>
<u>D4022/D4022M—2007(2012)E1</u>	<u>Specification for Coal Tar Roof Cement, Asbestos Containing</u>	<u>Table 1507.10.2</u>
<u>D4272—09</u>	<u>Test Method for Total Energy Impact of Plastic Films by Dart Drop</u>	<u>1504.7</u>
<u>D4318—2013E1</u>	<u>Test Methods for Liquid Limit, Plastic Limit and Plasticity Index of Soils</u>	<u>1613.3.4.1</u>
<u>D4434/D4434M—12</u>	<u>Specification for Poly (Vinyl Chloride) Sheet Roofing</u>	<u>1507.13.2</u>
<u>D4479/D4479M—07(2012)E1</u>	<u>Specification for Asphalt Roof Coatings-Asbestos-free</u>	<u>Table 1507.10.2</u>
<u>D4586/D4586M—07(2012)E1</u>	<u>Specification for Asphalt Roof Cement-Asbestos-free</u>	<u>Table 1507.10.2</u>
<u>D4601/D4601M—04(2012)E1</u>	<u>Specification for Asphalt-coated Glass Fiber Base Sheet Used in Roofing</u>	<u>Table 1507.10.2</u>
<u>D4637/D4637M—13</u>	<u>Specification for EPDM Sheet Used in Single-ply Roof Membrane</u>	<u>1507.12.2</u>

<u>ASTM</u>	<u>ASTM International</u> <u>100 Barr Harbor Drive</u> <u>West Conshohocken, PA 19428-2959</u>	
<u>Standard reference number</u>	<u>Title</u>	<u>Referenced in code section number</u>
<u>D4869/D4869M—05(2011)e01</u>	<u>Specification for Asphalt-saturated (Organic Felt) Underlayment Used in Steep Slope Roofing</u>	<u>1507.2.3,</u> <u>1507.5.3,</u> <u>1507.6.3,</u> <u>1507.7.3,</u> <u>1507.8.3,</u> <u>1507.9.3,</u> <u>1507.17.3,</u> <u>1507.17.4.1</u>
<u>D4897/D4897M—01(2009)</u>	<u>Specification for Asphalt-coated Glass Fiber Venting Base Sheet Used in Roofing</u>	<u>Table 1507.10.2</u>
<u>D4990—97a (2005)e01</u>	<u>Specification for Coal Tar Glass Felt Used in Roofing and Waterproofing</u>	<u>Table 1507.10.2</u>
<u>D4945—17</u>	<u>Test Method for High-strain Dynamic Testing of Piles</u>	<u>1810.4.1.4</u>
<u>D5019—07a</u>	<u>Specification for Reinforced Nonvulcanized Polymeric Sheet Used in Roofing Membrane</u>	<u>1507.12.2</u>
<u>D5034—09 (2017)</u>	<u>Standard Test Method for Breaking Strength and Elongation of Textile Fabrics (Grab Test)</u>	<u>3308.6.3</u>
<u>D5035—11(2019)</u>	<u>Standard Test Method for Breaking Force and Elongation of Textile Fabrics (Strip Method)</u>	<u>3308.6.3</u>
<u>D5055—16</u>	<u>Standard Specification for Establishing and Monitoring Structural Capacities of Prefabricated Wood I-joists</u>	<u>2303.1.2</u>
<u>D5096—2002(2017)</u>	<u>Standard Test Method for Determining the Performance of a Cup Anemometer or Propeller Anemometer</u>	<u>3314.4.4.6,</u> <u>3316.7.8.5,</u> <u>3319.13.2</u>
<u>D5456—17E1</u>	<u>Specification for Evaluation of Structural Composite Lumber Products</u>	<u>Table 1705.5.6,</u> <u>2303.1.10</u>
<u>D5516—17</u>	<u>Test Method of Evaluating the Flexural Properties of Fire-retardant-treated Softwood Plywood Exposed to the Elevated Temperatures</u>	<u>2303.2.5.1</u>
<u>D5643/D5643M—06(2012)E1</u>	<u>Specification for Coal Tar Roof Cement, Asbestos-free</u>	<u>Table 1507.10.2</u>
<u>D5664—17</u>	<u>Standard Test Method for Evaluating the Effects of Fire-retardant Treatment and Elevated Temperatures on Strength Properties of Fire-retardant Treated Lumber</u>	<u>2303.2.5.2</u>

<u>ASTM</u>	<u>ASTM International</u> <u>100 Barr Harbor Drive</u> <u>West Conshohocken, PA 19428-2959</u>	
<u>Standard reference number</u>	<u>Title</u>	<u>Referenced in code section number</u>
<u>D5665—99a (2006)</u>	<u>Specification for Thermoplastic Fabrics Used in Cold-applied Roofing and Waterproofing</u>	<u>Table 1507.10.2</u>
<u>D5726—98 (2005)</u>	<u>Specification for Thermoplastic Fabrics Used in Hot-applied Roofing and Waterproofing</u>	<u>Table 1507.10.2</u>
<u>D5778—12</u>	<u>Standard Test Method for Electronic Friction Cone and Piezocone Penetration Testing of Soils</u>	<u>1803.5.2</u>
<u>D 6066—11</u>	<u>Standard Practice for Determining the Normalized Penetration Resistance of Sands for Evaluation of Liquefaction Potential</u>	<u>1816.2</u>
<u>D6083—05e01</u>	<u>Specification for Liquid Applied Acrylic Coating Used in Roofing</u>	<u>Table 1507.10.2,</u> <u>Table 1507.14.3,</u> <u>1507.15.2</u>
<u>D6162—2000A (2008)</u>	<u>Specification for Styrene-butadiene-styrene (SBS) Modified Bituminous Sheet Materials Using a Combination of Polyester and Glass Fiber Reinforcements</u>	<u>1507.11.2</u>
<u>D6163—00 (2008)</u>	<u>Specification for Styrene-butadiene-styrene (SBS) Modified Bituminous Sheet Materials Using Glass Fiber Reinforcements</u>	<u>1507.11.2</u>
<u>D6164/D6164M—11</u>	<u>Specification for Styrene-butadiene-styrene (SBS) Modified Bituminous Sheet Metal Materials Using Polyester Reinforcements</u>	<u>1507.11.2</u>
<u>D6222/D6222M—11</u>	<u>Specification for Atactic Polypropylene (APP) Modified Bituminous Sheet Materials Using Polyester Reinforcements</u>	<u>1507.11.2</u>
<u>D6223/D6223M —02(2011)E1</u>	<u>Specification for Atactic Polypropylene (APP) Modified Bituminous Sheet Materials Using a Combination of Polyester and Glass Fiber Reinforcements</u>	<u>1507.11.2</u>
<u>D6298—05e1</u>	<u>Specification for Fiberglass Reinforced Styrene-butadiene-styrene (SBS) Modified Bituminous Sheets with a Factory Applied Metal Surface</u>	<u>1507.11.2</u>
<u>D6305—08 (2015)E1</u>	<u>Practice for Calculating Bending Strength Design Adjustment Factors for Fire-retardant-treated Plywood Roof Sheathing</u>	<u>2303.2.5.1</u>

<u>ASTM</u>	<u>ASTM International</u> <u>100 Barr Harbor Drive</u> <u>West Conshohocken, PA 19428-2959</u>	
<u>Standard reference number</u>	<u>Title</u>	<u>Referenced in code section number</u>
<u>D6380—03 (2009)</u>	<u>Standard Specification for Asphalt Roll Roofing (Organic) Felt</u>	<u>1507.2.9.2,</u> <u>1507.3.3,</u> <u>1507.6.5</u>
<u>D6509/D6509M—09</u>	<u>Standard Specification for Atactic Polypropylene (APP) Modified Bituminous base Sheet Materials Using Glass Fiber Reinforcements</u>	<u>1507.11.2</u>
<u>D6694—08</u>	<u>Standard Specification for Liquid-applied Silicone Coating Used in Spray Polyurethane Foam Roofing Systems</u>	<u>Table 1507.14.3,</u> <u>1507.15.2</u>
<u>D6754/D6745M—10</u>	<u>Standard Specification for Ketone Ethylene Ester Based Sheet Roofing</u>	<u>1507.13.2</u>
<u>D6757—2013</u>	<u>Standard Specification for Underlayment for Use with Steep Slope Roofing</u>	<u>1507.2.3,</u> <u>1507.17.3,</u> <u>1507.17.4.1</u>
<u>D6841—16</u>	<u>Standard Practice for Calculating Design Value Treatment Adjustment Factors for Fire-retardant-treated Lumber</u>	<u>2303.2.5.2</u>
<u>D6878/D6878M—11a</u>	<u>Standard Specification for Thermoplastic Polyolefin Based Sheet Roofing</u>	<u>1507.13.2</u>
<u>D6947—07</u>	<u>Standard Specification for Liquid Applied Moisture Cured Polyurethane Coating Used in Spray Polyurethane Foam Roofing System</u>	<u>Table 1507.14.3,</u> <u>1507.15.2</u>
<u>D7032—10a</u>	<u>Standard Specification for Establishing Performance Ratings for Wood, Plastic Composite Deck Boards and Guardrail Systems (Guards or Rails)</u>	<u>2612.2.1,</u> <u>2612.2.2, 2612.4,</u> <u>2612.5.1</u>
<u>D7147—11</u>	<u>Standard Specification for Testing and Establishing Allowable Loads of Joist Hangers</u>	<u>2303.5, 2304.10.3</u>
<u>D7158/D7158M—11</u>	<u>Standard Test Method for Wind Resistance of Sealed Asphalt Shingles (Uplift Force/Uplift Resistance Method)</u>	<u>1504.1.1,</u> <u>Table 1504.1.1</u>
<u>D7254—07</u>	<u>Standard Specification for polypropylene (PP) siding</u>	<u>1404.12</u>
<u>D7655—12</u>	<u>Standard Classification for Size of Aggregate Used as Ballast for Roof Membrane Systems</u>	<u>1507.12.3,</u> <u>1507.13.3</u>

<u>ASTM</u>	<u>ASTM International</u> <u>100 Barr Harbor Drive</u> <u>West Conshohocken, PA 19428-2959</u>	
<u>Standard reference number</u>	<u>Title</u>	<u>Referenced in code section number</u>
<u>D7672—2014</u>	<u>Standard Specification for Evaluating Structural Capacities of Rim Board Products and Assemblies</u>	<u>2303.1.3</u>
<u>E84—2013A</u>	<u>Test Methods for Surface Burning Characteristics of Building Materials</u>	<u>202</u> <u>(FLAME SPREAD INDEX; SMOKE-DEVELOPED INDEX),</u> <u>402.6.4.4,</u> <u>402.6.2, 703.5.2,</u> <u>720.1, 720.1.1,</u> <u>720.1.2, 720.4,</u> <u>803.1.1, 803.1.4,</u> <u>803.1.4.1, 803.10,</u> <u>803.11, 806.7,</u> <u>1404.12.1,</u> <u>1510.10.3,</u> <u>2303.2, 2603.3,</u> <u>2603.4.1.13,</u> <u>2606.3.5.4,</u> <u>2603.5.5, 2603.7,</u> <u>2603.7.1,</u> <u>2603.7.3,</u> <u>2604.2.4, 2606.4,</u> <u>2612.3, 2614.3,</u> <u>3105.3, K1</u>
<u>E90—09</u>	<u>Test Method for Laboratory Measurement of Airborne Sound Transmission Loss of Building Partitions and Elements</u>	<u>1207.2, 1207.2.1</u>
<u>E108—2011</u>	<u>Test Methods for Fire Tests of Roof Coverings</u>	<u>1505.1, 2603.6,</u> <u>2610.2, 2610.3</u>

<u>ASTM</u>	<u>ASTM International</u> <u>100 Barr Harbor Drive</u> <u>West Conshohocken, PA 19428-2959</u>	
<u>Standard reference number</u>	<u>Title</u>	<u>Referenced in code section number</u>
<u>E119—2012A</u>	<u>Standard Test Methods for Fire Tests of Building Construction and Materials</u>	<u>703.2, 703.2.1,</u> <u>703.2.3, 703.2.5,</u> <u>703.3, 703.4,</u> <u>703.6, 704.12,</u> <u>705.7, 705.8.5,</u> <u>707.6, 712.1.13.2,</u> <u>714.3.1, 714.4,</u> <u>715.1, 715.4,</u> <u>716.2,</u> <u>Table 716.3,</u> <u>Table 716.5,</u> <u>716.5.6,</u> <u>716.5.8.1.1,</u> <u>Table 716.6,</u> <u>716.6.7, 717.3.1,</u> <u>717.5.2, 717.5.3,</u> <u>717.6.1, 716.6.2,</u> <u>716.6.2.1,</u> <u>Table 721.1(1),</u> <u>1407.10, 1409.10,</u> <u>2103.1, 2603.4,</u> <u>2603.5.1,</u> <u>2603.5.2</u>
<u>E136—2012</u>	<u>Test Method for Behavior of Materials in a Vertical Tube Furnace at 750°C</u>	<u>703.5.1, 720.1.1</u>
<u>E330—02</u>	<u>Test Method for Structural Performance of Exterior Windows, Curtain Walls and Doors by Uniform Static Air Pressure Difference</u>	<u>1705.9.2</u>
<u>E331—00 (2009)</u>	<u>Test Method for Water Penetration of Exterior Windows, Skylights, Doors and Curtain Walls by Uniform Static Air Pressure Difference</u>	<u>1403.2</u>
<u>E336—05</u>	<u>Standard Test Method for Measurement of Airborne Sound Insulation in Buildings</u>	<u>1207.2</u>
<u>E408—13</u>	<u>Standard Test Methods for Total Normal Emittance of Surfaces Using Inspection-meter Techniques</u>	<u>1504.9</u>
<u>E492—09</u>	<u>Test Method for Laboratory Measurement of Impact Sound Transmission Through Floor-ceiling Assemblies Using the Tapping Machine</u>	<u>1207.3</u>

<u>ASTM</u>	<u>ASTM International</u> <u>100 Barr Harbor Drive</u> <u>West Conshohocken, PA 19428-2959</u>	
<u>Standard reference number</u>	<u>Title</u>	<u>Referenced in code section number</u>
<u>E605—93 (2011)</u>	<u>Test Method for Thickness and Density of Sprayed Fire-resistive Material (SFRM) Applied to Structural Members</u>	<u>1705.14.4.1,</u> <u>1705.14.4.2,</u> <u>1705.14.4.5,</u> <u>1705.14.5</u>
<u>E 648—06a</u>	<u>Standard Test Method for Critical Radiant Flux of Floor-covering Systems Using a Radiant Heat Energy Source</u>	<u>804.2</u>
<u>E681—2009</u>	<u>Test Methods for Concentration Limits of Flammability of Chemical Vapors and Gases</u>	<u>202</u> <u>(FLAMMABLE GAS)</u>
<u>E736—00 (2011)</u>	<u>Test Method for Cohesion/Adhesion of Sprayed Fire-resistive Materials Applied to Structural Members</u>	<u>704.13.2,</u> <u>1705.14.6</u>
<u>E814—2013</u>	<u>Test Method of Fire Tests of Through-penetration Firestops</u>	<u>202</u> <u>(F RATING;</u> <u>T RATING),</u> <u>714.3.1.2,</u> <u>714.3.2, 714.4.1.2</u>
<u>E970—2010</u>	<u>Test Method for Critical Radiant Flux of Exposed Attic Floor Insulation Using a Radiant Heat Energy Source</u>	<u>720.3.1</u>
<u>E1007—97</u>	<u>Test Method for Field Measurement of Tapping Machine Impact Sound Transmission through Floor-ceiling Assemblies and Associated Support Structures</u>	<u>1207.3</u>
<u>E1300—12AE1</u>	<u>Practice for Determining Load Resistance of Glass in Buildings</u>	<u>2404.1</u>
<u>E1354—2013</u>	<u>Standard Test Method for Heat and Visible Smoke Release Rates for Materials and Products Using an Oxygen Consumption Calorimeter</u>	<u>424.2</u>
<u>E1592—05 (2012)</u>	<u>Test Method for Structural Performance of Sheet Metal Roof and Siding Systems by Uniform Static Air Pressure Difference</u>	<u>1504.3.2</u>
<u>E1602—02 (2010)E1</u>	<u>Guide for Construction of Solid Fuel-burning Masonry Heaters</u>	<u>2112.2</u>

<u>ASTM</u>	<u>ASTM International</u> <u>100 Barr Harbor Drive</u> <u>West Conshohocken, PA 19428-2959</u>	
<u>Standard reference number</u>	<u>Title</u>	<u>Referenced in code section number</u>
<u>E1886—13A</u>	<u>Test Method for Performance of Exterior Windows, Curtain Walls, Doors and Storm Shutters Impacted by Missiles and Exposed to Cyclic Pressure Differentials</u>	<u>1609.1.2</u>
<u>E1918—16</u>	<u>Standard Test Method for Measuring Solar Reflectance of Horizontal and Low-sloped Surfaces in the Field</u>	<u>1504.9</u>
<u>E1966—07A(2011)</u>	<u>Test Method for Fire-resistant Joint Systems</u>	<u>202</u> <u>(FIRE-RESISTANT</u> <u>JOINT SYSTEM),</u> <u>715.3</u>
<u>E1980—11</u>	<u>Standard Practice for Calculating Solar Reflectance Index of Horizontal and Low-sloped Opaque Surfaces</u>	<u>1504.9</u>
<u>E1996—2014a*</u> <u>*As modified in</u> <u>Chapter 16</u>	<u>Specification for Performance of Exterior Windows, Curtain Walls, Doors and Impact Protective Systems Impacted by Windborne Debris in Hurricanes</u>	<u>1609.1.2,</u> <u>1609.1.2.2</u>
<u>E2072—10</u>	<u>Standard Specification for Photoluminescent (Phosphorescent) Safety Markings</u>	<u>1025.4,</u> <u>Figure S101.1(2),</u> <u>Figure S101.1(3),</u> <u>Figure S101.1(4),</u> <u>Figure S101.1(5),</u> <u>Figure S101.1(6),</u> <u>Figure S101.1(7),</u> <u>Figure S101.1(8)</u>
<u>E2174—10AE1</u>	<u>Standard Practice for On-Site Inspection of Installed Fire Stops</u>	<u>1705.17.1</u>
<u>E2273—03(2011)</u>	<u>Standard Test Method for Determining the Drainage Efficiency of Exterior Insulation and Finish Systems (EIFS) Clad Wall Assemblies</u>	<u>1408.4.1</u>
<u>E2307—2010</u>	<u>Standard Test Method for Determining Fire Resistance of a Perimeter Joint System Between an Exterior Wall Assembly and Floor Assembly Using the Intermediate-scale, Multistory Test Apparatus</u>	<u>715.4</u>

<u>ASTM</u>	<u>ASTM International</u> <u>100 Barr Harbor Drive</u> <u>West Conshohocken, PA 19428-2959</u>	
<u>Standard reference number</u>	<u>Title</u>	<u>Referenced in code section number</u>
<u>E2353—2014</u>	<u>Standard Test Methods for Performance of Glazing in Permanent Railing Systems, Guards and Balustrades</u>	<u>2407.1.2</u>
<u>E2393—10A</u>	<u>Standard Practice for On-Site Inspection of Installed Fire Resistive Joint Systems and Perimeter Fire Barrier</u>	<u>1705.17.2</u>
<u>E2404—2013E1</u>	<u>Standard Practice for Specimen Preparation and Mounting of Textile, Paper or Vinyl Wall or Ceiling Coverings to Assess Surface Burning Characteristics</u>	<u>803.1.4</u>
<u>E2556—10</u>	<u>Standard Specification for Vapor Permeable Flexible Sheet Water-Resistive Barriers Intended for Mechanical Attachment</u>	<u>2510.6</u>
<u>E2568—09e1</u>	<u>Standard Specification for PB Exterior Insulation and Finish Systems</u>	<u>1408.2</u>
<u>E2570—07</u>	<u>Standard Test Method for Evaluating Water-resistive Barrier (WRB) Coatings Used Under Exterior Insulation and Finish Systems (EIFS) for EIFS with Drainage</u>	<u>1408.4.1.1,</u> <u>1705.16</u>
<u>E2573—12</u>	<u>Standard Practice for Specimen Preparation and Mounting of Site-fabricated Stretch Systems to Assess Surface Burning Characteristics</u>	<u>803.10</u>
<u>E2599—11</u>	<u>Standard Practice for Specimen Preparation and Mounting of Reflective Insulation Materials and Vinyl Stretch Ceiling Materials for Building Applications to Assess Surface Burning Characteristics</u>	<u>2614.3</u>
<u>E2634—11 (2015)</u>	<u>Standard Specification for Flat Wall Insulating Concrete Form (ICF) Systems</u>	<u>1903.4</u>
<u>E2751—13</u>	<u>Standard Practice for Design and Performance of Supported Glass Walkways</u>	<u>2409.1</u>
<u>F547—2012</u>	<u>Terminology of Nails for Use with Wood and Wood-based Materials</u>	<u>Table 2506.2</u>
<u>F1346—91 (2003)</u>	<u>Performance Specification for Safety Covers and Labeling Requirements for All Covers for Swimming Pools, Spas and Hot Tubs</u>	<u>3109.3.2.1,</u> <u>3109.4,</u> <u>3109.5.1.8,</u> <u>3109.6</u>

<u>ASTM</u>	<u>ASTM International</u> <u>100 Barr Harbor Drive</u> <u>West Conshohocken, PA 19428-2959</u>	
<u>Standard reference number</u>	<u>Title</u>	<u>Referenced in code section number</u>
<u>F1667—2015</u>	<u>Specification for Driven Fasteners: Nails, Spikes and Staples</u>	<u>Table 721.1(2),</u> <u>Table 721.1(3),</u> <u>1507.2.6,</u> <u>1507.17.5,</u> <u>2303.6,</u> <u>Table 2304.10.1,</u> <u>2304.10.5,</u> <u>Table 2506.2</u>
<u>F2090—10</u>	<u>Specification for Window Fall Prevention Devices with Emergency Escape (Egress) Release Mechanisms</u>	<u>1015.8</u>
<u>F2200—2013</u>	<u>Standard Specification for Automated Vehicular Gate Construction</u>	<u>3110.3</u>
<u>F2208—08</u>	<u>Standard Safety Specification for Residential Pool Alarms</u>	<u>3109.3.2.1</u>
<u>G152—06</u>	<u>Practice for Operating Open Flame Carbon Arc Light Apparatus for Exposure of Nonmetallic Materials</u>	<u>1504.6</u>
<u>G154—06</u>	<u>Practice for Operating Fluorescent Light Apparatus for UV Exposure of Nonmetallic Materials</u>	<u>1504.6</u>
<u>G155—05a</u>	<u>Practice for Operating Xenon Arc Light Apparatus for Exposure of Nonmetallic Materials</u>	<u>1504.6</u>

<u>AWC</u>	<u>American Wood Council</u> <u>222 Catocin SE, Suite 201</u> <u>Leesburg, VA 20175</u>	
<u>Standard reference number</u>	<u>Title</u>	<u>Referenced in code section number</u>
<u>AWC WCD No. 4—2003</u>	<u>Wood Construction Data—Plank and Beam Framing for Residential Buildings</u>	<u>2306.1.2</u>
<u>AWC WFCM—2018</u>	<u>Wood Frame Construction Manual for One- and Two-Family Dwellings</u>	<u>1609.1.1,</u> <u>1609.1.1.1,</u> <u>2301.2, 2308.2.4,</u> <u>2308.6.7.2,</u> <u>2309.1</u>

<u>AWC</u>	<u>American Wood Council</u> <u>222 Catocin SE, Suite 201</u> <u>Leesburg, VA 20175</u>	
<u>Standard reference number</u>	<u>Title</u>	<u>Referenced in code section number</u>
<u>ANSI/AWC NDS—2018</u>	<u>National Design Specification (NDS) for Wood Construction with 2018 NDS Supplement</u>	<u>202</u> <u>(NOMINAL SIZE (LUMBER)),</u> <u>722.1,</u> <u>Table 1604.3,</u> <u>Table 1705.5.6,</u> <u>1711.1.1,</u> <u>1711.1.4, 1811.5,</u> <u>1908.1.5,</u> <u>2304.13, 2306.1,</u> <u>2306.1.3,</u> <u>Table 2306.2(1),</u> <u>Table 2306.2(2),</u> <u>Table 2306.3(1),</u> <u>Table 2306.3(2),</u> <u>2307.1</u>
<u>AWC STJR—2015</u>	<u>Span Tables for Joists and Rafters</u>	<u>2306.1.1,</u> <u>2308.4.2.1,</u> <u>2308.7.1,</u> <u>2308.7.2</u>
<u>ANSI/AWC PWF—2015</u>	<u>Permanent Wood Foundation Design Specification</u>	<u>2304.10.5.2</u>
<u>AWC SDPWS—2015</u>	<u>Special Design Provisions for Wind and Seismic</u>	<u>202 (SHEAR WALL, SHEAR WALL SEGMENT, PERFORATED),</u> <u>2305.1, 2305.2,</u> <u>2305.3, 2306.1,</u> <u>2306.2, 2306.3,</u> <u>Table 2306.3(1),</u> <u>Table 2306.3(3)</u>
<u>AWC TR7—2007</u>	<u>Basic Requirements for Permanent Wood Foundation System, Technical Report No. 7</u>	<u>1805.2</u>

<u>AWCI</u>	<u>Association of the Wall and Ceiling Industry</u> <u>513 West Broad Street, Suite 210</u> <u>Falls Church, VA 22046</u>	
<u>Standard reference number</u>	<u>Title</u>	<u>Referenced in code section number</u>
<u>12-B—04</u>	<u>Technical Manual 12-B Standard Practice for the Testing and Inspection of Field Applied Thin Film Intumescent Fire-resistive Materials; an Annotated Guide, Second Edition</u>	<u>1705.15</u>

<u>AWPA</u>	<u>American Wood Protection Association</u> <u>P.O. Box 361784</u> <u>Birmingham, AL 35236-1784</u>	
<u>Standard reference number</u>	<u>Title</u>	<u>Referenced in code section number</u>
<u>C1—03</u>	<u>All Timber Products-Preservative Treatment by Pressure Processes</u>	<u>1505.6</u>
<u>M4—16</u>	<u>Standard for the Care of Preservative-treated Wood Products</u>	<u>1811.5.2,</u> <u>2303.1.9</u>
<u>U1—16</u>	<u>USE CATEGORY SYSTEM: User Specification for Treated Wood</u>	<u>Table 1507.9.6,</u> <u>1811.5.2,</u> <u>2303.1.9,</u> <u>2304.12.1,</u> <u>2304.12.2,</u> <u>2304.12.3,</u> <u>2304.12.4,</u> <u>2304.12.5</u>

<u>AWS</u>	<u>American Welding Society</u> <u>8669 NW 36 Street, #130</u> <u>Doral, FL 33166</u>	
<u>Standard reference number</u>	<u>Title</u>	<u>Referenced in code section number</u>
<u>D1.1—15</u>	<u>Structural Welding Code—Steel</u>	<u>Table 1705.2,</u> <u>1705.2.1.1,</u> <u>1811.7.1.1, K1</u>
<u>D1.2—03</u>	<u>Structural Welding Code—Aluminum</u>	<u>1705.33.1,</u> <u>2003.2.2</u>
<u>D1.3—98</u>	<u>Structural Welding Code—Sheet Steel</u>	<u>Table 1705.2</u>

<u>AWS</u>	<u>American Welding Society</u> <u>8669 NW 36 Street, #130</u> <u>Doral, FL 33166</u>	
<u>Standard reference number</u>	<u>Title</u>	<u>Referenced in code section number</u>
<u>D1.4/D1.4M—2017</u>	<u>Structural Welding Code-Reinforcing Steel Including Metal Inserts and Connections In Reinforced Concrete Construction</u>	<u>Table 1705.2,</u> <u>1705.2.1.3,</u> <u>Table 1705.3,</u> <u>1903.6.2, 2107.3</u>

<u>AWWA</u>	<u>American Water Works Association</u> <u>6666 West Quincy Avenue</u> <u>Denver, CO 80235</u>	
<u>Standard reference number</u>	<u>Title</u>	<u>Referenced in code section number</u>
<u>C 104—08</u>	<u>American National Standard for Cement-Mortar Lining for Ductile-Iron Pipe and Fittings for Water</u>	<u>Q105.1</u>

<u>BHMA</u>	<u>Builders Hardware Manufacturers' Association</u> <u>355 Lexington Avenue, 17th Floor</u> <u>New York, NY 10017-6603</u>	
<u>Standard reference number</u>	<u>Title</u>	<u>Referenced in code section number</u>
<u>A 156.10—2011</u>	<u>Power Operated Pedestrian Doors</u>	<u>1010.1.4.2</u>
<u>A 156.19—2013</u>	<u>Standard for Power Assist and Low Energy Operated Doors</u>	<u>1010.1.4.2</u>
<u>A 156.27—11</u>	<u>Power and Manual Operated Revolving Pedestrian Doors</u>	<u>1010.1.4.1</u>

<u>CEN</u>	<u>European Committee for Standardization (CEN)</u> <u>Central Secretariat</u> <u>Rue de Stassart 36</u> <u>B-10 50 Brussels</u>	
<u>Standard reference number</u>	<u>Title</u>	<u>Referenced in code section number</u>
<u>EN 1081—98</u>	<u>Resilient Floor Coverings-Determination of the Electrical Resistance</u>	<u>406.7.1</u>
<u>BS EN 15250—2007</u>	<u>Slow Heat Release Appliances Fired By Solid Fuel Requirements and Test Methods</u>	<u>2112.2, 2112.5</u>

<u>CGSB</u>	<u>Canadian General Standards Board</u> <u>Place du Portage 111, 6B1</u> <u>11 Laurier Street</u> <u>Gatineau, Quebec, Canada KIA 1G6</u>	
<u>Standard reference number</u>	<u>Title</u>	<u>Referenced in code section number</u>
<u>37-GP-52M (1984)</u>	<u>Roofing and Waterproofing Membrane, Sheet Applied, Elastomeric</u>	<u>1504.7, 1507.12.2</u>
<u>37-GP-56M (1980)</u>	<u>Membrane, Modified, Bituminous, Prefabricated and Reinforced for Roofing—with December 1985 Amendment</u>	<u>1507.11.2</u>
<u>CAN/CGSB 37.54—95</u>	<u>Polyvinyl Chloride Roofing and Waterproofing Membrane</u>	<u>1507.13.2</u>

<u>CPA</u>	<u>Composite Panel Association</u> <u>19465 Deerfield Avenue, Suite 306</u> <u>Leesburg, VA 20176</u>	
<u>Standard reference number</u>	<u>Title</u>	<u>Referenced in code section number</u>
<u>ANSI A135.4—2012</u>	<u>Basic Hardboard</u>	<u>2303.1.7</u>
<u>ANSI A135.5—2012</u>	<u>Prefinished Hardboard Paneling</u>	<u>1404.3.1,</u> <u>2303.1.7,</u> <u>2304.7</u>
<u>ANSI A135.6—2012</u>	<u>Engineered Wood Siding</u>	<u>1405.3.2,</u> <u>2303.1.7</u>
<u>A208.1—09</u>	<u>Particleboard</u>	<u>2303.1.8,</u> <u>2303.1.8.1</u>

<u>CPSC</u>	<u>Consumer Product Safety Commission</u> 4330 East West Highway Bethesda, MD 20814-4408	
<u>Standard reference number</u>	<u>Title</u>	<u>Referenced in code section number</u>
<u>16 CFR Part 1201 (2002)</u>	<u>Safety Standard for Architectural Glazing Material</u>	<u>2406.2,</u> <u>Table 2406.2(1),</u> <u>2406.3.1,</u> <u>2407.1,</u> <u>2407.1.4.1,</u> <u>2408.2.1,</u> <u>2408.3, 2409.2,</u> <u>2409.3,</u> <u>2409.4.1</u>
<u>16 CFR Part 1209 (2002)</u>	<u>Interim Safety Standard for Cellulose Insulation</u>	<u>720.6</u>
<u>16 CFR Part 1404 (2002)</u>	<u>Cellulose Insulation</u>	<u>720.6</u>
<u>16 CFR Part 1500.44 (2009)</u>	<u>Method for Determining Extremely Flammable and Flammable Solids</u>	<u>202</u> <u>(FLAMMABLE SOLID)</u>
<u>16 CFR Part 1630 (2007)</u>	<u>Standard for the Surface Flammability of Carpets and Rugs</u>	<u>804.4.1</u>

<u>CSA</u>	<u>Canadian Standards Association</u> 8501 East Pleasant Valley Cleveland, OH 44131-5516	
<u>Standard reference number</u>	<u>Title</u>	<u>Referenced in code section number</u>
<u>AAMA/WDMA/CSA 101/I.S.2/A440—11</u>	<u>Specifications for Windows, Doors and Unit Skylights</u>	<u>1709.5.1,</u> <u>2405.5</u>

<u>CSSB</u>	<u>Cedar Shake and Shingle Bureau</u> <u>P. O. Box 1178</u> <u>Sumas, WA 98295-1178</u>	
<u>Standard reference number</u>	<u>Title</u>	<u>Referenced in code section number</u>
<u>CSSB—97</u>	<u>Grading and Packing Rules for Western Red Cedar Shakes and Western Red Shingles of the Cedar Shake and Shingle Bureau</u>	<u>Table 1507.8.5,</u> <u>Table 1507.9.6</u>

<u>DASMA</u>	<u>Door and Access Systems Manufacturers Association International</u> <u>1300 Summer Avenue</u> <u>Cleveland, OH 44115-2851</u>	
<u>Standard reference number</u>	<u>Title</u>	<u>Referenced in code section number</u>
<u>ANSI/DASMA 107—1997 (R2012)</u>	<u>Room Fire Test Standard for Garage Doors Using Foam Plastic Insulation</u>	<u>2603.4.1.9</u>
<u>108—12</u>	<u>Standard Method for Testing Sectional Garage Doors and Rolling Doors: Determination of Structural Performance Under Uniform Static Air Pressure Difference</u>	<u>1709.5.2</u>
<u>115—16</u>	<u>Standard Method for Testing Sectional Garage Doors and Rolling Doors: Determination of Structural Performance Under Missile Impact and Cyclic Wind Pressure</u>	<u>1609.1.2.3</u>

<u>DOC</u>	<u>U.S. Department of Commerce</u> <u>National Institute of Standards and Technology</u> <u>1401 Constitution Avenue NW</u> <u>Washington, DC 20230</u>	
<u>Standard reference number</u>	<u>Title</u>	<u>Referenced in code section number</u>
<u>PS-1—09</u>	<u>Structural Plywood</u>	<u>2303.1.5, 2304.7,</u> <u>Table 2304.8(4),</u> <u>Table 2304.8(5),</u> <u>Table 2306.2(1),</u> <u>Table 2306.2(2)</u>

<u>DOC</u>	<u>U.S. Department of Commerce</u> <u>National Institute of Standards and Technology</u> <u>1401 Constitution Avenue NW</u> <u>Washington, DC 20230</u>	
<u>Standard reference number</u>	<u>Title</u>	<u>Referenced in code section number</u>
<u>PS-2—10</u>	<u>Performance Standard for Wood-based Structural-use Panels</u>	<u>2303.1.5,</u> <u>2304.7,</u> <u>Table 2304.7(5),</u> <u>Table 2304.8(5),</u> <u>Table 2306.2(1),</u> <u>Table 2306.2(2)</u>
<u>PS 20—05</u>	<u>American Softwood Lumber Standard</u>	<u>202(GRADE (LUMBER)),</u> <u>2303.1.1</u>

<u>DOJ</u>	<u>U.S. Department of Justice</u> <u>950 Pennsylvania Avenue, NW</u> <u>Civil Rights Division, Disability Rights Section-NYA</u> <u>Washington, DC 20530</u>	
<u>Standard reference number</u>	<u>Title</u>	<u>Referenced in code section number</u>
<u>36 CFR Part 1192</u>	<u>American with Disabilities Act (ADA) Accessibility Guidelines for Transportation Vehicles (ADAAG) Department of Justice, 1991</u>	<u>E109.2.4,</u> <u>E111.4</u>

<u>DOL</u>	<u>U.S. Department of Labor</u> <u>Frances Perkins Building</u> <u>200 Constitution Avenue NW</u> <u>Washington, DC 20210</u>	
<u>Standard reference number</u>	<u>Title</u>	<u>Referenced in code section number</u>
<u>29 CFR Part 1910.1000 (2009)</u>	<u>Air Contaminants</u>	<u>202</u> <u>(CEILING LIMIT)</u>

<u>DOT</u>	<u>NYS Department of Transportation</u> <u>Main Office</u> <u>50 Wolf Road</u> <u>Albany, NY 12232</u>	
<u>Standard reference number</u>	<u>Title</u>	<u>Referenced in code section number</u>
<u>EI 19—001</u>	<u>NYSDOT LRFD Bridge Design Specifications - 2019</u>	<u>1607.7.1</u>
<u>BM—2019</u>	<u>NYSDOT Bridge Manual</u>	<u>1607.7.1</u>

<u>DOTn</u>	<u>U.S. Department of Transportation</u> <u>c/o Superintendent of Documents</u> <u>East Building, 2nd floor</u> <u>Washington, DC 20590</u>	
<u>Standard reference number</u>	<u>Title</u>	<u>Referenced in code section number</u>
<u>49 CFR Parts 100—185 (2005)</u>	<u>Hazardous Materials Regulations</u>	<u>202</u>
<u>49 CFR Parts 173.137 (2009)</u>	<u>Shippers—General Requirements for Shipments and Packaging—Class 8—Assignment of Packing Group</u>	<u>202</u> <u>(CORROSIVE MATERIAL)</u>
<u>49 CFR Parts 173—178 (1999)</u>	<u>Specification of Transportation of Explosive and Other Dangerous Articles, UN 0335, UN 0336 Shipping Containers</u>	<u>202</u> <u>(COMBUSTIBLE LIQUID; EXPLOSIVE; FIREWORKS; FLAMMABLE LIQUID)</u>

<u>FEMA</u>	<u>Federal Emergency Management Agency</u> <u>Federal Center Plaza</u> <u>500 C Street S.W.</u> <u>Washington, DC 20472</u>	
<u>Standard reference number</u>	<u>Title</u>	<u>Referenced in code section number</u>
<u>FIS 360497</u>	<u>Federal Emergency Management Agency Flood Insurance Study report</u>	<u>202</u> <u>(500-YEAR FLOOD ELEVATION), G102.2, G402</u>

<u>FEMA</u>	<u>Federal Emergency Management Agency Federal Center Plaza 500 C Street S.W. Washington, DC 20472</u>	
<u>Standard reference number</u>	<u>Title</u>	<u>Referenced in code section number</u>
<u>FIRMs 360497</u>	<u>Federal Emergency Management Agency Flood Insurance Rate Map</u>	<u>202 (500-YEAR FLOOD ELEVATION; BASE FLOOD ELEVATION; COASTAL A-ZONE; COASTAL HIGH HAZARD AREA) G102.2, G102.3, G102.3.1, G102.3.2, G103.3.1, G103.3.2, G402</u>
<u>FORM 086-0-34—12</u>	<u>Floodproofing Certificate; Federal Emergency Management Agency</u>	<u>G107.3, G402</u>
<u>FORM 086-0-33—12</u>	<u>Elevation Certificate; Federal Emergency Management Agency</u>	<u>G107.3, G402</u>

<u>FM</u>	<u>Factory Mutual Global Research Standards Laboratories Department 1301 Atwood Avenue, P.O. Box 7500 Johnston, RI 02919</u>	
<u>Standard reference number</u>	<u>Title</u>	<u>Referenced in code section number</u>
<u>4430 (2012)</u>	<u>Approval Standard for Heat and Smoke Vents</u>	<u>910.3.1</u>
<u>4470 (2012)</u>	<u>Approval Standard for Single-Ply Polymer-Modified Bitumen Sheet, Built-Up Roof (BUR) And Liquid Applied Roof Assemblies for use in Class 1 and Noncombustible Roof Deck Construction</u>	<u>1504.7</u>
<u>4474 (2011)</u>	<u>American National Standard for Evaluating the Simulated Wind Uplift Resistance of Roof Assemblies Using Static Positive and/or Negative Differential Pressures</u>	<u>1504.3.1, 1504.3.2</u>

<u>FM</u>	<u>Factory Mutual Global Research Standards Laboratories Department 1301 Atwood Avenue, P.O. Box 7500 Johnston, RI 02919</u>	
<u>Standard reference number</u>	<u>Title</u>	<u>Referenced in code section number</u>
<u>4880 (2010)</u>	<u>Approval Standard for Class 1 Fire Rating of Insulated Wall or Wall and Roof/Ceiling Panels, Interior Finish Materials or Coatings and Exterior Wall Systems</u>	<u>2603.4, 2603.9</u>
<u>DS 1-35 (2017)</u>	<u>Factory Mutual Data Sheet – Green Roof Systems</u>	<u>1507.16.1</u>

<u>GA</u>	<u>Gypsum Association 6525 Belcrest Road, Suite 480 Hyattsville, MD 20782</u>	
<u>Standard reference number</u>	<u>Title</u>	<u>Referenced in code section number</u>
<u>GA 216—13</u>	<u>Application and Finishing of Gypsum Panel Products</u>	<u>Table 2508.1, 2509.2</u>
<u>GA 600—12</u>	<u>Fire-Resistance Design Manual, 20th Edition</u>	<u>Table 721.1(1), Table 721.1(2), Table 721.1(3)</u>

<u>HPVA</u>	<u>Hardwood Plywood Veneer Association 1825 Michael Faraday Drive Reston, VA 20190</u>	
<u>Standard reference number</u>	<u>Title</u>	<u>Referenced in code section number</u>
<u>HP-1—2016</u>	<u>American National Standard for Hardwood and Decorative Plywood</u>	<u>2303.3, 2304.7</u>

<u>HUD</u>	<u>U.S. Department of Housing and Urban Development 451 7th Street, SW Washington, DC 20410</u>	
<u>Standard reference number</u>	<u>Title</u>	<u>Referenced in code section number</u>
<u>HUD 24 CFR Part 3280 (2008)</u>	<u>Manufactured Home Construction and Safety Standards</u>	<u>G201.1.2, G402</u>

<u>ICC</u>	International Code Council, Inc. <u>500 New Jersey Ave, NW</u> <u>6th Floor</u> <u>Washington, DC 20001</u>	
<u>Standard reference number</u>	<u>Title</u>	<u>Referenced in code section number</u>
<u>ICC A117.1—09</u>	<u>Accessible and Usable Buildings and Facilities</u>	<u>202</u> <u>(ACCESSIBLE UNIT,</u> <u>TYPE B UNIT,</u> <u>TYPE B+NYC</u> <u>UNIT),</u> <u>907.2.11.1.1,</u> <u>1009.8.2, 1009.9,</u> <u>1009.11,</u> <u>1010.1.9.7,</u> <u>1012.1, 1012.6.5,</u> <u>1012.10, 1013.4,</u> <u>1023.9.3, 1101.2,</u> <u>1103.2.2,</u> <u>1105.1.7, 1106.1,</u> <u>1106.5, 1106.6,</u> <u>1106.7,</u> <u>1106.7.3.1,</u> <u>1106.7.3.2.1,</u> <u>1106.8.2,</u> <u>1106.8.5, 1107.2,</u> <u>1107.2.1,</u> <u>1107.2.2,</u> <u>1107.2.2.1,</u> <u>1107.2.2.2,</u> <u>1107.2.2.3,</u> <u>1107.2.2.5,</u> <u>1107.2.2.7.3,</u> <u>1107.2.2.7.5,</u> <u>1107.2.2.7.6,</u> <u>1107.2.2.8.1,</u> <u>1107.2.2.8.1.1,</u> <u>1107.2.2.8.2,</u> <u>1107.2.2.8.2.1,</u> <u>1107.2.2.9,</u> <u>1107.2.3,</u> <u>1107.2.3.1,</u> <u>1107.2.3.2,</u> <u>1107.2.3.3,</u> <u>1107.2.3.4,</u>

<u>ICC</u>	International Code Council, Inc. <u>500 New Jersey Ave, NW</u> <u>6th Floor</u> <u>Washington, DC 20001</u>	
<u>Standard reference number</u>	<u>Title</u>	<u>Referenced in code section number</u>
		<u>1107.2.3.5,</u> <u>1107.2.4,</u> <u>1107.2.5,</u> <u>1107.2.6,</u> <u>1107.2.7,</u> <u>1107.2.8,</u> <u>1107.3.1, 1107.4,</u> <u>1107.6.1.3,</u> <u>1108.2.2,</u> <u>1108.2.3,</u> <u>1108.2.5,</u> <u>1108.2.7,</u> <u>1108.2.9.2,</u> <u>1108.3, 1108.4.1,</u> <u>1108.4.1.1,</u> <u>1108.4.1.2,</u> <u>1108.4.1.4,</u> <u>1108.4.1.5,</u> <u>1109.1, 1109.2,</u> <u>1109.2.2,</u> <u>1109.2.4, 1109.3,</u> <u>1109.4, 1109.5.1,</u> <u>1109.5.2,</u> <u>1109.5.3, 1109.6,</u> <u>1109.7, 1109.7.1,</u> <u>1109.7.1.1,</u> <u>1109.8, 1109.8.1,</u> <u>1109.9.3,</u> <u>1109.9.3.3,</u> <u>1109.9.3.4,</u> <u>1109.10.3,</u> <u>1109.16, 1109.17,</u> <u>1110.4.10,</u> <u>1110.4.11,</u> <u>1110.4.12, 1111.2,</u> <u>1111.3, 1111.4,</u> <u>1111.4.2, 3001.2,</u> <u>3001.3, 3307.2.6,</u> <u>E101.2, E104.2,</u>

<u>ICC</u>	<u>International Code Council, Inc.</u> <u>500 New Jersey Ave, NW</u> <u>6th Floor</u> <u>Washington, DC 20001</u>	
<u>Standard reference number</u>	<u>Title</u>	<u>Referenced in code section number</u>
		<u>E104.2.4, E104.3, E104.3.1, E105.1, E105.2.1, E105.2.2, E105.4, E105.5, E105.6, E106.2, E106.3, E106.4, E106.4.9, E106.5, E107.2, E107.3, E109.2.1, E109.2.2.1, E109.2.2.2, E109.2.2.3, E109.2.3, E109.2.5, E109.2.6, E109.2.8, E111.4</u>
<u>ICC 300—12</u>	<u>ICC Standard on Bleachers, Folding and Telescopic Seating and Grandstands</u>	<u>1029.1.1</u>
<u>ICC 400—17</u>	<u>Standard on Design and Construction of Log Structures</u>	<u>2301.2</u>
<u>ICC 500—14</u>	<u>ICC/NSSA Standard on the Design and Construction of Storm Shelters</u>	<u>202 (STORM SHELTER), 423.1, 423.3, 423.4, 1604.5.1, 1604.10</u>
<u>ICC 600—14</u>	<u>Standard for Residential Construction in High-wind Regions</u>	<u>1609.1.1, 1609.1.1.1, 2308.2.4</u>
<u>SBCCI SSTD 11—99</u>	<u>Test Standard for Determining Wind Resistance of Concrete or Clay Roof Tiles</u>	<u>1711.2.1, 1712.2.2, 1504.2.1.1, 1504.2.1.2</u>

<u>IEC</u>	<u>International Electrotechnical Commission</u> <u>IEC Central Office</u> <u>3, rue de Varembe, P.O. Box 131</u> <u>1211 Geneva 20</u> <u>Switzerland</u>	
<u>Standard reference number</u>	<u>Title</u>	<u>Referenced in code section number</u>
<u>IEC 60118-4 – 2014-12</u>	<u>Electroacoustics - Hearing aids , Part 4</u>	<u>N102.1</u>
<u>IEC 62489-1 – 2010-01</u>	<u>Electroacoustics - Audio-frequency induction loop systems for assisted hearing, Part 1</u>	<u>N102.1</u>

<u>ISO</u>	<u>International Organization for Standardization</u> <u>ISO Central Secretariat</u> <u>1 ch, de la Voie-Creuse, Case Postale 56</u> <u>CH-1211 Geneva 20, Switzerland</u>	
<u>Standard reference number</u>	<u>Title</u>	<u>Referenced in code section number</u>
<u>ISO 8115—86</u>	<u>Cotton Bales—Dimensions and Density</u>	<u>Table 307.1(1),</u> <u>Table 415.11.1.1.1</u>
<u>ISO 8336—09</u>	<u>Fiber-Cement Flat Sheets - Product Specification and Test Methods</u>	<u>1404.10,</u> <u>1405.16.1,</u> <u>1405.16.2,</u> <u>Table 2509.2</u>

<u>ITU</u>	<u>International Telecommunication Union (ITU):</u> <u>Place des Nations</u> <u>1211 Geneva 20 Switzerland</u>	
<u>Standard reference number</u>	<u>Title</u>	<u>Referenced in code section number</u>
<u>ITU-T, Recommendation E.161—2001</u>	<u>Arrangement of digits, letters and symbols on telephones and other devices that can be used for gaining access to a telephone network</u>	<u>1109.7.2.2.4.1</u>

<u>NAAMM</u>	<u>National Association of Architectural Metal Manufacturers</u> <u>800 Roosevelt Road, Bldg. C, Suite 312</u> <u>Glen Ellyn, IL 60137</u>	
<u>Standard reference number</u>	<u>Title</u>	<u>Referenced in code section number</u>
<u>FP 1001—17</u>	<u>Guide Specifications for Design of Metal Flag Poles</u>	<u>1609.1.1</u>

<u>NCMA</u>	<u>National Concrete Masonry Association</u> <u>13750 Sunrise Valley</u> <u>Herndon, VA 22071-4662</u>	
<u>Standard reference number</u>	<u>Title</u>	<u>Referenced in code section number</u>
<u>TEK 5—84(1996)</u>	<u>Details for Concrete Masonry Fire Walls</u>	<u>Table 721.1(2)</u>

<u>NFPA</u>	<u>National Fire Protection Association</u> <u>1 Batterymarch Park</u> <u>Quincy, MA 02169-7471</u>	
<u>Standard reference number</u>	<u>Title</u>	<u>Referenced in code section number</u>
<u>2—16</u>	<u>Hydrogen Technologies Code</u>	<u>421.4</u>
<u>13—16*</u> <u>*As modified in Appendix Q</u>	<u>Installation of Sprinkler Systems</u>	<u>705.8.2,</u> <u>712.1.3.1,</u> <u>901.1.1,</u> <u>903.3.1.1,</u> <u>903.3.2,</u> <u>903.3.5.1,</u> <u>903.3.8.2,</u> <u>903.3.8.5,</u> <u>905.3.3.1,</u> <u>907.6.3, 1019.3,</u> <u>1705.29.1, K1,</u> <u>Q101.1, Q102.1,</u> <u>Q105.1</u>

<u>NFPA</u>	<u>National Fire Protection Association</u> <u>1 Batterymarch Park</u> <u>Quincy, MA 02169-7471</u>	
<u>Standard reference number</u>	<u>Title</u>	<u>Referenced in code section number</u>
<u>13D—16*</u> <u>*As modified in Appendix Q</u>	<u>Standard for the Installation of Sprinkler Systems in One- and Two-family Dwellings and Manufactured Homes</u>	<u>901.1.1,</u> <u>903.2.11.4,</u> <u>903.3.1.3</u> <u>903.3.5.1.1,</u> <u>Q101.1, Q102.1,</u> <u>Q103.1</u>
<u>13R—16*</u> <u>*As modified in Appendix Q</u>	<u>Standard for the Installation of Sprinkler Systems in Low Rise Residential Occupancies</u>	<u>901.1.1,</u> <u>903.2.11.4,</u> <u>903.3.1.2,</u> <u>903.3.5.1,</u> <u>903.3.5.1.1, 903.4</u> <u>Q101.1, Q104.1,</u> <u>Q105.1</u>
<u>14—16*</u> <u>*As modified in Appendix Q</u>	<u>Standard for the Installation of Standpipe and Hose System</u>	<u>403.3.2, 901.1.1,</u> <u>905.2, 905.3.3.3,</u> <u>905.4.2, 905.6.2,</u> <u>905.8, 1705.30,</u> <u>3202.2.4,</u> <u>3303.8.1,</u> <u>G304.1.2,</u> <u>G308.9, G308.10,</u> <u>G308.11, G402,</u> <u>Q101.1, Q102.1,</u> <u>Q105.1</u>
<u>20—16*</u> <u>*As modified in Appendix Q</u>	<u>Standard for the Installation of Stationary Pumps for Fire Protection</u>	<u>901.1.1, 913.1,</u> <u>913.2, 913.2.1,</u> <u>913.5, 1705.30.2,</u> <u>Q101.1, Q105.1,</u> <u>Q106.1</u>
<u>22—13</u>	<u>Standard for Water Tanks for Private Fire Protection</u>	<u>Q105.1</u>
<u>25—16</u>	<u>Standard for the Inspection, Testing, and Maintenance of Water-based Fire Protection Systems</u>	<u>Q102.1</u>
<u>30—12</u>	<u>Flammable and Combustible Liquids Code</u>	<u>415.6,</u> <u>507.8.1.1.1,</u> <u>507.8.1.1.2</u>
<u>31—11</u>	<u>Standard for the Installation of Oil-burning Equipment</u>	<u>2113.15</u>
<u>32—11</u>	<u>Standard for Dry Cleaning Plants</u>	<u>415.9.3</u>

<u>NFPA</u>	<u>National Fire Protection Association</u> <u>1 Batterymarch Park</u> <u>Quincy, MA 02169-7471</u>	
<u>Standard reference number</u>	<u>Title</u>	<u>Referenced in code section number</u>
<u>40—11</u>	<u>Standard for the Storage and Handling of Cellulose Nitrate Film</u>	<u>409.1</u>
<u>45—15</u>	<u>Standard on Fire Protection for Laboratories Using Chemicals</u>	<u>427.2, 427.7.1</u>
<u>54—16</u>	<u>National Fuel Gas Code</u>	<u>2113.1</u>
<u>58—14</u>	<u>Liquefied Petroleum Gas Code</u>	<u>415.9.2</u>
<u>61—13</u>	<u>Standard for the Prevention of Fires and Dust Explosions in Agricultural and Food Product Facilities</u>	<u>426.1</u>
<u>69—14</u>	<u>Standard on Explosion Prevention Systems</u>	<u>426.1</u>
<u>72—16*</u> <u>*As modified in Appendix Q</u>	<u>National Fire Alarm Code</u>	<u>407.4.4.3,</u> <u>407.4.4.5,</u> <u>407.4.4.5.1,</u> <u>411.5, 505.2.3,</u> <u>901.1.1, 901.6,</u> <u>903.4.1, 904.3.5,</u> <u>907.1, 907.2,</u> <u>907.2.1.1,</u> <u>907.2.2, 907.2.7,</u> <u>907.2.8.4,</u> <u>907.2.11,</u> <u>907.2.12.1,</u> <u>907.2.13.3, 907.3,</u> <u>907.3.3, 907.3.4,</u> <u>907.5.2.1.2,</u> <u>907.5.2.2, 907.6,</u> <u>907.6.1, 907.6.5,</u> <u>907.7, 907.7.1,</u> <u>907.7.2, 911.1.5,</u> <u>911.1.6, 911.2,</u> <u>915.7, 916.1,</u> <u>3005.5, 3007.7</u> <u>Q101.1, Q102.1,</u> <u>Q107.1</u>

<u>NFPA</u>	<u>National Fire Protection Association</u> <u>1 Batterymarch Park</u> <u>Quincy, MA 02169-7471</u>	
<u>Standard reference number</u>	<u>Title</u>	<u>Referenced in code section number</u>
<u>80—13</u>	<u>Standard for Fire Doors and Other Opening Protectives</u>	<u>410.3.5, 509.4.2, 713.7, 716.5, 716.5.7, 716.5.8.1, 716.5.9.2, 716.6, 716.6.4, 1010.1.4.3</u>
<u>82—14</u>	<u>Standard on Incinerators and Waste and Linen Handling Systems and Equipment</u>	<u>713.13</u>
<u>85—15</u>	<u>Boiler and Combustion System Hazards Code</u>	<u>426.1</u>
<u>92—18*</u> <u>*As modified in Appendix Q</u>	<u>Standard for Smoke Control Systems</u>	<u>901.1.1, 909.7, 909.8, 909.10.1, Q101.1, Q108.1</u>
<u>99—15</u>	<u>Health Care Facilities Code</u>	<u>908.8, 407.10, 425.1</u>
<u>101—15</u>	<u>Life Safety Code</u>	<u>1029.6.2</u>
<u>105—13</u>	<u>Standard for Smoke Door Assemblies and Other Opening Protectives</u>	<u>405.4.2, 710.5.2.2, 716.5.3.1, 909.20.4.1</u>
<u>110—13</u>	<u>Standard for Emergency and Standby Power Systems</u>	<u>1705.36, 2702.1, 2702.4.2</u>
<u>111—13</u>	<u>Standard on Stored Electrical Energy Emergency and Standby Power Systems</u>	<u>1704.31, 1705.36, 2702.1</u>
<u>120—15</u>	<u>Standard for Fire Prevention and Control in Coal Mines</u>	<u>426.1</u>
<u>170—15</u>	<u>Standard for Fire Safety and Emergency Symbols</u>	<u>1025.2.6.2, 1025.3.1, 1025.6.1</u>
<u>211—13</u>	<u>Standard for Chimneys, Fireplaces, Vents and Solid Fuel-burning Appliances</u>	<u>2112.5</u>
<u>221—15</u>	<u>Standard for High Challenge Fire Walls, Fire Walls, and Fire Barrier Walls</u>	<u>706.2</u>

<u>NFPA</u>	<u>National Fire Protection Association</u> <u>1 Batterymarch Park</u> <u>Quincy, MA 02169-7471</u>	
<u>Standard reference number</u>	<u>Title</u>	<u>Referenced in code section number</u>
<u>252—12</u>	<u>Standard Methods of Fire Tests of Door Assemblies</u>	<u>715.4.2, 715.4.3, 715.4.7.3.1, Table 716.3, 716.3.1, 716.4, 716.5.1, 716.5.2, 716.5.3, 716.5.5.1, 716.5.8.1.1</u>
<u>253—15</u>	<u>Standard Method of Test for Critical Radiant Flux of Floor Covering Systems Using a Radiant Heat Energy Source</u>	<u>406.8.3, 424.2, 804.2</u>
<u>255—06</u>	<u>Standard Method of Test Surface Burning Characteristics of Building Materials</u>	<u>K1</u>
<u>257—12</u>	<u>Standard for Fire Test for Window and Glass Block Assemblies</u>	<u>Table 716.3, 716.3.2, 716.4, 716.5.3.2, 716.6, 716.6.1, 716.6.2, 716.6.7.3</u>
<u>259—13</u>	<u>Standard Test Method for Potential Heat of Building Materials</u>	<u>2603.4.1.10, 2603.5.3</u>
<u>265—11</u>	<u>Standard Methods of Fire Tests for Evaluating Room Fire Growth Contribution of Textile Wall Coverings on Full Height Panels and Walls</u>	<u>803.1.3, 803.1.3.1</u>
<u>268—12</u>	<u>Standard Test Method for Determining Ignitability of Exterior Wall Assemblies Using a Radiant Heat Energy Source</u>	<u>1406.2.1.1, 1406.2.1.1.1, 1406.2.1.1.2, 2603.5.7</u>
<u>269—12</u>	<u>Standard Test Method for Developing Toxic Potency Data for Use in Fire Hazard Modeling</u>	<u>803.14</u>
<u>276—11</u>	<u>Standard Method of Fire Tests for Determining the Heat Release Rate of Roofing Assemblies With Combustible Above-Deck Roofing Components</u>	<u>1508.1, 2603.3, 2603.4.1.5</u>
<u>285—12</u>	<u>Standard Fire Test Method for the Evaluation of Fire Propagation Characteristics of Exterior Nonload-bearing Wall Assemblies Containing Combustible Components</u>	<u>1401.2, 1403.5, 1403.5.1, 1407.11, 1409.11, 2601.2.1, 2603.5.5</u>

<u>NFPA</u>	<u>National Fire Protection Association</u> <u>1 Batterymarch Park</u> <u>Quincy, MA 02169-7471</u>	
<u>Standard reference number</u>	<u>Title</u>	<u>Referenced in code section number</u>
<u>286—15</u>	<u>Standard Methods of Fire Test for Evaluating Contribution of Wall and Ceiling Interior Finish to Room Fire Growth</u>	<u>402.6.4.4,</u> <u>803.1.2,</u> <u>803.1.2.1, 803.11,</u> <u>2603.7.2, 2603.9,</u> <u>2604.2.4, 2614.4</u>
<u>288—12</u>	<u>Standard Methods of Fire Tests of Horizontal Fire Door Assemblies Installed in Fire-resistance-rated Floor Systems</u>	<u>712.1.13.1</u>
<u>289—13</u>	<u>Standard Method of Fire Test for Individual Fuel Packages</u>	<u>402.6.2, 424.2</u>
<u>409—11</u>	<u>Standard for Aircraft Hangars</u>	<u>412.4.6,</u> <u>Table 412.4.6,</u> <u>412.4.6.1, 412.6.5</u>
<u>418—11</u>	<u>Standard for Heliports</u>	<u>412.8.4</u>
<u>484—15</u>	<u>Standard for Combustible Metals</u>	<u>426.1</u>
<u>654—13</u>	<u>Standard for the Prevention of Fire & Dust Explosions from the Manufacturing, Processing and Handling of Combustible Particulate Solids</u>	<u>426.1</u>
<u>655—12</u>	<u>Standard for the Prevention of Sulfur Fires and Explosions</u>	<u>426.1</u>
<u>664—12</u>	<u>Standard for the Prevention of Fires and Explosions in Wood Processing and Woodworking Facilities</u>	<u>426.1</u>
<u>701—10</u>	<u>Standard Method of Fire Tests for Flame-Propagation of Textiles and Films</u>	<u>424.2, 3102.3.1,</u> <u>3102.6.1.1,</u> <u>3105.3,</u> <u>3301.9.1.3,</u> <u>3301.9.2.3,</u> <u>3307.2.3,</u> <u>3307.4.7,</u> <u>3308.3.4,</u> <u>3314.8.2,</u> <u>3315.1.6,</u> <u>3315.2.3, H114.2,</u> <u>H114.2.2, H117.4</u>

<u>NFPA</u>	<u>National Fire Protection Association</u> <u>1 Batterymarch Park</u> <u>Quincy, MA 02169-7471</u>	
<u>Standard reference number</u>	<u>Title</u>	<u>Referenced in code section number</u>
<u>704—12</u>	<u>Standard System for the Identification of the Hazards of Materials for Emergency Response</u>	<u>202</u> <u>(HAZARDOUS PRODUCTION MATERIAL; LABORATORY CHEMICAL),</u> <u>415.5.2, 427.4</u>
<u>720—15</u>	<u>Standard for the Installation of Carbon Monoxide (CO) Detection and Warning Equipment</u>	<u>915.5.4, 915.6.1,</u> <u>915.6.2, 915.7</u>
<u>1124—17</u>	<u>Code for the Manufacture, Transportation and Storage of Fireworks and Pyrotechnic Articles</u>	<u>415.6.1.1</u>

<u>PCI</u>	<u>Precast Prestressed Concrete Institute</u> <u>200 West Adams Street, Suite 2100</u> <u>Chicago, IL 60606-6938</u>	
<u>Standard reference number</u>	<u>Title</u>	<u>Referenced in code section number</u>
<u>MNL 124—11</u>	<u>Design for Fire Resistance of Precast Prestressed Concrete</u>	<u>722.2.3.1</u>
<u>MNL 128—01</u>	<u>Recommended Practice for Glass Fiber Reinforced Concrete Panels</u>	<u>1903.3</u>

<u>PTI</u>	<u>Post-Tensioning Institute</u> <u>38800 Country Club Drive</u> <u>Farmington Hills, MI 48331</u>	
<u>Standard reference number</u>	<u>Title</u>	<u>Referenced in code section number</u>
<u>PTI DC—35.1-14</u>	<u>Recommendations for Prestressed Rock and Soil Anchors</u>	<u>1815.1, 1815.3,</u> <u>1815.4.5, 1815.5</u>

<u>RCSC</u>	<u>Research Council on Structural Connections</u> <u>One East Wacker Drive, Suite 700</u> <u>Chicago, IL 60601</u>	
<u>Standard reference number</u>	<u>Title</u>	<u>Referenced in code section number</u>
<u>RCSC—14 (2015)</u>	<u>Specification for Structural Joints Using High-Strength Bolts</u>	<u>Table 1705.2</u>

<u>RMI</u>	<u>Rack Manufacturers Institute</u> <u>8720 Red Oak Boulevard, Suite 201</u> <u>Charlotte, NC 28217</u>	
<u>Standard reference number</u>	<u>Title</u>	<u>Referenced in code section number</u>
<u>ANSI/MH16.1—12</u>	<u>Specification for Design, Testing and Utilization of Industrial Steel Storage Racks</u>	<u>2209.1</u>

<u>SBCA</u>	<u>Structural Building Components Association</u> <u>6300 Enterprise Lane</u> <u>Madison, WI 53719</u>	
<u>Standard reference number</u>	<u>Title</u>	<u>Referenced in code section number</u>
<u>ANSI/FS 100-12</u>	<u>Standard Requirements for Wind Pressure Resistance of Foam Plastic Insulating Sheathing Used in Exterior Wall Covering Assemblies</u>	<u>2603.10</u>

<u>SDI</u>	<u>Steel Deck Institute</u> <u>P. O. Box 426</u> <u>Glenshaw, PA 15116</u>	
<u>Standard reference number</u>	<u>Title</u>	<u>Referenced in code section number</u>
<u>NC—17</u>	<u>Standard for Noncomposite Steel Floor Deck</u>	<u>2210.1.1.1</u>
<u>RD—17</u>	<u>Standard for Steel Floor Deck</u>	<u>2210.1.1.2</u>
<u>SDI-C—2017</u>	<u>Standard for Composite Steel Floor Deck Slabs</u>	<u>2210.1.1.3</u>
<u>SDI-QA/QC—2017</u>	<u>Standard for Quality Control and Quality Assurance for Installation of Steel Deck</u>	<u>1705.2.1.2</u>

<u>SJI</u>	<u>Steel Joist Institute</u> <u>1173B London Links Drive</u> <u>Forest, VA 24551</u>	
<u>Standard reference number</u>	<u>Title</u>	<u>Referenced in code section number</u>
<u>SJI 100—15</u>	<u>Standard Specification Load Tables and Weight Tables for Steel Joists and Joist Girders K-Series, LH-Series, DHL-Series, Joist Girders - 44th Edition</u>	<u>1604.3.3, 2203.2, 2207.1</u>
<u>SJI 200—15</u>	<u>Standard Specification for Composite Steel Joists - CJ-Series</u>	<u>1604.3.3</u>

<u>SPRI</u>	<u>Single-Ply Roofing Institute</u> <u>411 Waverly Oaks Road, Suite 331B</u> <u>Waltham, MA 02452</u>	
<u>Standard reference number</u>	<u>Title</u>	<u>Referenced in code section number</u>
<u>ANSI/SPRI/FM 4435-ES-1—11</u>	<u>Wind Design Standard for Edge Systems Used with Low Slope Roofing Systems</u>	<u>1504.5</u>
<u>ANSI/SPRI RP-4—13</u>	<u>Wind Design Guide for Ballasted Single-ply Roofing Systems</u>	<u>1504.4</u>
<u>ANSI/SPRI VF1—10</u>	<u>External Fire Design Standard for Vegetative Roofs</u>	<u>1507.16.1</u>
<u>RP-14—16</u>	<u>Wind Design Standards for Vegetative Roofing Systems</u>	<u>1507.16.1</u>

<u>TIA</u>	<u>Telecommunications Industry Association</u> <u>1320 N. Courthouse Road</u> <u>Arlington, VA 22201-3834</u>	
<u>Standard reference number</u>	<u>Title</u>	<u>Referenced in code section number</u>
<u>222-G—05</u>	<u>Structural Standards for Antenna Supporting Structures and Antennas, including—Addendum 1, 222-G-1, Dated 2007, Addendum 2, 222-G-2 Dated 2009 Addendum 3, 222-3 dated 2013 and Addendum 4, 222-G-4 dated 2014</u>	<u>1609.1.1</u>
<u>TIA-222-H—17</u>	<u>Standard for Antennas and the Supporting Structures for Antennas and Small Wind Turbines</u>	<u>1609.1.1, 3108.1, 3108.2, 3108.4</u>

<u>TMS</u>	<u>The Masonry Society</u> <u>105 South Sunset Street, Suite Q</u> <u>Longmont, CO 80501</u>	
<u>Standard reference number</u>	<u>Title</u>	<u>Referenced in code section number</u>
<u>216—2013</u>	<u>Standard Method for Determining Fire Resistance of Concrete and Masonry Construction Assemblies</u>	<u>Table 721.1(2), 722.1</u>
<u>302—2012</u>	<u>Standard Method for Determining the Sound Transmission Class for Masonry Walls</u>	<u>1207.2.1</u>
<u>402—2016*</u> <u>*As modified in Chapter 21</u>	<u>Building Code Requirements and Specifications for Masonry Structures</u>	<u>1405.6, 1405.6.2, 1405.10, 1604.3.4, 1705.4.1, Table 1705.4.1, 1705.4.3, Table 1705.4.3 2101.2, 2104.1, 2106.1, 2107.1, 2107.2, 2107.3, 2107.4, 2108.1, 2108.2, 2108.3, 2109.1, 2109.1.1, 2109.1.1.1, 2109.2, 2109.2.1, 2110.1</u>
<u>403—2017</u>	<u>Direct Design Handbook for Masonry Structures</u>	<u>2101.2</u>
<u>404—2016</u>	<u>Standard for the Design of Architectural Cast Stone</u>	<u>2101.2</u>
<u>504—2016</u>	<u>Standard for the Fabrication of Architectural Cast Stone</u>	<u>2103.1</u>
<u>602—2016</u>	<u>Specification for Masonry Structures</u>	<u>1405.6.1, Table 1705.4.1, Table 1705.4.3, 2103.1, 2103.2.1, 2103.3, 2103.4, 2104.1, 2104.2, 2104.3, 2104.5, 2105.1, 2105.2</u>
<u>604—2016</u>	<u>Standard for the Installation of Architectural Cast Stone</u>	<u>2104.1</u>

<u>TPI</u>	<u>Truss Plate Institute</u> <u>218 N. Lee Street, Suite 312</u> <u>Alexandria, VA 22314</u>	
<u>Standard reference number</u>	<u>Title</u>	<u>Referenced in code section number</u>
<u>TPI 1—2014</u>	<u>National Design Standard for Metal-plate-connected Wood Truss Construction</u>	<u>2303.4.6, 2306.1</u>

<u>UL</u>	<u>UL LLC</u> <u>333 Pfingsten Road</u> <u>Northbrook, IL 60062-2096</u>	
<u>Standard reference number</u>	<u>Title</u>	<u>Referenced in code section number</u>
<u>9—2009</u>	<u>Fire Tests of Window Assemblies</u>	<u>Table 716.3,</u> <u>716.3.2, 716.4,</u> <u>716.5.3.2, 716.6,</u> <u>716.6.1, 716.6.2,</u> <u>716.6.8.1</u>
<u>10A—2009</u>	<u>Tin Clad Fire Doors</u>	<u>716.5</u>
<u>10B—2008</u>	<u>Fire Tests of Door Assemblies—with Revisions through April 2009</u>	<u>Table 716.3,</u> <u>716.5.2, 716.5.5.1,</u> <u>716.5.8.1.1.</u>
<u>10C—2009</u>	<u>Positive Pressure Fire Tests of Door Assemblies</u>	<u>716.5.1, 716.5.3,</u> <u>716.5.5.1,</u> <u>716.5.8.1.1,</u> <u>1010.1.10.1</u>
<u>14B—2008</u>	<u>Sliding Hardware for Standard Horizontally mounted Tin Clad Fire Doors—with Revisions Through May 3, 2013</u>	<u>716.5</u>
<u>14C—06</u>	<u>Swinging Hardware for Standard Tin Clad Fire Doors Mounted Singly and in Pairs—with Revisions through May 2013</u>	<u>716.5</u>
<u>55A—04</u>	<u>Materials for Built-Up Roof Coverings</u>	<u>1507.10.2</u>
<u>103—2010</u>	<u>Factory-built Chimneys, for Residential Type and Building Heating Appliances—with Revisions through July 2012</u>	<u>718.2.5.1</u>
<u>127—2011</u>	<u>Factory-built Fireplaces</u>	<u>718.2.5.1, 2111.12</u>
<u>214—01</u>	<u>Standard for Tests for Flame-propagation of Fabrics and Films</u>	<u>3301.9.1.3,</u> <u>3301.9.2.3,</u> <u>H114.2, H117.4</u>

<u>UL</u>	<u>UL LLC</u> <u>333 Pfingsten Road</u> <u>Northbrook, IL 60062-2096</u>	
<u>Standard reference number</u>	<u>Title</u>	<u>Referenced in code section number</u>
<u>217—16</u>	<u>Single and Multiple Station Smoke Alarms, 8th Edition</u>	<u>907.2.11,</u> <u>907.2.11.6,</u> <u>915.5.3</u>
<u>263—11</u>	<u>Standard for Fire Tests of Building Construction and Materials</u>	<u>703.2, 703.2.1,</u> <u>703.2.3, 703.2.5,</u> <u>703.3, 703.4,</u> <u>703.6, 704.12,</u> <u>705.7, 705.8.5,</u> <u>707.6, 712.1.13.2,</u> <u>714.1, 715.5.1,</u> <u>716.2,</u> <u>Table 716.3,</u> <u>716.5.6,</u> <u>716.5.8.1.1,</u> <u>Table 716.6,</u> <u>716.6.7.1, 717.3.1,</u> <u>717.5.2, 717.5.3,</u> <u>717.6.1, 717.6.2.1,</u> <u>Table 721.1(1),</u> <u>1407.10, 1409.10,</u> <u>2103.1, 2603.4,</u> <u>2603.5.1, 2603.5.2</u>
<u>268—16</u>	<u>Smoke Detectors for Fire Alarm Systems, 7th Edition</u>	<u>407.8, 907.2.11.6,</u> <u>907.2.11.7,</u> <u>915.6.3</u>
<u>294—1999</u>	<u>Access Control System Units—with Revisions through September 2010</u>	<u>1010.1.9.6,</u> <u>1010.1.9.7,</u> <u>1010.1.9.8,</u> <u>1010.1.9.9</u>
<u>300—05(R2010)</u>	<u>Fire Testing of Fire Extinguishing Systems for Protection of Commercial Cooking Equipment—with Revisions through July 16, 2010</u>	<u>904.12</u>
<u>300A—06</u>	<u>Outline of Investigation for Extinguishing System Units for Residential Range Top Cooking Surfaces</u>	<u>407.2.6, 904.13</u>
<u>305—2012</u>	<u>Panic Hardware</u>	<u>1010.1.10.3</u>
<u>325—02</u>	<u>Door, Drapery, Gate, Louver and Window Operations and Systems— with Revisions through June 2013</u>	<u>3110.3.1, 3110.4,</u> <u>406.3.5</u>
<u>555—2006</u>	<u>Fire Dampers—with Revisions through May 2012</u>	<u>717.3.1</u>

<u>UL</u>	<u>UL LLC</u> <u>333 Pfingsten Road</u> <u>Northbrook, IL 60062-2096</u>	
<u>Standard reference number</u>	<u>Title</u>	<u>Referenced in code section number</u>
<u>555C—2006</u>	<u>Ceiling Dampers—with Revisions through May 2010</u>	<u>717.3.1</u>
<u>555S—99</u>	<u>Smoke Dampers—with Revisions through May 2012</u>	<u>717.3.1</u>
<u>580—2006</u>	<u>Test for Uplift Resistance of Roof Assemblies—with Revisions through July 2009</u>	<u>1504.3.1, 1504.3.2</u>
<u>641—2010</u>	<u>Type L Low-temperature Venting Systems—with Revisions through June 2013</u>	<u>2113.11.1.4</u>
<u>723—2008</u>	<u>Standard for Test for Surface Burning Characteristics of Building Materials—with Revisions through September 2010</u>	<u>202, (FLAME SPREAD INDEX), 402.6.4.4, 402.6.2, 703.5.2, 720.1, 803.1.1, 803.1.2, 803.1.4, 803.10, 803.11, 806.7, 1404.12.1, 1407.9, 1409.9, 1409.10.1, 1510.10.3, 2303.2, 2603.3, 2603.4.1.13, 2606.3.5.4, 2606.3.5.5, 2603.7, 2603.7.1, 2603.7.2, 2603.7.3, 2604.2.4, 2606.4, 2612.3, 2614.3, 3105.3, K1</u>
<u>790—04</u>	<u>Standard Test Methods for Fire Tests of Roof Coverings—with Revisions through October 2008</u>	<u>1505.1, 2603.6, 2610.2, 2610.3</u>
<u>793—08</u>	<u>Standards for Automatically Operated Roof Vents for Smoke and Heat—with Revisions through September 2011</u>	<u>910.3.1</u>
<u>864—03</u>	<u>Standards for Control Units and Accessories for Fire Alarm Systems—with Revisions through December 2014</u>	<u>406.8.5.1.1, 909.12, 909.12.4.1</u>
<u>924—06</u>	<u>Standard for Safety Emergency Lighting and Power Equipment—with Revisions through February 2011</u>	<u>1013.5</u>

<u>UL</u>	<u>UL LLC</u> <u>333 Pfingsten Road</u> <u>Northbrook, IL 60062-2096</u>	
<u>Standard reference number</u>	<u>Title</u>	<u>Referenced in code section number</u>
<u>1040—96</u>	<u>Fire Test of Insulated Wall Construction—with Revisions through October 2012</u>	<u>2603.4, 2603.5.2, 2603.9</u>
<u>1256—02</u>	<u>Fire Test of Roof Deck Construction—with Revisions through January 2007</u>	<u>1508.1, 2603.3, 2603.4.1.5</u>
<u>1275—05</u>	<u>Flammable Liquid Storage Cabinets</u>	<u>427.4</u>
<u>1479—03</u>	<u>Fire Tests of Through-penetration Firestops—with Revisions through October 2012</u>	<u>202 (F RATING, L RATING, T RATING, THROUGH-PENETRATION FIRESTOP SYSTEM), 714.3.1.2, 714.3.2, 714.4.1.2, 714.4.3</u>
<u>1482—2011</u>	<u>Solid-Fuel-type Room Heaters—with Revisions through August 2015</u>	<u>2112.2</u>
<u>1703—02</u>	<u>Flat-Plate Photovoltaic Modules and Panels</u>	<u>1505.9, 1507.17.6, 1510.11.4</u>
<u>1715—97</u>	<u>Fire Test of Interior Finish Material—with Revisions through January 2013</u>	<u>1407.10, 1409.10, 2603.4, 2603.5.2, 2603.9, 2614.4</u>
<u>1777—2007</u>	<u>Chimney Liners—with Revisions through October 2015</u>	<u>2113.11.1, 2113.19</u>
<u>1784—01</u>	<u>Air Leakage Tests of Door Assemblies—with Revisions through July 2009</u>	<u>710.5.2.2, 710.5.2.2.1, 716.5.3.1, 716.5.7.1, 1016.3.1, 1016.3.2, 3006.1.1, 3007.6, 3007.6.3, 3008.7.3</u>
<u>1897—12</u>	<u>Uplift Tests for Roof Covering Systems</u>	<u>1504.3.1</u>
<u>1975—06</u>	<u>Fire Test of Foamed Plastics Used for Decorative Purposes</u>	<u>402.6.2, 402.6.4.5, 424.2</u>

<u>UL</u>	<u>UL LLC</u> <u>333 Pfingsten Road</u> <u>Northbrook, IL 60062-2096</u>	
<u>Standard reference number</u>	<u>Title</u>	<u>Referenced in code section number</u>
<u>1994—04</u>	<u>Standard for Luminous Egress Path Marking Systems— with Revisions through November 2010</u>	<u>411.7, 1025.2.1, 1025.2.3, 1025.2.4, 1025.4</u>
<u>2017—2008</u>	<u>Standards for General-purpose Signaling Devices and Systems—with Revisions through May 2011</u>	<u>3109.5.1.8 406.8.5.1.1</u>
<u>2034—08</u>	<u>Standard for Single- and Multiple-Station Carbon Monoxide Alarm—with Revisions through March 2015</u>	<u>915.5.2, 915.5.3</u>
<u>2075—2013</u>	<u>Standard for Gas and Vapor Detectors and Sensors</u>	<u>406.8.5.1.1, 915.6.1, 915.6.3</u>
<u>2079—04</u>	<u>Tests for Fire Resistance of Building Joint Systems—with Revisions through December 2012</u>	<u>202 (FIRE- RESISTANT JOINT SYSTEM, L RATING), 715.3, 715.6</u>
<u>2196—2017</u>	<u>Tests for Fire Resistive Cables</u>	<u>909.20.6.1</u>
<u>2200—2012</u>	<u>Stationary Engine Generator Assemblies—with Revisions through June 2013</u>	<u>2702.1.2 2702.4.1</u>

<u>ULC</u>	<u>Underwriters Laboratories of Canada</u> <u>7 Underwriters Road</u> <u>Toronto, Ontario, Canada M1R3B4</u>	
<u>Standard reference number</u>	<u>Title</u>	<u>Referenced in code section number</u>
<u>CAN/ULC S 102.2—2010</u>	<u>Standard Method of Test for Surface Burning Characteristics of Flooring, Floor Coverings and Miscellaneous Materials and Assemblies—with 2000 Revisions</u>	<u>720.2, 720.3, 720.4</u>
<u>CAN/ULC S635—16</u>	<u>Standard for Lining Systems for Existing Masonry or Factory-built Chimneys and Vents</u>	<u>2113.11.1.2, 2113.19</u>

<u>USC</u>	<u>United States Code</u> <u>c/o Superintendent of Documents</u> <u>U.S. Government Printing Office</u> <u>732 North Capitol Street NW</u> <u>Washington, DC 20401</u>	
<u>Standard reference number</u>	<u>Title</u>	<u>Referenced in code section number</u>
<u>18 USC Part 1, Ch.40</u>	<u>Importation, Manufacture, Distribution and Storage of Explosive Materials</u>	<u>202</u> <u>(EXPLOSIVE)</u>

<u>WCLIB</u>	<u>West Coast Lumber Inspection Bureau</u> <u>P. O. Box 23145</u> <u>Portland, OR 97281</u>	
<u>Standard reference number</u>	<u>Title</u>	<u>Referenced in code section number</u>
<u>AITC 104—03</u>	<u>Typical Construction Details</u>	<u>2306.1</u>
<u>AITC 110—01</u>	<u>Standard Appearance Grades for Structural Glued Laminated Timber</u>	<u>2306.1</u>
<u>AITC 113—10</u>	<u>Standard for Dimensions of Structural Glued Laminated Timber</u>	<u>2306.1</u>
<u>AITC 117—15</u>	<u>Standard Specifications for Structural Glued Laminated Timber of Softwood Species</u>	<u>2306.1</u>
<u>AITC 119—96</u>	<u>Standard Specifications for Structural Glued Laminated Timber of Hardwood Species</u>	<u>2306.1</u>
<u>AITC 200—09</u>	<u>Manufacturing Quality Control Systems Manual for Structural Glued Laminated Timber</u>	<u>2306.1</u>

<u>WDMA</u>	<u>Window and Door Manufacturers Association</u> <u>2025 M Street, NW Suite 800</u> <u>Washington, DC 20036-3309</u>	
<u>Standard reference number</u>	<u>Title</u>	<u>Referenced in code section number</u>
<u>AAMA/WDMA/CSA 101/I.S.2/A440—11</u>	<u>Specifications for Windows, Doors and Unit Skylights</u>	<u>1709.5.1,</u> <u>2405.5</u>

§ 52. Section D102.2.5 of appendix D of the New York city building code, as added

by local law number 33 for the year 2007, is amended to read as follows:

D102.2.5 R-1 and R-2 occupancies. No building or space classified in [~~occupancy group~~] Occupancy Group R-1 or R-2 may be located on a lot containing a building classified in construction Type IIB, VA or VB.

§ 52-a. Items 9 and 12 of section D105.1 of appendix D of the New York city building code, as amended by local law number 141 for the year 2013, are amended to read as follows:

9. One- or two-family detached or semidetached dwellings of two stories or less in height and 2,500 square feet (232 m²) or less in area per story located within Zoning Districts R-2 through R-5 may be constructed or reconstructed of construction Type VA, or if damaged for any cause only the damaged portions shall be required to be reconstructed to conform to Type VA construction. In addition, one-family dwellings located within Zoning District R-1 anywhere in the city, may be constructed of Type VB construction in conformance with the area and height limits established by [~~Table 503 of Chapter 5~~] Tables 504.3, 504.4 and 506.2 of this code.
12. One- or two-family detached, zero lot line or semi-detached dwellings of three stories in height and 2,500 square feet (232 m²) or less in area per story located within Zoning Districts R-1 through R-5 within Lower Density Growth Management Areas as defined by the *New York City Zoning Resolution* may be constructed or reconstructed of construction Type VA where such buildings are equipped throughout with an automatic sprinkler system in accordance with Section 903.3.1.1, or if damaged for any cause only the damaged portions shall be required to be reconstructed to conform to Type VA construction where such buildings are equipped throughout with an automatic sprinkler system in accordance with Section 903.3.1.1. In addition, no portion of a one- or two-family detached, zero lot line or semi-detached dwellings located within Zoning Districts R-1, R-2 or R-5 within Lower Density Growth Management Areas shall exceed a maximum building height of 35 feet (10 668 mm) above the grade plane.

§ 53. Section D106 of appendix D of the New York city building code, as added

by local law number 33 for the year 2007, is amended to read as follows:

SECTION BC D106
FIRE DISTRICT MAPS FOR THE BOROUGHS OF
STATEN ISLAND (RICHMOND COUNTY) AND QUEENS

D106.1 Fire district maps. Within the boroughs of Staten Island (Richmond County) and Queens, the fire districts shall comprise such areas indicated on the “fire district maps” as per Figures D106.1(1) and D106.1(2).

§ 53-a. Figure D106.1(1) of appendix D of the New York city building code, as added by local law number 33 for the year 2007, is amended to read as follows:

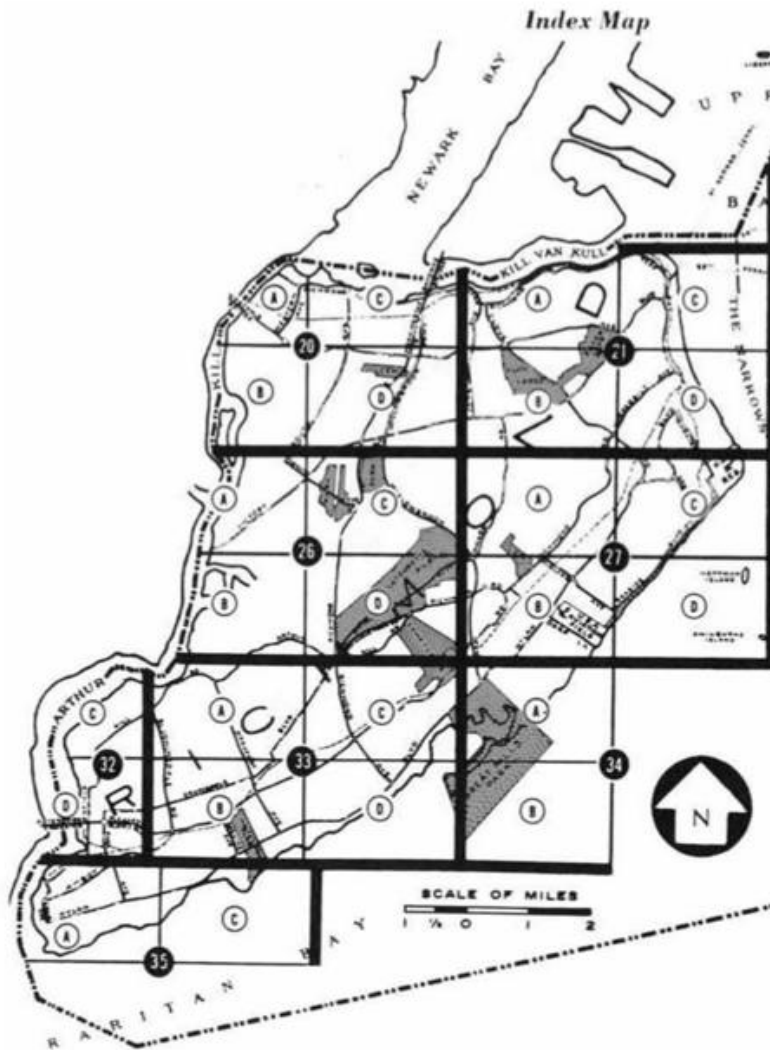



FIGURE D106.1(1) FIRE DISTRICT MAPS
BOROUGH OF STATEN ISLAND (RICHMOND
COUNTY)

NOTES:

¹ FIRE DISTRICT MAPS LEGEND

-  Inside Fire District
-  Outside Fire District

² BOUNDARY LINES HAVE BEEN ESTABLISHED:

- a. On centerlines of mapped streets;
OR
- b. 200'-0" distant from, and parallel to, street lot lines

Subpart 37 (Appendix E of the New York City Building Code)

§54. Appendix E of the New York city building code, as added by local law number 33 for the year 2007, sections E104.3, E105, E106.2, E107.2, and E112.4 as amended by local law number 141 for the year 2013, is amended to read as follows:

**APPENDIX E
SUPPLEMENTARY ACCESSIBILITY REQUIREMENTS**

**SECTION BC E101
GENERAL**

E101.1 Scope. The provisions of this appendix shall control the supplementary requirements for the design and construction of facilities for accessibility [~~to persons~~] for individuals with [~~physical~~] disabilities.

E101.2 Design. Technical requirements for items herein shall comply with this code and ICC A117.1.

**SECTION BC E102
DEFINITIONS**

E102.1 [General] Definitions. The following [~~words and~~] terms [~~shall, for the purposes of this appendix, have the meanings shown herein.~~] are defined in Chapter 2:

CLOSED-CIRCUIT TELEPHONE. [~~A telephone with a dedicated line such as a house phone, courtesy phone or phone that must be used to gain entrance to a facility.~~]

MAILBOXES. [~~Receptacles for the receipt of documents, packages or other deliverable matter. Mailboxes include, but are not limited to, post office boxes and receptacles provided by commercial mail receiving agencies, apartment houses and schools.~~]

TRANSIENT LODGING. [~~A building, facility or portion thereof, excluding inpatient medical care facilities and long-term care facilities, that contains one or more dwelling units or sleeping units. Examples of transient lodging include, but are not limited to, resorts, group homes, hotels, motels, dormitories, homeless shelters, halfway houses and social service lodging.~~]

**SECTION BC E103
ACCESSIBLE ROUTE**

E103.1 Raised platforms. In banquet rooms or spaces where a head table or speaker's lectern is located on a raised platform, an accessible route shall be provided to the platform.

**SECTION BC E104
SPECIAL OCCUPANCIES**

E104.1 General. Transient lodging facilities shall be provided with accessible features in accordance with Sections E104.2 and E104.3. Group I-3 occupancies shall be provided with accessible features in accordance with Sections [~~E104.3~~] E104.2 and E104.4.

[~~**E104.2 Accessible beds.** In rooms or spaces having more than 25 beds, five percent of the beds shall have a clear floor space complying with Section 305 (Clear Floor Space) of ICC A117.1.~~]

~~[E104.2.1 Sleeping areas. A clear floor space complying with Section 305 (Clear Floor Space) of ICC A117.1 shall be provided on both sides of the accessible bed. The clear floor space shall be positioned for parallel approach to the side of the bed.]~~

~~[Exception: This requirement shall not apply where a single clear floor space complying with Section 305 (Clear Floor Space) of ICC A117.1 positioned for parallel approach is provided between two beds.]~~

~~[E104.3] E104.2 Communication features. [Communication] Accessible communication features complying with Chapter 7 of ICC A117.1 shall be provided in accordance with Sections [E104.3.1] E104.2.1 through [E104.3.4] E104.2.4 of this code.~~

~~[E104.3.1] E104.2.1 Transient lodging. In transient lodging facilities, sleeping units with accessible communication features shall be provided in accordance with Table [E104.3.1] E104.2.1. Units required to comply with Table [E104.3.1] E104.2.1 shall be dispersed among the various classes of units.~~

**TABLE ~~[E104.3.1] E104.2.1~~
DWELLING OR SLEEPING UNITS WITH ACCESSIBLE COMMUNICATION FEATURES**

TOTAL NUMBER OF DWELLING OR SLEEPING UNITS PROVIDED	MINIMUM REQUIRED NUMBER OF DWELLING OR SLEEPING UNITS WITH ACCESSIBLE COMMUNICATION FEATURES
1	1
2 to 25	2
26 to 50	4
51 to 75	7
76 to 100	9
101 to 150	12
151 to 200	14
201 to 300	17
301 to 400	20
401 to 500	22
501 to 1,000	5% of total
1,001 and over	50 plus 3 for each 100 over 1,000

~~[E104.3.2] E104.2.2 Group I-3. In Group I-3 occupancies at least 2 percent, but no fewer than one of the total number of general holding cells and general housing cells equipped with audible emergency alarm systems and permanently installed telephones within the cell, shall comply with Section [E104.3.4] E104.2.4.~~

~~[E104.3.3] E104.2.3 Dwelling units and sleeping units. Where dwelling units and sleeping units are altered or added, the requirements of Section [E104.3] E104.2 shall apply only to the units being altered or added until the number of units with accessible communication features complies with the minimum number required for new construction.~~

~~[E104.3.4]~~ **E104.2.4 Notification devices.** Visual notification devices shall be provided to alert room occupants of incoming telephone calls and a door knock or bell. Notification devices shall not be connected to visual alarm signal appliances. Permanently installed telephones shall have volume controls and an electrical outlet complying with ICC A117.1, including Section 309 (Operable Parts), located within 48 inches (1219 mm) of the telephone to facilitate the use of a TTY.

E104.3 Accessible beds. In rooms or spaces having more than 25 beds, five percent of the beds shall have a clear floor space complying with Section 305 (Clear Floor Space) of ICC A117.1.

E104.3.1 Sleeping areas. A clear floor space complying with Section 305 (Clear Floor Space) of ICC A117.1 shall be provided on both sides of the accessible bed. The clear floor space shall be positioned for parallel approach to the side of the bed.

Exception: This requirement shall not apply where a single clear floor space complying with Section 305 (Clear Floor Space) of ICC A117.1 positioned for parallel approach is provided between two beds.

E104.4 Partitions. Solid partitions or security glazing that separates visitors from detainees in Group I-3 occupancies shall provide a method to facilitate voice communication. Such methods are permitted to include, but are not limited to, grilles, slats, talk-through baffles, intercoms or telephone handset devices. The method of communication shall be accessible to individuals who use wheelchairs and individuals who have difficulty bending or stooping. Hand-operable communication devices, if provided, shall comply with Section E106.3.

SECTION BC E105 OTHER FEATURES AND FACILITIES

E105.1 Portable toilets and bathing rooms. Where multiple single-user portable toilet or bathing units are clustered at a single location, at least 5 percent, but not less than one toilet unit or bathing unit at each cluster, shall be accessible and comply with ICC A117.1, including Section 603 (Toilet and Bathing Rooms). Signs containing the [~~International Symbol of Accessibility~~] dynamic accessibility symbol and complying with Section 703 (Signs) of ICC A117.1 shall identify accessible portable toilets and bathing units.

Exception: Portable toilet units provided for use exclusively by construction personnel on a construction site.

E105.2 Laundry equipment. Where provided in spaces required to be accessible, washing machines and clothes dryers shall comply with this section. Where laundry equipment is provided within a dwelling or sleeping unit, not for public use or common use, such equipment shall comply with Section 1107.2.8.

E105.2.1 Washing machines. Where three or fewer washing machines are provided, at least one shall comply with ICC A117.1, including Section 611 (Washing Machines and Clothes Dryers), and shall be [~~front loading~~] accessible. Where more than three washing machines are provided, at least two shall comply with ICC A117.1, including Section 611 and shall be [~~front loading~~] accessible.

E105.2.2 Clothes dryers. Where three or fewer clothes dryers are provided, at least one shall comply with ICC A117.1, including Section 611 (Washing Machines and Clothes Dryers), and shall be ~~[front-loading]~~ accessible. Where more than three clothes dryers are provided, at least two shall comply with ICC A117.1, including Section 611, and shall be ~~[front-loading]~~ accessible.

E105.3 Depositories, vending machines, change machines and similar equipment. ~~[Where provided, at]~~ At least one of each type of depository, vending machine, change machine and similar equipment shall [comply with ICC A117.1] be accessible.

Exception: Drive-up-only depositories are not required to comply with this section.

E105.4 Mailboxes. Where mailboxes are provided in facilities not subject to Section 1107.3.1, but required to be accessible pursuant to the Americans with Disabilities Act, at least five percent, but not less than one, of each type shall comply with ICC A117.1.

E105.5 Automatic teller machines and fare machines. Where automatic teller machines or self-service fare vending, collection or adjustment machines are provided, at least one machine of each type at each location where such machines are provided shall be accessible and comply with ICC A117.1, including Section 707 (ATMs and Fare Machines). Where bins are provided for envelopes, wastepaper or other purposes, at least one of each type shall be accessible and comply with ICC A117.1, including Section 905 (Storage Facilities).

E105.6 Two-way communication systems. Where two-way ~~[Communication]~~ communication systems are provided to gain admittance to a building or facility or to restricted areas within a building or facility, the system shall be accessible and comply with ICC A117.1, including Section 708 (Two-Way Communication Systems).

SECTION BC E106 TELEPHONES

E106.1 General. Where coin-operated public pay telephones, coinless public pay telephones, public closed-circuit telephones, courtesy phones or other types of public telephones are provided, accessible public telephones shall be provided in accordance with Sections E106.2 through E106.5 for each type of public telephone provided. For purposes of this section, a bank of telephones shall be considered two or more adjacent telephones.

E106.2 Wheelchair-accessible telephones. Where public telephones are provided, wheelchair-accessible telephones complying with ICC A117.1, including Section 704 (Telephones), shall be provided in accordance with Table E106.2.

Exception: Drive-up-only public telephones are not required to be accessible.

**TABLE E106.2
WHEELCHAIR-ACCESSIBLE TELEPHONES**

NUMBER OF TELEPHONES PROVIDED ON A FLOOR, LEVEL OR EXTERIOR SITE	MINIMUM REQUIRED NUMBER OF WHEELCHAIR-ACCESSIBLE TELEPHONES
1 or more single unit	1 per floor, level and exterior site
1 bank	1 per floor, level and exterior site
2 or more banks	1 per bank

E106.3 Volume controls. All public telephones provided shall have accessible volume control complying with Section 704.3 (Volume-Control Telephones) of ICC A117.1.

E106.4 TTYs. TTYs complying with ICC A117.1, including Sections 704.4 through 704.7, shall be provided in accordance with Sections E106.4.1 through E106.4.9.

E106.4.1 Bank requirement. Where four or more public pay telephones are provided at a bank of telephones, at least one public TTY shall be provided at that bank.

Exception: TTYs are not required at banks of telephones located within 200 feet (60 960 mm) of, and on the same floor as, a bank containing a public TTY.

E106.4.2 Floor requirement. Where four or more public pay telephones are provided on a floor of a privately owned building, at least one public TTY shall be provided on that floor. Where at least one public pay telephone is provided on a floor of a publicly owned building, at least one public TTY shall be provided on that floor.

E106.4.3 Building requirement. Where four or more public pay telephones are provided in a privately owned building, at least one public TTY shall be provided in the building. Where at least one public pay telephone is provided in a publicly owned building, at least one public TTY shall be provided in the building.

E106.4.4 Site requirement. Where four or more public pay telephones are provided on a site, at least one public TTY shall be provided on the site.

E106.4.5 Rest stops, emergency road stops[;] and service plazas. Where a public pay telephone is provided at a public rest stop, emergency road stop or service plaza, at least one public TTY shall be provided.

E106.4.6 Hospitals. Where a public pay telephone is provided in or adjacent to a hospital emergency room, hospital recovery room or hospital waiting room, at least one public TTY shall be provided at each such location.

E106.4.7 Transportation facilities. Transportation facilities shall be provided with TTYs in accordance with Section E109.2.5 in addition to the TTYs required by Sections E106.4.1 through E106.4.4.

E106.4.8 Detention and correctional facilities. In detention and correctional facilities, where a public pay telephone is provided in a secured area used only by detainees or inmates and security personnel, then at least one TTY shall be provided in at least one secured area.

E106.4.9 Signs. Public TTYs shall be identified by the International Symbol of TTY complying with Section 703.6.3.2 (International Symbol of TTY) of ICC A117.1. Directional signs indicating the location of the nearest public TTY shall be provided at banks of public pay telephones not containing a public TTY. Additionally, where signs provide direction to public pay telephones, they shall also provide direction to public TTYs. Such signs shall comply with visual signage requirements in ICC A117.1, including Section 703.2 (Visual Characters), and shall include the International Symbol of TTY.

E106.5 Shelves for portable TTYs. Where a bank of telephones in the interior of a building consists of three or more public pay telephones, at least one public pay telephone at the bank shall be provided with a shelf and an electrical outlet in accordance with Section 704.6 (TTY Shelf) of ICC A117.1.

Exceptions:

1. In secured areas of detention and correctional facilities, if shelves and outlets are prohibited for purposes of security or safety shelves and outlets for TTYs are not required to be provided.
2. The shelf and electrical outlet shall not be required at a bank of telephones with a TTY.

**SECTION BC E107
SIGNAGE**

E107.1 Signs. Required accessible portable toilets and bathing facilities shall be identified by the ~~[International Symbol of Accessibility]~~ dynamic accessibility symbol, in accordance with Figure 1111.1.

E107.2 Designations. Interior and exterior signs identifying permanent rooms and spaces shall ~~[be] have [tactile]~~ visual characters, raised characters and braille complying with ICC A117.1. Where pictograms are provided as designations of interior rooms and spaces, the pictograms shall have ~~[tactile text descriptors. Signs required to provide tactile]~~ visual characters, raised characters and [pictograms shall comply] braille complying with Sections [703.3 and]703.2 through 703.5 of ICC A117.1.

Exceptions:

1. Exterior signs that are not located at the door to the space they serve are not required to comply.
2. Building directories, menus, seat and row designations in assembly areas, occupant names, building addresses and company names and logos are not required to comply.
3. Signs in parking facilities are not required to comply.

4. Temporary (seven days or less) signs are not required to comply.
5. In detention and correctional facilities, signs not located in public areas are not required to comply.

E107.3 Directional and informational signs. Signs that provide direction to, or information about, permanent interior spaces of the site and facilities shall contain visual characters complying with Section 703.2 (Visual Characters) of ICC A117.1.

Exception: Building directories, personnel names, company or occupant names and logos, menus and temporary (seven days or less) signs are not required to comply with ICC A117.1.

E107.4 Other signs. Signage indicating special accessibility provisions shall be provided at fixed facilities and stations, signage must be provided in accordance with Sections E109.2.2 through E109.2.2.3.

SECTION BC E108 RESERVED

SECTION BC E109 TRANSPORTATION FACILITIES AND STATIONS

E109.1 General. Fixed transportation facilities and stations shall comply with the applicable provisions of Section E109.2.

E109.2 New construction. New stations in rapid rail, light rail, commuter rail, intercity rail, high speed rail and other fixed guideway systems shall comply with Sections E109.2.1 through E109.2.8.

E109.2.1 Station entrances. Where different entrances to a station serve different transportation fixed routes or groups of fixed routes, all entrance serving each group or route shall comply with Section 1104 and ICC A117.1, including Section 404 (Doors and Doorways).

E109.2.2 Signs. Signage in fixed transportation facilities and stations shall comply with Sections E109.2.2.1 through E109.2.2.3.

E109.2.2.1 ~~[Tactile]~~ Raised character and braille signs. Where signs are provided at entrances to stations identifying the station or the entrance, or both, at least one sign at each entrance shall ~~[be tactile]~~ have raised characters and braille. A minimum of one ~~[tactile]~~ raised character and braille sign identifying the specific station shall be provided on each platform or boarding area. Such signs shall be placed in uniform locations at entrances and on platforms or boarding areas within the transit system to the maximum extent practicable. ~~[Tactile]~~ Raised character and braille signs shall comply with ~~[Section]~~ Sections 703.3 (~~[Tactile]~~ Raised Characters) and 703.4 (Braille) of ICC A117.1.

Exceptions:

1. Where the station has no defined entrance but signs are provided, the ~~[tactile]~~ raised character and braille signs shall be placed in a central location.
2. Signs are not required to be ~~[tactile]~~ raised character and braille where audible signs are remotely transmitted to hand-held receivers, or are user or proximity actuated.

E109.2.2.2 Identification signs. Stations covered by this section shall have identification signs containing visual characters complying with Section 703.2 (Visual Characters) of ICC A117.1. Signs shall be clearly visible and within the sightlines of a standing or sitting passenger from within the train on both sides when not obstructed by another train.

E109.2.2.3 Informational signs. Lists of stations, routes and destinations served by the station ~~[which]~~ that are located on boarding areas, platforms or mezzanines shall provide visual characters complying with Section 703.2 (Visual Characters) of ICC A117.1. Signs covered by this provision shall, to the maximum extent practicable, be placed in uniform locations within the transit system.

E109.2.3 Fare machines. Self-service fare vending, collection and adjustment machines shall comply with Section 707 (ATMs and Fare Machines) ~~of ICC A117.1~~. Where self-service fare vending, collection or adjustment machines are provided for the use of the general public, at least one accessible machine of each type provided shall be provided at each accessible point of entry and exit.

E109.2.4 Rail-to-platform height. Station platforms shall be positioned to coordinate with vehicles in accordance with the applicable provisions of 36 CFR, Part 1192. Low-level platforms shall be 8 inches (203 mm) minimum above top of rail.

Exception: Where vehicles are boarded from sidewalks or street level, low-level platforms shall be permitted to be less than 8 inches (203 mm).

E109.2.5 TTYs. Where a public pay telephone is provided in a transit facility (as defined by the Department of Transportation), at least one public TTY complying with ~~[Sections 704.4 through 704.7 of]~~ ICC A117.1, Sections 704.4 through 704.7, shall be provided in the station. In addition, where one or more public pay telephones serve a particular entrance to a transportation facility, at least one TTY telephone complying with ICC A117.1, ~~[Section]~~ Sections 704.4 through 704.7 ~~[of ICC A117.1]~~ shall be provided to serve that entrance.

E109.2.6 Track crossings. Where a circulation path serving boarding platforms crosses tracks, an accessible route complying with ICC A117.1, including Section 402 (Accessible Routes) shall be provided.

Exception: Openings for wheel flanges shall be permitted to be 2¹/₂ inches (64 mm) maximum.

E109.2.7 Public address systems. Where public address systems convey audible information to the public, the same or equivalent information shall be provided in a visual format.

E109.2.8 Clocks. Where clocks are provided for use by the general public, the clock face shall be uncluttered so that its elements are clearly visible. Hands, numerals and digits shall contrast with the background either light-on-dark or dark-on-light. Where clocks are mounted overhead, numerals and digits shall comply with ICC A117.1, Section 703.2 (Visual Characters) [~~of ICC A117.1~~].

[E109.3 Reserved.]

**SECTION BC E110
RESERVED**

**SECTION BC E111
[RESERVED]**

**[SECTION BC E112]
REFERENCED STANDARDS**

[E112.1] E111.1 General. This section lists the standards that are referenced in various sections of this appendix. The standards are listed herein by the promulgating agency of the standard, the standard identification, the effective date and title and the section or sections of this document that reference the standard.

[E112.2] E111.2 Subsequent additions, modifications, or deletions. Refer to the rules of the department for any subsequent additions, modifications or deletions that may have been made to these standards in accordance with Section 28-103.19 of the [~~Administrative Code~~] Administrative Code.

[E112.3] E111.3 Applicability. The application of the referenced standards shall be as specified in Section 102.4.

[E112.4] E111.4 Standards.

DOJ 36 CFR Part 1192	Americans with Disabilities Act (ADA) Accessibility Guidelines for Transportation Vehicles (ADAAG). Washington, DC: Department of Justice, 1991	E109.2.4
ICC A117.1-09	Accessible and Usable Buildings and Facilities	E101.2, et al.

§55. Section F102.5 of appendix F of the New York city building code, as added

by local law number 33 for the year 2007, is amended to read as follows:

F102.5 Exterior wall ventilation openings. Exterior wall ventilator openings located with any portion within 2 feet (610 mm) of outside ground level shall be covered for their height and width with perforated sheet metal plates no less than 0.070 inch (1.8 mm) thick, expanded sheet metal

plates not less than 0.047 inch (1.2 mm) thick, ~~cast-iron~~ cast-iron grills or grating, extruded aluminum load-bearing vents or with hardware cloth of 0.035 inch (0.89 mm) wire or heavier. The openings therein shall not exceed ¼ inch (6.4 mm).

§ 56. Appendix G of the New York city building code, as added by local law number 33 for the year 2007, sections G103.3.1 and G307.4 as added by local law number 99 for the year 2013, section G307.5 as added by local law number 100 for the year 2013, section G311 as added by local law number 108 for the year 2013, and sections G102, G104, G105, G106, G107, G201, G301, G303, G304, G308, G309, G310, G402 and G501 as amended by local law number 141 for the year 2013, are amended to read as follows:

**APPENDIX G
FLOOD-RESISTANT CONSTRUCTION**

**~~[CHAPTER G1]~~
~~[GENERAL PROVISIONS]~~**

**SECTION BC G101
PURPOSE AND OBJECTIVES**

G101.1 Purpose. The purpose of this appendix is to promote the public health, safety and general welfare and to minimize public and private losses due to flood conditions in specific flood hazard areas through the establishment of comprehensive regulations for management of flood hazard areas designed to:

1. Prevent unnecessary disruption of commerce, access and public service during times of flooding;
2. Manage the alteration of natural ~~[flood plains]~~ floodplains, stream channels and shorelines;
3. Manage filling, grading, dredging and other development ~~[which]~~ that may increase flood damage or erosion potential;
4. Prevent or regulate the construction of flood barriers ~~[which]~~ that will divert floodwaters or ~~[which]~~ that can increase flood hazards;
5. Contribute to improved construction techniques in the ~~[flood plain;]~~ floodplains; and
6. Comply with and exceed the minimum standards of the National Flood Insurance Program as administered by the Federal Emergency Management Agency (FEMA).

G101.2 Objectives. The objectives of this appendix are to:

1. Protect human life;
2. Minimize the expenditure of public money for flood control projects;
3. Minimize the need for rescue and relief efforts associated with flooding;
4. Minimize prolonged business interruption;
5. Minimize damage to structures located in [~~areas of special~~] flood hazard areas;
6. Minimize damage to public facilities and utilities such as water, electricity, telephone and sewer lines, and streets and bridges located in [~~areas of special~~] flood hazard areas;
7. Help maintain a stable tax base by providing for the sound use and development of flood prone areas; and
8. Ensure that potential owners and occupants are notified that property is within [~~areas of special~~] flood hazard areas.

G101.3 [~~Reserved.~~ Referenced standards. Where this code makes reference to the nationally recognized standard ASCE 24, such standard shall be as modified for New York City in accordance with Section G501 of this appendix.

G101.4 Reserved.

SECTION BC G102 APPLICABILITY

G102.1 General. This appendix, in conjunction with the *New York City Construction Codes*, provides minimum requirements for development located, in whole or in part, in [~~areas of~~] special flood hazard areas and shaded X-Zones within the jurisdiction of New York City, including:

1. **Subdivisions.** This appendix shall apply to the subdivision of land;
2. **Utilities.** This appendix shall apply to the installation of utilities;
3. **Group U buildings and structures.** This appendix shall apply to placement and replacement of Group U buildings as defined in Section 312;
4. **Site improvements.** This appendix shall apply to site improvements, including but not limited to, temporary or permanent storage of materials, mining, dredging, filling, grading, paving, excavations, operations and other land disturbing activities;
5. **Prefabricated buildings and manufactured homes.** This appendix shall apply to placement and replacement of prefabricated buildings and manufactured homes;
6. **Post-FIRM construction.** This appendix shall apply to post-FIRM construction;

7. **Alterations to post-FIRM construction.** This appendix shall apply to repair, alteration, reconstruction, rehabilitation[;] or additions to post-FIRM construction;
8. **Substantial improvement of pre-FIRM construction.** This appendix shall apply to substantial improvement of pre-FIRM buildings and structures, including restoration after damage, as if hereafter erected;
9. **Horizontal enlargements of pre-FIRM construction.** This appendix shall apply to horizontal enlargements of pre-FIRM buildings and structures to the extent of such horizontal enlargement, including but not limited to additions[;] (whether above or below grade), decks, carports, or similar appendages. The existing portions of the structure shall not be required to comply, unless otherwise required because the alteration is deemed a substantial improvement; and
10. **Other alterations to pre-FIRM construction.** This appendix shall apply to [~~alterations or repairs~~] repair, alteration, reconstruction, rehabilitation, or additions to pre-FIRM buildings and structures[; including installation of new components, materials, finishes and equipment, that increase the degree of noncompliance with this appendix]. No increase in the degree of noncompliance with this appendix shall be permitted. The requirements of this Item 10 shall be deemed satisfied if the work would not increase the degree of noncompliance with this appendix.

10.1. Work that increases the degree of noncompliance. Work to pre-FIRM construction deemed as an increase in the degree of noncompliance includes, but is not limited to:

- 10.1.1. The conversion of any space below the design flood elevation from nonhabitable space into habitable space;
- 10.1.2. The creation of a direct communication between a dwelling unit and a space below the design flood elevation;
- 10.1.3. Where a dwelling unit already has space below the design flood elevation or has space with which the dwelling unit directly communicates that is below the design flood elevation, an increase in such space;
- 10.1.4. The conversion of any space below the design flood elevation in a non-residential building (for flood zone purposes) to accessory (as such term is defined in NYC ZR) to a group R-1, R-2, or R-3 occupancy, when such space was not previously accessory to such occupancy;
- 10.1.5. The installation of new components, materials, finishes, plumbing fixtures and equipment below the design flood elevation that are not permitted by this appendix to be located below the design flood elevation, where such similar items did not previously exist, except for new components, materials, finishes, and equipment as permitted by Item 10.2.2;

10.1.6. The lowering of the elevation of a floor of a basement (for floodzone purposes), or a portion thereof located below the design flood elevation, except as permitted by Item 10.2.4;

10.1.7. An alteration consisting of a change in use, occupancy or how such space is used in a building, or portion thereof, that results in a more restrictive flood design class per ASCE 24; and

10.1.8. Any condition not addressed in Items 10.1.1 through 10.1.7 as determined by the commissioner.

10.2. Work that does not increase the degree of noncompliance. The following [~~alterations or repairs~~] work to pre-FIRM construction, other than substantial improvements, shall not be deemed as an increase in the degree of noncompliance:

~~[10.1. Where the alteration or repair comprises the replacement of pre-FIRM components, materials, finishes or equipment;]~~

~~[10.2. Where the alteration or repair comprises the installation of new components, materials, finishes or equipment in a space within the structure where similar pre-FIRM components, materials, finishes or equipment already exist; and]~~

~~[10.3. Where such alteration is a change in use, occupancy or how such space is used, provided that such change would not increase the degree of noncompliance with requirements of this appendix. The conversion of any space below the design flood elevation from nonhabitable space into habitable space shall be deemed an increase in the degree of noncompliance.]~~

10.2.1. Plumbing fixtures:

10.2.1.1. The in-kind replacement of plumbing fixtures below the design flood elevation; and

10.2.1.2. The installation of new plumbing fixtures in a space within the structure where similar plumbing fixtures already exist, provided that the number of plumbing fixtures is not increased and provided any required backflow prevention and/or sewage ejection is provided in accordance with this appendix.

10.2.2. Components, materials, finishes, equipment, fire protection systems and equipment, and appliances, other than plumbing fixtures:

10.2.2.1. The in-kind replacement of components, materials, finishes, equipment, fire protection systems and equipment, and appliances;

10.2.2.2. The installation of new components, materials, finishes, equipment, fire protection systems and equipment, and appliances, in a space within the structure where similar pre-FIRM items already exist; and

10.2.2.3. Within existing nonresidential portions of a nonresidential (for flood zone purposes) building, the installation of new components, materials, finishes, equipment, fire protection systems and equipment, and appliances which serve only the space(s) being altered below the design flood elevation, provided such items, as well as any associated electrical wiring, are designed and/or isolated so as not to affect the operation of building components, systems and wiring of other parts of the building if submerged. This item shall not include increases to the number of plumbing fixtures or the installation of building systems which support other areas of the building.

10.2.3. Change in use, occupancy or how such space is used. Alteration consisting of a change in use, occupancy or how such space is used in a nonresidential building (for flood zone purposes), or portion thereof, that does not result in a more restrictive flood design class per ASCE 24, is not a conversion from nonhabitable space into habitable space, and is not otherwise required by Item 10.1.4 to comply with this appendix. Such alteration shall also comply with the provisions of Item 10.2.2; and

10.2.4. Pits. The lowering of the elevation of a floor or a portion thereof located below the design flood elevation for pits to accommodate sump pumps, house traps, valve access, cleanouts, ejector pumps and elevators.

11. Retroactive requirements. This appendix shall apply to retroactive requirements as provided for in Section [~~G314~~] G312.

G102.2 Establishment of [~~areas of special~~] flood hazard areas. The following flood hazard map and supporting data are adopted as referenced standards and declared to be a part of this appendix.

1. FEMA FIS 360497.
2. FEMA FIRMs 360497.

G102.2.1 Preliminary flood insurance study and rate maps. Until such time that the department by rule adopts revised FEMA FIS 360497 and FEMA FIRMs 360497 with a final effective date later than [~~May 1, 2014~~] April 18, 2018, the following flood hazard maps and supporting data are also adopted as a referenced standard and declared a part of this appendix.

1. FEMA PFIS 360497.
2. FEMA PFIRMs 360497.

G102.2.2 Effect of preliminary flood insurance study and rate maps. Notwithstanding any other provision in this appendix to the contrary:

1. All references in this appendix to elevations in FEMA FIS 360497 and FEMA FIRMs 360497 shall be deemed to refer to the greater of (i) the elevations identified in the

FEMA FIS 360497/FEMA FIRMs 360497 or (ii) the elevations identified in the FEMA PFIS 360497/FEMA PFIRMs 360497. In comparing elevations, the elevations identified in FEMA FIS 360497 and FEMA FIRMs 360497 that are expressed in relation to the National Geodetic Vertical Datum (NGVD) shall be converted to the North American Vertical Datum (NAVD).

2. All references in this appendix to ~~[areas of special]~~ flood hazard areas as delineated on FEMA FIRMs 360497 shall be deemed to refer to the ~~[areas of special]~~ flood hazard areas as delineated on FEMA PFIRMs 360497 except that, where a structure is located in ~~[an area of special]~~ a flood hazard area as delineated on FEMA PFIRMs 360497 and in a more restrictive ~~[area of special]~~ flood hazard area as delineated on FEMA FIRMs 360497, such structure shall be deemed to be located in the more restrictive ~~[area of special]~~ flood hazard area as delineated on FEMA FIRMs 360497.

G102.3 Letters of map change. Map changes to FEMA FIRMs 360497 shall be administered in compliance with Sections G102.3.1 through G102.3.3.

G102.3.1 Letters of map amendment (LOMA). Where FEMA FIRMs 360497 indicates that a structure or tax lot is within a delineated ~~[area of]~~ special flood hazard area, but the pre-FIRM ground elevations adjacent to the structure or throughout the tax lot are at or above the base flood elevation, the commissioner shall deem such structure or tax lot as being within the ~~[area of]~~ special flood hazard area and shall not approve plans except in compliance with this appendix, unless a letter of map amendment (LOMA) is issued by FEMA removing such structure or tax lot from the ~~[area of]~~ special flood hazard area.

G102.3.1.1 Letters of map amendment (LOMAs) during pendency of PFIRMs. Until such time that the department by rule adopts revised FEMA FIS 360497 and FEMA FIRMs 360497 with a final effective date later than ~~[May 1, 2014]~~ April 18, 2018, the commissioner shall not deem issuance of a LOMA by FEMA as removing such structure or tax lot from the ~~[area of]~~ special flood hazard area unless the elevations specified in the LOMA equal or exceed the applicable corresponding elevations on the FEMA PFIS 360497/FEMA PFIRMs 360497.

G102.3.2 Letter of map revision based on fill (LOMR-F). Where FEMA FIRMs 360497 indicates that a structure or tax lot is within a delineated ~~[area of]~~ special flood hazard area, but post-FIRM compacted fill is proposed to be added adjacent to the structure or throughout the tax lot to an elevation at or above the base flood elevation, the commissioner shall deem such structure or tax lot as being within the ~~[area of]~~ special flood hazard area and shall not approve plans except in compliance with this appendix, unless a conditional or final letter of map revision based on fill (LOMR-F) is issued by FEMA removing such structure or tax lot from the ~~[area of]~~ special flood hazard area. Buildings constructed with basements below the Base Flood Elevation on filled land shall maintain a minimum setback distance of 20 feet (6096 mm), at or above the Base Flood Elevation, from the edge of the ~~[Special Flood Hazard Area]~~ special flood hazard area to the nearest wall of the basement, regardless of the design approach used. The commissioner shall promulgate rules establishing procedures for processing letters of map revision based on fill (LOMR-F).

G102.3.2.1 Letters of map revision based on fill (LOMR-Fs) during pendency of PFIRMs. Until such time that the department by rule adopts revised FEMA FIS 360497 and FEMA FIRMs 360497 with a final effective date later than [~~May 1, 2014~~] April 18, 2018, the commissioner shall not deem issuance of a LOMR-F as removing such structure or tax lot from the [~~area of~~] special flood hazard area unless the elevations specified in the LOMR-F equal or exceed the applicable corresponding elevations on the FEMA PFIS 360497/FEMA PFIRMs 360497.

G102.3.3 Certificates of occupancy. Certificates of occupancy shall indicate that the structure or tax lot is subject to a letter of map amendment (LOMA) or letter of map revision based on fill (LOMR-F) as per Section G106.5.

SECTION BC G103 ADMINISTRATION

G103.1 Permit applications. The commissioner is hereby designated as the [~~flood plain~~] floodplain administrator for the City of New York and shall review permit applications to determine that:

1. Proposed development sites will be reasonably safe from flooding;
2. All site development activities, including grading, filling, utility installation and drainage modification, and all new construction and substantial improvements (including the placement of prefabricated buildings and manufactured homes) are designed and constructed with methods, practices and materials that minimize flood damage and that are in accordance with this code and ASCE 24; and
3. All other required state and federal permits have been obtained.

G103.2 Reserved.

G103.3 Determination of flood elevations. Flood elevations shall be determined in accordance with Sections G103.3.1 through G103.3.2.

G103.3.1 Determination of base flood elevations. Where the proposed development is within [~~an area of~~] a special flood hazard area but the base flood elevations are not specified in the FEMA FIRMs 360497, the commissioner shall require the applicant to request base flood elevation data from the New York State Department of Environmental Conservation (DEC); and

1. Submit to the commissioner either:
 - 1.1. A letter from DEC making such a determination of base flood elevation; or
 - 1.2. A letter from the DEC indicating that the data are not available. When such a letter from DEC indicates that the data are not available, the base flood elevation shall be equal to 3 feet (914 mm) above the highest adjacent pre-FIRM grade.

Exception: Large lots. Where the base flood elevation is not specified, the applicant shall submit a detailed engineering study establishing the base flood elevation, performed by an engineer in accordance with accepted hydrologic and hydraulic engineering techniques, in sufficient detail to allow review by the commissioner for any of the following conditions:

1. For a development which is located on a tax lot greater than 5 acres (2.02 hectares), or is located on property that was part of a tax lot that was greater than 5 acres (2.02 hectares) at the time of the adoption of the FIRM (October 1, 1984), or at any subsequent applicable map change thereto; or
2. For subdivisions resulting in 50 or more tax lots, including all tax lots previously subdivided from the same tax lot since the adoption of the FIRM (October 1, 1984), or since any subsequent applicable map changes thereto.

[G103.3.1] G103.3.2 Determination of 500-year flood elevations. Where 500-year flood elevations are not specified in the FEMA FIRMs 360497 or FEMA FIS 360497, such elevations shall be determined by a registered design professional using modeling based on generally accepted engineering methods or a review of available data from city, state and federal agencies.

G103.4 Reserved.

G103.5 Floodway encroachment. Prior to issuing a permit for any floodway encroachment, including fill, new construction, substantial improvements and other development or land-disturbing activity, the commissioner shall require submission of a certification, prepared by a registered design professional, along with supporting technical data, demonstrating that such development will not cause any increase of the level of the base flood. ~~[However, a floodway encroachment that increases the level of the base flood may be authorized if the applicant has:]~~

~~[1. Applied for a conditional Letter of Map Revision; and]~~

~~[2. Received the approval of the Federal Emergency Management Agency (FEMA).]~~

G103.5.1 Floodway revisions. A floodway encroachment that increases the level of the base flood is authorized if the applicant has applied for a conditional Flood Insurance Rate Map (FIRM) revision and has received the approval of the Federal Emergency Management Agency (FEMA).

G103.6 Watercourse alteration. Prior to issuing a permit for any alteration or relocation of any watercourse within ~~[an area of]~~ a special flood hazard area, the commissioner shall require the applicant to:

1. Notify any affected adjacent municipalities or government jurisdictions;
2. Notify the DEC;

3. Submit evidence of such notifications to the commissioner and the Regional Director, Region II, the Federal Emergency Management Agency (FEMA);
4. Submit to the commissioner evidence of all such notifications;
5. Submit an engineering analysis demonstrating that the flood-carrying capacity of the altered or relocated portion of the watercourse will not be decreased; and
6. Submit evidence that such watercourses will be maintained in a manner which preserves the channel's flood-carrying capacity.

G103.7 [~~Sand dune alterations in V-Zones~~] Alterations in coastal areas. Prior to issuing a permit for any alteration of sand dunes [~~in a V-Zone~~] in coastal high-hazard areas and coastal A-zones, the commissioner shall require submission of an engineering analysis, prepared by a registered design professional, demonstrating that the proposed alteration will not increase the potential for flood damage.

G103.8 Records. The commissioner shall maintain records of the following:

1. Applications and supporting documents for development in [~~areas of special~~] flood hazard areas;
2. Permits issued in [~~areas of special~~] flood hazard areas;
3. Inspection reports;
4. Certifications required in this appendix; and
5. Certificate of occupancy where applicable.

G103.9 Violations. See Chapter 2 of Title 28 of the *Administrative Code*.

SECTION BC G104 PERMITS

G104.1 [~~Permit required~~] Required. Any person, owner or owner's authorized agent who intends to conduct any development, as applicable pursuant to Section G102.1, within [~~an area of special~~] a flood hazard area, shall first [~~apply~~] make application to the commissioner and shall obtain the required permit in accordance with Section 28-105.1 of the *Administrative Code*, notwithstanding any exemption pursuant to Section 28-105.4 of the *Administrative Code*.

G104.2 [~~Permit application requirements~~] Application for permit. The applicant shall file an application in writing on a form furnished by the commissioner. The commissioner shall not approve such application unless the applicant submits all plans, details, data and documents demonstrating that the development complies with [~~Section G104~~] Sections G104.2.1 through G104.2.3 and all other provisions of this appendix.

~~[G104.3 Site plan]~~ **G104.2.1 Flood zone compliance plans.** The permit application shall include ~~[a site plan]~~ flood zone compliance plans. ~~[The site plan]~~ Such plans shall include plans and drawings, shall be sealed by a registered design professional and shall include a site plan and the following information and any other data as may be required by the department:

1. Flood design class assigned according to ASCE 24;
- ~~[1-]~~ 2. A delineation of the flood hazard areas, including identification of the base ~~[and]~~ flood elevation(s), design flood ~~[and]~~ elevations and stillwater flood depth;
- ~~[2-]~~ 3. If applicable, the location of the regulatory floodway;
- ~~[3-]~~ 4. For all proposed structures, spot ground elevations at building corners and in 20-foot (6096 mm) or smaller intervals along the foundation footprint, or 1-foot (305 mm) contour elevations throughout the building site;
- ~~[4-]~~ 5. Proposed locations of water supply, sanitary sewer, and utilities;
- ~~[5-]~~ 6. Drainage patterns and facilities; ~~[and]~~
- ~~[6-]~~ 7. Foundation design details, including but not limited to:
 - ~~[6.1-]~~ 7.1. Proposed elevation of the lowest floor including basement (for flood zone purposes) of all structures;
 - ~~[6.2-]~~ 7.2. For crawl spaces and enclosed parking, storage and building access that are wet floodproofed below the design flood elevation, location and total net area of foundation openings in accordance with ASCE 24;
 - ~~[6.3-]~~ 7.3. For dry floodproofed spaces in buildings or structures that are nonresidential (for flood zone purposes), the proposed elevation to which the enclosure will be dry floodproofed in accordance with ASCE 24; ~~[and]~~
 - ~~[6.4-]~~ 7.4. Any proposed fill and excavation details~~[-]~~ ; and
 - 7.5. In coastal high-hazard areas and coastal A-zones, the proposed elevation of the bottom of the lowest horizontal structural member of the lowest floor; and
8. For structures in coastal high-hazard areas or coastal A-zones, and for dry-floodproofed structures: flood loading and parameters including average velocity of water (V), debris impact load (F_i), scour depths, and wave loads (F_i or F_D).

Exception: Applications for subdivisions shall comply with Section G302.

~~[G104.4 Water course]~~ **G104.2.2 Watercourse alteration.** The permit application shall include documentation required by Section G103.6 and, if applicable, a description of the extent to which any watercourse will be altered or relocated as a result of proposed development~~[-, and any documentation required by Section G103.6].~~

[G104.5] G104.2.3 Certifications. The permit application shall include the applicable certifications in accordance with Sections ~~[G104.5.1]~~ G104.2.3.1 through ~~[G104.5.3]~~ G104.2.3.3.

~~[G104.5.1]~~ G104.2.3.1 A-Zones. For construction in A-Zones, the permit application shall include the following certifications, as applicable:

1. **Wet floodproofing certification.** For applications involving wet floodproofed enclosures below the design flood elevation, ~~[construction documents]~~ flood zone compliance plans shall include a certification by the applicant, as applicable to the scope of work proposed, that "in accordance with ASCE 24, the use of the enclosure is limited to the parking of vehicles, building access, or storage, and that the design [provides for] incorporates openings to allow for the automatic entry and exit of floodwaters for equalization of hydrostatic flood forces [in accordance with Section 2.6.2, ASCE 24] and flood damage-resistant materials and techniques that minimize damage to a structure by floodwater."
2. **Dry floodproofing certification for nonresidential buildings.** For applications involving dry floodproofed buildings and structures that are nonresidential (for flood zone purposes), ~~[construction documents]~~ flood zone compliance plans shall include a certification by the applicant that "the [dry floodproofing is designed] structure is designed to be dry floodproofed with walls that are substantially impermeable to the passage of water and that all walls, floors, and flood shields are designed to resist hydrostatic, hydrodynamic, and other flood-related loads, including the effects of buoyancy resulting from flooding to the elevation listed in Table 6-1 in accordance with ASCE 24."
3. **Utility certifications.** For all applications involving utility or mechanical work, including applications where such work is to be filed in a separate, related application, ~~[construction documents]~~ flood zone compliance plans shall include a certification by the applicant that "all heating, ventilation, air conditioning, plumbing, electrical and other services facilities and equipment within the structure or site will be located or constructed so as to prevent water from entering or accumulating within the components during conditions of flooding in accordance with ASCE 24."

~~[G104.5.2 V-Zones]~~ G104.2.3.2 Coastal high-hazard areas and coastal A-Zones. For construction in ~~[V-Zones]~~ coastal high-hazard areas and coastal A-Zones, the permit application shall include the following certifications, as applicable:

1. **Structural design certification.** ~~[Construction documents]~~ Flood zone compliance plans shall include a certification by the applicant that the "entire structure is designed in accordance with ASCE 24, including that the pile or column foundation and building or structure to be attached thereto is designed to be anchored to resist flotation, collapse and lateral movement due to the effects of wind and flood loads acting simultaneously on all building components, and other load requirements of Chapter 16 of the *New York City Building Code*."

2. **Breakaway wall certification.** Where breakaway walls are provided, ~~[construction documents]~~ flood zone compliance plans shall include a certification by applicant that "the breakaway walls meet the load requirements of Section 5.3.3 of ASCE 7, are designed in accordance with ASCE 24, and are of an open lattice-type construction only."
3. **Utility certifications.** For all applications involving utility or mechanical work, including applications where such work is to be filed in a separate, related application, ~~[construction documents]~~ flood zone compliance plans shall include a certification by the applicant that "all heating, ventilation, air conditioning, plumbing, electrical and other services, facilities and equipment within the structure or site will be located or constructed so as to prevent water from entering or accumulating within the components during conditions of flooding, in accordance with ASCE 24."

[G104.5.3] G104.2.3.3 Floodway encroachment certification. For any floodway encroachment, including fill, new construction, substantial improvements and other development or land-disturbing activity, the applicant shall submit a certification, along with supporting technical data, demonstrating that such development will not cause any increase of the level of the base flood in accordance with the requirements of Section G103.5.

[G104.6] G104.3 Validity of permit. The issuance of a permit under this appendix shall not be construed to be a permit for, or approval of, any violation of this appendix or any other provision of this code. The issuance of a permit based on submitted documents and information shall not prevent the commissioner from requiring the correction of errors. The commissioner is authorized to prevent occupancy or use of a structure or site ~~[which]~~ that is in violation of this appendix or other provisions of this code.

[G104.7 Permit expiration.] G104.4 Expiration. A permit shall become invalid if the proposed development~~[;]~~

[1.—Is] is not commenced within 180 days after its issuance ~~[;]~~ , or

[2.—If] if the work authorized is suspended or abandoned for a period of 180 days after the work commences.

[G104.8 Permit reinstatement. ~~Permit reinstatements for a permit that has expired pursuant to Section G104.7 shall be requested in writing. The commissioner is authorized to grant such reinstatement, provided that the work shall comply with all of the requirements of this appendix, including any revised FEMA FIRMs 360497 in effect at the time the application for reinstatement is made, and provided further that the applicant shall pay all reinstatement fees as required in Article 112 of Title 28 of the *New York City Administrative Code*.]~~

[G104.9 Permit suspension] G104.5 Suspension or revocation. The commissioner is authorized to suspend or revoke a permit issued under this appendix wherever the permit is issued in error or on the basis of incorrect, inaccurate or incomplete information, or in violation of this code, in accordance with Section 28-105 of the *Administrative Code*.

G104.6 Reinstatement. Permit reinstatements for a permit that has expired pursuant to Section G104.4 shall be requested in writing. The commissioner is authorized to grant such reinstatement, provided that the work shall comply with all of the requirements of this appendix, including any revised FEMA FIRMs 360497 in effect at the time the application for reinstatement is made, and provided further that the applicant shall pay all reinstatement fees as required in Article 112 of Title 28 of the *Administrative Code*.

SECTION BC G105 VARIANCES

G105.1 General. The Board of Standards and Appeals shall hear and decide requests for variances from the requirements of this appendix. The Board of Standards and Appeals shall base its determination on technical justifications, and has the right to attach such conditions to variances as it deems necessary to further the purposes and objectives of this appendix.

Exception: In specific cases, provided that noncompliance with the requirements of the 44 CFR section 60.3 is not created, the commissioner shall be authorized to vary the standards prescribed in this appendix under and pursuant to the provisions of Section 28-103.3 of the *Administrative Code* and Section 645(b)(2) of the *New York City Charter*, including but not limited to:

1. Increases to the number of plumbing fixtures on an existing non-dry floodproofed story located below DFE including to accommodate compliance with the *New York City Plumbing Code* or Chapter 11 of this code for accessibility for persons with disabilities, or both; and
2. Modifications to the egress provisions of ASCE 24, Section 6.2.2.

G105.2 Records. The Board of Standards and Appeals shall:

1. Maintain a record of all variance actions, including justification for their issuance; and
2. Report such variances issued in its biennial report submitted to the Federal Emergency Management Agency (FEMA).

G105.3 Historic structures. A variance is authorized to be issued by the Board of Standards and Appeals for the repair or rehabilitation of a historic structure upon a determination that the proposed repair or rehabilitation will not preclude the structure's continued designation as a historic structure, and the variance is the minimum necessary to preserve the historic character and design of the structure.

G105.4 Functionally dependent facilities. The Board of Standards and Appeals is authorized to issue a variance for the construction or substantial improvement of a functionally dependent facility provided the criteria in Sections G105.3, G105.5 and G105.7 are met and the variance is the minimum necessary to allow the construction or substantial improvement, and that all due consideration has been given to methods and materials that minimize flood damages during the base flood and create no additional threats to public safety.

G105.5 Floodway restrictions. The Board of Standards and Appeals shall not issue a variance for any proposed development in a floodway if any increase in flood levels would result during the base flood discharge.

G105.6 Conditions. In reviewing applications for variances, the Board of Standards and Appeals shall consider all technical evaluations, all relevant factors, all other portions of this appendix and the following:

1. The danger that materials and debris may be swept onto other lands resulting in further injury or damage.
2. The danger to life and property due to flooding or erosion damage.
3. The susceptibility of the proposed development, including contents, to flood damage and the effect of such damage on current and future owners.
4. The importance of the services provided by the proposed development to the community.
5. The availability of alternate locations for the proposed development that are not subject to flooding or erosion.
6. The compatibility of the proposed development with existing and anticipated development.
7. The relationship of the proposed development to the comprehensive plan and floodplain management program for that area.
8. The safety of access to the property in times of flood for ordinary and emergency vehicles.
9. The expected heights, velocity, duration, rate of rise and debris and sediment transport of the floodwaters and the effects of wave action, if applicable, expected at the site.
10. The costs of providing governmental services during and after flood conditions including maintenance and repair of public utilities and facilities such as sewer, gas, electrical and water systems, streets and bridges.

G105.7 Conditions for issuance. Except for historic structures as provided for in Section G105.3, the Board of Standards and Appeals is authorized to issue a variance where all of the following criteria are met:

1. A technical showing of good and sufficient cause that the characteristics of the size, configuration or topography of the site renders the standards inappropriate;
2. A determination that failure to grant the variance would result in exceptional hardship to the applicant for the variance;
3. A determination that the granting of a variance will not result in increased flood heights, additional threats to public safety, extraordinary public expense, nor create nuisances,

cause fraud on or victimization of the public or conflict with existing local laws or ordinances;

4. A determination that the variance is the minimum necessary, considering the flood hazard, to afford relief;
5. Notification to the applicant in writing over the signature of the Executive Director of the Board of Standards and Appeals that the issuance of a variance to construct a structure below the base flood level will result in increased premium rates for flood insurance up to amounts as high as \$25 for \$100 of insurance coverage, and that such construction below the base flood level increases risks to life and property; and
6. A determination that the new construction, substantial improvement, or other proposed development is located on a tax lot that, on November 16, 1983, was no more than 1/2 acre (0.2 hectare) in size. However, where the tax lot has been determined to be larger than 1/2 acre (0.2 hectare), the technical justification required for issuing the variance increases with the lot size.

[PROGRESS AND SPECIAL INSPECTION REQUIREMENTS]

~~[G105.1 General. Progress and special inspections shall be performed in accordance with this section. All work applications, regardless of the scope of work, shall be subject to the progress and special inspection requirements of Sections G105.2 through G105.4.]~~

~~[G105.2 All work applications other than new buildings and substantial improvements. All work applications other than new buildings and substantial improvements, shall be subject to the following special inspection:]~~

- ~~[1. **Flood zone compliance special inspection.** Prior to sign-off of work, a special inspector or special inspection agency shall inspect during the course of construction and certify that: “the structure was constructed” or “alterations were performed,” “with methods and practices that minimize flood damage and that are in accordance with approved plans, and with any applicable provisions of Appendix G of the *New York City Building Code* and ASCE 24.”]~~

~~[G105.3 New buildings and substantial improvements. All applications for new buildings or substantial improvements shall be subject to the following inspections:]~~

- ~~[1. **Elevation progress inspection.** Upon placement of the lowest floor, including the basement (for flood zone purposes), an engineer or licensed professional surveyor shall inspect the site and verify the elevation of such lowest floor. The inspection report verifying the elevation shall be submitted to the department prior to further vertical construction. The commissioner shall be permitted to issue a stop work order if such inspection report is not submitted.]~~
- ~~[2. **Flood zone compliance special inspection.** Prior to sign-off of work, a special inspector or special inspection agency shall inspect during the course of construction and certify that: “the structure was constructed” or “alterations were performed,” “with methods and~~

practices that minimize flood damage and that are in accordance with approved plans, and with any applicable provisions of Appendix G of the *New York City Building Code* and ASCE 24.”]

[3. ~~**Final elevation required items.**~~ Prior to the sign-off of the flood zone compliance special inspection, the special inspector or special inspection agency shall verify that the following required items have been submitted to the department, as applicable:]

[3.1. ~~**Elevation certificate.**~~ The elevation certificate shall be made utilizing FEMA Form 086-0-33 titled, “Elevation Certificate,” and shall be signed by an engineer or surveyor.]

[3.2. ~~**Dry floodproofing certificate.**~~ The Dry floodproofing certificate shall be made utilizing FEMA Form 086-0-34 titled, “Floodproofing Certificate,” and shall be signed by an engineer.]

[~~**G105.4 Flood shield inspection.**~~ Where floodshields or other flood control devices are installed as part of a dry floodproofing system in buildings and structures that are nonresidential (for flood zone purposes), the special inspector or special inspection agency responsible for the flood zone compliance special inspection shall inspect the shields or devices in their stored positions or locations, witness their activation or transportation to their installed positions, and witness their deactivation or transportation back to their stored locations. The special inspector or special inspection agency shall also confirm the installation of signage required by ASCE 24, Section 6.2.3, Item 3.]

[~~**G105.5 Reserved.**~~]

[~~**G105.6 Reserved.**~~]

[~~**G105.7 Reserved.**~~]

SECTION BC G106 CERTIFICATES OF OCCUPANCY

G106.1 Applicability. This section shall apply to post-FIRM construction and substantial improvements where the work results in the issuance of a new or amended certificate of occupancy.

G106.2 Enclosed areas subject to flooding in A-Zones. The certificate of occupancy shall describe all ~~wet floodproofed~~ enclosed areas below the design flood elevation that are subject to flooding and that meet the requirements of this appendix for wet floodproofing as "wet floodproofed, subject to flooding". ~~[Such wet floodproofed enclosed areas shall be usable solely for parking, storage, building access or crawl spaces.]~~ The certificate of occupancy shall indicate the use of wet floodproofed spaces as either parking, storage, building access or crawl spaces. The certificate of occupancy shall be issued with the following restriction: "Levels subject to flooding shall not be used for any other use except as stated on this certificate."

G106.3 Enclosed areas subject to flooding in ~~V-Zones~~ coastal high-hazard areas and coastal A-Zones. The certificate of occupancy shall describe all enclosed areas below the design flood elevation that are not dry floodproofed as "subject to flooding". ~~[Such enclosed areas shall be usable solely for parking, storage and building access.]~~ The certificate of occupancy shall indicate the use of spaces enclosed by open lattice breakaway walls below the design flood elevation as either unconditioned parking, unconditioned storage, or unconditioned building access. The certificate of occupancy shall be issued with the following restriction: "Levels subject to flooding shall not be used for any other use except as stated on this certificate."

G106.4 Dry floodproofed spaces. The certificate of occupancy shall describe any dry floodproofed spaces as "dry floodproofed." Where flood shields or other flood control devices are installed, the certificate of occupancy shall also provide notations describing these features. For evacuated buildings or evacuated portions of buildings utilizing the temporary stair or ramp provisions of Section G308.10.1, the certificate of occupancy shall note "In portions of this building planned to be evacuated during flood conditions, occupancy shall be prohibited except for maintenance or emergency personnel."

G106.4.1 Restrictive declaration. ~~[For such]~~ Where dry floodproofed buildings [containing] contain dwelling units, patient care areas (for flood zone purposes) or spaces intended to be used by persons for sleeping purposes, the certificate of occupancy shall also provide notations as required by Section G304.1.2, Item [2.2.5] 2.2. ~~[Where flood shields or other flood control devices are installed, the certificate of occupancy shall also provide notations describing these features.]~~

G106.5 Letters of map change. Where applicable, the certificate of occupancy shall indicate that "the structure is exempted from the ~~[area of]~~ special flood hazard area pursuant to FEMA Letter of Map Amendment (LOMA) # (____)," or that "the structure is exempted from the ~~[area of]~~ special flood hazard area pursuant to FEMA Letter of Map Revision Based on Fill (LOMR-F) # (____)," or that "the structure is exempted from the ~~[area of]~~ special flood hazard area pursuant to FEMA Letter of Map Revision (LOMR) # (____)."

[SECTION BC G107]
[VARIANCES]

~~[G107.1 General. The Board of Standards and Appeals shall hear and decide requests for variances from the requirements of this appendix. The Board of Standards and Appeals shall base its determination on technical justifications, and has the right to attach such conditions to variances as it deems necessary to further the purposes and objectives of this appendix.]~~

~~[G107.2 Conditions for variance.]~~

~~[G107.2.1 Historic structures. The Board of Standards and Appeals is authorized to issue a variance for the repair or rehabilitation of a historic structure provided that:]~~

- ~~[1. The application has received approval from the Landmark Preservation Commission and/or the New York State Historical Preservation Office, as applicable;]~~
- ~~[2. The proposed repair or rehabilitation will not preclude the structure's continued designation as a historic structure; and]~~
- ~~[3. The variance is the minimum necessary to preserve the historic character and design of the structure.]~~

~~[G107.2.2 Floodway restrictions. The Board of Standards and Appeals shall not issue a variance for any proposed development in a floodway if any increase in flood levels would result during the base flood discharge.]~~

~~[G107.2.3 General conditions for variance. Except for historic structures as provided for in Section G107.2.1, the Board of Standards and Appeals is authorized to issue a variance only upon:]~~

- ~~[1. A determination that the new construction, substantial improvement, or other proposed development is located on a tax lot that, on November 16, 1983, was no more than 1/2 acre (0.2 hectare) in size. However, where the tax lot has been determined to be larger than 1/2 acre (0.2 hectare), the technical justification required for issuing the variance increases with the lot size;]~~
- ~~[2. Showing of good and sufficient cause;]~~
- ~~[3. Determination that failure to grant the variance would result in exceptional hardship to the applicant;]~~
- ~~[4. Determination that the granting of a variance will not result in:]~~
 - ~~[a. Increased flood heights;]~~
 - ~~[b. Additional threats to public safety;]~~
 - ~~[c. Extraordinary public expense;]~~

~~[d. Nuisances;]~~

~~[e. Fraud on or victimization of the public; or]~~

~~[f. Conflict with existing local laws or ordinances; and]~~

~~[5. Determination that the variance is the minimum necessary, considering the flood hazard, to afford relief.]~~

~~[G107.2.4 Functionally dependent facilities. The Board of Standards and Appeals is authorized to issue a variance for the construction or substantial improvement of a functionally dependent facility provided that:]~~

~~[1. The criteria for Sections G107.2.1 through G107.2.3 are met; and]~~

~~[2. All methods and materials utilized minimize flood damage during the base flood and create no additional threats to public safety.]~~

~~[G107.3 Standards for variance. In reviewing applications for variances, the Board of Standards and Appeals shall consider all technical evaluations, all relevant factors, all other portions of this appendix and the following:]~~

~~[1. The danger that materials and debris may be swept onto other lands resulting in injury or damage;]~~

~~[2. The danger to life and property due to flooding or erosion damage;]~~

~~[3. The susceptibility of the proposed development, including contents, to flood damage and the effect of such damage on current and future owners;]~~

~~[4. The importance of the services provided by the proposed development to the community;]~~

~~[5. The availability of alternate locations for the proposed development that are not subject to flooding or erosion;]~~

~~[6. The relationship of the proposed development to the comprehensive plan and flood plain management program for that area;]~~

~~[7. The safety of access to the property in times of flood or ordinary and emergency vehicles;]~~

~~[8. The expected heights, velocity, duration, rate of rise and debris and sediment transport of the floodwaters and the effects of wave action, if applicable, expected at the site; and]~~

~~[9. The costs of providing governmental services during and after flood conditions including maintenance and repair of public utilities and facilities such as sewer, gas, electrical and water systems, streets and bridges.]~~

~~[G107.4 Notification of risks. Upon issuance of a variance, the Executive Director of the Boards of Standards and Appeals shall provide written notice to the owner and the applicant that:]~~

~~[1. The issuance of a variance to construct a structure below the base flood level will result in increased premium rates for flood insurance up to amounts as high as twenty five dollars for each one hundred dollars of insurance coverage; and]~~

~~[2. That such construction below the base flood level increases risks to life and property.]~~

~~[G107.5 Records. The Board of Standards and Appeals shall:]~~

~~[1. Maintain a record of all variance actions, including justification for their issuance; and]~~

~~[2. Report such variances issued in its biennial report submitted to the Federal Emergency Management Agency (FEMA).]~~

SECTION BC G107 **PERIODIC, PROGRESS AND SPECIAL INSPECTION REQUIREMENTS**

G107.1 General. Periodic, progress and special inspections shall be performed in accordance with this section. All work applications, regardless of the scope of work, shall be subject to the progress and special inspection requirements of Sections G107.2 through G107.4.

G107.2 All work applications other than new buildings, horizontal enlargements and substantial improvements. All work applications other than new buildings, horizontal enlargements and substantial improvements, shall be subject to the following special inspection:

1. **Flood zone compliance special inspection.** Prior to sign-off of work, a special inspector or special inspection agency shall inspect during the course of construction and certify that: "the structure was constructed" or "alterations were performed," "with methods and practices that minimize flood damage and that are in accordance with approved plans, and with any applicable provisions of Appendix G of the *New York City Building Code* and ASCE 24."

G107.3 New buildings, horizontal enlargements and substantial improvements. All applications for new buildings, horizontal enlargements or substantial improvements shall be subject to the following inspections:

1. **Elevation progress inspection.** Upon placement of the lowest floor, including the basement (for flood zone purposes), an engineer or licensed professional surveyor shall inspect the site and verify the elevation of such lowest floor. The inspection report verifying the elevation shall be submitted to the department prior to further vertical construction. The commissioner shall be permitted to issue a stop work order if such inspection report is not submitted.
2. **Flood zone compliance special inspection.** Prior to sign-off of work, a special inspector or special inspection agency shall inspect during the course of construction and certify that: "the structure was constructed" or "alterations were performed," "with methods and practices that minimize flood damage and that are in accordance with approved plans, and with any applicable provisions of Appendix G of the *New York City Building Code* and ASCE 24."

3. Final elevation required items. Prior to the sign-off of the flood zone compliance special inspection, the special inspector or special inspection agency shall verify that the following required items have been submitted to the department, as applicable:

3.1. Elevation certificate. The elevation certificate shall be made utilizing FEMA Form 086-0-33 titled, “Elevation Certificate,” and shall be signed by a registered design professional or surveyor.

3.2. Dry floodproofing certificate. The dry floodproofing certificate shall be made utilizing FEMA Form 086-0-34 titled, “Floodproofing Certificate,” and shall be signed by a registered design professional.

G107.4 Flood shield inspection. Where flood shields or other flood control devices are installed as part of a dry floodproofing system in buildings and structures that are nonresidential (for flood zone purposes), the special inspector or special inspection agency responsible for the flood zone compliance special inspection shall inspect the shields or devices in their stored positions or locations, witness their activation or transportation to their installed positions, and witness their deactivation or transportation back to their stored locations. The special inspector or special inspection agency shall also confirm the installation of signage required by ASCE 24, Section 6.2.3, Item 3.

G107.5 Periodic inspections of dry floodproofing systems. Covered buildings, as described in Section 28-324 of the *Administrative Code*, shall be subject to periodic inspections for dry floodproofing systems in accordance with Sections G107.5.1 and G107.5.2.

G107.5.1 Annual inspection of dry floodproofing system. An inspection of the dry floodproofing system shall be conducted annually in accordance with Section 28-324.2 of the *Administrative Code*.

G107.5.2 Triennial full scale deployment inspection. A full-scale deployment inspection shall be conducted every three years in accordance with Section 28-324.3 of the *Administrative Code*.

~~[CHAPTER G2]~~
~~[DEFINITIONS]~~
SECTION BC G201
DEFINITIONS

~~G201.1 [General.~~ The following words and terms shall, for the purposes of this appendix, have the meanings shown herein.]

~~[G201.2] Definitions.~~ This section contains terms defined elsewhere in this code, and terms with definitions that are specific to this appendix.

G201.1.1 Terms defined elsewhere in this code. The following terms are defined in Chapter 2:

500-YEAR FLOOD ELEVATION. [The elevation of the flood having a 0.2 percent chance of being equaled or exceeded in any given year, as specified on FEMA FIRM 360497 or FEMA FIS 360497.]

A-ZONE. [An area of special flood hazard without high velocity wave action. When not shown on the FIRMs, the water surface elevation may be determined from available data by the registered design professional of record in accordance with Section G103.3. See also “Area of special flood hazard.”]

[AREA OF SPECIAL FLOOD HAZARD. The land in the flood plain delineated as subject to a 1 percent or greater chance of flooding in any given year. Such areas are designated on the Flood Insurance Rate Map (FIRM) as A Zones, Limit of Moderate Wave Action (Coastal A Zones), or V Zones. Such areas are also known as the base flood plain or 100 year floodplain. Areas designated as X Zones shall not be deemed areas of special flood hazard for the purposes of this Appendix.]

BASE FLOOD. [The flood having a 1 percent chance of being equaled or exceeded in any given year.]

BASE FLOOD ELEVATION. [The elevation of the base flood, including wave height, as specified on FEMA FIRMs 360497 or as determined in accordance with Section G103.3. In areas designated as ZONE AO, the base flood elevation shall be the elevation of the highest existing grade of the building’s perimeter plus the depth number (in feet) specified on the flood hazard map.]

BASEMENT (FOR FLOOD ZONE PURPOSES). [The portion of a building having its floor subgrade (below ground level) on all sides.]

BREAKAWAY WALL. [An open lattice wall that is not part of the structural support of the building to which it is attached and that is intended through its design and construction to collapse under specific later loading forces without causing damage to the elevated portion of the building or the supporting foundation system.]

COASTAL A-ZONE. [An area within a special flood hazard area, shown on FEMA FIRMs 360497 as an area bounded by a “Limit of Moderate Wave Action,” landward of a V Zone or landward of an open coast without mapped V Zones. In a Coastal A Zone, the principal source of flooding must be astronomical tides, storm surges, seiches, or tsunamis, and not riverine flooding. During the base flood conditions, the potential for breaking wave heights must be greater than or equal to 1 foot, 6 inches (457 mm). In no case shall an area of special flood hazard be deemed a coastal A Zone unless and until it has been identified as such on the adopted FEMA FIRMs 360497.]

COASTAL HIGH-HAZARD AREA.

DESIGN FLOOD ELEVATION. [The applicable elevation specified in ASCE 24, Tables 2-1, 4-1, 5-1, 6-1, or 7-1, depending on the structural occupancy category designated in ASCE 24, Table 1-1.]

~~[DEVELOPMENT. Any man-made change to improved or unimproved real estate, including but not limited to, buildings or other structures, temporary structures, temporary or permanent storage of materials, mining, dredging, filling, grading, paving, excavations, operations and other land disturbing activities.]~~

~~[EXISTING CONSTRUCTION. See “Pre-FIRM development.”]~~

~~[EXISTING STRUCTURE. See “Pre-FIRM development.”]~~

~~FLOOD or FLOODING. [A general and temporary condition of partial or complete inundation of normally dry land from:]~~

~~[1. The overflow of inland or tidal waters.]~~

~~[2. The unusual and rapid accumulation or runoff of surface waters from any source.]~~

~~FLOOD-DAMAGE-RESISTANT MATERIALS. [Any construction material, including finishes, capable of withstanding direct and prolonged contact with floodwaters without sustaining any damage that requires more than cosmetic repair.]~~

FLOOD HAZARD AREA.

~~FLOOD INSURANCE RATE MAP (FIRM). [The flood official map on which the Federal Emergency Management Agency (FEMA) has delineated areas of special flood hazard, base flood elevations, and the flood boundary and floodways.]~~

~~FLOOD INSURANCE STUDY (FIS). [The official report provided by the Federal Emergency Management Agency (FEMA) containing the Flood Insurance Rate Map (FIRM), the water surface elevation of the base flood and supporting technical data.]~~

~~FLOODPROOFING, DRY. [For buildings and structures that are nonresidential (for flood zone purposes), a combination of design modifications that results in the building's or structure's being water tight to the design flood elevation, including the attendant utility and sanitary facilities, with walls substantially impermeable to the passage of water and with structural components having the capacity to resist loads as identified in ASCE 7.]~~

~~FLOODPROOFING, WET. [A floodproofing method designed to permit parts of the structure below the design flood elevation that are used for parking, storage, building access, or crawl space to intentionally flood, by equalizing hydrostatic pressures and by relying on the use of flood damage resistant materials and construction techniques.]~~

~~FLOODWAY. [The channel of the river, creek or other watercourse and the adjacent land areas that must be reserved in order to discharge the base flood without cumulatively increasing the water surface elevation more than a designated height. Floodways are mapped only in the Boroughs of the Bronx and Staten Island.]~~

~~[FUNCTIONALLY DEPENDENT FACILITY. A facility that cannot be used for its intended purpose unless it is located or carried out in close proximity to water, such as a~~

docking or port facility necessary for the loading or unloading of cargo or passengers, shipbuilding or ship repair. The term does not include long term storage, manufacture, sales or service facilities.]

[~~HISTORIC STRUCTURE.~~ A pre-FIRM building or structure:]

- ~~[1. Designated as a landmark or located within an historic district designated by the *New York City Landmarks Preservation Commission*;~~]
- ~~[2. Listed or preliminarily determined to be eligible for listing in the National or State Register of Historic Places; or]~~
- ~~[3. Determined by the Secretary of the U.S. Department of the Interior or the New York State Department of Parks and Recreation as contributing to the historical significance of a registered historic district or a district preliminarily determined to qualify as an historic district.]~~

[~~LETTER OF MAP AMENDMENT (LOMA).~~ An official amendment to the FIRM, issued and approved by the Federal Emergency Management Agency (FEMA), removing structures or tax lots or portions of tax lots from areas of special flood hazard, resulting from a demonstration that the pre-FIRM ground elevations are at or above the base flood elevation.]

[~~LETTER OF MAP REVISION BASED ON FILL (LOMR-F).~~ An official amendment to the FIRM, issued and approved by the Federal Emergency Management Agency (FEMA), removing structures or tax lots or portions of tax lots from areas of special flood hazard, resulting from the post-FIRM placement of compacted fill, such that the new ground elevation is at or above the base flood elevation.]

[~~LETTER OF MAP REVISION (LOMR).~~ An official amendment to the FIRM, issued and approved by the Federal Emergency Management Agency (FEMA), removing or adding structures or tax lots or portions of tax lots from areas of special flood hazard, which generally results from physical measures implemented that affect the hydrologic or hydraulic characteristics of a flooding source and thus result in the modification of the existing regulatory floodway, the effective base flood elevations, or the special flood hazard area.]

LOWEST FLOOR. [The lowest floor of the lowest enclosed area, including crawl spaces and basements (for flood zone purposes). The lowest floor shall not include any wet floodproofed spaces usable solely for vehicle parking, building access, storage or crawl space, provided that such enclosure is not built so as to render the structure in violation of this appendix, including that:]

- ~~[1. Such enclosure shall allow for the automatic entry and exit of floodwaters;]~~
- ~~[2. Such enclosure shall be constructed solely of flood-resistant materials and finishes;]~~
- ~~[3. Such enclosure shall have a floor elevation equal to or higher than the outside adjacent grade on at least one side; and]~~

~~[4. Such outside adjacent grade shall slope down, towards the source of flooding, providing positive drainage by gravity, thus preventing accumulations of water under or in the structure after the floodwaters recede without the use of pumps, pipes or drains.]~~

~~[**MANUFACTURED HOME.** A structure that is transportable in one or more sections, built on a permanent chassis, designed for use with or without a permanent foundation when attached to the required utilities, and constructed to the Federal Mobile Home Construction and Safety Standards and rules and regulations promulgated by the U.S. Department of Housing and Urban Development. The term also includes mobile homes, park trailers, travel trailers and similar transportable structures that are placed on a site for 180 consecutive days or longer.]~~

~~[**MANUFACTURED HOME PARK OR SUBDIVISION.** A parcel (or contiguous parcels) of land divided into two or more manufactured home lots for rent or sale.]~~

~~[**MARKET VALUE OF STRUCTURE.** The price that a buyer is willing, but is not under any duty, to pay for a particular structure to an owner who is willing, but not obligated, to sell, exclusive of the value of the land, or of other buildings or structures on the same tax lot. The market value of a structure shall be determined in accordance with rules promulgated by the commissioner.]~~

~~[**NATIONAL GEODETIC VERTICAL DATUM (NGVD).** [The national vertical datum standard established in 1929; used as a reference for establishing elevations within a flood plain.]~~

~~[**NEW CONSTRUCTION.** See “Post-FIRM development.”]~~

~~[**NONRESIDENTIAL (FOR FLOOD ZONE PURPOSES).** [A building or structure that either:]~~

~~[1. Contains no space classified in Group I-1, R-1, R-2, or R-3, and contains no space that is accessory, as such term is defined in the *New York City Zoning Resolution*, to any Group I-1, R-1, R-2, or R-3 occupancy; or]~~

~~[2. Contains such space(s), but also contains space on the lowest floor that is not accessory, as such term is defined in the *New York City Zoning Resolution*, to a Group I-1, R-1, R-2, or R-3 occupancy.]~~

~~[**NORTH AMERICAN VERTICAL DATUM (NAVD).** [The national vertical datum standard established in 1988, used as a reference for establishing elevations within a flood plain.]~~

~~[**PATIENT CARE AREA (FOR FLOOD ZONE PURPOSES).** [Any space meeting the following conditions:]~~

~~[1. The space is located within a building or structure, or portion thereof, that is classified in Group I-2; and]~~

~~[2. The space is primarily used for the provision of medical services to persons, including, but not limited to, consultation, evaluation, monitoring and treatment services.]~~

~~[**Exceptions:** The following spaces shall not be considered patient care areas (for flood zone purposes):]~~

~~[1. "Emergency rooms or departments" as defined in 10 NYCRR 700.2(a)(2) and]~~

~~[2. Spaces primarily used for the provision of medical services identified in 10 NYCRR 703.6(e)(2)(i).]~~

~~[**PRE-FIRM DEVELOPMENT.** Any development:]~~

~~1. Completed prior to November 16, 1983;]~~

~~2. Under construction on November 16, 1983 provided that the start of construction was prior to said date; or]~~

~~3. Completed on or after November 16, 1983 but that:]~~

~~3.1. Was not located within an area of special flood hazard at the start of construction; and]~~

~~3.2. Is now located within an area of special flood hazard as a result of a subsequent change to the FIRM.]~~

~~[**PRE-FIRM STRUCTURE.** See "Pre-FIRM development."]~~

~~[**POST-FIRM DEVELOPMENT.** Any development that is not pre-FIRM development.]~~

~~[**POST-FIRM STRUCTURE.** See "Post-FIRM development."]~~

~~[**RECREATIONAL VEHICLE.** A vehicle that is built on a single chassis, 400 square feet (37.16 m²) or less when measured at the largest horizontal projection, designed to be self-propelled or permanently towable by a light-duty truck, and designed primarily not for use as a permanent dwelling but as temporary living quarters for recreational, camping, travel or seasonal use. A recreational vehicle is ready for highway use if it is on its wheels or jacking system, is attached to the site only by quick disconnect-type utilities and security devices and has no permanently attached additions.]~~

~~**RESIDENTIAL (FOR FLOOD ZONE PURPOSES).** [A building or structure containing any space that is either:]~~

~~[1. Classified in Group I-1, R-1, R-2, or R-3; or]~~

~~[2. Accessory, as such term is defined in the *New York City Zoning Resolution*, to any Group I-1, R-1, R-2, or R-3 occupancy.]~~

[Exception: Such a building or structure shall be considered nonresidential (for flood zone purposes) when also containing space on the lowest floor that is not accessory, as such term is defined in the *New York City Zoning Resolution*, to a Group I-1, R-1, R-2, or R-3 occupaney.]

SAND DUNES. [Naturally occurring accumulations of sand in ridges or mounds landward of a beach.]

SHADED X-ZONE. [The land in the floodplain delineated as subject to a 0.2 percent or greater chance of flooding, but less than one percent chance of flooding, in any given year. Such areas are designated on the Flood Insurance Rate Map (FIRM) as shaded X-Zones.]

SPECIAL FLOOD HAZARD AREA. [See “Area of special flood hazard.”]

~~**[START OF CONSTRUCTION.** The date of permit issuance for: (i) post-FIRM developments; (ii) substantial improvements to pre-FIRM structures; and (iii) those pre-FIRM developments that, at the time of permit issuance, were not within an area of special flood hazard but that, prior to completion, were within an area of special flood hazard as a result of map change; provided the actual commencement of construction, repair, reconstruction, rehabilitation, addition, placement or other improvement is within 180 days after the date of permit issuance and such construction activity is not thereafter suspended or abandoned for 180 days or more. For the purposes of this definition:]~~

~~[1. The actual commencement of construction means the first placement of permanent construction of a building (including a manufactured home or prefabricated building) on a site, such as the pouring of a slab or footings, installation of pilings or construction of columns.]~~

~~[2. Permanent construction does not include land preparation (such as clearing, excavation, grading or filling), the installation of streets or walkways, excavation for abasement (for flood zone purposes), footings, piers or foundations, the erection of temporary forms or the installation of accessory buildings such as garages or sheds not occupied as dwelling units or not part of the main building.]~~

~~[3. For a substantial improvement, the actual commencement of construction means the first alteration of any wall, ceiling, floor or other structural part of a building, regardless of whether that alteration affects the external dimensions of the building.]~~

SUBSTANTIAL DAMAGE. [Damage of any origin sustained by a structure whereby the cost of restoring the structure to its before-damaged condition would equal or exceed 50 percent of the market value of the structure before the damage occurred.]

SUBSTANTIAL IMPROVEMENT. [Any repair, reconstruction, rehabilitation, addition or improvement of a building or structure, the cost of which equals or exceeds 50 percent of the market value of the structure before the improvement or repair is started. If the structure has sustained substantial damage, any repairs are considered substantial improvement regardless of the actual repair work performed. The term does not, however, include either:]

~~[1. Any project for improvement of a building required to correct pre-FIRM health, sanitary or safety code violations identified by the commissioner, the Fire Commissioner, the Commissioner of Housing Preservation and Development, or the Commissioner of Health and Mental Hygiene, and that are the minimum necessary to assure safe living conditions; or]~~

~~[2. Any alteration of a historic structure provided that the alteration will not preclude the structure's continued designation as a historic structure.]~~

~~[VARIANCE. A grant of relief from the requirements of this appendix, which permits construction in a manner otherwise prohibited by this appendix.]~~

~~V-ZONE. [An area of special flood hazard subject to high-velocity wave action.]~~

G201.1.2 Definitions specific to this appendix. The following words and terms shall, for the purposes of this appendix, have the meanings shown herein:

DEVELOPMENT. Any man-made change to improved or unimproved real estate, including but not limited to, buildings or other structures, temporary structures, temporary or permanent storage of materials, mining, dredging, filling, grading, paving, excavations or drilling operations and other land-disturbing activities.

EXISTING CONSTRUCTION. See “Pre-FIRM development.”

EXISTING STRUCTURE. See “Pre-FIRM development.”

FLOOD DESIGN CLASS. A classification of buildings and other structures for determination of flood loads and conditions, and determination of minimum elevation requirements on the basis of risk associated with unacceptable performance.

FUNCTIONALLY DEPENDENT FACILITY. A facility that cannot be used for its intended purpose unless it is located or carried out in close proximity to water. The term includes only docking facilities, port facilities that are necessary for loading and unloading of cargo or passengers and shipbuilding and ship repair facilities, but does not include long-term storage or related manufacturing, sales or service facilities.

HISTORIC STRUCTURE. Any structure that meets one of the following criteria:

1. Listed individually in the National Register of Historic Places;
2. Certified by the Secretary of the U.S. Department of the Interior as meeting the requirements for individual listing in the National Register;
3. Certified or preliminarily determined by the Secretary of the U.S. Department of the Interior to be contributing to the historical significance of a registered historic district or a district preliminarily determined by the Secretary of the U.S. Department of the Interior to qualify as a registered historic district;

4. Individually listed or preliminarily determined to be eligible for listing in the New York State Register of Historic Places; or
5. Individually listed as a landmark by the NYC Landmarks Preservation Commission. Location within a historic district does not alone qualify as being an individually listed landmark.

LETTER OF MAP AMENDMENT (LOMA). An official amendment to the FIRM, issued and approved by the Federal Emergency Management Agency (FEMA), removing structures or tax lots or portions of tax lots from special flood hazard areas, resulting from a demonstration that the pre-FIRM ground elevations are at or above the base flood elevation.

LETTER OF MAP REVISION BASED ON FILL (LOMR-F). An official amendment to the FIRM, issued and approved by the Federal Emergency Management Agency (FEMA), removing structures or tax lots or portions of tax lots from special flood hazard areas, resulting from the post-FIRM placement of compacted fill, such that the new ground elevation is at or above the base flood elevation.

LETTER OF MAP REVISION (LOMR). An official amendment to the FIRM, issued and approved by the Federal Emergency Management Agency (FEMA), removing or adding structures or tax lots or portions of tax lots from special flood hazard areas, which generally results from physical measures implemented that affect the hydrologic or hydraulic characteristics of a flooding source and thus result in the modification of the existing regulatory floodway, the effective base flood elevations, or the special flood hazard area.

MANUFACTURED HOME. A structure that is transportable in one or more sections, built on a permanent chassis, designed for use with or without a permanent foundation when attached to the required utilities, and constructed to the Federal Mobile Home Construction and Safety Standards and rules and regulations promulgated by the U.S. Department of Housing and Urban Development. The term also includes mobile homes, park trailers, travel trailers and similar transportable structures that are placed on a site for 180 consecutive days or longer.

MANUFACTURED HOME PARK OR SUBDIVISION. A parcel (or contiguous parcels) of land divided into two or more manufactured home lots for rent or sale.

MARKET VALUE OF STRUCTURE. The price that a buyer is willing, but is not under any duty, to pay for a particular structure to an owner who is willing, but not obligated, to sell, exclusive of the value of the land, or of other buildings or structures on the same tax lot. The market value of a structure shall be determined in accordance with rules promulgated by the commissioner.

NEW CONSTRUCTION. See “Post-FIRM development.”

POST-FIRM DEVELOPMENT. Any development that is not pre-FIRM development.

POST-FIRM STRUCTURE. See "Post-FIRM development."

PRE-FIRM DEVELOPMENT. Any development:

1. Completed prior to November 16, 1983;
2. Under construction on November 16, 1983, provided that the start of construction was prior to said date; or
3. Completed on or after November 16, 1983, but that:
 - 3.1. Was not located within a special flood hazard area at the start of construction; and
 - 3.2. Is now located within a special flood hazard area as a result of a subsequent change to the FIRM.

PRE-FIRM STRUCTURE. See "Pre-FIRM development."

RECREATIONAL VEHICLE. A vehicle that is built on a single chassis, 400 square feet (37.16 m²) or less when measured at the largest horizontal projection, designed to be self-propelled or permanently towable by a light-duty truck, and designed primarily not for use as a permanent dwelling but as temporary living quarters for recreational, camping, travel or seasonal use. A recreational vehicle is ready for highway use if it is on its wheels or jacking system, is attached to the site only by quick disconnect-type utilities and security devices and has no permanently attached additions.

START OF CONSTRUCTION. The date of permit issuance for: (i) post-FIRM developments; (ii) substantial improvements to pre-FIRM structures; and (iii) those pre-FIRM developments that, at the time of permit issuance, were not within a special flood hazard area but that, prior to completion, were within a special flood hazard area as a result of map change; provided the actual commencement of construction, repair, reconstruction, rehabilitation, addition, placement or other improvement is within 180 days after the date of permit issuance and such construction activity is not thereafter suspended or abandoned for 180 days or more. For the purposes of this definition:

1. The actual commencement of construction means the first placement of permanent construction of a building (including a manufactured home or prefabricated building) on a site, such as the pouring of a slab or footings, installation of pilings or construction of columns.
2. Permanent construction does not include land preparation (such as clearing, excavation, grading or filling), the installation of streets or walkways, excavation for a basement (for flood zone purposes), footings, piers or foundations, the erection of temporary forms or the installation of accessory buildings such as garages or sheds not occupied as dwelling units or not part of the main building.
3. For a substantial improvement, the actual commencement of construction means the first alteration of any wall, ceiling, floor or other structural part of a building, regardless of whether that alteration affects the external dimensions of the building.

VARIANCE. A grant of relief from the requirements of this appendix, which permits construction in a manner otherwise prohibited by this appendix.

~~[CHAPTER G3]
[CONSTRUCTION STANDARDS]~~

SECTION BC G301
[GENERAL] CONSTRUCTION STANDARDS

G301.1 All developments. To the extent required by Section G102.1, all developments, including but not limited to utility installation, site improvements, placement of prefabricated buildings and manufactured homes, new building construction, alterations and repairs, shall be designed and constructed to resist the effects of flood hazards and flood loads in accordance with this appendix and ASCE 24.

G301.1.1 Multiple flood zones. For a structure that is located in more than one zone (for instance both an A-Zone and an X-Zone, or both an A-Zone and a V-Zone), the provisions associated with the most restrictive ~~[area of special flood hazard]~~ zone shall apply to the entire structure.

G301.2 Design requirements and load combinations. Any construction ~~[within the scope of]~~ subject to the requirements of Section G102.1~~[-located in a special flood hazard area.]~~ shall be designed and constructed to resist the loads and load combinations specified in Chapter 16.

SECTION BC G302
SUBDIVISIONS

G302.1 General. Any subdivision proposal, including proposals for manufactured home parks and subdivisions, or other proposed new development within ~~[an area of]~~ a special flood hazard area shall ~~[demonstrate that]~~ be reviewed to verify all of the following:

1. All such proposals are consistent with the need to minimize flood damage~~[;]~~ .
2. All public utilities and facilities, such as sewer, gas, electric and water systems, are located and constructed to minimize or eliminate flood damage~~[; and]~~ .
3. Adequate drainage is provided to reduce exposure to flood hazards.

G302.2 Subdivision requirements. The following requirements shall apply ~~[to]~~ in the case of any proposed subdivision, including proposals for manufactured home parks and subdivisions, any portion of which lies within ~~[an area of]~~ a special flood hazard area:

1. The ~~[area of]~~ special flood hazard area, including floodways ~~[and V-Zones]~~, coastal high-hazard areas and coastal A-Zones, as appropriate, shall be delineated on tentative and final subdivision plats~~[;]~~ .
2. Base flood elevations shall be shown on tentative and final subdivision plats~~[;]~~ .

3. Building lots shall be provided with adequate buildable area, in accordance with the *New York City Zoning Resolution*, outside the floodway~~[-and]~~ .
4. The design criteria for ~~[any]~~ utilities and facilities~~[-as]~~ set forth in this appendix and appropriate *New York City Construction Codes*~~[-]~~ shall be met.

SECTION BC G303 SITE IMPROVEMENT

G303.1 Development in floodways. Development or land-disturbing activity ~~[is prohibited in floodways]~~ shall not be authorized in the floodway unless it has been demonstrated through hydrologic and hydraulic analyses performed in accordance with standard engineering practice, and prepared by a registered design professional, that the proposed encroachment will not result in any increase in the ~~[level of the]~~ base flood level, in accordance with Section G103.5.

G303.2 Coastal high-hazard areas and coastal A-Zones. In coastal high-hazard areas and coastal A-Zones:

1. New buildings, not including substantial improvements, shall only be authorized landward of the reach of mean high tide.
2. The use of fill for structural support of buildings is prohibited.

G303.3 Sewer facilities. All new ~~[and]~~ or replaced sanitary sewer facilities, private sewage treatment plants (including all pumping stations and collector systems) and on-site waste disposal systems shall be designed in accordance with Chapter 7, ASCE 24, to minimize or eliminate infiltration of floodwaters into the facilities and discharge from the facilities into floodwaters, or impairment of the facilities and systems.

~~[G303.3]~~ **G303.4 Water facilities.** All new ~~[and]~~ or replacement water facilities shall be designed in accordance with the provisions of Chapter 7, ASCE 24, to minimize or eliminate infiltration of floodwaters into the systems.

~~[G303.4]~~ **G303.5 Storm drainage.** Storm drainage shall be designed to convey the flow of surface waters to minimize or eliminate damage to persons or property and shall meet the requirements of ASCE 24.

~~[G303.5]~~ **G303.6 Streets and sidewalks.** Streets and sidewalks shall be designed to minimize potential for increasing or aggravating flood levels and shall meet the requirements of Section ~~[G303.7]~~ G303.8.

~~[G303.6]~~ **G303.7 Retaining walls and driveways.** Retaining walls shall be designed in accordance with Section 1807. Retaining walls and driveways shall meet the requirements of Section ~~[G303.7]~~ G303.8.

~~[G303.7]~~ **G303.8 Grading and fill.** In ~~[areas of special]~~ flood hazard areas, grading and/or fill shall not be approved:

1. Unless such fill is placed, compacted and sloped to minimize shifting, slumping and erosion during the rise and fall of flood water and, as applicable, wave action, in accordance with ASCE 24 and Section 1804 of this code.
2. In floodways, unless it has been demonstrated through hydrologic and hydraulic analyses performed by an engineer in accordance with standard engineering practice that the proposed grading or fill, or both will not result in any increase in the flood levels during the occurrence of the design flood, in accordance with Section G103.5.
3. In coastal A-Zones and [~~V-Zones~~] coastal high-hazard areas, unless such fill is conducted and or placed to avoid diversion of water and waves towards any building or structure.

SECTION BC G304
POST-FIRM CONSTRUCTION, HORIZONTAL ENLARGEMENTS AND
SUBSTANTIAL IMPROVEMENTS

G304.1 A-Zone construction standards. In addition to the requirements of ASCE 24, the following standards shall apply to post-FIRM construction, horizontal enlargements and substantial improvements located within A-Zones, other than Coastal A-Zones.

G304.1.1 Residential. For buildings or structures that are residential (for flood zone purposes), all post-FIRM new buildings, horizontal enlargements and substantial improvements shall comply with the applicable requirements [~~in Chapter G3~~] of this [~~code~~] appendix and ASCE 24, and shall be elevated as follows:

1. **Lowest floor.** The lowest floor, including the basement (for flood zone purposes), shall be elevated to [~~at~~] or above the design flood elevation specified in ASCE 24, Table 2-1;
2. **Enclosures below the design flood elevation.** Enclosed spaces below the design flood elevation specified in ASCE 24, Table 2-1, shall be useable solely for parking of vehicles, building access, storage, or crawlspace, and shall be wet floodproofed in accordance with ASCE 24. Breakaway walls are not required in A-Zones;
 - 2.1. A restrictive declaration noting the above restriction shall be filed with the City Register or County Clerk, and the City Register File Number (CRFN) shall be identified in the permit application and on the certificate of occupancy.
3. **Under-floor spaces.** The finished ground level of an under-floor space, such as a crawl space, shall be equal to or higher than the outside finished ground level on at least one side[-];
4. **Materials.** Only flood-damage-resistant materials and finishes shall be utilized below the design flood elevation specified in ASCE 24, Table 5-1;
5. **Utilities and equipment.** Utilities and attendant equipment shall be located at or above the design flood elevation specified in ASCE 24, Table 7-1, or with the exception of the items below, shall be constructed so as to prevent water from entering

or accumulating within the components during conditions of flooding in accordance with ASCE 24[;].

- 5.1. Fire protection systems and equipment. The following fire protection systems and equipment shall be located at or above the design flood elevation specified in ASCE 24, Table 7-1, except that where the system or equipment or portion thereof serves only spaces located below such design flood elevation, the system or equipment or portion thereof may be located below such design flood elevation:
 - 5.1.1. Sprinkler control valves that are not outside stem and yoke valves;
 - 5.1.2. Fire standpipe control valves that are not outside stem and yoke valves;
 - 5.1.3. Sprinkler booster pumps and fire pumps;
 - 5.1.4. Dry pipe valve-related electrically operated alarm appurtenances;
 - 5.1.5. Alarm control panels for water and non-water fire extinguishing systems;
 - 5.1.6. Alarm control panels for sprinkler systems, pre-action sprinkler systems, deluge sprinkler systems, and combined dry pipe and pre-action sprinkler systems;
 - 5.1.7. Electrically operated waterflow detection devices serving sprinkler systems; and
 - 5.1.8. Air compressors serving sprinkler systems and pre-action sprinkler systems.
- 5.2. Fire alarm systems and components. Where a zoning indicator panel is provided at the main building entrance in accordance with Section 907.6.3.1 of this code and such panel is located at or below 5 feet (1524 mm) above the design flood elevation specified in ASCE 24, Table 7-1, at least one secondary zoning indicator panel complying with the following requirements shall be provided:
 - 5.2.1. The secondary zoning indicator panel, associated controls, power supplies and means of transferring control shall be provided at least 5 feet (1524 mm) above the design flood elevation specified in ASCE 24, Table 7-1, in a location accessible to responding Fire Department personnel and approved by the department and the Fire Department; and
 - 5.2.2. Where the secondary zoning indicator panel or associated controls are only operable upon transfer of control from another zoning indicator panel, such transfer shall be by a means that is approved by the Fire Department.

- 5.3. Fuel-oil piping systems. The following requirements shall apply to fuel-oil piping systems, as defined by Section 202 of the *New York City Mechanical Code*:
 - 5.3.1. Fill piping that does not terminate in a watertight terminal approved by the department shall terminate at least 3 feet (914 mm) above the design flood elevation specified in ASCE 24, Table 7-1; and
 - 5.3.2. Normal vent piping and emergency vent piping shall terminate at least 3 feet (914 mm) above the design flood elevation specified in ASCE 24, Table 7-1.
- 5.4. Plumbing systems and components. The structure shall comply with the following requirements:
 - 5.4.1. Relief vents and fresh air intakes. Relief vents and fresh air intakes serving building traps in accordance with Section 1002.6 of the *New York City Plumbing Code* shall be carried above grade and shall terminate in a screened outlet that is located outside of the building and at or above the design flood elevation specified in ASCE 24, Table 7-1; and
 - 5.4.2. Reduced pressure zone backflow preventers.
 - 5.4.2.1. Primary reduced pressure principle backflow preventers complying with the requirements of the Department of Environmental Protection shall be located at or above the design flood elevation specified in ASCE 24, Table 7.1.
 - 5.4.2.2. [~~Reduced~~] Secondary reduced pressure principle backflow preventers complying with Section 608.13.2 of the *New York City Plumbing Code* and backflow preventers with intermediate atmospheric vents complying with Section 608.13.3 of the *New York City Plumbing Code* shall be located at or above the design flood elevation specified in ASCE 24, Table 7.1.
 - 5.4.3. Relief vents for gas service, equipment, and appliance pressure regulators. Relief vents for gas service, equipment, and appliance pressure regulators complying with the *New York City Fuel Gas Code* shall be located at or above the design flood elevation specified in ASCE 24, Table 7.1.
6. **Certifications.** Applications shall contain applicable certifications in accordance with Section G104.5; and
7. **Special inspections.** Special inspections shall be as required by Section [~~G105~~] G107.

G304.1.2 Nonresidential. For buildings or structures that are nonresidential (for flood zone purposes), all post-FIRM new buildings, horizontal enlargements and substantial

improvements shall comply with the applicable requirements [~~in Chapter G3~~] of this [~~code~~] appendix and ASCE 24, and shall comply with either of the following:

1. **Elevation option.** The structure shall comply with Items 1 through [~~6~~] 7 of Section G304.1.1; or

2. **Dry floodproofing option.** The structure shall comply with the following:

2.1. Elevation of dry floodproofing. The structure shall be dry floodproofed to [~~at~~] or above the design flood elevation specified in ASCE 24, Table 6-1;

2.2. Dwelling units, patient care areas (for flood zone purposes) and sleeping [~~spaces~~] areas. Where dwelling units, patient care areas (for flood zone purposes) or spaces intended to be used by persons for sleeping purposes are located in a building utilizing the dry floodproofing option, the following additional requirements shall be met:

2.2.1. All rooms and spaces within dwelling units, patient care areas (for flood zone purposes) and all spaces intended to be used by persons for sleeping purposes shall be located at or above the design flood elevation;

2.2.2. A restrictive declaration noting the above restriction shall be filed with the City Register or County Clerk, and the [~~page number and liber number~~] City Register File Number (CRFN) shall be identified in the permit application and on the certificate of occupancy.

2.3. Utilities and equipment. Utilities and attendant equipment shall be located within the dry floodproofed enclosure, or may be located outside the dry floodproofed enclosure provided that they are located at or above the design flood elevation specified in ASCE 24, Table 7-1, or are constructed so as to prevent water from entering or accumulating within the components during conditions of flooding in accordance with ASCE 24.

2.3.1. Additional requirements. [~~The structure shall comply with~~] Notwithstanding the above, utilities and attendant equipment, listed in Items 5.1 through 5.4 of Section G304.1.1, shall not be located in dry floodproofed enclosures and shall be elevated in accordance with Section G304.1.1.

2.4. Fire department connections. Dry floodproofing measures including temporary shields, stairs and ramps shall be located and arranged so as to allow hose lines to be attached to the inlets of fire department connections without interference in accordance with Section 6.4.5 of NFPA 14, as modified by Appendix Q of this code.

2.5. Certifications. Applications shall contain applicable certifications in accordance with Section [~~G104.5~~] G104.2.3; and

[2.5.] 2.6. Special inspections. Special inspections shall be as required by Section [G105] G107

G304.2 [V-Zone] Coastal high-hazard area construction standards. In addition to the requirements of ASCE 24, the following standards shall apply to post-FIRM construction, horizontal enlargements and substantial improvements located within [V-Zones] coastal high-hazard area.

1. **Foundation.** The lowest floor shall be elevated on adequately anchored pilings or columns and securely anchored to such piles or columns to prevent [~~floatation~~] flotation, collapse and lateral movement resulting from wind and flood loads acting simultaneously on all building components, and other load requirements of Chapter 16 and this appendix.
2. **Lowest horizontal member.** The lowest portion of the lowest horizontal structural member of the lowest floor (excluding the pilings or columns) shall be at or above the design flood elevation specified in ASCE 24, Table 4-1.
3. **Below the lowest horizontal member.** Spaces below the lowest horizontal member shall be either:
 - 3.1. Free of obstructions; or
 - 3.2. Enclosed with breakaway walls providing unconditioned space useable solely for parking of vehicles, building access, storage or crawl space. Such breakaway walls shall:
 - 3.2.1. Be of an open lattice type construction only;
 - 3.2.2. Meet the load requirements of Section 5.3.3 of ASCE 7; and
 - 3.2.3. Meet the additional requirements of ASCE 24.
4. **Materials.** Only flood-damage-resistant materials and finishes shall be utilized below the design flood elevation specified in ASCE 24, Table 5-1;
5. **Utilities and equipment.** Utilities and attendant equipment shall be located at or above the design flood elevation specified in ASCE 24, Table 7-1, or shall be constructed so as to both resist the wave action and prevent water from entering or accumulating within the components during conditions of flooding in accordance with ASCE 24;

[5.4] 5.1. Additional requirements. The structure shall comply with Items 5.1 through 5.4 of Section G304.1.1.
6. **Prohibitions.** The following shall be prohibited in [V-Zones] coastal high-hazard areas:
 - 6.1. Development, including land-disturbing activities, seaward of the reach of mean high tide;

- 6.2. Use of fill for structural support of buildings; and
- 6.3. Man-made alterations of sand dunes that would increase potential damage to buildings.
7. **Certifications.** Applications shall contain applicable certifications in accordance with Section [~~G104.5~~] G104.2.3; and
8. **Special inspections.** Special inspections shall be as required by Section [~~G105~~] G107.

G304.3 Coastal A-Zone construction standards. In addition to the requirements of ASCE 24, all post-FIRM new buildings, horizontal enlargements and substantial improvements in a Coastal A-Zone shall comply with the [~~V-Zone~~] coastal high-hazard area construction standards of Section G304.2.

Exceptions: The following structural systems shall be permitted in a Coastal A-Zone:

- 1. Wave-resisting stem wall foundation.** Stem walls supporting a floor system above, and backfilled with soil or gravel to the underside of the floor system, shall be permitted in Coastal A-Zones. The design and construction of the shallow foundation system shall comply with the following:
 - 1.1. The underside of such floor system shall be located at or above the design flood elevation specified in ASCE 24, Table 4-1.
 - 1.2. Stem walls enclosing areas below the design flood elevation shall not be permitted. Stem walls shall be designed to transfer all vertical and lateral forces to the slab above and to the foundation elements below;
 - 1.3. The design shall consider all forces resulting from flooding, including wave action, debris impact, erosion, and local scour;
 - 1.4. The design shall consider all forces resulting from soil pressure behind the walls, including the effect of hydrostatic loads, and all live and dead surcharge loads from the slab above;
 - 1.5. Flood openings shall not be required in stem walls constructed in accordance with this section;
 - 1.6. Where soils are susceptible to erosion and local scour, stem walls shall be supported by deep footings;
 - 1.7. Shallow foundations including spread footing, mat and raft foundations shall be designed to prevent sliding, uplift, or overturning when exposed to the combination of loads in ASCE 24, Section 1.6.2.
- 2. Wave-resisting dry floodproofing wall and foundation system.** Buildings that are nonresidential (for flood zone purposes) and that are located in Coastal A-Zones shall

be permitted to be dry floodproofed in accordance with Section G304.1.2 [~~provided the structure is~~]. Such structure shall be dry floodproofed to [at] or above the design flood elevation specified in ASCE 24, Table 6-1. [~~For buildings or structures utilizing this exception, construction documents~~] Flood zone compliance plans shall include calculations demonstrating that the foundation and building, including flood shields if provided, will resist the wave action, including the combination of loads in ASCE 24, Section 1.6, to at or above the design flood elevation [~~specified in ASCE 24, Table 4-1~~].

G304.4 Construction standards for shaded X-Zones. In shaded X-Zones, [~~buildings that include I-2 occupancies that are hospitals~~] flood design class 4 buildings, as defined in ASCE 24, Table 1-1, shall comply with the requirements of this [~~chapter~~] appendix and the applicable provisions of ASCE 24 for A-Zone construction.

G304.4.1 Alterations to certain flood design class 4 buildings. Where existing emergency vehicle garages and fire, rescue, ambulance, and police stations located within shaded X-Zones are undergoing either a substantial improvement or an increase in the degree of noncompliance as such term is described in Item 10 of Section G102.1, they shall comply with this appendix to the maximum extent practicable as described in Sections G304.4.1.1 through G304.4.1.4.

G304.4.1.1 Existing emergency vehicle garages and fire, rescue, ambulance, and police stations to remain. Where an existing emergency vehicle garage or fire, rescue, ambulance, or police station building is undergoing substantial improvement or an increase in the degree of noncompliance, such existing emergency vehicle storage area shall be permitted to be located below the design flood elevation, provided such space is wet floodproofed in accordance with ASCE 24 and an emergency action plan is filed with the department in accordance with ASCE 24, Section 6.2.3. Such emergency action plan shall include actionable directives for the relocation of such emergency vehicles in advance of a flood event.

G304.4.1.2 Equipment within existing emergency vehicle garages and fire, rescue, ambulance, and police stations. Where an existing emergency vehicle garage or fire, rescue, ambulance, or police station building is undergoing substantial improvement or an increase in the degree of noncompliance, equipment necessary to support operations of such facilities may be located below the design flood elevation where elevation of such equipment to the design flood elevation is physically unfeasible. Such equipment shall be elevated to the maximum extent practicable.

G304.4.1.3 Conversion of space below the design flood elevation. Conversion of existing nonoccupiable space to occupiable space without such space being in full compliance with this appendix shall be prohibited.

G304.4.1.4 Subgrade spaces to remain. Where an existing emergency vehicle garage or fire, rescue, ambulance, or police station building is undergoing substantial improvement or an increase in the degree of noncompliance, the existing

subgrade space shall be provided with a sump pump system, designed to be fully submerged and remain operational post-flood-event to remove flood waters after a storm surge has receded. Such pump system shall be designed with the pump controller located above the design flood elevation and all electrical wiring below the design flood elevation shall be listed and marked for use with a submersible pump. The pump system shall be connected to a standby power source, which shall be elevated above the design flood elevation.

G304.5 Additional construction standards with respect to connections for temporary external generators, boilers and chillers. In addition to the other requirements of this [chapter] appendix, connections for temporary external generators, boilers and chillers shall be provided in accordance with Sections G304.5.1 through G304.5.4.

G304.5.1 Group I-1 and adult homes, enriched housing, community residences and intermediate care facilities. An occupancy that is classified as Group I-1, or that is an adult home, enriched housing, community residence or intermediate care facility and classified as Group R pursuant to an exception to Section [~~308.2.1 or 308.2.2~~] 308.3.1 or 308.3.2, shall comply with the following requirements:

- 1. Connections for temporary external generators.** Electrical connections shall be provided allowing for the connection of temporary external generators capable of providing power for at least 72 hours for, at a minimum, the following systems:
 - 1.1. Exit signs and means of egress illumination required by Chapter 10 and serving such occupancy;
 - 1.2. Fire alarm systems serving such occupancy;
 - 1.3. For buildings having occupied floors located more than 75 feet (22 860 mm) above the lowest level of fire department vehicle access, at least one elevator that serves all floors; and
 - 1.4. Lighting in such occupancy, sufficient to maintain illumination in accordance with Section 1205.3, for (i) spaces primarily used for the provision of medical services to persons, including, but not limited to, consultation, evaluation, monitoring and treatment services and (ii) spaces intended to be used by persons for sleeping purposes.

Exception: Connections for temporary external generators shall not be required for buildings with emergency or standby power systems that are permanently installed above the design flood elevation specified in Table 7-1 of ASCE 24 and capable of providing power for at least 72 hours to the systems identified in Item 1 of Section G304.5.1. Natural gas shall be a permitted fuel supply.

- 2. Flood protection for temporary external generator connections.** Electrical connections installed in accordance with Item 1 of Section G304.5.1 shall be located at or above the design flood elevation specified in Table 7-1 of ASCE 24.

3. **Emergency connection plan.** Prior to sign-off of work by the department, a plan shall be submitted to the department that identifies how the temporary external generators will be connected and capable of providing power for the occupancy in accordance with Item 1 of Section G304.5.1 within 72 hours after failure of the normal power supply.

G304.5.2 Group I-2 hospitals. An occupancy that is a Group I-2 hospital shall comply with the following requirements:

1. **Connections for temporary external generators.** Electrical connections shall be provided allowing for the connection of temporary external generators capable of providing power for at least 72 hours for, at a minimum, the following systems:
 - 1.1. All electrical services serving such occupancy for which emergency or standby power must be provided in accordance with any other applicable local, state or federal law or rule; and
 - 1.2. Air conditioning and cooling systems serving such occupancy, sufficient to maintain temperature and humidity in accordance with Section 1204, for (i) spaces primarily used for the provision of medical services to persons, including, but not limited to, consultation, evaluation, monitoring and treatment services and (ii) spaces intended to be used by persons for sleeping purposes.

Exception: Connections for temporary external generators shall not be required for buildings that have emergency or standby power systems that are permanently installed above the design flood elevation specified in Table 7-1 of ASCE 24 and capable of providing power for at least 72 hours to the systems identified in Item 1 of Section G304.5.2. Natural gas shall be a permitted fuel supply.

2. **Connections for temporary external boilers and chillers.** Where boiler and chiller plants are located below the design flood elevation specified in Table 7-1 of ASCE 24 and serve (i) spaces primarily used for the provision of medical services to persons, including, but not limited to, consultation, evaluation, monitoring and treatment services or (ii) spaces intended to be used by persons for sleeping purposes, connections shall be provided to allow for the connection of temporary external boilers and chillers capable of maintaining temperature and humidity for such spaces in accordance with Section 1204 for at least 72 hours.
3. **Flood protection for temporary external generator, boiler and chiller connections.** Electrical connections installed in accordance with Item 1 of Section G304.5.2 and connections installed in accordance with Item 2 of Section G304.5.2 shall be located at or above the design flood elevation specified in Table 7-1 of ASCE 24.
4. **Emergency connection plan.** Prior to sign-off of work by the department, the following shall be submitted to the department:

- 4.1. For an occupancy required to comply with Item 1 of Section G304.5.2, a plan that identifies how the temporary external generators will be connected and capable of providing power for the occupancy in accordance with such item within 72 hours after failure of the normal power supply; and
- 4.2. For an occupancy required to comply with Item 2 of Section G304.5.2, a plan that identifies how the temporary external boilers and chillers will be connected and capable of maintaining temperature and humidity for specified spaces in accordance with Section 1204 within 72 hours after failure of the primary boiler and chiller plants.

G304.5.3 Group I-2 nursing homes. An occupancy that is a Group I-2 nursing home shall comply with Section G304.5.2.

Exception: Such occupancy is not required to comply with Items 1.2, 2 and 4.2 of Section G304.5.2.

G304.5.4 Group I-2 occupancies, other than hospitals and nursing homes. A Group I-2 occupancy, other than a hospital or a nursing home, shall comply with Section G304.5.1.

SECTION BC G305 MANUFACTURED HOMES

G305.1 Elevation. All new and replacement manufactured homes shall be prohibited in coastal high-hazard areas. Within A-Zones, all new, replaced or substantially improved manufactured homes shall be elevated such that the lowest floor of the manufactured home is elevated to or above the design flood elevation as specified in ASCE 24, Table 2-1.

G305.2 Foundations. Within A-Zones, all new and replacement manufactured homes, including substantial improvement of existing manufactured homes, shall be placed on a permanent, reinforced foundation that is designed in accordance with ASCE 24.

~~[G305.1 General. Manufactured homes shall be prohibited in V-Zones. Within A-Zones, all new, replaced or substantially improved manufactured homes shall be:]~~

~~[1. Installed using methods and practices that minimize flood damage;]~~

~~[2. Elevated to or above the design flood elevation specified in ASCE 24, Table 2-1;]~~

~~[3. Placed on a permanent, reinforced foundation that is designed in accordance with ASCE 24; and]~~

~~[4. Securely]~~

G305.3 Anchoring. Manufactured homes shall be securely anchored to [a] an adequately anchored foundation system [designed] to resist flotation, collapse and lateral movement. Methods of anchoring are authorized to include, but are not limited to, use of over-the-top or

frame ties to ground anchors. This requirement is in addition to applicable state and local anchoring requirements for resisting wind forces.

G305.4 Protection of mechanical equipment and outside appliances. Mechanical equipment and outside appliances shall be elevated to or above the design flood elevation.

Exception: Where such equipment and appliances are designed and installed to prevent water from entering or accumulating within their components and the systems are constructed to resist hydrostatic and hydrodynamic loads and stresses, including the effects of buoyancy, during the occurrence of flooding up to the elevation required by ASCE 24, Table 2-1, the systems and equipment shall be permitted to be located below the elevation required by ASCE 24, Table 2-1. Electrical wiring systems shall be permitted below the design flood elevation provided they conform to the provisions of the *New York City Electrical Code*.

G305.5 Enclosures. Fully enclosed areas below elevated manufactured homes shall comply with the requirements of Section G304.1.1, Item 2.

SECTION BC G306 RECREATIONAL VEHICLES

G306.1 [General] Placement prohibited. The ~~[following shall apply to]~~ placement of ~~[all]~~ recreational vehicles ~~[within areas of special flood hazard:]~~ shall not be authorized in coastal high-hazard areas or in floodways.

~~[1. Placement in V-Zones and floodways prohibited. The placement of recreational vehicles is prohibited in V-Zones and floodways.]~~

~~[2.]~~ **G306.2 Temporary placement in A-Zones.** ~~[Within A-Zones, recreational vehicles]~~ Recreational vehicles in A-Zones shall be fully licensed and ready for highway use, and shall be placed on a site for less than 180 consecutive days.

~~[3.]~~ **G306.3 Permanent placement [in A-Zones].** ~~[Within A-Zones, recreational]~~ Recreational vehicles in A-Zones that are not fully licensed and ready for highway use, or that are to be placed on a site for 180 or more consecutive days, shall meet the requirements of Section G305 for manufactured homes.

SECTION BC G307 TANKS

G307.1 Underground tanks. Underground tanks in ~~[areas of]~~ special flood hazard areas shall be designed, constructed, installed, and anchored to prevent flotation, collapse and lateral movement resulting from hydrostatic loads, including the effects of buoyancy, during conditions of flooding to the design flood elevation, in accordance with ASCE 24.

G307.2 Above-ground tanks. Above-ground tanks in ~~[areas of]~~ special flood hazard areas shall be:

1. Elevated to or above the design flood elevation specified in ASCE 24, Table 7-1; or

2. Designed, constructed, installed, and anchored to prevent flotation, collapse and lateral movement resulting from hydrodynamic and hydrostatic loads, including the effects of buoyancy, during conditions of flooding to the design flood elevation, in accordance with ASCE 24.

G307.3 Tank inlets and vents. In [~~areas of~~] special flood hazard areas, tank inlets, fill openings, outlets and vents shall be:

1. Installed at or above the design flood elevation specified in ASCE 24, Table 7-1, or [~~fitted with covers~~] designed to prevent the inflow of floodwater and outflow of the contents of the tanks during conditions of flooding to the design flood elevation, in accordance with ASCE 24; and
2. Anchored to prevent lateral movement resulting from hydrodynamic and hydrostatic loads, including the effects of buoyancy, during conditions of flooding to the design flood elevation, in accordance with ASCE 24.

G307.4 Additional fuel-oil storage capacity. Fuel-oil storage capacity in [~~areas of~~] special flood hazard areas and shaded X-Zones shall comply with the following:

1. In [~~areas of~~] special flood hazard areas, fuel oil on the lowest story having its floor above the applicable design flood elevation shall be limited to 3,000 gallons (11 356 L) and no storage tank may exceed the lesser of 1,500 gallons (5678 L) or the quantity of fuel-oil needed to operate the emergency or standby generator(s) served by such tank for 24 hours; and
2. In shaded X-Zones, fuel oil on the lowest story having its floor above the 500-year flood elevation shall be limited to 3,000 gallons (11 356 L) and no storage tank may exceed the lesser of 1,500 gallons (5678 L) or the quantity of fuel-oil needed to operate the emergency or standby generator(s) served by such tank for 24 hours.

G307.4.1 Additional requirements. Where fuel-oil storage capacity exceeds the quantity set forth in Section 1305.11.1.3 of the *New York City Mechanical Code*, the fuel-oil storage shall comply with Sections G307.4.1.1 and G307.4.1.2 in addition to Section 1305 of the *New York City Mechanical Code*.

G307.4.1.1 Vault. Each fuel-oil storage tank shall be separately enclosed in a vault complying with all of the following requirements:

1. The walls, floor, and top of such vault shall have a fire resistance rating of not less than 3 hours;
2. The walls of such vault shall be bonded to the floor of such vault;
3. The top and walls of such vault shall be independent of the building structure;
4. An exterior building wall having a fire resistance rating of not less than 3 hours shall be permitted to serve as a wall of such vault; and

5. The vault shall be located in a dedicated room or area of the building that is separated vertically and horizontally from other areas of the building by construction having a fire resistance rating of not less than 2 hours.

G307.4.1.2 Extinguishing system. Fuel-oil storage shall be protected with an alternative automatic fire-extinguishing system complying with Section 904.

G307.5 Elevation of certain tanks and containers serving [~~critical facilities~~] flood design class 4 buildings. The following tanks and containers shall be located at or above the design flood elevation specified in ASCE 24, Table 7-1, [~~unless such tanks and containers serve buildings that include I-2 occupancies that are hospitals, in which case such tanks and containers shall be located at or above the greater of (i) the design flood elevation specified in ASCE 24, Table 7-1, or (ii) the 500-year flood elevation~~] when serving flood design class 4 buildings. Such tanks and containers must be designed to maintain service to such structure during flood conditions and shall comply with [~~section 9.6~~] Section 9.7 of ASCE 24:

1. Medical and compressed gas storage tanks, oxygen tanks, and other cryogenic system storage tanks;
2. Hazardous material storage tanks;
3. Stationary compressed gas containers;
4. Stationary cryogenic containers; and
5. Stationary flammable gas storage containers.

SECTION BC G308 OTHER BUILDING WORK

G308.1 [~~Detached~~] Garages and accessory structures. [~~Detached~~] Garages and accessory structures shall be [anchored to prevent flotation, collapse and lateral movement resulting from hydrostatic loads, including the effects of buoyancy, during conditions of flooding to the design flood elevation. Enclosed accessory structures usable solely for parking or storage shall be wet floodproofed and shall have flood openings to allow for the automatic entry and exit of flood waters] designed and constructed in accordance with ASCE 24, Section 9.4.

G308.2 Fences. Fences in floodways that may block the passage of floodwaters, such as stockade fences and wire mesh fences, shall meet the requirement of Section G103.5.

G308.3 Oil derricks. Oil derricks located in [~~areas of~~] special flood hazard areas shall be designed in conformance with ASCE 24.

G308.4 Retaining walls, sidewalks and driveways. Retaining walls, sidewalks and driveways shall meet the requirements of [~~Section~~] Sections G303.6 and G303.7.

G308.5 [~~Prefabricated swimming pools in floodways. Prefabricated swimming pools~~] Swimming pools. Swimming pools shall be designed and constructed in accordance with ASCE

24. Above-ground swimming pools, on-ground swimming pools and in-ground swimming pools that involve placement of fill in floodways shall also meet the requirements of Section G103.5.

G308.6 [~~Temporary flood shields. Temporary flood shields shall be permitted in accordance with Section 6.2.3 of ASCE 24.~~] **Decks, porches, and patios.** Decks, porches and patios shall be designed and constructed in accordance with ASCE 24.

G308.7 **Nonstructural concrete slabs in coastal high-hazard areas and coastal A-Zones.** In coastal high-hazard areas and coastal A-Zones, nonstructural concrete slabs used as parking pads, enclosure floors, landings, decks, walkways, patios and similar nonstructural uses are permitted beneath or adjacent to buildings and structures provided that the concrete slabs shall be constructed in accordance with ASCE 24, [Section 9.3](#).

G308.8 **Roads and watercourse crossings in regulated floodways.** Roads and watercourse crossings that encroach into regulated floodways, including roads, bridges, culverts, low-water crossings and similar means for vehicles or pedestrians to travel from one side of a watercourse to the other, shall meet the requirement of Section G103.5.

G308.9 **Temporary flood shields.** Temporary flood shields shall be permitted in accordance with Section 6.2.3 of ASCE 24. Temporary flood shields shall be located and arranged so as to allow hose lines to be attached to the inlets of fire department connections without interference in accordance with Section 6.4.5 of NFPA 14 as modified by Appendix Q. Where temporary flood shields extend beyond the property line, Section 3202 for permitted encroachments into the public right-of-way shall apply.

[~~G308.7~~] **G308.10** **Temporary stairs and ramps.** Temporary stairs and ramps shall comply with the requirements of Sections [~~G308.7.1~~] **G308.10.1** and [~~G308.7.2~~] **G308.10.2**. Temporary stairs and ramps shall be located and arranged so as to allow hose lines to be attached to the inlets of fire department connections without interference in accordance with Section 6.4.5 of NFPA 14, as modified by Appendix Q. Where temporary stairs and ramps extend beyond the property line, Section 3202 for permitted encroachments into the public right-of-way shall apply.

[~~G308.7.1~~] **G308.10.1** **Evacuated buildings.** Temporary stairs and ramps shall be permitted to provide elevated ingress and egress in compliance with Item 3 of Section 6.2.2 of ASCE 24 for buildings or portions of buildings that are planned to be evacuated during design flood conditions, except for maintenance and emergency personnel, provided that such temporary stairs and ramps shall not be permitted to serve as a required means of egress for a dwelling unit or for any area described in Item 2.2.1 of Section G304.1.2 required to be located at or above the design flood elevation.

[~~G308.7.2~~] **G308.10.2** **Existing buildings.** Temporary stairs and ramps for an existing building or portions thereof shall be permitted to provide elevated ingress and egress in compliance with Item 3 of Section 6.2.2 of ASCE 24, including as a required means of egress for dwelling units or for areas described in Item 2.2.1 of Section G304.1.2 required to be located at or above the design flood elevation, where such temporary stairs and ramps comply with Sections 1009 and 1010.

G308.11 Alterations to pre-FIRM buildings involving flood protective works. Where alterations to pre-FIRM buildings within the flood hazard area, other than substantial improvements or horizontal enlargements, include the installation of flood protective works, compliance with ASCE 24, Section 6.2.2 shall be required. Flood protective works shall be located and arranged so as to allow hose lines to be attached to the inlets of fire department connections without interference in accordance with Section 6.4.5 of NFPA 14, as modified by Appendix Q of this code.

SECTION BC G309 TEMPORARY STRUCTURES AND TEMPORARY STORAGE

G309.1 Temporary structures. Temporary structures shall be erected for a period of less than 180 days. Temporary structures shall be anchored to prevent flotation, collapse or lateral movement resulting from hydrostatic loads, including the effects of buoyancy, during conditions of the base flood. Fully enclosed temporary structures shall have flood openings that are in accordance with ASCE 24 to allow for the automatic entry and exit of floodwaters.

G309.2 Temporary storage. Temporary storage includes storage of goods and materials for a period of fewer than 180 days. Stored materials shall not include hazardous materials.

G309.3 Floodway encroachment. Temporary structures and temporary storage in floodways shall meet the requirements of Section G103.5.

SECTION BC G310 UTILITY AND MISCELLANEOUS GROUP U [~~BUILDINGS AND OTHER SIMILAR STRUCTURES~~]

G310.1 Utility and miscellaneous Group U [~~buildings and other similar structures~~]. Section G310 shall govern utility and miscellaneous Group U, including buildings that are [identified] accessory in [Section 312] character and [other similar] miscellaneous structures not classified in any specific occupancy in this code, including, but not limited to, agricultural buildings, aircraft hangars (accessory to a one- or two-family residence), barns, carports, fences more than 6 feet (1829 mm) high, grain silos (accessory to a residential occupancy), greenhouses, livestock shelters, private garages, retaining walls, sheds, stables[;] and towers.

G310.2 Flood loads. Utility and miscellaneous Group U buildings and [~~similar~~] structures, including substantial improvement of such buildings and structures, shall be anchored to prevent flotation, collapse or lateral movement resulting from flood loads, including the effects of buoyancy, during conditions of the design flood.

G310.3 Elevation. Utility and miscellaneous Group U buildings and [~~similar~~] structures, including substantial improvement of such buildings and structures, shall be elevated such that the lowest floor, including basement, is [~~at~~] elevated to or above the design flood elevation specified in ASCE 24, unless otherwise permitted to comply with requirements of Section 9.4 of ASCE 24.

G310.4 Enclosures below design flood elevation. Fully enclosed areas below the design flood elevation shall [~~empty~~] be constructed in accordance with Section G304.

G310.5 Flood-damage-resistant materials. Flood-damage-resistant materials shall be used below the design flood elevation.

G310.6 Protection of mechanical, plumbing and electrical systems. Mechanical, plumbing and electrical systems, including plumbing fixtures, shall be elevated to or above the design flood elevation.

Exception:~~[The following]~~ Electrical systems, equipment and components; heating, ventilating, air conditioning and plumbing appliances; plumbing fixtures, duct systems and other service equipment shall be permitted to be located below the design flood elevation provided that they are designed and installed ~~[to prevent water from entering or accumulating within the components and to resist hydrostatic and hydrodynamic loads and stresses, including the effects of buoyancy, during the occurrence of flooding to the design flood elevation in compliance with the flood resistant construction requirements of this code:]~~

~~[1. Electrical systems, equipment and components;]~~

~~[2. Heating, ventilating, air conditioning, and plumbing appliances;]~~

~~[3. Plumbing fixtures;]~~

~~[4. Duct systems; and]~~

~~[5. Other service equipment.]~~

in compliance with Section G304.1.2, Item 2.3 and other applicable flood-resistant construction requirements of this code.

Electrical wiring systems shall be permitted to be located below the design flood elevation provided they conform to the provisions of the *New York City Electrical Code* and Section 7.2 of ASCE 24.

SECTION BC G311 **HAZARDOUS SUBSTANCES**

G311.1 Hazardous substances. Portable containers located in the flood hazard area that store hazardous substances, as defined in Section 41-03 of Title 15 of the *Rules of the City of New York*, shall comply with Section 41-14 of Title 15 of the *Rules of the City of New York*.

SECTION BC [G311] G312 **RETROACTIVE REQUIREMENTS**

[G311.1] G312.1 General. Notwithstanding any other provision of the *New York City Construction Codes*, the provisions of this section shall apply retroactively to all buildings and structures specified herein.

[G311.2] G312.2 Connections for temporary external generators. The following buildings shall be provided with connections for temporary external generators in accordance with Sections

G304.5.1 through G304.5.4, as applicable, by January 1, 2033, and a report detailing compliance with such requirements shall be filed with the department in accordance with Section ~~[G311.2.2]~~ G312.2.2 by such date:

1. Buildings whose main use or dominant occupancy is Group I-1 and that are located in ~~[an area of]~~ a special flood hazard area;
2. Buildings whose main use or dominant occupancy is an adult home, enriched housing, community residence or intermediate care facility that is classified as occupancy Group R pursuant to an exception to Section ~~[308.2.1 or 308.2.2]~~ 308.3.1 or 308.3.2 and that are located in ~~[an area of]~~ a special flood hazard area;
3. Buildings whose main use or dominant occupancy is Group I-2 hospital and that are located in ~~[an area of]~~ a special flood hazard area or shaded X-Zone;
4. Buildings whose main use or dominant occupancy is Group I-2 nursing home and that are located in ~~[an area of]~~ a special flood hazard area; and
5. Buildings whose main use or dominant occupancy is Group I-2, other than hospitals and nursing homes, and that are located in ~~[an area of]~~ a special flood hazard area.

~~[G311.2.1]~~ G312.2.1 Modification to the ~~[area of special]~~ flood hazard area ~~[or shaded X-Zone]~~. Where the ~~[area of]~~ special flood hazard area or shaded X-Zone is modified on or after the effective date of this section, any building identified in Section ~~[G311.2]~~ G312.2 and newly identified as being within such modified ~~[area of]~~ special flood hazard area or shaded X-Zone shall, no later than 20 years following the adoption of such modification, comply with the retroactive requirements of Section ~~[G311.2]~~ G312.2. The owner of such building shall, no later than 20 years following the adoption of such modification, file with the department a report detailing compliance with such requirements in accordance with Section ~~[G311.2.2]~~ G312.2.2.

~~[G311.2.2]~~ G312.2.2 Report of compliance. The owner of a building required to comply with the provisions of Section ~~[G311.2]~~ G312.2 shall file with the department, by January 1, 2033, a report prepared by a registered design professional or licensed master electrician (i) certifying that the requirements of Section ~~[G311.2]~~ G312.2 have been satisfied and detailing how such requirements were satisfied or (ii) certifying that the building met or was altered to meet the provisions of any applicable exception in Sections G304.5.1 or G304.5.2.

~~[G311.2.3]~~ G312.2.3 Filing. The department may promulgate rules establishing filing fees for the review and examination of such reports.

~~[G311.3]~~ G312.3 Connections for temporary external boilers and chillers. Buildings whose main use or dominant occupancy is Group I-2 hospital and that are located in ~~[an area of special]~~ a flood hazard area ~~[or shaded X-Zone]~~ shall be provided with connections for temporary external boilers and chillers in accordance with Section G304.5.2 by January 1, 2033, and a report detailing compliance with such requirements shall be filed with the department in accordance with Section ~~[G311.3.2]~~ G312.3.2 by such date.

~~[G311.3.1]~~ **G312.3.1 Modification to the ~~[area of special]~~ flood hazard area ~~[or shaded X-Zone]~~.** Where the ~~[area of]~~ special flood hazard area or shaded X-Zone is modified on or after the effective date of this section, any building whose main use or dominant occupancy is Group I-2 hospital and that is newly identified as being within such modified ~~[area of]~~ special flood hazard area or shaded X-Zone shall comply with the retroactive requirements of Section ~~[G311.3]~~ G312.3 no later than 20 years following the adoption of such modification. The owner of such building shall file with the department a report detailing compliance with such requirements in accordance with ~~[section G311.3.2]~~ Section 312.3.2 no later than 20 years following the adoption of such modification.

~~[G311.3.2]~~ **G312.3.2 Report of compliance.** The owner of a building required to comply with the provisions of Section ~~[G311.3]~~ G312.3 shall file with the department, by January 1, 2033, a report prepared by a registered design professional (i) certifying that the requirements of Section ~~[G311.3]~~ G312.3 have been satisfied and detailing how such requirements were satisfied or (ii) certifying that any boiler and chiller plants that serve the spaces specified in Item 2 of Section G304.5.2 are located at or above the design flood elevation specified in Table 7-1 of ASCE 24.

~~[G311.3.3]~~ **G312.3.3 Filing.** The department may promulgate rules establishing filing fees for the review and examination of such reports.

~~[CHAPTER G401]~~
~~[REFERENCED STANDARDS]~~

SECTION BC G401
~~[GENERAL]~~ REFERENCED STANDARDS

G401.1 General. This ~~[chapter]~~ section lists the standards that are referenced in various sections of this appendix. The standards are listed herein by the promulgating agency of the standard, the standard identification, the effective date and title and the section or sections of this document that reference the standard.

G401.2 Subsequent additions, modifications or deletions. Refer to the rules of the department for any subsequent additions, modifications or deletions that may have been made to these standards in accordance with Section 28-103.19 of the *Administrative Code*.

G401.3 Applicability. The application of the referenced standards shall be as specified in Section ~~[402.4]~~ G105.1.

~~[G401.4 Reserved.]~~

~~[G401.5 Reserved.]~~

~~[G401.6 Reserved.]~~

**SECTION BC G402
STANDARDS**

ASCE 7-[05] <u>16</u>	<u>Minimum Design Loads and Associated Criteria for Buildings and Other Structures</u>	<u>[G104.5.2, G 201.2] G104.2.3.2, G304.2</u>
ASCE 24- [05*] <u>14*</u>	[Flood-Resistant] <u>Flood Resistant Design and Construction</u>	<u>G101.3, G102.1, G103.1, [G104.3, G104.5.1, G104.5.2, G105.2, G105.3.1, G201.2,] G104.2.1, G104.2.3.1, G104.2.3.2, G107.2, G107.3, G107.4, G301.1, [G303.2,] G303.3, G303.4, G303.5, G303.8, G304.1, G304.1.1, G304.1.2, G304.2, G304.3, G304.4, G304.4.1.1, G304.5.1, G305.1, G305.2, G305.4, G307.1, G307.2, G307.3, G307.5, G308.1, G308.3, G308.5, G308.6, G308.7, G308.9, G308.10.1, G308.10.2, G308.11, G309.1, G310.3, G310.6, G312.3.2</u>

*As modified in [~~Chapter G5~~] Section G501.

FEMA FIS 360497	Flood Insurance Study, Community Number 360497, Revised September 5, 2007 Federal Emergency Management Agency	<u>G102.2, G102.2.1, G102.2.2, G102.3.1.1, G103.3.2</u>
FEMA PFIS 360497	Preliminary Flood Insurance Study, <u>Issued December 5, 2013,</u> Community Number 360497,	<u>G102.2.1, G102.2.2, G102.3.1.1, [G102.3.2.2]</u>

FEMA FIRMs 360497	Flood Insurance Rate Map, Community Number 360497, Panel Numbers 1 through 0457, Revised September 5, 2007, Federal Emergency Management Agency, with the following [Letter] <u>Letters</u> of Map Revision: <i>Letter of Map Revision effective September 29, 2008, FEMA case # 08-02-0948P, revising FIRM panel 0111 and Letter of Map Revision effective April 18, 2018, FEMA case # 17-02-1503P, revising FIRM panels 0092F, 0094F, 0111F, and 0113F.</i>	G102.2, <u>G102.2.2</u> , G102.3, G102.3.1, G102.3.2, [G103.3 , G201.2] <u>G103.3.1</u> , <u>G103.3.2</u>
FEMA [FIRMs] <u>PFIRMs</u> 360497	Preliminary Flood Insurance Rate Map, Community Number 360497, <u>Issued December 5, 2013;</u> <u>Revised January 30, 2015, as applicable;</u> Federal Emergency Management Agency	G102.2.1, G102.2.2, G102.3.1.1, G102.3.2.1
FEMA FORM 086-0-34	Floodproofing Certificate; Federal Emergency Management Agency	[G105.3] <u>G107.3</u>
FEMA FORM 086-0-33	Elevation Certificate; Federal Emergency Management Agency	[G105.3] <u>G107.3</u>
HUD 24 CFR Part 3280- [94] <u>08</u>	Manufactured Home Construction and Safety Standards, [1994] <u>2008</u>	[G201.2] <u>G201.1.2</u>

NFPA 14-16* Standard for the Installation of Standpipe and Hose Systems

G304.1.2, G308.9, G308.10, G308.11

*As modified in Appendix Q.

~~[CHAPTER G5]
[MODIFICATIONS TO REFERENCED STANDARDS]~~

**SECTION BC G501
MODIFICATIONS TO REFERENCED STANDARDS**

~~[The following amendments are hereby made to the referenced standards listed in Section G401.]~~

G501.1 Amendments to ~~[ASCE 24-05]~~ ASCE 24-14. The following amendments are hereby made to the applicable sections of ~~[ASCE 24-05]~~ ASCE 24-14. Refer to the rules of the department for any subsequent additions, modifications or deletions that may have been made to this standard in accordance with Section 28-103.19 of the *Administrative Code*.

Section 1.1. Section 1.1 (Scope) is amended by deleting the sentence “In addition to the requirements of this section (see Fig. 1-2):” and Items 1 through 4, and by adding the following paragraph to read as follows:

~~[The scope]~~ In addition to the requirements of this section, the applicability of this standard is as provided for in Section G102.1 of the *New York City Building Code*, Appendix G.

Section 1.1. Figure 1-2 (Application of Chapters) of Section 1.2. Delete.

Section ~~[1.1.2]~~ 1.1.1. A new Section ~~[1.1.2]~~ 1.1.1 is added to read as follows:

~~[1.1.2]~~ **1.1.1 High-risk flood hazard areas.** Notwithstanding any other provision in this standard, no special flood hazard area in New York City shall be classified as alluvial fan area, flash flood area, mudslide area, ice jam and debris area, erosion-prone area, high-velocity flow area.

Section 1.2. Section 1.2 (Definitions) is amended by modifying only the following definitions to read as follows:

Breakaway wall— As defined in Section G201 of the *New York City Building Code*, Appendix G.

Design flood elevation—The applicable elevation specified in Table 2-1, 4-1, 5-1, 6-1, or 7-1, depending on the ~~[structural occupancy category]~~ flood design classification designated in Table 1-1.

High-risk flood hazard area—An area designated as a coastal high-hazard area, being those areas identified on the FIRM as a V-Zone or Coastal A-Zone.

Nonresidential—~~[As defined]~~ Defined as Nonresidential (for flood zone purposes) in Section G201 of the *New York City Building Code*, Appendix G.

Residential—~~[As defined]~~ Defined as Residential (for flood zone purposes) in Section G201 of the *New York City Building Code*, Appendix G.

Section 1.4.3. Table 1-1 of Section 1.4.3 (Classification of Structures) is amended to read as follows:

TABLE 1-1
[CLASSIFICATION OF STRUCTURES FOR FLOOD-RESISTANT DESIGN AND CONSTRUCTION]
[(CLASSIFICATION SAME AS NEW YORK CITY BUILDING CODE TABLE 1604.5)]
FLOOD DESIGN CLASS OF BUILDINGS AND STRUCTURES

[STRUCTURAL OCCUPANCY/ CATEGORY]	[NATURE OF OCCUPANCY] <u>USE OF OCCUPANCY OF BUILDINGS AND STRUCTURES</u>	<u>FLOOD DESIGN CLASS</u>
[I]	<p>Buildings and other structures that represent a low hazard to human life in the event of failure, including but not limited to: <u>normally are unoccupied and pose minimal risk to the public or minimal disruption to the community should they be damaged or fail due to flooding. Flood Design Class 1 includes:</u></p> <ol style="list-style-type: none"> 1. [Agricultural facilities.] 2. [Certain] certain temporary [facilities.] <u>structures that are in place for less than 180 days.</u> 3. 2. [Minor] accessory storage buildings and minor storage facilities. 4. <u>small structures used for parking of vehicles, and</u> 5. <u>certain agricultural structures.^a</u> 	<u>1</u>
[II]	<p>Buildings and other structures <u>that pose a moderate risk to the public or moderate disruption to the community should they be damaged or fail due to flooding, except those listed [in Occupancy Categories I, III and IV] as Flood Design Classes 1, 3, and 4. Flood Design Class 2 includes the vast majority of buildings and structures that are not specifically assigned another Flood Design Class, including most residential, commercial, and industrial buildings.</u></p>	<u>2</u>
[III]	<p>Buildings and other structures that represent a substantial hazard to human life in the event of failure, including but not limited to:</p> <ol style="list-style-type: none"> 1. Buildings and other structures whose primary occupancy is public assembly with an occupant load greater than 300.] 2. Buildings and other structures containing elementary school, secondary school or day care facilities with an occupant load greater than 250.] 3. Buildings and other structures containing adult education facilities, such as colleges and universities with an occupant load greater than 500.] 4. Group I-2 occupancies with an occupant load of 50 or more resident patients but not having surgery or emergency treatment facilities.] 5. Group I-3 occupancies.] 6. Any other occupancy with an occupant load greater than 5,000^a.] 7. Power generating stations, water treatment facilities for potable water, waste water treatment facilities and other public utility facilities not included in Occupancy Category IV.] 8. Buildings and other structures not included in Occupancy Category IV containing sufficient quantities of toxic or explosive substances to be dangerous to the public if released.] <p><u>pose a high risk to the public or significant disruption to the community should they be damaged, be unable to perform their intended functions after flooding, or fail due to flooding. Flood Design Class 3 includes:</u></p>	<u>3</u>

[STRUCTURAL OCCUPANCY/ CATEGORY]	[NATURE OF OCCUPANCY] USE OF OCCUPANCY OF BUILDINGS AND STRUCTURES	FLOOD DESIGN CLASS
	<ol style="list-style-type: none"> 1. <u>buildings and structures in which 300 or more persons may assemble in one place, such as theaters, lecture halls, and religious institutions with large areas used for worship;</u> 2. <u>museums;</u> 3. <u>community centers and other recreational facilities;</u> 4. <u>athletic facilities with seating for spectators;</u> 5. <u>elementary schools, secondary schools, and buildings with college or adult education classrooms;</u> 6. <u>jails, correctional facilities, and detention facilities;</u> 7. <u>healthcare facilities not having surgery or emergency treatment capabilities;</u> 8. <u>care facilities where residents have limited mobility or ability, including nursing homes but not including care facilities for five or fewer persons;</u> 9. <u>preschool and child care facilities not located in one- and two-family dwellings;</u> 10. <u>buildings and structures associated with power generating stations, water and sewage treatment plants, telecommunication facilities, and other utilities which, if their operations were interrupted by a flood, would cause significant disruption in day-to-day life or significant economic losses in a community; and</u> 11. <u>buildings and other structures not included in Flood Design Class 4 (including but not limited to facilities that manufacture, process, handle, store, use, or dispose of such substances as hazardous fuels, hazardous chemicals, hazardous waste, or explosives) containing toxic or explosive substances where the quantity of the material exceeds a threshold quantity established by the authority having jurisdiction and is sufficient to pose a threat to the public if released.^b</u> 	
[IV]	<p>Buildings and other structures designated as <u>that contain essential facilities[-; including but not limited to:] and services necessary for emergency response and recovery, or that pose a substantial risk to the community at large in the event of failure, disruption of function, or damage by flooding. Flood Design Class 4 includes:</u></p> <ol style="list-style-type: none"> 1. [Group] group <u>group I-2 occupancies having surgery or emergency treatment facilities[-] ;</u> 2. [Fire] fire, <u>rescue, ambulance, and police stations and emergency vehicle garages[-] ;</u> 3. [Designated earthquake, hurricane or other] designated <u>designated emergency shelters[-] ;</u> 4. [Designated] designated <u>designated emergency preparedness, [communications] communication, and [operations] operation centers and other facilities required for emergency response [-] ;</u> 5. [Power generating] power generating <u>power generating stations and other public utility facilities required [as emergency backup facilities for Occupancy Category</u> 	4

[STRUCTURAL OCCUPANCY/ CATEGORY]	[NATURE OF OCCUPANCY] USE OF OCCUPANCY OF BUILDINGS AND STRUCTURES	FLOOD DESIGN CLASS
	<p>IV structures.] in emergencies;</p> <p>6. [Structures] <u>structures</u> containing highly toxic materials as defined by Section 307 where the quantity of the material exceeds the maximum allowable quantities of Table 307.1(2)(-);</p> <p>7. [Aviation] <u>critical aviation facilities such as control towers, air traffic control centers, and [emergency aircraft] hangars[-] for aircraft used in emergency response;</u></p> <p>8. <u>ancillary structures such as communication towers, electrical substations, fuel or water storage tanks, or other structures necessary to allow continued functioning of a Flood Design Class 4 facility during and after an emergency;</u></p> <p>[8-] <u>9. [Buildings] buildings and other structures having critical national defense functions[-]; and</u></p> <p>[9-] <u>10. [Water] water storage facilities and pump structures required to maintain water pressure for fire suppression.</u></p>	

- a. ~~[For purposes of occupant load calculation, occupancies required by Table 1004.1.1 to use gross floor area calculations shall be permitted to use net floor areas to determine the total occupant load.] Certain agricultural structures may be exempt from some of the provisions of this standard; see Section C1.4.3.~~
- b. Buildings and other structures containing toxic, highly toxic, or explosive substances shall be eligible for assignment to a lower Flood Design Class if it can be demonstrated to the satisfaction of the authority having jurisdiction by a hazard assessment as described in Section 1.5.3 of *Minimum Design Loads for Buildings and Other Structures* that a release of the substances is commensurate with the risk associated with that Flood Design Class.

Section 2.3. Table 2-1 of Section 2.3 (Elevation Requirements) is amended to read as follows:

TABLE 2-1
MINIMUM ELEVATION OF THE TOP OF LOWEST FLOOR
[RELATIVE TO DESIGN FLOOD ELEVATION (DFE)—A ZONES*]
FLOOD HAZARD AREAS OTHER THAN COASTAL HIGH-HAZARD AREAS^a, COASTAL A-ZONES^a

[STRUCTURAL OCCUPANCY CATEGORY] [FLOOD DESIGN CLASS] ^b	MINIMUM ELEVATION [OF LOWEST FLOOR] [RELATIVE TO BASE FLOOD ELEVATION (BFE)] [OR DESIGN FLOOD ELEVATION (DFE)]
[I] <u>1</u> ^c	DFE=BFE+ <u>2 ft</u>
[H (1 and 2 family dwellings)]	[DFE=BFE+ <u>2 ft</u>]
[H ^{e,d} (all others)] <u>2</u> ^d	DFE=BFE+ [<u>1 ft</u>] <u>2 ft</u>
[HH ^{e,d}] <u>3</u> ^d	DFE=BFE+ [<u>1 ft</u>] <u>2 ft</u>
[IV ^{e,d}] <u>4</u> ^d	DFE=BFE+ <u>2 ft</u> , or <u>500-year flood elevation</u> , whichever is higher

- a. Minimum elevations shown in Table 2-1 do not apply to [~~V-Zones~~] Coastal High-Hazard Areas and Coastal A-Zones (see Table 4-1). Minimum elevations shown in Table 2-1 apply to [~~A-Zones~~] other high risk flood hazard areas unless specific elevation requirements are given in Section 3 of this standard.
- b. See Table 1-1 [~~or Table 1604.5 of the New York City Building Code,~~] for [~~structural occupancy category~~] Flood Design Class descriptions.
- c. Flood Design Class 1 structures shall be allowed below the minimum elevation where the structure is permitted to be wet floodproofed in accordance with the requirements of Section 6.3.1 and is wet floodproofed in accordance with Section 6.3.2.
- [e] d. For nonresidential buildings and nonresidential portions of mixed-use buildings, the lowest floor shall be allowed below the minimum elevation if the structure meets the floodproofing requirements of Section [~~6~~] 6.2.
- [~~d.~~] Buildings that include I-2 occupancies that are hospitals shall use the greater of (i) the DFE for the applicable structural occupancy category as indicated in this table or (ii) the 500-year flood elevation.

Section 4.4. Table 4-1 of Section 4.4 (Elevation Requirements) is amended to read as follows:

TABLE 4-1
MINIMUM ELEVATION OF BOTTOM OF LOWEST SUPPORTING
HORIZONTAL STRUCTURAL MEMBER OF LOWEST FLOOR
[RELATIVE TO DESIGN FLOOD ELEVATION (DFE)—V-ZONES] -COASTAL HIGH-HAZARD
AREAS AND COASTAL A-ZONES

[STRUCTURAL OCCUPANCY CATEGORY] FLOOD DESIGN CLASS ^a	[MEMBER ORIENTATION RELATIVE TO THE DIRECTION OF WAVE APPROACH] MINIMUM ELEVATION, RELATIVE TO BASE FLOOD ELEVATION (BFE) OR DESIGN FLOOD ELEVATION (DFE)	
	[Parallel ^b]	[Perpendicular ^b]
	[I] 1	[DFE=BFE]
[H (1 and 2 family dwellings)]	[DFE=BFE+ 2 ft]	[DFE=BFE+ 2 ft]
[H ^c (all others)] 2	[DFE=BFE]	DFE=BFE+ [4 ft] 2 ft
[HH ^c] 3	[DFE=BFE+ 1 ft]	DFE=BFE+ 2 ft
[IV ^c] 4	[DFE=BFE+ 1 ft]	DFE=BFE+ 2 ft, or 500-year flood elevation, whichever is higher

- a. See Table 1-1[~~or Table 1604.5 of the New York City Building Code;~~] for [structural occupancy category] Flood Design Class descriptions.
- [b. Orientation of lowest horizontal structural member relative to the general direction of wave approach; parallel shall mean less than or equal to +20 degrees from the direction of approach; perpendicular shall mean greater than +20 degrees from the direction of approach.]
- [c. Buildings that include I 2 occupancies that are hospitals shall use the greater of (i) the DFE for the applicable structural occupancy category as indicated in this table or (ii) the 500 year flood elevation.]

Section 4.6.1. Section 4.6.1 (Breakaway Walls) is amended by adding the following sentence:

All breakaway walls enclosing spaces below the DFE in [V-Zones] coastal high-hazard area shall be open lattice, and not solid, with such enclosed spaces constructed as unconditioned per the *New York State Energy Conservation Construction Code*.

Section 5.1. Table 5-1 of Section 5.1 (Materials, General) is amended to read as follows:

**TABLE 5-1
MINIMUM ELEVATION [RELATIVE TO DESIGN FLOOD
ELEVATION (DFE)] BELOW WHICH FLOOD-DAMAGE-RESISTANT
MATERIALS SHALL BE USED**

[STRUCTURAL OCCUPANCY CATEGORY] FLOOD DESIGN CLASS ^a	[A-ZONE]	[Coastal High-Hazard Areas and Coastal A-Zones]	
		[Orientation Parallel ^b] MINIMUM ELEVATION IN FLOOD HAZARD AREAS, OTHER THAN COASTAL HIGH-HAZARD AREAS AND COASTAL A-ZONES, RELATIVE TO DESIGN FLOOD ELEVATION (DFE)	[Orientation Perpendicular ^b] MINIMUM ELEVATION IN COASTAL HIGH-HAZARD AREAS AND COASTAL A-ZONES, RELATIVE TO DESIGN FLOOD ELEVATION (DFE)
[I] 1	[DFE=BFE]	DFE=BFE + 2 ft	DFE=BFE + 2 ft
[H (1 and 2 family dwellings)]	[DFE=BFE + 2 ft]	[DFE=BFE + 2 ft]	[DFE=BFE + 2 ft]
[H ^c (all others)] 2	[DFE=BFE + 1 ft]	DFE=BFE + [1 ft] 2 ft	DFE=BFE + 2 ft
[III ^c] 3	[DFE=BFE + 1 ft]	DFE=BFE + 2 ft	DFE=BFE + 3 ft
[IV ^c] 4	[DFE=BFE + 2 ft]	DFE=BFE + 2 ft, or 500-year flood elevation, whichever is higher	DFE=BFE + 3 ft, or 500-year flood elevation, whichever is higher

- a. See Table 1-1 [or Table 1604.5 of the *New York City Building Code*,] for [structural occupancy category] Flood Design Class descriptions.
- b. Orientation of lowest horizontal structural member relative to the general direction of wave approach; parallel shall mean less than or equal to +20 degrees from the direction of approach; perpendicular shall mean greater than +20 degrees from the direction of approach.]
- c. Buildings that include I-2 occupancies that are hospitals shall use the greater of (i) the DFE for the applicable structural occupancy category as indicated in this table or (ii) the 500-year flood elevation.]

Section 5.2.6. Section 5.2.6 (Finishes) shall be amended to read as follows:

5.2.6 Finishes and other materials. Interior and exterior finishes, as well as any materials not otherwise provided for in Sections 5.2.1 through 5.2.5, shall be flood damage-resistant materials in accordance with FEMA Technical Bulletin 2/August 2008, Flood Damage-

Resistant Materials Requirement for Buildings Located in ~~[Special Flood Hazard Areas]~~ special flood hazard areas, or shall be required to be approved by the authority having jurisdiction.

Section 6.2. Table 6-1 of Section 6.2 (Dry Floodproofing) is amended to read as follows:

TABLE 6-1
MINIMUM ELEVATION OF FLOODPROOFING ~~[, RELATIVE TO~~
~~DESIGN FLOOD ELEVATION (DFE) — A ZONES] - FLOOD HAZARD AREAS OTHER THAN COASTAL~~
HIGH-HAZARD AREAS^a

[STRUCTURAL OCCUPANCY CATEGORY] <u>FLOOD DESIGN CLASS^b</u>	MINIMUM ELEVATION OF [FLOODPROOFING^b] <u>FLOODPROOFING^c</u> <u>RELATIVE TO DESIGN FLOOD ELEVATION (DFE)</u>
[I] <u>1</u>	DFE=BFE+ [+ft] <u>2 ft</u>
[H^{e,d}] <u>2^d</u>	DFE=BFE+ [+ft] <u>2 ft</u>
[HH^d] <u>3</u>	DFE=BFE+ [+ft] <u>2 ft</u>
[IV^d] <u>4</u>	DFE=BFE+ 2 ft, <u>or 500-year flood elevation, whichever is higher</u>

- a. Dry floodproofing is not allowed in Coastal High-Hazard Areas.
- b. See Table 1-1 ~~[, or Table 1604.5 of the New York City Building Code,]~~ for ~~[structural occupancy category]~~ Flood Design Class descriptions.
- ~~[b.]~~ c. Wet or dry floodproofing shall extend to the same level.
- ~~[e.]~~ d. Dry floodproofing [of residential buildings and residential portions of mixed use buildings shall not be permitted.] shall not be permitted (i) in buildings that are "residential for flood zone purposes"; (ii) for certain systems and equipment as provided for in Section G304.1.2, Item 2.3.1 of the New York City Building Code; and (iii) for dwelling units and spaces directly accessed from dwelling units in buildings that are "nonresidential for flood zone purposes".
- ~~[d.]~~ Buildings that include I-2 occupancies that are hospitals shall use the greater of (i) the DFE for the applicable structural occupancy category as indicated in this table or (ii) the 500-year flood elevation.

Section 6.2.1. (Dry Floodproofing Limitations) is amended to add the following exceptions:

Exceptions:

1. Upon special application to the commissioner, the department may authorize dry floodproofing for designs that demonstrate resistance to flood velocities exceeding 5 ft/s while meeting the other limitations of this standard.
2. Dry floodproofing shall be permitted in Coastal A-Zones, provided:
 - 2.1 such dry floodproofing complies with the requirements of Appendix G of the New York City Building Code; and

2.2 where flood velocities adjacent to the structure exceed 5 ft/s, the commissioner has authorized the dry floodproofing in accordance with Exception 1.

Section 6.2.2. Item 1 of Section 6.2.2 (Dry Floodproofing Requirements) is amended to read as follows:

1. Be designed and constructed so that any area below the applicable elevation specified in Table 6-1, together with attendant utilities, equipment, and sanitary facilities, is flood resistant with walls that are substantially impermeable to the passage of water. Where acceptable to the commissioner, fixed flood-resistant glazing systems may be used when tested and designed to be within walls substantially impermeable to water. Walls, floors, and flood shields shall be designed and constructed to resist hydrostatic, hydrodynamic, and other flood-related loads, including the effects of buoyancy resulting from flooding to the elevation listed in Table 6-1;

Section 6.2.2. Item 3 of Section 6.2.2 (Dry Floodproofing Requirements) is amended to read as follows:

3. [~~Have either:~~] Provide egress and ingress, where a means of egress is required by Chapter 10 of the *New York City Building Code*, to such dry floodproofed areas of structures in accordance with Item 3.1, 3.2 or 3.3, or a combination thereof, where permitted, as follows:

[~~3.1.~~] 3.1 **Egress and ingress not blocked by shields.** [~~All required means~~] Means of egress shall be elevated to or above the applicable DFE specified in Table 6-1, capable of providing human ingress and egress during the design flood between the dry floodproofed area to the exterior, without being blocked by flood shields or flood control devices; or

[~~3.2.~~] 3.2 [~~At least one elevated door located in close proximity to each required means of egress to the exterior that is to be blocked by flood shields or flood control devices, such that the~~] **Egress and ingress blocked by shields not serving dwelling units.** Where a means of egress required by Chapter 10 of the *New York City Building Code* that does not serve a dwelling unit is to be blocked by flood shields or flood control devices, an alternate means of egress shall be provided capable of providing human ingress and egress during the design flood between the dry floodproofed area to the exterior. The alternate means of egress shall comprise of: (i) a door providing ingress and egress opening directly to the exterior at or above the DFE, and such door shall be permitted to be accessed by steps or ramps; or (ii) a means of egress leading to an exterior exit door not blocked by shields or which is constructed as a wet floodproofed enclosure where discharging below the DFE, and such means of egress shall be permitted to be accessed by stairs and ramps. In either case, such alternate means of egress shall also comply with Items 3.2.1 through 3.2.6:

3.2.1 Alternate Means of Egress Entrance. The alternate means of egress entrance door, or directional signage to such alternate means of egress entrance door shall be readily visible and identifiable within a direct line of sight to a person approaching the blocked egress door(s). The path of travel from the blocked egress door to the alternate means of egress entrance shall be unobstructed with a travel distance of not more than 40 ft as measured from the blocked means of egress. Directional signage to the alternate means of egress shall be installed on the exit door blocked by flood shields prior to flood condition and removed during non-flood conditions.

3.2.2 Travel Distance. The path of travel from the alternate means of egress entrance door leading to the exterior of the building shall not exceed 100 ft.

3.2.3 Temporary Stairs, Ramps and Platforms. For buildings or portions of buildings that are planned to be evacuated during the design flood condition and pre-FIRM buildings, temporary stairs and ramps shall be permitted to serve as an alternate means of egress if their only purpose is to provide supplemental egress and ingress during conditions of flooding subject to the limitations of Section G308.10 of the *New York City Building Code*.

3.2.3.1 Doors. Any door opening directly onto such temporary stairs or platforms shall be secured during non-flood conditions to prevent use when such temporary stairs and ramps are in storage.

3.2.3.2 Signage. Directional signage to an egress utilizing temporary stairs, ramps or platforms shall be removed to prevent accidental operation during non-flood conditions.

3.2.4 Visibility from outside. Permanent signage affixed to the outside of flood shields or flood control devices that block the egress door shall provide directions to first responders or other personnel seeking to locate the path into the space from the exterior.

3.2.5 Compliance with egress requirements. Such alternate means of egress shall meet all requirements of Chapter 10 of the *New York City Building Code* for a required means of egress, including, travel distances, hardware and signage. Where an alternate means of egress may be used as a means of egress at any time other than a flood event, temporary stairs and ramps shall not be permitted.

Exceptions for buildings or portions of buildings that are planned to be evacuated during the design flood conditions:

1. Such alternate means of egress shall not be required to comply with occupant load calculations of the *New York City Building Code* if its only purpose is to provide supplemental egress and ingress during conditions of flooding.

2. The alternate means of egress may serve more than one required exit provided that the travel distances to and within the alternate means of egress comply with Item 3.2.1 and Item 3.2.2 from each required means of egress that is blocked by flood shields or flood control devices.

3.2.6 Accessibility. The alternate means of egress shall not be required to comply with Chapter 11 of the *New York City Building Code* if its only purpose is to provide supplemental egress and ingress during conditions of flooding, unless the structure is intended for occupancy during the design flood.

3.3 Egress and ingress blocked by shields serving dwelling units. For each means of egress required by Chapter 10 of the *New York City Building Code* that serves a dwelling unit and is to be blocked by flood shields or flood control devices, at least one alternate means of egress shall be provided capable of providing human ingress and egress during the design flood between the dry floodproofed area to the exterior. The alternate means of egress shall comprise either an elevated door opening directly to the exterior of the building arranged in accordance with Section 3.3.1 or an enclosure that incorporates wet floodproofing and is arranged in accordance with Section 3.3.2.

3.3.1 Elevated door. Where an elevated door is provided, such door shall be capable of providing human ingress and egress during the design flood. The elevated door shall open directly to the exterior of the building and shall be located in close proximity to the required means of egress to the exterior that is to be blocked by flood shields or flood control devices as follows:

3.3.1.1 Face of door. The face of the elevated door itself, and not merely its directional signage, shall be arranged so it is clearly visible to a person approaching the blocked egress door(s).

3.3.1.2 Elevation of door. Such door(s) shall be elevated to [at] or above the applicable DFE specified in Table 6-1[~~capable of providing human ingress and egress during the design flood~~].

3.3.1.3 Compliance with egress requirements. Such door shall meet all *New York City Building Code* requirements for a required means of egress to the exterior of the structure including hardware and signage [~~but shall not be required to comply with occupant load calculations, unless the structure is intended for occupancy during the design flood~~].

3.3.1.4 Accessibility. Such door may be accessed by open steps and shall not be required to comply with Chapter 11 of the *New York City Building Code* if its only purpose is to provide supplemental egress and ingress during conditions of flooding and to provide emergency egress at other times.

3.3.2 Enclosure that incorporates wet floodproofing. Where an enclosure which is partially wet floodproofed is used to provide alternate means of egress, such means of egress shall be capable of providing human ingress and egress during the design flood and shall be located in close proximity to the required means of egress to the exterior that is to be blocked by flood shields or flood control devices as follows:

3.3.2.1 Face of door to enclosure. The face of the door to the enclosure, and not merely its directional signage, shall be arranged so it is clearly visible to a person approaching the blocked egress door(s).

3.3.2.2 Wet floodproofing within an enclosure. Wet floodproofed portions of the enclosure shall be designed to comply with Section 6.3 and resist all flood related loads while prohibiting infiltration of floodwater to dry floodproofed spaces within the building.

3.3.2.3 Travel Distance. The path of travel from the alternate means of egress entrance door to the door leading to the exterior of the building shall not exceed 25 ft.

3.3.2.4 Compliance with egress requirements. The entrance and exit door shall meet all requirements of Chapter 10 of the *New York City Building Code* for a required means of egress to the exterior of the structure including hardware and signage.

Section 6.2.3. Section 6.2.3 (Limits on Human Intervention) is amended to read as follows:

Section 6.2.3 Limits on human intervention. Dry floodproofing measures that require human intervention to activate or implement prior to or during a flood, including temporary stairs or ramps, shall be permitted only when all of the following conditions are satisfied:

1. The flood warning time (alerting potential flood victims of a pending flood situation) shall be a minimum of 12 [~~hours,~~] h unless the community operates a flood warning system and implements an emergency plan to ensure safe evacuation of flood hazard areas, in which case human intervention is allowed only if the community can provide a minimum flood warning time equal to or longer than the cumulative time:
 - (a) [~~time~~] to notify [~~person(s)~~] persons responsible for installation of floodproofing measures, [~~plus~~]
 - (b) [~~time~~] for responsible persons to travel to structure to be floodproofed, [~~plus~~]
 - (c) [~~time~~] to install, activate, or implement floodproofing measures, [~~plus~~] and
 - (d) [~~time~~] to evacuate all occupants from the flood hazard area [~~;~~].

2. All removable shields or covers for openings such as windows, doors, and other openings in walls and temporary stairs or ramps shall be designed to resist flood loads specified in Section 1.6[~~and~~].
3. Where removable shields or temporary stairs or ramps are to be used, a flood emergency plan shall be approved by the authority having jurisdiction and shall specify, at a minimum, the following information: storage [~~location(s)~~] locations of the shields and temporary stairs and ramps; the method of installation and removal; conditions activating installation and removal; maintenance of shields and attachment devices and temporary stairs and ramps; periodic practice of installing and removing shields and temporary stairs and ramps; testing sump pumps and other drainage measures; and inspecting necessary material and equipment to activate or implement floodproofing. The flood emergency plan shall be posted permanently [~~posted~~] in at least two conspicuous locations within the structure.
4. Where removable shields or temporary stairs or ramps are to be used, they shall be stored on site within a building or within a secured, weather-resistant enclosure. Off-site storage shall be prohibited for buildings required to comply with Section G304.
5. Where removable shields or temporary stairs or ramps are proposed as per Section G304, periodic inspections, including a triennial full scale deployment, shall be conducted in accordance with Article 324 of the *Administrative Code*.

Section 7.1. Table 7-1 of Section 7.1 (General) is amended to read as follows (see Table 7-1 below):

**TABLE 7-1
MINIMUM ELEVATION OF ~~[UTILITIES AND]~~ ATTENDANT UTILITIES AND
EQUIPMENT ~~[RELATIVE TO DESIGN FLOOD ELEVATION (DFE)]~~**

[STRUCTURAL OCCUPANCY CATEGORY* FLOOD DESIGN CLASS ^a]	LOCATE [UTILITIES AND] ATTENDANT <u>UTILITIES AND EQUIPMENT</u> ABOVE ^b		
	[A-Zones] <u>MINIMUM ELEVATION IN FLOOD HAZARD AREAS, OTHER THAN COASTAL HIGH-HAZARD AREAS AND COASTAL A-ZONES, RELATIVE TO DESIGN FLOOD ELEVATION (DFE)</u>	[Coastal High-Hazard Area and Coastal A-Zones]	
		<u>[Orientation Parallel^e] MINIMUM ELEVATION IN COASTAL HIGH-HAZARD AREAS AND COASTAL A-ZONES, RELATIVE TO DESIGN FLOOD ELEVATION (DFE)</u>	<u>[Orientation Perpendicular^e]</u>
[H] <u>1</u>	DFE=BFE + 2 ft	DFE=BFE+ 2 ft	[DFE=BFE]
[H (1 and 2 family dwellings)]	[DFE=BFE+ 2 ft]	[DFE=BFE+ 2 ft]	[DFE=BFE+ 2 ft]
[H^{c,d} (all others)] <u>2</u>	DFE=BFE+ [4 ft] <u>2</u> ft	DFE=BFE+ [4 ft] <u>2</u> ft	[DFE=BFE+ 2 ft]
[HI^d] <u>3</u>	DFE=BFE+ [4 ft] <u>2</u> ft	DFE=BFE+ [2] <u>3</u> ft	[DFE=BFE+ 3 ft]
[IV^d] <u>4</u>	DFE=BFE+ 2 ft, or 500-year flood elevation, whichever is higher	DFE=BFE+ [2] <u>3</u> ft, or 500-year flood elevation, whichever is higher	[DFE=BFE+ 3 ft]

a. See Table 1-1 [~~or Table 1604.5 of the New York City Building Code;~~] for [~~structural occupancy category~~] Flood Design Class descriptions.

b. Locate [~~utilities and~~] attendant utilities and equipment above elevations shown unless otherwise provided in [~~the text~~] Chapter 7 of ASCE 24.

[~~e. Orientation of lowest horizontal structural member relative to the general direction of wave approach; parallel shall mean less than or equal to +20 degrees from the direction of approach; perpendicular shall mean greater than +20 degrees from the direction of approach.~~]

[~~d. Buildings that include I-2 occupancies that are hospitals shall use the greater of (i) the DFE for the applicable structural occupancy category as indicated in this table or (ii) the 500-year flood elevation.~~]

Section 7.2.4. Section 7.2.4 (Panelboards, Disconnect Switches, and Circuit Breakers) is amended to read as follows:

7.2.4 Panelboards, Disconnect [switches] Switches, and [circuit breakers] Circuit Breakers. The panelboards, load centers, main disconnect [switch] switches, all service disconnecting means, and all circuit breakers shall be located above and be accessible from the elevation specified in Table 7-1, or within a dry floodproofed enclosure, except where prohibited by the New York City Building Code. [~~Switches~~] Panelboards, load centers, main

disconnect switches, all service disconnecting means, and circuit breakers shall be located no more than 6 feet 7 inches (2 m) above the floor, or a platform shall be installed to provide access.

Section 7.3.3. Section 7.3.3 is amended to read as follows:

7.3.3 Plumbing systems installed below minimum elevations. Plumbing systems and components, including plumbing fixtures, shall be elevated above the elevation specified in Table 7-1. Where plumbing systems and components have openings below the elevation specified in Table 7-1, the openings shall be protected with automatic backwater valves or other automatic backflow devices. Devices shall be installed in each line that extends below the DFE to prevent release of sewage into floodwaters and to prevent infiltration by floodwaters into the plumbing. Redundant devices requiring human intervention shall be permitted. Plumbing systems shall be provided with backwater valves in the building drain at its point of exit from the building and downstream of the building trap.

Section 7.3.4. Section 7.3.4 is amended to read as follows:

7.3.4 Sanitary systems. Sanitary systems shall be designed to minimize infiltration of flood waters into the systems and discharges from the systems into floodwaters. Vents and openings shall be above the elevation specified in Table 7-1. Sanitary system storage tanks shall be designed, constructed, installed, and anchored to resist at least 1.5 times the potential buoyant and other flood forces acting on an empty tank during design flood conditions. Tanks and piping shall be installed to resist local scour and erosion. Sanitary systems shall be provided with backwater valves at the point of exit from the building and downstream of the building trap. Sanitary systems that must remain operational during or immediately after the design flood or lesser floods shall be equipped with a sealed storage tank that is sized to store at least 150% of the anticipated sewage flow associated with occupancy during flood conditions and during subsequent periods of saturated soil when sewage will not percolate.

Section ~~[7.5.1.]~~ 7.5.2 A new section ~~[7.5.1]~~ 7.5.2 is added to read as follows:

~~[7.5.1]~~ 7.5.2 Elevator signage. Where there is potential for an elevator cab to descend below the elevation specified in Table 7-1 into a wet floodproofed space, the elevator shall be equipped with controls that will prevent the cab from descending into floodwaters. Permanent, durable, and washable signage shall be placed in the elevator cab and in the elevator lobby on any story subject to flooding, stating that “In the event of flooding, water sensors in the elevator shaft will prevent the elevator from descending to [description of story, e.g., ground floor, first floor, parking level, etc.] and will automatically cause the elevator to rise to [description of story, e.g., second floor, mezzanine, etc.]”

Section 8.1. Section 8.1 (General) is amended to read as follows:

8.1 General. Stairways and ramps, including stairs and ramps pursuant to Section G308.10 of the New York City Building Code, that are located below the elevations specified in Tables 2-1 and 4-1 shall be designed and constructed to:

1. Resist flood-related loads specified in Section 1.6 and minimize transfer of flood-related loads to the structure and structure foundation; or

2. Break away during design flood conditions without causing damage to the structure, including the foundation; or
3. Use materials that conform to Chapter 5 for those portions of stairways and ramps that are located below the elevations specified in Tables 2-1 and 4-1, including items such as gates and doors.

In flood hazard areas other than Coastal High-Hazard Areas and Coastal A-Zones, enclosures for stairways and ramps that extend below the elevations specified in Table 2-1 shall conform to the requirements for enclosures in Section 2.7. In Coastal High-Hazard Areas and Coastal A-Zones, enclosures for stairways and ramps that extend below the elevations specified in Table 4-1 shall conform to the requirements for enclosures in Section 4.6.

Elevators shall conform to the requirements of Section 7.5.

Section ~~[9.3.1.]~~ 9.4.1. The second sentence of the first paragraph of Section ~~[9.3.1.]~~ 9.4.1 (Attached Garages, ~~[and]~~ Carports, and Accessory Storage Structures) is amended to read as follows:

Wet floodproofed garages and carports are permitted below elevations specified in Table 2-1 provided the lowest level of the garage, ~~[or]~~ carport or accessory storage structure is at or above grade on at least one side, the garage, ~~[or]~~ carport or accessory storage structure walls meet the opening requirements of Section ~~[2.6]~~ 2.7, and the lowest level of the garage, ~~[or]~~ carport or accessory storage structure is not classified as a “lowest floor” pursuant to Appendix G of the *New York City Building Code*.

[Section 9.5. Section 9.5 (Pools) is amended by adding a new paragraph to read as follows:]

~~[Mechanical equipment for pools such as pumps and water heaters, and associated electrical wiring, shall comply with Section 7.2 and 7.4.]~~

Section 9.7. The first sentence of Section 9.7 (Tanks) is amended to read as follows:

Tanks and tank inlets, fill openings, outlets, and vents shall terminate in accordance with Section G307.3 of the *New York City Building Code* or where located below the design flood elevation, shall be designed, constructed, installed, and anchored to resist all flood-related and other loads, including the effects of buoyancy, during flooding up to and including the design flood and without release of contents into floodwaters or infiltration of floodwaters into the tanks.

[G501.2 Reserved.]

[G501.3 Reserved.]

**SECTION BC G601
RESERVED**

**SECTION BC G701
RESERVED**

**~~SECTION BC G702
RESERVED~~**

**SECTION G801
RESERVED**

**SECTION G901
RESERVED**

**SECTION G1001
RESERVED**

**SECTION G1101
RESERVED**

§ 57. Sections H 102.1 and H 108.1 of Appendix H of the New York city building code, as amended by local law number 141 for the year 2013, are amended to read as follows:

H102.1 [~~General. Unless otherwise expressly stated, the following words and terms shall, for the purposes of this appendix, have the meanings shown herein. Refer to Chapter 2 of this code for general definitions.~~] **Definitions.** The following terms are defined in Chapter 2:

COMBINATION SIGN. [~~A sign incorporating any combination of the features of pole, projecting and roof signs.~~]

DISPLAY SIGN. [~~The area made available by the sign structure for the purpose of displaying the sign.~~]

ELECTRIC SIGN.

FILM SIGN[~~]; [A flat section of a material that is extremely thin in comparison to its length and breadth and has a nominal maximum thickness of 0.01 inch (0.25 mm).~~]

GROUND SIGN. [~~A billboard or similar type of sign which is supported by one or more uprights, poles or braces in or upon the ground other than a combination sign or pole sign, as defined by this code.~~]

MONOPOLE SIGN.

POLE SIGN. [A sign wholly supported by a sign structure in the ground.]

PROJECTING SIGN. [~~A sign other than a wall sign, projects from and is supported by a wall of a building or structure.~~]

ROOF SIGN. [~~A sign erected upon or above a roof or parapet of a building or structure.~~]

SIGN. [~~Any letter, figure, character, mark, plane, point, marquee sign, design, poster, pictorial, picture, stroke, stripe, line, trademark, reading matter or illuminated service, which shall be constructed, placed, attached, painted, erected, fastened or manufactured in any manner whatsoever, so that the same shall be used for the attraction of the public to any place, subject, person, firm, corporation, public performance, article, machine or merchandise, whatsoever, which is displayed in any manner outdoors. Every sign shall be classified and conform to the requirements of that classification as set forth in this chapter.~~]

SIGN STRUCTURE. [~~Any structure which supports or is capable of supporting a sign as defined in this code. A sign structure is permitted to be a single pole and is not required to be an integral part of the building.~~]

TEMPORARY SIGN. [~~A sign, with display area 500 square feet (46.5 m²) or less, erected for a period of 30 days or less.~~]

WALL SIGN. [~~Any sign attached to or erected against the wall of a building or structure, projecting no more than 15 inches (381 mm) from the face of the wall, with the exposed face of the sign in a plane parallel to the plane of said wall.~~]

H108.1 Fail-safe device. Signs that contain moving sections or ornaments shall have fail-safe provisions to prevent the section or ornament from releasing and falling or shifting its center of gravity more than 15 inches (381 mm). The fail-safe device shall be in addition to the mechanism and the mechanism's housing [~~which~~] that operate the movable section or ornament. The fail-safe device shall be capable of supporting the full dead weight of the section or ornament when the moving mechanism releases.

§ 58. Sections H 114.2.3, H114.2.3.1 and H 114.2.3.2 of Appendix H of the New York city building code, as amended by local law number 141 for the year 2013, are amended to read as follows:

H114.2.3 Identification. The additional requirements set forth in [~~sections~~] Sections H114.2.3.1 through H114.2.3.2 shall apply:

H114.2.3.1 UL classification decal. All signs shall bear a decal bearing the UL classification mark or name of the testing entity and its listing number, on a corner of the face of the fabric. This decal shall be of color(s) contrasting with those of the background of the display, and shall be readable from street or roadway level with the aid of binoculars.

H114.2.3.2 Date of sign erection. All signs shall bear a decal identifying the date of erection of the flexible sign structure on a corner of the face of the sign fabric. This decal shall be of color(s) contrasting with those of the background of the display, and shall be readable from street or roadway level with the aid of binoculars. If the same fabric is

relocated, the existing decal shall remain, and a new decal stating the re-erection date shall be affixed.

§ 59. Section BC H117 of Appendix H of the New York city building code, as amended by local law number 141 for the year 2013, is amended to read as follows:

**SECTION BC H117
REFERENCED STANDARDS**

H117.1 General. This section lists the standards that are referenced in various sections of this appendix. The standards are listed herein by the promulgating agency of the standard, the standard identification, the effective date and title and the section or sections of this document that reference the standard.

H117.2 Subsequent additions, modifications or deletions. Refer to the rules of the department for any subsequent additions, modifications or deletions that may have been made to these standards in accordance with Section 28-103.19 of the [~~Administrative Code~~] Administrative Code.

H117.3 Applicability. The application of the referenced standards shall be as specified in Section 102.4.

H117.4 Standards.

ASTM D 635-10	Standard Test Method for Rate of Burning and/or Extent and Time of Burning of Self-Supporting Plastics in a Horizontal Position	H107.1.1
NFPA 701-[04] 10	Methods of Fire Test for Flame Propagation of Textiles and Films	H114.2
UL 214-01	Standard for Tests for Flame Propagation of Fabrics and Films	H114.2

§60. Appendix K of the New York city building code is REPEALED and a new appendix K is added to read as follows:

APPENDIX K
MODIFIED INDUSTRY STANDARDS FOR ELEVATORS AND CONVEYING SYSTEMS

CHAPTER K1
MODIFICATIONS TO ASME A17.1-2013,
SAFETY CODE FOR ELEVATORS AND ESCALATORS

K101.1 General. As referenced by Chapter 30 of the *New York City Building Code*, the provisions of ASME A17.1-2013 shall be modified in accordance with this chapter. The section numbers correlate to those in the referenced ASME standard. Refer to the rules of the department for any subsequent additions, modifications or deletions that may have been made to this standard in accordance with Section 28-103.19 of the *Administrative Code*.

PART 1
GENERAL

SECTION 1.1
SCOPE

1.1.4 Effective date.

Delete Section 1.1.4 in its entirety.

SECTION 1.2
PURPOSE AND EXCEPTIONS

1.2.1 Purpose.

Delete and revise Section 1.2.1 to read as follows:

The purpose of this Code is to provide for the safety of life and limb, and to promote the public welfare. Compliance with this Code shall be achieved by:

- (a) conformance with the requirements in ASME A17.1/CSA B44; or
- (b) conformance with some of the requirements in ASME A17.1/CSA B44 and for systems, subsystems, components, or functions that do not conform with certain requirements in ASME A17.1/CSA B44, conform with the applicable requirements in ASME A17.7/ CSA B44-07, subject to the approval of the Commissioner; or
- (c) conformance with the requirements in ASME A17.7/CSA B44.7, subject to the approval of the Commissioner.

SECTION 1.3
DEFINITIONS

1.3 Add or delete and revise the following definitions to Section 1.3 as follows:

Delete and revise the definition of “Alternate level” to read as follows:

ALTERNATE LEVEL: Alternate levels shall be located in accordance with the following provisions:

- (a) Where no blind hoistway exists, the alternate level shall be three (3) levels above the designated level.
- (b) Where blind hoistways exist, the alternate level shall be the second level above the blind hoistway.
- (c) The sky lobby alternate level shall be three (3) levels above the sky lobby designated level.

(d) Where the designated level is the top floor, the alternate level shall be one floor below the designated level.

Delete and revise the definition of “Building code” to read as follows:

BUILDING CODE: New York City Building Code.

Delete and revise the definition of “Control space, elevator, dumbwaiter, material lift” to read as follows:

CONTROL SPACE, ELEVATOR, DUMBWAITER, MATERIAL LIFT: A space outside the hoistway, intended to be accessed with or without full bodily entry, that contains the motor controller. The space could also contain electrical and/or mechanical equipment used directly in connection with the elevator, dumbwaiter, or material lift but not the electric driving machine or the hydraulic machine. (See Nonmandatory Appendix Q).

Add new definition of “Hospital emergency service” to read as follows:

HOSPITAL EMERGENCY SERVICE: A special operating control function that may be provided for elevators in Occupancy Group I-2 (Hospital) or other applicable medical facility used to transport a patient in a life or death situation.

Delete and revise the definition of “In-car stop switch” to read as follows:

IN-CAR STOP SWITCH: A device located in the car that, when manually operated, causes the electric power to be removed from the driving-machine motor and brake of an electric elevator or from the electrically operated valves and pump motor of a hydraulic elevator.

Add new definition of “Load, balanced” to read as follows:

LOAD, BALANCED: The amount of weight measured as a percentage of the car capacity that must be placed in the elevator such that the suspended load of the car side is equal to the suspended load of the counterweight side.

Add new definition of “Lobby, elevator” to read as follows:

LOBBY, ELEVATOR: see *landing, elevator or material lift.*

Delete and revise the definition of “Occupant Evacuation Operation” to read as follows:

OCCUPANT EVACUATION OPERATION (OEO): The operation of an elevator system for occupant evacuation under emergency conditions.

Add new definition of “Patient elevator” to read as follows:

PATIENT ELEVATOR: An elevator located in a building classified in Occupancy Group I-2 (Hospital) reserved for the “sole” use of vertical transportation of nonambulatory patients who are incapable of self-preservation because of age, physical or mental disability. Hospital staff or other passengers transporting a patient are permitted to ride with the patient. Such elevators must be operated by a designated attendant and shall meet the requirements of Sections 2.27.4 and 2.27.5.3.

Add new definition of “Sky lobby” to read as follows:

SKY LOBBY: The lowest landing of an elevator or a group of elevators located above the street level.

Add new definition of “Smoke hole” to read as follows:

SMOKE HOLE: An opening for venting at the top of the elevator hoistway(s).

PART 2
ELECTRIC ELEVATORS

SECTION 2.1
CONSTRUCTION OF HOISTWAYS AND HOISTWAY ENCLOSURES

2.1.2 Construction at top and bottom of the hoistway.

Delete and revise Section 2.1.2.1 to read as follows:

2.1.2.1 Construction at top of the hoistway. The top of the hoistway shall be enclosed as required by the building code. A metal or concrete roof or floor shall be provided at the top of the hoistway and shall comply with Section 2.1.3.

2.1.4 Control of smoke and hot gases.

Delete Section 2.1.4 in its entirety.

2.1.5 Windows and skylights.

Delete and revise Section 2.1.5 to read as follows:

2.1.5 Windows and skylights.

Windows in the walls of hoistway enclosures are prohibited. Windows and skylights and their frames and sashes in machine rooms and control rooms shall conform to the requirements of the building code (see Section 1.3).

2.1.6 Projections, recesses, and setbacks in hoistway enclosures.

Delete and revise Subsections (a) and (c) of Section 2.1.6.2 to read as follows:

2.1.6.2 On sides not used for loading and unloading

(a) beams, floor slabs, or other building construction making an angle less than 75 deg with the horizontal shall not project more than 50 mm (2 in) inside the hoistway enclosure unless the top surface of the projection is beveled at an angle not less than 75 deg with the horizontal

(c) where recesses or setbacks exceeding 50 mm (2 in) occur in the enclosure wall, the top of the recess or setback shall be beveled at an angle of not less than 75 deg with the horizontal

SECTION 2.2
PITS

2.2.2 Design and construction of pits.

Delete and revise Section 2.2.2.5 to read as follows:

2.2.2.5 Elevators with sprinklers in the hoistway shall be provided with a drain or sump pump. The sump pump/drain shall have the capacity to remove a minimum of 11.4 m³/h (3,000 gal/h) per elevator.

2.2.4 Pit access.

Add new Subsection (f) to Section 2.2.4.5 to read as follows:

2.2.4.5 Separate pit access door, when provided, shall be subject to the following requirements:

(f) Pit doors shall be labeled “DANGER, ELEVATOR PIT” with letters not less than 51 mm (2 in.) high.

SECTION 2.5
HORIZONTAL CAR AND COUNTERWEIGHT CLEARANCES

2.5.1 Clearances between cars, counterweights, and hoistway enclosures.

Delete and revise Section 2.5.1.3 to read as follows:

2.5.1.3 Between cars in multiple hoistways. The running clearance between the cars and any equipment attached thereto, of elevators operating in a multiple hoistway, shall be not less than 50 mm (2 in.). Where the clearance between elevators exceeds 762 mm (30 in), emergency access doors shall be provided for each elevator and shall conform with Sections 2.11.1.1 and 2.11.1.2.

SECTION 2.7
MACHINERY SPACES, MACHINE ROOMS, CONTROL SPACES, AND CONTROL ROOMS

2.7.2 Maintenance path and clearance.

Delete and revise Section 2.7.2.4.1 to read as follows:

2.7.2.4.1 Where a space is intended to be accessed with full bodily entry, then the requirements of Section 2.7.2.3 shall apply. When the machine space is inside the hoistway, the following shall apply:

- (a) All components of driving machines, motors, brakes and governors shall be installed within 915 mm (36 inches) horizontally from the inside edge of the car top railing, or from the edge of the car top, if a car top railing is not required by Section 2.14.1.7.1.
- (b) The top of all components of driving machines, motors, brakes and governors shall be located no more than a maximum of 1825 mm (72 inches) vertically above the car enclosure top working surface when components are located outside the standard railing or car top perimeter, and within 1980 mm (78 inches) vertically when the components are located within the standard railing or car top perimeter.
- (c) The maximum vertical dimensions shall be measured from the car top working surface when the car has been moved as per Subsection 2.26.1.4.2(g) and the locking means required by Subsections 2.7.5.1.1 and 2.7.5.1.2(c) has been engaged.

2.7.3 Access to machinery spaces, machine rooms, control spaces, and control rooms.

Add new Subsection (d) to Section 2.7.3.1.1 to read as follows:

2.7.3.1.1 A permanent and unobstructed means of access shall be provided to:

- (d) A control space for elevators must only be located where working clearances required for the control space will not impede upon the path of travel in unrestricted areas. Where the elevator control space is located in a path of travel in an unrestricted area, a clear path of travel parallel to the control space must not be less than the required working clearance plus 1219 mm (48 in) perpendicular to the control space. A permanent barricade is needed to establish the working clearances for the control space and must be accessible to elevator personnel from the control space. The barricade must be deployed whenever the doors to the control space are in the open position. (See figure Q-2.)

Fig. Q-2

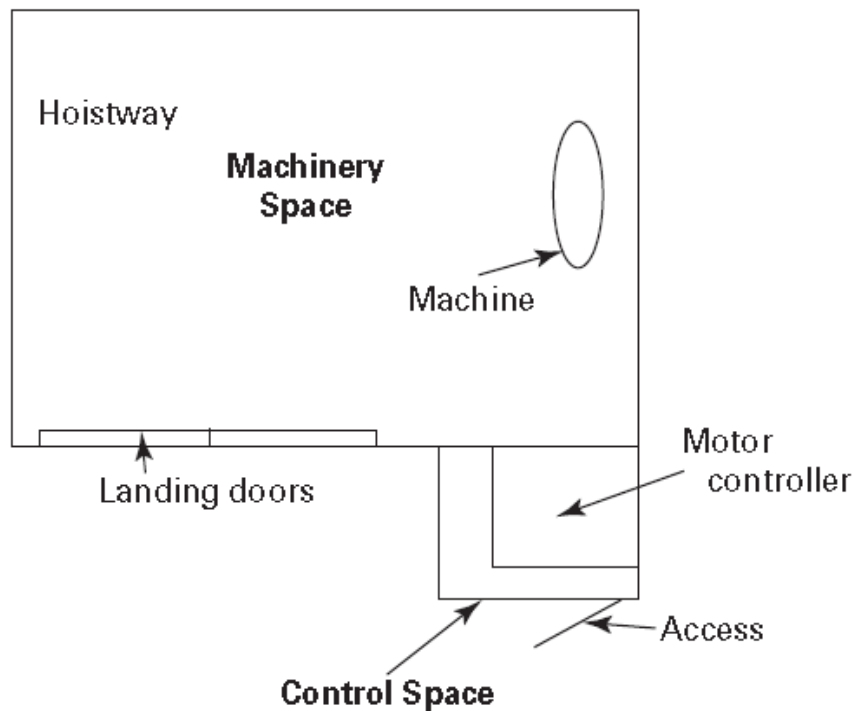

Add new Subsection (d) to Section 2.7.3.4.1 to read as follows:

2.7.3.4.1 Access doors shall be

(d) labeled “ELEVATOR EQUIPMENT” with letters not less than 51 mm (2 in.) high.

Delete and revise Section 2.7.3.4.2 to read as follows:

2.7.3.4.2 Access doors to machine rooms, control rooms and control spaces shall be provided. They shall be of a minimum width of 750 mm (29.5 in.) and a minimum height of 2 030 mm (80 in.). Keys to unlock the access doors shall be Group 2 Security (see 8.1).

Add new Subsection (d) to Section 2.7.3.4.7 to read as follows:

2.7.3.4.7 Access openings in elevator hoistway enclosures where full bodily entry is not necessary for maintenance and inspection of components shall be

(d) labeled “DANGER: ELEVATOR HOISTWAY” with letters not less than 51 mm (2 in.) high and have an electrical safety switch that will remove power from the hoist machine and brake if the door is opened.

2.7.6 Location of machinery spaces, machine rooms, control spaces, control rooms, and equipment.

Delete and revise Section 2.7.6.3.1 to read as follows:

2.7.6.3.1 The electric driving machine shall be located in a machinery space or machine room. When the driving machine is located inside the hoistway

- (a) an access door conforming to the requirements of Sections 2.7.3.3 and 2.7.3.4 shall be provided for visual observation of the driving machine motor and brake(s).
- (b) landing inspection operation in accordance with Section 2.26.1.4.4 shall be provided at the access door and shall be permitted to be within the frame of the door. The machine and brake must be visible to the operator.

Delete and revise Section 2.7.6.3.2 to read as follows:

2.7.6.3.2 The motor controller shall be located in a machine room, control space, or control room.

NOTE: For electrical clearance requirements, see NFPA 70 or CSA-C22.1, whichever is applicable (see Part 9).

Delete and revise Section 2.7.6.3.4 to read as follows:

2.7.6.3.4 Where a governor is located inside the hoistway, means of access conforming to the requirements of Sections 2.7.3.3 and 2.7.3.4 for inspection and servicing the governor shall be provided from outside the hoistway. This access door is permitted to be the same as the door required by Section 2.7.6.3.1, provided that visual observation of the governor is possible.

Delete and revise Section 2.7.6.4 to read as follows:

2.7.6.4 Means necessary for tests. Where an elevator driving-machine brake or an emergency brake is located in the hoistway or pit, means necessary for tests that require movement of the car or release of the driving-machine brake or emergency brake shall be provided in the machine room, control room, or control space and arranged so that they can be operated from outside the hoistway and shall conform to Sections 2.7.6.4.1 through 2.7.6.4.3. These means are also permitted to be used by elevator personnel for passenger rescue.

Delete and revise the first sentence of Section 2.7.6.4.3 to read as follows:

2.7.6.4.3 A means to move the car from outside the hoistway shall be provided in the control room, control space, or machine room and it shall conform to the following:

2.7.8 Remote machine rooms and control rooms.

Delete and revise Section 2.7.8.4 to read as follows:

2.7.8.4 A permanent means of communication shall be provided between the elevator car, remote machine room and/or control room/control space, and the lobby fire command station (where required or provided).

SECTION 2.8
EQUIPMENT IN HOISTWAYS, MACHINERY SPACES, MACHINE ROOMS,
CONTROL SPACES, AND CONTROL ROOMS

2.8.3 Pipes, ducts, tanks, and sprinklers.

Delete and revise Section 2.8.3.3 to read as follows:

2.8.3.3 Sprinkler systems conforming to NFPA 13 shall be permitted to be installed in the hoistway, subject to Sections 2.8.3.3.1 through 2.8.3.3.4.

Delete and revise Section 2.8.3.3.2 to read as follows:

2.8.3.3.2 Where elevator equipment is located or its enclosure is configured such that application of water from sprinklers could cause unsafe elevator operation, means shall be provided to automatically disconnect the main line power supply to the affected elevator and any other power supplies used to move the elevator upon or prior to the application of water.

(a) This means shall be independent of the elevator control and shall not be self-resetting.

(b) Heat detectors and sprinkler flow switches used to initiate main line elevator power shutdown shall comply with the requirements of NFPA 72.

(c) The activation of sprinklers outside of such locations shall not disconnect the main line elevator power supply. See also Section 2.27.3.3.6.

Delete and revise the first sentence of Section 2.8.3.3.4 to read as follows:

2.8.3.3.4 When sprinklers are installed not more than 600 mm (24 in.) above the pit floor, Subsections 2.8.3.3.4(a) and (b) apply to elevator electrical equipment and wiring in the hoistway located less than 1 200 mm (48 in.) above the pit floor, except earthquake protective devices conforming to Subsection 8.4.10.1.2(d); and on the exterior of the car at the point where the car platform sill and the lowest landing hoistway door sill are in vertical alignment.

SECTION 2.11
PROTECTION OF HOISTWAY OPENINGS

2.11.1 Entrances and emergency doors required.

Delete and revise Section 2.11.1.1 to read as follows:

2.11.1.1 Hoistway landing entrances. All elevator hoistway landing openings shall be provided with entrances that shall guard the full height and width of the openings. Entrances shall be at least 2 030 mm (80 in.) in height and 915 mm (36 in.) in width.

Delete and revise Subsection (a) of Section 2.11.1.2 to read as follows:

2.11.1.2 Emergency doors in blind hoistways. Where an elevator is installed in a single blind hoistway, there shall be installed in the blind portion of the hoistway an emergency door at every third floor, but not more than 11 m (36 ft) from sill to sill, conforming to the following:

(a) The clear opening shall be at least 915 mm (36 in.) wide and 2 030 mm (80 in.) high.

2.11.2 Types of entrances.

Delete and revise Section 2.11.2.1 to read as follows:

2.11.2.1 Passenger elevators. For passenger elevators, entrances shall be one of the following types:

(a) horizontally sliding

(b) horizontally swinging, single-section

(c) hand- or power-operated vertically sliding that slide up to open

2.11.7 Glass in hoistway doors.

Delete and revise Sections 2.11.7.1 and 2.11.7.1.1 to read as follows:

2.11.7.1 Vision panels. For elevators with automatic or continuous-pressure operation, manually operated or self-closing hoistway doors of the vertically or horizontally sliding type must be provided with a vision panel. In multisection doors, the vision panel is required in one section only, but is permitted to be placed in all sections. All horizontally swinging elevator doors must be provided with vision panels. Vision panels are permitted for any type of hoistway door. Vision panels are not required at the landing of automatic operation elevators equipped with horizontally sliding car and hoistway doors. Where required or used, vision panels must conform to Sections 2.11.7.1.1 through 2.11.7.1.7.

2.11.7.1.1 The area of any single vision panel must not be less than 0.008 m² (12 in²), and the total area of one or more panels in any hoistway door must not be more than .026 m² (40 in²).

2.11.11 Entrances, horizontal slide type.

Delete and revise Subsection (a) of Section 2.11.11.6 to read as follows:

2.11.11.6 Bottom guides. Bottom guides shall conform to the following:

(a) The bottom of each panel shall be guided by two or more members.

2.11.14 Fire tests.

Delete and revise Section 2.11.14.1 to read as follows:

2.11.14.1 Reserved.

Delete and revise Section 2.11.14.2 to read as follows:

2.11.14.2 Sections 2.11.15 through 2.11.18, and 2.11.14.2.1 through 2.11.14.2.3 apply where fire-resistive construction is required by 2.1.1.1.3.

2.11.15 Marking.

Delete and revise Section 2.11.15.1 to read as follows:

2.11.15.1 Labeling of tested entrance assembly. A single label listing covered components included per Section 2.11.15.1.1, or separate labels on all individual components per Section 2.11.15.1.2 shall be provided. Where required by the New York City Building Code, the entire entrance assembly must be of an approved type.

Delete and revise Section 2.11.15.2 to read as follows:

2.11.15.2 Other entrance assemblies. Other entrance assemblies of the three basic types (see Section 2.11.14) shall qualify for labeling or listing/certification:

(a) when composed of panel(s), frame, and hardware of the same type as tested and not exceeding the overall height and width of any panel and frame of the largest size tested; or

(b) when such panel(s), frame, and hardware are modified, and test or technical data demonstrates that the modifications will meet the performance requirements of the test procedure in Section 8.3.3.

All other elements of the assembly shall conform to all other applicable requirements of this Code.

Delete and revise Section 2.11.15.3 to read as follows:

2.11.15.3 Entrances larger than tested assemblies. When the entrance is too large for the regularly available test facilities, the certifying organization shall be permitted to issue oversize certificates or oversize labels, or such entrances shall be permitted to be used subject to approval by the commissioner.

2.11.16 Factory inspections.

Delete and revise Section 2.11.16 to read as follows:

2.11.16 Factory inspections.

The manufacturing facilities for the production of entrances or components thereof shall be inspected by the certifying organization at random at least quarterly, or if they are not manufactured on a continuous basis, at the time they are being produced, to assure that production methods are such that entrances or components thereof similar to those tested are being produced.

2.11.17 Transoms and fixed side panels.

Delete and revise the opening paragraph of Section 2.11.17 to read as follows:

2.11.17 Transoms and fixed side panels.

Transoms and fixed side panels shall be permitted to close openings above and beside the horizontally sliding or horizontally swinging type entrances, provided that

2.11.18 Installation instructions.

Delete and revise Section 2.11.18 to read as follows:

2.11.18 Installation instructions.

(a) Instructions detailing the application and installation of door listed/certified panels and entrance hardware shall be provided.

(b) Where frames are used, instructions detailing the listed/certified frame-to-wall interface shall be provided.

2.11.19 Gasketing of hoistway entrances.

Delete and revise the first sentence of Section 2.11.19.4 to read as follows:

2.11.19.4 Labeled gasketing material shall conform to Section 2.11.16.

SECTION 2.12
HOISTWAY DOOR LOCKING DEVICES AND ELECTRIC CONTACTS, AND
HOISTWAY ACCESS SWITCHES

2.12.3 Hoistway door combination mechanical locks and electric contacts.

Delete Section 2.12.3 in its entirety.

2.12.4 Listing/certification door locking devices and door or gate electric contacts.

Delete and revise Section 2.12.4.1 to read as follows:

2.12.4.1 Type tests. Each type and make of hoistway-door interlock, electric contact, and door or gate electric contact must be of an approved type. Hoistway-door combination mechanical locks and electrical contacts are not permitted.

2.12.7 Hoistway access switches.

Delete and revise Subsection (b) of Section 2.12.7.3.3 to read as follows:

2.12.7.3.3 The operation of a hoistway access switch at the landing shall permit movement of the car with the hoistway door located adjacent to the switch at the landing unlocked or not in the closed position, and with only the car door or gate associated with this hoistway door unlocked or not in the closed position, subject to the following requirements:

(b) The car shall not be operated at a speed greater than 0.35 m/s (75 ft/min). For elevators with static control, a means independent from the normal means to control the speed shall be provided to limit the speed of the car on hoistway access operation to a maximum of 0.35 m/s (75 ft/min), should the normal means to control this speed (mechanical, electrical, or solid-state devices) fail to do so.

The car speed-sensing device used for the means to limit the speed of the car while operating in response to an access switch shall be permitted to be either a separate car speed-sensing device from that of the normal speed control system or the same car speed-sensing device, provided that a separate means is used to continuously verify the proper operation of this speed-sensing device. Where the same car speed-sensing device is used, the detection of a failure of this car speed-sensing device while operating in response to an access switch shall cause the power to be removed from the driving machine motor and brake.

The car speed-sensing device(s) and, where required, the verification means described above, shall conform to the following:

(1) a common actuating means (e.g., a driving-machine shaft, brake drum, etc.) shall be permitted provided that it is not dependent on the following connection types, unless the connection is continuously monitored:

(a) traction (excluding the traction between the drive sheave and suspension means and the traction between the governor and governor rope)

(b) friction (except for interference fits), or

(c) a flexible coupling where positive engagement is not assured between coupling halves.

Where monitoring is required, the monitoring shall detect a failure that prevents conformance with this requirement while operating in response to an access switch and shall cause the electric power to be removed from the elevator driving-machine motor and brake.

(2) a common member (e.g., tape, target, wire, etc.) that is sensed by both speed-sensing devices shall be permitted, provided that

(a) the member is monitored such that when its presence is not detected while operating in response to an access switch, this shall cause the electric power to be removed from the elevator driving-machine motor and brake

(b) the common member is securely mounted in such a manner that horizontal movement of the car shall not affect the operation of the sensors

(3) a common mounting means shall be permitted

SECTION 2.13
POWER OPERATION OF HOISTWAY DOORS AND CAR DOORS

2.13.2 Power opening.

Delete and revise Section 2.13.2.1.2 to read as follows:

2.13.2.1.2 Collapsible car gates shall not be power opened.

SECTION 2.14
CAR ENCLOSURES, CAR DOORS AND GATES, AND CAR ILLUMINATION

2.14.1 Passenger and freight enclosures, general.

Delete and revise Section 2.14.1.5.1 to read as follows:

2.14.1.5.1 Top emergency exits shall conform to the following requirements:

- (a) The top emergency exit opening shall have an area of not less than 0.26 m² (400 in.²) and shall measure not less than 508 mm (20 in.) on any side.
- (b) Where the distance between the platform and the top of car escape hatch is 2 743 mm (9 ft.) or greater, the emergency exit opening shall measure not less than 0.37 m² (576 in.²) and shall measure not less than 600 mm (24 in) on any side.
- (c) During an alteration involving installation of a new car enclosure, the top emergency exit opening shall have an area of not less than 0.26 m² (400 in.²) and shall measure not less than 400 mm (16 in.) on any one side where prevailing conditions prevent any increase in opening size.
- (d) The top emergency exit and suspended ceiling opening, if any, shall be so located as to provide a clear passageway, unobstructed by fixed equipment located in or on top of the car. Equipment is permitted directly above the exit opening, provided that
 - (1) it is not less than 1 070 mm (42 in.) above the top of the car; or
 - (2) the exit is located to allow unobstructed passage of a parallelepiped volume measuring 300 mm by 500 mm by 1 500 mm (12 in. by 20 in. by 59 in.) at an angle not less than 60 deg from the horizontal (see Nonmandatory Appendix C).
- (e) The top emergency exit cover shall open outward. It shall be securely attached with a chain when in both the open and closed positions. Hinges are not permitted. The chain shall be not more than 300 mm (12 in.) in length and have a factor of safety of not less than 5. The exit cover shall only be openable from the top of the car, where it shall be openable without the use of special tools. The exit cover of the lower compartment of a multideck elevator shall be openable from both compartments. On elevators with two compartments, if the emergency exit of the lower compartment does not open directly

into the upper compartment, a guarded passageway shall be provided between the lower compartment roof and the upper compartment floor.

(f) The movable portion (exit panel) of the suspended ceiling that is below the top exit opening shall be restrained from falling. It shall not be permitted to be hinged and shall provide a clear opening with the top exit opening.

(1) The movable portion of the suspended ceiling shall measure no less than 600 mm (24 in.) by 600 mm (24 in.).

(2) Where the distance between the platform and the top of car exit is greater than 2 743 mm (9 ft.), the movable portion of the suspended ceiling shall measure no less than 710 mm (28 in.) by 710 mm (28 in.).

(3) The movable portion and the fixed portion of a suspended ceiling shall not contain lamps that could be shattered by the rescue operation using the top emergency exit. The movable portion of the suspended ceiling shall be permitted to contain light fixtures connected to the stationary portion of the suspended ceiling wiring by means of a plug and socket or by flexible armored wiring. Flexible wiring shall not be used to support or restrain the exit opening in the suspended ceiling in the open position.

(g) Where elevators installed in enclosed hoistways are provided with special car top treatments such as domed or shrouded canopies, the exit shall be made accessible, including the car top refuge space as specified in 2.4.12.

(h) Immediately adjacent to the top emergency exit there shall be a space available for standing when the emergency exit cover is open. This space shall be permitted to include a portion of the refuge area (see Section 2.4.12). All exit covers shall be provided with a car top emergency exit electrical device (see Section 2.26.2.18) that will prevent operation of the elevator car if the exit cover is open more than 50 mm (2 in.), and the device shall be so designed that it

(1) is positively opened

(2) cannot be closed accidentally when the cover is removed

(3) must be manually reset from the top of the car and only after the cover is within 50 mm (2 in.) of the fully closed position

(4) shall be protected against mechanical damage

2.14.2 Passenger-car enclosures.

Delete and revise Section 2.14.2.1.1 to read as follows:

2.14.2.1.1

(a) materials in their end-use configuration, other than those covered by Subsections 2.14.2.1.1(b) and (c), 2.14.2.1.3, and 2.14.2.1.4, shall conform to the following requirements, based on the tests conducted in accordance with the requirements of ASTM E84, ANSI/UL 723, NFPA 255, or CAN/ULC-S102:

(1) flame spread rating of 0 to 50

(2) smoke development of 0 to 100

(b) napped, tufted, woven, looped, and similar materials in their end-use configuration on car enclosure walls shall conform to Section 8.3.7. The enclosure walls to which this material is attached shall conform to Subsection 2.14.2.1.1(a).

(c) floor covering, underlayment, and its adhesive shall have a critical radiant flux of not less than 0.45 W/cm², as measured by ASTM E648.

Delete and revise Section 2.14.2.1.2 to read as follows:

2.14.2.1.2 Reserved.

Delete and revise Section 2.14.2.5 to read as follows:

2.14.2.5 Vision panels. Vision panels are not required, but where used, shall meet the following requirements:

(a) Be of a total area of not more than 0.047 m² (72 in²) and contain no single glass panel having a width exceeding 101 mm (4 in.);

(b) Hoistway door vision panels must be protected by protective grills made of number sixteen (16) gauge stainless or galvanized steel in accordance with the following specifications:

(1) Grills shall be sized to fit within or over the vision panel frame and completely cover the vision panel opening in the elevator, car doors and hoistway doors.

(2) Grills and vision panel frames shall be secured by means of non-reversible screws or other tamper proof fasteners.

(3) Grills shall contain openings that shall not be larger than 19 mm (0.75 in.) in diameter.

(4) All cut edges shall be deburred.

(5) Requirements for such grills may be waived if certification is submitted that such elevator is operated manually or twenty-four (24) hour doorman service is provided. A security guard shall not be considered doorman service.

(6) For the purpose of this subsection (b), a vandal resistant 6 mm (0.25 in.) polycarbonate sheet, such as Lexan, in two (2) layers, one (1) on each side of the required wire glass, may be used in lieu of the metal protective.

2.14.4 Passenger and freight car doors and gates, general requirements.

Delete and revise Section 2.14.4.11 to read as follows:

2.14.4.11 Closed position of car doors or gates. Car doors or gates shall be considered to be in the closed position under the following conditions:

(a) for horizontally sliding doors or gates, when the clear open space between the leading edge of the door or gate and the nearest face of the jamb does not exceed 25 mm (1 in.) except where car doors are provided with a car door interlock(s), 10 mm (0.375 in.)

(b) for vertically sliding counterweighted doors or gates, when the clear open space between the leading edge of the door or gate and the car platform sill does not exceed 25 mm (1 in.)

(c) for horizontally sliding center-opening doors, or vertically sliding biparting counterbalanced doors, when the door panels are within 25 mm (1 in.) of contact with each other, except where horizontally sliding center-opening car doors are provided with a car door interlock(s), 10 mm (0.375 in.)

2.14.5.10 Folding Car Doors

Section 2.14.5.10 is renumbered Section 2.14.6.4.

2.14.7 Illumination of cars and lighting fixtures.

Delete and revise Section 2.14.7.1.4 to read as follows:

2.14.7.1.4 Each elevator shall be provided with lighting and a duplex receptacle fixture on the car top and under the car platform. The lighting shall be permanently connected, fixed, or portable, or a combination thereof, to provide an illumination level of not less than 100 lx (10 fc) measured at the point of any elevator part or equipment, where maintenance or inspection is to be performed from the car top or under the car platform. All lighting shall be equipped with guards. The light switch shall be accessible from the landing when accessing the car top or under the car platform.

SECTION 2.15 **CAR FRAMES AND PLATFORMS**

2.15.8 Protection of platforms against fire.

Delete and revise Section 2.15.8 to read as follows:

2.15.8 Protection of platforms against fire.

Exposed wood shall not be used on Fire Service Access Elevators and Occupant Evacuation Elevators. All platform materials exposed to the hoistway shall be either of the following:

(a) metal

(b) other materials that, in their end-use configuration, conform to the following requirements, based on the tests conducted in accordance with the requirements of ASTM E84, UL 723, NFPA 255, or CAN/ULC-S102.2, whichever is applicable (see Part 9):

(1) flame spread rating of 0 to 50

(2) smoke development of 0 to 100

SECTION 2.16 **CAPACITY AND LOADING**

2.16.1 Minimum rated load for passenger elevators.

Delete and revise Section 2.16.1.3 to read as follows:

2.16.1.3 Carrying of freight on passenger elevators. When freight is to be carried on a passenger elevator, the requirements of Sections 2.16.1.3.1, 2.16.1.3.2 and 2.16.1.3.3 shall be conformed to.

2.16.1.3.1 The minimum rated load shall conform to Sections 2.16.1 or 2.16.2, whichever is greater.

2.16.1.3.2 The elevator shall be designed for applicable class of freight elevator loading.

2.16.1.3.3 Nonpermanent freight-handling equipment (Section 2.14.1.9.1), and freight materials, shall be removed when the elevator is used for passenger service.

2.16.3 Capacity and data plates.

Delete and revise Section 2.16.3.2.1 to read as follows:

2.16.3.2.1 Capacity plates must indicate the rated load of the elevator in pounds or kilograms and pounds (see Appendix D). In addition, this plate or a separate plate shall indicate

(a) the capacity lifting one-piece loads where the elevator conforms to Section 2.16.7

(b) for freight elevators designed for Class C2 loading, the maximum load the elevator is designed to support while being loaded or unloaded (see Subsection 2.16.2.2.4(c)), and

(c) calculated per Appendix D, the number of persons on passenger elevators and freight elevators permitted by Section 2.16.4 to carry passengers.

Add new Subsection (f) to Section 2.16.3.2.2 to read as follows:

2.16.3.2.2 Data plates shall indicate

(f) the weight required for balanced load.

Add new Section 2.16.10 to read as follows:

2.16.10 Detection of overload on passenger elevators and freight elevators permitted by Section 2.16.4 to carry passengers.

Passenger elevators and freight elevators permitted by Section 2.16.4 to carry passengers must be designed with the means to detect if the load exceeds the rated capacity of the elevator. If an overload is detected, the elevator doors must reopen and remain open and a voice notification and visual signal must indicate that the car is overloaded.

SECTION 2.18
SPEED GOVERNORS

2.18.1 Speed governors required and location.

Delete and revise Section 2.18.4.1.3 to read as follows:

2.18.4.1.3 The switches required in Section 2.18.4.1.1 shall remain in the open position until manually reset. Manual reset is defined here as personal intervention by elevator personnel at the governor and can include means such as a finger, hand or cable-actuated lever, or some form of electromechanical actuation from the access door specified in Section 2.7.6.3.4.

Add new Subsection (c) and Note to Section 2.18.4.2.5 to read as follows:

2.18.4.2.5 The speed-governor overspeed switch shall be permitted to open in the down direction of the elevator at not more than 100% of the speed at which the governor is set to trip in the down direction, subject to the following requirements:

(c) An access door is required when the governor is installed at the top of the hoistway for access to reset switches by elevator personnel. The access door must comply with Section 2.7.3.4.6.

NOTE: Manual reset is defined here as personal intervention by elevator personnel at the governor.

SECTION 2.20
SUSPENSION MEANS AND THEIR CONNECTIONS

2.20.1 Suspension means.

Delete and revise Section 2.20.1 to read as follows:

2.20.1 Suspension means.

Elevator cars and counterweights shall be suspended by steel wire ropes, or noncircular elastomeric-coated steel suspension members attached to the car frame or passing around sheaves attached to the car frame specified in Section 2.15.1. Suspension means that have previously been installed and used on another installation shall not be reused. All suspension members in a set of suspension means shall be the same material, grade, construction, and

dimensions. A suitable means shall be provided to protect the suspension means during the installation process.

Only the following shall be permitted:

(a) steel wire ropes constructed in accordance with ASME A17.6, Part 1

(b) noncircular elastomeric-coated steel suspension members constructed in accordance with ASME A17.6, Part 3

2.20.2 Suspension-means data.

Delete and revise Subsection (a) of Section 2.20.2.2.2 to read as follows:

2.20.2.2.2 The following data shall be provided:

(a) type of suspension (steel wire rope or noncircular elastomeric-coated steel suspension member)

2.20.4 Minimum number and diameter of suspension means.

Delete Section 2.20.4.2 in its entirety.

Section 2.20.4.3 is renumbered to Section 2.20.4.2.

2.20.9 Suspension-member fastening.

Delete and revise Section 2.20.9.5 to read as follows:

2.20.9.5 Wedge rope sockets. The use of wedge rope socket assemblies shall be permitted only for steel wire ropes. When used, the wedge rope socket assemblies shall be of a design as shown in Fig. 2.20.9.5 and shall conform to Sections 2.20.9.2, 2.20.9.3, and 2.20.9.5.1 through 2.20.9.5.7. Socket and wedge surfaces that contact the rope shall be free of burrs or sharp edges that could damage the rope. Wedge rope sockets are not permitted on counterweighted winding drum machines.

Delete Section 2.20.9.5.5 in its entirety.

Section 2.20.9.5.6 is renumbered to Section 20.9.5.5.

Section 2.20.9.5.7 is renumbered to Section 20.9.5.6.

SECTION 2.21 **COUNTERWEIGHTS**

2.21.1 General requirements.

Add new Section 2.21.1.2.1 to read as follows:

2.21.1.2.1 Weight section material. Weight section material shall be steel, iron or lead only and shall have a minimum melting temperature of 620°F (327°C).

SECTION 2.22 **BUFFERS AND BUMPERS**

2.22.4 Oil buffers.

Delete and revise Section 2.22.4.6 to read as follows:

2.22.4.6 Means for determining oil level. Oil buffers shall be provided with means for determining that the oil level is within the maximum and minimum allowable limits. Transparent sight gauges shall be permitted to be used provided they meet the requirements for the purpose in accordance with good engineering practice. They shall resist shock loading on the buffer or pressure rise as a result of impact, and not be stained by the presence of buffer oil or a means shall be provided to ensure that any staining does not affect the reading of the oil level.

- (a) A fixed inclined ladder shall be provided where the top of the buffer cylinder is over 1 524 mm (5 ft.) in height above the pit floor.
- (b) A fixed vertical or inclined ladder fitted with an inspection and maintenance platform with guard rails shall be provided where the top of the car buffer cylinder is over 2 134 mm (7 ft.) from the pit floor.

SECTION 2.24 **DRIVING MACHINES AND SHEAVES**

2.24.2 Sheaves and drums.

Delete and revise Section 2.24.2.1.1 to read as follows:

2.24.2.1.1 Sheaves. Driving-machine sheaves shall be integral with or directly attached to driving machine shafts. Sheaves shall be provided with steel shafts and metal bearings. Non-metallic sheaves are not permitted.

Delete Section 2.24.2.3.2 in its entirety.

Section 2.24.2.3.3 is renumbered to 2.24.2.3.2.

Section 2.24.2.3.4 is renumbered to 2.24.2.3.3.

2.24.10 Means for inspection of gears.

Delete and revise Section 2.24.10 to read as follows:

2.24.10 Means for inspection of gears.

Each gear case of geared machines shall have access to permit inspection of the contact surfaces of the gears.

SECTION 2.25
TERMINAL STOPPING DEVICES

2.25.3 Final terminal stopping devices.

Add new Subsection (d) to Section 2.25.3.1 to read as follows:

2.25.3.1 General requirements. Final terminal stopping devices shall conform to Section 2.25.1 and the following:

(d) Final limit switches and bracket shall be permanently secured and pinned.

Delete and revise Section 2.25.3.3.1 to read as follows:

2.25.3.3.1 Traction machine elevators shall have final terminal-stopping switches located in the hoistway and operated by cams attached to the car.

SECTION 2.26
OPERATING DEVICES AND CONTROL EQUIPMENT

2.26.1 Operation and operating devices.

Add new Items 3 and 4 to Subsection (c) of Section 2.26.1.4.1 to read as follows:

2.26.1.4.1 General requirements.

(c) Inspection operating devices shall

(3) be provided with a separate device of the continuous-pressure type labeled “ENABLE”, adjacent to the inspection operating devices; and

(4) become effective only when the “ENABLE” device is activated.

Add new Item 3 to Subsection (e) of Section 2.26.1.4.2 to read as follows:

2.26.1.4.2 Top-of-car inspection operation. Top-of-car inspection operation shall conform to Section 2.26.1.4.1 and the following:

(e) The inspection operating devices (see Subsection 2.26.1.4.1(c)) shall be permitted to be of the portable type, provided that

(3) when the machine is located in the hoistway, inspection operating devices shall be of the portable type.

Delete and revise Subsection (g) of Section 2.26.1.4.2 to read as follows:

(g) When in top-of-car inspection operation, a separate additional device shall be permitted to render ineffective the top final terminal stopping device, and the buffer switch for gas spring-return counterweight oil buffers, in conformance with the requirements of Subsections

2.26.4.3, 2.26.9.3.1(a), 2.26.9.3.2, and 2.26.9.4, and it shall allow the car to be moved to a position in conformance with the requirements of Subsections 2.7.4.5 and 2.7.5.1.3(c). When operating in the up direction with these devices rendered ineffective, the elevator shall stop when it reaches its maximum upward movement and shall be able to travel in the down direction without the need for any devices to be manually reset.

2.26.2 Electrical protective devices.

Delete and revise Section 2.26.2.5 to read as follows:

2.26.2.5 Emergency stop switch. On all elevators, an emergency stop switch must be provided in the car, and located in or adjacent to each car operating panel. When open (“STOP” position), this switch must cause the electric power to be removed from the elevator driving-machine motor and brake. Emergency stop switches must:

- (a) Be of the manually opened and closed type;
- (b) Have red operating handles or buttons;
- (c) Be conspicuously and permanently marked “STOP” and must indicate the “STOP” and “RUN” positions; and
- (d) While opened, cause the audible device to sound (see Section 2.27.1.2).

Delete and revise Section 2.26.2.21 to read as follows:

2.26.2.21 Reserved.

Delete Section 2.26.2.33 in its entirety.

2.26.5 System to monitor and prevent automatic operation of the elevator with faulty door contact circuits.

Add new Exception to Section 2.26.5 to read as follows:

EXCEPTION: When operating on Firefighters’ Service Phase II, item (b)(2) shall not be permitted.

2.26.6 Phase protection of motors.

Delete and revise Section 2.26.6 to read as follows:

2.26.6 Phase protection of motors.

Elevators having a polyphase AC power supply shall be provided with means to prevent the operation of the elevator drive motor or door motor if a reversal of phase rotation, or phase failure of the incoming polyphase AC power, will cause the elevator car or elevator door(s) to operate in the wrong direction.

SECTION 2.27
EMERGENCY OPERATION AND SIGNALING DEVICES

Add new Note to the header of Section 2.27 to read as follows:

NOTE: Additional requirements, including those for firefighters' communications systems, Fire Service Access Elevators (see Section 2.27.10) and Occupant Evacuation Operation (see Section 2.27.11), may be found in the building code.

2.27.1 Car emergency signaling devices.

Delete and revise Section 2.27.1.1 to read as follows:

2.27.1.1 Emergency communications. The two-way communications shall conform to 2.27.1.1.1 through 2.27.1.1.6.

2.27.1.1.1 A communications means between the car and a location staffed by authorized personnel who can take appropriate action shall be provided.

2.27.1.1.2

(a) Two-way voice communication shall be provided between the elevator car and elevator machine room, and/or control room.

(b) If the call is not acknowledged [Subsection 2.27.1.1.3(c)] within 45 s, the call shall be automatically directed to an alternate on- or off-site location.

2.27.1.1.3 The permanent two-way communication means within the car shall comply with the following requirements:

(a) ICC/ANSI A117.1.

(b) A push button to actuate the two-way communication means shall be provided in or adjacent to a car operating panel. The push button shall be visible and permanently identified with the "PHONE" symbol (see Section 2.26.12.1). The identification shall be on or adjacent to the "PHONE" push button. The communications means shall be initiated when the push button is actuated.

(c) On the same panel as the "PHONE" push button, a message shall be displayed that is activated by authorized personnel to acknowledge that communications are established. The message shall be permitted to be extinguished where necessary to display a new message [see Subsections 2.27.1.1.3(d) and 2.27.1.1.3(e)] or when the communications are terminated.

(d) On the same panel as the "PHONE" push button, messages shall be displayed which permit authorized personnel to communicate with and obtain responses from a trapped passenger(s) including a passenger(s) who cannot verbally communicate or cannot hear.

- (e) On the same panel as the “PHONE” push button, a message shall be displayed that is activated by authorized personnel to indicate when help is on the way. The message shall continue to be displayed until a new message is displayed [see Subsection 2.27.1.1.4(c)] or the communication is terminated.
- (f) The communications means shall provide on demand to authorized personnel, information that identifies the building location and elevator number.
- (g) The communications, once established, shall be disconnected only when authorized personnel terminate the call or a timed termination occurs. A timed termination by the communications means in the elevator, with the ability to extend the call by authorized personnel, is permitted if voice notification is sent by the communications means to authorized personnel a minimum of 3 min after communication has been established. Upon notification, authorized personnel shall have the ability to extend the call; automatic disconnection shall be permitted if the means to extend are not enacted within 20 s of the voice notification.
- (h) The communications means shall not use a handset in the car.
- (i) The communications shall not be transmitted to an automated answering system. The call shall be answered by authorized personnel.
- (j) Operating instructions shall be incorporated with or adjacent to the “PHONE” push button.
- (k) A means to display video to observe passengers at any location on the car floor, to authorized personnel for entrapment assessment, shall be provided.

2.27.1.1.4 Where the elevator rise is 18 m (60 ft) or more, a permanent two-way voice communication means within the building accessible to emergency personnel shall be provided at the designated level, and shall comply with the following requirements:

- (a) The means shall enable emergency personnel within the building to establish communications to each car individually. The communications shall be established without any intentional delay and shall not require intervention by a person within the car. The means shall override voice communications to outside of the building.
- (b) The communications, once established, shall be disconnected only when emergency personnel outside the car terminates the call or a timed termination occurs. A timed termination by the communications means in the elevator, with the ability to extend the call by emergency personnel, is permitted if voice notification is sent by the communications means to emergency personnel a minimum of 3 min after communication has been established. Upon notification, emergency personnel shall have the ability to extend the call; automatic disconnection shall be permitted if the means to extend are not enacted within 20 s of the voice notification.
- (c) Once the communications have been established, a message shall be displayed on the same panel as the “PHONE” push button, that is activated by emergency

personnel, to indicate that help is on site. The message shall be permitted to be extinguished where necessary to display a new message [see Subsection 2.27.1.1.4(e)] or when the communications are terminated.

(d) Operating instructions shall be incorporated with or adjacent to the communications outside the car. Instructions shall conform to Section 2.27.7.3.

(e) On the same panel as the “PHONE” push button, messages shall be displayed that permit emergency personnel to communicate with and obtain responses from a trapped passenger including a passenger who cannot verbally communicate or cannot hear. If the means of communication is behind a locked panel, it shall be accessible with the New York City Fire Department standard and New York City standard keys.

(f) A means to display video to observe passengers at any location on the car floor to emergency personnel for entrapment assessment shall be provided. The communications system shall be located within the fire command center where one is provided.

2.27.1.1.5 If the two-way communications means is normally connected to the building power supply, it shall automatically transfer to a source of standby or emergency power as required by the applicable building code or, where applicable, Standard for Health Care Facilities (ANSI/NFPA-99), after the normal power supply fails. The power source(s) shall be capable of providing for the means of communications [see Sections 2.27.1.1.3 and 2.27.1.1.4] for at least 4 h; and the audible signaling device (see Section 2.27.1.2) for at least 1 h.

2.27.1.1.6

(a) The voice communications means within the car shall include a means to verify operability of the telephone line, where

(1) verification of the telephone line operability shall be automatically performed

(2) verification may be continuous or periodic

(3) periodic verification shall be at least on a daily basis

(4) verification shall not require activation of the communications link(s). If means other than a telephone line (e.g., VOIP, network, intercom, etc.) is used for the communications, similar verification of this equivalent means shall be performed.

(b) If the verification means in 2.27.1.1.6(a) determines that the telephone line or equivalent means is not functional, an audible and illuminated visual signal shall be activated. A minimum of one visual and one audible signal shall be provided for each group of elevators controlled by a “FIRE RECALL” switch.

(1) The visual signal shall

(a) be located at the designated level in the vicinity of the “FIRE RECALL” switch and visible to elevator user(s)

(b) be labeled “ELEVATOR COMMUNICATIONS FAILURE” in red letters a minimum of 5 mm (0.25 in.) high

(c) illuminate intermittently

(d) continue illuminating intermittently until the telephone line or equivalent means is functional

(2) The audible signal shall

(a) be 10 dBA minimum above ambient, but shall not exceed 80 dBA measured at the designated landing “FIRE RECALL” switch

(b) sound at least once every 30 s with a minimum duration of half a second

(c) continue to sound until silenced by authorized personnel or the telephone line or equivalent means is functional

(3) A means to silence the audible signal shall be provided and shall be accessible only to authorized personnel. The signal when silenced shall remain silent for a period of no less than 12 hr or until activated by the next failed periodic verification [see 2.27.1.1.6(a)(3)].

(4) The verification means in 2.27.1.1.6(a) shall continue to monitor the operability of the telephone line or equivalent means while the telephone line or equivalent means is not functional on a continuous basis or periodically with intervals of not more than 5 min.

When the verification determines that the operability of the telephone line or equivalent means has been restored after being nonfunctional, the audible signal shall be silenced unless the signal has already been silenced in accordance with 2.27.1.1.6(b)(3) and the illuminated visual signal shall be extinguished.

2.27.2 Emergency or standby power system.

Delete and revise Section 2.27.2.4.1 to read as follows:

2.27.2.4.1 A selector switch(es) marked “ELEVATOR EMERGENCY POWER” in red lettering a minimum of 5 mm (0.25 in.) in height, that is key operated or under a locked cover (see Section 2.27.8), shall be provided to permit the selection of the elevator(s) to operate on the emergency or standby power system. The key shall be Group 3 Security (see Section 8.1). (NYC Fire Department and NYC standard keys.)

Delete and revise Section 2.27.2.4.3 to read as follows:

2.27.2.4.3 Means shall be provided adjacent to the selector switch(es) to indicate that the elevator is at the designated level with the doors in the normally open position.

2.27.3 Firefighters’ Emergency Operation: Automatic elevators.

Delete and revise the Note to Section 2.27.3 to read as follows:

2.27.3 Firefighters’ Emergency Operation: Automatic elevators.

Firefighters’ Emergency Operation shall apply to all automatic elevators except where the hoistway or a portion thereof is not required to be fire-resistive construction (see 2.1.1.1), the rise does not exceed 2 000 mm (80 in.), and the hoistway does not penetrate a floor.

NOTE: When the structure (building, etc.) is located in a flood hazard area, the alternate and designated levels (see Section 8.12.1) should be above the base flood elevation.

Delete and revise Section 2.27.3.1 to read as follows:

2.27.3.1 Phase I Emergency Recall Operation.

2.27.3.1.1 A two-position key-operated switch that will not change position without a deliberate action by the user, shall be

(a) provided at the designated or sky lobby level for each single elevator or for each group of elevators.

(b) labeled “FIRE RECALL” and its positions marked “NORMAL” and “FIREMAN SERVICE” (in that order). The “FIRE RECALL” letters shall be a minimum of 5 mm (0.25 in.) high. Text shall be either red on a background that contrasts with red, or a color that contrasts with red on a red background.

(c) located in the lobby or sky lobby within sight of the elevator or all elevators in that group and shall be readily accessible.

Delete and revise Section 2.27.3.1.2 to read as follows:

2.27.3.1.2 An additional key-operated “FIRE RECALL” switch, with two positions that will not change position without a deliberate action by the user, marked “NORMAL” and “FIREMAN

SERVICE” (in that order), shall be permitted only at the fire command center and the secondary fire command center where provided.

Delete and revise Section 2.27.3.1.3 to read as follows:

2.27.3.1.3 The switch(es) shall be rotated clockwise to go from the “NORMAL” to “FIREMAN SERVICE” positions. Keys shall be removable in the “NORMAL” and “FIREMAN SERVICE” positions.

Delete and revise Section 2.27.3.1.5 to read as follows:

2.27.3.1.5 All “FIRE RECALL” switches shall be provided with an illuminated visual signal (see Fig. 2.27.3.1.6(h)) to indicate when Phase I Emergency Recall Operation is in effect.

Delete and revise Section 2.27.3.1.6 to read as follows:

2.27.3.1.6 When a “FIRE RECALL” switch is in the “FIREMAN SERVICE” position, all cars controlled by the switch shall operate as follows:

- (a) A car traveling towards the designated or sky lobby level shall continue nonstop to the designated or sky lobby level and power operated doors shall open and remain open. On cars with more than one entrance, if the doors for another entrance can be opened at the designated or sky lobby level, only the doors serving the lobby where the “FIRE RECALL” switch is activated shall automatically open and remain open. Once at the designated or sky lobby level, all in-car door open button(s) shall be operative. Once the doors at an entrance other than the entrance serving the lobby where the “FIRE RECALL” switch is activated, are opened by means of an in-car door open button, they shall initiate reclosing within 15 s of reaching the normal open position.
- (b) A car traveling away from the designated or sky lobby level shall reverse at or before the next available landing without opening its doors and proceed to designated or sky lobby level.
- (c) A stopped car shall have the in-car stop switch (see Section 2.26.2.21) and the emergency stop switch in the car (see Section 2.26.2.5) when provided, rendered inoperative as soon as the car moves away from the landing. A moving car shall have the in-car stop switch and the emergency stop switch in the car when provided, rendered inoperative without delay. Once the emergency stop switch in the car and the in-car stop switch have been rendered inoperative, they shall remain inoperative while the car is on Phase I Emergency Recall Operation. All other stop switches required by Section 2.26.2 shall remain operative.
- (d) A car standing at a landing other than the designated or sky lobby level, with the doors open and the in-car stop switch and the emergency stop switch in the car when provided, in the run position, shall conform to the following:
 - (1) Elevators having automatic power-operated horizontally sliding doors shall close the doors without delay and proceed to the designated level.

- (2) Elevators having power-operated vertically sliding doors provided with automatic or momentary pressure closing operation shall have the closing sequence initiated without delay in accordance with Section 2.13.3.4, and the car shall proceed to the designated level.
- (3) Elevators having power-operated doors provided with continuous pressure closing operation (see Section 2.13.3.2), or elevators having manual doors, shall be provided with a visual and audible signal system [see Subsection 2.27.3.1.6(h)] to alert an operator to close the doors and shall, when the doors are closed, proceed to the designated level. Sequence operation, if provided, shall remain effective.
- (e) Door reopening devices for power-operated doors that are sensitive to smoke or flame shall be rendered inoperative without delay. Door reopening devices not sensitive to smoke or flame (e.g., mechanically actuated devices) are permitted to remain operative.

 - (1) Door closing for power-operated horizontally sliding doors shall conform to Section 2.13.5.
 - (2) Door closing for power-operated vertically sliding doors shall conform to Section 2.13.6.1.2 and shall have an average closing car door or gate speed not to exceed 0.20 m/s (0.67 ft/s).
- (f) Floor selection means, lanterns, and indicators

 - (1) in the car

 - (a) floor selection means shall be rendered inoperative
 - (b) car call-registered lights and car lanterns, where provided, shall be extinguished and remain inoperative
 - (c) position indicators and car-direction indicators, where provided, shall remain operative
 - (2) at the fire command center and secondary fire command center where provided

 - (a) position indicators and car-direction indicators shall remain operative
 - (3) at the designated or sky lobby level

 - (a) hall call-registered lights and hall lanterns, where provided, shall be extinguished and remain inoperative
 - (b) position indicators and car-direction indicators, where provided, shall remain operative

- (4) at all landings, except at the designated or sky lobby level
- (a) hall call-registered lights and hall lanterns, where provided, shall be extinguished and remain inoperative
 - (b) position indicators and car-direction indicators, where provided, shall be extinguished and remain inoperative
- (g) Where provided on elevators with vertically sliding doors, corridor door open and door close buttons shall remain operative.
- (h) An illuminated visual and audible signal system shall be activated. The visual signal shall be one of the symbols shown in Fig. 2.27.3.1.6(h) and located on the car-operating panel. The entire circular or square area or the outline of the hat, or the outline of the area shown in Fig. 2.27.3.1.6(h) shall be illuminated. The visual signal shall remain activated until the car is restored to automatic operation. When the door is open, the audible signal shall remain active until the door is closed. When the door is closed, the audible signal shall remain active for a minimum of 5 s. The audible signal shall not be active when the car is at the recall level.
- (i) A car stopped at a landing shall have the in-car door open button(s) rendered inoperative as soon as the car moves away from the landing. The in-car door open button(s) shall remain inoperative when a car stops to reverse direction. Once the in-car door open button(s) has been rendered inoperative, it shall remain inoperative until the car has returned to the designated level.
- (j) Where additional “FIRE RECALL” switches are provided, any “FIRE RECALL” switches shall be in the “FIREMAN SERVICE” position to recall the elevator to the designated level if the elevator was recalled to the alternate level (see 2.27.3.2.4).
- (k) To remove the elevator(s) from Phase I Emergency Recall Operation, the “FIRE RECALL” switch shall be rotated to the “NORMAL” position, provided that
- (1) the additional two-position “FIRE RECALL” switch, where provided, is in the “NORMAL” position
 - (2) no fire alarm initiating device is activated (see Section 2.27.3.2)
- (l) Means used to remove elevators from normal operation shall not prevent Phase I Emergency Recall Operation, except
- (1) as specified in this Code
 - (2) as controlled by elevator personnel
- (m) No device that measures load shall prevent operation of the elevator.

(n) If the normal power supply, emergency power supply, and standby power supply are not available and the elevator is equipped with an alternate source of power that can move the car to a floor, but is insufficient to move the car to the recall level, the following requirements shall apply:

- (1) The visual signal [2.27.3.1.6(h)] shall extinguish.
- (2) A car that is not at a landing shall move to the closest landing it is capable of reaching.
- (3) A car that has automatic power-operated horizontally sliding doors or power-operated vertically sliding doors provided with automatic closing operation and is stopped at a landing, shall open the doors, and then within 15 s, initiate reclosing.
- (4) A car that is stopped at a landing shall have its door open button operative.
- (5) A car stopped at a landing shall not move until normal power, emergency power, or standby power becomes available.

Fig. 2.27.3.1.6(h) Visual Signal

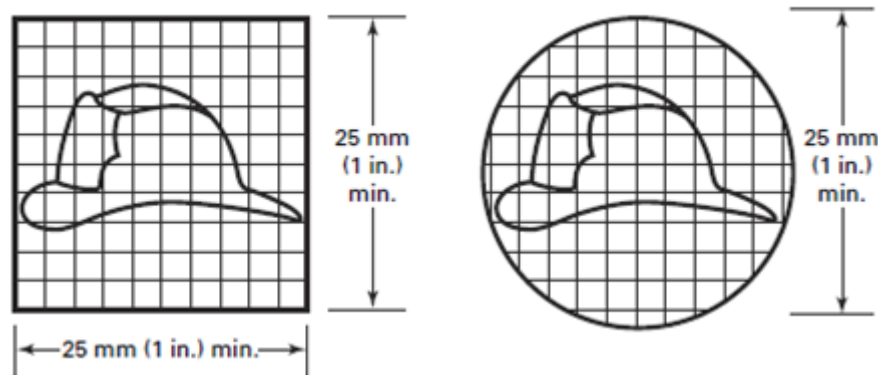

2.27.3.2 Phase I Emergency Recall Operation by fire alarm initiating devices.

Delete and revise Section 2.27.3.2.1 to read as follows:

2.27.3.2.1 Smoke detectors or other automatic fire detectors in environments not suitable for smoke detectors (fire alarm initiating devices) used to initiate Phase I Emergency Recall Operation shall be installed in conformance with the requirements of NFPA 72, and shall be located

- (a) at each elevator lobby served by the elevator
- (b) in the associated elevator machine room, machinery space containing a motor controller or driving machine, control space, or control room
- (c) in the elevator hoistway, when sprinklers are located in those hoistways

Delete and revise Section 2.27.3.2.2 to read as follows:

2.27.3.2.2 Sprinkler Waterflow Alarm. In a building equipped throughout with an automatic sprinkler system, the activation of the waterflow alarm shall cause Phase I emergency recall operation to be initiated.

Delete and revise Subsections (c) and (e) of Section 2.27.3.2.3 to read as follows:

2.27.3.2.3 Phase I Emergency Recall Operation to the designated level shall conform to the following:

(c) The activation of a fire alarm initiating device specified in Subsection 2.27.3.2.1(c) shall cause all elevators having any equipment in that hoistway, and any associated elevators of a group automatic operation, to be returned nonstop to the designated level, except that initiating device(s) installed at or below the designated landing shall cause the car to be sent to the alternate level.

(d) The Phase I Emergency Recall Operation to the designated level shall conform to Subsections 2.27.3.1.6(a) through (n).

Delete and revise Section 2.27.3.2.5 to read as follows:

2.27.3.2.5 The recall level shall be determined by the first activated fire alarm initiating device for that bank (see Section 2.27.3.2.1 or 2.27.3.2.2). If the car(s) is recalled to the designated level by the “FIRE RECALL” switch(es) [see also 2.27.3.1.6(j)], the recall level shall remain the designated level.

Delete and revise Section 2.27.3.2.7 to read as follows:

2.27.3.2.7 Listed relay(s) or other listed appliance(s) as specified and defined in NFPA 72 for connection to the fire alarm system shall be provided, and shall be

- (a) installed in conformance with the requirements of NFPA 72
- (b) used to initiate Phase I Emergency Recall Operation
- (c) located outside of any room or space requiring Group I Security (see 8.1)

Delete and revise Section 2.27.3.3 to read as follows:

2.27.3.3 Phase II Emergency In-Car Operation. A three-position (“NORMAL”, “HOLD,” and “FIREMAN SERVICE”, in that order) key-operated switch that will not change position without a deliberate action by the user, shall be labeled “FIRE OPERATION,” provided in an operating panel in each car, and shall be readily accessible. The label “FIRE OPERATION” lettering shall be a minimum of 5 mm (0.25 in.) high. Text shall be either red on a background that contrasts with red, or a color that contrasts with red on a red background. It shall become

effective only when Phase I Emergency Recall Operation is in effect and the car has been returned to the recall level.

The switch shall be rotated clockwise to go from “NORMAL” to “HOLD” to “FIREMAN SERVICE”. The key shall only be removable in the “NORMAL” and “HOLD” position. For elevators with power-operated doors, the “NORMAL”, “HOLD,” and “FIREMAN SERVICE” positions shall not change the mode of operation within Phase II Emergency In-Car Operation until the car is at a landing with the doors in the normal open position, except as required by Sections 2.27.3.3.4 and 2.27.3.4. The three modes of operation within Phase II In-Car Operation, “NORMAL”, “HOLD,” and “FIREMAN SERVICE”, are specified by Sections 2.27.3.3.1 through 2.27.3.3.4.

For elevators with manual doors, after the car and hoistway doors have been opened at least once at the recall level, the “NORMAL”, “HOLD,” and “FIREMAN SERVICE” positions shall then change the mode of operation in accordance with Sections 2.27.3.3.1 through 2.27.3.3.4.

Delete and revise Section 2.27.3.3.1 to read as follows:

2.27.3.3.1 When the “FIRE OPERATION” switch is in the “FIREMAN SERVICE” position, the elevator shall be on Phase II Emergency In-Car Operation, for use by emergency personnel only, and the elevator shall operate as follows:

(a) The elevator shall be operable only by a person in the car.

(b) Floor selection means, lanterns, and indicators

(1) in the car

(a) floor selection means shall function as required in Subsection 2.27.3.3.1(i)

(b) car call-registered lights, where provided, shall remain operative

(c) car lanterns, where provided, shall remain inoperative

(d) position indicators and car-direction indicators, where provided, shall remain operative

(2) at the fire command center

(a) position indicators and car-direction indicators, where provided, shall remain operative

(3) at the designated level

(a) the car shall not respond to hall calls

(b) hall call-registered lights, where provided, shall remain inoperative, except where associated cars of a group have been returned to group automatic operation

(c) position indicators and car-direction indicators, where provided, shall remain operative

(4) at all landings, except at the designated level

(a) the car shall not respond to hall calls

(b) hall call-registered lights, where provided, shall remain inoperative, except where associated cars of a group have been returned to group automatic operation

(c) position indicators, car-direction indicators, and hall lanterns, where provided, shall remain inoperative

(c) Door open and close buttons shall be provided for power-operated doors only and located as required by Section 2.27.3.3.7. Buttons shall be a minimum of 19 mm (0.75 in.) in the smallest dimension. The door open and door close buttons shall be labeled “OPEN” and “CLOSE” and when applicable “REAR OPEN” and “REAR CLOSE” or “SIDE OPEN” and “SIDE CLOSE” in lettering a minimum of 5 mm (0.25 in.) in height with a contrasting background. The labeling shall be on or adjacent to the buttons. The door open and close buttons shall be operative when the elevator is stopped within an unlocking zone.

(d) The opening of power-operated doors shall be controlled only by a continuous-pressure door open button. If the button is released prior to the doors reaching the normal open position, the doors shall automatically reclose. Requirements 2.13.3.3, 2.13.3.4, 2.13.4.2.1(b)(2), and 2.13.4.2.1(c) do not apply. All door open button(s) in the car shall be operational.

(e) Open power-operated doors shall be closed only by momentary pressure on the door close button. Where provided, additional door close button(s) in the car shall be operational.

(f) Opening and closing of power-operated car doors or gates that are opposite manual swing or manual slide hoistway doors shall conform to 2.27.3.3.1(d) and (e).

(g) All door reopening devices, except the door open button(s), shall be rendered inoperative. Full-speed closing shall be permitted. Landing door opening and closing buttons, where provided, shall be rendered inoperative.

(h) Every car shall be provided with a button labeled “CALL CANCEL” that shall be effective during Phase II Emergency In-Car Operation. When activated, all registered calls shall be canceled and a traveling car shall stop at or before the next available landing. The button shall be a minimum of 19 mm (0.75 in.) in the smallest dimension. Button labeling

shall be in lettering a minimum of 5 mm (0.25 in.) in height with a contrasting background. The labeling shall be on or adjacent to the button.

(i) Floor selection means shall be provided in the car to permit travel to all landings served by the car, and shall be operative at all times, except as in Sections 2.27.3.3.2 and 8.12.1. Means to prevent the operation of the floor selection means or door-operating buttons shall be rendered inoperative. Floor selection means that provide access to all landings served by the elevator shall be located below the firefighters' operating devices. The floor selection means shall be operable without the use of keys, cards, tools, or special knowledge. Where buttons not accessible to the public are provided, they shall be a minimum of 19 mm (0.75 in.) in the smallest dimension.

(j) A traveling car shall stop at the next available landing for which a car call was registered. When a car stops at a landing, all registered car calls shall be canceled.

(k) Means used to remove elevators from normal operation shall not prevent Phase II Emergency In-Car Operation, except

(1) as specified in this Code

(2) as controlled by elevator personnel

(l) No device that measures load shall prevent operation of the elevator at or below the capacity and loading required in Section 2.16.

(m) If the normal power supply, emergency power supply, and standby power supply are not available and the elevator is equipped with an alternate source of power that can move the car to a floor, but is insufficient to move the car to all landings, the following requirements shall apply:

(1) The visual signal [2.27.3.1.6(h)] shall illuminate intermittently.

(2) A car that is not at a landing shall not start until a car call is entered. After a car call is entered, the car shall move to the closest landing it is capable of reaching.

(3) A car stopped at a landing shall not move until normal power, emergency power, or standby power becomes available.

Delete and revise Sections 2.27.3.3.3, 2.27.3.3.4, and 2.27.3.3.5 to read as follows:

2.27.3.3.3 When the car is at a landing other than the recall level, with the doors in the normal open position, and the "FIRE OPERATION" switch is in the "NORMAL" position, power-operated doors shall operate as follows:

(a) Horizontal sliding doors shall close automatically. All door reopening devices shall remain inoperative. Door open buttons in the car shall remain operative. Full-speed closing is permitted. If the "FIRE OPERATION" switch is turned to the "FIREMAN SERVICE" or "HOLD" position prior to the completion of door closing, the doors shall reopen.

(b) Elevators having vertically sliding doors shall have corridor “DOOR OPEN” and “DOOR CLOSE” buttons rendered operative. All door reopening devices shall remain inoperative. Door closing shall be in accordance with Subsection 2.27.3.3.1(e). Full-speed closing is permitted. If the “FIRE OPERATION” switch is turned to the “FIREMAN SERVICE” or “HOLD” position prior to the completion of door closing, the doors shall reopen.

2.27.3.3.4 When the doors are in the closed position and the “FIRE OPERATION” switch is placed in the “NORMAL” position, the car shall return to the recall level in conformance with Subsections 2.27.3.1.6(a) through (n) and 2.27.3.2.5. If the normal power supply, emergency power supply, and standby power supply are not available and the elevator is equipped with an alternate source of power that can move the car to a floor, and the “FIRE OPERATION” switch in the car is in the “NORMAL” position, the following requirements shall apply:

(a) The visual signal [2.27.3.1.6(h)] shall illuminate intermittently.

(b) The requirements of 2.27.3.1.6(n)(2) through (5) shall apply.

2.27.3.3.5 Elevators shall be removed from Phase II Emergency In-Car Operation only when the “FIRE OPERATION” switch is in the “NORMAL” position and the car is at the designated level and the doors are in the normal open position.

Delete and revise Section 2.27.3.3.7 to read as follows:

2.27.3.3.7 The “FIRE OPERATION” switch (2.27.3.3), the “CALL CANCEL” button (2.27.3.3.1(h)), and the additional visual signal (2.27.3.3.8), shall be grouped together as shown in Fig. 2.27.3.3.7, exposed and accessible, on the cover of the main car operating panel and shall be located more than 1 220 mm (48 in.) and less than 1 830 mm (72 in.) above the floor as measured to the centerline of the “CALL CANCEL” button, “FIRE OPERATION” switch and visual signal.

Fig. 2.27.3.3.7 Panel Layout

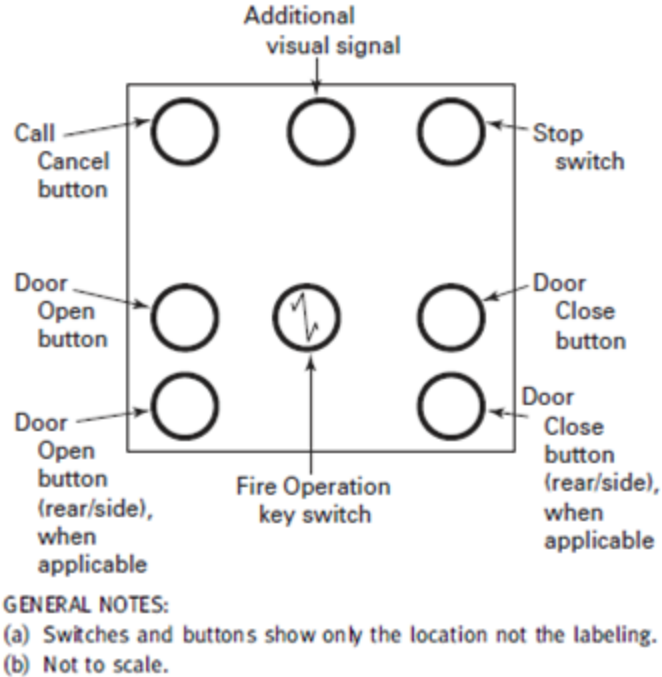

Delete Section 2.27.3.3.8 in its entirety.

Delete and revise Subsections (b) and (d) of Section 2.27.3.4 to read as follows:

2.27.3.4 Interruption of power. The failure and subsequent restoration of electrical power (normal, emergency, or standby) shall not cause any elevator to be removed from Phase I Emergency Operation or Phase II Emergency In-Car Operation.

(b) Elevators on Phase II Emergency In-Car Operation with the key in the “NORMAL” position shall be permitted to move only to the next floor in the direction of the recall level to reestablish absolute car position prior to conforming to Sections 2.27.3.3.3 and 2.27.3.3.4. If the key is moved to the “FIREMAN SERVICE” or “HOLD” position before the doors are fully closed, Subsections 2.27.3.4(c) or (d) shall apply, and automatic power-operated doors shall open if in a leveling zone.

(d) Elevators on Phase II Emergency In-Car Operation with the key in the “FIREMAN SERVICE” position shall not move, except for leveling within a leveling zone, until a car call is entered. Automatic power-operated doors shall not move until a door open or close button is pressed; after which they shall conform to Subsections 2.27.3.3.1(d) and (e). After a car call is entered, the car shall be permitted to move only to the next floor in the direction of the recall level to reestablish absolute car position prior to answering car calls.

Delete and revise Section 2.27.3.5 to read as follows:

2.27.3.5 Multicompartment elevators. Multicompartment elevators shall also conform to Sections 2.27.3.5.1 through 2.27.3.5.10 and shall be designed to have a usable hoistway entrance for the lower compartment when the upper compartment is at the designated or alternate level.

When the upper compartment has been recalled to the designated or alternate level and Phase I Emergency Recall Operation is in effect, the car and hoistway doors for both compartments shall open.

Delete and revise Sections 2.27.3.5.1, 2.27.3.5.2, 2.27.3.5.3, 2.27.3.5.4 and add new Sections 2.27.3.5.5 through 2.27.3.5.10 to read as follows:

2.27.3.5.1 The “FIRE RECALL” switch (see Section 2.27.3.1) shall be located at the designated level served by the upper compartment. Where a sky lobby exists, a “FIRE RECALL” switch shall also be located at the floor served by the upper compartment that is immediately above the sky lobby level. This level above the sky lobby level shall be the sky lobby designated level.

2.27.3.5.2 The Phase II Emergency In-Car Operation switch (see Section 2.27.3.3) shall be located in the upper compartment.

2.27.3.5.3 A visual and audible signal (see Subsection 2.27.3.1.6(h)) shall be provided in the main car operating panel of both the upper and lower compartments.

2.27.3.5.4 A minimum 3” diagonal video display shall be installed in the car operating panel of the upper compartment so that the entire floor area in the lower compartment is visible. The display shall show the lower compartment when the upper deck is on Phase I Emergency Recall Operation and is at the designated level with the car doors open and shall remain on during Phase II Emergency In-Car Operation.

2.27.3.5.5 Moving the Phase II Emergency In-Car Operation key switch to the “FIREMAN SERVICE” position shall result in locking out the lower compartment.

(a) When placed in the “FIREMAN SERVICE” position, the control system shall:

(1) disable all door reopening devices in the lower compartment; and

(2) initiate closing of the lower compartment doors in accordance with Subsection 2.13.4.2.1(c).

(b) When the upper compartment is stopped at the designated level, the Phase II Emergency In-Car Operation key switch is in the “NORMAL” position and Phase I Emergency Recall Operation is in effect; the lower compartment doors shall be opened.

2.27.3.5.6 Two-way hands-free voice communication shall be established between the upper and lower compartments when the elevator is on Phase I Emergency Recall Operation, the upper compartment is at the designated or alternate level, and the car and hoistway doors are open. Voice communication between the two compartments shall be maintained until such time as the elevator is returned to normal service.

2.27.3.5.7 A switch labeled “LOWER COMPARTMENT RECOVERY” with two positions marked “OFF” and “ON” shall be located adjacent to the elevator at the designated level. The key shall only be removable when the switch is in the “OFF” position.

(a) When the switch is in the “ON” position, the doors of the upper and lower compartments shall close in accordance with Subsection 2.13.4.2.1(c), and the lower compartment shall move to the designated level.

(b) When the lower compartment arrives at the designated level, the doors of the lower compartment shall open and remain open until the switch is turned to the “OFF” position. The doors of the upper compartment shall remain closed.

(c) When the switch is turned to the “OFF” position, the doors of the lower compartment shall close and the upper compartment shall arrive at the designated level and open the doors.

(1) The doors of the upper compartment shall remain open until:

(i) the elevator is placed on Phase II Emergency In-Car Operation; or

(ii) the elevator is returned to normal operation.

(2) The doors of the lower compartment shall remain closed until such time as:

(i) the elevator is returned to normal operation;

(ii) the “LOWER COMPARTMENT RECOVERY” switch is operated and the lower compartment has returned to the designated level; or

(iii) the elevator is on “FIREMAN SERVICE” Phase I Emergency Recall Operation.

2.27.3.5.8 Activation of a fire alarm initiating device at either the designated level or the level below the designated level shall cause the elevator(s) to travel to the alternate level.

2.27.3.5.9 Activation of a fire alarm initiating device at the sky lobby or the level above the sky lobby (which is the sky lobby designated level) shall cause the elevator(s) to travel to the sky lobby alternate level.

2.27.3.5.10 Alternate levels shall be located in accordance with the following provisions:

(a) Where no blind hoistway exists, the alternate level shall be three (3) levels above the designated level.

(b) Where blind hoistways exist, the alternate level shall be the second level above the blind hoistway.

(c) The sky lobby alternate level shall be three (3) levels above the sky lobby designated level.

Delete and revise Section 2.27.4 to read as follows:

2.27.4 Firefighters' Emergency Operation: Nonautomatic elevators.

- (a) Firefighters' Emergency Operation shall apply to all nonautomatic elevators except where the hoistway or a portion thereof is not required to be fire-resistive construction (see Section 2.1.1.1), the rise does not exceed 2 000 mm (80 in.), and the hoistway does not penetrate a floor.
- (b) Where Firefighters' Emergency Operation is provided voluntarily, the requirements of Section 2.27.4 shall also apply.
- (c) The following signage shall be provided:

 - (1) A sign stating "Manual Elevator" shall be provided on the inside of the entrance frame of all nonautomatic operated elevators at the designated landing.
 - (2) Single nonautomatic elevators, or a group of non-automatic elevators, shall be provided with signage indicating "Manual Elevator" on or adjacent to the Phase I Firemans' Emergency Operation key switch located at the designated landing.
 - (3) Lettering shall be in accordance with Subsection 2.27.3.1.1(b).

Delete and revise Section 2.27.4.1 to read as follows:

2.27.4.1 Phase I Emergency Recall Operation. A two-position key-operated switch shall be provided at the designated level for each single elevator or for each group of elevators. The two-position switch shall be labeled "FIRE RECALL" and its positions marked "NORMAL" and "FIREMAN SERVICE" (in that order), with the "NORMAL" position as the center position. The "FIRE RECALL" letters shall be a minimum of 5 mm (0.25 in.) high in red or a color contrasting with a red background. The two-position switch shall be located in the lobby within sight of the elevator or all elevators in that group and shall be readily accessible.

An additional "FIRE RECALL" switch with two positions, "NORMAL" and "FIREMAN SERVICE" (in that order), shall be permitted only at the fire command center.

The switch(es) shall be rotated clockwise to go from the "NORMAL" to the "FIREMAN SERVICE" positions. All keys shall be removable only in the "NORMAL" and "FIREMAN SERVICE" positions.

Only the "FIRE RECALL" switch(es) or fire alarm initiating devices located at floors that are served by the elevator, in the hoistway, or in an elevator machine room, a control space, or a control room (see Section 2.27.3.2) shall initiate Phase I Emergency Recall Operation.

All "FIRE RECALL" switches shall be provided with an illuminated visual signal to indicate when Phase I Emergency Recall Operation is in effect.

When all switches are in the "NORMAL" position, normal elevator service shall be in effect and the fire alarm initiating devices required by Section 2.27.4.2 shall be operative.

When a “FIRE RECALL” switch is in the “FIREMAN SERVICE” position, a visual and audible signal shall be provided to alert the attendant to return nonstop to the designated or alternate level. The visual signal shall read “FIRE RECALL — RETURN TO _____” [insert level to which the car should be returned (the designated or alternate level)]. The signal system shall be activated when Phase I Emergency Recall Operation is in effect.

Where an additional “FIRE RECALL” switch is provided, any “FIRE RECALL” switch must be in the “FIREMAN SERVICE” position to recall the elevator to the designated level if the elevator was recalled to the alternate level.

Any “FIRE RECALL” switch shall not affect the visual signal if the designated level fire alarm initiating device (see Section 2.27.3.2.4) has been activated.

To extinguish the audible and visual signals, the “FIRE RECALL” switch shall be rotated to the “NORMAL” position, provided that:

- (a) the additional two-position “FIRE RECALL” switch, where provided, is in the “NORMAL” position
- (b) no fire alarm initiating device is activated (see also Section 2.27.3.2.4)

No device, that measures load, shall prevent operation of the elevator at or below the capacity and loading required in Section 2.16.

Delete and revise Section 2.27.4.2 to read as follows:

2.27.4.2 Phase I Emergency Recall Operation by fire alarm initiating devices.

- (a) Fire alarm initiating devices shall be installed, in the locations listed in Subsections 2.27.4.2(a)(1) through (3), in compliance with the requirements in NFPA 72 as follows:
 - (1) at each elevator lobby served by the elevator
 - (2) in the associated elevator machine room, machinery space containing a motor controller or driving machine, control space, or control room
 - (3) in the elevator hoistway, when sprinklers are located in those hoistways
- (b) Phase I Emergency Recall Operation, conforming to Section 2.27.4.1, shall be initiated when any Phase I Emergency Recall Operation fire alarm initiating device specified in Subsection 2.27.4.2(a) is activated.
- (c) Phase I Emergency Recall Operation, when initiated by a Phase I Emergency Recall Operation fire alarm initiating device, shall be maintained until canceled by moving the “FIRE RECALL” switch to the “NORMAL” position.
- (d) When a fire alarm initiating device in a location specified by Subsections 2.27.4.2(a)(2) or (3) initiates Phase I Emergency Recall Operation as required by Sections 2.27.3.2.3

or 2.27.3.2.4, the visual signal [see 2.27.3.1.6(h) and Fig. 2.27.3.1.6(h)] shall illuminate intermittently only in a car(s) with equipment in that location.

2.27.5 Firefighters' Emergency Operation: automatic elevators with designated-attendant operation.

Delete and revise Section 2.27.5.2 to read as follows:

2.27.5.2 When operated by a designated attendant in the car,

- (a) elevators parked at the recall level shall conform to Section 2.27.3 and when Occupant Evacuation Operation is provided shall also conform to Section 2.27.11.6 without delay; elevators parked at a floor other than the recall level shall conform to Subsection 2.27.3.1.6(h). At the completion of a time delay of not less than 10 seconds and not more than 30 seconds, elevators parked at a floor away from the recall level shall conform to Section 2.27.3 and when Occupant Evacuation Operation is provided shall also conform to Section 2.27.11.6.
- (b) a moving car shall conform to Section 2.27.3 and when Occupant Evacuation Operation is provided shall also conform to Section 2.27.11.6.

Exception. The provisions of Section 2.27.5.2 do not apply to hospital service.

Delete and revise Section 2.27.5.3 to read as follows:

2.27.5.3 When an elevator that is provided with Firefighters' Emergency Operation or Occupant Evacuation Operation is on hospital service, a visual signal as shown in Fig. 2.27.3.1.6(h) shall illuminate and a continuous audible signal, audible within the car, shall sound when a "FIRE RECALL" switch (see Sections 2.27.3.1 and 2.27.11.1.2) is in the "FIREMEN SERVICE" position, or when a fire alarm initiating device (see Section 2.27.3.2) is activated to alert the operator of an emergency. There may be a means located in the car for manually silencing the audible signal, after the signal has been active for at least 5 seconds.

The signal shall be automatically reactivated when the doors open. The car shall remain under control of the operator until removed from hospital service. An elevator on Firefighters' Emergency Operation or Occupant Evacuation Operation shall not be placed on hospital service.

Add new Sections 2.27.5.3.1 through 2.27.5.3.3 to read as follows:

2.27.5.3.1 Hospital Emergency Service Recall Operation (when provided). A two-position key-operated corridor call (Hospital Emergency Service) switch shall be provided at one or more landings to activate the special control function by authorized or designated personnel. The two-position switch shall be marked "NORMAL" and "HOSPITAL EMERGENCY SERVICE". Keys shall be removed only in the "NORMAL" position.

When the switch is in the "HOSPITAL EMERGENCY SERVICE" position:

(a) All patient elevator cars equipped with the special control function shall override normal automatic operating modes for immediate recall of the patient elevator(s) to the landing at which the call is registered.

(b) On patient elevator cars with two entrances, if both entrances can be opened at the designated level, the doors serving the corridor where the two-position Hospital Emergency Service switch is located shall open and remain open.

(c) A patient elevator car traveling away from the designated level shall reverse at or before the next available landing without opening its doors.

(d) A patient elevator car stopped at a landing other than the designated level, with the doors open and in-car emergency stop switch in the run position, shall close the doors without delay and proceed to the designated level.

(e) A visual and audible signal shall be activated within the patient elevator car to alert the passengers and/or attendant operator that the “Hospital Emergency Service” function has been activated.

(f) Upon arrival at the registered call landing, power operated doors shall open automatically and remain in the open position for a predetermined adjustable time period to allow the authorized personnel sufficient time to activate the “In- Car” special operation function.

(g) If the Phase I (Section 2.27.3.1) recall mode is initiated while the elevator is under “Hospital Emergency Service” recall mode and “In-Car” hospital emergency service is not activated, the elevator shall revert to Phase I (Section 2.27.3.1) operation.

(h) Hospital emergency service corridor recall shall not override fire emergency Phase I (Section 2.27.3.1) or Phase II (Section 2.27.3.3) operation in effect.

2.27.5.3.2 Hospital Emergency Service In-Car Operation: A two-position “NORMAL” and “HOSPITAL EMERGENCY SERVICE” key-operated switch shall be provided in an operating panel inside the patient elevator(s) to activate the “Hospital Emergency Service”, a special independent operating mode. The switch shall be rotated clockwise to go from the “NORMAL” to “HOSPITAL EMERGENCY SERVICE” position. It shall become effective only when the designated level corridor call “Hospital Emergency Service” switch is in the “HOSPITAL EMERGENCY SERVICE” position and the car has returned to the designated level by “Hospital Emergency Service” recall operation.

When the “In-Car” switch is in the “HOSPITAL EMERGENCY SERVICE” position, the patient elevator shall be on Hospital Emergency Service operation, and the patient elevator shall operate as follows:

(a) The patient elevator shall be operable only by a designated person in the car.

(b) Activation of the “In-Car” operating mode shall remove the patient elevator from normal automatic and/or attendant service.

(c) The patient elevator(s) shall not be recalled under Phase I (Section 2.27.3.1) operation after the activation of “In-Car” operation mode.

(d) Doors shall remain open until the authorized person registers the car call and initiates the door closing function.

(e) The patient elevator shall travel directly to the selected landing, overriding normal corridor call demand or Phase I (Section 2.27.3.1) recall and shall automatically open the doors upon the arrival at the selected landing, except when the smoke detector(s) are activated on the selected landing or the waterflow alarm is activated on that floor. In such case, before the patient elevator has reached the selected landing, the patient elevator shall stop at a floor two stories below the selected landing or in the absence of a stop at that floor, at the nearest landing below the selected landing.

(f) When the patient elevator reaches the selected floor and the smoke detector(s) are activated on that landing or the waterflow alarm is activated on that floor before the doors are open, the patient elevator, without opening the doors, shall travel to a floor two stories below the selected landing or in the absence of a stop at that floor, to the nearest landing below the selected landing.

(g) Doors shall remain open with the audible and visual signal functioning until the “in-Car” switch is turned to the “NORMAL” position or for a predetermined adjustable time period to allow the removal of patients from the car and the patient elevator is placed into automatic, attendant or Phase I (Section 2.27.3.1) if in effect, operating mode.

(h) Upon transfer from “HOSPITAL EMERGENCY SERVICE” back to normal operation during a fire emergency and Phase I (Section 2.27.3.1) is in effect, the patient elevator shall be automatically recalled to the designated level.

2.27.5.3.3 Hospital Emergency Service switches color. The color of the Hospital Emergency Service switches located in the corridor at the designated level and inside the patient elevator(s) operating panel shall be “BLUE”.

2.27.6 Firefighters’ Emergency Operation, Occupant Evacuation Operation: Inspection Operation.

Delete and revise Section 2.27.6 to read as follows:

2.27.6 Firefighters’ Emergency Operation, Occupant Evacuation Operation: Inspection Operation.

When an elevator that is provided with Firefighters’ Emergency Operation or Occupant Evacuation Operation is on inspection operation (see Sections 2.26.1.4 and 2.26.1.5) or when a hoistway access switch has been enabled (see Subsection 2.12.7.3.3(a)), a continuous audible signal, audible at the location where the inspection operation is activated, shall sound when a “FIRE RECALL” switch (see Sections 2.27.3.1 and 2.27.11.1.2) is in the “FIREMAN SERVICE” position or when the fire alarm initiating device (see Sections 2.27.3.2 and 2.27.11.5) is activated to alert the operator of an emergency. The car shall remain under the

control of the operator until removed from inspection operation or hoistway access operation. Inspection operation or hoistway access operation shall take precedence over Phase I Emergency Recall Operation, Phase II Emergency In-Car Operation, and Occupant Evacuation Operation.

2.27.7 Firefighters' Emergency Operation: Operating procedures.

Delete Section 2.27.7 in its entirety.

2.27.8 Switch keys.

Delete and revise Section 2.27.8 to read as follows:

2.27.8 Switch keys.

The switches required by Section 2.27.2 through Section 2.27.5 for all elevators in a building shall be operable both by a citywide standard (2642) key and the New York City Fire Department standard (1620) key.

The citywide standard key and Fire Department standard key shall be designed in accordance with the requirements of the Fire Department. The Fire Department standard key (1620) shall be obtained only through Fire Department authorization.

Citywide standard keys shall be kept on the premises by a person responsible for the maintenance and operation of the elevators in a location readily accessible to authorized persons in an emergency, but not where they are available to the public.

2.27.11 Occupant Evacuation Operation.

Delete and revise the Note to Section 2.27.11 to read as follows:

2.27.11 Occupant Evacuation Operation.

Where elevators are provided for occupant evacuation, Occupant Evacuation Operation (OEO) shall be provided to function prior to Firefighter's Emergency Operation and shall conform to 2.27.11.1 through 2.27.11.6.

NOTE: See also Nonmandatory Appendix V for additional information.

Delete and revise Sections 2.27.11.1, 2.27.11.2, and 2.27.11.3 to read as follows:

2.27.11.1 The requirements of Section 2.27.3.1 are modified as follows.

2.27.11.1.1 The two-position switch in the lobby (Section 2.27.3.1.1) and two-position switch in the fire command center (Section 2.27.3.1.2) shall be labeled "BANK FIRE RECALL" and indicate the elevator bank that they control.

2.27.11.1.2 An additional two-position key operated individual "CAR FIRE RECALL" switch per elevator, that will not change position without a deliberate action by the user, shall be

located in the lobby at the designated level adjacent to the elevator it controls. Each switch shall be labeled “CAR FIRE RECALL” (with the car identification, as specified in Section 2.29.1, inserted), and its positions marked “NORMAL” and “FIREMEN SERVICE” (in that order) in letters a minimum of 5 mm (0.25 in.) high. Text shall be black on a yellow background. Each switch shall control the associated elevator in conformance with Section 2.27.3.1.6, but shall not control the other elevators controlled by the “BANK FIRE RECALL” switch (see Section 2.27.11.1.1).

2.27.11.1.3 Each individual “CAR FIRE RECALL” switch shall terminate Occupant Evacuation Operation for the elevator it controls when placed in the “FIREMEN SERVICE” position. Each “BANK FIRE RECALL” switch shall terminate Occupant Evacuation Operation for the elevators it controls when placed in the “FIREMEN SERVICE” position.

2.27.11.1.4 Each individual “CAR FIRE RECALL” switch shall be provided with an illuminated visual signal to indicate when Phase I Emergency Recall Operation is in effect for that car (see Section 2.27.3.1.5).

2.27.11.1.5 To remove an individual elevator from Phase I Emergency Recall Operation, the individual “CAR FIRE RECALL” switch shall be rotated to the “NORMAL” position, provided that

(a) the “BANK FIRE RECALL SWITCH” and the additional two-position “GROUP FIRE RECALL” “BANK FIRE RECALL” switch, where provided, are in the “NORMAL” position; and

(b) no fire alarm initiating device is activated (see Section 2.27.3.2).

2.27.11.1.6 A car with its individual “CAR FIRE RECALL” switch in the “FIREMEN SERVICE” position shall not be removed from Phase I Emergency Recall Operation when the “BANK FIRE RECALL” switch is rotated to the “NORMAL” position.

2.27.11.1.7 At the elevator designated level, only the door(s) serving the lobby where the “BANK FIRE RECALL” switch is located shall open.

2.27.11.2 The sign required by Section 2.27.9 shall not be installed. A variable message sign, as defined in ANSI/ICC A117.1, shall be installed for each elevator bank on each landing served. It shall be located not less than 2 130 mm (84 in.) and not more than 3 000 mm (120 in.) above the floor and in a central visible location within the elevator lobby. Message text shall be a minimum of 50 mm (2 in.) high and conform to ANSI/ICC A117.1. The variable message signs shall be powered by the same power supply as the elevator, including emergency or standby power.

When the elevators are not on Occupant Evacuation Operation or Firefighters’ Emergency Operation, the variable message signs shall not display other elevator system status messages.

2.27.11.3 Where hoistway pressurization is provided, a car on Phase I Emergency Recall, after completing the requirements of Section 2.27.3.1.6, shall conform to the following:

- (a) A car shall close its doors after 15 seconds.
- (b) Door reopening devices, door force limiting devices, kinetic energy limiting devices, and the door open button shall remain active.
- (c) At least one operating device normally used to call a car to the landing (e.g., hall call button, keypad) shall be located in the elevator lobby at the elevator designated level. Actuating this device shall cause all recalled cars to open their doors for 30 seconds to 45 seconds, then reclose.

2.27.11.5 Fire alarm system interface.

Delete and revise Sections 2.27.11.5.1 and 2.27.11.5.2 to read as follows:

2.27.11.5.1 Upon activation of an automatic fire alarm initiating device in the building in any area that does not initiate Phase I recall in this bank, the fire alarm system shall provide signals to the elevator system in conformance with NFPA 72, as modified by Appendix Q of the New York City Building Code and any applicable rules, indicating the floors to be evacuated. The floors to be evacuated shall be a contiguous block of floors, consisting of at least the floor with an active alarm, one floor above and one floor below. The elevator system shall initiate Occupant Evacuation Operation in accordance with Section 2.27.11.6 for the indicated floors. If activation of an automatic fire alarm initiating device which does not initiate Phase I recall in this bank occurs on any additional floor at any time while Occupant Evacuation Operation in accordance with Section 2.27.11.6 is in effect, the evacuation zone shall be expanded to include all floors with an active alarm, all floors between the highest and lowest floor with an active alarm plus one floor above the highest floor with an active alarm and one floor below the lowest floor with an active alarm. If the active alarm is on the elevator designated level, automatic initiation of Occupant Evacuation Operation in accordance with Section 2.27.11.6 shall not be permitted. Initiation by authorized or emergency personnel shall be provided through manual operation of the fire alarm system.

For the purposes of this section, an active alarm refers to the condition caused by the activation of an automatic fire alarm initiating device.

2.27.11.5.2 A means to initiate total building evacuation, labeled “ELEVATOR TOTAL BUILDING EVACUATION,” shall be provided at the fire command center location and installed in accordance with NFPA 72, as modified by Appendix Q of the New York City Building Code and any applicable rules. When this means is actuated, the fire alarm system shall provide a signal to the elevator system indicating that all floors are to be evacuated. The means to initiate total building evacuation shall be keyed as New York City standard #2642 and FDNY standard key.

Delete and revise Sections 2.27.11.6.1, 2.27.11.6.2, and 2.27.11.6.3 to read as follows:

2.27.11.6.1 The variable message signs required by Section 2.27.11.2 shall indicate one of the following messages:

(a) On all floors being evacuated, they shall indicate that the elevators are available for evacuation and the estimated time duration in minutes for the next elevator to arrive.

Text shall read: “Elevators and stairs available for evacuation. Next car in about “X” minutes.”

(b) On all floors not being evacuated, they shall indicate that elevator service is not available.

Text shall read: “Elevators temporarily dedicated to other floors.”

(c) On the elevator designated level, they shall indicate that the cars are in evacuation mode and that passengers should not use elevators.

Text shall read: “Elevators dedicated to evacuation. Do not enter elevator.”

(d) If no elevators are available for Occupant Evacuation Operation (fire service, inspection, shut off, etc.), they shall indicate that elevator service is not available.

On all floors being evacuated, they shall also indicate that occupants should use the stairs.

Text for floors being evacuated: “Elevators out of service. Use stairs to evacuate.”

Text for other floors: “Elevators out of service.”

2.27.11.6.2 Automatic visual signal or variable message sign, and voice notification in each car shall indicate that the car is being used to evacuate the building.

In the event that the car stops to pick up passengers at a floor other than the elevator designated level, the signals shall instruct the passengers to remain in the car.

Upon or prior to arrival at the elevator designated level, passengers shall be notified that they have arrived at the exit floor and to exit quickly. Message text shall be a minimum of 25 mm (1 in.) high and conform to ANSI/ICC A117.1. Voice notification shall be at least 10 dBA above ambient but not more than 80 dBA measured 1 525 mm (60 in.) above the floor, at the center of the car.

2.27.11.6.3 All landing calls outside of the contiguous block of floors being evacuated shall be canceled and disabled. Building security systems that limit service to these floors shall be overridden. Any landing call within the contiguous block of floors shall call an elevator or elevators to that landing. Landing calls entered at the floor with an active alarm shall be given higher priority than the calls at the floors above and below it. If a subsequent active alarm is received from a different floor, the evacuation priority shall be assigned in the sequence received. Once passengers have entered an elevator, it shall proceed only towards the elevator designated level. When total building evacuation is in effect and no calls are entered at an affected floor, priority shall be based on distance from the elevator designated level, with the farthest floor served getting highest priority.

Delete and revise Section 2.27.11.6.6 to read as follows:

2.27.11.6.6 Cars that are occupied when Occupant Evacuation Operation is actuated shall proceed without delay to the elevator designated level. Any reversal of travel direction that is needed shall be done at or before the next available floor without opening the doors. After opening and closing the doors at the elevator designated level, the cars shall proceed without delay to a floor that is being evacuated and park with their doors closed until a landing call is registered.

Delete and revise Section 2.27.11.6.9 to read as follows:

2.27.11.6.9 Once the block of floors being evacuated has been evacuated, as indicated by a 60 second period in which no landing calls are registered, one car shall park with its doors closed at the lowest floor of the block of floors ready to answer subsequent landing calls within the block of floors; the rest shall park with doors closed at the elevator designated level. A car parked at the elevator designated level shall replace the car at the lowest floor of the block that has answered a landing call.

SECTION 2.28 **LAYOUT DRAWINGS**

2.28.1 Information required on layout drawings.

Add new Subsection (k) to Section 2.28.1 to read as follows:

Elevator layout drawings shall, in addition to other data, indicate the following:

(k) any special operation of the elevator including, but not limited to, Occupancy Evacuation Operation (OEO) or Fire Service Access Elevator (FSAE)

SECTION 2.29 **IDENTIFICATION**

2.29.1 Identification of equipment.

Delete and revise Section 2.29.1 to read as follows:

2.29.1 Identification of Equipment

2.29.1.1 Each elevator shall be assigned a unique alpha-numeric or numerical identification, a minimum of 50 mm (2 in.) in height. The identification number shall be applied to the following locations:

- (a) The driving machine;
- (b) MG and/or Transformers set;
- (c) Controller;
- (d) Selector;

(e) Governor;

(f) Main line disconnect switch;

(g) The crosshead, or where there is no crosshead, the car frame, such that it is visible from the top of the car;

(h) The car operating panel, minimum of 13 mm (0.5 in.) in height;

(i) Adjacent to or on every elevator entrance at the designated level, minimum of 75 mm (3 in.) height; and

(j) Each bank of elevators shall be identified by an alphabetic letter.

Where an alpha-numeric designation is used for an elevator, the alpha portion shall represent the bank designation in which the elevator is located.

2.29.1.2 New York City Identification Number.

Each elevator shall be assigned a unique numerical identification, a minimum of 6 mm (¼ in.) in height. The City identification number shall be applied to the following locations:

(a) The driving machine;

(b) MG and/or Transformers set;

(c) Controller;

(d) Main line disconnect switch;

(e) The crosshead, or where there is no crosshead, the car frame, such that it is visible from the top of the car;

(f) The car operating panel (main panel only).

2.29.1.3 Where any of the following devices for more than one elevator are located in the same enclosure, such devices or a grouping of devices for one elevator with demarcation to establish that all devices within the demarcation belong to that identified elevator shall be identified with the unique alphabetical or numerical identification letter(s) or number(s) of its associated elevator as assigned in Section 2.29.1.1:

(a) means to trip the governor and/or means to reset the governor from outside the hoistway as permitted by Section 2.7.6.3.4

(b) display devices or their equivalent as required by Section 2.7.6.4.1

(c) means to move the car from outside the hoistway as required by Section 2.7.6.4.3

(d) stop switches as required by Section 2.7.6.5.2

(e) landing inspection operation transfer switches and operating devices as required by Section 2.7.6.5.2 (see also Section 2.26.1.4.4)

(f) “CAR DOOR BYPASS” and “HOISTWAY DOOR BYPASS” switches as required by Section 2.26.1.5

(g) means to manually reset the ascending car overspeed detection means as required by Section 2.19.1.2(a)(4)

(h) means to manually reset the unintended motion detection means as required by Section 2.19.2.2(a)(4)

(i) the earthquake reset button or switch as required by Section 8.4.10.1.1(a)(2)(b)

PART 3 **HYDRAULIC ELEVATORS**

SECTION 3.7 **MACHINERY SPACES, MACHINE ROOMS, CONTROL SPACES, AND CONTROL ROOMS**

Delete and revise the opening paragraph of Section 3.7.1 to read as follows:

3.7.1 Machinery spaces, machine rooms, control spaces, and control rooms shall conform to the requirements of Sections 2.7.1 through 2.7.7 and 2.7.9. Hydraulic machines and controllers are not permitted in the hoistway or pit.

SECTION 3.16 **CAPACITY AND LOADING**

Add new Section 3.16.10 to read as follows:

3.16.10 Detection of overload on passenger and freight elevators permitted to carry passengers.

Requirements of 2.16.10 shall not apply to direct acting hydraulic elevators.

SECTION 3.26 **OPERATING DEVICES AND CONTROL EQUIPMENT**

3.26.3 Anticreep and leveling operation.

Delete and revise Section 3.26.3.1.2 to read as follows:

3.26.3.1.2 The anticreep device shall maintain the car within 13 mm (1/2 in.) of the landing, irrespective of the position of the hoistway door.

PART 4 **ELEVATORS WITH OTHER TYPES OF DRIVING MACHINES**

SECTION 4.3
HAND ELEVATORS

Delete and revise Section 4.3 to read as follows:

RESERVED

PART 5
SPECIAL APPLICATION ELEVATORS

SECTION 5.2
LIMITED-USE/LIMITED-APPLICATION ELEVATORS

5.2.1 Electric limited-use/limited-application elevators.

Delete and revise Section 5.2.1.13 to read as follows:

5.2.1.13 Power operation of hoistway doors and car doors. When provided, power operation, power opening, and power closing of hoistway doors and car doors shall conform to Section 2.13, except as modified by Section 5.2.1.13.

(a) Requirement Section 2.13.1 does not apply. Both car and hoistway doors shall be of the horizontally sliding type with a power-operated horizontally sliding car door. Power operation of accordion or bifold type car doors shall be permitted.

(b) Vertically sliding doors and power operated swing doors shall not be permitted.

Delete and revise Section 5.2.1.16.1 to read as follows:

5.2.1.16.1 Rated load and platform area. The minimum rated load shall conform to Section 2.16.1, except as follows:

(a) The maximum rated load shall not exceed 635 kg (1,400 lb).

(b) The inside net platform area shall not exceed 1.67 m² (18 ft²) and shall comply with A117.1 Section 408.4.

(c) Requirements of Sections 2.16.1.2 and 2.16.1.3 do not apply.

SECTION 5.3
PRIVATE RESIDENCE ELEVATORS

5.3.1 Private residence electric elevators.

Delete and revise Section 5.3.1.6.1 to read as follows:

5.3.1.6.1 Suspension means passing through floors or stairs. Ropes passing through a floor or stairway outside the hoistway enclosure shall be enclosed with a solid or openwork enclosure. If of openwork, the enclosure shall reject a ball 13 mm (0.5 in.) in diameter. Means for inspection

shall be provided. The floor openings shall not be larger than is necessary to clear the suspension means.

5.3.1.7 Protection of hoistway openings.

Delete and revise Sections 5.3.1.7.1 through 5.3.1.7.5 to read as follows:

5.3.1.7.1 Where required. Where a hoistway enclosure is required, landing openings shall be protected by swinging or horizontally sliding doors. Landing openings in solid hoistway enclosures shall be protected the full height by solid swinging or horizontally sliding doors. Their fire-protection rating shall be not less than required by the building code (see Section 1.3). The doors shall be designed to withstand a force of 670 N (150 lbf) applied horizontally over an area 100 mm x 100 mm (4 in. x 4 in.) in the center of the doors without permanent displacement or deformation. Gates shall not be permitted.

5.3.1.7.2 Clearance between hoistway doors and landing sills and car doors and gates. The clearance between the hoistway doors and the hoistway edge of the landing sill shall not exceed 19 mm (0.75 in.) for swinging doors and 57 mm (2.25 in) for sliding doors. The distance between the hoistway face of the landing door and the car door gate shall not exceed 100 mm (4 in.).

5.3.1.7.3 Projection of hoistway doors into the hoistway. The hoistway face of the hoistway door shall not project into the hoistway beyond the line of the landing sill. No hardware, except that required for door-locking and door-operating or signaling devices, shall project into the hoistway beyond the line of the landing sill.

5.3.1.7.4 Locking devices for hoistway doors. Hoistway doors shall be provided with locking devices. The locking device shall be an interlock and conform to the requirements of Sections 2.12.2 and 2.12.4.

5.3.1.7.5 Opening of hoistway doors. Hoistway doors shall be so arranged that it will not be necessary to reach behind any panel, jamb, or sash to operate them.

Delete and revise Sections 5.3.1.7.7 and 5.3.1.7.8 to read as follows:

5.3.1.7.7 Access to the hoistway for emergency purposes. Hoistway door unlocking devices shall be provided for all hoistway doors, conforming to Section 2.12.6.

5.3.1.7.8 Power operation of hoistway doors. Power opening shall be permitted for hoistway doors and shall conform to Sections 2.13.2.2.1 and 2.13.2.2.2. Power closing shall be permitted for hoistway doors and shall conform to Sections 2.13.3.2 through 2.13.4, and 2.13.6.

Delete and revise Section 5.3.1.8.2 to read as follows:

5.3.1.8.2 Car doors and gates. A car door or gate that, when closed, will guard the opening to a height of at least 1 675 mm (66 in.) shall be provided at each entrance to the car. Car doors shall be permitted to be of solid or openwork construction that will reject a ball 75 mm (3 in.) in diameter.

Collapsible car gates shall be of a design that, when fully closed (extended position), will reject a ball 75 mm (3 in.) in diameter.

(a) Power Operation of Car Doors and Gates. Power opening shall be permitted for car doors and shall conform to Sections 2.13.2.1 and 2.13.6. Power closing shall be permitted for car doors and shall conform to Sections 2.13.3 through 2.13.6. Power operation of gates is not permitted.

(b) Car Door or Gate Locking Devices. Where the hoistway enclosure is not continuous for the full travel of the car, the car door or gate shall be provided with a mechanical lock that will lock the car door or gate if the car is more than 150 mm (6 in.) away from a landing.

(c) Car Door or Gate Electric Contacts. Every car door or gate shall be provided with an electric contact conforming to Sections 2.14.4.2.3 and 2.14.4.2.5.

(d) Strength and Deflection of Doors, Gates, and Their Guides, Guide Shoes, Track, and Hangers.

(1) Horizontal sliding car doors and gates shall be designed and installed to withstand a force of 335 N (75 lbf) applied horizontally on an area 100 mm by 100 mm (4 in. by 4 in.) at right angles to and at any location on the car door without permanent deformation. The deflection shall not exceed 19 mm (0.75 in.) and shall not displace the door from its guides or tracks. The force shall be applied while the door is in the fully closed position.

(2) Folding car doors shall be designed and installed to withstand a force of 335 N (75 lbf) applied horizontally using a 100 mm (4 in.) diameter sphere at any location within the folds on the car door without permanent deformation. The deflection shall not exceed 19 mm (0.75 in.) and shall not displace the door from its guides or tracks. The force shall be applied while the door is in the fully closed position.

The design of the car door or gate electric contacts shall be such that for a sliding door or gate, the car cannot move unless the door or gate is within 50 mm (2 in.) of the closed position. If the door or gate swings outward to open, the car door or gate must be closed and locked before the car can move.

Delete and revise Section 5.3.1.10.3 to read as follows:

5.3.1.10.3 Rise. The rise shall not exceed 18 m (60 ft).

Delete and revise Section 5.3.1.11.2 to read as follows:

5.3.1.11.2 Operation of safeties. The safety shall be of the inertia, rack and pinion, or other type operated by the action of a speed governor. If of the speed-governor type, the governor shall operate the safety at a maximum tripping speed of 0.38 m/s (75 ft/min).

Delete and revise Subsection (a) of Section 5.3.1.12.1 to read as follows:

5.3.1.12.1 Types permitted.

(a) Suspension means shall be not less than two wire ropes.

Delete and revise Section 5.3.1.12.4 to read as follows:

5.3.1.12.4 Arc of contact of suspension means on sheaves and sprockets. The arc of contact of a wire rope on a traction sheave shall be sufficient to produce traction under all load conditions up to rated load.

Delete and revise Subsection (b) of Section 5.3.1.16.1 to read as follows:

5.3.1.16.1 Overhead machinery beams and supports.

(b) Overhead Beams and Their Supports. Overhead beams and their supports shall be designed for not less than the sum of the following:

(1) the load resting on the beams and their supports, which shall include the complete weight of the machine, sheaves, controller, and any other equipment supported thereon

(2) the sum of the tension on all suspension ropes times 2

Delete and revise Subsection (a) of Section 5.3.1.16.2 to read as follows:

5.3.1.16.2 Driving machines: General requirements.

(a) Types of Driving Means. The driving means shall be one of the following types:

(1) traction

(2) winding drum (see Section 5.3.1.16.3)

(3) direct plunger hydraulic (see Section 5.3.2)

(4) roped-hydraulic (see Section 5.3.2)

(5) screw machine (see Section 5.3.1.16.4)

(6) rack-and-pinion, in jurisdictions enforcing NBCC

Delete and revise Section 5.3.1.16.4 to read as follows:

5.3.1.16.4 Screw machines. Screw machines, where used, shall conform to Sections 4.2.15 and 4.2.20, except that the rated speed shall not exceed 0.20 m/s (40 ft/min) and shall be provided with an overspeed governor.

Delete and revise Subsection (c) of Section 5.3.1.17.1 to read as follows:

5.3.1.17.1 Stopping devices required.

(c) If the driving machine is of the winding drum type

(1) a final terminal stopping device operated by the driving machine shall also be provided.

(2) driving-machine-operated final terminal stopping devices are not required when a lower final terminal stopping device is used in addition to the slack rope switch, and two independent upper final terminal stopping devices are provided. A separate device shall be used to operate the lower final terminal and one upper final terminal stopping devices. All final terminal stopping and slack-rope devices shall operate independently of one another. The power feed lines to the driving machine and brake shall be opened by one or both of the upper final terminal stopping devices and either the slack-rope switch or the lower terminal stopping device, or both.

(3) indirect connections between the final terminal stopping device and the driving machine shall be designed to prevent slippage.

Delete and revise Section 5.3.1.18.2.2 to read as follows:

5.3.1.18.2.2 Monitoring of the car door or gate switch electric contacts. The elevator controls shall be designed in such a manner that when the car stops at a floor and the landing door and its related electric contact are opened and closed and the car door or gate switch electric contact(s) fails to open, the car shall not be permitted to respond to a call. The car shall be permitted to answer a call only after the car door or gate switch electric contacts have cycled at least once.

Delete and revise Section 5.3.1.18.8 to read as follows:

5.3.1.18.8 Slack-rope devices for winding drum driving machines. Winding drum machines with rope suspension shall be provided with a slack-rope device of the manually reset type that will remove power from the motor and brake if the car is obstructed in its descent and the hoisting ropes slacken.

5.3.2 Private residence hydraulic elevators.

Delete and revise Section 5.3.2.2.1 to read as follows:

5.3.2.2.1 Direct-plunger and roped-hydraulic private residence elevator driving machines, sheaves, valves, supply piping, fittings, and tanks shall conform to Sections 3.18, 3.19, and 3.24, except as modified by 5.3.1.16.2 and 5.3.2.

Delete and revise Section 5.3.2.3 to read as follows:

5.3.2.3 Terminal stopping devices. Direct-plunger and roped-hydraulic private residence elevator terminal stopping devices shall conform to Section 3.25, except as modified in 3.25.2.

SECTION 5.4
PRIVATE RESIDENCE INCLINED ELEVATORS

5.4.2 Landing enclosures and gates (where required).

Delete and revise the header of 5.4.2 to read as follows:

5.4.2 Landing enclosures and doors (where required).

Delete and revise Sections 5.4.2.2, 5.4.2.3, and 5.4.2.4 to read as follows:

5.4.2.2 Landing doors. Landing doors shall comply with Section 5.3.1.7.

5.4.2.3 Construction of landing enclosures and doors. The landing enclosure shall either be of solid construction or of openwork rejecting a 25 mm (1 in.) ball. A force of 670 N (150 lbf) applied at any area 100 mm x 100 mm (4 in. X 4 in.) on the walls of the enclosure shall not reduce the running clearance below 19 mm (0.75 in.) nor cause a deflection exceeding 25 mm (1 in.).

5.4.2.4 Clearance between landing doors and landing sills and car doors. Clearances shall conform to Section 5.3.1.7.2.

SECTION 5.5
POWER SIDEWALK ELEVATORS

5.5.1 Electric sidewalk elevators.

Delete and revise Section 5.5.1.17 to read as follows:

5.5.1.17 Car and counterweight safeties. Safeties shall conform to Section 2.17.

SECTION 5.12
OUTSIDE EMERGENCY ELEVATORS

Delete Section 5.12 in its entirety.

PART 6
ESCALATORS AND MOVINGS WALKS

SECTION 6.1
ESCALATORS

6.1.3 Construction requirements.

Delete and revise Section 6.1.3.3.5 to read as follows:

6.1.3.3.5 Skirt and step clearance.

6.1.3.3.5.1 Loaded gap between skirt and step. The clearance (loaded gap) between the step tread and the adjacent skirt panel shall be not more than 5 mm (0.2 in.) when 110 N (25 lbf) is laterally applied from the step to the adjacent skirt panel. The applied load shall not deviate from 110 N (25 lbf) by more than ± 11 N (2.5 lbf). The load shall be distributed over an area not less than 1 940 mm² (3 in.²) and not more than 3 870 mm² (6 in.²).

6.1.3.3.5.2 Clearance between skirt and step. The clearance on either side of the steps between the step and the adjacent skirt panel shall not be more than 4 mm (0.16 in.), and the sum of the clearances on both sides shall be not more than 7 mm (0.28 in.).

Delete and revise Subsection (c) of Section 6.1.3.3.6 to read as follows:

6.1.3.3.6 Skirt panels.

(c) The exposed surfaces of the skirt panels adjacent to the steps shall be smooth and made from a low friction material, or permanently treated with a friction-reducing material. Untreated surfaces, such as porcelain, enameled steel, bronze or stainless steel, are not acceptable.

Delete and revise the first paragraph of Section 6.1.3.3.10 to read as follows:

6.1.3.3.10 Skirt deflector devices. Deflector devices shall be required and shall extend from skirt panels parallel to the escalator path of travel. Means to secure such deflector devices are permitted to be on the exposed surface of the skirt. Any exposed fastener heads shall be of the tamper-resistant type and flush to within 1 mm (0.04 in.).

Add new Subsection 6.1.3.6.6 to read as follows:

6.1.3.6.6 Floor opening protection adjacent to escalator wellway. Floor openings adjacent to the entire length of the escalator wellway shall be provided with protection in accordance with the *New York City Building Code* (see Part 9).

6.1.6 Operating and safety devices.

Delete and revise Section 6.1.6.2 to read as follows:

6.1.6.2 Starting devices.

In every new and existing escalator, starting devices shall be provided with the combination of a starting switch and a starting button. The escalator shall be started only after the activation of both the switch and the button.

(a) Starting Switch. The starting switch shall be of continuous pressure spring return type and shall be operated by a cylinder type lock having five-pin, five-disc or five-tumbler combination. The starting switch shall be of three-position type and shall be clearly marked as follows:

NORMAL. A central position for the key entry and spring return position.

START-UP. A right side position for starting the escalator in the upward direction.

START-DOWN. A left side position for starting the escalator in the downward direction.

(b) Starting Button. The starting button shall be of the constant pressure type and located within six (6) inches from the starting switch. It shall be clearly marked “Start”.

(c) Cover Plate. The starting devices shall be protected by a locked, transparent cover plate that can be opened by the starting key and clearly marked “For Start Only.”

(d) Location of starting devices. Starting devices shall be located at top and bottom of the escalator on the right side-facing newel.

NOTE: The starting key shall be kept on the premises at all times and may only be accessible to persons authorized to start escalators. It shall also be made available to the Commissioner or his or her representative.

(e) The key shall be of Group 2 Security (see Section 8.1).

Delete and revise Subsection (a) of Section 6.1.6.3.1 to read as follows:

6.1.6.3.1 Emergency stop buttons.

(a) Location - A red stop button shall be visibly located at the top and bottom landings on the right side facing the escalator. Remote stop buttons are prohibited except that any

escalator connected to an automatic fire alarm system shall gradually stop the escalator at a rate not greater than 3 ft per sec² (0.91 m/s²) upon the activation of such system.

(1) On high deck balustrades, they shall be located on the curved newel deck in the upper quadrant, with the centerline of the button at a 45 deg angle from the horizontal.

(2) On low deck balustrades, they shall be located below the handrail height. The centerline of the button shall be located on a radial line 45 deg above the horizontal, such that no part of the button assembly is within 38 mm (1.5 in.) of the bottom of the handrail and the button is no more than 90 mm (3.5 in.) from the bottom of the handrail.

Delete and revise Section 6.1.6.3.6 to read as follows:

6.1.6.3.6 Skirt obstruction device. Means shall be provided to cause the electric power to be removed from the escalator driving machine motor and brake if an object becomes caught between the step and the skirt as the step approaches the upper combplate, intermediate device, or lower combplate. On units having a run of 6 096 mm (20 ft.) or more, intermediate devices shall be provided on both sides of the escalator with devices located at intervals of 3 048 mm (10 ft.) or less. The activation of an intermediate device shall gradually stop the escalator at a rate not greater than 3 ft per sec² (0.91 m/s²) in the direction of travel. The skirt obstruction devices shall be located so that the escalator will stop before that object reaches the combplate. The escalator shall stop before that object reaches the combplate with any load up to full brake rated load with escalator running. The device shall be of the manually reset type.

Delete and revise Section 6.1.6.3.9 to read as follows:

6.1.6.3.9 Step upthrust device. Means shall be provided in the passenger-carrying line of the track system to detect a step forced upward in the lower transition curve at or prior to the point of tangency of the horizontal and curved track. The means shall actuate when the riser end of the step is displaced upward more than 5 mm (0.20 in.) at the lower landing. Actuation of the means shall cause power to be removed from the driving-machine motor and brake. The escalator shall stop, before the detected step reaches the combplate with any load up to brake rated load with escalator running [see Subsections 6.1.3.9.3(a)(2) and (b)(2)]. The device shall be of the manual reset type.

Delete and revise Section 6.1.6.3.12 to read as follows:

6.1.6.3.12 Handrail entry device. A handrail entry device shall be provided at each newel. It shall be operative in the newels in which the handrail enters the balustrade. It shall cause the escalator to stop by removing power from the driving-machine motor and brake. It shall operate in either of two ways:

(a) if an object becomes caught between the handrail and the handrail guard.

(b) if an object approaches the area between the handrail and the handrail guard.

For those units that rely on an opening of the balustrade to prevent entrapment, all handrail entry devices shall be operative whenever the handrails are operating. The device shall be of the manual reset type.

Delete and revise Subsection (b) of Section 6.1.6.3.13 to read as follows:

6.1.6.3.13 Combplate impact devices. Devices shall be provided that will cause the opening of the power circuit to the escalator driving-machine motor and brake if either

(b) a resultant vertical force not greater than 268 N (60 lbf) in the upward direction is applied at the center of the front of the combplate.

These devices shall be of the manual-reset type.

Add new Sections 6.1.6.3.17 and 6.1.6.3.18 to read as follows:

6.1.6.3.17 Service ports. Service ports used for diagnostic purposes or for resetting faults shall be placed in a location accessible only to elevator personnel.

6.1.6.3.18 Phase protection of motors. Escalators having a polyphase AC power supply shall be provided with means to prevent the operation of the escalator drive motor if a reversal of phase rotation, or phase failure of the incoming polyphase AC power, will cause the escalator to operate in the wrong direction.

Delete and revise Section 6.1.6.4 to read as follows:

6.1.6.4 Handrail speed monitoring device. A handrail speed monitoring device shall be provided that will cause the activation of the alarm required by Subsection 6.1.6.3.1(b) without any intentional delay, whenever the speed of either handrail deviates from the step speed by 15% or more. The device shall also cause electric power to be removed from the driving-machine motor and brake when the speed deviation of 15% or more is continuous within a 2 s to 6 s range. The device shall be of the manual reset type.

Delete and revise Section 6.1.6.7 to read as follows:

6.1.6.7 Step demarcation lights. Green step demarcation lights shall be located below the step at both landings in an area not to exceed 400 mm (16 in.) from the combplate. The lamps shall be LED type and activated whenever the escalator is in operation.

Delete and revise Section 6.1.6.9.3 to read as follows:

6.1.6.9.3 Additional signs, video displays or graphics. Signs, video displays or graphics other than those specified in Sections 6.1.6.9.1 and 6.1.6.9.2 shall not be permitted adjacent to the escalator in such a manner that obstructs boarding passenger view of the signs required in Section 6.1.6.9.1, obstructs or reduces passenger access to the handrails, within the safety zone (see Section 6.1.3.6.4), nor on the escalator, except for signs, graphics, or markings required by this Code, manufacturer's identification, and owner's identification that are permitted on the

escalator. They shall not be distracting, create passenger flow hazards, or impair function of safety devices. Step, step riser, handrail and balustrade signs or graphics are not permitted.

6.1.7 Lighting, access, and electrical work.

Delete and revise Section 6.1.7.3.2 to read as follows:

6.1.7.3.2 Access plates at the top and bottom landings shall be securely fastened by a mechanical means. Access plate(s) shall be provided with electrical switches that will remove power to the driving machine and brake should the access plate be displaced or removed.

Add new Sections 6.1.9 and 6.1.10 to read as follows:

6.1.9 New York City identification number.

Each escalator shall be assigned a unique numerical identification a minimum of 6 mm (0.25 in) in height. The city identification number shall be applied on the right hand side, facing the newel, at the top and bottom of the escalator as well as the following locations:

(a) The driving machine;

(b) Controller;

(c) Main line disconnect switch.

6.1.10 Building identification number.

Each escalator shall be assigned a unique alpha-numeric or numerical identification, a minimum of 6 mm (0.25 in) in height. The building identification number shall be applied on the exterior, clearly visible, at the top or bottom of the escalator.

SECTION 6.2 **MOVING WALKS**

6.2.6 Operating and safety devices.

Delete and revise Section 6.2.6.2 to read as follows:

6.2.6.2 Starting and inspection control switches.

In every new and existing moving walk, starting devices shall be provided with the combination of a starting switch and a starting button. The moving walk shall be started only after the activation of both the switch and the button.

(a) Starting Switch. The starting switch shall be of continuous pressure spring return type and shall be operated by a cylinder type lock having a five-pin, five-disc or five-tumbler combination. The starting switch shall be of three-position type and shall be clearly marked as follows:

TOWARDS. A left side position for starting the moving walk in the towards direction.

RUN (NORMAL). A central position for the key entry and spring return position.

AWAY. A right side position for starting the moving walk in the away direction.

(b) Starting Button. The starting button shall be of the constant pressure type and located within six (6) inches from the starting switch. It shall be clearly marked "Start".

(c) Cover Plate. The starting devices shall be protected by a locked, transparent cover plate that can be opened by the starting key and clearly marked "For Start Only."

(d) Location of starting devices. Starting devices shall be located at top and bottom of the moving walk on the right side-facing newel.

NOTE: The starting key shall be kept on the premises at all times and may only be accessible to persons authorized to start escalators. It shall also be made available to the Commissioner or his or her representative.

Delete and revise 6.2.6.3.10 to read as follows:

6.2.6.3.10 Handrail entry device. A handrail entry device shall be provided at each newel. It shall be operative in the newels in which the handrail enters the balustrade. It shall cause the moving walk to stop by removing power from the driving-machine motor and brake. It shall operate in either of the following two ways:

(a) if an object becomes caught between the handrail and the handrail guard

(b) if an object approaches the area between the handrail and handrail guard

For those units that rely on an opening of the balustrade to prevent entrapment, all handrail entry devices shall be operative whenever the handrails are operating. The device shall be of the manual reset type.

Delete and revise Subsection (b) of 6.2.6.3.11 to read as follows:

6.2.6.3.11 Combplate impact devices. Devices shall be provided that will cause the opening of the power circuit to the moving walk driving-machine motor and brake if either

(b) a resultant vertical force not greater than 268 N (60 lbf) in the upward direction is applied at the center of the front of the combplate.

Add new Subsections 6.2.6.3.13 and 6.2.6.3.14 to read as follows:

6.2.6.3.13 Service ports. Service ports used for diagnostic purposes or for resetting faults shall be placed in a location accessible only to elevator personnel.

6.2.6.3.14 Phase protection of motors. A moving walk having a polyphase AC power supply shall be provided with means to prevent the operation of the moving walk drive motor if a reversal of phase rotation, or phase failure of the incoming polyphase AC power, will cause the moving walk to operate in the wrong direction.

Delete and revise Section 6.2.6.4 to read as follows:

6.2.6.4 Handrail speed monitoring device. A handrail speed monitoring device shall be provided that will cause the activation of the alarm required by Subsection 6.2.6.3.1(b) without any intentional delay whenever the speed of either handrail deviates from the treadway speed by 15% or more. The device shall also cause electric power to be removed from the driving-machine motor and brake when the speed deviation of 15% or more is continuous within a 2 s to 6 s range. The device shall be of the manual reset type.

Delete and revise Section 6.2.6.8.3 to read as follows:

6.2.6.8.3 Additional signs, video displays or graphics. Signs, video displays or graphics other than those specified in Sections 6.2.6.8.1 and 6.2.6.8.2 shall not be permitted adjacent to the walk in such a manner that obstructs boarding passenger view of the signs required in Section 6.2.6.9.1, obstructs or reduces passenger access to the handrails, within the safety zone, nor on the moving walk, except for signs, graphics, or markings required by this Code, manufacturer's identification, and owner's identification that are permitted on the moving walk. They shall not be distracting, create passenger flow hazards, or impair function of safety devices. Pallet, handrail and balustrade signs or graphics are not permitted.

6.2.7 Lighting, access, and electrical work.

Delete and revise Section 6.2.7.3.2 to read as follows:

6.2.7.3.2 Access plates at the top and bottom landings shall be securely fastened by a mechanical means. Access plate(s) shall be provided with electrical switches that will remove power to the driving machine and brake should the access plate be displaced or removed.

Add new Sections 6.2.9 and 6.2.10 to read as follows:

6.2.9 New York City identification number.

Each moving walk shall be assigned a unique numerical identification a minimum of 6 mm (0.25 in) in height. The city identification number shall be applied on the right hand side, facing the newel, at the entrance and exit of the moving walk as well as the following locations:

- (a) The driving machine;
- (b) Controller;
- (c) Main line disconnect switch.

6.2.10 Building identification number.

Each moving walk shall be assigned a unique alpha-numeric or numerical identification, a minimum of 6 mm (0.25 in) in height. The building identification number shall be applied on the exterior, clearly visible, at the entrance and exit of the moving walk.

PART 7
DUMBWAITERS AND MATERIAL LIFTS

SECTION 7.1
POWER AND HAND DUMBWAITERS WITHOUT AUTOMATIC TRANSFER DEVICES

7.1.4 Vertical car clearances and runbys for car and counterweights.

Delete and revise Section 7.1.4.3.1 to read as follows:

7.1.4.3.1 Horizontal unobstructed area on the car top of not less than 0.370 m² (570 in.²) and measured not less than 500 mm (20 in.) on one side.

SECTION 7.4
MATERIAL LIFTS WITHOUT AUTOMATIC TRANSFER DEVICES

7.4.2 Classification.

Delete and revise Sections 7.4.2.1 and 7.4.2.2 to read as follows:

7.4.2.1 Type A Material Lifts shall conform to ASME B20.1.

7.4.2.2 Type B Material Lifts are not permitted.

7.4.3 Construction of Hoistways and hoistway enclosures.

Delete Section 7.4.3 in its entirety.

7.4.4 Pits.

Delete Section 7.4.4 in its entirety.

7.4.5 Location and guarding of counterweights.

Delete Section 7.4.5 in its entirety.

7.4.6 Vertical clearances and runbys for cars and counterweights.

Delete Section 7.4.6 in its entirety.

7.4.7 Horizontal car and counterweight clearances.

Delete Section 7.4.7 in its entirety.

7.4.8 Protection of spaces below hoistways.

Delete Section 7.4.8 in its entirety.

7.4.9 Machinery spaces, machine rooms, control spaces, and control rooms.

Delete Section 7.4.9 in its entirety.

7.4.10 Equipment in hoistways and machine rooms.

Delete Section 7.4.10 in its entirety.

7.4.11 Machinery and sheave beams, supports, and foundations.

Delete Section 7.4.11 in its entirety.

7.4.12 Guarding of equipment and standard railing.

Delete Section 7.4.12 in its entirety.

7.4.13 Protection of hoistway landing openings.

Delete Section 7.4.13 in its entirety.

7.4.14 Hoistway door locking devices and electric contracts, and hoistway access switches.

Delete Section 7.4.14 in its entirety.

7.4.15 Power operation of hoistway doors and car doors and gates.

Delete Section 7.4.15 in its entirety.

7.4.16 Identification of equipment.

Delete Section 7.4.16 in its entirety.

SECTION 7.5

ELECTRIC MATERIAL LIFTS WITHOUT AUTOMATIC TRANSFER DEVICES

Delete Section 7.5 in its entirety.

SECTION 7.6

HYDRAULIC MATERIAL LIFTS WITHOUT AUTOMATIC TRANSFER DEVICES

Delete Section 7.6 in its entirety.

SECTION 7.7
AUTOMATIC TRANSFER DEVICES

Delete Section 7.7 in its entirety.

SECTION 7.9
ELECTRIC MATERIAL LIFTS WITH AUTOMATIC TRANSFER DEVICES

Delete Section 7.9 in its entirety.

SECTION 7.10
HYDRAULIC MATERIAL LIFTS WITH AUTOMATIC TRANSFER DEVICES

Delete Section 7.10 in its entirety.

SECTION 7.11
MATERIAL LIFTS WITH OBSCURED TRANSFER DEVICES

Delete Section 7.11 in its entirety.

PART 8
GENERAL REQUIREMENTS

SECTION 8.1
SECURITY

8.1.4 Group 3: Emergency Operation.

Add new subsection (e) to the Note of Section 8.1.4 to read as follows:

NOTE: See the following:

(e) Firefighters Emergency Operation Phase I and Phase II and Occupant Evacuation Operation shall be by New York City standard key 2642 and FDNY standard key 1620.

SECTION 8.5
ESCALATOR AND MOVING WALK SAFETY REQUIREMENT FOR SEISMIC RISK
ZONE 2 OR GREATER

Delete and revise the title of Section 8.5 to read as follows:

SECTION 8.5
ESCALATOR AND MOVING WALK SEISMIC REQUIREMENTS

Delete and revise the first paragraph of Section 8.5 to read as follows:

(a) Section 8.5 applies to all escalators and moving walks where such equipment is installed in buildings assigned to one of the following:

(1) Seismic Design Category C with Component Importance Factor, I_p , equal to 1.5 as defined by the *New York City Building Code*

(2) Seismic Design Category D or greater as defined by the *New York City Building Code*

(3) Design Spectral Response Acceleration for a 0.2 s time period [$S_a(0.2)$] greater than 0.12 and building designated as *post-disaster building*

(4) Seismic Performance Category C with Seismic Hazard Exposure Group II or higher as defined by earlier model building codes (see Note)

(5) Seismic Risk Zone 2 or greater as defined by earlier building codes (see Note)

NOTE [8.5(a)(4) and (a)(5)]: For example, SBC 1982, SBC 1994, etc.

(b) The appropriate Escalator Seismic Force Level is determined by the applicable building code.

(1) Where the applicable building code references Seismic Design Categories or Design Spectral Response Acceleration [$S_a(0.2)$], force levels as referenced by Section 8.4.14 shall be used (see the *New York City Building Code*).

(2) Where the applicable building code makes reference to ground motion parameters (such as A_v or Z_v), Section 8.4.13 shall be used.

(3) Where the applicable building code makes reference to Seismic Risk Zones or to Seismic Risk Zones and component force level equations, force levels for the appropriate zone, as listed throughout Section 8.5, or the calculated component force level, whichever is greater, shall be used.

(c) The escalator and moving walk safety requirements contained in Section 8.5 shall be used considering the requirements in the other parts of the code. These requirements are to be applied as well as those in Sections 6.1 and 6.2 but are not additive. Where multiple requirements are applicable to the same component, the most stringent requirement shall control.

8.5.1 Balustrade Construction.

Delete and revise Section 8.5.1 to read as follows:

8.5.1 Balustrades shall be designed to withstand the vertical inertial force due to the weight of the balustrade and the horizontal seismic forces as follows:

(a) The component operating weight, W_p , is the sum of the balustrade dead load, decking weight if supported by the balustrade, and 70% of the machinery rated load (see Section 6.1.3.9.2) and the seismic force computed as defined in Sections 8.4.13 and 8.4.14.

(b) The seismic forces resulting from the machinery rated load shall be distributed along the exposed length of the handrail from entry newel tangent to exit newel tangent as depicted in Fig. 8.5.1.

Figure 8.5.1 Balustrade Handrail Force.

Add Figure 8.5.1 to read as follows:

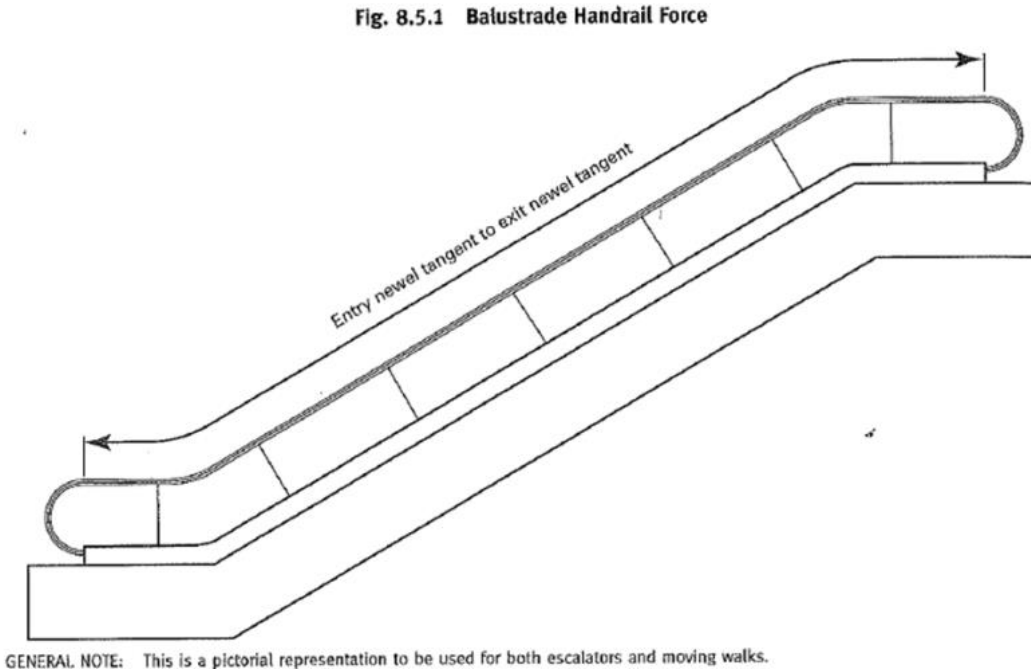

8.5.2 Truss Members.

Delete and revise Section 8.5.2 to read as follows:

8.5.2 Structural items not covered in Table 8.5.5 shall be capable of withstanding the inertia effect of the applicable masses without permanent deformation.

(a) For jurisdictions enforcing seismic zones or an equivalent ground motion parameter (see 8.4.13), the horizontal (see Section 8.5.2.1) and vertical (see Section 8.5.2.2) seismic forces shall be applied separately (not simultaneously).

(b) Earthquake forces shall be applied simultaneously as defined by Section 8.4.14, except $W_p = W_t + W_r$ where

$W_r = 25\%$ of the structural rated load calculated per Section 6.1.3.9.1

$W_t =$ total dead load of the escalator, including all components supported by the truss.

Delete and revise Section 8.5.2.1 to read as follows:

8.5.2.1 For jurisdictions enforcing seismic zones or an equivalent ground motion parameter, horizontal seismic forces shall be based on the total dead load of the escalator, including all components supported by the truss, plus 25% of the structural rated load in accordance with Section 6.1.3.9.1. The horizontal seismic force shall be computed as follows:

$$F_p = ZIC_p(W_t + W_r)$$

where

C_p = horizontal seismic force factor

F_p = total horizontal seismic force

I = importance factor

Z = seismic zone factor

= 0.25 for seismic zone 2

= 0.5 for seismic zone 3 or greater

Where the applicable building code does not make reference to seismic risk zones, the ground motion parameters shown in Section 8.4.13 shall be used.

Revise the first sentence of section Section 8.5.2.1.2 to read as follows:

The escalator or moving walk is not considered a structural component of the building.

Revise the NOTE following Section 8.5.2.1.3 to read as follows:

NOTE: When any portion of the escalator is more than six stories above grade, other values of C_p may apply and should be determined based upon the fundamental period of the building.

Delete and revise Section 8.5.2.2 to read as follows:

8.5.2.2 For jurisdictions enforcing seismic zones or an equivalent ground motion parameter, vertical forces shall be structurally allocated among all the supports. The total vertical force shall be defined by the following table:

<u>Zone</u>	<u>Total Vertical Force, F_{tv}</u>
<u>2</u>	<u>$(1 \pm 0.25)(W_t + W_r)$</u>
<u>3 or greater</u>	<u>$(1 \pm 0.50)(W_t + W_r)$</u>

8.5.3 Supporting Connections Between the Truss and the Building.

Delete and revise Section 8.5.3.1 to read as follows:

8.5.3.1 The truss end supports shall provide motion restraint in the principle horizontal directions capable of withstanding the seismic forces acting upon the escalator or moving walk. The clearance in the transverse direction between the escalator truss and the seismic restraint shall not exceed 6.5 mm (0.25 in.) on each side. Motion restraint in the longitudinal direction at either or both end supports shall accommodate the design story drift (see Section 8.5.3.2.2). Vertical restraint is required when the resultant vertical seismic force exceeds $W_t + W_r$ (see Section 8.5.2.2). Where one end of the truss uses an unfastened restraint, forces resulting from movement of building structure members are not considered as being applied to the truss.

Delete and revise Section 8.5.3.2 to read as follows:

8.5.3.2 Truss end supports shall accommodate the design story drift (see Section 8.5.3.2.2) in the longitudinal direction such that

(a) clearance between the truss and the building is sufficient to prevent truss compression damage.

(b) seat depth (the longitudinal overlap and bearing surface between the building support and the truss support) is sufficient to prevent disengagement of the truss end with the building support.

Delete and revise Section 8.5.3.2.1 to read as follows:

8.5.3.2.1 When one end of the escalator truss is not designed to accommodate story drift, the design shall account for the forces developed by building movement in a manner that restricts transfer of these forces to the truss. The other truss end support shall be free to slide in the longitudinal direction to accommodate the design story drift. When both ends are designed to accommodate story drift

(a) means shall be provided to prevent any truss end from disengaging from its building support seat.

(b) the end supports shall be permitted to be free to slide in the longitudinal direction such that the sum of the motions accommodates the total design story drift.

Delete and revise Section 8.5.3.2.2 to read as follows:

8.5.3.2.2 At the sliding end(s), the depth of the beam seat shall be capable of accommodating the design story drift. The design story drift shall have a minimum value of 1.5 times the building story drift, as obtained from either of the following:

(a) the structural engineer or record.

(b) the maximum story drift value as per ASCE/SEI-7, Table 12.2.-1.

NOTE [8.5.3.2.2(b)]: ASCE/SEI-7, Table 12.2-1 specifies a maximum story drift of $0.025 h_{sx}$ where h_{sx} is the building story height.

Add new Section 8.5.3.3 to read as follows:

8.5.3.3 Intermediate support(s) for escalators and moving walks, when used, shall be of sufficient size to accommodate design story drift movement in both the longitudinal and transverse directions. Any motion restraint provided shall not reduce the story drift capacity of the support.

8.5.4 Earthquake Protective Devices.

Delete and revise Section 8.5.4 to read as follows:

8.5.4 Earthquake protective devices shall be of the failsafe type. A minimum of one seismic detection device shall be provided in each escalator (nontandem operation or non-side-by-side arrangement) or moving walk. For escalators or moving walks in a tandem operation (see Section 6.1.6.6) or side-by-side arrangement, a minimum of one seismic detection device is required. The seismic detection device shall be mounted in the machine space or adjacent to the escalator or moving walk. Where possible, a seismic detection device shall be mounted adjacent to a vertical load-bearing building structural member when installed at an elevation above ground level, or any structural member if mounted at or below ground level, or any other location approved by the structural engineer of record.

(a) The seismic detection device shall conform to Sections 8.4.10.1.2(a) and (b).

(b) Actuation of the seismic detection device shall cause removal of power from the escalator and moving walk driving-machine motor(s) and brake(s) on all units controlled by the seismic detection device.

(c) Where a seismic detection device is used exclusively to control the escalator or moving walk, it shall be located in a machine room or machinery space and, where possible, shall be mounted adjacent to a vertical load-bearing member. Should no vertical load-bearing member be in close proximity, it shall be permitted to locate the seismic detection device at the nearest accessible vertical load-bearing member at approximately the same horizontal level as the upper machinery space or machine room.

Add new Section 8.5.5 to read as follows:

8.5.5 Allowable Stresses Applicable to Seismic Design. The allowable stress limits to be used in the design of all escalator and moving walk components are listed in Table 8.5.5. An escalator or moving walk subjected to seismic loading shall be capable of withstanding the specified seismic forces in combination with the dynamic or static loads occurring during normal operation.

Add Table 8.5.5 to read as follows:

<u>TABLE 8.5.5 Component-Based Allowable Design Stresses</u>			
<u>Component</u>	<u>Allowable Design Parameter</u>		
	<u>Seismic Zones Criteria</u> <u>[Note(1)]</u>	<u>Building Code</u>	
		<u>IBC, ASCE/SEI-7</u>	<u>NBCC 2005 or Later</u>
<u>Structural, steel</u>	$0.88F_y$	$0.6F_y$	$0.6F_y$
<u>Structural, other materials</u>	<u>Follow allowable limits as recommended by design specifications for material of use</u>	<u>Follow allowable limits as recommended by design specifications for material of use</u>	<u>Follow allowable limits as recommended by design specifications for material of use</u>
<u>Balustrades</u>	$\leq F_y$	$0.6F_y$	$0.6F_y$
<u>Structural glass in balustrades</u>	<u>Minimum factor of safety = 2 based on the modulus of rupture</u>	<u>Minimum factor of safety = 2 based on the modulus of rupture</u>	<u>Minimum factor of safety = 2 based on the modulus of rupture</u>
<u>Structural fastenings and/or connections</u>	<u>See 8.4.2.3.3</u>	<u>Per 8.4.2.3</u>	<u>Per 8.4.2.3</u>

GENERAL NOTE: F_y = yield strength.

NOTE:

(1) See Section 8.5.2(a).

SECTION 8.6
MAINTENANCE, REPAIR, REPLACEMENT, AND TESTING

8.6.1 General requirements.

Delete and revise Subsection (d) of Section 8.6.1.4.1 to read as follows:

8.6.1.4.1 On-site maintenance records.

(d) Permanent Record. A permanent record of the results of all acceptance tests as required by Sections 8.10.1.1.4 and 8.10.1.1.5 shall be kept with the on-site records. Test tags, complying with Section 2.16.3.3 for marking plates permanently attached to or adjacent to the controller, shall meet this requirement.

NOTE: This requirement does not apply to equipment installed under ASME A17.1-2010 and earlier editions.

Add new Note to Section 8.6.1.7.2 to read as follows:

8.6.1.7.2 Periodic test record.

NOTE: See Section 8.11.1.6 for test tag requirements.

8.6.3 Replacements.

Delete Section 8.6.3.2.2 in its entirety.

8.6.4 Maintenance and testing of electric elevators.

Delete and revise section 8.6.4.1.3 to read as follows:

8.6.4.1.3 Equal tension shall be maintained between individual suspension members in each set. Suspension members are considered to be equally tensioned when the smallest tension measured is within 10 percent of the highest tension measured. When suspension member tension is checked or adjusted, an anti-rotation device conforming to the requirements of Section 2.20.9.8 shall be required.

Delete and revise Section 8.6.4.6 to read as follows:

8.6.4.6.1 The driving-machine brake and emergency brake, where provided, shall be maintained annually to ensure proper operations, including, but not limited to the following:

- (a) residual pads (antimagnetic pads)
- (b) lining and running
- (c) springs
- (d) sleeves and guide bushings
- (e) discs and drums
- (f) brake coil and plunger
- (g) brake monitoring device, where provided

8.6.4.6.1.1 Brake maintenance shall be entered into the maintenance records.

8.6.4.6.1.2 A metal tag indicating the elevator maintenance company and date of service shall be attached to the elevator controller.

8.6.4.6.2 If any part of the driving-machine brake is changed or adjusted that can affect the holding capacity or decelerating capacity of the brake when required (see Section 2.24.8.3), it shall be adjusted and checked by means that will verify its proper function and holding capacity. A test complying with Section 8.6.4.20.4 shall be performed. When springs or brake pads are replaced, a brake load test shall be performed per Subsection 8.10.2.2.2(v).

8.6.4.6.3 If any part of the emergency brake is changed or adjusted that can affect the holding capacity or decelerating capacity of the emergency brake when required (see Section 2.19.3), it

shall be adjusted and checked by means that will verify its proper function and holding capacity. When springs or brake pads are replaced, a brake load test shall be performed.

Delete and revise Section 8.6.4.8.3 to read as follows:

8.6.4.8.3 Flammable and combustible liquids shall not be stored in machine rooms and spaces unless they are in compliance with NFPA 13, as modified by New York City Fire Code and New York City Building Code.

Delete and revise Section 8.6.4.10.1 to read as follows:

8.6.4.10.1 General.

(1) The hoisting ropes of elevators having winding-drum driving-machines with 1:1 roping, if of the babbitted rope socket type, shall be resocketed at intervals no longer than:

(a) 1 year, for machines located over the hoistway;

(b) 2 years, for machines located below or at the side of the hoistway;

(c) 4 years, for all counterweight cable ends of drum machines;

(2) In addition to the foregoing requirements, rope fastenings shall be resocketed when an inspection reveals any evidence of failure at the shackle regardless of the period of time since last re-shackling.

(3) Where auxiliary rope-fastening devices conforming to the requirements of Section 2.20.10 or where car hoist ropes with additional approved type emergency clamping devices are installed, refastening at the period specified is not required provided that, where such devices are installed, all hoisting ropes shall be refastened on the failure or indication of failure of any rope fastening. Wedge clamp shackles shall not be used on drum machines.

(4) Where the elevator is equipped with a drum counterweight, the fastenings shall be examined for fatigue or damage at the socket. Where fatigue or damage is detected, the ropes shall be refastened in conformance with Section 8.6.4.10.2.

Delete and revise Section 8.6.4.10.3 to read as follows:

8.6.4.10.3 Tags. A legible metal tag shall be securely attached through one of the tapered rope sockets during each resocketing (as shown in the diagram below), and shall bear the following information:

(a) The name of the person or firm who performed the resocketing; and

(b) The date on which the rope was resocketed.

The material and marking of the tags shall conform to Section 2.16.3.3, except that the height of the letters and figures shall be not less than 1.5 mm (0.0625 in.).

Delete and revise Section 8.6.4.19.6 to read as follows:

8.6.4.19.6 Firefighters' Emergency Operation. Firefighters' Emergency Operation (Phase I and II) shall be tested to determine conformance with the applicable requirements. Phase I recall shall be tested by individually activating fire alarm initiating device inputs to the elevator control, the key switch at the designated landing and, where provided, the switch at the building fire control station (Part 6).

Delete and revise Section 8.6.4.19.14 to read as follows:

8.6.4.19.14 Occupant Evacuation Operation. See Section 8.6.11.13.

Delete and revise Section 8.6.4.20.1 to read as follows:

8.6.4.20.1 Car and counterweight safeties. Types A, B, and C car and counterweight safeties shall be tested in accordance with Subsection 8.6.4.20.1(a)

(a) Rated Load and Rated Speed Test. Car safeties, except those operating on wood guide rails, and their governors, shall be tested with rated load in the car. Counterweight safety tests shall be made with no load in the car. Tests shall be made by tripping the governor by hand at the rated speed. The following operational conditions shall be checked (Item 2.29.2):

(1) Type B safeties shall stop the car with the rated load within the required range of stopping distances for which the governor is tripped (Item 2.29.2) and the level of the platform checked for conformance to Section 2.17.9.2.

(2) For Type A safeties and Type A safety parts of Type C safeties, there shall be sufficient travel of the safety rollers or dogs remaining after the test to bring the car and its rated load to rest on safety application at governor tripping speed. The level of the platform shall be checked for conformance to Section 2.17.9.2.

Delete and revise Section 8.6.4.20.3 to read as follows:

8.6.4.20.3 Oil buffers.

(a) Car oil buffers shall be tested to determine conformance with the applicable requirements by running the car onto the buffer with rated load at rated speed.

(b) For reduced stroke buffers, this test shall be made at the reduced striking speed permitted (Item 5.9.2.1).

(c) This test is not required where a Type C safety is used (see Section 8.6.4.20.1).

(d) In making these tests, the normal and emergency terminal stopping devices shall be made temporarily inoperative. The final terminal stopping devices shall remain operative and be temporarily relocated, if necessary, to permit compression of the buffer during the test.

(e) After completion of the test, a metal tag, indicating the date of the test, together with the name of the person or firm who performed the test, shall be attached to the buffer [Item 5.3.2(b)].

(f) Counterweight oil buffers shall be tested by running the counterweight onto its buffer at rated speed with no load in the car, except as specified in Subsections 8.6.4.20.3(b) and (c) (Item 5.9.2.1), or at reduced speed if the requirements of Section 8.6.11.10 are met.

(g) A test tag as required in Section 8.6.1.7.2 shall be provided.

Delete Subsection (b) of Section 8.6.4.20.4 in its entirety.

Delete Subsection (b) of Section 8.6.4.20.10 in its entirety.

8.6.8 Maintenance and testing of escalators and moving walks.

Delete and revise Section 8.6.8.2 to read as follows:

8.6.8.2 Step-to-skirt clearance. Clearances shall be maintained in compliance with the applicable codes, and the clearance on either side of the steps and between the steps and the adjacent skirt guard shall not exceed 4 mm (0.16 in.), and the sum of the clearances on both sides shall not exceed 7 mm (0.28 in.).

Delete Section 8.6.8.3 in its entirety.

Delete Section 8.6.8.15.19 in its entirety.

8.6.11 Special provisions.

Delete Section 8.6.11.10 in its entirety.

Delete and revise Section 8.6.11.13 to read as follows:

8.6.11.13 Occupant Evacuation Operation. All elevators provided with Occupant Evacuation Operation shall be subjected, by authorized personnel, to a check of the operation in conjunction with the fire alarm system testing in accordance with the requirements of NFPA 72, as modified by Appendix Q of the New York City Building Code and any applicable rules. Deficiencies shall be corrected. A record of findings shall be available to elevator personnel and the commissioner. These tests and inspections are not part of the Category 1 or Category 5 tests or inspections.

8.7.2 Alterations to electric elevators.

Add new Section 8.7.2.10.6 to read as follows:

8.7.2.10.6 Intermediate hoistway entrances placed out of service. Where permitted by the *New York City Building Code*, an intermediate hoistway entrance placed out of service shall comply with the following:

(a) Interlocks shall remain in the safety circuit with door panel(s) separately secured in closed position on the hoistway side.

(b) Eliminate the capability of automatic elevators from opening the car doors at the floor placed out of service.

(c) Egress, Accessibility and Firefighters' Emergency Operation.

(d) Associated labeling and signaling shall be removed.

Delete and revise Subsection (c) of Section 8.7.2.13 to read as follows:

8.7.2.13 Door reopening device. Where a reopening device for power-operated car doors or gates is added or is part of an alteration to the door system, the following requirements shall apply:

(c) when firefighters' emergency operation is provided, door reopening devices and door closing on Phase I and Phase II shall comply with the requirements of Subsection 2.27.3.1.6(e).

Delete and revise Section 8.7.2.14.1 to read as follows:

8.7.2.14.1 Where an alteration consists of the installation of a new car, the installation shall conform to Sections 2.12.6, 2.14, 2.15, and 2.17 (see also 8.7.2.15.1).

Delete and revise Subsection (e) of Section 8.7.2.14.2 to read as follows:

8.7.2.14.2 The following requirements shall be conformed to where alterations are made to existing cars:

(e) All side emergency exits shall be permanently fixed in the closed position. The corresponding side emergency exit on an adjacent car shall also be fixed in the closed position. The installation shall comply with Section 2.12.6.

Delete and revise Subsection (b) of Section 8.7.2.14.3 to read as follows:

8.7.2.14.3 Where any alteration is made to the car enclosure, other than as specified in 8.7.2.14.2, the installation shall conform to the following:

(b) Where an existing enclosure other than as specified in Subsection 8.7.2.14.3(a) is retained and new material is installed, the new material and adhesive shall conform to the following requirements, based on the tests conducted in accordance with the requirements of ASTM E84, ANSI/UL 723, or CAN/ULC-S102:

(1) flame spread rating of 0 to 50

(2) smoke development of 0 to 100

If the material or combination of materials installed exceeds 6.4 mm (0.25 in.) in thickness, the car enclosure shall conform to Section 2.14.2.1.1.

Add new Section 8.7.2.15.2.1 to read as follows:

8.7.2.15.2.1 When weight is added or removed from a counterweighted elevator, the counterbalance prior to the alteration shall be maintained.

Add new Items (4) and (5) to Subsection (c) of Section 8.7.2.17.1 to read as follows:

8.7.2.17.1 Increase or decrease in rise. Where an alteration involves an increase or decrease in the rise, the following requirements shall be conformed to:

(c) The bottom and top clearances and runbys for cars and counterweights shall conform to Section 2.4, except as follows:

(4) Where the only hoistway alteration is the decrease in travel at the upper end of the travel, the installation shall be modified as follows:

(i) Terminal stopping devices shall be provided based on the new top terminal landing location and the final limit switch shall be of the manual reset type.

(ii) A key controlled switch shall be provided in accordance with Section 8.1.5 (i.e. Group 4) requirements to by-pass the new top terminal stopping devices, when the elevator transfer switch is placed in the Top-of-Car Inspection Operation position, for access to the hoistway above the terminal landing.

The switch shall be manually operated, be labeled “Terminal By-Pass”, and shall have two positions; By-Pass and Normal.

The switch shall be located in the hoistway in the vicinity of the terminal limits and shall be accessible to a person standing on the car top. The car transfer switch shall not be removed from the Top-of-Car Inspection Operation position until the terminal limit By-Pass switch is placed in the Normal position.

(iii) Existing terminal stopping devices shall remain functional. The hoistway door electro-mechanical safety interlocks shall remain in the safety circuit and locked with door panel(s) separately secured in closed position on the hoistway side.

(iv) Associated floor labeling and signaling shall be removed.

(5) For manually operated elevators, as an exception to Item 4, the hoist ropes shall be extended and the upper limit switches shall be lowered to the new top terminal landing. Access for maintenance and inspection of the equipment at the top of the hoistway shall be provided.

Add new Subsections (b)(5) and (c)(10) to Section 8.7.2.27.4 to read as follows:

8.7.2.27.4 Controllers.

(b) Where an operation controller is installed, and the type of operation control, if automatic remains automatic, or, if nonautomatic remains continuous pressure, car switch, or other type of operation where the movement or stopping of the car is under the manual control of the operator (non-automatic), and the existing motion control equipment is retained, the installation shall conform to the following:

(5) Requirement 2.22

(c) Where both a motion controller and an operation controller are installed without any change in the type of motion control as described in 8.7.2.27.4(a) and without any change in the type of operation control as described in 8.7.2.27.4(b), the installation shall conform to the following:

(10) Requirement 2.22

Delete and revise Subsection (j) of Section 8.7.2.27.5 to read as follows:

8.7.2.27.5 Change in type of motion control. Where there is a change in the type of motion control (the method of controlling acceleration, speed, retardation, and stopping), the installation shall conform to the following:

(j) Car overspeed protection and unintended movement protection shall conform to Section 2.19 to the extent that the existing installation is approved by a design professional.

Delete and revise Subsection (l) of Section 8.7.2.27.6 to read as follows:

8.7.2.27.6 Change in type of operation control.

(l) Ascending car overspeed and unintended car movement protection shall conform to Section 2.19 to the extent the existing installation permits.

Delete Section 8.7.2.27.7 in its entirety.

Delete and revise Section 8.7.2.27.9 to read as follows:

8.7.2.27.9 Door monitoring system. Where there is an alteration to or addition of a system to monitor and prevent automatic operation of the elevator with faulty door contact circuits while the car is in the landing zone, the alteration shall conform to the requirements in Section 2.26.5.

8.7.3 Alterations to hydraulic elevators.

Add new Subsection (f) to 8.7.3.22.1 to read as follows:

8.7.3.22.1 Increase or decrease in rise. Where an alteration involves an increase or decrease in the rise without any change in the location of the driving machine, it shall conform to the following:

(f) Where the decrease is at the upper end of the rise, the installation shall conform to Section 8.7.2.17.1(4).

Delete and revise Section 8.7.3.31.10 to read as follows:

8.7.3.31.10 In-car stop switch. On passenger and freight elevators, a stop switch shall be provided in accordance with Section 2.26.2.5.

SECTION 8.8
WELDING

8.8.1 Qualification of welders.

Delete and revise Section 8.8.1 to read as follows:

8.8.1 Qualification of welders.

Where required elsewhere in the New York City Building Code, welding of parts, except for tack welds later incorporated into finished welds, shall be undertaken

(a) by welders qualified in accordance with the requirements of Section 4 of ANSI/AWS D1.1, whereby the welders shall be qualified by the manufacturer or contractor; a registered design professional; or a recognized testing laboratory; or

(b) as per department rules.

SECTION 8.10
ACCEPTANCE INSPECTIONS AND TESTS

Delete and revise the header of Section 8.10 to read as follows:

Requirement 8.10 covers acceptance inspections and tests of new or altered installations.

NOTE:

(1) Compliance with certain requirements is verifiable through review of design documents, engineering, or type tests.

8.10.1 General requirements for acceptance inspections and tests.

Delete and revise section 8.10.1.1.3 to read as follows:

8.10.1.1.3 RESERVED.

Delete and revise Section 8.10.1.1.4 to read as follows:

8.10.1.1.4 Acceptance test tags. A metal tag with the date (month and year) the acceptance test was satisfactorily performed, and the name of the applicant of record, shall be installed to be readily visible and shall be permanently attached to the controller of each unit.

Delete Section 8.10.1.1.5 in its entirety.

Delete Section 8.10.1.2 in its entirety.

8.10.2 Acceptance inspection and tests of electric elevators

Add new Subsection (y) to Section 8.10.2.2.1 to read as follows:

8.10.2.2.1 Inside car.

(y) Elevator mirrors. (3001.6)

Delete and revise Section 8.10.2.2.9 to read as follows:

8.10.2.2.9 Occupant Evacuation Operation. Verify conformance with Section 2.27.11. Tests shall be performed jointly by the fire alarm installer and the elevator system installer in conjunction with NFPA 72, as modified by Appendix Q of the New York City Building Code and any applicable rules.

SECTION 8.11
PERIODIC INSPECTIONS AND WITNESSING OF TESTS

8.11.1 General requirements for periodic inspections and witnessing of tests.

Delete and revise Section 8.11.1.1 to read as follows:

8.11.1.1 Persons authorized to make periodic inspections and witness tests. Refer to Article 304 of the *Administrative Code*.

Delete and revise Sections 8.11.1.3 and 8.11.1.4 to read as follows:

8.11.1.3 Periodic inspection and test frequency. See Chapter 3 of Title 28 of the *Administrative Code*.

NOTE: Required intervals for periodic inspections and tests can be found in Table N1 as modified by this appendix.

8.11.1.4 Installation placed out of service. An installation placed out of service permanently or temporarily so that it cannot be operated for a definite period shall comply with the following requirements:

8.11.1.4.1 Elevators not in use but available for service. Elevators not in use but available for service are those elevators whose power feed line has been disconnected by opening the

main line switch. All required tests shall be regularly performed and a periodic inspection shall be made, and fees shall be paid pursuant to the New York City Building Code. An elevator inspector shall verify that these tests and inspections are being performed, and that the power was interrupted.

8.11.1.4.1.1 Elevators placed out of service (dismantled). Elevators that are dismantled shall have power feed lines disconnected from the main line disconnect switch and shall meet the requirements of subsections (a) or (b), below:

(a) An electric elevator, dumbwaiter, sidewalk elevator or material lift whose suspension ropes have been removed, whose car and counterweight rest at the bottom of the hoistway, and whose hoistway doors have been permanently barricaded or sealed in the closed position on the hoistway side; or

(b) A hydraulic elevator, dumbwaiter, sidewalk elevator or material lift whose car rests at the bottom of the hoistway; whose pressure piping has been disassembled and removed from the premises; whose hoistway doors have been permanently barricaded or sealed in the closed position.

In addition, an application to dismantle the elevator shall be filed with the department and an inspection fee charged. Thereafter, one (1) additional inspection per year shall be made to verify that the status is unchanged and fees shall be paid for such inspection. Before the installation is put back in service, an application to restore service shall be filed with the department. For access to the bottom of the hoistway, the requirements of Section 8.11.1.4.1.2(b)(4) shall apply.

8.11.1.4.1.2 Elevators removed and permanently discontinued – One elevator shaftway. When a single elevator with one elevator shaftway is removed and permanently discontinued, an application shall be filed with the department and inspection fees charged. Such process shall meet the following requirements:

(a) If it is proposed to extend the floor at every story of the building, the new construction shall be the same or of similar construction as the existing adjacent floor and of equivalent or better fire resistive rating. All hoistway equipment shall be completely removed; rails may remain.

(b) If the hoistway shaft is to remain open:

(1) All hoistway equipment shall be completely removed; rails may remain. Except as provided in item 4, all door and window assemblies opening onto masonry shaftway and masonry enclosed associated machine rooms shall be completely removed and the open space so created shall be filled with the same or similar material of equal thickness and of equivalent or better fire restive rating as the adjacent masonry.

(2) Except as provided in item 3, all door and window assemblies opening onto the hoistway shaft that were originally enclosed with an open wire screen and subsequently enclosed with other than masonry units (i.e. metal lath and plaster or

transit boards) shall remain. Such door and window assemblies shall be fastened in a closed position and shall be adequately welded or bolted shut. The assembly shall be enclosed in material of equal or similar thickness of equivalent or better fire resistive rating as the adjacent enclosure.

(3) The sidewalk elevator door at the street level shall be fastened in a closed position and shall be adequately welded shut. The underside of such door shall be properly reinforced and supported by steel beams and columns to support the same loading as the sidewalk.

(4) Firefighter access to the bottom of the hoistway (elevator pit) shall be provided through the door assembly of the pit door and shall meet the following requirements:

(i) If the machine room is located at or near the level of the bottom of the shaftway and is so located that access to the bottom of the shaftway is readily available through the machine room, the door to the machine room shall be kept closed with a heavy-duty dead bolt locking device.

(ii) If the machine room is located other than at or near the level of the bottom of the shaftway or the bottom of the shaftway is not otherwise readily accessible through the machine room, the lowermost door opening onto the shaftway shall be kept closed with a heavy-duty dead bolt locking device. A conspicuous sign of 25 mm (1 in.) block letters with contrasting background shall be permanently affixed to the door and shall read “HOISTWAY.”

(iii) The key to the locking device required in items (i) and (ii) above shall be kept by the building superintendent and shall be readily available to the commissioner or the commissioner’s representative and to firefighters.

(c) The ventilation opening (smoke hole) in the flooring provided at the top of the hoistway immediately below the sheaves or at the level of the top of the machine room floor beams and the ventilation opening at the exterior portion of the machine room shall be maintained.

(d) All electric service to the elevator hoistway and machine room shall be disconnected outside the confines of the elevator hoistway and machine room.

8.11.1.4.1.3 Elevators removed and permanently discontinued – Multi-elevator shaftway.

When a single elevator in a multi-elevator shaftway is removed and permanently discontinued, an application shall be filed with the department and inspection fees charged. Such process shall meet the following requirements:

(a) If it is proposed to extend the floor at every story of the building, the new construction shall be the same or of similar construction as the existing adjacent floor and of equivalent or better fire resistive rating. All hoistway equipment for the discontinued elevator shall be completely removed; rails may remain. The shaft enclosure shall be rearranged so that the remaining operating elevators are properly enclosed to maintain the integrity of the shaftway.

(b) If the hoistway shaft is to remain open:

(1) All hoistway equipment for the discontinued elevator shall be completely removed; rails may remain. All door assemblies serving the discontinued elevator, openings onto the masonry shaftway shall be completely removed and the open space so created shall be filled with the same or similar material of equal thickness of equivalent or better fire resistive rating as the adjacent masonry.

(2) All door assemblies serving the discontinued elevator, opening onto the hoistway shaft that were originally enclosed with an open wire screen and subsequently enclosed with other than masonry units (i.e. metal lath and plaster or transite boards), shall remain. Such door assemblies shall be fastened in a closed position and shall be adequately welded shut. The assembly shall be enclosed in material of equivalent or better fire resistive rating as the adjacent enclosure.

8.11.1.4.2 Escalator installation placed out of service.

8.11.1.4.2.1 Escalators not in use but available for service. Escalators not in use but available for service are those escalators whose power feed lines have been disconnected from the main line disconnect switch and whose entrances have been barricaded. All required tests shall be regularly performed and a periodic inspection shall be made, and fees shall be paid pursuant to the New York City Building Code. An elevator inspector shall verify that these tests and inspections are being performed, and that the power was interrupted.

8.11.1.4.2.2 Escalators discontinued or placed out of service. Escalators discontinued or placed out of service shall comply with Section 8.11.1.4.2.1. An application shall be filed with the department and an inspection fee charged. Thereafter, one (1) additional inspection per year shall be made to verify that the status is unchanged and fees shall be paid for such inspection. Before the installation is put back in service, it shall be subject to all of the routine and periodic inspections and tests required by the New York City Building Code.

8.11.1.4.2.3 Escalators removed and permanently discontinued. An application shall be filed with the department and inspection fees charged. The escalator steps, newels, rails, all wire cables, and other equipment and machinery shall be completely removed. An opening created by the removal of the escalator shall be filled with new construction of the same or similar construction as the existing adjacent floor and of equivalent or better fire resistive rating.

8.11.1.4.3 Moving walk installation placed out of service.

8.11.1.4.3.1 Moving walks not in use but available for service. Moving walks not in use but available for service are those moving walks whose power feed lines have been disconnected from the main line disconnect switch and whose entrances have been barricaded. All required tests shall be regularly performed and a periodic inspection shall be made and fees charged. An elevator inspector shall verify that these tests and inspections are being performed, and that the power was interrupted.

8.11.1.4.3.2 Moving walk discontinued or placed out of service. Moving walks discontinued or placed out of service shall meet the requirements of Section 8.11.1.4.3.1 except for periodic inspection. An application shall be filed with the department and inspection fees charged. Thereafter, one (1) additional inspection per year shall be made to verify that the status is unchanged and fees shall be paid for such inspection. Before the installation is placed back in service, it shall be subject to all of the routine and periodic inspections and tests required by the New York City Building Code.

8.11.1.4.3.3 Moving walk removed and permanently discontinued. An application shall be filed with the department and inspection fees charged. The moving walk treadways, newels, rails, all wire cables, and other equipment and machinery shall be completely removed. The truss may remain. An opening created by the removal of the moving walk shall be covered by new construction of the same or similar construction as the existing adjacent floor and of equivalent or better fire resistive rating.

Add new Section 8.11.1.6 to read as follows:

8.11.1.6 Test and maintenance data tags. A tag conforming to the requirements of Section 2.16.3.3 for data plates with the test date, the category number of the test, and the name of the agency performing the test shall be installed at the following locations:

(a) Category 1 on the controller for elevators, escalators and moving walks and also on the lower starting station of escalators and moving walks.

(b) Category 5 on the elevator controller, governor(s), release carrier(s) and oil buffer(s).

(c) Brake maintenance tag on the controller for elevators, escalators and moving walks and also on the lower starting station of escalators and moving walks.

8.11.2 Periodic inspection of electric elevators.

Delete and revise the Note to Section 8.11.2.1 to read as follows:

8.11.2.1 Periodic inspection requirements. Inspectors shall include the following when identifying components or systems, or both, that shall be inspected.

NOTES:

(1) For inspection frequency, see Section 8.11.1.3.

(2) Refer to Article 304 of the *Administrative Code*.

8.11.3 Periodic inspection of hydraulic elevators.

Delete and revise the Note to Section 8.11.3.1 to read as follows:

8.11.3.1 Periodic inspection requirements. Inspectors shall include the following when identifying components or systems, or both, that shall be inspected.

NOTES:

(1) For inspection frequency, see Section 8.11.1.3.

*(2) Refer to Article 304 of the *Administrative Code*.*

8.11.4 Periodic inspection of escalators and moving walks.

Delete and revise the Note to Section 8.11.4.1 to read as follows:

8.11.4.1 Periodic inspection and test requirements. Inspectors shall include the following when identifying components or systems, or both, that shall be inspected:

NOTES:

(1) For inspection frequency, see Section 8.11.1.3.

*(2) Refer to Article 304 of the *Administrative Code*.*

Add new Table N1 to read as follows:

**TABLE N1
REQUIRED INSPECTION AND TEST INTERVALS IN "MONTHS" (1)**

		Periodic Inspections on Behalf of Owner By an Approved Agency (2)						Category Tests (3) on Behalf of Owner By an Approved Agency (4)							
				Notifications	Filing	Approved agency (Inspecting)	Approved Agency (Witnessing)	Category 1		Category 5		Notifications	Filing	Approved agency (Performing)	Approved Agency (Witnessing)
Reference Code	Equipment Type (5)	Requirement	Interval					Requirement	Interval	Requirement	Interval				
ASME A17.1	Electric Elevators	8.11.2.1	1-1 to 12-31	No	Yes	Yes	No	8.6.4.19	1-1 to 12-31	8.6.4.20	60	Yes (Cat. 5)	Yes	Yes	Yes
ASME A17.1	Hydraulic Elevators	8.11.3.1	1-1 to 12-31	No	Yes	Yes	No	8.6.5.14	1-1 to 12-31	Roped 8.6.5.16	60	Yes (Cat. 5)	Yes	Yes	Yes
ASME A17.1	Escalators & Moving Walks	8.11.4.1	1-1 to 12-31	No	Yes	Yes	No	8.6.8.15	1-1 to 12-31	N/A	N/A	Yes (Cat. 1)	Yes	Yes	Yes
ASME A17.1	Sidewalk Elevators	8.11.5.1	1-1 to 12-31	No	Yes	Yes	No	8.6.4.19, 8.6.5.14	1-1 to 12-31	8.6.4.20, 8.6.5.16	60	Yes (Cat. 5)	Yes	Yes	Yes
ASME A17.1	Dumbwaiters	8.11.5.4	1-1 to 12-31	No	Yes	Yes	No	8.6.4.19, 8.6.5.14	1-1 to 12-31	8.6.4.20, 8.6.5.16	60	No	Yes	Yes	No
ASME A17.1	Material Lifts	8.11.5.5	1-1 to 12-31	No	Yes	Yes	No	8.6.4.19, 8.6.5.14	1-1 to 12-31	8.6.4.20, 8.6.5.16	60	No	Yes	Yes	No
ASME A17.1	Special Purpose Personnel Elevators	8.11.5.6	1-1 to 12-31	No	Yes	Yes	No	8.6.4.19, 8.6.5.14	1-1 to 12-31	8.6.4.20, 8.6.5.16	60	No	Yes	Yes	No
ASME A17.1	Inclined Elevators	8.11.5.7	1-1 to 12-31	No	Yes	Yes	No	8.6.4.19, 8.6.5.14	1-1 to 12-31	8.6.4.20, 8.6.5.16	60	No	Yes	Yes	No
ASME A17.1	Shipboard Elevators	8.11.5.8	1-1 to 12-31	No	Yes	Yes	No	8.6.4.19, 8.6.5.14	1-1 to 12-31	8.6.4.20, 8.6.5.16	60	No	Yes	Yes	No
ASME A17.1	Screw-Column Elevators	8.11.5.9	1-1 to 12-31	No	Yes	Yes	No	8.6.4.19, 8.6.5.14	1-1 to 12-31	8.6.4.20, 8.6.5.16	60	No	Yes	Yes	No
ASME A17.1	Rooftop Elevators	8.11.5.10	1-1 to 12-31	No	Yes	Yes	No	8.6.4.19, 8.6.5.14	1-1 to 12-31	8.6.4.20, 8.6.5.16	60	No	Yes	Yes	No
ASME A17.1	Rack and Pinion Elevators	8.11.5.11	1-1 to 12-31	No	Yes	Yes	No	8.6.4.19, 8.6.5.14	1-1 to 12-31	8.6.4.20, 8.6.5.16	60	No	Yes	Yes	No
ASME A17.1	Limited Use-Limited Application Elevators (Commercial Bldgs. Only)	8.11.5.12	1-1 to 12-31	No	Yes	Yes	No	8.6.4.19, 8.6.5.14	1-1 to 12-31	8.6.4.20, 8.6.5.16	60	Yes (Cat. 5)	Yes	Yes	Yes

**TABLE N1
REQUIRED INSPECTION AND TEST INTERVALS IN "MONTHS" (1)**

		Periodic Inspections on Behalf of Owner By an Approved Agency (2)						Category Tests (3) on Behalf of Owner By an Approved Agency (4)							
				<u>Notifications</u>	<u>Filing</u>	<u>Approved agency (Inspecting)</u>	<u>Approved Agency (Witnessing)</u>	<u>Category 1</u>		<u>Category 5</u>		<u>Notifications</u>	<u>Filing</u>	<u>Approved agency (Performing)</u>	<u>Approved Agency (Witnessing)</u>
<u>Reference Code</u>	<u>Equipment Type (5)</u>	<u>Requirement</u>	<u>Interval</u>					<u>Requirement</u>	<u>Interval</u>	<u>Requirement</u>	<u>Interval</u>				
<u>ASME A17.1</u>	<u>Elevators Used for Construction</u>	<u>8.11.5.13</u>	<u>1-1 to 12-31</u>	<u>No</u>	<u>Yes</u>	<u>Yes</u>	<u>No</u>	<u>8.6.4.19, 8.6.5.14</u>	<u>1-1 to 12-31</u>	<u>8.6.4.20, 8.6.5.16</u>	<u>60</u>	<u>No</u>	<u>Yes</u>	<u>Yes</u>	<u>Yes</u>
<u>ASME A18.1</u>	<u>Platform/Stairway Chair Lifts</u>	<u>10.2</u>	<u>1-1 to 12-31</u>	<u>No</u>	<u>Yes</u>	<u>Yes</u>	<u>No</u>	<u>10.3.1</u>	<u>1-1 to 12-31</u>	<u>10.3.3</u>	<u>60</u>	<u>No</u>	<u>Yes</u>	<u>Yes</u>	<u>No</u>
<u>ASME B20.1</u>	<u>Vertical and Inclined Reciprocating Conveyors (VRC) and Tow Conveyors</u>	<u>No</u>	<u>No</u>	<u>No</u>	<u>No</u>	<u>No</u>	<u>No</u>	<u>Appendix K2</u>	<u>Appendix K2</u>	<u>Appendix K2</u>	<u>Appendix K2</u>	<u>No</u>	<u>Yes</u>	<u>Yes</u>	<u>No</u>
<u>ASME A90.1</u>	<u>ManLifts</u>	<u>8.2</u>	<u>1-1 to 12-31</u>	<u>No</u>	<u>Yes</u>	<u>Yes</u>	<u>No</u>	<u>8.1</u>	<u>1-1 to 12-31</u>	<u>N/A</u>	<u>N/A</u>	<u>No</u>	<u>Yes</u>	<u>Yes</u>	<u>Yes</u>
<u>ASME A17.1</u>	<u>PR Elevators</u>	<u>8.11.5.2</u>	<u>1-1 to 12-31</u>	<u>No</u>	<u>No</u>	<u>Yes (6)</u>	<u>No</u>	<u>8.6.4.19, 8.6.5.14</u>	<u>1-1 to 12-31</u>	<u>8.6.4.20, 8.6.5.16</u>	<u>60</u>	<u>No</u>	<u>Yes</u>	<u>Yes</u>	<u>Yes</u>
<u>ASME A17.1</u>	<u>PR Dumb-waiters</u>	<u>No</u>	<u>No</u>	<u>No</u>	<u>No</u>	<u>No</u>	<u>No</u>	<u>8.6.4.19, 8.6.5.14</u>	<u>1-1 to 12-31</u>	<u>8.6.4.20, 8.6.5.16</u>	<u>60</u>	<u>No</u>	<u>No</u>	<u>No</u>	<u>No</u>
<u>ASME A18.1</u>	<u>PR Platform/Stairway Chair Lifts</u>	<u>No</u>	<u>No</u>	<u>No</u>	<u>No</u>	<u>No</u>	<u>No</u>	<u>10.3.1</u>	<u>1-1 to 12-31</u>	<u>10.3.3</u>	<u>60</u>	<u>No</u>	<u>No</u>	<u>No</u>	<u>No</u>

Notes:

- (1) See Article 304.6 of the *Administrative Code*.
- (2) Periodic inspections, in accordance with Section 28-304.6.1 of the *Administrative Code*, do not require the presence of a witnessing agency.
- (3) Water-hydraulic elevators shall be tested in accordance with section 8.6.5.15.
- (4) Where filing with the Department is not required, the owner shall perform category testing and maintain a log of each test performed as required by the *New York City Building Code*. Such log shall be made available to the Department upon request.
- (5) Dismantled devices do not require Category 1 or 5 tests but do require periodic inspections.
- (6) For private residence elevators, periodic inspection and category testing may be performed on the same date.

CHAPTER K2
MODIFICATIONS TO ASME B20.1/2015,
SAFETY STANDARD FOR CONVEYORS AND RELATED EQUIPMENT

K201.1 General. As referenced in Section 3001.2 of this code, the provisions of ASME B20.1-2015 shall be modified in accordance with this appendix. The section numbers correlate to those in the referenced ASME standard. Refer to the rules of the department for any subsequent additions, modifications or deletions that may have been made to this standard in accordance with Section 28-103.19 of the *Administrative Code*.

4 DEFINITIONS

Delete and revise the definition “Conveyor, vertical reciprocating” in Section 4 to read as follows:

CONVEYOR, VERTICAL RECIPROCATING. A permanent reciprocating power or gravity-actuated unit (not designed to carry passengers or an operator) that receives objects on a carrier and transmits these objects vertically between two or more levels.

6 SPECIFIC SAFETY STANDARDS
SECTION 6.1

BELT CONVEYORS: FIXED IN PLACE

Delete Section 6.1 in its entirety.

SECTION 6.2
GUARDING OF BUCKET CONVEYORS

Delete Section 6.2 in its entirety.

SECTION 6.3
SAFETY CONSIDERATIONS FOR CHAIN CONVEYORS

Delete Section 6.3 in its entirety.

SECTION 6.4
EN MASSE CONVEYORS

Delete Section 6.4 in its entirety.

SECTION 6.5
FLIGHT AND APRON CONVEYORS: BULK MATERIAL

Delete Section 6.5 in its entirety.

SECTION 6.6
INCLINED RECIPROCATING CONVEYORS

Delete Section 6.6 in its entirety.

SECTION 6.7
LIVE ROLLER CONVEYORS: BELT OR CHAIN DRIVEN

Delete Section 6.7 in its entirety.

SECTION 6.8
MOBILE CONVEYORS

Delete Section 6.8 in its entirety.

SECTION 6.9
**SAFETY CONSIDERATIONS FOR PORTABLE CONVEYORS, EXTENDABLE
BELT CONVEYORS, AND CAR UNLOADERS**

Delete Section 6.9 in its entirety.

SECTION 6.10
SAFETY CONSIDERATIONS FOR PUSHER BAR CONVEYORS

Delete Section 6.10 in its entirety.

SECTION 6.11
6.11 ROLLER AND WHEEL CONVEYORS

Delete Section 6.11 in its entirety.

SECTION 6.12
6.12 SAFETY CONSIDERATIONS FOR SCREW CONVEYORS

Delete Section 6.12 in its entirety.

SECTION 6.13
**SAFETY CONSIDERATIONS FOR SHUTTLE CONVEYERS, BELT TRIPPERS,
AND TRANSFER CARS**

Delete Section 6.13 in its entirety.

SECTION 6.14
SKIP HOISTS: BULK MATERIAL

Delete Section 6.14 in its entirety.

SECTION 6.15
SLAT CONVEYORS AND ROLLER SLAT CONVEYORS

Delete Section 6.15 in its entirety.

SECTION 6.16
SUSPENDED VERTICAL TRAY CONVEYORS

Delete Section 6.16 in its entirety.

SECTION 6.17
TOW CONVEYORS

Delete and revise the title of Section 6.17 to read as follows:

SECTION 6.17
TOW CONVEYORS (SHOPPING CAR CONVEYORS)

6.17.2 Tow Conveyors: Public use intended.

Delete and revise Section 6.17.2.2 and add new Section 6.17.2.3 to Section 6.17.2 read as follows:

6.17.2.2 Guarding. Where a parted chain, cable, belt, tow pin, or other linkage would permit a runaway condition on an incline or decline, anti-runway/backstop devices shall be provided.

6.17.2.3 Periodic inspections and tests. Tow conveyors shall be subject to periodic inspections and tests including acceptance, category 1 and category 5.

SECTION 6.18
TROLLEY CONVEYORS AND POWER AND FREE CONVEYORS

Delete Section 6.18 in its entirety.

SECTION 6.19
VERTICAL ARTICULATED CONVEYORS

Delete Section 6.19 in its entirety.

SECTION 6.20
VERTICAL CHAIN-OPPOSED SHELF TYPE CONVEYORS

Delete Section 6.20 in its entirety.

SECTION 6.21
VERTICAL RECIPROCATING CONVEYORS

6.21.1 Safety considerations.

Add new Subsections (d), (e), (f), (g), (h), (i), (j) and (k) to Section 6.21.1 to read as follows:

(d) Travel distance shall be limited to less than 22 860 mm (75 ft) with a maximum of four landings served.

(e) Where fire-resistant construction is required by the Building Code, conveyor(s) shall be enclosed in a fire-rated hoistway.

(f) Access at landings shall be a restricted area for authorized personnel with no public access.

(g) Where there is accessible space under the hoistway, the conveyor and counterweight shall be equipped with a safety device designed to stop and hold the conveyor and counterweight independent of the hoisting or driving mechanism and shall comply with A17.1 rules 2.6 and 2.1.2.3.

(h) The operating device shall not be located inside the conveyor enclosure and must be external to the hoistway at each landing served.

(i) The system shall incorporate a position indicator at each floor landing to register the location of the conveyor.

(j) The rated-load capacity shall not be less than 239 kg/m² (49 lbs. per sq ft).

(k) The rated speed shall not exceed 406 mm/sec (80 FPM).

6.21.2 Guarding.

6.21.2 Delete and revise Subsections (b), (c) and (d) of Section 6.21.2 to read as follows:

(b) The conveyor housing shall be equipped with doors or an equivalent means at each manual landing and unloading station, arranged so that they can be opened only when the carrier is present and stopped at that level and such that the carrier cannot be actuated until they are closed. This requirement is typically satisfied by use of a mechanical locking device, which is actuated by the motion of the carrier, and an electrical switch indicating that the door is closed and locked.

(1) The unlocking mechanism must be mounted on the carrier.

(2) This requirement shall be satisfied by the use of an interlock as required by ASME A17.1, Section 2.12.2.

(c) Vertical reciprocating conveyors designed to automatically receive and discharge material shall have interlocked doors as in (b) or, as an alternative,

be guarded by a suitable enclosure extending from the path of the moving carrier.

(d) Where the application requires that personnel walk onto the carrier to load or unload material, the carriers shall be provided with a conveyor enclosure securely fastened to the conveyor platform. The enclosure walls shall be of solid, grille or perforated construction; and shall be of such strength and support that when subjected to a leaning or falling rated load on the conveyor, the enclosure walls will not deflect or deform in a way that reduces running clearances to less than 13 mm (0.5 in.). Enclosure entrance(s) shall be provided with solid doors or gates; and shall guard the full width opening with a minimum height of 2030 mm (80 in.). Grille or perforated portions of conveyor enclosures and entrance gates shall reject a ball 38 mm (1.5 in.) in diameter.

Add new Section 6.21.3 to read as follows:

6.21.3 Periodic testing.

(a) All conveyors shall be inspected and tested as per Table N1 of ASME A17.1 as modified by Chapter K1 of this appendix.

(b) All safety devices shall be tested on all tests. A static full load shall be performed every five years to ensure that the conveyor holds the load.

SECTION 6.22
MATERIAL ENCAPSULATING CONVEYORS

Delete Section 6.22 in its entirety.

Delete and revise the title of “Mandatory Appendix I” to read as follows:

NON-MANDATORY APPENDIX I
SPECIFICATIONS FOR DESIGN, INSTALLATION
COMMISSIONING, AND PERIODIC INSPECTION OF VERTICAL
RECIPROCATING CONVEYORS

CHAPTER K3
MODIFICATIONS TO ASME A17.3-2015,
SAFETY CODE FOR EXISTING ELEVATORS AND ESCALATORS

K301.1 Retroactive requirements for existing elevators and escalators. As referenced in Section 3001.2 of this code, the provisions of ASME A17.3-2015 shall be modified in accordance with this appendix and are applicable to all existing elevators and escalators. The section numbers correlate to those in the referenced ASME standard. Refer to the rules of the department for any subsequent additions, modifications or deletions that may have been made to this standard in accordance with Section 28-103.19 of the *Administrative Code*.

PART I
INTRODUCTION

SECTION 1.1
SCOPE

1.1.2 Equipment not covered by this code.

Delete and revise subsection (ee) to read as follows:

Equipment not covered by this code. Equipment not covered by this code includes, but is not limited to, the following:

- (ee) limited-use/limited-application elevators within the scope of ASME A17.1, except for section 3.10.12 of this code, where such limited-use/limited-application elevators shall achieve compliance by January 1, 2027

SECTION 1.5
ALTERATIONS, MAINTENANCE, AND INSPECTIONS AND TESTS

1.5 Delete and revise Section 1.5 to read as follows:

Existing installations shall conform to the following requirements of ASME A17.1–2013:

(a) Requirements 8.10, Acceptance Inspections and Tests; and 8.11, Periodic Inspections and Tests

(b) Requirements 8.6, Maintenance, Repair, and Replacement; and 8.7, Alterations

In addition, existing installations shall conform to Sections 1007.4, 1607.8.1, 3001.2, 3001.4, 3002.5, and 3003.2 of the *New York City Building Code*.

PART II
HOISTWAYS AND RELATED CONSTRUCTION FOR ELECTRIC
ELEVATORS

SECTION 2.1
HOISTWAYS

2.1.1 Hoistway construction.

Delete Section 2.1.1 in its entirety.

2.1.2 Windows in hoistway enclosures.

Delete and revise Section 2.1.2 to read as follows:

2.1.2 Windows in hoistway enclosures. Every hoistway-window opening ten (10) stories or fewer above a thoroughfare, and every such window opening three (3) stories or fewer above the roof of an adjacent building, shall be guarded by one of the following:

- (a) Vertical bars at least 5/8 inch (16 mm) in diameter or equivalent, spaced not more than 10 inches (254 mm) apart, permanently and securely fastened in place; or
- (b) Metal-sash windows having solid-section steel muntins of not less than 1/8 inch (3.2 mm) thickness, spaced not more than 8 inch (203 mm) apart.

Exterior hoistway-windows shall be marked with the word “SHAFTWAY” in red letters at least 6 inches (152 mm) high on a white background.

2.1.4 Pipes, air ducts, and wiring.

Delete Section 2.1.4 in its entirety.

2.1.5 Counterweight guards.

Delete Section 2.1.5 in its entirety.

SECTION 2.2
MACHINE ROOMS AND MACHINERY SPACES

2.2.5 Pipes, air ducts, and wiring.

Delete Section 2.2.5 in its entirety.

SECTION 2.4
CLEARANCES AND RUNBYS

Delete Section 2.4 in its entirety.

SECTION 2.5
PROTECTION OF SPACES BELOW HOISTWAYS

Delete and revise Section 2.5 to read as follows:

Where the space below the hoistway is not permanently secured against access, the following requirements shall be conformed to:

- (a) The cars and counterweights shall be provided with spring or oil buffers.
- (b) Car and counterweight buffer supports shall be of sufficient strength to withstand without permanent deformation the impact resulting from buffer engagement of the car plus the rated load or the counterweight with an empty car at the following speeds:

- (1) Governor tripping speed where the safety is governor operated;
- (2) One hundred and twenty-five (125) percent of the rated speed where the safety is not governor operated.

SECTION 2.6
HOISTWAY ENTRANCES

2.6.3 Hoistway-door vision panels.

Delete and revise Section 2.6.3 to read as follows:

2.6.3 Hoistway-door vision panels. Hoistway-door vision panels must be protected by protective grills made of number sixteen (16) gage stainless or galvanized steel in accordance with the following specifications:

- (a) Grills shall be sized to fit within or over the vision panel frame and completely cover the vision panel opening in the elevator, car doors and hoistway doors.
- (b) Grills and vision panel frames shall be secured by means of non-reversible screws or other tamper proof fasteners.
- (c) Grills shall contain openings that shall reject a ball 0.75 inch (19 mm) in diameter.
- (d) All cut edges shall be deburred.
- (e) The provisions of this section shall apply to both new and existing passenger cars. Requirements for such grills may be waived if certification is submitted that such elevator is operated manually or twenty-four (24) hour doorman service is provided. A security guard shall not be considered doorman service.
- (f) For the purpose of this subparagraph, a vandal resistant 0.25 inch (6 mm) polycarbonate sheet, such as Lexan, in two (2) layers, one (1) on each side of the required wire glass, may be used in lieu of the metal protective.

2.6.4 Door hangers.

Delete Section 2.6.4 in its entirety.

2.6.7 Bottom guides.

Delete and revise Section 2.6.7 to read as follows:

2.6.7 Bottom guides. Existing elevators in occupancy groups R-1, R-2 and E shall comply with the following requirements:

- (a) The bottom of each horizontally sliding hoistway elevator door panel shall be equipped with bottom guiding members and bottom safety retainers.

- (1) The bottom of each horizontally sliding hoistway door panel shall be guided by two or more members as described in ASME A17.1 Section 2.11.11.6.
- (2) Safety Retainers - The bottom of each horizontally sliding hoistway elevator door panel shall be provided with a means of retaining the door panel in position if the primary guiding means fail, and preventing displacement of the bottom of the door panel by not more than 0.75 inch (19 mm) into the hoistway. Such retainers shall be installed on the bottom, shaft-side of each door panel, shall be fabricated of at least twelve (12) gage stainless or galvanized steel, and shall engage the corresponding sill member by not less than 0.375 inch (9.5 mm).

Exception: New elevator doors installed under the 1996/1997 or later editions of ASME A17.1 as modified by Chapter K1 of this Appendix.

(b) The door panels shall be structurally sound and in such condition that the guide(s) and retainer(s) may be securely attached.

- (1) At least one (1) bottom guide shall be installed near each end of every door panel.
- (2) A safety retainer(s) totaling at least 8 inches (203 mm) in length shall be installed between the two (2) outermost guides.
- (3) On smaller sized door panels, where due to the width of the door panel, the space between the two (2) outermost bottom guides would be less than 8 inches (203 mm), then either:
 - (i) The length of the retainer may be reduced to a minimum of 4 inches (102 mm); or
 - (ii) When only one (1) bottom guide is provided near the center of the door, a 4 inches (102 mm) retainer shall be installed on each side of the bottom guide. If the space between the bottom guide and the edge of the door is less than four inches, the length of the retainer may be reduced to the amount of the space between the bottom guide and the edge of the door.

Exception: New elevator entrance frames and doors installed under the 1996/1997 or later editions of ASME A17.1 as modified by Chapter K1 of this appendix.

SECTION 2.7

HOISTWAY-DOOR LOCKING DEVICES, PARKING DEVICES, AND ACCESS

2.7.4 Access to hoistway.

Delete Section 2.7.4 in its entirety.

2.7.5 Restricted opening of hoistway doors and/or car doors on passenger elevators.

Delete and revise the title of Section 2.7.5 to read as follows:

2.7.5 Restricted opening of hoistway doors and/or car doors on automatic passenger elevators. Automatic passenger elevators shall comply by January 1, 2027.

Add new Section 2.7.7 to read as follows:

2.7.7 Locks on elevators and elevator hoistway doors. All elevators shall comply by January 1, 2027.

In all buildings, no switch, lock or device of any kind shall be installed on any floor on or above the street floor on any passenger elevator car or hoistway sliding door. Freight elevators, and passenger elevators with swing-type hoistway doors, are permitted to have locks provided that they are openable by the city-wide standard key 2642 and the New York City Fire Department Standard 1620 key.

SECTION 2.8
POWER OPERATION OF DOORS AND GATES

2.8.1 Kinetic energy and force limitations for power-operated horizontally sliding doors.

Add new Subsection (3) to Section 2.8.1(a):

(3) See Nonmandatory Appendix G of A17.2-204 for door closing time guidelines.

PART III
MACHINERY AND EQUIPMENT FOR ELECTRIC ELEVATORS

SECTION 3.3
CAR FRAMES AND PLATFORMS

3.3.1 Car platforms.

Delete Section 3.3.1 in its entirety.

SECTION 3.4
CAR ENCLOSURES

3.4.1 Car enclosures.

Delete Section 3.4.1 in its entirety.

3.4.2 Car doors and gates.

Delete and revise Section 3.4.2 to read as follows:

3.4.2 Car doors and gates. Passenger and loft elevators shall comply with subsections (a) and (b) of this section.

(a) Doors, gates, and electric contacts. Cars shall have a car door or gate provided at each entrance equipped with a car door or gate electric contact. Car doors and/or gates shall conform to the following requirements:

- (1) Be positively opened by a lever or other device attached to and operated by the door or gate.
- (2) Be maintained in the open position by the action of gravity or by a restrained compression spring, or both, or by positive mechanical means.
- (3) Not be readily accessible.

(b) Car-door interlock. A car-door interlock shall be required for

- (1) Car doors of elevators where the clearance between the loading side of the car platform and hoistway enclosure exceeds the maximum specified in 2.4.1.
- (2) Car doors of elevators that face an unenclosed portion of the hoistway during the travel of the car.

(c) Closed position of car doors or gates. Car doors or gates shall be considered to be in the closed position under the following conditions:

- (1) For horizontally sliding doors or gates, when the clear open space between the leading edge of the door or gate and the nearest face of the jamb does not exceed 2 in. (51mm) except where car doors are provided with a car-door interlock(s), 0.375 in. (10 mm)
- (2) For vertically sliding counterweighted doors or gates, when the clear open space between the leading edge of the door or gate and the car platform sill does not exceed 2 in. (51 mm)
- (3) For horizontally sliding center-opening doors, or vertically sliding biparting counterbalanced doors, when the door panels are within 2 in. (51 mm) of contact with each other, except where horizontally sliding center-opening car doors are provided with a car-door interlock(s), 0.375 in. (10 mm)

(d) Collapsible gates. Collapsible car gates shall conform to the following requirements:

- (1) Collapsible car gates shall not be power opened to a distance exceeding one-third (1/3) of the clear gate opening, and in no case more than 10 inches (254 mm).

- (2) When fully closed (extended position), gates shall reject a ball 3 inches (76 mm) in diameter for passenger elevators and 4.5 inches (114 mm) for freight elevators.
- (3) Gates shall have at least every fourth vertical member guided at the top and every second vertical member guided at the bottom.
- (4) Handles of manually operated collapsible gates nearest the car operating device on elevators operated from the car only shall be so located that the nearest handle is not more than 48 inches (1.22 m) from the car operating device when the gate is closed (extended position), and not more than 48 inches (1.22 m) above the car floor. Gate handles shall be provided with finger guards.

3.4.4 Emergency exits.

Delete Section 3.4.4 in its entirety.

3.4.5 Car illumination.

Delete and revise Section 3.4.5 to read as follows:

3.4.5 Car illumination.

- (a) Interiors of cars shall be provided with an electric light or lights. Not less than two (2) lamps shall be provided.
- (b) The minimum illumination at the car threshold, with the door closed, shall not be less than:
 - (1) For passenger elevators: 5 fc (54 lux).
 - (2) For freight elevators: 2½ fc (27 lux).
- (c) Light control switches are not required, but if provided they shall be located in or adjacent to the operating device in the car. In elevators having automatic operation, they shall be of the key-operated type or located in a fixture with a locked cover.
- (d) Top of car light fixtures shall be provided with a non-key-operated switch in or adjacent to the fixture.

SECTION 3.5 **SAFETIES**

3.5.1 Car safeties.

Delete Section 3.5.1 in its entirety.

3.5.2 Counterweight safeties.

Delete Section 3.5.2 in its entirety.

3.5.3 Safeties to stop ascending cars or counterweights prohibited.

Delete Section 3.5.3 in its entirety.

3.5.4 Application and release of safeties.

Delete Section 3.5.4 in its entirety.

3.5.5 Maximum permissible movement of governor rope to operate the safety mechanism.

Delete Section 3.5.5 in its entirety.

3.5.6 Rail lubricants and lubrication plate.

Delete and revise Section 3.5.6 to read as follows:

3.5.6 Rail lubricants. Rail lubricants or coatings that will reduce the holding power of the safety or prevent its functioning as required shall not be used.

SECTION 3.6 **SPEED GOVERNORS**

Delete Section 3.6 in its entirety.

SECTION 3.8 **DRIVING MACHINES AND SHEAVES**

3.8.1 General requirement.

Delete Section 3.8.1 in its entirety.

3.8.2 Winding drum machines.

Delete and revise Subsection (b) of Section 3.8.2 to read as follows:

(b) Final terminal stopping devices for winding drum machines shall consist of a stopping switch located on the driving machine (machine final) and a stopping switch located in the hoistway and operated by cams attached to the car.

(1) Stopping switches, located on and operated by the driving machine, shall not be driven by chains, ropes, or belts. The opening of these contacts shall occur before or concurrent with the opening of the final terminal stopping switch.

(2) Driving machines equipped with an alternating current motor and alternating current brake or a direct current motor and direct-current brake shall have the final terminal stopping and machine stop device contacts installed in the operating

circuits. The occurrence of a single ground or the failure of any single magnetically operated switch, contactor, or relay shall not render any final terminal stopping device ineffective.

Add new Subsection 3.8.4.1 to read as follows:

3.8.4.1 Single plunger brakes.

(a) All existing traction elevators with single plunger brakes must comply with either of the following by January 1, 2027:

(1) Alteration of single plunger assemblies to dual-plunger type, or

(2) Compliance with Unintended Car Movement Protection as specified by Section 2.19.2 of ASME A17.1.

(b) Notwithstanding any inconsistent provision of chapter 1 of title 28 of the Administrative Code, the work required to comply with this section may not be performed without a permit from the department.

SECTION 3.9
TERMINAL STOPPING DEVICES

3.9.1 Normal terminal stopping devices.

Delete Section 3.9.1 in its entirety.

3.9.2 Final terminal stopping devices.

Delete and revise Section 3.9.2 to read as follows:

3.9.2 Final terminal stopping devices. Upper and lower final terminal electro-mechanical stopping devices shall be provided and arranged to prevent movement of the car by the normal operating devices in either direction of travel after the car has passed a terminal landing. Final terminal stopping devices shall be located as follows:

(a) Winding drum driving machines. Elevators having winding drum machines shall have stopping switches on the machines and also installed in the hoistway and operated by cams attached to the car. Final limit switches and brackets shall be permanently secured and pinned.

(b) Traction driving machines. Elevators having traction driving machines shall have stopping switches installed in the hoistway and operated by cams attached to the car. Final limit switches and brackets shall be permanently secured and pinned.

SECTION 3.10
OPERATING DEVICES AND CONTROL EQUIPMENT

3.10.1 Types of operating devices.

Delete Section 3.10.1 in its entirety.

3.10.3 Top-of-car operating devices.

Delete Section 3.10.3 in its entirety.

3.10.4 Electrical protective devices.

Delete and revise Section 3.10.4 to read as follows:

3.10.4 Electrical protective devices.

Electrical protective devices shall be provided in accordance with the following:

- (a) Slack-rope switch. Winding drum machines shall be provided with a slack-rope device equipped with a slack-rope switch of the enclosed manually reset type that shall cause the electric power to be removed from the elevator driving machine motor and brake if the suspension ropes become slack.
- (b) Compensating rope sheave switch. Compensating rope sheaves shall be provided with a compensating rope sheave switch or switches mechanically opened by the compensating rope sheave before the sheave reaches its upper or lower limit of travel to cause the electric power to be removed from the elevator driving machine motor and brake.
- (c) Broken rope, tape, or chain switches used in connection with machine room normal terminal stopping switches. Broken rope, tape, or chain switches conforming to the requirements of Section 3.6.1 shall be provided in connection with normal terminal stopping devices located in machine rooms of traction elevators. Such switches shall be opened by a failure of the rope, tape or chain.
- (d) Car-safety mechanism switch. A switch shall be required where a car safety is provided.
- (e) Final terminal stopping devices. Final terminal stopping devices shall be provided for every elevator.
- (f) Emergency terminal speed limiting device. Where reduced stroke oil buffers are provided, emergency terminal speed limiting devices are required.
- (g) Motor generator overspeed protection. Means shall be provided to cause the electric power to be removed automatically from the elevator driving machine

motor and brake should a motor generator set, driven by a direct current motor, overspeed excessively.

(h) Motor field sensing means. Where direct current is supplied to an armature and shunt field of an elevator driving machine motor, a motor field current sensing means shall be provided, which shall cause the electric power to be removed from the motor armature and brake unless current is flowing in the shunt field of the motor.

A motor field current sensing means is not required for static control elevators provided with a device to detect an overspeed condition prior to, and independent of, the operation of the governor overspeed switch. This device shall cause power to be removed from the elevator driving machine motor armature and machine brake.

(i) Buffer switches for oil buffers used with type C car safeties. Oil level and compression switches shall be provided for all oil buffers used with Type C safeties.

(j) Hoistway door interlocks or hoistway door electric contacts. Hoistway door interlocks or hoistway door electric contacts shall be provided for all elevators.

(k) Car door or gate electric contacts. Car door or gate electric contacts shall be provided for all elevators with car doors or gates.

(l) Normal terminal stopping devices. Normal terminal stopping devices shall be provided for every elevator.

(m) Car side emergency exit electric contact. An electric contact shall be provided on every car side emergency exit door.

(n) Electric contacts for hinged car platform sills. Hinged car platform sills, where provided, shall be equipped with electric contacts.

(o) Emergency stop switch. On all elevators, an emergency stop switch shall be provided in the car, and located in or adjacent to each car operating panel. When open (i.e. the “stop position”), this switch shall cause the electric power to be removed from the elevator driving-machine motor and brake. Emergency stop switches shall:

(1) Be of the manual open and close type;

(2) Have a red operating handle or buttons;

(3) Be conspicuously and permanently marked “STOP” and indicate the “STOP” and “RUN” positions; and

(4) When open, cause an audible signaling device to sound.

(p) Stop switch in pit. A stop switch, conforming to the following requirements shall be provided in the pit of every elevator. The switch shall be located adjacent to the normal pit access. The switch shall cause the electric power to be removed from the elevator driving machine motor and brake and shall:

- (1) Be of the manual open and close type;
- (2) Have a red operating handle or buttons;
- (3) Be conspicuously and permanently marked “STOP” and indicate the “STOP” and “RUN” positions; and
- (4) Be positively opened mechanically and its opening shall not be solely dependent on a spring.

(q) Buffer switches for gas spring return oil buffers. A buffer switch shall be provided for gas spring return oil buffers that will cause electric power to be removed from the elevator driving machine motor and brake if the plunger is not within 0.5 inch (13 mm) of the fully extended position.

3.10.5 Power supply line disconnecting means.

Delete Section 3.10.5 in its entirety.

3.10.11 Reserved for Future Use.

Delete and revise Section 3.10.11 to read as follows:

3.10.11 Signal System on Car Switch Elevators.

3.10.11 Signal systems on car switch elevators. Elevators with car switch operations shall be provided with a signal system by means of which signals can be given from any landing whenever the elevator is desired at the landing.

3.10.12 System to Monitor and Prevent Automatic Operation of the Elevator With Faulty Door Contact Circuits.

Delete and revise Section 3.10.12 to read as follows:

3.10.12 System to monitor and prevent automatic operation of passenger and freight elevators with faulty door contact circuits.

All automatic passenger and freight elevators shall comply with this section by January 1, 2020. Means shall be provided to monitor the position of power-operated car doors that are mechanically coupled with the landing doors or power-operated car doors with manually operated swing-type hall doors, while the car is in the landing zone, in order

(a) to prevent the operation of the car if the car door is not closed (see Section 3.4.2(c) of ASME A17.3), regardless whether the portion of the circuits incorporating the car-door contact or the interlock contact of the landing door coupled with car door, or both, are closed or open, except as permitted under any of the following conditions:

(1) by a car-leveling or truck-leveling device;

(2) when a hoistway access switch is operated;

(3) when the top-of-car inspection operation utilizing a car door by-pass or hoistway-door bypass switch is activated;

(4) when on any mode of inspection operation; and

(b) to prevent, except as permitted by inspection operation, the power closing of the doors if the car door is fully open and any of the following conditions exist:

(1) the car-door contact is closed or the portion of the circuit, incorporating this contact is bypassed;

(2) the interlock contact of the landing door that is coupled to the opened car door is closed or the portion of the circuit, incorporating this contact is bypassed, except when operating during Firefighters' Service Phase II;

Exception: For swing-type door operation, the locking (secondary) contacts shall be monitored.

(3) the car-door contact and the interlock contact of the door that is coupled to the opened car door are closed, or the portions of the circuits incorporating these contacts are bypassed.

SECTION 3.11 **EMERGENCY OPERATION AND SIGNALING DEVICES**

3.11.1 Car emergency signaling devices.

Delete and revise Section 3.11.1 to read as follows:

3.11.1 Car emergency signaling devices. In all buildings, the elevator(s) shall be provided with the following:

(a) If installed, altered, or both under ASME A17.1–2003 or earlier edition, as modified by Chapter K, Appendix K1

(1) An audible signaling device, operable from the emergency stop switch, when provided, and from a switch marked "ALARM" that is located in or adjacent to each car operating panel. The signaling device shall be located inside the

building and audible inside the car and outside the hoistway. One signaling device shall be permitted to be used for a group of elevators.

(2) If the audible signaling device, or the means of two-way communication, or both, are normally connected to the building power supply, they shall automatically transfer to a source of emergency power within 10 seconds after the normal power supply fails. The power source shall be capable of providing for the operation of the audible signaling device for at least 1 hour, and the means of two-way communication for at least 4 hours.

(3) In buildings in which a building attendant (building employee, watchman, etc.) is not continuously available to take action when the required emergency signal is operated, the elevators shall be provided with a means within the car for communicating with or signaling to a service that is capable of taking appropriate action when a building attendant is not available.

(4) An emergency power system shall be provided conforming to the requirements of (a)(3) of this section.

(b) If installed, altered, or both under ASME A17.1–2013 or later editions as modified by Chapter K, Appendix K1, the emergency communications system shall comply with Section 2.27 of the ASME A17.1 Code under which it was installed or altered.

3.11.3 Firefighters' service.

Delete and revise Section 3.11.3 to read as follows:

3.11.3 Firefighters' service operation in existing elevators. Firefighters' service operation shall be installed in accordance with the *New York City Building Code* in all existing elevators serving any of the following:

(a) High rise buildings or buildings classified in Occupancy Group M except existing R-2.

(b) All buildings or buildings classified in Occupancy Group A, B, E, I, or R-1 (except for "residential hotels," as such term is defined by the commissioner pursuant to rules and regulations).

SECTION 3.12 **SUSPENSION MEANS AND THEIR CONNECTIONS**

3.12.1 Suspension means.

Delete Section 3.12.1 in its entirety.

PART IV
HYDRAULIC ELEVATORS

SECTION 4.2
MECHANICAL EQUIPMENT

Delete Section 4.2 in its entirety.

SECTION 4.3
DRIVING MACHINES

4.3.2 Plunger stops.

Delete and revise Section 4.3.2 to read as follows:

4.3.2 Plunger stops. Plungers shall be provided with solid metal stops and/or other means to prevent the plunger from traveling beyond the limits of the cylinder. Stops shall be so designed and constructed as to stop the plunger from maximum speed in the up direction under full pressure without damage to the connection to the driving machine, plunger, plunger connection, couplings, plunger joints, cylinder, cylinder connecting couplings or any other parts of the hydraulic system.

4.3.3 Hydraulic elevators.

Delete and revise Section 4.3.3 to read as follows:

4.3.3 Hydraulic elevators. Hydraulic elevators that have any portion of the cylinder buried in the ground and that do not have a double cylinder or a cylinder with a safety bulkhead shall:

- (a) Have the cylinder replaced with a double cylinder or a cylinder with a safety bulkhead protected from corrosion by one or more of the following methods:
 - (1) Monitored cathodic protection;
 - (2) A coating to protect the cylinder from corrosion that will withstand the installation process;
 - (3) By a protective plastic casing immune to galvanic or electrolytic action, salt water, and other known underground conditions; or
- (b) Be provided with a device meeting the requirements of Section 3.5 or a device arranged to operate in the down direction at an overspeed not exceeding one hundred twenty-five (125) percent of rated speed. The device shall mechanically act to limit the maximum car speed to the buffer striking speed, or stop the elevator car with rated load with a deceleration not to exceed 32.2 ft/s² (9.8 m/s²), and shall not automatically reset. Actuation of the device shall cause power to be removed from the pump motor and control valves until manually reset; or

(c) Have other means acceptable to the department to protect against unintended movement of the car as a result of uncontrolled fluid loss.

SECTION 4.5
TANKS

4.5.2 Pressure tanks.

Delete Section 4.5.2 in its entirety.

SECTION 4.7
OPERATING DEVICES AND CONTROL EQUIPMENT

4.7.2 Top-of-car operating devices.

Delete Section 4.7.2 in its entirety.

4.7.3 Anticreep leveling devices.

Delete Section 4.7.3 in its entirety.

4.7.4 Electrical protective devices.

Delete and revise Section 4.7.4 to read as follows:

4.7.4 Electrical protective devices. Electrical protective devices conforming to the requirements of Section 3.10.4, where they apply to hydraulic elevators, shall be provided and operate as follows:

(a) The following devices shall prevent operation of the elevator by the normal operating device and also the movement of the car in response to the anticreep leveling device:

(1) stop switches in the pit

(2) stop switches on top of the car

(3) car side emergency exit door electric contacts, where such doors are provided

(b) The following devices shall prevent the operation of the elevator by the normal operating device, but the anticreep leveling device where provided, shall remain operative:

(1) emergency stop switches in the car

(2) broken rope, tape, or chain switches on normal terminal stopping devices when such devices are located in the machine room or overhead space

(3) hoistway-door interlocks or hoistway-door electric contacts

- (4) car door or gate electric contacts
- (5) hinged car platform sill electric contacts
- (6) in-car stop switch, where permitted by subsection 3.10.4(t)

4.7.5 Power supply line disconnecting means.

Delete Section 4.7.5 in its entirety.

4.7.7 Control and operating circuit requirements.

Delete and revise Section 4.7.7 to read as follows:

4.7.7 Control and operating circuit requirements. Control and operating circuits shall conform to the requirements of Sections 3.10.9 and 3.10.12.

SECTION 4.8
ADDITIONAL REQUIREMENTS FOR COUNTERWEIGHTED
HYDRAULIC ELEVATORS

Delete Section 4.8 in its entirety.

SECTION 4.9
ADDITIONAL REQUIREMENTS FOR ROPED HYDRAULIC ELEVATORS

Delete Section 4.9 in its entirety.

PART V
ESCALATORS

SECTION 5.1
CONSTRUCTION

5.1.4 Antislid device.

Delete and revise Section 5.1.4 to read as follows:

5.1.4 Antislid device.

On high deck balustrades, antislid devices shall be provided on decks or combination of decks when the outer edge of the deck is greater than 12 inches (305 mm) from the centerline of the handrail or on adjacent escalators when the distance between centerline of the handrails is greater than 16 inches (406 mm).

These devices shall consist of raised objects fastened to the decks, not closer than 4 inches (102 mm) to the handrail and spaced not greater than 78 inches (2000 mm) apart. The height shall be not less than .75 inches (19 mm). There shall be no sharp corners or edges.

5.1.7 Step risers.

Delete Section 5.1.7 in its entirety.

5.1.8 Slotting of step treads.

Delete Section 5.1.8 in its entirety.

5.1.11 Step/skirt performance index.

Delete Section 5.1.11 in its entirety.

SECTION 5.3
OPERATING AND SAFETY DEVICES

5.3.1 Starting switches.

Delete and revise Section 5.3.1 to read as follows:

5.3.1 Starting devices. In every new and existing escalator, starting devices shall be provided with the combination of a starting switch and a starting button. The escalator shall be started only after the activation of both the switch and the button.

(a) Starting switch. Starting switches shall be of continuous pressure spring return type and shall be operated by a cylinder-type lock having five-pin, five-disc or five-tumbler combination. Starting switches shall be of three-position type and shall be clearly marked as follows:

NORMAL. A central position for the key entry and spring return position.

START-UP. A right side position for starting the escalator in the upward direction.

START-DOWN. A left side position for starting the escalator in the downward direction.

(b) Starting Button. Starting buttons shall be of the constant pressure type and located within 6 inches (152 mm) from the starting switch. They shall be clearly marked "**Starting Button**".

(c) Cover Plate. A locked, transparent cover plate that can be opened by the starting key and clearly marked "**For Start Only**" shall protect the starting devices.

(d) Location of starting devices. Starting devices shall be located at the top and bottom of the escalator on the right side-facing newel.

NOTE: The starting key shall be kept on the premises at all times and shall only be accessible to persons authorized to start escalators. It shall also be made available to the commissioner or the commissioner's representatives.

5.3.2 Emergency stop buttons.

Delete and revise Section 5.3.2 to read as follows:

5.3.2 Emergency stop buttons location. A red stop button shall be visibly located at the top and bottom landings on the right side-facing the escalator. Remote stop buttons are prohibited, except that any escalator connected to an automatic fire alarm system shall gradually stop the escalator at a rate not greater than 3 ft per sec² (0.91 m/s²) upon the activation of such system.

5.3.7 Skirt obstruction device.

Delete and revise the title of Section 5.3.7 to read as follows:

5.3.7 Skirt obstruction and deflector devices.

Add new Section 5.3.7.1 to read as follows:

5.3.7.1 Means shall be provided to cause the electric power to be removed from the escalator driving machine motor and brake if an object becomes caught between the step and the skirt as the step approaches the upper combplate, intermediate device or lower combplate. On units having a run of 20 feet (6.1 m) or more, intermediate devices shall be provided on both sides of the escalator with devices located at intervals of 10 feet (3.05 m) or less. The activation of intermediate devices shall stop the escalator at a rate not greater than 3 ft per sec² (0.91 m/s²) in the direction of travel. The upper and lower skirt obstruction device shall be located so that the escalator will stop before that object reaches the combplate. The activation of any skirt device shall stop the escalator with any load up to full brake rated load with the escalator running.

Add new Section 5.3.7.2 to read as follows:

5.3.7.2 Skirt deflector devices, in accordance with 6.1.3.3.10 of A17.1, 2013, shall be provided no later than January 1, 2025.

Add new Section 5.3.13 to read as follows:

5.3.13 Comb-step stop device. A device shall be provided that will cause the opening of the power circuit to the escalator driving machine motor and brake where a resultant vertical force not greater than 60 lbf (268 N) in the upward direction is applied at the center of the front of the comb-plate.

PART VI **DUMBWAITERS**

Delete Part VI in its entirety.

PART VII
HAND ELEVATORS

Add new Section 7.0 to read as follows:

SECTION 7.0
EXISTING HAND POWERED FREIGHT ELEVATORS

Existing hand powered freight elevators shall not be subject to the provisions of this section. However, adequate protection of landing openings shall be provided by hinged or sliding doors which shall remain locked at all times except when the freight elevator is in use. Auxiliary gates not less than 36 inches (914 mm) in height, substantially constructed and secured in place, of wood or metal, or equivalent metal chains shall be installed. Such gates or chains may be arranged to lift vertically, to slide horizontally, or to swing. No part of any gate or chain shall project into the freight elevator shaft. Gates may be operated automatically or manually.

SECTION 7.1
HOISTWAY, HOISTWAY ENCLOSURES, AND RELATED CONSTRUCTION

Delete Section 7.1 in its entirety.

SECTION 7.2
MACHINERY AND EQUIPMENT

Delete Section 7.2 in its entirety.

PART VIII
SIDEWALK ELEVATORS

SECTION 8.1
HOISTWAY, HOISTWAY ENCLOSURES, AND MACHINE ROOMS

Delete Section 8.1 in its entirety.

SECTION 8.2
MACHINERY AND EQUIPMENT

8.2.2 Buffers and bumpers.

Delete Section 8.2.2 in its entirety.

8.2.3 Counterweights.

Delete Section 8.2.3 in its entirety.

8.2.4 Car frames and platforms.

Delete Section 8.2.4 in its entirety.

8.2.5 Bow-irons and stanchions.

Delete Section 8.2.5 in its entirety.

8.2.6 Car enclosures and car doors and gates.

Delete Section 8.2.6 in its entirety.

8.2.7 Car and counterweight safeties and governors.

Delete Section 8.2.7 in its entirety.

8.2.8 Capacity and loading.

Delete Section 8.2.8 in its entirety.

8.2.9 Driving machines and sheaves.

Delete Section 8.2.9 in its entirety.

8.2.10 Terminal stopping devices.

Delete Section 8.2.10 in its entirety.

8.2.11 Locking devices for hinged swinging doors or vertically lifting covers in sidewalks or other areas exterior to the building.

Delete Section 8.2.11 in its entirety.

8.2.12 Requirements for electrical wiring and electrical equipment.

Delete Section 8.2.12 in its entirety.

8.2.13 Clearance between loading side of car platforms and hoistway enclosures.

Delete Section 8.2.13 in its entirety.

8.2.14 Operating devices and control equipment of sidewalk elevator.

Delete and revise Section 8.2.14 to read as follows:

8.2.14 Operating devices and control equipment of sidewalk elevator. The operation of power sidewalk elevators through openings in the sidewalk, or through openings in other exterior areas that are accessible to the public, and that are protected by hinged doors or vertically lifting covers, shall conform to the following:

- (a) The elevator shall be operated in both the up and down directions through the opening, only from the sidewalk or other exterior area. The operation shall be by means of:
- (1) Key-operated continuous-pressure type up and down switches;
or
- (2) Continuous-pressure-type up-and-down operating buttons on the free end of a detachable, flexible cord 5 feet (1.52 m) or less in length.
- (b) Key-operated switches shall be of continuous pressure spring return type, and shall be operated by a cylinder-type lock having not less than a five-pin or five-disk combination with the key removable only when the switch is in the "OFF" position.
- (c) Key-operated switches and plug receptacles for flexible cords shall be mounted in weatherproof boxes with covers installed above the sidewalk or other area on the side of the building wall, located 18 inches (457 mm) or less horizontally from one side of the opening.
- (d) Operating buttons may be provided in the elevator car and at any landing below the top landing, provided that such buttons shall operate the car only when the bow-iron or stanchions are not in contact with the doors or covers in the sidewalk or other exterior area.
- (e) When the bow-iron or stanchions are in contact with the doors or covers at the sidewalk or other exterior area, it shall be possible to operate the car only by means of either the key switches or the continuous-pressure type up-and-down buttons on the free end of the flexible cord specified in Section 8.2.14(a)(1).
- (f) Flexible cords and operating keys shall not be left where they are accessible to unauthorized persons for operation of the elevator.

PART IX
MOVING WALKS

SECTION 9.2
PROTECTION OF SUPPORTS AND MACHINE SPACES AGAINST FIRE

Delete and revise the title of Section 9.2.2 to read as follows:

9.2.1 Protection required.

SECTION 9.3
CONSTRUCTION REQUIREMENTS

Delete and revise subsection (a) of Section 9.3.3.4 to read as follows:

9.3.3.4 Skirt panels. Where skirt panels are provided

(a) the clearance between each side of the treadway and the adjacent skirt panel shall be not more than 0.188 inches (4.8 mm).

SECTION 9.6
OPERATING AND SAFETY DEVICES

9.6.2 Starting switch.

Delete and revise Section 9.6.2 to read as follows:

9.6.2 Starting devices. In every new and existing moving walk, starting devices shall be provided with the combination of a starting switch and a starting button. The moving walk shall be started only after the activation of both the switch and the button.

(a) **Starting Switch.** Starting switches shall be of continuous pressure spring return type and shall be operated by a cylinder-type lock having five-pin, five-disc or five-tumbler combination. Starting switches shall be of three-position type and shall be clearly marked as follows:

NORMAL. A central position for the key entry and spring return position.

START-UP. A right-side position for starting the moving walks in the upward direction.

START-DOWN. A left-side position for starting the moving walks in the downward direction.

(b) **Starting Button.** Starting buttons shall be of the constant pressure type and located within 6 inches (152 mm) from the starting switch. They shall be clearly marked "Starting Button".

(c) **Cover Plate.** A locked, transparent cover plate that can be opened by the starting key and clearly marked "For Start Only" shall protect the starting devices.

(d) **Location of starting devices.** Starting devices shall be located at top and bottom of the moving walk on the right-side facing newel.

NOTE: The starting key shall be kept on the premises at all times and shall only be accessible to persons authorized to start moving walks. It shall also be made available to the commissioner or the commissioner's representatives.

9.6.3 Emergency stop buttons.

Delete and revise Section 9.6.3 to read as follows:

9.6.3 Emergency stop buttons location. A red stop button shall be visibly located at the top and bottom landings on the right side facing the moving walk. Remote stop buttons are prohibited, except that any moving walk connected to an automatic fire alarm system shall gradually stop the moving walk at a rate not greater than 3 ft/sec² (0.91 m/s²) upon the activation of such system.

Add new Section 9.6.14 to read as follows:

9.6.14 Comb-plate stop device. A device shall be provided that will cause the opening of the power circuit to the moving walk driving-machine motor and brake when a resultant vertical force not greater than 60 lbf (268 N) in the upward direction is applied at the center of the front of the comb-plate.

PART X **PRIVATE RESIDENCE ELEVATORS**

Delete and revise Part X Scope to read as follows:

SCOPE

This Part applies to power elevators that are limited in size, capacity, rise, and speed and are installed in or at a private residence. This Part also applies to similar elevators installed in buildings as a means of access to private residences within such buildings provided the elevators are so installed that they are not accessible to the general public or to other occupants in the building.

NOTE: This Part has been developed to provide a minimum standard of safety for private residence elevators. These elevators are installed for the convenience of those persons who are unable to use stairways. Private residence elevators, while they are usually installed in single-family dwellings, may be installed within a separate apartment in a multiple dwelling where they are not accessible to the general public or to other occupants of the building. It is frequently necessary to install such elevators in open stairwells, as the construction of the building may not provide space for an enclosed hoistway.

Since the size, speed, load, rise, and use are limited, it is possible to provide an adequate level of safety without requiring the equipment to meet the standards in other parts of the Code. Equipment installed for use by the general public is subjected to much more severe and frequent service.

Although private residences are usually exempt from routine inspections, this Code will provide a basis for evaluation of existing equipment during resale or exchange of property. It will also be useful when an “installation placed out of service” is returned to use.

It should be noted that the rules of this Part of the Code do not apply to all power elevators installed in private residences, but only to those that meet the definition for “private residence elevator.” All other elevators in private residences are required to comply with all the rules of the other parts of this Code.

All residential elevators shall comply with the following by January 1, 2021.

SECTION 10.1 **HOISTWAY, HOISTWAY ENCLOSURES, AND RELATED CONSTRUCTION**

Section 10.1.1 Hoistway enclosure construction.

Delete Section 10.1.1 in its entirety.

Section 10.1.2 Pits.

Delete Section 10.1.2 in its entirety.

Section 10.1.3 Top car clearance.

Delete Section 10.1.3 in its entirety.

Section 10.1.4.4 Locking devices for hoistway doors and gates.

Delete Section 10.1.4.4 in its entirety.

Section 10.1.4.5 Opening of hoistway doors or gates.

Delete Section 10.1.4.5 in its entirety.

Section 10.1.4.6 Hangers and stops for hoistway sliding doors.

Delete Section 10.1.4.6 in its entirety.

Section 10.1.4.7 Access to the hoistway for emergency purposes.

Delete Section 10.1.4.7 in its entirety.

Section 10.1.5 Pipes in hoistways.

Delete Section 10.1.5 in its entirety.

Section 10.1.6 Horizontal car clearances.

Delete Section 10.1.6 in its entirety.

Section 10.1.7 Guarding of suspension means.

Delete Section 10.1.7 in its entirety.

SECTION 10.2
CARS

Delete Section 10.2 in its entirety.

SECTION 10.3
COUNTERWEIGHTS

Delete Section 10.3 in its entirety.

SECTION 10.4
SAFTETIES AND GOVERNORS

Delete Section 10.4 in its entirety.

SECTION 10.5
CAR AND COUNTERWEIGHT GUIDE RAILS AND FASTENINGS

Delete Section 10.5 in its entirety.

SECTION 10.6
CAR AND COUNTERWEIGHT BUFFERS

Delete Section 10.6 in its entirety.

SECTION 10.7
DRIVING MACHINES, SHEAVES, AND THEIR SUPPORTS

Delete Section 10.7 in its entirety.

SECTION 10.8
TERMINAL STOPPING DEVICES

Delete Section 10.8 in its entirety.

SECTION 10.9
OPERATING DEVICES AND CONTROL EQUIPMENT

10.9.1 Type of Operation.

Delete Section 10.9.1 in its entirety.

10.9.2 Control and Operating Circuit Requirements.

Delete Section 10.9.2 in its entirety.

10.9.3 Key Operated Switches.

Delete Section 10.9.3 in its entirety.

10.9.5 Phase Reversal and Failure Protection.

Delete Section 10.9.5 in its entirety.

10.9.7 Slack Rope and Slack Chain Devices for Winding Drum and Roller Chain Type Driving Machines.

Delete Section 10.9.7 in its entirety.

SECTION 10.10
EMERGENCY SIGNAL DEVICES

Delete and revise Section 10.10 to read as follows:

10.10.1 Emergency signal. A telephone connected to a central telephone exchange shall be permanently installed in the car and an emergency signaling device operable from inside the car and audible outside the hoistway shall be provided. The telephone must have the capability of calling outside to contact emergency personnel.

SECTION 10.11
LIMITATION OF LOAD, SPEED, AND RISE

Delete Section 10.11 in its entirety.

SECTION 10.12
MARKING PLATES

Delete Section 10.12 in its entirety.

SECTION 10.13
SUSPENSION MEANS

Delete Section 10.13 in its entirety.

§61. Appendix M of the New York city building code is REPEALED and a new appendix M is added to read as follows:

APPENDIX M
SUPPLEMENTARY REQUIREMENTS FOR
ONE- AND TWO-FAMILY DWELLINGS

SECTION BC M101
GENERAL

M101.1 General. The provisions of this appendix contain supplementary requirements for the design and construction of one- and two-family dwellings not more than three stories in height.

SECTION BC M102
DEFINITIONS

M102.1 Definitions. The following terms are defined in Chapter 2:

DWELLING, ONE-FAMILY.

DWELLING, TWO-FAMILY.

SECTION BC M103
FIRE WALL SEPARATION

M103.1 General. A fire wall shall be provided between buildings in accordance with Chapter 7. However, attached one- and two-family dwellings of construction Type IIIA, IIIB, VA and VB, where permitted and where each building is not more than three stories in height and not more than 2,100 square feet (195 m²) on a story, may be separated by party walls constructed in accordance with the following and as illustrated in Figures M103(1) and M103(2):

1. If there are three or fewer contiguous attached one- or two-family dwellings, such fire wall shall consist of a solid 1-inch (25 mm) Type X gypsum wall board core covered on each side by a ½-inch (12.7 mm) exterior-grade Type X gypsum wall board, followed by a 1-inch (25 mm) air gap on one side. Such assembly shall be constructed between two independently supported load-bearing stud walls. See Figure M103(1).
2. If there are in excess of three contiguous attached one or two-family dwellings, the fire wall shall be made of concrete and masonry, and constructed in accordance with Section 706.
3. Such wall shall be continuous between foundations and roofs.
4. When roof construction on the same level is combustible on both sides of the party wall, the party wall shall extend through the roof construction to a height of at least 4 inches (102 mm) above the high point of the roof framing unless a minimum of 18 inches (457 mm) of non-combustible roof construction is provided on each side of the party wall.

5. Such party wall shall be made smoke-tight at junctions with exterior walls. In buildings of construction Type VA or VB, exterior walls shall be constructed of noncombustible materials for a distance of at least 18 inches (457 mm) on each side of the party wall, or the party wall shall project at least 12 inches (305 mm) through the exterior wall.

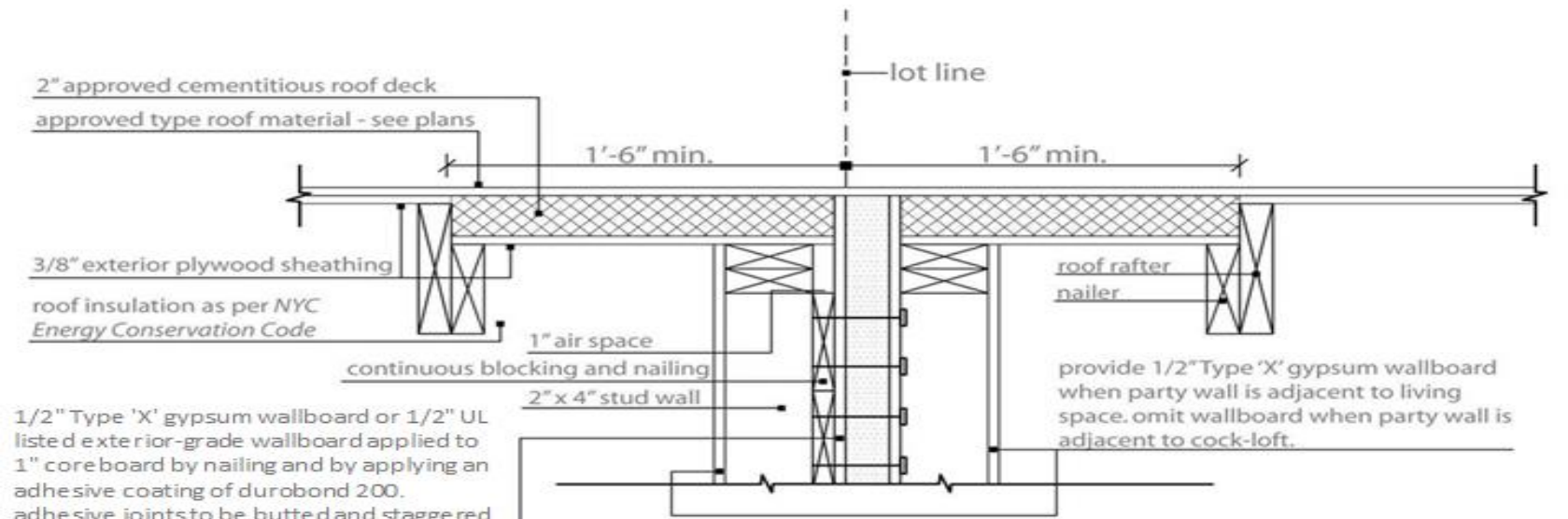

1/2" Type 'X' gypsum wallboard or 1/2" UL listed exterior-grade wallboard applied to 1" core board by nailing and by applying an adhesive coating of durobond 200. adhesive joints to be butted and staggered with joints of the core board, all sheetrock joints to be taped and spackled.

section through two hour rated party wall with sloped or roofs at same level (no projection)

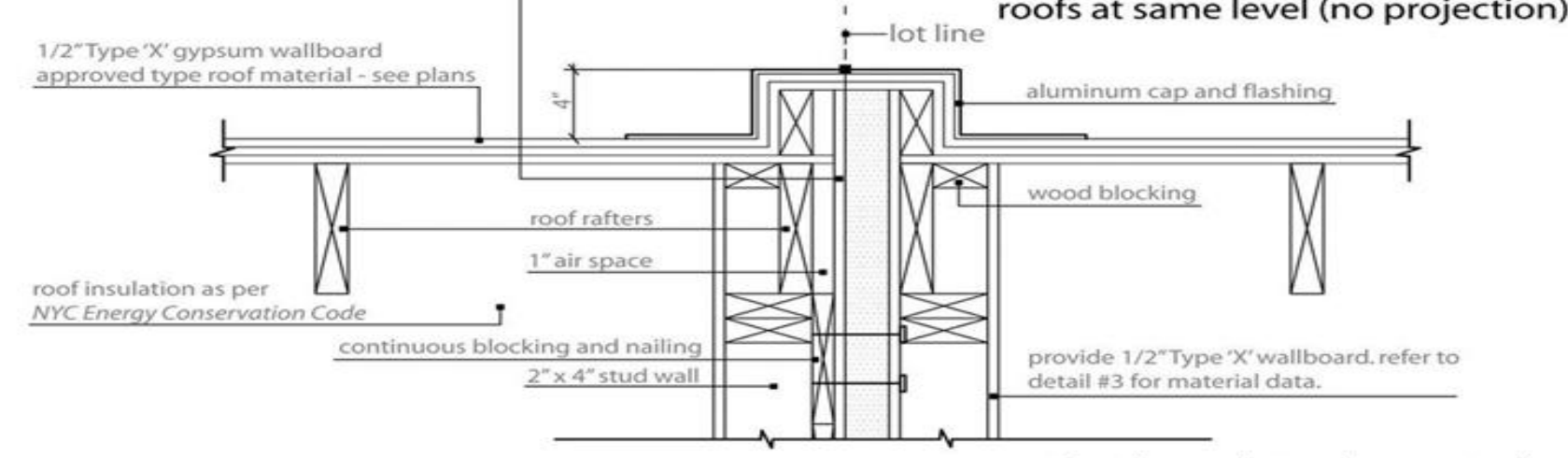

1/2" Type 'X' gypsum wallboard approved type roof material - see plans

section through two hour rated party wall with sloped or roofs at same level 4" projection at roof

**FIGURE M103(1)
PARTY WALL VERTICAL SECTION**

when 4" brick or stone veneer is used, provide 1" air space between sheathing and 4" veneer. refer to general construction notes. all other conditions remain the same.

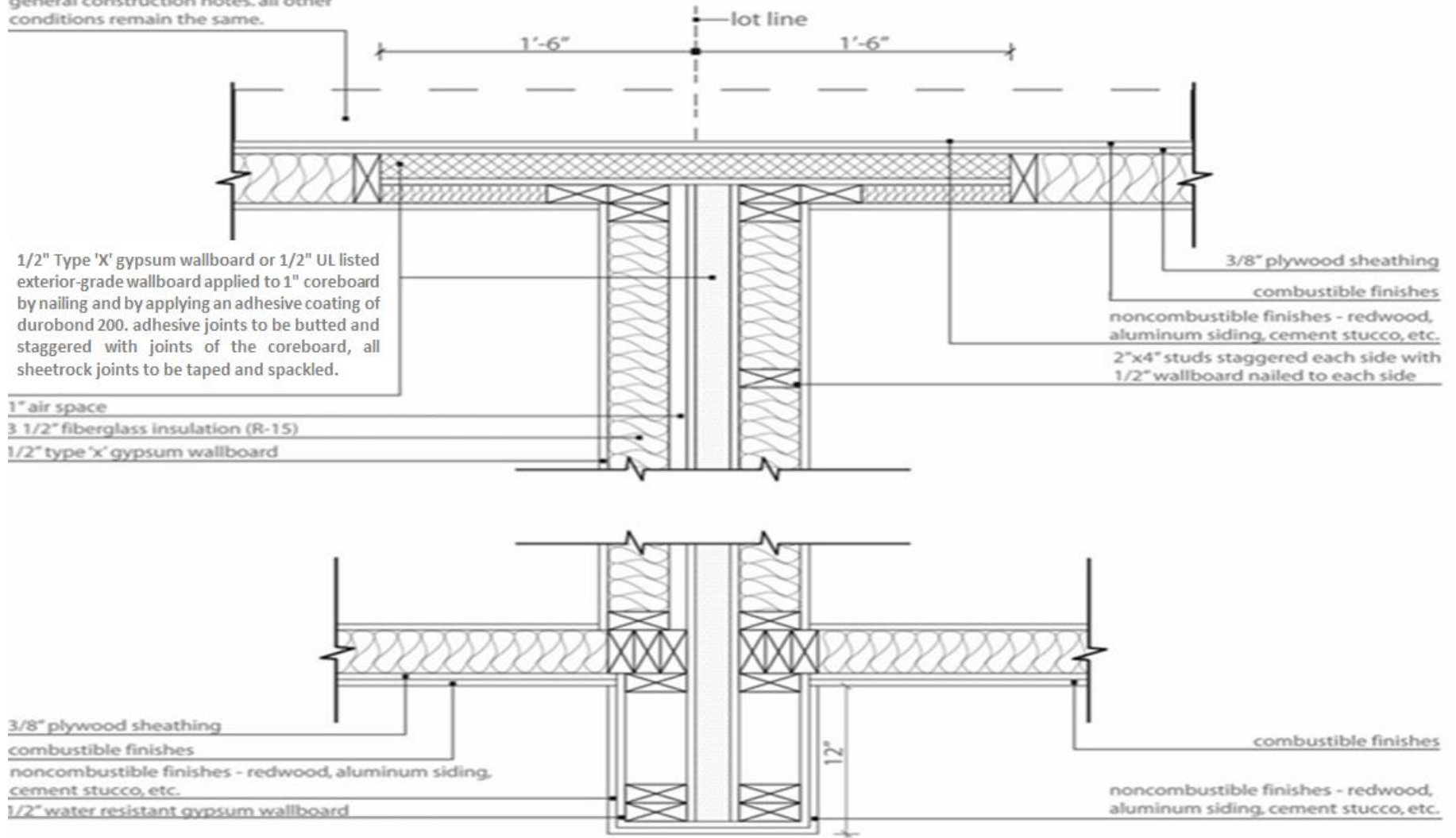

FIGURE M103(2)
PARTY WALL PLAN SECTION

plan of two hour party wall with and without projection through exterior facade.

§ 62. Section BC N102 of appendix N of the New York city building code is REPEALED and a new section N102 is added to read as follows:

SECTION BC N102
INDUCTION LOOP SYSTEM

N102.1 Induction loop system specifications.

1. Where induction-loop systems are provided for hearing aid purposes, the system performance shall be in accordance with IEC 60118-4:2014.
2. The methods of measuring and specifying the performance of system components shall be in accordance with IEC 62489-1:2010, as specified in IEC 60118-4:2014.
3. All electrical wiring installations shall be in accordance with the *New York City Electrical Code*.

N102.2 Capital projects. City funded projects shall provide induction-loop systems pursuant to Section 224.3 of the New York City Charter.

§ 63. Items 9 and 10 of Section N103.1 of appendix N of the New York city building code, as added by local law number 33 for the year 2007, are amended to read as follows:

9. All ~~[input]~~ electrical wiring ~~[must comply]~~ installations shall be in accordance with the *New York City Electrical Code*.
- ~~[10. The installation of all stand-alone components of the system must comply with the *New York City Electrical Code*.]~~

§ 64. Items 9, 10 and 11 of Section N104.1 of appendix N of the New York city building code, as added by local law number 33 for the year 2007, are amended to read as follows:

9. All ~~[input and output]~~ electrical wiring ~~[must comply]~~ installations shall be in accordance with the New York City Electrical Code.
10. ~~[The installation of all stand-alone components of the system must comply with the New York City Electrical Code.~~
- ~~11.]~~ The frequencies used by the transmitter should be in compliance with applicable FCC rules.

§65. Appendix P of the New York city building code is REPEALED and a new appendix P is added to read as follows:

APPENDIX P
RESERVED

§66. Appendix Q of the New York city building code is REPEALED and a new appendix Q is added to read as follows:

APPENDIX Q
**MODIFIED NATIONAL STANDARDS FOR AUTOMATIC SPRINKLER,
STANDPIPE, FIRE PUMP, FIRE ALARM, AND SMOKE CONTROL SYSTEMS**

SECTION BC Q101
SCOPE

Q101.1 Scope. This appendix provides the modifications to the nationally recognized standards NFPA 13, NFPA 13D, NFPA 13R, NFPA 14, NFPA 20, NFPA 72, and NFPA 92, governing the installation and maintenance requirements of automatic sprinkler systems, standpipe and hose systems, fire pumps, fire alarms, and smoke control systems. Where a referenced publication has been modified for the City of New York as by the *New York City Building Code* and the *New York City Fire Code*, every reference to such publication shall be deemed to include all such modifications.

SECTION BC Q102
INSTALLATION OF SPRINKLER SYSTEMS

Q102.1 General. Sprinkler systems, where required by this code, shall be installed in accordance with NFPA 13, *Standard for the Installation of Sprinkler Systems*, 2016 edition, modified for New York City as follows. Refer to the rules of the department for any subsequent additions, modifications or deletions that may have been made to this standard in accordance with Section 28-103.19 of the *Administrative Code*.

Chapter 1 Administration No changes.

Chapter 2 Referenced Publications

2.1 Add at end the following: “Where a referenced publication has been modified for the City of New York by the *New York City Building Code* or the rules of the Department of Buildings, every reference to such publication shall be deemed to include all such modifications. Where the edition of a publication referenced within this standard differs from the edition provided for the same standard in Chapter 35 of the *New York City Building Code*, the edition provided for in Chapter 35 of the *New York City Building Code* shall govern.”

Chapter 3 Definitions No changes.

Chapter 4 General Requirements No changes.

Chapter 5 Classification of Occupancies and Commodities No changes.

Chapter 6 System Components and Hardware

6.3.1.1.1 Delete after the word wall and replace with the following: “in accordance with the *New York City Plumbing Code.*”

Add the following at the end of section **6.3.9.1.1**: “The use of pipe or tube other than that described above must involve consideration of many factors, including but not limited to the following:

1. Pressure rating.
2. Beam strength (hangers).
3. Corrosion (chemical and electrolytic).
4. Resistance to failure when exposed to elevated temperatures.
5. Methods of joining (strength, permanence, fire hazard).
6. Availability of fittings (for sprinkler outlets and proper routings).
7. Physical characteristics relating to integrity during earthquakes.
8. Toxicity.
9. Combustibility.
10. Movement during sprinkler operation (water distribution).”

Add Section **6.3.9.9** Non-metallic piping and fittings are permitted to be used only in Group R occupancies 6 stories or less in height.

6.7.1.3 Delete.

6.7.3 Delete.

Add Section **6.8.2.2.3** The alarm apparatus for a dry-pipe system shall also consist of approved low and high air pressure alarm attachments to the dry-pipe valve.

6.8.5 Change “8.16.2.6” to “8.17.1.9”.

Chapter 7 System Requirements

7.1.5 Delete.

7.1.5.1 Delete.

Add 7.2.6.3.4 to read as follows: “High/Low air pressure in the system shall be monitored so that either condition sends a supervisory signal. Such signal shall trigger an audible notification signal and shall report to a supervising station if the system is required otherwise to do so.”

7.2.6.8.3 Delete and replace with the following: “High / Low air pressure in the system shall be monitored so that either condition sends a supervisory signal. Such signal shall trigger an audible notification signal and shall report to a supervising station if the system is required otherwise to do so.”

7.6.3.1 Delete.

Figure 7.6.3.1 Delete.

7.6.3.2 Add the following sentence at the end: “Backflow prevention device relief discharge shall be piped to a safe location.

7.9 Delete entire section, including subsections.

Chapter 8 Installation Requirements

8.2.1 Delete the first sentence and replace with the following: “The maximum floor area on any one floor to be protected by a single riser from a control and alarm device shall be as follows:”

8.15.3.2.1 Delete the words after “is” and replace with the following: “permanently blocked off so that storage cannot occur.”

8.15.4.1* Delete the reference to 8.15.4.4 and add the following at the end: “when required by other sections of this standard or the *New York City Building Code*.”

8.15.4.4 Delete.

8.15.5.3 Delete the words “in NFPA 101, or the applicable building code” and replace with the following: “in accordance with the *New York City Building Code*.”

8.15.5.4* Delete the words “in elevator machine rooms or”.

8.15.7.4 Delete.

8.15.7.5 Delete.

8.15.8.1.2 Delete all words after and including “as defined”.

8.15.8.2* Delete and replace with the following: “Closets and Pantries. Sprinklers are not required in clothes closets, linen closets, and pantries within:

- (1) Dwelling units in hotels and motels where the area of the closet or pantry does not exceed 24 square feet (2.2 m), the least dimension does not exceed 3 feet (0.9 m), and the walls and ceilings are surfaced with noncombustible or limited-combustible materials; and

(2) Dwelling units in Group R occupancies other than hotels and motels where the area of the closet or pantry does not exceed 12 square feet (1.1 m), the room or space upon which the closet or pantry opens is equipped with sprinklers designed to afford protection to the opening of the closet or pantry, and the walls and ceilings of the closet or pantry are surfaced with noncombustible or limited-combustible materials.”

8.15.9 Add the following after the word “closets”: “without solid doors”.

8.15.16 Delete.

8.15.20.4.4 Delete and replace with the following: “In altering existing sprinkler systems which contain ¾-inch (19 mm) pipe, the existing ¾-inch (19 mm) pipe shall be removed and replaced with pipe having a minimum diameter of 1-inch (25 mm) except as provided for in 8.15.20.4.1, 8.15.20.4.2, 8.15.20.4.3 and 8.15.20.4.5.”

Add **8.15.20.4.5** “Where nipples used are less than 1 in. (25 mm) diameter, nipples shall be schedule 80 and no longer than shoulder length.”

8.15.20.5.4 Delete and replace with the following: “Where nipples used are less than 1 in. (25 mm) diameter, nipples shall be schedule 80 and no longer than shoulder length.”

8.15.23.3 Delete.

8.15.26 Delete and replace with the following: “Sprinkler Interior Protected Glazing. Where sprinklers are used in combination with glazing as an alternative to a required fire-rated wall or window assembly, the sprinkler-protected assembly shall be approved by the commissioner and shall comply with the following:

“(1) Sprinklers shall be listed as specific application window sprinklers unless standard spray sprinklers are specifically permitted by the commissioner.”

“(2) Sprinklers shall be supplied by a wet-pipe system.”

“(3) Where the assembly is required to be protected from both sides, sprinklers shall be installed on both sides of the glazing.”

“(4) The use of sprinkler protected glazing shall be limited to non-load-bearing walls.”

“(5) The water supply duration for the design area that includes the window sprinklers shall not be less than the required rating of the assembly.”

Add **8.16.1.1.1.4** to read as follows: “An approved indicating shutoff valve may be used in lieu of an O.S.&Y. gate valve wherever referred to in these modifications except such valve shall not be part of the pressure reducing valve. The indicator shall be readily visible from the floor.”

Add **8.16.1.1.1.5** to read as follows: “A connection from public water system shall not extend into or through a building unless such connection is under the control of an outside indicator post or O.S.&Y. gate or under the control of an inside O.S.&Y. gate valve located near the outside wall of the building.”

Add 8.16.1.1.1.6 to read as follows: “All gate valves controlling water supplied for sprinklers shall be located where readily accessible and when necessary, permanent ladders, clamped treads on risers, chains and wheels, or other accepted means shall be provided.”

Add 8.16.1.1.1.7 to read as follows: “Floor control valves shall be provided where required or in special cases where area or height or number of tenants is excessive, both in manufacturing and mercantile buildings, or where contents are more than ordinarily susceptible to damage. Floor valves shall be located where they are readily accessible. They are to be O.S.&Y. or indicating type located ahead of the inlet of any pressure reducing valve.”

Add 8.16.1.1.1.8 to read as follows: “Valves controlling sprinkler supplied from the standpipe system shall be listed for standpipe service in the pressure zone in which it is installed. They shall be O.S.&Y. or indicating valves, and shall be located ahead of the inlet of any pressure reducing valve installed.”

8.16.1.1.2.2 Delete and replace with the following: “Floor control valves in high-rise buildings shall comply with 8.16.1.1.2.1(1) or 8.16.1.1.2.1(2).”

8.16.1.1.2.5 Delete.

8.16.1.1.3.5 Delete and replace with the following: “Where there is one water supply connection a check valve shall be installed. Such check valve may be a swing check, alarm check, an approved fire meter or an approved detector check.”

Add 8.16.1.1.3.6 to read as follows: “Where a system having only one dry-pipe valve is supplied with city water and Fire Department connection, it will be satisfactory to install the main check valve in the water supply connection in a vertical position immediately inside of the building after the main indicating valve.”

Add 8.16.1.1.3.7 to read as follows: “Check valves on tank or pump connections, when located underground, may be placed inside of buildings and at a safe distance from the tank riser or pump, except in cases where the building is entirely of one fire area, in which case the check valve may be located over-head in the lowest level.”

Add 8.16.1.1.4.5 to read as follows: “Where either a wet or dry pipe sprinkler system is supplied by city water and a Fire Department connection and has more than one riser with O.S.&Y. gate valve in each, and the whole system is controlled by one outside post indicator valve, the main check valve in the water supply connection may be installed immediately inside building. If the supply is controlled by an underground gate valve with a Department of Environmental Protection standard curb, roadway or sidewalk flush box, the main check valve in the water supply connection shall be installed immediately after the O.S.&Y. gate valve inside the building.”

Add 8.16.1.1.4.6 to read as follows: “A gate valve shall be installed on each side of each check valve under conditions other than described in 8.16.1.1.4.1, 8.16.1.1.4.2, 8.16.1.1.4.3 and 8.16.1.1.4.4. However, this shall not apply to two-way Fire Department check valves.”

Add 8.16.1.1.4.7 to read as follows: “In a city connection serving as one source of supply, the city valve in the connection may serve as one of the required gate valves. An O.S.&Y. valve or an indicator post valve shall be installed on the systems (water supply) side of the check valve.”

8.16.1.1.5 Delete and replace with the following: “Where a gravity tank is located on a tower in the yard, the gate valve on the tank side of the check valve shall be of O.S.&Y. type; the other shall be either an O.S.&Y. valve or other listed indicating valve. Where a gravity tank is located on a building, both gate valves shall be the O.S.&Y. type; and all fittings inside the buildings, except the drain tee fill line, and heater connections, shall be under the control of a gate valve.”

8.16.1.2.4 Delete all words after and including the word “unless.”

8.16.1.2.5 Delete all words after and including the word “at.”

Add 8.16.1.3.4 to read as follows: “Where sprinklers are supplied from a yard main, a listed outside indicator post gate valve shall be placed in the connecting pipe at a safe distance from the building. Indicator post valves shall be located not less than 40 feet (12 192 mm) from buildings; but where necessary to place a valve close to a building, it shall be located at a blank part of the wall.”

Add 8.16.1.3.5 to read as follows: “When a building has no basement, and an outside post indicator control cannot be furnished, a short post indicator may be installed in a horizontal position in riser with handwheel projecting outside of wall.”

Add 8.16.1.4.2.7 to read as follows: “Pits for underground valves, except those located at the base of a tank riser, are described in the Standard for Outside Protection (ANSI/NFPA No. 24-2010). For pits protecting valves located at the base of a tank riser, refer to 8.15.1.4.2.6.”

8.16.2.3.2 Add at the end the following: “unless the system is installed utilizing schedule 40 steel piping for sizes 1” to 6” and a minimum of schedule 30 steel piping for sizes 8” and larger.”

Table 8.16.2.4.2 Delete and replace with the following:

TABLE 8.16.2.4.2
SECTIONAL OR FLOOR VALVE SIZE
MINIMUM SIZE OF DRAIN CONNECTION

<u>Up to 2 in.</u>	<u>1 in.</u>
<u>2½ in. to 4 in.</u>	<u>1¼ in.</u>
<u>5 in. and larger</u>	<u>2 in.</u>

8.16.4.1.5 Delete.

8.16.6 Delete.

Add 8.17.1.5.3 to read as follows: “Identification signs shall be provided for outside alarm devices. The sign shall be located near the device in a conspicuous position and shall be worded as follows: “SPRINKLER FIRE ALARM –WHEN BELL RINGS NOTIFY FIRE DEPARTMENT OR POLICE”.”

8.17.1.6 Add at end a new item 4 as follows: “(4) Refer to NFPA 72 for further requirements.”

Add 8.17.1.8 to read as follows: “Dry Pipe System Alarms.”

Add 8.17.1.8.1 to read as follows: “The alarm apparatus for a dry-pipe system shall consist of approved low and high air pressure alarm attachments as well as waterflow pressure type alarm attachments to the dry-pipe valve. When a dry-pipe valve is located on the system side of an alarm valve, the actuating device of the alarms for the dry-pipe valve may be connected to the alarms on the wet-pipe system.”

Add 8.17.1.9 1 to read as follows: “Drains for Alarm Devices.”

Add 8.17.1.9.1 to read as follows: “Where vents are necessary for satisfactory electric alarm switch operations, such vents shall be properly piped to a drain.”

Add 8.17.1.9.2 to read as follows: “Drains from alarm devices shall be so arranged that there will be no danger of freezing, and so that there will be no overflowing at the alarm apparatus, at domestic connections or elsewhere with the sprinkler drains wide open and under pressure.”

Add 8.17.1.9.3 to read as follows: “Drain from retarding chamber and electric alarm switch shall be permitted to discharge through an open cone and be run separate from main system drains to a safe and visible point of free discharge or to sewer or ground drain. Drain from water-motor-operated alarm device may run separately to sewer or ground drain or may be connected to drain from retarding chamber at a point between such sewer and a check valve on this drain, a union or plug being inserted in the drain from the alarm device to permit inspection. Where checks are used, they shall be so located as to have the equivalent of at least a four-foot (1219 mm) head and shall not be installed in a vertical position.”

Add 8.17.1.9.4 to read as follows: “Where drains are conveyed to a sewer, a proper trap shall be provided.”

Add 8.17.1.9.5 to read as follows: “Where it is necessary to drain alarm valves outside the wall, an open discharge cone shall be provided inside to break the pipe line so that cold air will not conduct directly into the retarding chamber. Alternately, all drains shall have at least 4 feet (1219 mm) of pipe beyond the valves, in a warm area.”

8.17.2.2 Delete items 1 –3 and add the following:

“(1) Systems with sprinklered areas not exceeding 2000 square feet (186 m²).”

“(2) Systems containing 36 or fewer sprinkler heads except as otherwise required by other sections of this referenced standard.”

8.17.2.3 Delete items 1 –3 and add the following:

“(1) Minimum size of two-way Fire Department connection is 5 inches (127 mm) except for two-way Fire Department connections supplying a single system with a riser smaller than 5 inches (127 mm) where a 4 inch (102 mm) two-way Fire Department connection may be used.”

8.17.2.4.6 Delete.

Add 8.17.4.2.1.1 to read as follows: “This test pipe shall be not less than 1-inch in diameter, located in the upper story, and the connection shall be permitted to be piped from the end of the most remote branch line. The discharge shall be at a point where it can be readily observed. In locations where it is not practical to terminate the test pipe outside the building, the test pipe may terminate in a drain. In such case, the test connection shall be made using a sight test connection containing a smooth bore corrosion resistant orifice giving a flow equivalent to one sprinkler. The test valve shall be located at an accessible point, and not over seven feet above the floor. The control valve on the test connection shall be located at a point not exposed to freezing.”

8.17.5 Delete.

Chapter 9 Hanging, Bracing, and Restraint of System Piping

9.2.1.3.3 Delete all subsections and replace with the following:

“9.2.1.3.3.1 Listed flexible hose fittings and their anchoring components intended for use in installations connecting the sprinkler system piping to sprinklers shall be rigidly fixed to the building structure at the sprinkler end of the flexible hose, independent of the ceiling suspension and support system in accordance with ASTM C 635, Section 3.1.1.10, as modified by Appendix R of the *New York City Building Code*.”

9.3.4.11 Delete.

9.3.4.11.1 Delete.

Chapter 10 Underground Requirements

10.10.1 Delete and replace with the following: “The installing contractor shall perform all required inspections and acceptance tests in accordance with this chapter prior to scheduling an inspection.”

Figure 10.10.1 Delete.

Chapter 11 Design Approaches

11.1.4.2* Delete and replace with the following: “The minimum water supply requirements for a pipe schedule designed sprinkler system shall be per the requirements of 11.2.2. The minimum water supply requirement for a hydraulically calculated sprinkler system shall be the calculated sprinkler system demand only, for the duration indicated in Table 11.2.3.1.2. Where gravity tanks are used as the supply or a portion of the supply to a hydraulically designed sprinkler system, it shall not be required to balance the calculated sprinkler flow and pressure demand to the outlet pressure of the gravity tank for the calculation of the water supply duration. The total water supply required shall be the product of the calculated system flow only, multiplied by the required water supply duration.”

Add 11.1.4.2.1 to read as follows: “In fully sprinklered buildings, where an Automatic Wet Standpipe System is not required by Section 905 of the *New York City Building Code*, the storage capacity of the fire reserve in the tank supplying water to the sprinkler system shall be as required for the sprinkler demand, at a minimum.”

11.1.6 Delete.

Add 11.2.2.10 to read as follows: “Where the water supply to a system sized in accordance with the pipe sizing schedules is taken from a water storage tank, the adequacy of the tank capacity shall be verified with a hydraulic calculation.”

Table 11.2.3.1.2 Delete hose stream allowances.

11.2.3.1.5.2 (10) Delete.

Add 11.2.3.2.3.4 to read as follows: “Reductions in the size of the calculated area of operation shall not be taken for the use of quick response sprinklers in the design of systems in existing buildings employing fixed duration stored water supplies of less than 5,000 gallons.”

Chapter 12 General Requirements for Storage

12.2 Delete.

12.7.2 Delete the following: “the hose stream allowance and”.

12.7.4 Delete the following: “adding the hose stream allowance from 12.8 to”.

12.8 Delete the following: “Hose Stream Allowance and”.

12.8.4 Delete.

12.8.5 Delete.

12.8.6 Delete the following: “adding the hose stream allowance from Table 12.8.6 to”.

Table 12.8.6 Remove the column(s) titled “Hose Stream Allowance” and all of its corresponding requirements.

12.12.1.2 Delete the following: “existing with a hose stream demand of at least 250 gpm (950 L/min)”.

Chapter 13 Protection of Miscellaneous and Low-Piled Storage

13.1.2 Delete.

Table 13.2.1 Remove the column(s) titled “Inside Hose” and all of its corresponding requirements.

Chapter 14 Protection for Palletized, Solid-Piled, Bin Box, Shelf, or Back-to-Back Shelf Storage of Class I through Class IV Commodities

14.3.4 Delete the following: “Hose stream allowance and”.

Chapter 15 Protection for Palletized, Solid-Piled, Bin Box, Shelf, or Back-to-Back Shelf Storage of Plastic and Rubber Commodities No changes.

Chapter 16 Protection of Rack Storage of Class I Through Class IV Commodities

Table 16.3.3.1 Remove Hose Stream Allowance Requirements.

Chapter 17 Protection of Rack Storage of Plastic and Rubber Commodities

17.3.1.17 Delete the following: “adding the hose stream allowance from Table 17.3.1.17 to”.

Table 17.3.1.17 Delete.

Chapter 18 Protection of Rubber Tire Storage

18.3 Delete the following: “hose streams”.

Chapter 19 Protection of Roll Paper

19.1.1.1 Delete the following: “plus the hose stream allowance”.

Chapter 20 Special Designs of Storage Protection

20.3.1 Delete the following: “with 500 GPM (1900 L/min) hose stream allowance”.

20.3.2 Delete the following: “with 500 GPM (1900 L/min) hose stream allowance”.

20.3.3 Delete the following: “with 500 GPM (1900 L/min) hose stream allowance”.

20.3.4 Delete the following: “with 500 GPM (1900 L/min) hose stream allowance”.

20.3.5 Delete the following: “with 500 GPM (1900 L/min) hose stream allowance”.

20.3.6 Delete the following: “with 500 GPM (1900 L/min) hose stream allowance”.

20.4.1.1 Delete the following: “plus a minimum of 500 gpm (1900 L/min) for hose streams”.

20.4.1.2 Delete the following: “and hose streams”.

Table 20.5.6.2 Remove the row(s) titled “Hose Allowance” and all of its corresponding requirements.

Chapter 21 Alternative Sprinkler System Designs for Chapters Through 20

21.1.7(5) Delete.

21.4 Delete the following: “Hose Stream Allowance and”.

21.4.1 Delete the following: “adding the hose stream allowance from Table 21.4.1 to”.

Table 21.4.1 Remove the column(s) titled “Hose Stream Allowance” and all of its corresponding requirements.

Chapter 22 Special Occupancy Requirements

Add 22.1.1.3 to read as follows: “The application of the requirements of this chapter are subject to the approval of the Fire Commissioner.”

22.12.1.2 Delete.

22.12.1.3 Delete the following: “to augment hand hose streams”.

22.13.1 Delete the following: “plus an allowance of 1000 gpm (63 L/sec) for hand hose streams for not less than 2 hours”.

22.15.2.2.1 Gravity Waste and Linen Chutes. Add the following after the heading: “Sprinklers shall be provided in chute vestibules on all floors; if no vestibule exists, sprinklers shall be provided above chute doors and shall be located no more than 1-foot (25 mm) horizontally from face of chute door. All building service chute sprinkler systems shall be provided with a local water flow and valve supervisory alarm with supervising station annunciation. In high rise buildings where sprinklers in chutes are supplied by a chute riser(s), such riser(s) shall be zoned to coincide with the zoning of the standpipe riser(s).”

22.15.2.2.1.5 Delete.

22.21.1.7.3 Delete.

22.21.7.4 Delete the following: “plus the hose stream demand specified in 22.21.1.7.3”.

22.25.1.4 Delete the following: “plus a minimum of 500 gpm (1893 L/min) for hose streams”.

22.26.1.2 Delete the following: “plus hose stream demand”.

22.26.1.2.1 Delete.

22.27.1.1(1) Delete the following: “500 gpm (1892.5 L/min) for manual hose streams plus”.

22.28.1(2)(a) Delete the following: “500 gpm (1892.5 L/min) for manual hose streams plus”.

Table 22.37.1.4.4.1(B) Remove the row titled “hose stream demand” and all of its corresponding requirements.

Table 22.37.1.4.4.3 Remove the row titled “hose stream demand” and all of its corresponding requirements.

Chapter 23 Plans and Calculations

23.1.3(35) Delete the following: “and the water required for hose streams both inside and outside.”

23.3.2(9) Delete “inside hose”.

23.3.4(3) Delete and renumber (4) to (3).

23.3.5.2(16) Delete “inside hose.”

23.3.5.3(3) Delete and renumber (4) and (5) to (3) and (4), respectively.

23.3.5.5(4) Delete.

23.4.4.2.5 Delete “not including hose stream allowance”.

Chapter 24 Water Supplies

24.1.1 Add the following at the end of the section:

“(a) Two automatic sources of water supply shall be provided for sprinklers in:”

“(1) Buildings classified in occupancy group H.”

“(2) Buildings classified in occupancy group M when the area on one floor exceeds 20,000 square feet (1858 m²).”

“(3) Buildings classified in occupancy group A-1 with stages larger than 1,000 square feet (93 m²) in floor area or with a stage height greater than 40 feet (15 240 mm).”

“(b) The domestic water supply may be used to supply any sprinklers required by Section 903 of the *New York City Building Code* when installed in buildings classified in occupancy groups B, E, I and R, and not classified as a high-rise building, provided that all the requirements stated in subdivision (d) of this section are met.”

“(c) The domestic water supply may be used to supply water to sprinklers in cooling towers if provision is made to automatically stop the use of water through the domestic supply lines and provided that all of the requirements stated in subdivision (d) of this section are met.”

“(d) When the domestic water is used to supply sprinklers as permitted in subdivisions (b) and (c) of this section, all of the following conditions shall be met:”

“(1) The domestic water supply line from the tank or street supply shall be at least the size of the sprinkler line and the capacity available shall be at least equal to the capacity required for the sprinklers.”

“(2) The domestic water supply line from the tank or street shall have the required pressure as provided in this referenced standard.”

“(3) The domestic water supply line shall be of non ferrous material except when the domestic water supply is four inches (102 mm) or more.”

“(4) An O.S.&Y. valve or other listed valve having visual indication, and sealed open, shall be installed in the sprinkler supply branch, or such other valve arrangement as may be provided in this referenced standard and in referenced standards NFPA-13R or NFPA 13-D as modified for New York City, as applicable.”

“(5) The pipe connecting the domestic water supply and the sprinkler control valve shall be of nonferrous material and not less than twelve inches (305 mm) long.”

“(6) The number of heads in each fire section shall not exceed six, except that the number of heads in each fire section may exceed six in buildings classified in occupancy group R-2, or R-3 not exceeding six stories or 75 feet (22 860 mm) in height and in spaces classified in occupancy group R-2, or R-3 in buildings not exceeding six stories or 75 feet (22 860 mm) in height, provided that no more than three heads are supplied from any one domestic water riser.”

“(7) The connection shall be made at the supply or riser side of any domestic branch control valves.”

“(8) In connection with the above conditions, the number of fire sections having 6 or fewer heads may be unlimited; and the installation of alarms in branches supplying fire sections shall be at the option of the owner, except that such alarms shall be provided where required by referenced standards NFPA-13R and NFPA-13D as modified for New York City.”

“(9) A check valve shall be installed on the sprinkler supply branch.”

24.1.3.2(1) Delete the words “or Class II Standpipes”.

Add **24.2.3.1** to read as follows: “Combined Use. In light hazard occupancies with only limited ordinary hazard areas, an automatic fire pump serving the lower 300 feet (91 440 mm) of the standpipe system may be used as the primary supply to the sprinkler system, provided that an automatic switching secondary power supply is available to drive the pump, where secondary power is required by other provisions of this code, and that the pump is fully supervised as to pump running and power loss. The supervisory attachments shall be directly connected to an office where maintenance personnel are in attendance twenty-four hours a day; or, in lieu thereof, the supervisory attachment may be directly connected to the supervising station of an approved operating fire alarm company.”

Add **24.2.3.2** to read as follows: “In hydraulically designed sprinkler systems supplied from a gravity tank, the pressure may be increased by means of an automatic, special service fire pump. The pump shall be sized to satisfy the water supply requirements of this section and the *New York City Building Code* and shall be arranged with a bypass to permit the portion of the system so supplied to be served by the system’s two-way Fire Department connections.

If the pump is not supplied from the street side of the building service switch, the electrical service and pump operation shall be fully supervised and an automatic switching secondary power supply provided to drive the pumps, where secondary power is required by other provisions of this code.”

Add **24.2.3.3** to read as follows: “Wiring for Fire Pumps. When the fire pump feeder conductors are routed through the building(s), they shall be enclosed by 2 inches (51 mm) of concrete or an assembly that has a minimum of 2-hour fire resistive rating. Wiring for all fire and sprinkler pumps shall be in accordance with the *New York City Electrical Code*.”

Add **24.2.3.4** to read as follows: “**Sprinkler Booster Pumps.** Where the pressure from the city water main is insufficient to comply with the requirements of this referenced standard, but is sufficient to provide at least 5 PSI (34 kPa) at the highest level of sprinklers as determined by test, an automatic,

electrically driven pump installed for the purpose of boosting or increasing the city water pressure in the sprinkler system may be used subject to the following requirements:”

- “(a) Pumps shall be of approved centrifugal type, capable of delivering at least 200 gpm (757 L/m), and shall be capable of supplying the calculated flow and pressure demand of the sprinkler system.”
- “(b) Pumps shall be maintained under approved automatic control with closed circuit supervisory attachment. The supervisory attachments shall be directly connected to an office where maintenance personnel are in attendance twenty-four hours a day; or, in lieu thereof, the supervisory attachment may be directly connected to the supervising station of an approved operating fire alarm company. The supervisory alarm services shall be arranged so as to provide positive indication at an approved central office or sprinkler alarm panel board that the pump has operated or that the source of electrical supply has failed.”
- “(c) Such pumps shall also comply with the applicable provisions of this referenced standard and the *New York City Building Code* pertaining to fire pumps, except that only one water supply shall be required.”
- “(d) Power to such pumps shall be supplied from the street side of the building service switch. Secondary power shall be provided where required by other provisions of this code.”
- “(e) If a secondary power supply is provided to drive the pump and such power supply is automatic switching, the 5 psi (34 kPa) requirement in 23.2.2.4 and the requirements of paragraph (d), for power to be supplied from the street side of the building service switch, may be waived.”

24.2.4.1 through 24.2.4.3, including all subsections Delete.

Add 24.2.4.1 to read as follows: “A pressure tank providing water supply in accordance with Table 11.2.2.1 or section 11.2.3 is an acceptable water supply source. The total available quantity of water in pressure tanks need not exceed 15,000 gallons (56 781 L) when there is a secondary source of water supply available from a gravity tank or a street connection. The maximum gross capacity of a single pressure tank shall be 9,000 gallons (34 069 L) and shall include the needed extra capacity to fill dry-pipe or preaction systems when installed.”

Add 24.2.4.1.1 to read as follows: “Each tank shall be kept at a maximum of 2/3 full of water and a minimum of 1/3 full of air maintained under a minimum pressure of 75 psig (517 kPa). The water-to-air ratio shall be so proportioned and the tank so located that a minimum pressure of 15 psig (103 kPa) will be available on the highest line of sprinklers below the main roof when all the water has been discharged from the tank.”

Add 24.2.4.1.2 to read as follows: “The tank supports shall be designed on the basis of a full tank. The tanks shall be supplied with water through a fixed pipe, independent of the sprinkler piping and at least 2 inch (51 mm) in size. The water supply shall be capable of supplying the tank at a rate of at least 65 gpm (4 L/s) without decreasing the pressure in the tank. The tank shall have a fixed water level plate on the end of the tank opposite the gage glass, or equivalent devices, to indicate the level of the water in the tank.”

Add 24.2.4.1.3 to read as follows: “The air compressor shall be provided with automatic controls for maintaining the air pressure. The capacity of the compressor shall be sufficient to build up the tank pressure to 75 psig (517 kPa) within 3 hr. or less.”

Add 24.2.4.1.4 to read as follows: “Pressure tanks shall be provided with closed circuit high and low water and high and low air pressure alarms.”

Add 24.2.4.1.5 to read as follows: “Pressure tanks shall be located at or above the top level of sprinklers.”

24.2.5 Add at end the following: “If any of the sprinkler heads are supplied from domestic water tanks, the combined water supply in the tank shall be at least 5,000 gallons (18 927 L). Further, the sprinkler water supply shall be taken from the lowest level of the tank.”

Add 24.2.5.1 to read as follows: “Combined Use. In A, B, E, I and R Occupancies, with only limited ordinary hazard areas, the sprinkler and standpipe reserve may be common to both. The Reserve shall be sized for the greater demand, in accordance with NFPA 14, 7.10.1.3. For purposes of this section, limited shall be defined as less than 30 percent of the floor area on the given floor. Buildings whose occupancies are more than 85 percent light hazard may have a light hazard water supply, provided the ordinary hazard areas are designed for ordinary hazard requirements with respect to sprinkler spacing and pipe sizing.”

Add 24.2.5.2 to read as follows: “Combined standpipe and sprinkler systems may be used in Occupancies A, B, E, F, I, M, R and S. If an automatic fire pump is used as the primary supply, the requirements of 23.2.2.1 shall apply.”

Chapter 25 Systems Acceptance

25.1 Delete and replace with the following: “The installing contractor shall inspect and test the installation in accordance with the procedures of this chapter prior to scheduling an inspection.”

25.2.1.1 Delete the words “2 hours” and replace with “1 hour”.

25.2.1.4.1 Delete the words “2 hours” and replace with “1 hour”.

25.2.1.7 Delete the words “150 psi (10.3 bar)” and replace with “200 psi (13.8 bar)”.

25.3 Delete entire section, including subsections.

25.3.1 Delete.

25.3.2 Delete.

25.3.3 Delete.

25.3.4 Delete.

25.5.2(5) Delete.

25.6.2 (13) Delete item 13 and renumber remainder of items accordingly.

Chapter 26 Marine Systems. No changes.

Chapter 27 System Inspection, Testing, and Maintenance

27.1 Delete and replace with the following: “General. A sprinkler system installed in accordance with this standard shall be properly inspected, tested, and maintained in accordance with NFPA 25, Standard for the Inspection, Testing, and Maintenance of Water-Based Fire Protection Systems and the *New York City Fire Code*, to provide at least the same level of performance and protection as designed.”

ANNEXES

The annexes are not a part of the requirements of this Referenced Standard but are included for informational purposes only. These annexes contain explanatory material, numbered to correspond with the applicable text paragraphs. In the event of any conflict between the Annexes and the body of the Referenced Standard, particularly where modifications have been made for New York City, the body of the Referenced Standard will govern.

Annex A Explanatory Material

Annex B Miscellaneous Topics

Annex C Explanation of Test Data and Procedures for Rack Storage

Annex D Sprinkler System Information from the 2012 Edition of the Life Safety Code

Annex E Development of the Design Approach to Conform with SEI/ASCE 7

Annex F Informational References

SECTION BC Q103 INSTALLATION OF SPRINKLER SYSTEMS IN ONE- AND TWO-FAMILY DWELLINGS AND MANUFACTURED HOMES

Q103.1 General. Sprinkler systems, where required by this code, shall be installed in accordance with NFPA 13D, *Standard for the Installation of Sprinkler Systems in One- and Two-Family Dwellings and Manufactured Homes*, 2016 edition, modified for New York City as follows. Refer to the rules of the department for any subsequent additions, modifications or deletions that may have been made to this standard in accordance with Section 28-103.19 of the *Administrative Code*.

Chapter 1 Administration No changes.

Chapter 2 Referenced Publications

2.1 Add at end the following: “Where a referenced publication has been modified for the City of New York by the *New York City Building Code* or the rules of the Department of Buildings, every

reference to such publication shall be deemed to include all such modifications. Where the edition of a publication referenced within this standard differs from the edition provided for the same standard in Chapter 35 of the *New York City Building Code*, the edition provided for in Chapter 35 of the *New York City Building Code* shall govern.”

Chapter 3 Definitions

3.3.11.3 Delete.

3.3.11.7 Delete.

Chapter 4 General Requirements No changes.

Chapter 5 System Components

5.2.2 Add at end the following: “Non-metallic pipe shall be used in wet systems only.”

5.2.2.3 Delete.

5.4 Delete.

Chapter 6 Water Supply

6.2 Add the following as item (6):

“(6) A common supply main to the building, serving both sprinklers and domestic uses, may be used if provision is made to prevent flow on the domestic water system upon operation of sprinklers, and closure of the main sprinkler control valve (the house control valve) will shut off the domestic water supply.”

6.3 Delete.

Chapter 7 Installation

7.1.1 Delete the words “unless a separate shutoff valve for the sprinkler system is installed in accordance with 7.1.2.”

7.1.2 **Delete and replace with the following:** “Except for the meter set controlling combined domestic water and fire sprinkler systems, sectional control valves and other valves if provided in supply pipes to sprinklers shall be locked open and supervised open by one of the following methods:”

“(a) Supervising station, proprietary or remote station signaling service, or”

“(b) Local signaling service that will cause the sounding of an audible signal.”

“Exception: Underground gate valves with roadway boxes need not be supervised.”

7.1.3 Delete the words “other than those complying with Section 6.3.”

7.6 Add at the end the following: “as modified for New York City.”

Chapter 8 Sprinkler Position and Location

8.3.4 Add the following after the word “garages”: “provided that at least one sprinkler head is located within 3 feet (914 mm) of any communicating opening between the garage and the dwelling.”

8.3.5 Add after the word “attics”, the words “without floors”.

Chapter 9 Protection from Freezing

9.2.3.1.1 Delete and replace with the following: “Arrangement of supply piping to an anti-freeze system shall be in accordance with NFPA-13-2016 as modified for New York City.”

9.2.3.1.2 Delete.

9.2.3.1.3 Delete.

9.2.3.1.4 Delete.

9.2.3.2 Delete.

9.2.3.2.1 Delete.

9.2.3.2.2 Delete.

9.2.3.2.3 Delete.

Chapter 10 Discharge and Hydraulic Calculations

10.4.2.2 Delete the words “unless smaller sizes are permitted by 10.4.2.3.”

10.4.2.3 Delete.

Chapter 11 System Acceptance

11.2.1.1 Delete and replace with the following: “Where a Fire Department pumper connection is not provided, the system shall be hydrostatically tested for leakage at 50 psi (344 kPa) above normal system operating pressure and checked visually for leakage at each joint or coupling.”

11.2.1.2 Add the following to the end: “As modified for New York City. Dry systems shall also be tested by placing the system under 40 pounds (2.8 bar) air pressure. Any leak that results in a drop in system pressure greater than 2 psi (0.14 bar) in 24 hours shall be corrected. Check for leaks using soapy water brushed on each joint or coupling. Leaks will be shown by the presence of bubbles. This test shall be made prior to concealing of piping.”

Chapter 12 Inspection, Testing, and Maintenance

12.1 Add at end the following: “The owner is responsible for the maintenance of the system.”

ANNEXES

The annexes are not a part of the requirements of this Referenced Standard but are included for informational purposes only. These annexes contain explanatory material, numbered to correspond with the applicable text paragraphs. In the event of any conflict between the Annexes and the body of the Referenced Standard, particularly where modifications have been made for New York City, the body of the Referenced Standard will govern.

Annex A Explanatory Material

A.5.2.3.2 Delete.

Figure A.6.2(c) Delete the “Fire sprinkler shutoff valve (supervised or lockable)*” shown.

A.6.3 Delete.

Figure A.6.3(a) Delete.

Figure A.6.3(b) Delete.

Figure A.6.3(c) Delete.

Figure A.6.3(d) Delete.

A.10.4.2.3(1) Delete.

Figure A.10.4.2.3(1) Delete.

Annex B Informational References No changes.

SECTION BC Q104 **INSTALLATION OF SPRINKLER SYSTEMS IN** **RESIDENTIAL OCCUPANCIES**

Q104.1 General. Sprinkler systems, where required by this code, shall be installed in accordance with NFPA 13R, *Standard for the Installation of Sprinkler Systems in Low-Rise Residential Occupancies*, 2016 edition, modified for New York City as follows. Refer to the rules of the department for any subsequent additions, modifications or deletions that may have been made to this standard in accordance with Section 28-103.19 of the *Administrative Code*.

Chapter 1 Administration

1.1 Delete after the word “including” and replace with the following: “six stories in height in buildings not exceeding 60 ft (18.3 m) in height above grade plane.”

1.2.3 Add at end the following: “in accordance with the *New York City Building Code*.”

Chapter 2 Referenced Publications

2.1 Add at end the following: “Where a referenced publication has been modified for the City of New York by the *New York City Building Code* or the rules of the Department of Buildings, every reference to such publication shall be deemed to include all such modifications. Where the edition of a publication referenced within this standard differs from the edition provided for the same standard in Chapter 35 of the *New York City Building Code*, the edition provided for in Chapter 35 of the *New York City Building Code* shall govern.”

Chapter 3 Definitions

3.3.6 Delete after the word “walls.”

3.3.9 Delete (Use definitions contained in *New York City Building Code*).

Chapter 4 General Requirements No changes.

Chapter 5 System Components

5.2.1 Add at the end the following: “Non-metallic pipe shall be used in wet systems only when standpipe is not present.”

5.2.11 Add at the end the following: “in accordance with the *New York City Plumbing Code*.”

5.3.2(1) Delete and replace with the following: “Antifreeze systems – Only glycerin type anti-freeze is permitted for use in systems containing non-metallic pipe or fittings.”

Chapter 6 Installation

6.5.4 Delete and replace with the following: “Sprinkler Interior Protected Glazing. Where sprinklers are used in combination with glazing as an alternative to a required fire-rated wall or window assembly, the sprinkler-protected assembly shall be approved by the commissioner and shall comply with the following:

“(1) Sprinklers shall be listed as specific application window sprinklers unless standard spray sprinklers are specifically permitted by the commissioner.”

“(2) Sprinklers shall be supplied by a wet pipe system.”

“(3) Where the assembly is required to be protected from both sides, sprinklers shall be installed on both sides of the glazing.”

“(4) The use of sprinkler protected glazing shall be limited to non-load-bearing walls.”

“(5) The water supply duration for the design area that includes the window sprinklers shall not be less than the required rating of the assembly.”

6.6.6* After the word “attics” add the words: “without floors”.

Add 6.6.10 to read as follows: “Location of sprinklers installed in buildings classified in occupancy group R-1 shall be in accordance with the requirements of the *New York City Building Code* and NFPA-13-2016 as modified for New York City.”

6.8.2 Delete and replace with the following: “Except for the meter set controlling combined domestic water and fire sprinkler systems, sectional control valves and other valves if provided in supply pipes to sprinklers shall be locked open and supervised open by one of the following methods:”

“(a) Supervising station, proprietary or remote station signaling service, or”

“(b) Local signaling service that will cause the sounding of an audible signal at a constantly attended point.”

“**Exception:** Underground gate valves with roadway boxes need not be supervised.”

6.11 Delete and replace with the following: “Fire Department Connection. Except in buildings classified in occupancy group R-1, at least one 3 in. (76 mm) single inlet Fire Department connection shall be provided and located in accordance with the *New York City Building Code*. Buildings classified in occupancy group R-1 shall be provided with two-way Fire Department connections in accordance with the referenced standard NFPA-13-2016 as modified for New York City. A Fire Department connection is not required in one-and two-family dwellings.”

6.11.1 Delete.

6.11.2 Delete.

6.11.5 Delete.

Chapter 7 Discharge Criteria No changes.

Chapter 8 Plans and Calculations No changes.

Chapter 9 Water Supply

9.3 Add the following as item (5):

“(5) A common supply main to the building, serving both sprinklers and domestic uses, may be used if provision is made to prevent flow on the domestic water system upon operation of sprinklers, and closure of the main sprinkler control valve (the house control valve) will shut off the domestic water supply.”

9.6 Delete.

Chapter 10 System Acceptance

10.1.2 Delete.

Figure 10.1.2 Delete.

10.1.3 Delete.

Chapter 11 Care and Maintenance

11.3 Delete and replace with the following: “Sprinkler systems shall be inspected, tested, and maintained in accordance with the *New York City Fire Code* and with the rules of the Fire Department.”

11.4 Delete.

ANNEXES

The annexes are not a part of the requirements of this Referenced Standard but are included for informational purposes only. These annexes contain explanatory material, numbered to correspond with the applicable text paragraphs. In the event of any conflict between the Annexes and the body of the Referenced Standard, particularly where modifications have been made for New York City, the body of the Referenced Standard will govern.

Annex A Explanatory Material

A.1.1 Delete the words “four stories” and replace with the words: “six stories”.

A.5.2.12.2 Delete.

A.9.6 Delete.

Table A.9.6(a) Delete.

Table A.9.6(b) Delete.

Annex B Informational References No changes.

SECTION BC Q105 **INSTALLATION OF STANDPIPE AND HOSE** **SYSTEMS**

Q105.1 General. Standpipe and hose systems, where required by this code, shall be installed in accordance with NFPA 14, *Standard for the Installation of Standpipe and Hose Systems*, 2016 edition, modified for New York City as follows. Refer to the rules of the department for any subsequent additions, modifications or deletions that may have been made to this standard in accordance with Section 28-103.19 of the *Administrative Code*.

Chapter 1 Administration No changes.

Chapter 2 Referenced Publications

2.1 Add at end the following: “Where a referenced publication has been modified for the City of New York by the *New York City Building Code* or the rules of the Department of Buildings, every reference to such publication shall be deemed to include all such modifications. Where the edition of a publication referenced within this standard differs from the edition provided for the same

standard in Chapter 35 of the *New York City Building Code*, the edition provided for in Chapter 35 of the *New York City Building Code* shall govern.”

Chapter 3 Definitions

3.3.3.1 Delete and replace with the following: “Fire Department Connection (FDC).”

3.3.3.1.1 Delete and replace with the following: “Standpipe System Fire Department Connection (Standpipe FDC). A connection through which the fire department can pump water to a standpipe system at the required system demand. Supplemental water can also be provided into the sprinkler system or other system furnishing water for fire extinguishment to supplement existing water supplies. Unless otherwise allowed in the *New York City Building Code*, FDCs shall be 2-way connections.”

3.3.3.1.2 Delete.

3.3.5.1 Delete the words ‘NFPA 101’ and replace with ‘the *New York City Building Code*’.

3.3.6 Delete and replace with the following: “Fire Department. The New York City Fire Department (FDNY).”

3.3.7 Add at end the following: “For the purposes of this section, a penthouse of any area with an occupant load greater than 10 shall be considered a story.”

3.3.8 Delete the words “or reel”.

3.3.9.1.1 Delete.

3.3.18 Delete.

3.3.19.2 Delete the words “trained personnel” and replace with “building occupants”.

3.3.19.3 Delete the words “trained personnel” and replace with “building occupants”. Add at end the following: “The hose stations shall be attached to the hose connections by a reducing coupling.”

3.3.21 Delete the words ‘and exclusive of pressure from the fire department connection’.

Add **3.3.24** to read as follows: “3.3.24 Zones”

Add **3.3.24.1** to read as follows: “Standpipe System Zone. A vertical subdivision of a standpipe system limited or determined by the pressure limitations of the system components. Standpipe System Zones shall not exceed 300 feet (91.4 m) in height.”

Add **3.3.24.2** to read as follows: “Fire Department Connection (FDC) Zone. A vertical subdivision of a standpipe system in buildings with more than two standpipe system zones arranged so that the Fire Department will pump through express FDC risers to upper zones.”

Chapter 4 System Components and Hardware

4.2.2 Delete and replace with the following: “Pipe for buried portions of the standpipe system, whether inside or outside of the building, shall be red brass, ductile iron, hard tempered type “K” copper tubing, galvanized steel or other approved corrosion resistant material. All such pipe, other than ductile iron, shall be adequately wrapped or otherwise protected against corrosion.”

Add 4.2.2.1 as follows: “Where ductile iron pipe is installed in accordance with Table 4.2.1, it shall be lined in accordance with AWWA C 104, *Cement-Mortar Lining for Ductile-Iron Pipe and Fittings*.”

4.2.3 Add at end the following: “Piping conforming to the specifications contained in this section may only be used in buildings with floor heights not exceeding 300 feet (91.4 m) above grade plane or in the highest 300 feet (91.4 m) portion of other buildings. Otherwise, piping conforming to the wall thicknesses specified in 4.2.4 shall be used.”

4.4.1.2 Delete.

4.4.2.2.2 Replace “NFPA 51B” with “the *New York City Fire Code*”.

4.4.2.2.3 Replace “NFPA 51B” with “the *New York City Fire Code*”.

4.5.1 Add at end the following: “6 inch (152 mm) and larger sectional and riser control valves shall have a minimum ¾ inch (197 mm) valved bypass.”

4.6.2.1 Delete and replace with the following: “Class III Standpipe Hose Stations. Class III standpipe systems shall have 2½” (64 mm) hose connections located as required for Class I standpipes. At each hose connection there shall be a hose station. The hose stations shall be equipped with a minimum of 125 feet (38.1 m), or a maximum of 150 feet (45.7 m), of 1½” (38 mm) fire hose, connected to an adjustable fog nozzle. The hose shall be attached to the hose connection by a 2½” x 1½” (64 mm x 38 mm) non-swivel reducing coupling. A pressure restricting device shall be installed on the 2½” hose connection when required by Appendix Q of the *New York City Building Code*. The hose shall be mounted on a rack and may be located in a cabinet, in accordance with Section 905.7 of the *New York Building Code*. The hose, pressure restricting device (when required) and reducing coupling shall be installed in such a manner that they can be readily removable by the Fire Department.”

4.6.2.2 Delete.

4.6.3.2 Delete.

4.6.4 Delete “for Class II service”.

4.6.5 Delete and replace with the following: “Label. Each rack or storage facility for 1½-in. (40-mm) hose shall be provided with a label that shall include operating instructions.”

4.7.2. Delete and replace with the following: “Hose connections shall have nominal 2½ inch (64 mm) threads conforming to FDNY standards.”

4.7.3 Add at end the following: “Caps are not required to be listed and shall be brass upon completion of construction and are permitted to be impact-resistant plastic during construction.”

4.7.4 Delete.

Add 4.7.6 to read as follows: “Pressure-reducing valves shall not be installed as hose valves or installed downstream of hose valves.”

4.8 Delete entire section, including all subsections and replace with the following: “Fire Department Connections (FDCs). (See Figure A.6.4.)”

Add 4.8.1 to read as follows: “FDCs shall be listed or approved for a working pressure equal to or greater than the pressure requirement of the system demand.”

Add 4.8.2 to read as follows: “Each FDC shall have at least two 3-inch (76 mm) internally threaded swivel fittings having threads conforming to FDNY standards and be of a minimum size of 5 inches (127 mm) except where supplying a single 4-inch (102 mm) standpipe riser, in which case the minimum size shall be 4 inches (102 mm).”

Add 4.8.2.1 to read as follows: “FDCs shall be provided as follows:”

“(a) One FDC shall be provided for each 300 feet (91.4 m) of exterior building wall or fraction thereof facing upon each street or public space.”

“(b) Where buildings face upon two parallel streets or public spaces without an intersecting street or public space, one FDC shall be provided for each 300 feet (91.4 m) of exterior building wall or fraction thereof facing upon each such parallel street or public space.”

“(c) Where a building faces upon two intersecting streets or public spaces and the total length of the exterior building walls facing upon such streets or public spaces does not exceed 300 feet (91.4 m) only one FDC need be installed provided the FDC is located within 15 feet (4.6 m) of the corner and on the street with the longest building frontage.”

“(d) Where a building faces on three streets or public spaces, one FDC shall be provided for each 300 feet (91.4 m) of building wall or fraction thereof facing upon such streets or public spaces provided that at least one FDC is installed on each of the parallel streets or public spaces, and further provided that the FDCs shall be located so that the distance between them does not exceed 300 feet (91.4 m).”

“(e) Where a building faces upon four streets or public spaces, at least one FDC shall be provided on each street front or public space; however, only one FDC need be provided at the corner of two intersecting streets or public spaces if the FDC is located within 15 feet (4.6 m) of the corner and on the street with the longest building frontage or public space, and if the distances between FDCs, in all cases, do not exceed 300 feet (91.4 m).”

“(f) In any case where the exterior building walls of a building facing a street or public space are obstructed in part by another building, one FDC shall be provided for each clear three hundred feet of exterior building wall or fraction thereof facing upon such street or public space.”

“(g) High-rise buildings shall have at least two remotely located fire department connections. In high-rise buildings with multiple FDC zones, each FDC zone shall have two remotely located fire department connections.”

“(h) Location.”

“(1) FDCs shall be placed between 18 inches (457 mm) and 36 inches (914 mm) above the sidewalk level.”

“(2) FDCs shall be of the flush, free standing or exposed type, and with the exception of the swivels, caps, and plugs, shall not project beyond the street property line. The riser pipe to a free standing FDC shall be red brass. When FDCs are installed in wall recesses, the recesses shall be of ample size to permit convenient hose attachment.”

“(i) Check valves. Each FDC shall be provided with a swing-type check valve inside of the building or in a valve pit outside of the building.”

“(j) FDC Express Riser Check Valves. In addition to the check valve required in (h), each FDC express riser supplying an upper FDC zone shall be provided with a swing-type check valve located at the connection between the express riser and the high zone standpipe system and located at the level of such connection.”

“(k) Drip valves. A ¾ inch (19 mm) automatic ball drip valve shall be placed between the FDC and the check valve, except that on a fireboat FDC, a ½ inch (13 mm) open drip without a shutoff may be used. Automatic ball drips shall be placed in the horizontal position.”

“(l) Fire Department Connection Zones. FDCs shall be arranged in maximum FDC zone heights of 600 feet (15 240 mm), supplying no more than two standpipe system zones. A normally closed valved interconnect shall be provided at the highest point between each FDC zone interconnecting the zones. FDC express riser piping shall not be installed in stairway enclosures but may be installed in any other protected shaft.”

“(m) Sectional Valves. Sectional valves shall be provided in all standpipe risers at 100 foot (30 480 mm) vertical intervals. This does not apply to FDC express risers.”

Add 4.8.3 to read as follows: “FDCs shall be equipped with approved plugs or caps, properly secured, and arranged for easy removal by fire departments. Caps shall be painted red, except that the caps for combination standpipe and sprinkler systems shall be painted yellow, and caps for sprinkler systems only shall be painted green.”

Add 4.8.4 to read as follows: “FDCs shall be of an approved type.”

4.10 Add at end the following: “All interior signage shall have a red background with minimum 1-inch high white letters. All exterior signage shall have a white background with minimum 1 inch (25 mm) high red letters.”

Chapter 5 System Requirements

5.1.3 Add at end the following: “and Section 905 of the *New York City Building Code*.”

5.3.2.1 Delete and replace with the following: “Class II systems are not allowed.”

5.3.2.2 Delete.

5.3.3 Delete and replace with the following: “Class III Systems. Class III standpipe systems shall have 2½” (64 mm) hose connections located as required for Class I standpipes in Section 905.4 of the *New York City Building Code*. At each hose connection there shall be a hose station. The hose stations shall be equipped with a minimum of 125 feet (38.1 m), or a maximum of 150 feet (45.7 m), of 1½” (38 mm) fire hose, connected to an adjustable fog nozzle. The hose shall be attached to the hose connection by a 2½” x 1½” (64 mm x 38 mm) non-swivel reducing coupling. A pressure restricting device shall be installed on the 2½” hose connection when required by Appendix Q of the *New York City Building Code*. The hose shall be mounted on a rack, and may be located in a cabinet, in accordance with Section 905.7 of the *New York City Building Code*. The hose, pressure restricting device (when required) and reducing coupling shall be installed in such a manner that they can be readily removable by the Fire Department.”

5.3.3.1 Delete.

5.3.3.2 Delete.

5.3.3.2.1 Delete.

5.4.1.1 Delete the words “automatic dry,” and delete the words “semiautomatic dry, manual dry,” and add at end the following: “unless otherwise permitted in the code.”

5.4.1.2 Delete the words “automatic or semiautomatic” and replace with “automatic wet”.

5.4.2.1 Delete.

5.5.2.1 Add at end the following: “, except for pressure-restricting devices supplying hose outlets.”

5.5.2.2 Add at end the following: “, except for pressure-restricting devices supplying hose outlets.”

Chapter 6 Installation Requirements

6.1.2.1 Add at end the following: “and in accordance with the requirements of Section 905 of the *New York City Building Code*.”

6.1.2.2 Delete the words “in accordance with Table 6.1.2.2” and replace with “in accordance with the requirements of Section 905 of the *New York City Building Code*.”

6.1.2.2.4 Add the following at the end: “in accordance with the *New York City Building Code*.”

Table 6.1.2.2 Delete.

6.1.2.3.1 Add at end the following: “All parts of the standpipe systems that may be exposed to frost shall be protected from freezing by any one of the following methods:”

- “(1) The piping shall be frost proofed with insulation having a thermal conductance of 0.1 Btu/hr. per square foot of surface per degree F at a mean temperature of 70 to 75 degrees F (21°C to 24°C). Insulation shall be protected to prevent water infiltration, and when exposed to the**

weather the insulation shall be covered with a 45-pound (20 kg) roofing felt jacket or equivalent.”

“(2) Steam or listed heat tracing may be used in conjunction with the insulation.”

“(3) Tanks subject to freezing temperatures shall be protected.”

6.2 Delete the words “NFPA 24” and replace with “*the New York City Building Code*”.

6.3.1.1 Add at end the following: “Check valves other than those in Fire Department and fire pump line shall be provided with an O.S.&Y. or indicating shutoff valve (with indicator readily visible from the floor) that is flanged, mechanically coupled or wafer type and connected to the inlet and outlet of such check valves. The valves on the suction and discharge of the fire pump, in accordance with NFPA 20, shall be deemed to comply with this requirement when the discharge valve is placed on the discharge side of the check valve. One of the shutoff valves placed on each side of the tank check valve may be of the remote-control type, and when used, shall be on the downstream side of such check valve.”

6.3.2 Add at end the following:

“(1) Riser control valves. Riser control valves shall, where practical, be located within a required stair enclosure serving the entrance floor. Where the stair enclosure extends to the basement or cellar, the riser control valve may be located within the stair enclosure at or in the basement or cellar ceiling, providing that a sign indicating the valve location is installed within the stair enclosure at the entrance floor. The hose outlet valve for the entrance floor shall be located on the riser side of the riser control valve. Riser control valves shall not be required on a standpipe that supplies only one or two hose outlet valves.”

“(2) Sectional valves. Sectional valves shall be provided in all standpipe risers at 100 foot (30.5 m) vertical intervals. This does not apply to FDC express risers.”

“(3) Operation. Each valve shall be so designed and installed as to permit its manual operation at the valve location. Pressure ratings and the name of the manufacturer shall be cast raised or depressed on each valve used in the system.”

“(4) Remotely Controlled Valves. Where riser control or section valves are located outside of a required stair enclosure, the valves shall be of such type and so installed so as to be remotely operated by either electric motors or hydraulic means. The remote control shall be from either the entrance floor or from a fire pump room. Operating devices shall be grouped, suitably housed, and kept locked with a Fire Department lock and key. The door of the housing shall be embossed to indicate the purpose of the device. Instructions for operating the remote valves by the control device shall be legible, detailed, and complete, and shall be permanently secured to the inner face of the door. The position of each remotely controlled valve, whether opened or closed, shall be indicated at its remote-control point and also at the valve.”

“(5) Access. Valves shall be readily accessible for inspection, repair, and use. If the valve is placed so that its operating mechanism is more than 7 feet (2.1 m) above a floor or stair landing, a 12 inch (305 mm) wide wrought iron, steel or equivalent ladder securely fastened shall be provided for access to the valve. In lieu of a ladder, chain operated mechanisms are permissible and shall be padlocked securely in place.”

“(6) Marking. Each control valve shall be conspicuously marked with the number assigned to it on the riser diagram for the standpipe system. Metal numbered tags at least 2 inches (51 mm) in diameter shall be securely attached to the valve. Each valve shall have a metal sign stating “STANDPIPE CONTROL VALVE” securely hung from the valve.”

“(7) Supervision. Each control valve not remotely controlled shall be electrically supervised in its normal position. If the normal position is the closed position, a metal placard stating such fact shall be conspicuously attached to the valve.”

6.3.4 Add at end the following: “Wafer type control valves may not be used in pump suction piping.”

6.3.7.1 Replace the words “isolation control valves” with “sectional valves”.

6.3.7.1(3) Add at end the following: “only permissible when no fire alarm system is present.”

6.3.7.1(4) Delete.

Add **6.4.2.3** to read as follows: “In addition, each high zone FDC zone shall be provided with a swing-type check valve located at each connection between the high zone FDC express riser and the high zone standpipe system and located at the level of such connection.”

6.4.5.2 Delete and replace with the following: “Marking. Each fire department connection shall be marked as follows:”

“(1) Each FDC shall be provided with caps painted red, and shall have the word “STANDPIPE” in letters 1 inch (25 mm) high and 1/8 inch (3.2 mm) deep cast in the body or on a nonferrous metal plate secured to the connection or mounted on the wall in a visible location.”

“(2) Caps of each FDC used for combination standpipe and sprinkler systems shall be painted yellow and the words shall read “COMBINATION STANDPIPE AND SPRINKLER SYSTEMS”.”

“(3) Where FDCs serve other than the entire building, the connections shall be marked in accordance with the specifications of this section “LOW ZONE” or “HIGH ZONE” and indicate the floors served. If there are more than two FDC zones, they the marking shall be approved by the Fire Department.”

“(4) For manual systems, the sign shall also indicate that the system is manual and that it is either wet or dry.”

6.4.5.2.1 Delete.

6.4.5.2.2 Delete.

6.4.6 Delete “48 in. (1219 mm)” and replace with “36 in. (914 mm).”

Chapter 7 Design

7.1.1 After the word “used,” insert the following: “in accordance with 7.9.3.1.”

7.2.1 Add at the end the following: “Maximum height of each standpipe system zone is limited to 300 feet (91.4 m).”

7.2.2 Delete and replace with the following: “FDC express riser piping shall be permitted to be designed with pressures in excess of 350 psi (24 bar) in accordance with their materials listings or as approved.”

7.2.2.1 Delete.

7.2.3.1 Delete and replace with the following: “Where the residual pressure at the 1½” outlet of a Class III hose station exceeds 100 psi (6.9 bar), an approved pressure restricting device shall be provided to limit the residual pressure at the flow required by Section 7.10 to 100 psi (6.9 bar). This pressure-restricting device shall be installed on the 2½” hose connection outlet between the connection and the hose.”

7.2.3.1.1 Delete and replace with the following: “7.2.3.1 shall not apply to Class I outlets without hose installed.”

7.2.3.2 Delete and replace with: “Reserved.”

7.2.3.3 Delete the words “pressure-regulating device” and replace with “pressure-restricting device”.

7.2.4 Delete and replace with the following: “Hose connections shall not be located downstream of pressure-reducing valves, except when allowed by Section 7.9.3.1 or when approved by the commissioner.”

7.3.2 Delete and replace with the following: “**Class I Systems.** Where required to be provided, hose connections shall be located in accordance with the requirements of Section 905 of the *New York City Building Code*. Class I standpipe hose connections shall be provided in all of the following locations:”

“(1) In every required stairway, a hose connection shall be provided for each floor level. Hose connections shall be readily accessible and located at the riser on each floor-level landing and on the entrance floor above the standpipe riser control valve. Nonrequired enclosed stairways that do not serve as a means of egress are not required to have hose connections. Stairways without hose connections shall have a sign on the door to the stairway stating, “No standpipe connections in stairway.”

“(2) On each side of the wall adjacent to the exit opening of a horizontal exit.”

“**Exception:** Where floor areas adjacent to a horizontal exit are reachable from exit stairway hose connections by a 30-foot (9144 mm) hose stream from a nozzle attached to 100 feet (30 480 mm) of hose, a hose connection shall not be required at the horizontal exit.”

“(3) In every exit passageway at the entrance from the exit passageway to the other areas of a building.”

“**Exception:** Where floor areas adjacent to an exit passageway are reachable from exit stairway hose connections by a 30-foot (9144 mm) hose stream from a nozzle attached to 100 feet (30 480 mm) of hose, a hose connection shall not be required at the entrance from the exit passageway to other areas of the building.”

“(4) In covered mall buildings, in accordance with Section 905.3.3.2.”

“(5) Where the roof has a slope of less than four units vertical in 12 units horizontal (33.3-percent slope), each standpipe shall be provided with a hose connection located either on the roof or at the highest landing of stairways with stair access to the roof. An additional hose connection shall be provided at the top of the most hydraulically remote standpipe for testing purposes. This additional hose connection shall be not be required when a roof manifold is installed in accordance with 7.3.2.1.”

“(6) Where the most remote portion of a floor or story is more than 150 feet (45 720 mm) from a hose connection, additional hose connections shall be provided in approved locations. For the purposes of this section, a penthouse with an occupant load greater than 10 shall be considered a story.”

“(7) In any staircase where the change in elevation between floor landings is more than 25 feet (7.6 m), in addition to the hose connections required by paragraph 1, a hose connection shall be installed at the first intermediate stair landing below the higher floor level.”

7.3.2.1 Delete and replace with the following: “Roof Manifold. At the top of the highest riser there shall be provided, above the main roof level, a three-way manifold equipped with three 2½ inch (63.5 mm) hose valves with hose valve caps. The lowest valve shall be located with the hose end at least 18 inches (457 mm) above the roof and the highest valve with the hose end not more than 60 inches (1524 mm) above the roof. The manifold may be set in a horizontal or vertical position, provided the hose outlets are set back between 18 inches (457 mm) and 60 inches (1524 mm) above the roof level. Where the manifold is located other than within a heated stair enclosure, the control valve shall be located in a horizontal run of piping below the roof, with a long stem extending through the roof and equipped with a wheel handle at its upper end at least 12 inches (304.8 mm) above the roof. Between the control valve and the manifold there shall be provided within the heated space a ½ inch (12.7 mm) open drip or a ¾ inch (19 mm) automatic ball drip, with the drip pipe extended to spill over a plumbing fixture or drain.”

7.3.2.1.1 Delete.

7.3.2.2 through 7.3.2.12 Delete.

7.3.3.1 Delete and replace with the following: “Class II systems are not permitted.”

7.3.3.2 Delete.

7.3.4 Delete and replace with the following: “Class III Systems. Class III systems shall be provided with hose connections as required for Class I systems.”

7.3.4.1 Delete and replace with the following: “Where a building is protected throughout by an approved automatic sprinkler system in accordance with NFPA 13 or NFPA 13R, hose stations shall not be required provided that the requirements of Section 905.3 of the *New York City Building Code* are complied with.”

7.3.4.1.1 Delete.

7.3.4.1.2 Delete.

7.4 Replace the words “Separate standpipes” with “Separate standpipe risers”.

7.5.1 Delete and replace with the following: “Where two or more standpipes are installed in the same building or section of building, they shall be interconnected as follows:”

“(1) Standpipe systems that include more than one riser shall have all risers cross-connected at, or below, the lowest level of fire department access, except as otherwise provided in this section.

“(2) Standpipe systems that have one or more standpipe system zone shall be so designed and installed that the risers supplied from each zone will be cross-connected below, or in, the story of the lowest hose outlets from the water source in each zone. Horizontal intermediate check valves shall be installed in the run of each riser continuing into a higher zone in such manner as to permit all upper zones of the system within each FDC zone provided in accordance with 4.8.2.1 to be fed through one riser from the zone below and to prevent any lower zone of the system from being supplied from a zone above, except as otherwise required by this referenced standard. FDC zones shall be interconnected in accordance with 4.8.2.1(1).”

“(3) Risers supplied by an upper level cross connection shall be provided with manual control valves or remote-control valves, so arranged that risers supplied by the upper level cross connections may independently be shut off from the tank supplies.”

“(4) Cross connections shall be at least as large as the largest riser supplied by the cross connection. However, when supplying two, but not more than four 4-inch (102 mm) risers, the cross connection shall not be less than 5 inches (123 mm). The cross connection shall not be less than 6 inches (152 mm) for all other riser combinations.”

“(5) Where there is no cellar, cross connections may be hung from the ceiling of the lowest story.”

“(6) Each FDC shall be connected to a riser or to a cross connection connecting other Fire Department hose connections or risers within each Fire Department zone provided in accordance with 4.8.2.1. The pipe from the FDC to the riser or cross connection shall be five-inch (123 mm) I.P.S., except that a 4-inch (102 mm) pipe shall be sufficient when such

pipe supplies a single 4-inch (102 mm) riser system. The pipe from the FDC shall be run as directly as practicable to the riser or cross connection.”

“(7) When tanks are used for the primary water supply, the standpipe systems may use separate riser systems serving, respectively, low and high parts of the building. Separate gravity tanks or pressure tanks may supply each zone, but in every case the standpipe system shall be so designed that every hose outlet of the entire system can be supplied through the required cross connections from every FDC within each FDC zone provided in accordance with 4.8.2.1.”

7.5.3 Delete.

7.6.1 Delete and replace with the following: “Class I and Class III standpipes in buildings with floor heights less than 150 feet (45.7 m) above grade plane shall be at least 4 inches (100 mm) in size. All standpipes in buildings with floor heights greater than 150 (45.7 m) feet above grade plane shall be no less than 6 inches (150 mm) in diameter.”

7.6.2.1 Delete and replace with the following: “In fully sprinklered buildings having a combined standpipe system that is hydraulically calculated, the minimum standpipe size in buildings with floor heights less than 150 feet (45.7 m) above the lowest level of Fire Department vehicle access shall be at least 4 inches (102 mm).”

7.7.2* Delete and replace with the following: “Where an automatic water supply is required for a Class I or Class III standpipe system by 5.4, the standpipe system shall be designed so that the system demand can be independently supplied by the attached water supply and each fire department connection provided on the system.”

7.7.4 Delete.

7.8.1 Replace the words “100 psi (6.9 bar)” with “65 psi (4.5 bar)”.

7.9.1 Delete and replace with the following: “Maximum Standpipe System Zone Height. The maximum standpipe system zone height for any building shall be 300 feet (91.4 m). Floors below grade plane shall be included in the lowest standpipe system zone, provided that the maximum FDC zone height for the FDC zone that includes the lowest zone is not exceeded and the maximum hose connection outlet working pressure in the FDC zone does not exceed 205 pounds per square inch. FDC zones shall be arranged in accordance with 4.8. Each standpipe system zone requiring pumps or tanks, shall be provided with a separate pump or tank.”

7.9.1.1 Delete.

7.9.1.2 Delete.

7.9.2 Delete and replace with the following: “**Building Height 300 Feet or Less.** In buildings with occupied floors less than 300 feet (91.4 m) in height above the lowest level of Fire Department vehicle access, water supplies shall be provided by a public waterworks system in accordance with 9.1.4(1), by automatic fire pumps in accordance with 9.1.4(2), or by gravity tanks in accordance with 9.1.4(4).”

7.9.2.1 Delete.

7.9.3 Delete and replace with the following: “Building Height More Than 300 Feet (91.4 m). All standpipe system zones servicing occupied floors located higher than 300 feet (91.4 m) above the lowest level of Fire Department vehicle access shall be equipped with a water supply provided by gravity tanks supplemented by pumps where necessary in accordance with 9.1.4.”

Add 7.9.3.1 to read as follows: “Building Heights More Than 300 Feet (91.4 m) but No More Than 500 Feet (152.4 m). All standpipe system zones servicing occupied floors located higher than 300 feet (91.4 m) above the lowest level of Fire Department vehicle access but not higher than 500 feet (152.4 m) above grade plane, shall be supplied by a gravity tank equipped with a special service fire pump, in accordance with 9.1.4(4)(1), to boost supply to pressures as required by 7.8. This tank shall also be used to supplement the water supply in the lower standpipe system zone in the building. A pressure-reducing valve bypass shall be provided, where necessary, and arranged to provide water supply from the upper zone to the lower zone at the required pressures. Where a pressure-reducing valve is not necessary to provide required pressures, a normally open bypass shall be provided. Where a pressure-reducing valve is necessary, an additional pressure-reducing valve shall be provided, in parallel, with isolation valves located on the inlet and outlet of each pressure-reducing valve.”

Add 7.9.3.2 to read as follows: “Building Heights More Than 500 Feet (152.4 m). Where portions of a standpipe system service floors located higher than 500 feet (152.4 m) above the lowest level of Fire Department vehicle access, each of the building’s standpipe system zones shall be provided with dual water supplies consisting of a gravity supply down-feeding from above the highest outlet in the zone and an automatic fire pump up-feeding from below the lowest outlet in the zone. The gravity tanks and automatic fire pumps shall be in accordance with 9.1.4 and the following:”

- “(1) Gravity tanks shall serve as the gravity supply for one standpipe system zone only. The gravity tank supply for one standpipe system zone may be used as the automatic fire pump suction supply for no more than one other standpipe system zone.”
- “(2) Gravity tanks shall be located so as to provide the water supply for its standpipe system zone at the required pressures by gravity only. The pressure from this supply may exceed the minimum pressures required by 7.8.1 at the top hose connection in the zone by up to 15 percent.”
- “(3) The gravity supply for the topmost standpipe system zone of the building shall be provided by a gravity tank in accordance with 9.1.4(4) and shall be equipped with a special service fire pump, in accordance with 9.1.4(4)(1), to boost supply to pressures as required by 7.8.”
- “(4) The topmost standpipe system zone shall have a minimum height of 150 feet (45.7 m) so as to provide a water supply to the next lower standpipe system zone at the pressures required by 7.8 by gravity only. Pressures provided by this supply may exceed the minimum pressures required by 7.8.1 at the topmost hose connection in the next lower zone by up to 15 percent.”
- “(5) Gravity tanks may serve as the suction source for the automatic fire pumps serving the next higher standpipe system zone located above the standpipe system zone served by the gravity tank.”

7.10.1.3.1.1 Delete the words “(including any hose stream demand)”.

7.11.1 Delete.

7.11.2.4 Delete.

7.11.2.5(3) Delete.

7.12.1 Delete and replace with the following: “Fire department connections shall be installed in accordance with 4.8.”

7.12.1.1. Delete.

7.12.2 Delete.

7.12.2.1 Delete.

7.12.3 Delete entire section, including all subsections.

Chapter 8 Plans and Calculations. No changes.

Chapter 9 Water Supply

9.1.1 Delete the words “and semiautomatic.”

9.1.2 Add at the end the following: “Where manual combination standpipe systems are provided in accordance with the provisions of 5.4.1.1 of this referenced standard, an automatic water supply sufficient to provide the required sprinkler system demand shall be provided. Where such supply is provided by an automatic fire pump, the minimum pump capacity shall be as required by the sprinkler system demand in accordance with Section 903 of the *New York City Building Code* and NFPA 13. Where such water supply is provided by pressure or gravity tanks, the minimum water supply shall also be as required in accordance with the above.”

9.1.3 Delete the words “and semiautomatic.”

9.1.4 Delete and replace with the following: “Water supplies from the following sources shall be permitted:”

“(1) Public Water Connection. A public waterworks system where pressure and flow rate are adequate as confirmed by a statement by the Bureau of Water Supply of the Department of Environmental Protection.”

“(a) Each service directly supplying a standpipe system, or a fire pump shall be equipped with a control valve located under the sidewalk in a flush sidewalk box located within two feet (610 mm) of the street line, or in such other locations as may be approved by the Department of Environmental Protection. The purpose of each such control valve shall be clearly indicated by the words, “Standpipe Supply Control” cast in the cover of such flush sidewalk box or, in lieu thereof, a metal sign with 1-inch lettering shall be located on the exterior building wall indicating the use and location of the valve.”

“(2) Automatic Fire Pumps. Automatic fire pumps connected to an approved water source in accordance with NFPA 20 and the following:”

“(a) Water Supply. Any required automatic fire pump shall draw from two independent street water mains in different streets, except that:”

“(1) any automatic fire pump serving a building classified in occupancy group R-2 that is fully protected by a system of automatic sprinklers may draw from a single water main; and”

“(2) an automatic fire pump may draw from a single water main if augmented by a suction tank or tanks, and if the valves at the meter and pump are provided with tamper switches that are wired to an approved supervising station of an operating fire alarm company. Where two services are installed, one service from the street water main shall be run directly to the pump, and the other service may be used for domestic water supply. The connection from water to the mains to the pumps shall be at least 6-inch (152 mm) pipe size and shall be flushed before connection is made to the system. Connections shall be in accordance with the provisions of the *New York City Plumbing Code* and applicable referenced standards.”

“(b) In the event that two separate and distinct water mains are not available as a supply or the street mains cannot produce the required supply, there shall be provided a suction tank, or tanks suitably located and of sufficient capacity to furnish the fire pump with at least a one-half hour supply at the rated capacity of such pump. Suction tanks shall be filled by a 6-inch (152 mm) connection to the water main, controlled by an automatic ball float valve in the suction tank. A 6-inch (152 mm) bypass shall be provided so that pumps may be fed directly from the street water main.”

“(c) When a water service supplies both the domestic service and the fire pump, a remote-control valve shall be placed on the domestic service connection at the point where such connection is taken from the city supply or service main. Such remote-control valve shall be controlled from a point near the pump control panel. In lieu of a remote-control valve, a manually operated valve may be installed to shut off the entire domestic water supply to the building, provided such valve is located in the fire pump room and is properly tagged for identification.”

“(d) Building Groups. Where a group of two or more buildings, whether connected or separated, are operated under a single ownership, one fire pump may be accepted as the water supply for the group. The pump shall be installed in the building where the maintenance personnel are located, and a metal sign with 1-inch (25 mm) lettering shall be installed in each building at all of the hose outlets on the entrance floor indicating the location of the fire pump.”

“(3) Pressure Tanks. Pressure tanks installed in accordance with NFPA 22 and the following:”

“(a) Tank Size. The tank volume shall be the water storage quantity required and an additional air space volume equivalent to one-half of the required water storage space.”

“(b) Air-To-Water Ratio. Air-to-water ratio shall be 1 to 2 by volume and may be maintained by automatic electrical controls.”

“(c) Air Pressure. An air compressor is provided with suitable automatic control and of sufficient capacity to build up air pressure of at least 75 psig (517 kPa) in the tank within three hours and to maintain thereafter an air pressure between 70 and 80 psig (482 to 552 kPa) The automatic control shall also maintain the proper air-to-water ratio in the pressure tank.”

“(d) Water Supply. Pressure tanks shall be supplied with water through a fixed pipe, independent of the standpipe riser and at least two inches (51 mm) in size. The water supply and connection shall be capable of supplying the tank at a rate of at least 75 gpm (5 L/s) without reducing the pressure in the tank. The tank shall have a fixed water level plate on the end opposite the gauge glass, or other equivalent indicating device.”

“(e) Level Supervision. All pressure tanks used to provide the required primary water supply of a standpipe system shall be equipped with a high and low air pressure and a high and low water level electrical alarm system.”

“(4) Gravity Tanks. Gravity tanks installed in accordance with NFPA 22 and the following:”

“(a) Construction and support of tanks. Tanks for the standpipe system supply shall be constructed and supported in accordance with the provisions of NFPA 22 and applicable provisions of the *New York City Building Code* for loads and structural work. Tanks with a total capacity of 15,000 gallons (56 775 L) or greater shall be multi-compartment type such that no compartment is larger than one half of the required standpipe water supply reserve plus the domestic water reserve in combination tanks. In the alternative, multiple tanks may be provided, provided that the above criteria are met.”

“(b) Combination tanks. Gravity tanks may be used to provide the required primary water supply to the standpipe system and may also be used to supply automatic sprinkler and/or domestic water in a building provided all the following conditions are met:”

“(1) The connections to the tank are made in such a manner as to provide the required sprinkler and/or fire standpipe reserve. The domestic supply is above the sprinkler and/or standpipe reserve. Where a standpipe riser is used to supply water to a combination sprinkler and standpipe system as permitted, the connection to the tank shall be made in such a manner as to provide the required sprinkler or standpipe reserve, whichever is greater.”

“(2) The connections to the system are made outside of the tank. When connections or piping are installed inside the tank, the piping shall be assembled without couplings and shall be of red brass or approved equivalent material in accordance with the *New York City Plumbing Code* and applicable referenced standards.”

“(3) The tank is filled by means of an automatic pump at a rate of not less than 65 gpm (4 L/s).”

“(c) Filling of tanks.”

“(1) Gravity tanks shall be filled at the rate of at least 65 gpm (4 L/s). Pipes used to fill the tanks shall not be used for any other purpose; nor shall required fire pumps be used for filling purposes.”

“(2) Where there is sufficient pressure in the city water main to fill tanks at the required rate during all hours of each day, and a filling pump is not provided, the connection to the city water supply shall be made near the point where the city water service enters the building.”

“(3) A combined fire standpipe reserve and domestic water tank shall only be filled by direct public water connection or separate fill pumps, or direct connection to equipment, or pumps used to supply domestic water systems in accordance with the *New York City Plumbing Code* and applicable referenced standards.”

“(d) Emergency drains on tanks. Each tank shall be provided with a drain of at least 4 inches (102 mm). National Pipe Thread. Each drain pipe shall be controlled by a manually operated gate valve located so as to be readily accessible. The drain shall be installed in accordance with the *New York City Plumbing Code* and applicable referenced standards.”

“(e) Heating of tanks.”

“(1) Where the water in the tank is subject to freezing, the tank shall be equipped with a tank heater in accordance with the provisions of NFPA 22.”

“(2) Where the standpipe supply and domestic water supply are combined in a single tank, heating of such tank shall not be required in hotels, multiple dwellings, hospitals, or other occupancies where the domestic supply is drawn upon during all hours of every day of the week.”

“(f) Strainer.”

“(1) Every standpipe gravity or suction tank shall be provided with a brass or bronze strainer at the discharge to risers or to pump supply lines.”

“(2) Each strainer shall have clear openings with an aggregate area equal to, or more than, the required area of the pipe into which the tank discharges. Openings shall be not more than 1 in. (25 mm) nor less than ½ in. (13 mm) in diameter.”

“(g) Overflow pipe for tanks. Each gravity tank shall be provided with an overflow in accordance with the *New York City Plumbing Code* and applicable referenced standards.”

“(h) Access to tanks. Access to the top of each gravity tank shall be by means of a steel, wrought iron or approved equivalent material gooseneck ladder, constructed of flat side bars at least 2 in. by 3/8 in (51 mm by 10 mm), or equivalent, spaced at least 14 in. (356 mm) apart, with round or square rungs at least 5/8 in. (16 mm) thick spaced not more than 12 in. (305 mm) on centers. The ladder shall be rigidly braced and shall not tip outward from the vertical at any point. When ladders exceed 25 ft. (6.1 m) in height, body irons spaced not more than 2 ft. (610 mm) on center and a metal platform at least 14 in. (356 mm) square, rigidly secured to the stringers of the ladder or other type of enclosed safe access, shall be provided near the top of the tank.”

“(i) Level Supervision. Gravity tanks shall be equipped with a high and low water level electrical alarm system.”

“(j) Where a group of two or more buildings, connected or separated, is operated under a single control, a single gravity tank may be accepted as the primary water supply for the several standpipe systems of such group, provided a dead riser is carried from the bottom of the tank to an underground header or cross connection system and provided each building unit has a post indicator type control valve outside or an O.S.&Y. control valve inside the building at a readily accessible location. The underground cross-connection may not cross any public street without the approval of the city departments having jurisdiction.”

“(k) The bottom of the topmost zone gravity tanks shall be located above the highest hose outlet in the zone that such tank supplies, excepting the roof manifold and those hose outlets in a penthouse enclosing mechanical equipment. Pressures may be boosted by use of automatic special service or other fire pump(s) to provide the hose outlet pressures required by 7.8 of this referenced standard. Tanks in intermediate zones may be sufficiently elevated to provide the pressures required by 7.8 provided that they are also installed in accordance with 7.9.”

“(l) The special service pump, as required by this standard, may be located anywhere in the zone served, provided that an express piped suction supply is installed from the gravity tank(s) that supply such pump, and such pump is located at a lower elevation than the gravity tank. Special service pumps are to be installed in accordance with the requirements of 9.1.4(2) - (d), (e), (f) and (h).”

9.1.4.1 Delete.

9.1.5 Delete.

9.2 Delete the words “Class II”.

9.3 Delete and replace with the following: “Minimum Supply for Group R-2 Occupancies. The water supply servicing standpipe systems in Group R-2 occupancies shall be 500 gpm (32 L/s) per zone. If provided with a stored water supply, any gravity tank or intermediate tank shall be a minimum of 15,000 gallons. Water supplies shall comply with the requirements of 7.9.”

Chapter 10 Water Supply Testing No Changes.

Chapter 11 System Acceptance

11.4.1 Delete and replace with: “*General. All new systems, including yard piping and fire department connection piping, shall be tested hydrostatically at not less than 300 psi (20.7 bar) or 50 psi (3.5 bar) in excess of the system working pressure, whichever is greater, for 1 hour.”

Add **11.4.1.1** to read as follows: “Individual FDC zones shall be treated as a separate system in determining the hydrostatic test pressures. Standpipe systems being installed in buildings under construction shall be tested in sections up to 100 feet (31 m) in length provided a final test is conducted of the entirely completed system at 115 psi (7.9 bar) at the most remote hose connection.”

11.4.2 Delete and replace with: “The 115 psi (7.9 bar) hydrostatic test pressure shall be measured at the elevation of the highest hose valve in the section being tested.”

Exception: The 200 psi (13.8 bar) test pressure for the topmost 100 feet (31 m) standpipe section in each FDC zone may be measured at the lowest point of the topmost 100 feet (31 m) section.”

11.5.5.1 Delete and replace with the following: “Pressure regulating devices on sprinkler branch line shall be tested according to NFPA 13.”

11.5.5.1.1 Delete.

11.5.5.2 Delete.

Chapter 12 Buildings Under Construction

12.1 Add at end the following: “During construction, alteration or demolition operations, standpipe systems shall comply with this section and Chapter 33 of the *New York City Building Code*.”

12.2 Delete and replace with the following: “Fire Department Connections. FDCs shall be provided as per 4.8. The location of the FDC(s) shall be placarded, kept free from obstruction, and identified by a red light.”

Add **12.2.1** to read as follows: “Fire Department Connection Zones. FDCs shall be arranged in maximum FDC zone heights of 600 feet (183 m). FDC express risers shall be provided when necessary.”

12.3 Delete and replace with the following: “Other System Features. The pipe sizes, hose valves, hose, water supply, and other details for new construction shall be in accordance with this standard and Chapter 33 of the *New York City Building Code*. Temporary risers shall be at least 4 inches in (102 mm) diameter for structures less than 450 feet high (137 m) and at least 6 inches (152 mm) in diameter for structures 450 feet (137 m) high or more. There shall be as many risers as will be, or were, required for the permanent system. Each such riser shall be connected to a cross connection that is supplied through FDC(s) at the street level and shall be equipped on each floor with a 2½ inch (64 mm) hose outlet valve. The installations shall be made so that each riser, cross connection, and branch line can be plugged or capped when work is not being done on the system.”

12.5.1 Delete and replace with the following: “At least one approved 2½ inch (64 mm) hose connection for attaching Fire Department hose shall be provided at each floor level in the exit

stairways. In any stairway where the length of travel between floor landings is more than 25 feet (7.6 m), a 2½ inch (64 mm) hose connection shall be installed at the first intermediate stair landing below the higher floor level.”

12.5.2 Add at the end the following: “and provided with caps according to 4.7.3.”

12.8 Delete entire section, including all subsections.

Chapter 13 System Testing, Inspection, and Maintenance No changes.

ANNEXES

The annexes are not a part of the requirements of this Referenced Standard but are included for informational purposes only. These annexes contain explanatory material, numbered to correspond with the applicable text paragraphs. In the event of any conflict between the Annexes and the body of the Referenced Standard, particularly where modifications have been made for New York City, the body of the Referenced Standard will govern.

Annex A Explanatory Material No changes.

Annex B Informational References No changes.

SECTION BC Q106 INSTALLATION OF STATIONARY FIRE PUMPS

Q106.1 General. Fire pump systems, where required by this code, shall be installed in accordance with NFPA 20, *Standard for the Installation of Stationary Pumps for Fire Protection*, 2016 edition, modified for New York City as follows. Refer to the rules of the department for any subsequent additions, modifications or deletions that may have been made to this standard in accordance with Section 28-103.19 of the *Administrative Code*.

Chapter 1 Administration No changes.

Chapter 2 Referenced Publications

2.1 Add at end the following: “Where a referenced publication has been modified for the City of New York by the *New York City Building Code* or the rules of the Department of Buildings, every reference to such publication shall be deemed to include all such modifications. Where the edition of a publication referenced within this standard differs from the edition provided for the same standard in Chapter 35 of the *New York City Building Code*, the edition provided for in Chapter 35 of the *New York City Building Code* shall govern.”

Chapter 3 Definitions

3.3.40 Delete and replace with the following: ““On-Site Standby Generator” as per the *New York City Electrical Code*.”

3.3.44.5 Add the following sentence at the end: “This definition is for use with this referenced standard only.”

3.3.44.11 Add the following sentence at the end: “Multistage, Multiport (fire) Pumps are prohibited in the City of New York.”

Chapter 4 General Requirements

4.5.1.2 Delete.

Add 4.6.2.1.1 to read as follows: “Number of sources shall be as required by the *New York City Building Code*.”

Add 4.6.2.1.2 to read as follows: “Water drained and/or supplied from fire pump shall not discharge into a potable water source.”

4.8 Delete.

4.8.1 Delete.

4.8.2 Delete.

4.12.1.3.1 Delete.

4.13.1.1.2 Delete “fire-rated construction in accordance with Table 4.13.1.1.2” and replace with the following: “a minimum of 2-hour fire-rated construction unless otherwise noted in the *New York City Building Code*.”

Table 4.13.1.1.2 Delete.

Add 4.13.1.1.8 to read as follows: “Fire pumps shall be placed on concrete pads at least 12 inches (305 mm) above the pump room floor with a clearance of at least 3 feet (914 mm) maintained on all sides from walls or from other equipment in the pump room. In the event of the use of a vertical shaft centrifugal fire pump, the 12 inches (305 mm) high concrete pad may be omitted, provided the bottom of the electric driving motor and all electrical appurtenances are raised at least 12 inches (305 mm) above the pump room floor.”

Add 4.13.1.1.9 to read as follows: “Each automatic fire pump shall be equipped with a 3 inches (76 mm) National Pipe Thread pressure relief valve installed in the pump discharge. Such relief valve shall be set to relieve below the shutoff head of the pump, but above the pressure required to maintain the operating pressure at the highest hose valve. The discharge from the relief valve may be piped back into the suction side of the pump on the pump side of the suction valve provided a visual sight glass is installed in the discharge of the relief valve.”

4.13.2.1.2 Delete “not less than the fire-resistance rating of the fire pump room.” and replace with the following: “of 2 hours unless otherwise noted in the *New York City Building Code*.”

4.13.5.2 Delete.

4.13.7.2 Add at the end the following “Floor drain shall have a minimum outlet size of 4 inches (102 mm).”

4.14.1.2 Delete “or painted on the inside prior to installation with a paint recommended for submerged surfaces.”

4.14.2.2 Delete.

4.14.6 Add at the end the following “and the *New York City Fire Code.*”

4.15.4.2 Delete.

4.15.6.5 Delete.

4.16.2 Delete.

4.16.5 Delete.

4.16.7 Delete and replace with the following: “A listed swing- or spring loaded-type check valve shall be installed in the pump discharge assembly.”

4.16.10 Delete.

4.17.1 Delete “by one of the following methods” and replace with the following: “in accordance with the requirements of Sections 903, 905 and 907 of the *New York City Building Code.* Delete Items (1) through (4).”

Add 4.19.8.1 to read as follows: “The drainage shall not discharge into a potable water supply.”

4.20.2.10 Delete.

4.30.2 Delete “applicable NFPA 70 articles” and replace with “*New York City Electrical Code.*”

4.31.1.1 Delete.

4.31.1.1.1 Delete.

Chapter 5 Fire Pumps for High-Rise Buildings

5.3.1 Add at the end following “the *New York City Building Code* and the *New York City Plumbing Code.*”

5.4 Delete the phrase “or a test header discharging back into the tank with a calibrated nozzle(s) arranged for the attachment of a pressure gauge to determine pitot pressure” and add the following after “shall be required.”: “See Section 14.2.1.5 for additional fire pump testing arrangements.”

5.6.1.1 Delete and replace with the following: “Water supplies for buildings over 300 feet (91 m) above the lowest level of Fire Department vehicle access shall comply with Section Q105 of the *New York City Building Code.*”

5.6.1.1.1 Delete.

5.6.1.1.2 Delete.

5.6.1.1.3 Delete.

5.6.1.2 Delete.

5.6.1.3 Delete.

5.6.1.4 Delete.

5.6.1.5 Delete.

5.6.1.5.1 Delete.

5.6.2 Delete.

Chapter 6 Centrifugal Pumps

6.2.1.1 Delete.

6.2.2.1 Delete.

Chapter 7 Vertical Shaft Turbine-Type Pumps No changes.

Chapter 8 Positive Displacement Pumps No changes.

Chapter 9 Electric Drive for Pumps

9.1.3 Delete: “NFPA 70, Article 695, and all other applicable articles” and add the following sentence at the end: “and the requirements of the *New York City Electrical Code*.”

9.2.2*(5) Delete “of Article 695 of NFPA 70” and add the following sentence at the end: “and the requirements of the *New York City Electrical Code*.”

9.2.3 Add the following sentence at the end: “Overcurrent protection shall comply with the requirements of the *New York City Electrical Code*.”

9.2.3.1 Delete all words after and including “all the following requirements:” and replace with the following: “the requirements of the *New York City Electrical Code*.”

9.3.1 Delete and replace with the following: “Where required by the *New York City Building Code*, an alternate power source shall be provided in accordance with the requirements of the *New York City Electrical Code*.”

9.6.1.1 Delete and replace with the following: “As per the *New York City Electrical Code* and Chapter 27 of the *New York City Building Code*.”

9.6.1.2 Delete.

9.6.2.1 Delete and replace with the following: “As per the *New York City Electrical Code* and Chapter 27 of the *New York City Building Code*.”

9.6.2.2 Delete.

9.6.2.3 Delete.

9.6.5.1 Delete and replace with the following: “As per the *New York City Electrical Code* and Chapter 27 of the *New York City Building Code*.”

9.6.5.2 Delete.

9.6.5.3 Delete.

9.7 Delete and replace with the following: “Junction Boxes. Where fire pump wiring to or from a fire pump controller is routed through a junction box, such wiring shall be installed as per the *New York City Electrical Code* and Chapter 27 of the *New York City Building Code*.”

9.8.1 Delete and replace with the following: “As per the *New York City Electrical Code* and Chapter 27 of the *New York City Building Code*.”

9.8.1.1 Delete.

9.8.1.2 Delete.

9.8.2 Delete.

9.8.3 Delete.

9.9 Delete and replace with the following: “As per the *New York City Electrical Code* and Chapter 27 of the *New York City Building Code*.”

9.9.1 Delete.

9.9.2 Delete.

9.9.3 Delete.

9.9.4 Delete.

Chapter 10 Electric-Drive Controllers and Accessories

10.1.2.2.2 Add the following sentence at the end: “A placard shall be placed adjacent to the fire pump controller in accordance with the *New York City Electrical Code*.”

10.5.2.1.1.2 Delete.

10.5.2.1.1.3 Delete.

10.5.2.5 Delete.

10.5.2.7 Delete.

10.5.3 Delete.

10.5.4 Delete and replace with the following: “Shutdown shall be accomplished by the method in 10.5.4.1.”

10.5.4.2 Delete.

10.5.4.2.1 Delete.

10.5.4.2.2 Delete.

Chapter 11 Diesel Engine Drive

11.4.1 Add the following sentence at the end: “Fuel supply shall comply with applicable sections of the *New York City Building Code*, the *New York City Mechanical Code* and the *New York City Fire Code*.”

11.4.3.1 Delete and replace with the following: “Diesel fuel supplies shall be located in accordance with applicable sections of the *New York City Building Code*, the *New York City Mechanical Code* and the *New York City Fire Code*.”

11.5 Add the following sentence at the end: “Exhaust system shall comply with applicable sections of the *New York City Mechanical Code*.”

Chapter 12 Engine Drive Controllers

12.1.1 Delete “nonautomatic”.

12.7.2.1.1.2 Delete.

12.7.2.1.1.3 Delete.

12.7.2.1.1.4 Delete.

12.7.2.3 Delete.

12.7.2.4 Delete.

12.7.2.5 Delete.

12.7.2.7 Delete

12.7.5.2 Delete.

12.7.5.2.1 Delete.

12.7.5.2.2 Delete.

Chapter 13 Steam Turbine Drive No changes.

Chapter 14 Acceptance Testing, Performance, and Maintenance

Add 14.2.1.1 to read as follows: “Testing shall comply with the manufacturer’s requirements.”

Add 14.2.1.2 to read as follows: “Testing shall also comply with the *New York City Fire Code*, where applicable.”

Add 14.2.1.3 to read as follows: “Fire pump shall be equipped with a listed flowmeter.”

Add 14.2.1.4 to read as follows: “Water used in fire pump testing shall not discharge into any source containing potable water.”

Add 14.2.1.5 to read as follows: “Acceptance flow testing shall be performed by one of the following four methods:”

“(1) Use of pump discharge via hose streams”

“(2) Use of pump discharge via bypass flowmeter to drain line or suction reservoir. The flowmeter shall be sized per 4.21.2 and the drain line shall be sized at a minimum as per 4.21.3.4.”

“(3) Use of pump discharge via bypass flowmeter to pump suction (closed-loop metering)”

“(4) Use of pump discharge to a suction reservoir with a calibrated nozzle(s) arranged for attachment of a pressure gauge to determine pitot pressure.”

14.2.4.1.2 Delete.

14.2.6.4 Delete.

14.2.6.4.1 Delete.

ANNEXES

The annexes are not a part of the requirements of this Referenced Standard but are included for informational purposes only. These annexes contain explanatory material, numbered to correspond with the applicable text paragraphs. In the event of any conflict between the Annexes and the body of the Referenced Standard, particularly where modifications have been made for New York City, the body of the Referenced Standard will govern.

Annex A Explanatory Material No changes.

Annex B Possible Causes of Pump Troubles No changes.

Annex C Fire Pump Controller Connectivity No changes.

Annex D Informational Resources Delete.

Annex E Material Extracted by NFPA 70, Article 695 Delete.

SECTION BC Q107
INSTALLATION OF FIRE ALARMS

Q107.1 General. Fire alarm system design, installation, testing, and maintenance, where required by this code, shall be conducted and documented in accordance with NFPA 72, *National Fire Alarm and Signaling Code*, 2016 edition, modified for New York City as follows. Refer to the rules of the department for any subsequent additions, modifications or deletions that may have been made to this standard in accordance with Section 28-103.19 of the *Administrative Code*.

Chapter 1 Administration No changes.

Chapter 2 Referenced Publications

2.1 Add at end the following: “Where a referenced publication has been modified for the City of New York by the *New York City Building Code* or the rules of the Department of Buildings, every reference to such publication shall be deemed to include all such modifications. Where the edition of a publication referenced within this standard differs from the edition provided for the same standard in Chapter 35 of the *New York City Building Code*, the edition provided for in Chapter 35 of the New York City Building Code shall govern.”

Chapter 3 Definitions No changes.

Chapter 4 Reserved

Chapter 5 Reserved

Chapter 6 Reserved

Chapter 7 Documentation No changes.

Chapter 8 Reserved

Chapter 9 Reserved

Chapter 10 Fundamentals

10.5.1.1 Delete and replace with the following: “Fire alarm system and emergency communication system plans and specifications shall be developed in accordance with the *New York City Building Code* by persons licensed and registered to practice the profession of engineering under the Education Law of the State of New York, who are also experienced in the proper design, application, installation, and testing of the system.”

10.5.1.2 Delete.

10.5.2.1 Add at beginning the following: “Fire alarm installations shall be performed by a New York City licensed electrical contractor.”

10.5.3.1 Add at beginning the following: “Fire alarm inspection, testing and maintenance shall be performed by a New York City licensed electrical contractor holding a New York State registration

for ‘Business of Installing, Servicing or Maintaining Security or Fire Alarm Systems’ or those fire alarm companies holding a New York State registration for ‘Business of Installing, Servicing or Maintaining Security or Fire Alarm Systems,’ and in accordance with rules and regulations promulgated by the Fire Commissioner.”

10.6.3.1 Delete and replace with the following: “Refer to the *New York City Electrical Code* for requirements.”

10.6.3.2 Delete and replace with the following: “Refer to the *New York City Electrical Code* for requirements.”

10.6.3.3 Delete and replace with the following: “Refer to the *New York City Electrical Code* for requirements.”

10.6.3.4 Delete and replace with the following: “Refer to the *New York City Electrical Code* for requirements.”

10.6.4.1 Delete and replace with the following: “Refer to the *New York City Electrical Code* for requirements.”

10.6.4.2 Delete and replace with the following: “Refer to the *New York City Electrical Code* for requirements.”

10.6.4.3 Delete and replace with the following: “Refer to the *New York City Electrical Code* for requirements.”

10.6.5.1 Delete and replace with the following: “Refer to the *New York City Electrical Code* for requirements.”

10.6.5.2 Delete and replace with the following: “Refer to the *New York City Electrical Code* for requirements.”

10.6.5.3 Delete and replace with the following: “Refer to the *New York City Electrical Code* for requirements.”

10.6.5.4 Delete and replace with the following: “Refer to the *New York City Electrical Code* for requirements.”

10.6.6.1 Delete and replace with the following: “Refer to the *New York City Electrical Code* for requirements.”

10.6.6.2 Delete and replace with the following: “Refer to the *New York City Electrical Code* for requirements.”

10.6.7.2.1 Delete and replace with the following: “The secondary power supply for fire alarm systems and supervising station facilities shall have sufficient capacity to operate the system in accordance with the *New York City Electrical Code*. The secondary power supply for other systems shall have sufficient capacity to operate the system under quiescent load (system operating in a nonalarm condition) for a minimum of 24 hours and, at the end of that period, shall be capable of

operating all alarm notification appliances used for evacuation or to direct aid to the location of an emergency for 5 minutes, unless otherwise permitted or required by 10.6.7.2.1.1 through 10.6.7.2.2.

10.6.7.2.1.2 Reserved.

10.6.7.2.1.3 Reserved.

10.6.7.2.1.4 Delete and replace with the following: “The secondary power supply for high-power speaker arrays used for wide-area mass notification systems shall be in accordance with 24.6.5.2.”

Add **10.6.7.2.1.8** to read as follows: “The secondary power supply for two-way voice radio communication enhancement system shall be in accordance with 24.9.5.3.1.”

Chapter 11 Reserved

Chapter 12 Circuits and Pathways

Add **12.3.6.1** to read as follows: “Class-N circuits shall not be installed unless approved by the Fire Department.”

Chapter 13 Reserved

Chapter 14 Inspection, Testing, and Maintenance

14.1.1 Delete and replace with the following: “The inspection, testing and maintenance of systems, their initiating devices, and notification appliances shall comply with the requirements of this chapter and the *New York City Fire Code*.”

14.1.2 Delete and replace with the following: “The inspection, testing and maintenance of single- and multiple-station smoke and heat alarms and household fire alarm systems shall comply with the requirements of this chapter and the *New York City Fire Code*.”

14.4.9 Delete and replace with the following: “In-building auxiliary radio communication systems (ARCS) shall be inspected and operationally tested in accordance with the requirements of the *New York City Fire Code* and rules promulgated by the Fire Department.”

14.6.3 Delete and replace with the following: “Supervising Station Records. For supervising station alarm systems, records pertaining to signals received at the supervising station that result from maintenance, inspection, and testing shall be maintained in accordance with the *New York City Fire Code*.”

14.6.3.1 Delete.

14.6.3.2 Delete.

14.6.4 Delete.

Chapter 15 Reserved

Chapter 16 Reserved

Chapter 17 Initiating Devices

Add 17.5.3.2.1 to read as follows: “Partial coverage smoke detection shall be located in common areas and work spaces such as corridors, lobbies, storage rooms, equipment rooms, and other tenantless spaces, where required.”

Add 17.5.3.2.2 to read as follows: “Selective coverage smoke detection shall be located as follows:”

“(1) In each mechanical equipment, electrical, transformer, telephone equipment or similar room, in elevator machine rooms, and in elevator lobbies.”

“(2) In air distribution systems in accordance with Section 606 of the *New York City Mechanical Code*.”

17.10.2.4 Delete and replace with the following: “The selection and placement of the gas detectors shall be based on an engineering evaluation including, but not limited to, the following:

- (1) Structural features, size, and shape of the rooms and bays
- (2) Occupancy and uses of areas
- (3) Ceiling heights
- (4) Ceiling shape, surface, and obstructions
- (5) Ventilation
- (6) Ambient environment
- (7) Gas characteristics of the gases present
- (8) Configuration of the contents in the area to be protected
- (9) Response time(s)”

Chapter 18 Notification Appliances No changes.

Chapter 19 Reserved

Chapter 20 Reserved

Chapter 21 Emergency Control Function Interfaces

21.3.3 Delete and replace with the following: “Unless otherwise required by the authority having jurisdiction, only the elevator lobby, elevator hoistway, and elevator machine room smoke detectors, sprinkler waterflow alarm-initiating devices, or other automatic fire detection as permitted by 21.3.9, and initiating devices used to initiate shutdown of elevator power in accordance with 21.4 shall be used to recall elevators for fire fighters’ service.”

21.3.13 Delete and replace with the following: “Separate outputs from the fire alarm systems to the elevator controller(s) shall be provided to implement elevator Phase I Emergency Recall Operation in accordance with ANSI/ASME A17.1a/CSA B44a, Safety Code for Elevators and Escalators.”

21.3.13.1 Delete and replace with the following: “See ANSI/ASME A17.1a/CSA B44a, Safety Code for Elevators and Escalators, for designated and alternate levels of elevator recall.”

21.3.13.2 Delete and replace with the following: “See ANSI/ASME A17.1a/CSA B44a, Safety Code for Elevators and Escalators, for designated and alternate levels of elevator recall.”

21.3.13.3 Delete and replace with the following: “See ANSI/ASME A17.1a/CSA B44a, Safety Code for Elevators and Escalators, for designated and alternate levels of elevator recall.”

21.4.2 Delete and replace with the following: “If heat detectors are used to shut down elevator power prior to sprinkler operation, they shall be placed within 24 in. (610 mm) of each sprinkler head and be installed in accordance with the requirements of Chapter 17. Upon activation of the heat detector used for elevator power shutdown, there shall be permitted to be a delay in the activation of the power shunt trip. This delay should be the time that it takes the elevator cab to travel from the top of the hoist way to the lowest recall level. Alternatively, engineering methods, such as those specified in Annex B, shall be permitted to be used to select and place heat detectors to ensure response prior to any sprinkler head operation under a variety of the growth rate scenarios.”

21.4.3 Delete and replace with the following: “Pressure or water flow switches shall not be used to shut down elevator power.”

21.6 Delete section, including all subsections, and replace with the following:

“21.6 Occupant Evacuation Elevators.”

“21.6.1 Elevator Status. Any elevator specifically designated and marked for use by occupants for evacuation during fires shall comply with all of the provisions of 21.5 and 21.6.”

“21.6.2 Elevator Occupant Evacuation Operation (OEO). Outputs from the fire alarm system to the elevator controller(s) shall be provided to implement elevator occupant evacuation operation in accordance with section 2.27 of ASME A17.1/CSA B44 as modified by Chapter K1 of Appendix K of the *New York City Building Code*, as required in 21.6.2.1 and 21.6.2.2.”

“21.6.2.1 Partial Evacuation. Where an elevator or group of elevators is designed for use by occupants for evacuation, the provisions of 21.6.2.1.1 through 21.6.2.1.4 shall apply for partial evacuation.”

“21.6.2.1.1 Initiation. Output signal(s) shall be provided to initiate elevator occupant evacuation operation upon automatic or manual detection of a fire on a specific floor or floors as a result of either or both of the following:

- (1) Activation of any automatic fire alarm initiating device in the building, other than an initiating device used for elevator Phase I Emergency Recall Operation in accordance with Chapter K1 of Appendix K of the *New York City Building Code*.

(2)* Activation of manual means at the fire command center by authorized or emergency personnel.”

“21.6.2.1.2* Floor Identification.

(A) The output signal(s) shall identify each floor to be evacuated.

(B) The identified floors shall be a contiguous block of floors including the following:

(1) The floor with the first activated automatic initiating device.

(2) Floors with any subsequently activated automatic initiating device(s).

(3) Floors identified by manual means from the fire command center.

(4) One floor above the highest floor identified by 21.6.2.1.2(B)(1) through 21.6.2.1.2(B)(3).

(5) One floor below the lowest floor identified by 21.6.2.1.2(B)(1) through 21.6.2.1.2(B)(3).

(C) The identified floors shall be displayed on a standard emergency services interface along with the other elevator status information required by 21.6.1.”

“21.6.2.1.3 Manual Floor Selection.

(A) A means shall be provided at the fire command center to allow the manual selection of floors.

(B) The floors shall be selected on the basis of information from authorized or emergency personnel.”

“21.6.2.1.4* Occupant Notification. The in-building fire emergency voice/alarm communications system shall transmit coordinated messages throughout the building.

(A) Live voice evacuation messages shall be transmitted to the floors identified in 21.6.2.1.2 to indicate the need to evacuate and that elevator service is available.

(B) Live voice messages shall be transmitted to the floors not being evacuated to inform occupants of evacuation status and shall include an indication that elevator service is not available.

(C)* Live voice messages shall be transmitted to the floors identified in 21.6.2.1.2 to indicate that elevator service is not available when all elevators have been recalled on Phase I Emergency Recall Operation.

(D) All live voice messages shall be coordinated with the text displays provided separately by the elevator management system.”

“21.6.2.2 Total Evacuation. Where an elevator or group of elevators is designated for use by occupants for evacuation, the provisions of 21.6.2.2.1 through 21.6.2.2.3 shall apply for total evacuation.”

“21.6.2.2.1 Output(s) to signal elevator occupant evacuation operation for total evacuation shall be manually activated from the fire command center by a means labeled “ELEVATOR TOTAL BUILDING EVACUATION.””

“21.6.2.2.2 The output(s) shall identify that all floors are to be evacuated.”

“21.6.2.2.3 A live voice evacuation message shall be transmitted from the in-building fire emergency voice/alarm communication system throughout the entire building to indicate the need to evacuate.”

21.7.3* Delete and replace with the following: “Fan Shutdown and Restart.”

Add **21.7.3.1** to read as follows: “Connections between fire alarm systems and the HVAC systems for the purpose of monitoring and control shall be arranged such that primary control (the control that all other controls are secondary or subservient to) capability rests with the fire alarm control unit(s) under all circumstances and in addition shall operate and be monitored in accordance with the *New York City Building Code*.

Exception: Primary control of HVAC systems may rest with approved smoke control systems.”

Add **21.7.3.2** to read as follows: “HVAC fans or fan systems which have been automatically shut down by the activation of any fire alarm control unit or device shall be arranged and equipped not to automatically restart when the fire alarm control unit or device is reset. At least two manual means of restarting the fans or fan systems shall be required, such as manually resetting the fire alarm control unit or device and subsequently manually resetting the fan or fan system controls.”

Add **21.7.3.3** to read as follows: “Fans or fan systems that were automatically shut down by the fire alarm control unit or device in high rise fire alarm systems shall be manually enabled to start by means of overriding the fan shut down through the use of city-wide standard key (#2642) located at the Fire Command Center and/or Fire Fighters’ Smoke Control Station. The actual start of the fans shall be accomplished manually through HVAC controls at the Fire Command Center, Fire Fighters’ Smoke Control Station and locally at the fan rooms.”

Add **21.7.3.4** to read as follows: “Smoke Exhaust control means shall be enabled through the use of city-wide standard key (#2642) located at the Fire Command Center, Fire Fighters’ Smoke Control Station, fire alarm control unit or, in the entrance lobby of the building adjacent to the fire alarm remote annunciator, when provided.”

21.9.1 Delete and replace with the following: “Where permitted by the *New York City Building Code*, any device or system intended to electrically lock a required means of egress door in the direction of egress shall be connected to the fire alarm system serving the protected premises and shall automatically unlock upon any activation from the fire alarm system.”

21.9.3 Delete and replace with the following: “Where permission is obtained from the commissioner, for all means of egress doors connected in accordance with 21.9.1, and where batteries are used in accordance with 10.6.7 as the secondary power supply, the batteries shall not be utilized to maintain these doors in the locked condition, unless the fire alarm control unit is arranged with circuitry and sufficient secondary power to ensure the exits will unlock within 10 minutes of loss of primary power.”

Chapter 22 Reserved

Chapter 23 Protected Premises Fire Alarm Systems

23.3.2 Delete and replace with the following: “Nonrequired (Voluntary Systems) and Components. The features for a nonrequired system shall be established by the system designer on the basis of the goals and objectives intended by the system owner and subject to the approval of the Fire Department.”

23.8.1.1.2(3) Delete and replace with the following: “(3) Subsequent system operation shall be subject to approval of the Fire Department.”

Add 23.8.1.1.3 to read as follows: “Group A Occupancies. Presignal systems in Group A occupancies required by Section 907.2.1.1 of the *New York City Building Code* shall operate in the “Event/Non-Event Mode,” as follows:

“(1) For the purposes of this section, Event Mode is defined when an assembly space and is occupied by public members with an occupant load in accordance with Section 907.2.1.1 of the *New York City Building Code*. Each assembly space within a structure that meets the occupant load as required in the Section 907.2.1.1 of the *New York City Building Code* shall be equipped with a separate In-Building Fire Emergency Voice/Alarm Communications System.”

“(2) The In-Building Fire Emergency Voice/Alarm Communications System shall consist of the following:”

- One –way voice communication”
- Event/Non-Event #2642 Key switch”
- Remote Annunciator if the building fire alarm control panel is not installed in the assembly space”
- “Warden phone to communicate to the base building Fire Alarm Control Panel or Fire Command Center”

“(3) The Event Mode and Non-Event Mode shall be selectable positions in a two-position key switch at the In-Building Fire Emergency Voice/Alarm Communications System operated by city wide standard key (#2642) with visual indication of mode status at the fire alarm control panel or Fire Command Center. A log record shall be maintained for all mode operations identifying the operator, time and date of each such operation of mode and the selected duration of time for Event Mode.”

“(4) In the Event Mode, no automatic alarm audible or visual notification signals shall be transmitted to the public or occupants of the place of assembly only. Manual live voice

announcements shall be made by the designated Certificate of Fitness holder (F-53) for manual live voice announcements supervising the In-Building Fire Emergency Voice/Alarm Communications System to direct and implement emergency procedures including evacuation.”

“(5) The Event Mode shall be adjustable up to a maximum time period duration of eight hours, and shall automatically revert to Non-Event Mode at the expiration of the time period unless manually switched to Non-Event Mode prior to such expiration time. A supervisory signal in addition to the foregoing is not prohibited.”

“(6) In the Non-Event Mode, all speakers, horns and visual appliances shall emit alarm notification signals for public notification purposes – the audible signal shall comply with the base building approved fire alarm sequence of operation.”

“(7) In the Event Mode, an unacknowledged alarm actuation shall, after the expiration of 180 seconds (3 minutes), automatically revert to Non-Event Mode and cause all alarm appliances to emit notification signals throughout the entire premises without exception, including publicly occupied assembly and support areas. Prerecorded or synthesized voice messages are prohibited.”

“(8) The In-Building Fire Emergency Voice/Alarm Communications System shall be accessible within the assembly space to permit the assigned Certificate of Fitness holder (F-53) for manual live voice announcements to assess conditions and effectively direct evacuation of the admitted public.”

“(9) The In-Building Fire Emergency Voice/Alarm Communications System shall be manned by a Certificate of Fitness holder (F-53) for manual live voice announcements issued by the Fire Department, during all times that the fire alarm system is in Event Mode.”

“(10) A central station connection for manual, automatic and waterflow valve alarm and trouble shall be provided for the fire alarm system, activated automatically in either Event or Non-event Mode.”

“(11) The Certificate of Fitness holder (F-53) for manual live voice announcements shall have the ability at the In-Building Fire Emergency Voice/Alarm Communications System to stop any conflicting or confusing sounds and visual distractions, and to illuminate the assembly space.”

“(12) In buildings that are not required to have a Fire and Life Safety Director person, a Certificate of Fitness holder (F-01) shall be assigned at the main fire alarm control panel to investigate any alarm conditions and report back to the Certificate of Fitness Holder (F-53) supervising the In-Building Fire Emergency Voice/Alarm Communications System.”

“(13) A Certificate of Fitness for Place of Assembly Safety Personnel (F-03/F-04) shall be provided as per the *New York City Fire Code*.”

“(14) All Certificate of Fitness holders on duty during Event Mode shall be equipped with a personal communication device that will allow for two-way communications.”

23.8.5.1.2* Delete and replace with the following: “Where connected to a supervising station, fire alarm systems employing automatic fire detectors or waterflow detection devices shall include a manual fire alarm box to initiate a signal to the supervising station.”

Chapter 24 Emergency Communication Systems (ECS)

Add **24.4.10** to read as follows: “One-Way Emergency Voice Communication System.”

Add **24.4.10.1** to read as follows: “One-way emergency voice communications equipment shall be installed in accordance with 24.4.10.”

Add **24.4.10.2** to read as follows: “Fire Department Use. One-way emergency voice communications service, where provided, shall be for use only by the Fire Department or by building personnel authorized to use such service who have obtained a Certificate of Fitness from the Fire Department.”

Add **24.4.10.2.1** to read as follows: “Activation. The voice communication panel at the annunciator panel shall be operated only by the Fire Department with activation of city wide standard key (#2642).”

Add **24.4.10.2.2** to read as follows: “Building Personnel Use. If requested by a building owner, building personnel who have obtained a FDNY Certificate of Fitness shall be permitted to utilize the system from a panel at the concierge or security desk.”

Add **24.4.10.2.3** to read as follows: “Permitted Variation. Any variation of equipment and system operation, if permitted by the Fire Commissioner, provided in order to facilitate additional uses of any one-way emergency voice communications service shall not adversely affect performance when used by those authorized pursuant to 24.4.1.10.2.”

Add **24.4.10.2.4** to read as follows: “Speaker Stations. Speaker stations shall be installed in each dwelling unit and on at least every other story in every required vertical exit enclosure.”

Add **24.4.11** to read as follows: “One-way Emergency Voice Communications Circuits in Group R-2 Occupancies. Where a one-way voice communications circuit is provided, such system shall comply with provisions for notification appliance integrity monitoring including 10.19, 12.6, 23.4 and 23.7 and the notification appliance circuits serving the apartments and stairway speakers shall meet the classifications for Class “X” Pathway Designation per 12.3.6. Additionally, outgoing and return conductors feeding the same circuit may not be run in the same stairwell.”

Add the following at the end of **24.5**: “In-building mass notification systems shall not be installed unless approved by the Fire Department.”

Add **24.6** to read as follows: “Wide-Area Mass Notification Systems.”

Add **24.6.1** to read as follows: “Wide-area mass notification systems shall not be installed unless approved by the Fire Department.”

24.8.11 Delete and replace with the following: “In buildings provided with a two-way telephone communications system, at least one telephone station shall be provided where required by the *New York City Building Code*.”

24.8.15 Delete and replace with the following: “Telephone jacks are prohibited in new buildings and new fire alarm systems in existing buildings.”

24.9* Delete and replace with the following: “Two-way Radio Communications Enhancement Systems (In-Building Auxiliary Radio Communication System (ARCS)).”

Add 24.9.1.3 to read as follows: “Definitions. The following definitions are applicable to this section only.”

Delivered Audio Quality (DAQ). A measure of audio quality over a transmission medium as defined in standards published in TIA/TSB-88C. The following table shows the DAQ descriptions as published in the document:

<u>Delivered Audio Quality (DAQ)</u>	<u>Faded Subjective Performance Description</u>
<u>1</u>	<u>Unusable, speech present but unreadable.</u>
<u>2</u>	<u>Understandable with considerable effort. Frequent repetition due to noise/distortion.</u>
<u>3</u>	<u>Speech understandable with slight effort. Occasional repetition required due to noise/distortion.</u>
<u>3.4</u>	<u>Speech understandable with repetition only rarely required. Some noise/distortion.</u>
<u>4</u>	<u>Speech easily understood. Occasional noise/distortion.</u>
<u>4.5</u>	<u>Speech easily understood. Infrequent noise/distortion.</u>
<u>5</u>	<u>Speech easily understood.</u>

Dedicated Radio Console (DRC). A fixed location console that contains at least the following components:

- (1) A handset or headset to broadcast and/or receive voice communications from/to ARCS.
- (2) A visual display to identify all signals transmitted from the Firefighter handheld units and supervisory signals.
- (3) Fire Department city wide standard key (#2642) to enable/disable radio transmission.

In-Building Auxiliary Radio Communication System (ARCS). Wireless two-way radio communication enhancement system installed in buildings to propagate Fire Department wireless frequencies for the use of the Fire Department in case of an emergency.

Repeater Channel System. A repeater system utilizing channels with paired receive and transmit frequencies. When a user within the building transmits on a repeater channel, the repeater system rebroadcasts the users’ signal to the DRC and all users within the building on that channel. This transmission increases the distance from which users can directly talk with each other. A user at the DRC must enable repeater channel for users to communicate.

Simplex Channel System. A simplex system utilizing channels with the same frequencies for transmit and receive. Users communicate on simplex channels radio-to-radio without going through infrastructure. However, their radios need to be within a certain distance to be picked up by one another. A simplex system allows a user at the DRC to communicate with a user on a simplex channel anywhere in the building, even though the distance between the DRC and the user would typically be prohibitive. A simplex system only extends the transmission's reach for the DRC. It does not improve coverage between individual user radios.

Add 24.9.2.1 to read as follows: "Critical Areas. Critical areas, such as the fire/emergency command center(s), the fire pump room(s), exit stairs, exit passageways, elevator lobbies, standpipe cabinets, sprinkler sectional valve locations, and other areas deemed critical by the authority having jurisdiction at the time of plan examination, shall be provided with 100 percent floor area radio coverage."

Add 24.9.2.2 to read as follows: "General Building Areas. General building areas shall be provided with 95 percent floor area radio coverage in accordance with rules promulgated by the Fire Department."

Add 24.9.2.3 to read as follows: "System Types. Buildings and structures that cannot support the required level of radio coverage shall be equipped with either a repeater channel system or a simplex channel system."

Add 24.9.3 to read as follows: "Signal Strength."

Add 24.9.3.1 to read as follows: "Inbound. A minimum inbound signal strength of -95 dBm, or other signal strength as required by the authority having jurisdiction, shall be provided throughout the coverage area and provide a minimum intelligible DAQ of 3.4."

Add 24.9.3.2 to read as follows: "Outbound. A minimum outbound signal strength of -95 dBm at the donor site, or other signal strength as required by the authority having jurisdiction, shall be provided from the coverage area and provide a minimum intelligible DAQ of 3.4."

Add 24.9.4 to read as follows: "System Radio Frequencies. The ARCS shall be capable of transmitting all public safety radio frequencies assigned by the Fire Department and be capable of using any modulation technology."

Add 24.9.4.1 to read as follows: "List of Assigned Frequencies. The Fire Department shall maintain a list of all inbound/outbound frequency pairs for distribution to system designers and installers."

Add 24.9.4.2 to read as follows: "Frequency Changes. Systems shall be capable of upgrade, to allow for instances where the Fire Department changes or adds system frequencies, in order to maintain radio system coverage as originally designed."

Add 24.9.4.3 to read as follows: "Perimeter Coverage. The design of the ARCS shall minimize RF radiation beyond the intended building's limits so as to avoid interference, in compliance with FCC regulations."

Add 24.9.5 to read as follows: "Components and Equipment."

Add 24.9.5.1 to read as follows: “Component Approval. Components utilized in the installation of the public safety radio enhancement system, such as repeaters, transmitters, receivers, signal boosters, cabling, and fiber-distributed antenna systems, shall be FCC compliant, listed by a Nationally Recognized Testing Laboratory (NRTL) and shall be compatible with the Fire Department radio system.”

Add 24.9.5.2 to read as follows: “Component Enclosures. All active components including but not limited to repeater, transmitter, receiver, and signal booster components remotely located from the Fire Command Center shall be contained in a listed UL 50E enclosure(s).”

Add 24.9.5.2.1 to read as follows: “The enclosure shall be painted Fire Department Red.”

Add 24.9.5.2.2 to read as follows: “A tamper switch shall monitor all active components in non-secure locations located remotely from the Fire Command Center such as amplifiers and repeaters. The notification for the tamper switch shall be monitored at the DRC.”

Add 24.9.5.3 to read as follows: “Power Supply. Power supply to the ARCS shall be in accordance with Section 760.41 of the *New York City Electrical Code*.

Exception: Where power supply for the building fire alarm system has adequate capacity to support the ARCS power requirements, connection to the fire alarm system power supply via dedicated branch circuits with appropriate overcurrent protection is permitted.”

Add 24.9.5.3.1 to read as follows: “Battery Backup. The ARCS shall be provided with supervisory operations for 24 hours followed by full load operation for 6 hours.”

Add 24.9.5.4 to read as follows: “External filters. Permanent external filters and attachments shall not be permitted.”

Add 24.9.5.5 to read as follows: “Labeling.”

Add 24.9.5.5.1 to read as follows: “Cables.”

Add 24.9.5.5.1.1 to read as follows: “Cables utilized in the ARCS shall be labeled as “FDNY Communications Use”.”

Add 24.9.5.5.1.2 to read as follows: “Where continuously accessible, the cable shall be marked every 8 feet (2438 mm).”

Add 24.9.5.5.1.3 to read as follows: “Wherever the cable is intermittently accessible, each accessible point shall be labeled.”

Add 24.9.5.5.1.4 to read as follows: “Field labeling of the cables shall be acceptable.”

Add 24.9.5.5.2 to read as follows: “Dedicated Radio Console Enclosure. The DRC shall be enclosed and the outside of the enclosure shall be labeled the following in white lettering contrasted against a Fire Department Red background:

AUXILIARY RADIO COMMUNICATIONS

Add 24.9.5.5.3 to read as follows: “Cable Rating. All ARCS cables shall be protected such that the circuit shall maintain its electrical function during fire conditions for at least a 2-hour period and the protection shall not interfere with the normal operation of the system as a whole.

Exception: Radiating ARCS cables running horizontally that are not part of the main trunk connecting to a vertical riser shall have a plenum rating with a minimum temperature of 125°C (257 °F).”

Add 24.9.5.5.4 to read as follows: “Cable Installation and Rating.”

Add 24.9.5.5.4.1 to read as follows: “All ARCS vertical and horizontal risers, and all cabling from the dedicated radio console and from radio amplification units up to such risers, shall be installed to withstand fire conditions for at least a 2-hour period.

Exception: Where such risers are installed in 2-hour rated exit stairway, 2-hour rated elevator shafts or 2-hour rated inaccessible shafts that contain only non-combustible materials.”

Add 24.9.5.5.4.1.1 to read as follows: “All ARCS vertical and horizontal risers shall be plenum rated with a minimum temperature rating of 85°C (185°F).”

Add 24.9.5.5.4.2 to read as follows: “If horizontal non-riser ARCS cables are not installed in a 2-hour rated enclosure, antennas shall be installed on every floor as to allow RF (radio frequency) propagation to overlap from floors above or below, and design criteria that all antennae on any one floor would fail, and that the DAQ and RSSI meet the requirements of 24.9.3.1 and 24.9.3.2 within a building fully protected by an automatic sprinkler system.”

Add 24.9.6 to read as follows: “Supervisory Signals.”

Add 24.9.6.1 to read as follows: “Supervisory signals shall be provided in the form of visual indications (e.g., LED, alpha-numeric display) at the DRC with at minimum for the following system functions:

- (1) The integrity of the circuit monitoring signal booster(s) and power supply(ies) shall comply with 10.17.1.
- (2) Base Station Failure.
 - (a) Low transmit power
 - (b) Over temperature
 - (c) High Voltage Standing Wave Ratios (VSWR)
- (3) Supervisory Signals.
 - (a) Loss of alternating-current power source
 - (b) Overall base-station failure

- (c) Low battery capacity, alarming at 70 percent of battery capacity
- (d) Antenna malfunction, where applicable
- (e) Signal amplification failure, where applicable
- (f) Tamper switch as required.”

Add 24.9.7 to read as follows: “Technical Criteria. The Fire Department shall maintain a document of technical information specific to its requirements. This document shall contain, at a minimum, the following:

- (1) Frequencies required
- (2) Maximum time domain interference
- (3) Unit ID and emergency alert signaling
- (4) DRC specifications
- (5) Installation specifications
- (6) Test equipment specifications
- (7) Other supporting technical information necessary to direct system design.”

Add 24.9.8 to read as follows: “Inspection and Testing. Inspection and testing shall be performed in accordance with testing frequencies and methods set forth in the rules of the Fire Department.”

Chapter 25 Reserved

Chapter 26 Supervising Station Alarm Systems

26.3.9.2 Delete and replace with the following: “Testing and maintenance records shall be retained as required by the *New York City Fire Code*.”

26.3.10 Delete and replace with the following: “Testing and maintenance for central station service shall be performed in accordance with the *New York City Fire Code* and the Rules of the City of New York.”

26.4.1 Delete and replace with the following: “Application. Where permitted by the Fire Department, supervising facilities of proprietary alarm systems shall comply with the operating procedures of 26.4. The facilities, equipment, personnel, operation, testing, and maintenance of the proprietary supervising station shall also comply with 26.4.”

26.6.7 Delete and replace with the following: “Testing and maintenance of communication methods shall be in accordance with the requirements of the *New York City Fire Code*.”

26.6.3.3 Delete and replace with the following: “A single transmission path shall not be permitted.”

26.6.4.1.4 Delete and replace with the following: “Transmission Channels. A system employing a DACT may employ any two of the following transmission means:

- (1) A cellular telephone connection
- (2) A one-way radio system
- (3) A one-way private radio alarm system
- (4) A private microwave radio system
- (5) A two-way RF multiplex system
- (6) An IP connection
- (7) A telephone line
- (8) A transmission means complying with 26.6.3.1.

Exception: Where access to two technologies in the preceding list is not available at the protected premises, with the approval of the Fire Department, a telephone line (number) shall be permitted to be used as the second transmission means. Each DACT shall be programmed to call a second DACR line (number) when the signal transmission sequence to the first called line (number) is unsuccessful. The DACT shall be capable of selecting the operable means of transmission in the event of failure of the other means. Where two telephone lines (numbers) are used, it shall be permitted to test each telephone line (number) at alternating 6-hour intervals.”

Chapter 27 Public Emergency Alarm Reporting Systems No changes.

Chapter 28 Reserved

Chapter 29 Single- and Multiple-Station Alarms and Household Fire Alarm Systems

29.1.4 Delete and replace with the following: “The requirements of this chapter shall not apply to one- and two-family manufactured homes.”

29.5 Delete section, including all subsections, and replace with the following: “Smoke alarm detection and notification requirements shall be in accordance with Section 907 of the *New York City Building Code*.”

29.6.3, Item 2 Delete Item 2 of 29.6.3 and replace with the following: “(2) All electrical systems shall be installed by a New York City licensed electrical contractor.”

ANNEXES

The annexes are not a part of the requirements of this Referenced Standard but are included for informational purposes only. These annexes contain explanatory material, numbered to correspond with the applicable text paragraphs. In the event of any conflict between the

Annexes and the body of the Referenced Standard, particularly where modifications have been made for New York City, the body of the Referenced Standard will govern.

Annex A Explanatory Material No changes.

Annex B Engineering Guide for Automatic Fire Detector Spacing No changes.

Annex C System Performance and Design Guide No changes.

Annex D Speech Intelligibility No changes.

Annex E Sample Ordinance Adopting NFPA 72 No changes.

Annex F Wiring Diagrams and Guide for Testing Fire Alarm Circuits No changes.

Annex G Guidelines for Emergency Communication Strategies for Buildings and Campuses
No changes.

Annex H Informational References No changes.

SECTION BC Q108 **INSTALLATION OF SMOKE CONTROL SYSTEMS**

Q108.1 General. Smoke control systems, where required by this code, shall be installed in accordance with NFPA 92, *Standard for Smoke Control Systems*, 2018 edition, modified for New York City as follows. Refer to the rules of the department for any subsequent additions, modifications or deletions that may have been made to this standard in accordance with Section 28-103.19 of the *Administrative Code*.

Chapter 1 Administration

1.1* Delete and replace with the following: “This standard shall apply to the design of smoke control systems.”

1.2.1 Delete and replace with the following: “The purpose of this standard shall be to establish requirements for smoke control systems using either the airflow design method or the exhaust method to accomplish one of more of the following:”

“(1) Inhibit smoke from entering stairwells, means of egress, smoke refuge areas, elevator shafts, or similar areas”

“(2) Maintain a tenable environment in smoke refuge areas and means of egress during the time required for evacuation”

“(3) Inhibit the migration of smoke from the smoke zone”

“(4) Provide conditions outside the smoke zone that enable emergency response personnel to conduct search and rescue operations and to locate and control the fire”

“(5) Contribute to the protection of life and to the reduction of property loss”

1.2.2 Delete the words “other codes and standards”.

1.2.3 Delete the words “other codes and standards”.

Add 1.2.4 to read as follows: “The requirements for pressurization systems are provided in the *New York City Building Code*.”

1.3 Delete entire sections, including subsections.

1.4 Delete entire sections, including subsections.

Chapter 2 Referenced Publications

2.1 Add at end the following: “Where a referenced publication has been modified for the City of New York by the *New York City Building Code* or the rules of the Department of Buildings, every reference to such publication shall be deemed to include all such modifications. Where the edition of a publication referenced within this standard differs from the edition provided for the same standard in Chapter 35 of the *New York City Building Code*, the edition provided for in Chapter 35 of the *New York City Building Code* shall govern.”

Chapter 3 Definitions

3.3.1 Delete definition of Atrium and replace with the following: “See the *New York City Building Code*.”

3.3.12 Delete definition of Smoke and replace with the following: “See the *New York City Building Code*.”

3.3.13* Delete definition of Smoke Barrier and replace with the following: “See the *New York City Building Code* definition of ‘Smoke Partition’. Where the term ‘Smoke Barrier’ is utilized throughout this referenced standard, it shall be amended to read ‘Smoke Partition.’”

3.3.15* Delete definition of Smoke Control Mode and replace with the following: “See the *New York City Building Code*.”

3.3.16* Delete definition of Smoke Damper and replace with the following: “See the *New York City Building Code*.”

3.3.22 Delete definition of Stack Effect and replace with the following: “See the *New York City Building Code*.”

3.3.24* Delete definition of Tenable Environment and replace with the following: “See the *New York City Building Code*.”

3.3.25 Delete definition of Smoke Control Zone and replace with the following: “See the *New York City Building Code*.”

Chapter 4 Design Fundamentals

4.1.1* Delete Item (1).

4.2.3 Delete entire sections, including subsections.

4.4.2 Delete entire sections, including subsections.

Table 4.4.2.1.1 Delete.

4.6 Delete entire sections, including subsections.

4.7 Delete.

4.8.1.2 Delete.

4.8.3 Delete entire sections, including subsections.

Chapter 5 Smoke Management Calculation Procedures No changes.

Chapter 6 Building Equipment and Controls Delete entire chapter including all sections and subsections.

Chapter 7 Smoke Control System Documentation

7.1 Delete the words “by the designer during the design process”.

7.3.1 Delete the words “(see Chapter 8)” from Item (2).

Chapter 8 Testing Delete entire chapter including all sections and subsections.

ANNEXES

The annexes are not a part of the requirements of this Referenced Standard but are included for informational purposes only. These annexes contain explanatory material, numbered to correspond with the applicable text paragraphs. In the event of any conflict between the Annexes and the body of the Referenced Standard, particularly where modifications have been made for New York City, the body of the Referenced Standard will govern.

Annex A Explanatory Material No changes.

Annex B Predicting the Rate of Heat Release of Fires No changes.

Annex C Computer-Based Models for Atria and Malls No changes.

Annex D Additional Design Objectives No changes.

Annex E Stratification of Smoke No changes.

Annex F Types of Stairwell Pressurization Systems No changes.

Annex G HVAC Air-Handling System Types No changes.

Annex H Fire Fighters' Smoke Control Station (FSCS) Considerations Delete entire Annex including all sections and subsections.

Annex I Information on Testing for Leakage Between Smoke Zones No changes.

Annex J Advisory Information on Acceptance Testing No changes.

Annex K Example Problems Illustrating the Use of Equations No changes.

Annex L Comparison of Equations No changes.

Annex N Information References No changes.

§ 67. Figure 1A of section R103.3 of appendix R of the New York city building code is REPEALED and a new figure 1A is added to read as follows:

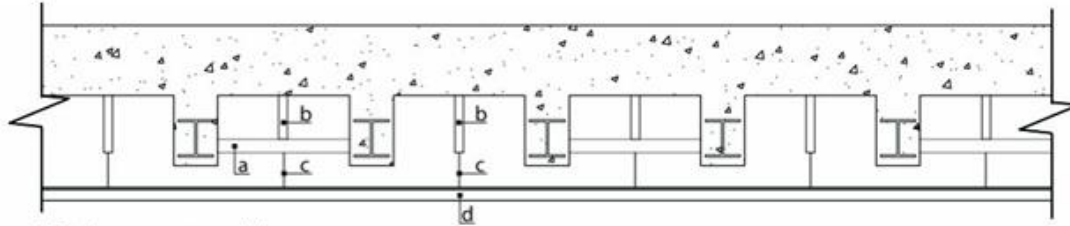

'cinder concrete arch'

- (a) 1-1/2" C bridging 85# hot rolled or 1-1/2" .803# cold formed furring channels not to exceed 4'-6" o.c.
- (b) hook over reinforcing 1" x 15" flat iron bolted to 'a' or punched to receive rod hanger.
- (c) 1/4" ϕ or 1" x 1/8" hanger not to exceed 4'-6" o.c.
- (d) 1-1/2" C cold rolled 0.440# carrying C not to exceed 4'-6" o.c.

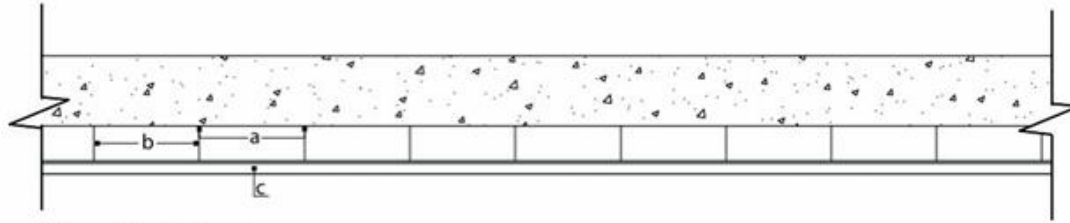

'stone concrete arch'

- (a) expansion shields or other approved fastening not to exceed 4'-6" o.c.
- (b) 1/4" ϕ or 1" x 1/8" hanger not to exceed 4'-6" o.c.
- (c) 1-1/2" C cold rolled 0.440# carrying C not to exceed 4'-6" o.c.

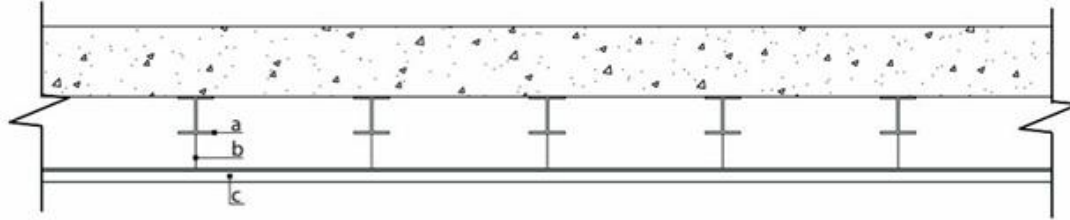

'exposed steel construction'

- (a) beam clamp or approved fastening device not to exceed 4'-6" o.c.
- (b) 1/4" ϕ or 1" x 1/8" hanger not to exceed 4'-6" o.c.
- (c) 1-1/2" C cold rolled 0.440# carrying C not to exceed 4'-6" o.c.

note
 construction similar to:
 (1) open steel joist
 (2) concrete plank
 (3) bulb tee

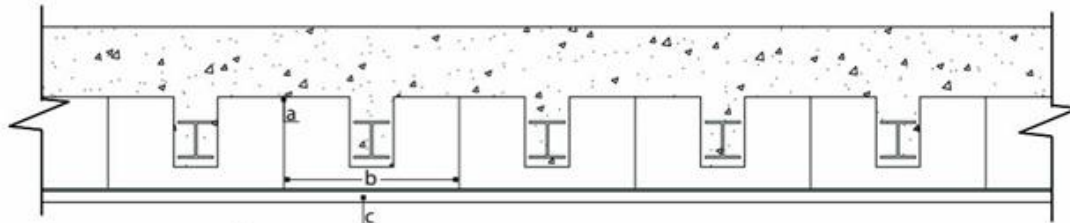

'new concrete arch'

- (a) insert or approved fastening cast in slab not to exceed 4'-6" o.c.
- (b) 1/4" ϕ or 1" x 1/8" hanger not to exceed 4'-6" o.c.
- (c) 1-1/2" C cold rolled 0.440# carrying C not to exceed 4'-6" o.c.

FIGURE 1A
HANGER CONNECTION DETAILS FOR CONSTRUCTION GROUPS I AND I

§ 68. Figure 1B of section R103.3 of appendix R of the New York city building code

is REPEALED and a new figure 1B is added to read as follows:

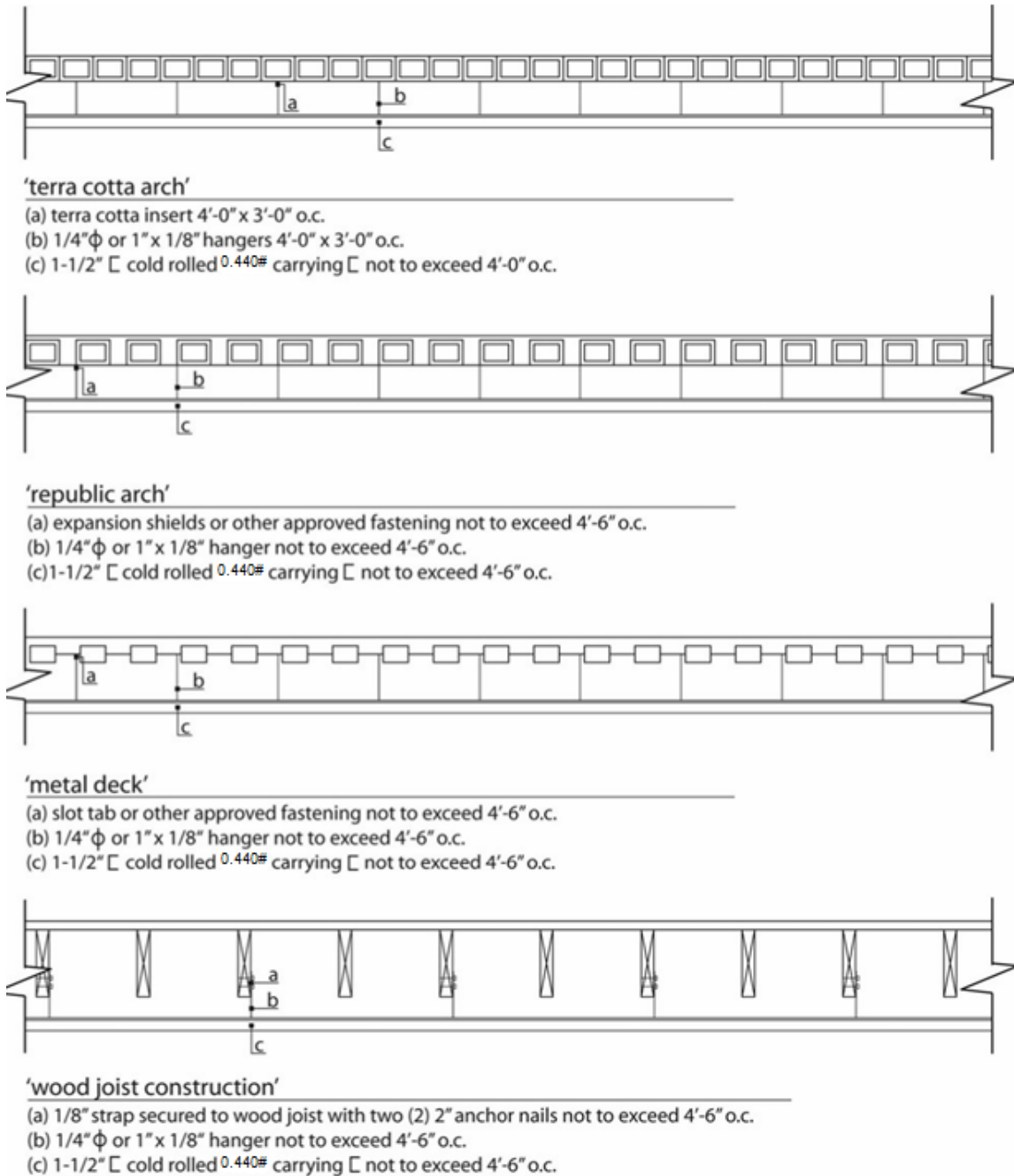

FIGURE 1B
HANGER CONNECTION DETAILS FOR CONSTRUCTION GROUPS I AND II

§ 69. Section R103.4 of appendix R of the New York city building code, as added by

local law number 33 for the year 2007, is amended to read as follows:

R103.4 ASTM C 636, Section 2.1.5. Delete Section 2.1.5 and replace as follows:

2.1.5 Each connection of a hanger to a structural member of the building shall be in accordance with ~~[Sections]~~ Section 2.1.5.1 or 2.1.5.2 as applicable.

§ 70. Section R103.8 of appendix R of the New York city building code, as added by local law number 33 for the year 2007, is amended to read as follows:

R103.8 ASTM C 636, Section 2.2.4. Delete Section 2.2.4 and replace as follows:

2.2.4 Carrying channels shall be designed to support the suspended loads, and shall be a minimum 1½ inches deep (38 mm) cold-rolled steel channel weighing ~~[0.457]~~ 0.440 pounds per linear foot (~~[0.707]~~ 0.681 kg/m) and shall be given an electro-galvanized, hot dipped galvanized cadmium coating, or zinc coating.

§ 71. Section R103.10 of appendix R of the New York city building code, as added by local law number 33 for the year 2007, is amended to read as follows:

R103.10 ASTM C 636, Section 2.3.2. Delete Section 2.3.2 and replace as follows:

2.3.2 Main runners shall be supported from the carrying channels. Direct hung suspension systems where the main runners are supported directly to the existing structure shall not be permitted. Indirect hung or furring bar suspension systems designed and installed in accordance with this code and utilizing carrying channels shall be permitted.

§ 72. Section S101.1 of Appendix S of the New York city building code, as added by local law number 141 for the year 2013, is amended to read as follows:

S101.1 Scope. The figures of this appendix shall supplement the provisions of luminous egress path markings in Section ~~[1024]~~ 1025 and are intended for illustrative purposes. Where there is a conflict between the figures and the provisions in Section ~~[1024]~~ 1025, the provisions in Section ~~[1024]~~ 1025 shall govern.

§2. Chapter 1 of the New York city mechanical code, as amended by local law number 141 for the year 2013, item 5 of section 106.8 as amended by local law number 195 for the year 2018, is amended to read as follows:

**CHAPTER 1
ADMINISTRATION**

**SECTION MC 101
GENERAL**

101.1 Title. This code shall be known and may be cited as the “*New York City Mechanical Code*,” “NYCMC” or “MC.” All section numbers in this code shall be deemed to be preceded by the designation “MC.”

101.2 Scope. This code shall regulate the design, installation, maintenance, alteration and inspection of mechanical systems that are permanently installed and utilized to provide control of environmental conditions and related processes within buildings. This code shall also regulate those mechanical systems, system components, equipment and appliances specifically addressed herein. The installation of fuel gas distribution piping and equipment, fuel gas-fired appliances and fuel gas-fired appliance venting systems shall be regulated by the *New York City Fuel Gas Code*.

101.3 Intent. The purpose of this code is to provide minimum standards to safeguard life or limb, health, property, public welfare and the environment by regulating and controlling the design, construction, installation, quality of materials, location, operation and maintenance or use of mechanical systems.

101.4 Severability. If a section, subsection, sentence, clause or phrase of this code is, for any reason, held to be unconstitutional, such decision shall not affect the validity of the remaining portions of this code.

**SECTION MC 102
APPLICABILITY**

102.1 General. [-] Where there is a conflict between a general requirement and a specific requirement, the specific requirement shall govern. Where, in a specific case, different sections of this code specify different materials, methods of construction or other requirements, the most restrictive shall govern.

102.2 Existing installations. Except as otherwise provided for in this chapter or elsewhere in this code, a provision in this code shall not require the removal, alteration or abandonment of, nor prevent the continued utilization and maintenance of, a mechanical system lawfully in existence on the effective date of this code.

102.3 Maintenance. Mechanical systems, both existing and new, and parts thereof shall be maintained in proper operating condition in accordance with the original design and in a safe and sanitary condition. Devices or safeguards that are required by this code shall be maintained in compliance with the applicable provisions under which they were installed.

102.3.1 Owner responsibility. The owner shall be responsible for maintenance of mechanical systems. To determine compliance with this provision, the commissioner shall have the authority to require existing mechanical systems to be inspected.

102.4 Additions, alterations or repairs. Additions, alterations, renovations or repairs to a mechanical system shall conform to requirements for a new mechanical system without requiring the existing mechanical system to comply with all of the requirements of this code. Additions, alterations or repairs shall not cause an existing mechanical system to become unsafe, hazardous or overloaded.

102.4.1 Minor additions, alterations, renovations and repairs. Minor additions, alterations, renovations and repairs to existing mechanical systems shall meet the provisions for new construction, unless such work is done in the same manner and arrangement as was in the existing system, is not hazardous and is approved.

102.4.2 Special provisions for prior code buildings. In addition to the requirements of Sections 102.4 and 102.4.1, the provisions of Sections 102.4.2.1 through 102.4.2.6 shall apply to prior code buildings.

102.4.2.1 Fire and smoke dampers. In cases where the building's passive fire-resistance protection design, including rated construction, corridors and fire separations, complies with 1968 or prior codes, the determination as to whether a fire or smoke damper is required shall be permitted to be made pursuant to the *1968 Building Code*, or at the election of the applicant, the *New York City Mechanical Code*.

102.4.2.2 Guards and access to roofs and elevated structures. The provisions of Section [~~304.10~~] 304.11 relating to guards and Section 306.5 relating to permanent means of access shall not apply where the equipment or appliances replace existing equipment or appliances in the same location.

102.4.2.3 Vibration isolators for cooling towers. Where a replacement cooling tower is installed and physical limitations prohibit compliance with the vibration isolator requirements of Section [~~928.3.7~~] 313.3.7, such isolators may be omitted provided the devices shall comply with the *New York City Noise Control Code*.

102.4.2.4 Noncombustible fill for cooling towers. Where an existing exterior cooling tower with combustible fill within 15 feet (4572 mm) of the lot line is replaced, such replacement shall be permitted to have combustible fill, notwithstanding the provisions of Section 908.3.2.

102.4.2.5 Seismic supports. The determination as to whether seismic requirements apply to an alteration shall be made in accordance with the *1968 Building Code* and interpretations by the department relating to such determinations. Any applicable seismic loads and requirements shall be permitted to be determined in accordance with Chapter 16 of the *New York City Building Code* or the *1968 Building Code* and Reference Standard RS 9-6 of such code.

102.4.2.6 Wind resistance. Equipment, appliances and supports that are exposed to wind shall be designed and installed to resist the wind pressures determined in accordance with Chapter 16 of the *New York City Building Code*.

102.5 Change in occupancy. Refer to Chapter 1 of Title 28 of the *Administrative Code*.

102.6 Reserved.

102.7 Reserved.

102.8 Referenced standards. The standards referenced herein shall be those that are listed in Chapter 15 and in the rules of the department and such standards shall be considered as part of the requirements of this code to the prescribed extent of each such reference. Where differences occur between provisions of this code and the referenced standards, the provisions of this code shall apply. Refer to Article 103 of Chapter 1 of Title 28 of the *Administrative Code* for additional provisions relating to referenced standards.

102.8.1 Editions of referenced standards. References to standards in this code shall be to the editions of those standards provided for in Chapter 15 of this code, or as otherwise provided by rule.

102.9 Requirements not covered by this code. Requirements necessary for the strength, stability or proper operation of an existing or proposed mechanical system, or for the public safety, health and general welfare, not specifically covered by this code, shall be determined by the commissioner.

SECTION MC 103 DEPARTMENT OF BUILDINGS

103.1 General. Refer to the New York City Charter and Chapter 1 of Title 28 of the *Administrative Code*.

SECTION MC 104 DUTIES AND POWERS OF THE COMMISSIONER OF BUILDINGS

104.1 General. The commissioner shall have the authority to render interpretations of this code, ~~and~~ ~~to~~ adopt rules, and establish policies ~~[,]~~ and procedures in order to clarify and implement its provisions. Such interpretations, policies, procedures, and rules shall be in compliance with the intent and purpose of this code. See the New York City Charter and Chapter 1 of Title 28 of the *Administrative Code* for additional provisions relating to the authority of the Commissioner of Buildings.

SECTION MC 105 APPROVALS

105.1 Approvals. Refer to Chapter 1 of Title 28 of the *Administrative Code*.

SECTION MC ~~[105]~~ 106 PERMITS

~~[105.1]~~ 106.1 General. Permits shall comply with this section, with Article 105 of Chapter 1 of Title 28 of the *Administrative Code*, and with requirements found elsewhere in this code.

~~[105.2]~~ 106.2 Required. Any owner or authorized agent who intends to construct, add to, alter, repair, move, demolish, or change the occupancy of a building or structure, or to erect, install, add

to, alter, repair, remove, convert or replace any gas, mechanical or plumbing system, the installation of which is regulated by this code, or to cause any such work to be done, shall first make application for construction document approval in accordance with Chapter 1 of Title 28 of the *Administrative Code* and this chapter and obtain the required permit.

[105.3] 106.3 Work exempt from permit. Exemptions from permit requirements of this code as authorized in Chapter 1 of Title 28 of the *Administrative Code* and the rules of the department shall not be deemed to grant authorization for any work to be done in any manner in violation of the provisions of this code or any other laws or rules.

[105.4] 106.4 Validity of permit. The issuance or granting of a permit shall not be construed to be a permit for, or an approval of, any violation of any of the provisions of this code or of any other law. Permits presuming to give authority to violate or cancel the provisions of this code or other law shall not be valid. The issuance of a permit based on construction documents and other data shall not prevent the commissioner from requiring the correction of errors in the construction documents and other data. The commissioner is also authorized to prevent occupancy or use of a structure where in violation of this code or of any other law.

106.5 Permits with respect to limited alteration applications. For permits with respect to limited alteration applications refer to Sections 28-101.5 and 28-104.6, Exception 1 of the *Administrative Code*.

SECTION MC ~~[106]~~ 107 CONSTRUCTION DOCUMENTS

[106.1] 107.1 General. Construction documents shall comply with Article 104 of Chapter 1 of Title 28 of the *Administrative Code* and other applicable provisions of this code and its referenced standards. Such construction documents shall be coordinated with architectural, structural and means of egress plans.

[106.2] 107.2 Required documents. The applicant shall submit all of the documents specified in Sections ~~[106.3]~~ 107.3 through ~~[106.10]~~ 107.10 as appropriate to the nature and extent of the work proposed. Construction documents shall indicate the heating, ventilation, refrigeration, and other mechanical work to be performed, so drawn as to conform to the architectural and structural aspects of the building and to show in detail compliance with this code.

~~[106.2.1]~~ 107.2.1 Composite plans. Composite plans showing compliance of architectural, structural, and mechanical parts of a building may be submitted provided that a clear understanding of each part is not impaired.

[106.3] 107.3 Lot diagram. The lot diagram shall be provided where applicable to the work proposed, including but not limited to the installation of exterior or rooftop equipment.

[106.4] 107.4 Building classification statement. Where applicable to the proposed work, the statement shall identify:

1. The occupancy group or groups that apply to parts of the building in accordance with Section 302 of the *New York City Building Code*;

2. The occupancy group of the main use or dominant occupancy of the building;
3. The construction [~~class~~] type of the building in accordance with Section 602 of the *New York City Building Code*;
4. The structural occupancy/risk category in accordance with Table 1604.5 of the *New York City Building Code*;
5. The height of the building as defined in Section [~~502.4~~] 202 of the *New York City Building Code*;
6. The applicable measurements to the highest and lowest level of [~~fire department~~] Fire Department access; [~~and~~]
7. Whether the building is inside or outside of the fire districts [-]; and
8. Whether the building is inside or outside a flood hazard area as such term is defined in Chapter 2 of the *New York City Building Code*.

[~~106.5~~] 107.5 Fuel-burning and fuel-oil storage equipment plans. Construction documents for fuel-burning and fuel-oil storage equipment shall contain plans that include the following data and information:

1. Diagrams of all distribution piping, including vent and fill piping for oil systems, and all safety cut-off and relief devices and valves in piping; indications of the sizes of distribution piping to be used and the fire-resistive ratings of the shafts or spaces containing distribution piping where required to be fire rated.
2. Diagrammatic floor plans showing the size, location, material for all fuel oil and transfer distribution piping and related equipment.
3. Floor plans or partial floor plans showing the location, operating pressure, layout, size, and listing information for all fuel-burning equipment, tanks, vents, and chimneys. The plans shall also indicate the method or means of providing air to the equipment space, including duct and opening sizes or means of direct venting.
4. Plans indicating the location and type of any relevant smoke and heat detectors, alarm and fire extinguishing systems.
5. Seismic protection and restraint details for piping and equipment as required by Chapter 16 of the *New York City Building Code*.
6. Details indicating the location, size and materials for all breechings; the thickness and type of insulation materials; and the clearances from combustible walls, partitions, and ceiling; and the fire-resistive ratings of rooms and spaces containing the equipment.
7. Details describing the type, material, listing information, height, and termination distances to adjacent properties and structures for chimneys and vents.

8. Details showing structural supports for fuel-burning equipment where required.
9. A statement as to the kind or grade of fuel to be used.
10. Plans indicating the location, arrangement, size, load, and maximum capacity of the burning, storage and fuel-pumping equipment.
11. In ~~[areas of]~~ special flood ~~[hazards]~~ hazard areas, construction documents shall comply with Appendix G of the *New York City Building Code*.

[106.6] 107.6 Heating systems. Construction documents for heating systems shall include the temperature to be maintained in every room and the output capacity in BTU per hour of the central heating source.

[106.7] 107.7 Boilers. Construction documents for boiler installations shall indicate the output capacity in BTU per hour, the operating weight of each boiler, the pressure setting of the relief valves, and such other data and information as required by this code.

[106.8] 107.8 Air-conditioning and ventilating systems. Construction documents for air-conditioning and ventilating systems shall contain plans that include the following data and information:

1. The location and sizes of all ducts; the location of all fire and smoke dampers, motors, fans, and filters; the type, air capacity, and size of all equipment; and where not shown on accompanying structural plans, the operating weight and manner of support of equipment.
2. The locations of smoke detecting devices.
3. The location and size of the fresh air intake, the design population, and the required ventilation for each room or space.
4. The amount of air to be exhausted or supplied from each outlet for each room or space.
5. In the case of ventilating or exhaust systems for ranges, fryers, ovens, and other similar types of restaurant or bakery equipment, for which a hood is required, the plans shall also show the type of extinguishing system, the location of heat detection devices, nozzles, piping, gas controls, manual and automatic control valves, method of joining ducts, method and location of discharging exhaust from building, the location of break-glass controls, and the quantity in cfm designed for each hood.
6. The safety group classification of refrigerant utilized, if any.
7. The refrigerant concentration limit calculations and routing of all refrigerant piping for any air-conditioning system that contains more than 6.6 pounds (3.0 kg) of refrigerant. Refer to Chapter 11 for refrigerant piping requirements.

[106.9] 107.9 Refrigerating systems. Construction documents for refrigerating systems shall contain plans that include the following data and information:

1. The location of all machinery; the horsepower of compressors; the type and number of pounds of refrigerant to be used; and the air quantities for, and means of, ventilating the machinery space.
2. The location of refrigerant detectors and emergency switches for compressors and for ventilation in the machinery rooms.
3. The location of pressure relief piping and any city water connections and water-saving devices.
4. The tonnage capacity of the machine and the suction and discharge pressures at which the machine is rated.
5. The operating weight of the equipment.
6. The safety group classification of refrigerant utilized.
7. The refrigerant concentration limit calculations and routing of all refrigerant piping for any refrigerating system that contains more than 6.6 pounds (3.0 kg) of refrigerant. Refer to Chapter 11 for refrigerant piping requirements.

[106.10] 107.10 Energy efficiency. Construction documents shall include compliance documentation as required by the *New York City Energy Conservation Code*.

107.11 Retention of construction and submittal documents. Refer to Section 28-104.12 of the *Administrative Code*.

SECTION MC [107] 108 INSPECTIONS AND TESTING

[107.1] 108.1 General. Except as otherwise specified, inspections required by this code or by the department during the progress of work may be performed on behalf of the owner by approved agencies or, if applicable, by special inspectors. However, in the interest of public safety, the commissioner may direct that any of such inspections be performed by the department. All inspections shall be performed at the sole cost and expense of the owner. Refer to Article 116 of Chapter 1 of Title 28 of the *Administrative Code* for additional provisions relating to inspections.

[107.2] 108.2 Required inspections and testing. In addition to any inspections otherwise required by this code or applicable rules, the following inspections shall be required:

1. Progress inspections.

- 1.1. Underground inspection and/or testing of installed piping, valves, fittings, support structures, anti-corrosion equipment and associated underground components shall be made [after trenches or ditches are excavated and bedded, piping installed, and] before backfill is put in place. When excavated soil contains rocks, broken concrete, frozen chunks and other rubble that would damage or break the piping or cause corrosive action, clean backfill shall be on the job site ready for use in backfilling.

Exception: Ground-source heat pump loop systems tested and backfilled in accordance with Section [~~1208.1.1~~] 1210 shall be permitted to be backfilled prior to inspection.

- 1.2. Rough-in inspection shall be made after the roof, framing, fireblocking and bracing are in place and all ducting and other components to be concealed are complete, and prior to the installation of wall or ceiling membranes.
- 1.3. Inspections required by the *New York City Energy Conservation Code* shall be made in accordance with the rules of the department, as applicable.
2. **Special inspections.** Special inspections shall be performed in accordance with this code and Chapter 17 of the *New York City Building Code*.
3. **Final inspection.** Refer to Article 116 of Chapter 1 of Title 28 of the *Administrative Code*.
4. **Issuance of certificate of compliance.** Upon satisfactory inspection of service equipment and the satisfaction of all the requirements for sign-off, the department shall issue a certificate of compliance as applicable for the following service equipment:
 - 4.1. Air-conditioning and ventilation systems,
 - 4.2. Fuel-burning and fuel-oil storage equipment, including generators,
 - 4.3. Refrigeration systems,
 - 4.4. Heating systems, and
 - 4.5. Boilers.

The requirements of Section [~~107.2~~] 108.2 shall not be considered to prohibit the operation of any heating equipment or appliances installed to replace existing heating equipment or appliances serving an occupied portion of a structure provided that a request for inspection of such heating equipment or appliances has been filed with the department not more than 48 hours after such replacement work is completed, and all required inspections are performed before any portion of such equipment or appliances is concealed by any permanent portion of the structure.

[~~107.2.1~~] 108.2.1 Approved inspection agencies. Refer to Articles 114 and 115 of Chapter 1 of Title 28 of the *Administrative Code*.

[~~107.2.2~~] 108.2.2 Inspection of prefabricated construction assemblies. Prior to the approval of a prefabricated construction assembly having concealed mechanical work and the issuance of a permit, the department shall require the submittal of an evaluation report by an approved agency on each prefabricated construction assembly, indicating the complete details of the mechanical system, including a description of the system and its components, the basis upon which the system is being evaluated, test results and similar information, and other data as necessary for the commissioner to determine conformance to this code.

~~[107.2.2.1]~~ **108.2.2.1 Test and inspection records.** Required test and inspection records shall be available to the commissioner at all times during the fabrication of the mechanical system and the erection of the building; or such records as the commissioner designates shall be filed.

108.2.3 Exposure of work. The work shall remain accessible and exposed for inspection purposes. Neither the commissioner nor the city shall be liable for expense entailed in the removal or replacement of any material required to allow inspection.

~~[107.3]~~ **108.3 Testing.** Mechanical systems shall be tested as required in this code and in accordance with Sections ~~[107.3.1]~~ 108.3.1 through ~~[107.3.3]~~ 108.3.3. Tests shall be made by the permit holder and witnessed by the department or an approved agency.

~~[107.3.1]~~ **108.3.1 New, altered, extended or repaired systems.** New mechanical systems and parts of existing systems, that have been altered, extended, renovated or repaired, shall be tested as prescribed herein to disclose leaks and defects.

~~[107.3.2]~~ **108.3.2 Apparatus, material and labor for tests.** Apparatus, material and labor required for testing a mechanical system or part thereof shall be furnished by the permit holder.

~~[107.3.3]~~ **108.3.3 Reinspection and testing.** Where any work or installation does not pass an initial test or inspection, the necessary corrections shall be made ~~[so as to achieve compliance]~~ to comply with this code. The work or installation shall then be resubmitted to the department for inspection and testing.

~~[107.4]~~ **108.4 Sign-off of completed work.** Refer to Article 116 of Chapter 1 of Title 28 of the *Administrative Code*.

~~[107.5]~~ **108.5 Temporary connection.** The commissioner shall have the authority to authorize the temporary connection of a mechanical system to the sources of energy for the purpose of testing mechanical systems or for use under a temporary certificate of occupancy.

SECTION MC 109 VIOLATIONS

~~[108.1]~~ **109.1 General.** Refer to Chapters 2 and 3 of Title 28 of the *Administrative Code*.

§ 3. Chapter 2 of the New York city mechanical code, as amended by local law number 141 for the year 2013, is amended to read as follows:

CHAPTER 2

DEFINITIONS

SECTION MC 201 GENERAL

201.1 Scope. Unless otherwise expressly stated, the following words and terms shall, for the purposes of this code, have the meanings indicated in this chapter.

201.2 Interchangeability. Words used in the present tense include the future; words in the masculine gender include the feminine and neuter; the singular number includes the plural and the plural, the singular.

201.3 Terms defined in other codes. Where terms are not defined in this code and are defined in the *New York City Building Code*, the *New York City Electrical Code*, the *New York City Fire Code*, the *New York City Fuel Gas Code* [ø¶], the *New York City Plumbing Code*, or the New York City Energy Conservation Code, such terms shall have meanings ascribed to them as in those codes.

201.3.1 Terms defined in the general administrative provisions. The following terms are defined in Section 28-101.5 of the *Administrative Code*:

1968 BUILDING CODE.

1968 OR PRIOR CODE BUILDINGS OR STRUCTURES (PRIOR CODE BUILDINGS).

ACCEPTANCE OR ACCEPTED.

ADDITION.

ADMINISTRATIVE CODE.

ALTERATION.

APPROVAL OR APPROVED.

APPROVED AGENCY.

APPROVED FABRICATOR.

APPROVED INSPECTION AGENCY.

APPROVED TESTING AGENCY.

ARCHITECT.

BUILDING.

CHARTER.

CERTIFICATE OF COMPLIANCE.

CITY.

COMMISSIONER.

CONSTRUCTION DOCUMENTS.

DAY.

DEFERRED SUBMITTAL.

DEMOLITION.

DEMOLITION, FULL.

DEMOLITION, PARTIAL.

DEPARTMENT.

ENGINEER.

ENLARGEMENT.

ENVIRONMENTAL CONTROL BOARD or ECB.

EXISTING BUILDING OR STRUCTURE.

FABRICATED ITEM.

FIRE PROTECTION PLAN.

HEREAFTER.

HERETOFORE.

INSPECTION CERTIFICATE.

INTERIM CERTIFICATE OF OCCUPANCY.

LABEL.

LABELED.

LAND SURVEYOR.

LANDSCAPE ARCHITECT.

LETTER OF COMPLETION.

LIMITED ALTERATION APPLICATION.

LIMITED PLUMBING ALTERATIONS.

LIMITED SPRINKLER ALTERATIONS.

LIMITED STANDPIPE ALTERATIONS.

LISTED.

MAIN USE OR DOMINANT OCCUPANCY (OF A BUILDING).

MANUFACTURER'S DESIGNATION.

MARK.

MATERIALS.

OCCUPANCY.

OWNER.

PARTY WALL.

PERMIT.

PERSON.

PREMISES.

PRIOR CODE BUILDING.

PROFESSIONAL CERTIFICATION.

PROGRESS INSPECTION.

PROJECT.

REGISTERED DESIGN PROFESSIONAL.

REGISTERED DESIGN PROFESSIONAL OF RECORD. REQUIRED.

RETAINING WALL.

SERVICE EQUIPMENT.

SIGN-OFF.

SINGLE ROOM OCCUPANCY MULTIPLE DWELLING.

SPECIAL INSPECTION.

SPECIAL INSPECTION AGENCY.

SPECIAL INSPECTOR.

STRUCTURE.

SUBMITTAL DOCUMENTS.

SUPERINTENDENT OF CONSTRUCTION (CONSTRUCTION SUPERINTENDENT).

USE (USED).

UTILITY COMPANY OR PUBLIC UTILITY COMPANY.

UTILITY CORPORATION OR PUBLIC UTILITY CORPORATION.

WORK NOT CONSTITUTING MINOR ALTERATIONS OR ORDINARY REPAIRS.

WRITING (WRITTEN).

WRITTEN NOTICE.

ZONING RESOLUTION.

201.4 Terms not defined. Where terms are not defined through the methods authorized by this section, such terms shall have ordinarily accepted meanings such as the context implies.

SECTION MC 202 GENERAL DEFINITIONS

~~[1968 OR PRIOR CODE BUILDINGS OR STRUCTURES (PRIOR CODE BUILDINGS).~~ See Section 28-101.5 of the *Administrative Code*.]

ABRASIVE MATERIALS. Moderately abrasive particulate in high concentrations, and highly abrasive particulate in moderate and high concentrations, such as alumina, bauxite, iron silicate, sand and slag.

ABSORPTION SYSTEM. A refrigerating system in which refrigerant is pressurized by pumping a chemical solution of refrigerant in absorbent, and then separated by the addition of heat in a generator, condensed (to reject heat), expanded, evaporated (to provide refrigeration), and reabsorbed in an absorber to repeat the cycle; the system may be single or multiple effect, the latter using multiple stages or internally cascaded use of heat to improve efficiency.

ACCESS (TO). That which enables a device, fixture, appliance or equipment to be reached by ready access or by a means that first requires the removal or movement of a panel, door or similar obstruction (see also “Ready access (to)”).

AIR. All air supplied to mechanical equipment and appliances for combustion, ventilation, cooling [; etc] and similar purposes. Standard air is air at standard temperature and pressure, namely, 70°F ([2+] 21.1°C) and 29.92 inches of mercury (101.3 kPa).

AIR CONDITIONING. The treatment of air so as to control simultaneously the temperature, humidity, cleanness and distribution of the air to meet the requirements of a conditioned space.

AIR-CONDITIONING SYSTEM. A system that consists of heat exchangers, blowers, filters, supply, exhaust and return ducts, and shall include any apparatus installed in connection therewith.

AIR DISPERSION SYSTEM. Any diffuser system designed to both convey air within a room, space or area and diffuse air into that space while operating under positive pressure. Systems are commonly constructed of, but not limited to, fabric or plastic film.

AIR DISTRIBUTION SYSTEM. Any system of ducts, plenums and air-handling equipment that circulates air within a space or spaces and includes systems made up of one or more air-handling units.

AIR, EXHAUST. Air being removed from any space, appliance or piece of equipment and conveyed directly to the atmosphere by means of openings or ducts.

AIR, INTAKE. Air supplied from the outdoors to any space, appliance or piece of equipment.

AIR-HANDLING UNIT. A blower or fan used for the purpose of distributing supply air to a room, space or area.

AIR, MAKEUP. ~~[Air that is provided]~~ Any combination of outdoor and transfer air intended to replace exhaust air [being exhausted] and exfiltration.

AIR, OUTDOOR. Ambient air that enters a building through a ventilation system, through intentional openings for natural ventilation, or by infiltration.

AIR, RELIEF. Air removed from any space, appliance or piece of equipment that serves to balance building pressurization due to introduction of outdoor air. Exhaust air shall not be considered relief air.

AIR, RETURN. Air removed from a conditioned space or location and recirculated or relieved to the outdoors.

AIR, TRANSFER. Air moved from one indoor space to another.

AIR TRANSFER OPENING. An opening designed to allow the movement of environmental air between two contiguous spaces.

~~[ALTERATION. Any construction, addition, change of use or occupancy, or renovation to a building or structure in existence. See Section 28-101.5 of the *Administrative Code*.]~~

APPLIANCE. A device or apparatus that is manufactured and designed to utilize energy and for which this code provides specific requirements.

APPLIANCE, EXISTING. Any appliance regulated by this code ~~[which]~~ that was legally installed prior to the effective date of this code, or for which a permit to install has been issued.

APPLIANCE, FUEL-FIRED. An appliance that burns solid, liquid and/or gaseous fuel, including but not limited to wood stoves, household cooking ranges, furnaces, boilers, water heaters, clothes dryers and gas-fired refrigerators.

APPLIANCE, GAS (EQUIPMENT). Any apparatus or equipment that uses gas as a fuel or raw material to produce light, heat, power, refrigeration or air conditioning.

APPLIANCE TYPE.

High-heat appliance. Any appliance in which the products of combustion at the point of entrance to the flue under normal operating conditions have a temperature greater than 2,000°F ([1093] 1093.3°C).

Low-heat appliance (residential appliance). Any appliance in which the products of combustion at the point of entrance to the flue under normal operating conditions have a temperature of 1,000°F ([538] 537.8°C) or less.

Medium-heat appliance. Any appliance in which the products of combustion at the point of entrance to the flue under normal operating conditions have a temperature of more than 1,000°F ([538] 537.8°C), but not greater than 2,000°F ([1093] 1093.3°C).

APPLIANCE, VENTED. An appliance designed and installed in such a manner that all of the products of combustion are conveyed directly from the appliance to the outdoor atmosphere through an approved chimney or vent system.

~~[APPROVED. In reference to construction documents, the determination by the department after full examination that submitted construction documents comply with this code and other applicable laws and rules. In reference to materials, the determination by the commissioner that material is acceptable for its intended use. See Section 28-101.5 of the *Administrative Code*.]~~

~~[APPROVED AGENCY. An established and recognized agency, or other qualified person, engaged in conducting tests or furnishing inspection services, when approved pursuant to department rules as qualified to perform or witness identified testing or inspection services. See Chapter 1 of Title 28 of the *Administrative Code*.]~~

~~[APPROVED INSPECTION AGENCY. An approved agency that is approved by the department as qualified to perform one or more of the inspections required by this code. See Chapter 1 of Title 28 of the *Administrative Code*.]~~

~~[APPROVED TESTING AGENCY. An approved agency that is approved by the department as qualified to test and evaluate the performance of one or more of the materials regulated in their use by this code. Such term shall include, when approved pursuant to department rules, a third party testing or certification agency, evaluation agency, testing laboratory, testing service, licensed concrete testing laboratory, or other entity concerned with product evaluation. See Chapter 1 of Title 28 of the *Administrative Code*.]~~

~~[ARCHITECT. A person licensed and registered to practice the profession of architecture under the *Education Law of the State of New York*.]~~

AUTOMATIC BOILER. Any class of boiler that is equipped with the controls and limit devices specified in Chapter 10.

BATHROOM. A room containing a bathtub, shower, spa or similar bathing fixture.

BOILER, HIGH-PRESSURE. An appliance [(equipment)] for supplying steam or hot water that, for a steam boiler, operates at a pressure of more than 15 psig ([103] 103.4 kPa gauge), and for a

hot water boiler, operates at a pressure exceeding 160 psig ([1103] 1103.2 kPa gauge) or at a temperature exceeding 250°F ([121] 121.1°C).

BOILER, LOW-PRESSURE. A self-contained appliance for supplying steam or hot water as follows:

Hot water heating boiler. A boiler in which no steam is generated, from which hot water is circulated for heating purposes and then returned to the boiler, and that operates at water pressures not exceeding 160 pounds per square inch gauge (psig) ([1103] 1103.2 kPa gauge) and at water temperatures not exceeding 250°F ([121] 121.1°C) at or near the boiler outlet.

Hot water supply boiler. A boiler, completely filled with water, which furnishes hot water to be used externally to itself, and that operates at water pressures not exceeding 160 psig ([1103] 1103.2 kPa gauge) and at water temperatures not exceeding 250°F ([121] 121.1°C) at or near the boiler outlet.

Steam heating boiler. A boiler in which steam is generated and that operates at a steam pressure not exceeding 15 psig ([103] 103.4 kPa gauge).

BOILER ROOM. A room primarily utilized for the installation of a boiler.

BRAZED JOINT. A gas-tight joint obtained by the joining of metal parts with metallic mixtures or alloys ~~[which]~~ that melt at a temperature above 1,000°F ([538] 537.8°C), but lower than the melting temperature of the parts to be joined.

BRAZING. A ~~[metal-joining]~~ metal-joining process wherein coalescence is produced by the use of a nonferrous filler metal having a melting point above 1,000°F ([538]] 537.8°C), but lower than that of the base metal being joined. The filler material is distributed between the closely fitted surfaces of the joint by capillary attraction.

BREATHING ZONE. The region within an occupied space between planes 3 and 72 inches ([76] 76.2 and [1829] 1828.8 mm) above the floor and more than 2 feet ([610] 609.6 mm) from the walls of the space or from fixed air-conditioning equipment.

BTU. Abbreviation for British thermal unit, which is the quantity of heat required to raise the temperature of 1 pound ([454] 453.6 g) of water 1°F ([0.56] -17.22°C) (1 Btu = 1055 J).

~~**[BUILDING.]** Any structure used or intended for supporting or sheltering any use or occupancy. The term shall be construed as if followed by the phrase “structure, premises, lot or part thereof” unless otherwise indicated by the text. See Section 28-101.5 of the *Administrative Code*.~~

CEILING RADIATION DAMPER. A listed device installed in a ceiling membrane of a fire-resistance-rated floor/ceiling or roof/ceiling assembly to limit automatically the radiative heat transfer through an air inlet/outlet opening. [-]

CHIMNEY. A primarily vertical structure containing one or more flues [~~for the purpose of carrying gaseous products of combustion and air~~] used to remove products of combustion from [a] fuel-burning [appliance to the outdoor atmosphere] appliances, refuse incineration, or industrial processes.

Factory-built chimney. A listed and labeled chimney composed of factory-made components, assembled in the field in accordance with manufacturer's instructions and the conditions of the listing.

Masonry chimney. A field-constructed chimney composed of solid masonry units, bricks, stones or concrete.

Metal chimney. A field-constructed chimney composed of metal.

CHIMNEY CONNECTOR. A pipe that connects a fuel-burning appliance to a chimney.

CLEARANCE. The minimum distance through air measured between the heat-producing surface of the mechanical appliance, device or equipment and the surface of the combustible material or assembly.

CLOSED COMBUSTION [~~SOLID FUEL-BURNING APPLIANCE~~] SOLID FUEL-BURNING APPLIANCE. A heat-producing appliance that employs a combustion chamber that [~~has~~ ~~no~~] does not have openings other than the flue collar, fuel charging door and adjustable openings provided to control the amount of combustion air that enters the combustion chamber.

CLOTHES DRYER. An appliance used to dry wet laundry by means of heat. [~~Dryer classifications are as follows:~~]

~~[Type 1. Factory built package, multiple production. Primarily used in family living environment. Usually the smallest unit physically and in function output.]~~

~~[Type 2. Factory built package, multiple production. Used in business with direct intercourse of the function with the public. Not designed for use in individual family living environment.]~~

COMBINATION FIRE/SMOKE DAMPER. A listed device installed in ducts and air transfer openings designed to close automatically upon the detection of heat and resist the passage of flame and smoke. The device is installed to operate automatically, be controlled by a smoke detection system, and where required, is capable of being positioned from a fire command center.

COMBUSTIBLE ASSEMBLY. Wall, floor, ceiling or other assembly constructed of one or more component materials that are not defined as noncombustible.

COMBUSTIBLE [~~LIQUIDS~~] LIQUID. [~~Any liquids having a closed cup flash point at or above 100°F (38°C), and that are divided into the following classifications] For the purposes of transportation, a combustible liquid as defined in the regulations of the United States Department of Transportation, as set forth in 49 CFR 173.120. For all other purposes, a liquid, other than a compressed gas or cryogenic fluid, having a closed cup flash point at or above 100°F (37.8°C) classified as follows:~~

Class II. Liquids having a closed cup flash ~~[points]~~ point at or above 100°F (~~[38]~~37.8°C) and below 140°F (60°C). **Class IIIA.** Liquids having a closed cup flash ~~[points]~~ point at or above 140°F (60°C) and below 200°F (~~[93]~~ 93.3°C). **Class IIIB.** Liquids having a closed cup flash ~~[points]~~ point at or above 200°F (~~[93]~~ 93.3°C).

COMBUSTIBLE MATERIAL. Any material not defined as noncombustible.

COMBUSTION. In the context of this code, refers to the rapid oxidation of fuel accompanied by the production of heat or heat and light.

COMBUSTION AIR. Air necessary for complete combustion of a fuel, including theoretical air and excess air.

COMBUSTION CHAMBER. The portion of an appliance within which combustion occurs.

COMBUSTION PRODUCTS. Constituents resulting from the combustion of a fuel with the oxygen of the air, including the inert gases, but excluding excess air.

COMMERCIAL COOKING APPLIANCES. Appliances used in a commercial food service establishment for heating or cooking food and which produce grease vapors, steam, fumes, smoke or odors that are required to be removed through a local exhaust ventilation system. Such appliances include deep fat fryers; upright broilers; griddles; broilers; steam-jacketed kettles; hot-top ranges; under-fired broilers (charbroilers); ovens; barbecues; rotisseries; and similar appliances. For the purpose of this definition, a food service establishment shall include any building or a portion thereof used for the preparation and serving of food.

COMMERCIAL COOKING RECIRCULATING SYSTEM. Self-contained system consisting of the exhaust hood, the cooking equipment, the filters and the fire suppression system. The system is designed to capture cooking vapors and residues generated from commercial cooking equipment. The system removes contaminants from the exhaust air and recirculates the air to the space from which it was withdrawn.

COMMERCIAL KITCHEN EXHAUST HOODS.

Backshelf ~~[Hood]~~ hood. A backshelf hood is also referred to as a low-proximity hood, or as a sidewall hood where wall mounted. Its front lower lip is low over the appliance(s) and is “set back” from the front of the appliance(s). It is always closed to the rear of the appliances by a panel where free-standing, or by a panel or wall where wall mounted, and its height above the cooking surface varies. (This style of hood can be constructed with partial end panels to increase its effectiveness in capturing the effluent generated by the cooking operation).

Double island canopy hood. A double island canopy hood is placed over back to back appliances or appliance lines. It is open on all sides and overhangs both fronts and the sides of the appliance(s). It could have a wall panel between the backs of the appliances. (The fact that exhaust air is drawn from both sides of the double canopy to meet in the center causes each side of this hood to emulate a wall canopy hood, and thus it functions much the same with or without an actual wall panel between the backs of the appliances).

Eyebrow hood. An eyebrow hood is mounted directly to the face of an appliance, such as an oven and dishwasher, above the opening(s) or door(s) from which effluent is emitted, extending past the sides and overhanging the front of the opening to capture the effluent.

Pass-over hood. A pass-over hood is a free-standing form of a backshelf hood constructed low enough to pass food over the top.

Single island canopy hood. A single island canopy hood is placed over a single appliance or appliance line. It is open on all sides and overhangs the front, rear [7] and sides of the appliance(s). A single island canopy is more susceptible to cross drafts and requires a greater exhaust air flow than an equivalent sized wall-mounted canopy to capture and contain effluent generated by the cooking operation(s).

Wall canopy hood. A wall canopy hood is mounted against a wall above a single appliance or line of appliance(s), or it could be free-standing with a back panel from the rear of the appliances to the hood. It overhangs the front and sides of the appliance(s) on all open sides. The wall acts as a back panel, forcing the makeup air to be drawn across the front of the cooking equipment, thus increasing the effectiveness of the hood to capture and contain effluent generated by the cooking operation(s).

~~[COMMISSIONER. The Commissioner of Buildings of the City of New York or his or her duly authorized representative. See Section 28-101.5 of the *Administrative Code*.]~~

COMPENSATING HOODS. Compensating hoods are those having integral (built-in) makeup air supply. The makeup air supply for such hoods is generally supplied from: short-circuit flow from inside the hood, air curtain flow from the bottom of the front face, and front face discharge from the outside front wall of the hood. The compensating makeup airflow can also be supplied from the rear or side of the hood, or the rear, front or sides of the cooking equipment. The makeup air flow can be one or a combination of methods.

COMPRESSOR. A specific machine, with or without accessories, for compressing a gas.

COMPRESSOR, POSITIVE DISPLACEMENT. A compressor in which increase in pressure is attained by changing the internal volume of the compression chamber.

COMPRESSOR UNIT. A compressor with its prime mover and accessories.

CONCEALED LOCATION. A location that cannot be accessed without damaging permanent parts of the building structure or finished surface. Spaces above, below or behind readily removable panels or doors shall not be considered as concealed.

CONDENSATE. The liquid that condenses from a gas (including flue gas) caused by a reduction in temperature or increase in pressure.

CONDENSER. A heat exchanger designed to liquefy refrigerant vapor by removal of heat.

CONDENSING UNIT. A specific refrigerating machine combination for a given refrigerant, consisting of one or more power-driven compressors, condensers and, where required, liquid receivers [~~(when required)~~], and the regularly furnished accessories.

CONDITIONED SPACE. ~~[An area, room or space being heated or cooled by any equipment or appliance]~~ An area or room within a building that is within the thermal envelope of a building that is directly or indirectly heated or cooled using fossil fuel or electricity as the energy source. Spaces that are indirectly heated or cooled where they communicate through openings with conditioned spaces, where they are separated from conditioned spaces by uninsulated walls, floors or ceilings, or where they contain uninsulated ducts, piping or other sources of heating or cooling using fossil fuel or electricity.

CONFINED SPACES. A space having a volume less than 50 cubic feet per 1,000 British thermal units per hour (Btu/h) (4.8 m³/kW) of the aggregate input rating of all appliances installed in that space.

~~**CONSTRUCTION DOCUMENTS.** Plans and specifications and other written, graphic and pictorial documents, prepared or assembled for describing the design, location, physical characteristics and other elements of the project necessary for obtaining a building permit. See Section 28-101.5 of the *Administrative Code*~~

CONTROL. A manual or automatic device designed to regulate the gas, air, water or electrical supply to, or operation of, a mechanical system.

CONVERSION BURNER. A burner designed to supply gaseous fuel to an appliance originally designed to utilize another fuel.

COOKING APPLIANCE. See “Commercial cooking appliances.”

DAMPER. A manually or automatically controlled device to regulate draft or the rate of flow of air or combustion gases.

Volume damper. A device that ~~[, when installed,]~~ will restrict, retard or direct the flow of air in a duct, or the products of combustion in a heat-producing appliance, its vent connector, vent or chimney therefrom.

DECORATIVE SHROUD. A listed, partial, noncombustible enclosure for aesthetic purposes that is installed at the termination of a venting system that surrounds or conceals ~~[the]~~ a factory-built chimney system or vent cap.

DESIGN FLOOD ELEVATION. Refer to Section G201.2 of Appendix G of the *New York City Building Code*.

DESIGN WORKING PRESSURE. The maximum allowable working pressure for which a specific part of a system is designed.

DIRECT REFRIGERATION SYSTEM. A system in which the evaporator or condenser of the refrigerating system is in direct contact with the air or other substances to be cooled or heated.

DIRECT-VENT APPLIANCES. Appliances that are constructed and installed so that all air for combustion is derived directly from the outdoor atmosphere and all flue gases are discharged directly to the outdoor atmosphere.

DISCRETE PRODUCT. Products that are non-continuous, individual, distinct pieces such as, but not limited to, electrical, plumbing and mechanical products and duct straps, duct fittings, duct registers and pipe hangers.

DRAFT. The pressure difference existing between the appliance or any component part and the atmosphere, that causes a continuous flow of air and products of combustion through the gas passages of the appliance to the atmosphere.

Induced draft. The pressure difference created by the action of a fan, blower or ejector, that is located between the appliance and the chimney or vent termination.

Natural draft. The pressure difference created by a vent or chimney because of its height, and the temperature difference between the flue gases and the atmosphere.

DRIP. The container placed at a low point in a system of piping to collect condensate and from which the condensate is removable.

DRY CLEANING SYSTEMS. Dry cleaning plants or systems are classified as follows:

Type I. Those systems using Class I flammable liquid solvents having a flash point below 100°F ([38]37.8°C).

Type II. Those systems using Class II combustible liquid solvents having a flash point at or above 100°F ([38] 37.8°C) and below 140°F (60°C).

Type III. Those systems using Class III combustible liquid solvents having a flash point at or above 140°F (60°C).

Types IV and V. Those systems using Class IV nonflammable liquid solvents.

DUCT. A tube or conduit utilized for conveying air. The air passages of self-contained systems are not to be construed as air ducts.

DUCT FURNACE. A warm-air furnace or heater normally installed in an air distribution duct to supply warm air for heating. This definition shall apply only to a warm-air heating appliance that, for air circulation, depends on a blower not furnished as part of the furnace.

DUCT SYSTEM. A continuous passageway for the transmission of air that, in addition to ducts, includes duct fittings, dampers, plenums, fans and accessory air-handling equipment and appliances.

DUCTLESS MINI-SPLIT SYSTEM. A heating and cooling system that is comprised of one or multiple indoor evaporator/air-handling units and an outdoor condensing unit that is connected by refrigerant piping and electrical wiring. A ductless mini-split system is capable of cooling or heating one or more rooms without the use of a traditional ductwork system.

DWELLING. A building or structure [which] that is occupied in whole or in part as the home, residence or sleeping place of one or more families.

DWELLING UNIT. A single unit consisting of one or more habitable rooms and occupied or arranged to be occupied as a unit separate from all other units within a dwelling.

ELECTRIC HEATING APPLIANCE. An appliance that produces heat energy to create a warm environment by the application of electric power to resistance elements, refrigerant compressors or dissimilar material junctions.

ENERGY RECOVERY VENTILATION SYSTEM. Systems that employ air-to-air heat exchangers to recover energy from or reject energy to exhaust air for the purpose of preheating, precooling, humidifying or dehumidifying outdoor ventilation air prior to supplying such air to a space, either directly or as part of an HVAC system.

~~[ENGINEER. A person licensed and registered to practice the profession of engineering under the Education Law of the State of New York.]~~

ENGINEERED SMOKE CONTROL SYSTEM. Refer to Smoke Control System in Section 909 of the *New York City Building Code*.

ENVIRONMENTAL AIR. Air that is ~~[supplied, returned, recirculated, or exhausted from a space for the purpose of modifying the existing atmosphere within a building]~~ conveyed to or from occupied areas through ducts that are not part of the heating or air-conditioning system, such as ventilation for human usage, domestic kitchen range exhaust, bathroom exhaust, and domestic clothes dryer exhaust.

EQUIPMENT. All piping, ducts, vents, control devices and other components of systems other than appliances ~~[which]~~ that are permanently installed and integrated to provide control of environmental conditions for buildings. This definition shall also include other systems specifically regulated in this code.

EQUIPMENT, EXISTING. Any equipment regulated by this code ~~[which]~~ that was legally installed prior to the effective date of this code, or for which a permit to install has been issued.

EVAPORATIVE COOLER. A device used for reducing the sensible heat of air for cooling by the process of evaporation of water into an airstream.

EVAPORATIVE COOLING SYSTEM. The equipment and appliances intended or installed for the purpose of environmental cooling by an evaporative cooler from which the conditioned air is distributed through ducts or plenums to the conditioned area.

EVAPORATOR. That part of the system in which liquid refrigerant is vaporized to produce refrigeration.

EXCESS AIR. The amount of air provided in addition to theoretical air to achieve complete combustion of a fuel, thereby preventing the formation of dangerous products of combustion.

EXFILTRATION. Uncontrolled outward air leakage from conditioned spaces through unintentional openings in ceilings, floors and walls to unconditioned spaces or the outdoors caused by pressure differences across these openings resulting from wind, the stack effect created by temperature

differences between indoors and outdoors, and imbalances between supply, return and exhaust airflow rates.

EXHAUST SYSTEM. An assembly of connected ducts, plenums, fittings, registers, grilles and hoods through which air is conducted from a space or spaces and exhausted to the outdoor atmosphere.

EXTRA-HEAVY-DUTY COOKING APPLIANCE. Extra-heavy-duty cooking appliances [~~include appliances utilizing~~] are those utilizing open flame combustion of solid fuel such as wood, charcoal, briquettes, and mesquite to provide all or part of the heat source for cooking at any time.

FIELD ERECTED BOILER. A boiler where the pressure vessel is constructed partially or totally in the field. Field erected boilers do not include cast iron sectional boilers [~~which~~] that are considered factory built since each section is a separate pressure vessel.

FIRE DAMPER. A listed device installed in ducts and air transfer openings designed to close automatically upon detection of heat and to restrict the passage of flame. Fire dampers are classified for use in either static systems that will automatically shut down in the event of a fire, or in dynamic systems that continue to operate during a fire. A dynamic fire damper is tested and rated for closure under elevated temperature airflow.

FIREPLACE. An assembly consisting of a hearth and fire chamber of noncombustible material and provided with a chimney, for use with solid fuels. A fireplace shall be considered an appliance.

Factory-built fireplace. A listed and labeled fireplace and chimney system composed of factory-made components, and assembled in the field in accordance with manufacturer's instructions and the conditions of the listing.

Masonry fireplace. [~~A field-constructed fireplace composed of solid masonry units, bricks, stones or concrete.~~] A hearth and fire chamber of solid masonry units such as bricks, stones, listed masonry units or reinforced concrete, provided with a suitable chimney.

FIREPLACE STOVE. A free-standing chimney-connected solid-fuel-burning heater, designed to be operated with the fire chamber doors in either the open or closed position.

FLAME SAFEGUARD. A device that will automatically shut off the fuel supply to a main burner or group of burners when the means of ignition of such burners becomes inoperative, and when flame failure occurs on the burner or group of burners.

FLAME SPREAD INDEX. [~~The numerical value assigned to~~] A comparative measure, expressed as a dimensionless number, derived from visual measurements of the spread of flame versus time for a material tested in accordance with ASTM E 84 or UL 723.

FLAMMABILITY CLASSIFICATION. Refrigerants shall be assigned to one of the three classes—1, 2 or 3—in accordance with ASHRAE 34.

FLAMMABLE LIQUIDS. Any liquid that has a closed cup flash point below 100°F ([~~38~~] 37.8°C), and has a vapor pressure not exceeding 40 [~~psia~~] psi ([~~276~~] 275.8 kPa) at 100°F ([~~38~~] 37.8°C).

Flammable liquids shall be known as Class I liquids and shall be divided into the following classifications:

Class IA. Liquids having a closed cup flash point below 73°F ([23] 22.8°C) and a boiling point below 100°F ([38] 37.8°C).

Class IB. Liquids having a closed cup flash point below 73°F ([23] 22.8°C) and a boiling point at or above 100°F ([38] 37.8°C).

Class IC. Liquids having a closed cup flash point at or above 73°F ([23] 22.8°C) and below 100°F ([38] 37.8°C).

FLAMMABLE VAPOR OR FUMES. Mixtures of gases in air at concentrations equal to or greater than the LFL and less than or equal to the upper flammability limit (UFL).

FLASH POINT. The minimum temperature at which the application of a test flame causes the vapors of a portion of the sample to ignite under the conditions specified by the test procedures and apparatus. The flash point of a liquid shall be determined in accordance with ASTM D 56, ASTM D 93 or ASTM D 3278.

FLEXIBLE AIR CONNECTOR. A conduit for transferring air between an air duct or plenum and an air terminal unit or between an air duct or plenum and an air inlet or air outlet. Such conduit is limited in its use, length and location.

FLOOR AREA, NET. The actual occupied area, not including unoccupied accessory areas or thicknesses of walls.

FLOOR FURNACE. A completely self-contained furnace suspended from the floor of the space being heated, taking air for combustion from outside such space and with means for observing flames and lighting the appliance from such space.

Fan type. A floor furnace equipped with a fan that provides the primary means for circulating air.

Gravity type. A floor furnace depending primarily on circulation of air by gravity. This classification shall also include floor furnaces equipped with booster-type fans that do not materially restrict free circulation of air by gravity flow when such fans are not in operation.

FLUE. A passageway within a chimney or vent through which gaseous combustion products pass.

FLUE CONNECTION (BREECHING). A passage for conducting the products of combustion from a fuel-fired appliance to the vent or chimney (see also “Chimney connector” and “Vent connector”).

FLUE GASES. Products of combustion [~~and~~] plus excess air in fireplace and appliance flues, or heat exchangers.

FLUE LINER (LINING). A system or material used to form the inside surface of a flue in a chimney or vent, for the purpose of protecting the surrounding structure from the effects of combustion products and conveying combustion products without leakage to the atmosphere.

FUEL GAS. A natural gas, manufactured gas, liquefied petroleum gas or a mixture of these gases.

FUEL OIL. Kerosene or any hydrocarbon oil having a flash point not less than 100°F ([38] 37.8°C).

FUEL-OIL PIPING SYSTEM. A closed piping system that connects a combustible liquid from a source of supply to a fuel-oil-burning appliance.

FURNACE. A completely self-contained heating unit that is designed to supply heated air to spaces remote from or adjacent to the appliance location.

FURNACE ROOM. A room primarily utilized for the installation of fuel-burning, space-heating and water-heating appliances other than boilers (see also “Boiler room”).

FUSIBLE PLUG. A device arranged to relieve pressure by operation of a fusible member at a predetermined temperature.

GROUND SOURCE HEAT PUMP LOOP SYSTEM. Piping buried in horizontal or vertical excavations or placed in a body of water for the purpose of transporting heat transfer liquid to and from a heat pump. Included in this definition are closed loop systems in which the liquid is recirculated and open loop systems in which the liquid is drawn from a well or other source.

HAZARDOUS LOCATION. Any location considered to be a fire hazard for flammable vapors, dust, combustible fibers or other highly combustible substances. The location is not necessarily categorized in the *New York City Building Code* as a high-hazard use group classification.

HEAT EXCHANGER. A device that transfers heat from one medium to another.

HEAT PUMP. A refrigeration system that extracts heat from one substance and transfers it to another portion of the same substance or to a second substance at a higher temperature for a beneficial purpose.

HEAT TRANSFER LIQUID. The operating or thermal storage liquid in a mechanical system, including water or other liquid base, and additives at the concentration present under operating conditions used to move heat from one location to another. Refrigerants are not included as heat transfer liquids.

HEAVY-DUTY COOKING APPLIANCE. Heavy-duty cooking appliances include electric under-fired broilers, electric chain (conveyor) broilers, gas under-fired broilers, gas chain (conveyor) broilers, gas open-burner ranges (with or without oven), electric and gas wok ranges, smokers, smoker ovens, and electric and gas over-fired (upright) broilers and salamanders.

HIGH-PROBABILITY SYSTEMS. A refrigeration system in which the basic design or the location of components is such that a leakage of refrigerant from a failed connection, seal or component will enter an occupancy classified area, other than the machinery room.

HIGH-SIDE PRESSURE. The parts of a refrigerating system subject to condenser pressure.

HOOD. An air-intake device used to capture by entrapment, impingement, adhesion or similar means, grease, moisture, heat and similar contaminants before they enter a duct system.

Type I. A kitchen hood for collecting and removing grease vapors and smoke. Such hoods are equipped with a fire suppression system.

Type II. A general kitchen hood for collecting and removing steam, vapor, heat, odors [~~and~~] and products of combustion.

HOOD, FUME. A hood used for hazardous exhaust systems.

HYDROGEN GENERATING APPLIANCE. A self-contained package or factory-matched packages of integrated systems for generating gaseous hydrogen. Hydrogen generating appliances utilize electrolysis, reformation, chemical, or other processes to generate hydrogen.

IGNITION SOURCE. A flame, spark or hot surface capable of igniting flammable vapors or fumes. Such sources include appliance burners, burner ignitors and electrical switching devices.

IMMEDIATELY DANGEROUS TO LIFE OR HEALTH (IDLH). The concentration of airborne contaminants that poses a threat of death, immediate or delayed permanent adverse health effects, or effects that could prevent escape from such an environment. This contaminant concentration level is established by the National Institute of Occupational Safety and Health (NIOSH) based on both toxicity and flammability. It is generally expressed in parts per million by volume (ppm v/v) or milligrams per cubic meter (mg/m³).

INDIRECT REFRIGERATION SYSTEM. A system in which a secondary coolant cooled or heated by the refrigerating system is circulated to the air or other substance to be cooled or heated. Indirect systems are distinguished by the [~~method~~] following methods of application [~~shown below~~]:

Closed system. A system in which a secondary fluid is either cooled or heated by the refrigerating system and then circulated within a closed circuit in indirect contact with the air or other substance to be cooled or heated.

Double-indirect open-spray system. A system in which the secondary substance for an indirect open-spray system is heated or cooled by an intermediate coolant circulated from a second enclosure.

Open-spray system. A system in which a secondary coolant is cooled or heated by the refrigerating system and then circulated in direct contact with the air or other substance to be cooled or heated.

Vented closed system. A system in which a secondary coolant is cooled or heated by the refrigerating system and then passed through a closed circuit in the air or other substance to be cooled or heated, except that the evaporator or condenser is placed in an open or appropriately vented tank.

INTEGRAL VENT APPLIANCES. Appliances designed for outdoor installation that have built-in natural or mechanical venting means and are constructed and installed so that all air for combustion is derived from the outdoor atmosphere and all flue gases are discharged to the outdoor atmosphere through an integral vent termination.

INFILTRATION. Uncontrolled inward air leakage to conditioned spaces through unintentional openings in ceilings, floors and walls from unconditioned spaces or the outdoors caused by pressure differences across these openings resulting from wind, the stack effect created by temperature differences between indoors and outdoors, and imbalances between supply, return and exhaust airflow rates.

INTERLOCK. A device actuated by another device with which it is directly associated, to govern succeeding operations of the same or allied devices. A circuit in which a given action cannot occur until after one or more other actions have taken place.

JOINT, FLANGED. A joint made by bolting together a pair of flanged ends.

JOINT, FLARED. A metal-to-metal compression joint in which a conical spread is made on the end of a tube that is compressed by a flare nut against a mating flare.

JOINT, MECHANICAL. ~~[A general form of gas-tight joints obtained by the joining of metal parts through a positive holding mechanical construction, such as flanged joint, screwed joint or flared joint.]~~ A connection between pipes, fittings, or pipes and fittings, which is neither screwed, caulked, threaded, soldered, solvent cemented, brazed nor welded. Also, a joint in which compression is applied along the centerline of the pieces being joined. Some joints are part of a coupling, fitting or adapter. These joints include both the press-type and push-fit joining systems.

JOINT, PLASTIC ADHESIVE. A joint made in thermoset plastic piping by the use of an adhesive substance ~~[which]~~ that forms a continuous bond between the mating surfaces without dissolving either one of them.

JOINT, PLASTIC HEAT FUSION. A joint made in thermoplastic piping by heating the parts sufficiently to permit fusion of the materials when the parts are pressed together.

JOINT, PLASTIC SOLVENT CEMENT. A joint made in thermoplastic piping by the use of a solvent or solvent cement ~~[which]~~ that forms a continuous bond between the mating surfaces.

JOINT, SOLDERED. A gas-tight joint obtained by the joining of metal parts with metallic mixtures of alloys ~~[which]~~ that melt at temperatures between 400°F (~~[204]~~ 204.4°C) and 1,000°F (~~[538]~~ 537.8°C).

JOINT, WELDED. A gas-tight joint obtained by the joining of metal parts in molten state.

~~[**LABEL.** Identification applied to material by the manufacturer or an approved agency that contains the name of the manufacturer, the function and performance characteristics of the material, and the name and identification of the approved agency that conducted the evaluation of a representative sample of such material.]~~

~~[**LABELED.** Material or product to which has been attached a label, symbol or other identifying mark of the manufacturer that contains the name of the manufacturer, the function and performance characteristics of the product or material, and the name and identification of an approved agency and that indicates that a representative sample of the material has been tested and evaluated by an~~

~~approved agency for compliance with nationally recognized standards or tests to determine suitable usage in a specified manner. See Section 28-101.5 of the Administrative Code.]~~

LIGHT-DUTY COOKING APPLIANCE. Light-duty cooking appliances include gas and electric ovens (including standard, bake, roasting, revolving, retherm, convection, combination convection/steamer, countertop conveyORIZED baking/finishing, deck and pastry), electric and gas steam-jacketed kettles, electric and gas pasta cookers, electric and gas compartment steamers (both pressure and atmospheric) and electric and gas cheesemelters.

LIMIT CONTROL. A device responsive to changes in pressure, temperature or level for turning on, shutting off or throttling the gas supply to an appliance.

LIMITED CHARGE SYSTEM. A system in which, with the compressor idle, the design pressure will not be exceeded when the refrigerant charge has completely evaporated.

LIMITED COMBUSTIBLE MATERIAL. A building construction material not complying with the definition of noncombustible material, which, in the form in which it is used, has a potential heat value not exceeding 3,500 Btu/lb (8141 kJ/kg) and complies with the following: Materials, in the form and thickness used, having neither a flame spread index/rating greater than 25 nor evidence of continued combustion, and of such composition that surfaces that would be exposed by cutting through the material on any place would have neither a flame spread index/rating greater than 25 nor evidence of continued progressive combustion. Materials subject to increase in combustibility or flame spread index/rating beyond the limits herein established through the effects of age, moisture, or other atmospheric condition shall be considered combustible.

~~**[LISTED.** Material identified in a list published by an approved agency that maintains periodic inspection of production of listed material or periodic evaluation services and whose listing states either that the material meets identified nationally recognized standards or has been tested and found suitable for a specified purpose when installed in accordance with the manufacturer's installation instructions. See Section 28-101.5 of the Administrative Code.]~~

LIVING SPACE. Space within a dwelling unit utilized for living, sleeping, eating, cooking, bathing, washing and sanitation purposes.

LOWER EXPLOSIVE LIMIT (LEL). See "LFL."

LOWER FLAMMABLE LIMIT (REFRIGERANT) (LFL). The minimum concentration of refrigerant that is capable of propagating a flame through a homogeneous mixture of refrigerant and air.

LOWER FLAMMABLE LIMIT (LFL). The minimum concentration of vapor in air at which propagation of flame will occur in the presence of an ignition source. The LFL is sometimes referred to as LEL or lower explosive limit.

~~**[LOW-PRESSURE HOT-WATER-HEATING BOILER.** A boiler furnishing hot water at pressures not exceeding 160 psig (1103 kPa) and at temperatures not exceeding 250°F (121°C).]~~

~~**[LOW-PRESSURE STEAM-HEATING BOILER.** A boiler furnishing steam at pressures not exceeding 15 psig (103 kPa).]~~

LOW-PROBABILITY SYSTEMS. A refrigeration system in which the basic design or the location of components is such that a leakage of refrigerant from a failed connection, seal or component will not enter an occupancy-classified area, other than the machinery room.

LOW-SIDE PRESSURE. The parts of a refrigerating system subject to evaporator pressure.

MACHINERY ROOM. A room meeting prescribed safety requirements and in which refrigeration systems or components thereof are located (see Sections 1105 and 1106 of this code, and Section [4015.4] 1006.2.2.2 of the *New York City Building Code*).

MECHANICAL DRAFT SYSTEM. A venting system designed to remove flue or vent gases by mechanical means [;] that consists of an induced-draft portion under nonpositive static pressure or a forced-draft portion under positive static pressure.

Forced-draft venting system. A portion of a venting system using a fan or other mechanical means to cause the removal of flue or vent gases under positive static pressure.

Induced-draft venting system. A portion of a venting system using a fan or other mechanical means to cause the removal of flue or vent gases under nonpositive static vent pressure.

Power venting system. A portion of a venting system using a fan or other mechanical means to cause the removal of flue or vent gases under positive static vent pressure.

MECHANICAL EQUIPMENT/APPLIANCE ROOM. A room or space in which nonfuel-fired mechanical equipment and appliances are located.

MECHANICAL EXHAUST SYSTEM. A system for removing air from a room or space by mechanical means.

~~**[MECHANICAL JOINT.** A connection between pipes, fittings, or pipes and fittings, which is neither screwed, caulked, threaded, soldered, solvent cemented, brazed nor welded. Also, a joint in which compression is applied along the centerline of the pieces being joined. Some joints are part of a coupling, fitting or adapter. These joints include both the press-type and push-fit joining systems.]~~

MECHANICAL SYSTEM. A system specifically addressed and regulated in this code and composed of components, devices, appliances and equipment [~~which~~] that become part of the building.

MEDIUM-DUTY COOKING APPLIANCE. Medium-duty cooking appliances include electric discrete element ranges (with or without oven), electric and gas hot-top ranges, electric and gas griddles, electric and gas double-sided griddles, electric and gas fryers (including open deep fat fryers, donut fryers, kettle fryers and pressure fryers), electric and gas conveyor pizza ovens, electric and gas tilting skillets (braising pans) and electric and gas rotisseries.

MODULAR BOILER. A steam or hot-water-heating assembly consisting of a group of individual boilers called modules intended to be installed as a unit [~~with no~~] without intervening stop valves.

Modules are under one jacket or are individually jacketed. The individual modules shall be limited to a maximum input rating of 400,000 Btu/h (117 228 W) gas, 3 gallons per hour (gph) (11.4 L/h) oil, or 115 kW (electric).

NATURAL DRAFT SYSTEM. A venting system designed to remove flue or vent gases under nonpositive static vent pressure entirely by natural draft.

NATURAL VENTILATION. The movement of air into and out of a space through intentionally provided openings, such as windows and doors, or through nonpowered ventilators.

NET OCCUPIABLE FLOOR AREA. The floor area of an occupiable space defined by the inside surfaces of its walls but excluding shafts, column enclosures and other permanently enclosed, inaccessible and unoccupiable areas. Obstructions in the space such as furnishings, display or storage racks and other obstructions, whether temporary or permanent, shall not be deducted from the space area.

NONABRASIVE/ABRASIVE MATERIALS. Nonabrasive particulate in high concentrations, moderately abrasive particulate in low and moderate concentrations, and highly abrasive particulate in low concentrations, such as alfalfa, asphalt, plaster, gypsum and salt.

NONCOMBUSTIBLE MATERIALS. Materials that, when tested in accordance with ASTM E 136, have at least three of four specimens tested meeting all of the following criteria:

1. The recorded temperature of the surface and interior thermocouples shall not at any time during the test rise more than 54°F (~~[30]~~12.2°C) above the furnace temperature at the beginning of the test.
2. There shall not be flaming from the specimen after the first 30 seconds.
3. If the weight loss of the specimen during testing exceeds 50 percent, the recorded temperature of the surface and interior thermocouples shall not at any time during the test rise above the furnace air temperature at the beginning of the test, and there shall not be flaming of the specimen.

~~[**OCCUPANCY.** The purpose or activity for which a building or space is used or is designed, arranged or intended to be used.]~~

OCCUPATIONAL EXPOSURE LIMIT (OEL). The timeweighted average (TWA) concentration for a normal eight-hour workday and a 40-hour workweek to which nearly all workers can be repeatedly exposed without adverse effect, based on the OSHA PEL, ACGIH TLV-TWA, AIHA WEEL, or consistent value.

OCCUPIABLE SPACE. An enclosed space intended for human activities, excluding those spaces intended primarily for other purposes, such as storage rooms and equipment rooms, that are only intended to be occupied occasionally and for short periods of time.

OFFSET (VENT). A combination of approved bends that make two changes in direction bringing one section of the vent out of line but into a line parallel with the other section.

OUTDOOR AIR. Air taken from the outdoors, and therefore not previously circulated through the system.

OUTDOOR OPENING. A door, window, louver or skylight openable to the outdoor atmosphere.

OUTLET, GAS. A threaded connection or bolted flange in a piping system to which a gas-burning appliance is attached.

PANEL HEATING. A method of radiant space heating in which heat is supplied by large heated areas of room surfaces. The heating element usually consists of warm water piping, warm air ducts, or electrical resistance elements embedded in or located behind ceiling, wall or floor surfaces.

PELLET FUEL-BURNING APPLIANCE. A closed-combustion, vented appliance equipped with a fuel-feed mechanism for burning processed pellets of solid fuel of a specified size and composition.

PIPING. Where used in this code, “piping” refers to either pipe or tubing, or both.

Pipe. A rigid conduit of iron, steel, copper, brass or plastic.

Tubing. Semirigid conduit of copper, aluminum, plastic or steel.

PLASTIC, THERMOPLASTIC. A plastic that is capable of being repeatedly softened by increase of temperature and hardened by decrease of temperature.

PLASTIC, THERMOSETTING. A plastic that is capable of being changed into a substantially infusible or insoluble product when cured under application of heat or chemical means.

PLENUM. A compartment or chamber located in one story only to which one or more air ducts are connected and ~~[which]~~ that forms part of the air supply or return system and may be part of the building construction, such as the concealed space above a ceiling.

PORTABLE FUEL CELL APPLIANCE. A fuel cell generator of electricity, which is not fixed in place. A portable fuel cell appliance utilizes a cord and plug connection to a grid-isolated load and has an integral fuel supply.

POWER BOILER. See “Boiler.”

PREMISES. Land, improvements thereon, or any part thereof.

PRESSURE, FIELD TEST. A test performed in the field to prove system tightness.

PRESSURE-LIMITING DEVICE. A pressure-responsive mechanism designed to stop automatically the operation of the pressure-imposing element at a predetermined pressure.

PRESSURE RELIEF DEVICE. A pressure-actuated valve or rupture member designed to relieve excessive pressure automatically.

PRESSURE RELIEF VALVE. A pressure-actuated valve held closed by a spring or other means and designed to relieve pressure automatically in excess of the device’s setting.

PRESSURE VESSELS. Closed containers, tanks or vessels that are designed to contain liquids or gases, or both, under pressure.

PRESSURE VESSELS—REFRIGERANT. Any refrigerant-containing receptacle in a refrigerating system. This does not include evaporators where each separate section does not exceed 0.5 cubic foot (0.014 m³) of refrigerant-containing volume, regardless of the maximum inside dimensions, evaporator coils, controls, headers, pumps and piping.

PROTECTIVE ASSEMBLY (REDUCED CLEARANCE). Any noncombustible assembly that is labeled or constructed in accordance with Table [308.6] 308.4.2 and is placed between combustible materials or assemblies and mechanical appliances, devices or equipment, for the purpose of reducing required airspace clearances. Protective assemblies attached directly to a combustible assembly shall not be considered as part of that combustible assembly.

PURGE. To clear of air, water or other foreign substances.

PUSH-FIT JOINTS. A type of mechanical joint consisting of elastomeric seals and corrosion-resistant tube grippers. [~~Such joints are permanent or removable depending on the design.~~] The joint is made by pushing the pipe into the joint and allowing the grippers to secure the connection.

QUICK-OPENING VALVE. A valve that opens completely by fast action, either manually or automatically controlled. A valve requiring one-quarter round turn or less is considered to be quick opening.

RADIANT HEATER. A heater designed to transfer heat primarily by direct radiation.

READY ACCESS (TO). That which enables a device, fixture, appliance or equipment to be directly reached, without requiring the removal or movement of any panel, door or similar obstruction (see “Access (to)”).

RECEIVER, LIQUID. A vessel permanently connected to a refrigeration system by inlet and outlet pipes for storage of liquid refrigerant.

RECIRCULATED AIR. Air removed from a conditioned space and intended for reuse as supply air.

RECLAIMED REFRIGERANTS. Refrigerants reprocessed to the same specifications as for new refrigerants by means including distillation. Such refrigerants have been chemically analyzed to verify that the specifications have been met. Reclaiming usually implies the use of processes or procedures that are available only at a reprocessing or manufacturing facility.

RECOVERED REFRIGERANTS. Refrigerants removed from a system in any condition without necessarily testing or processing them.

RECYCLED REFRIGERANTS. Refrigerants from which contaminants have been reduced by oil separation, removal of noncondensable gases, and single or multiple passes through devices that reduce moisture, acidity and particulate matter, such as replaceable core filter dryers. These procedures usually are performed at the field job site or in a local service shop.

REFRIGERANT. A substance used for heat transfer in a refrigerating system; the refrigerant absorbs heat and transfers it at a higher temperature and higher pressure, usually with a change of state.

REFRIGERANT SAFETY CLASSIFICATIONS. Groupings that indicate the toxicity and flammability classes in accordance with ASHRAE 34.

REFRIGERATED ROOM OR SPACE. A room or space in which an evaporator or brine coil is located for the purpose of reducing or controlling the temperature within the room or space to below 68°F (20°C).

REFRIGERATING SYSTEM. A combination of interconnected refrigerant-containing parts constituting one closed refrigerant circuit in which a refrigerant is circulated for the purpose of extracting heat.

REFRIGERATION MACHINERY ROOM. See “Machinery room.”

REFRIGERATION SYSTEM, ABSORPTION. A heat-operated, closed-refrigeration cycle in which a secondary fluid (the absorbent) absorbs a primary fluid (the refrigerant) that has been vaporized in the evaporator.

Direct system. A system in which the evaporator is in direct contact with the material or space refrigerated, or is located in air-circulating passages communicating with such spaces.

Indirect system. A system in which a brine coil cooled by the refrigerant is circulated to the material or space refrigerated, or is utilized to cool the air so circulated. Indirect systems are distinguished by the type or method of application.

REFRIGERATION SYSTEM CLASSIFICATION. Refrigeration systems are classified according to the degree of probability that leaked refrigerant from a failed connection, seal or component will enter an occupied area. The distinction is based on the basic design or location of the components.

REFRIGERATION SYSTEM, MECHANICAL. A combination of interconnected refrigeration-containing parts constituting one closed refrigerant circuit in which a refrigerant is circulated for the purpose of extracting heat and in which a compressor is used for compressing the refrigerant vapor.

REFRIGERATION SYSTEM, SELF-CONTAINED. A complete factory-assembled and tested system that is shipped in one or more sections and ~~[has no refrigerant-containing]~~ that does not have refrigerant-containing parts that are joined in the field by other than companion or block valves.

~~[REGISTERED DESIGN PROFESSIONAL. Refer to Chapter 1 of Title 28 of the *New York City Administrative Code*.]~~

~~[RETURN AIR. Air removed from an approved conditioned space or location and recirculated or exhausted outdoors.]~~

RETURN AIR SYSTEM. An assembly of connected ducts, plenums, fittings, registers and grilles through which return air from the space or spaces to be heated or cooled is conducted back to the supply unit or relieved to the outdoors (see also “Supply air system”).

ROOM HEATER, VENTED. A free-standing heating unit burning solid or liquid fuel for direct heating of the space in and adjacent to that in which the unit is located.

SAFETY VALVE. A valve that relieves pressure in a steam boiler by opening fully at the rated discharge pressure. The valve is of the spring-pop type.

SELF-CONTAINED EQUIPMENT. Complete, factory-assembled and tested, heating, air-conditioning or refrigeration equipment installed as a single unit, and having all working parts, complete with motive power, in an enclosed unit of said machinery.

SHAFT. An enclosed space extending through one or more stories of a building, connecting vertical openings in successive floors, or floors and the roof.

SHAFT ENCLOSURE. The walls or construction forming the boundaries of a shaft.

SLEEPING UNIT. A dwelling unit, which may contain either toilet or kitchen facilities but not both. Any sleeping unit housing more than one family shall also be classified as a congregate living unit. The creation of or conversion to sleeping units shall be limited by Section 27-2077 of the *New York City Housing Maintenance Code*.

SMOKE DAMPER. A listed device [~~is~~] installed in ducts and air transfer openings designed to resist the passage of air and smoke. The device is installed to operate automatically, controlled by a smoke detection system, and where required, is capable of being positioned from a fire command center.

SMOKE-DEVELOPED INDEX. [~~A numerical value assigned to~~] A comparative measure, expressed as a dimensionless number, derived from measurements of smoke obscuration versus time for a material tested in accordance with ASTM E 84.

SOLID FUEL (COOKING APPLICATIONS). Applicable to commercial food service operations only, solid fuel is any bulk material such as hardwood, mesquite, charcoal or briquettes that is combusted to produce heat for cooking operations.

SOURCE CAPTURE SYSTEM. A mechanical exhaust system designed and constructed to capture air contaminants at their source and to exhaust such contaminants to the outdoor atmosphere.

STATIONARY FUEL CELL POWER PLANT. A self-contained package or factory-matched package [~~which~~] that constitute an automatically operated assembly of integrated systems for generating useful electrical energy and recoverable thermal energy that is permanently connected and fixed in place.

STOP VALVE. A shutoff valve for controlling the flow of liquid or gases.

STORY. That portion of a building included between the upper surface of a floor and the upper surface of the floor next above, except that the topmost story shall be that portion of a building included between the upper surface of the topmost floor and the ceiling or roof above.

STRENGTH, ULTIMATE. The highest stress level that the component will tolerate without rupture.

SUPPLY AIR. That air delivered to each or any space supplied by the air distribution system or the total air delivered to all spaces supplied by the air distribution system, which is provided for ventilating, heating, cooling, humidification, dehumidification and other similar purposes.

SUPPLY AIR SYSTEM. An assembly of connected ducts, plenums, fittings, registers and grilles through which air, heated or cooled, is conducted from the supply unit to the space or spaces to be heated or cooled (see also “Return air system”).

THEORETICAL AIR. The exact amount of air required to supply oxygen for complete combustion of a given quantity of a specific fuel.

THERMAL RESISTANCE (R). A measure of the ability to retard the flow of heat. The R-value is the reciprocal of thermal conductance.

THIRD-PARTY CERTIFICATION AGENCY. An approved agency operating a product or material certification system that incorporates initial product testing, assessment and surveillance of a manufacturer’s quality control system.

THIRD-PARTY CERTIFIED. Certification obtained by the manufacturer indicating that the function and performance characteristics of a product or material have been determined by testing and ongoing surveillance by an approved third-party certification agency. Assertion of certification is in the form of identification in accordance with the requirements of the third-party certification agency.

THIRD-PARTY TESTED. Procedure by which an approved testing laboratory provides documentation that a product, material or system conforms to specified requirements.

~~[TLV-TWA (]~~THRESHOLD LIMIT VALUE-TIME WEIGHTED AVERAGE~~)] (TLV-TWA). The time-weighted average concentration of a refrigerant or other chemical in air for a normal 8-hour workday and a 40-hour workweek, to which nearly all workers are repeatedly exposed, day after day, without adverse effects, as adopted by the American Conference of Government Industrial Hygienists (ACGIH).~~

TOILET ROOM. A room containing a water closet and, frequently, a lavatory, but not a bathtub, shower, spa or similar bathing fixture.

TOXICITY CLASSIFICATION. Refrigerants shall be classified for toxicity [to] in one of two classes in accordance with ASHRAE 34.

TRANSITION FITTINGS, PLASTIC TO STEEL. An adapter for joining plastic pipe to steel pipe. The purpose of this fitting is to provide a permanent, pressure-tight connection between two materials [~~which~~] that cannot be joined directly one to another.

UNCONFINED SPACE. A space having a volume not less than 50 cubic feet per 1,000 Btu/h (4.8m³/kW) of the aggregate input rating of all appliances installed in that space. Rooms

communicating directly with the space in which the appliances are installed, through openings not furnished with doors, are considered a part of the unconfined space.

UNIT HEATER. A self-contained appliance of the fan type, designed for the delivery of warm air directly into the space in which the appliance is located.

UNUSUALLY TIGHT CONSTRUCTION. Construction meeting all of the following requirements:

1. Walls exposed to the outside atmosphere having a continuous water vapor retarder with a rating of 1 perm ($57 \text{ ng/s} \cdot \text{m}^2 \cdot \text{Pa}$) or less with openings gasketed or sealed; and
2. Openable windows and doors meeting the air leakage requirements of the *New York City Energy Conservation Code*, Section 502.4.1; and
3. Caulking or sealants are applied to areas, such as joints around window and door frames, between sole plates and floors, between wall-ceiling joints, between wall panels, at penetrations for plumbing, electrical and gas lines, and at other openings.

VENT. A pipe or other conduit composed of factory-made components, containing a passageway for conveying combustion products and air to the atmosphere, listed and labeled for use with a specific type or class of appliance.

Pellet vent. A vent listed and labeled for use with listed pellet-fuel-burning appliances.

Type L vent. A vent listed and labeled for use with the following:

~~[1.]~~Oil-burning appliances that are listed for use with Type L vents.

~~[2. Gas-fired appliances that are listed for use with Type B vents.]~~

VENT CONNECTOR. The pipe that connects an approved fuel-fired appliance to a vent.

VENT DAMPER DEVICE, AUTOMATIC. A device intended for installation in the venting system, in the outlet of an individual automatically operated fuel-burning appliance that is designed to open the venting system automatically when the appliance is in operation and to close off the venting system automatically when the appliance is in a standby or shutdown condition.

VENTED ROOM HEATER. A vented self-contained, free-standing, nonrecessed appliance for furnishing warm air to the space in which it is installed, directly from the heater without duct connections.

VENTILATION. The natural or mechanical process of supplying conditioned or unconditioned air to, or removing such air from, any space.

VENTILATION AIR. That portion of supply air that comes from the outside (outdoors), plus any recirculated air that has been treated to maintain the desired quality of air within a designated space.

VENTING SYSTEM. A continuous open passageway from the flue collar of an appliance to the outside atmosphere for the purpose of removing flue or vent gases. A venting system is usually composed of a vent or a chimney and vent connector, if used, assembled to form the open passageway.

WATER HEATER. Any heating appliance or equipment that heats potable water and supplies such water to the potable hot water distribution system.

ZONE. One occupiable space or several occupiable spaces with similar occupancy classification (see Table [403.3] 403.3.1.1), occupant density, zone air distribution effectiveness and zone primary airflow rate per unit area.

§ 4. Chapter 3 of the New York city mechanical code, as amended by local law number 141 for the year 2013, is amended to read as follows:

CHAPTER 3 GENERAL REGULATIONS

SECTION MC 301 GENERAL

301.1 Scope. This chapter shall govern the approval and installation of all equipment and appliances that comprise parts of the building mechanical systems regulated by this code in accordance with Section 101.2.

301.2 Energy utilization. Heating, ventilating, ~~and~~ air-conditioning, and refrigeration systems of all structures shall be designed and installed for efficient utilization of energy in accordance with *the New York City Energy Conservation Code*.

301.3 Identification. All pipe and tubing and each pipe fitting utilized in a mechanical system shall bear the identification of the manufacturer.

301.4 Plastic pipe, fittings and components. Plastic pipe, fittings and components shall be third-party certified.

301.5 Third-party testing and certification. Piping, tubing and fittings shall comply with the applicable referenced standards, specifications and performance criteria of this code and shall be identified in accordance with Section 301.3. Piping, tubing and fittings shall either be tested by an approved third-party testing agency or certified by an approved third-party certification agency.

301.6 Fuel gas appliances and equipment. The approval and installation of fuel gas distribution piping and equipment, fuel gas-fired appliances and fuel gas-fired appliance venting systems shall be in accordance with the *New York City Fuel Gas Code*.

~~301.4]~~ **301.7 Listed and labeled.** Appliances regulated by this code shall be listed and labeled for the application in which they are installed.

Exception: Listing and labeling of equipment and appliances used for refrigeration shall be in accordance with Section 1101.2.

~~[301.5]~~ **301.8 Testing of materials.** Refer to Section 28-113 of the *Administrative Code*.

~~[301.6]~~ **301.9 Label information.** A permanent factory-applied name-plate(s) shall be affixed to appliances on which shall appear in legible lettering, the manufacturer's name or trademark, the model number, serial number and the seal or mark of the approved agency. A label shall also include the following:

1. Electrical equipment and appliances: Electrical rating in volts, amperes and motor phase; identification of individual electrical components in volts, amperes or watts, motor phase; Btu/h (W) output; and required clearances.
2. Absorption units: Hourly rating in Btu/h (W); minimum hourly rating for units having step or automatic modulating controls; type of fuel; type of refrigerant; cooling capacity in Btu/h (W); and required clearances.
3. Fuel-burning units: Hourly rating in Btu/h (W); type of fuel approved for use with the appliance; and required clearances.
4. Electric comfort heating appliances: ~~[Name and trade mark of the manufacturer; the model number or equivalent; the electric]~~ Electric rating in volts, ~~[ampacity]~~ amperes and phase; Btu/h (W) output rating; individual marking for each electrical component in amperes or watts, volts and phase; and required clearances from combustibles ~~[; and a seal indicating approval of the appliance by an approved agency].~~

~~[301.7]~~ **301.10 Electrical.** Electrical wiring, controls and connections to equipment and appliances regulated by this code shall be in accordance with the *New York City Electrical Code*.

~~[301.8]~~ **301.11 Plumbing connections.** Potable water supply and building drainage system connections to equipment and appliances regulated by this code shall be in accordance with the *New York City Plumbing Code*.

~~[301.9]~~ **301.12 Fuel types.** Fuel-fired appliances shall be designed for use with the type of fuel to which they will be connected and the altitude at which they are installed. Appliances that comprise parts of the building mechanical system shall not be converted for the usage of a different fuel, except where approved and converted in accordance with the manufacturer's instructions. The fuel input rate shall not be increased or decreased beyond the limit rating for the altitude at which the appliance is installed.

~~[301.10 Vibration isolation. Where vibration isolation of equipment and appliances is employed, supplemental restraint shall be used to accomplish the support and restraint.]~~

301.13 Reserved.

~~[301.11]~~ **301.14 Repair.** Defective material or parts shall be replaced or repaired in such a manner so as to preserve the original approval or listing.

~~[301.12]~~ **301.15 Wind resistance.** Mechanical equipment, appliances and supports that are exposed to wind shall be designed and installed to resist the wind pressures determined in accordance with the *New York City Building Code*.

~~[301.13]~~ **301.16 Flood hazard.** For structures located in ~~[areas of special flood hazard, and buildings that include I 2 occupancies that are hospitals located in shaded X Zones]~~ flood hazard areas, mechanical systems, equipment and appliances shall comply with the additional requirements of Appendix G of the *New York City Building Code*.

301.16.1 High-velocity wave action. For buildings in coastal high-hazard areas and coastal A-zones as established in Section G102 of the *New York City Building Code*, mechanical systems and equipment shall not be mounted on or penetrate through breakaway walls.

~~[301.14 Rodent proofing]~~ **301.17 Rodentproofing.** Buildings or structures and the walls enclosing habitable or occupiable rooms and spaces in which persons live, sleep or work, or in which feed, food or foodstuffs are stored, prepared, processed, served or sold, shall be constructed to protect against the entrance of rodents in accordance with Appendix F of the *New York City Building Code*.

~~[301.15]~~ **301.18 Seismic resistance.** ~~[When]~~ Where earthquake loads are applicable in accordance with the *New York City Building Code*, mechanical system supports shall be designed and installed for the seismic forces in accordance with the *New York City Building Code*.

SECTION MC 302 **~~[PROTECTION OF STRUCTURE]~~ STRUCTURAL SAFETY**

302.1 Structural safety. The building or structure shall not be weakened by the installation of mechanical systems. Where floors, walls, ceilings or any other portion of the building or structure are required to be altered or replaced in the process of installing or repairing any system, the building or structure shall be left in a safe structural condition in accordance with the *New York City Building Code*.

302.1.1 Loading. Alterations resulting in the addition of loads to any member, such as HVAC equipment and water heaters, shall not be permitted without verification that the members are capable of supporting such additional loading.

302.2 Penetrations of floor/ceiling assemblies and fire-resistance-rated assemblies. Penetrations of floor/ceiling assemblies and assemblies required to have a fire-resistance rating shall be protected in accordance with Chapter 7 of the *New York City Building Code* and Chapter 6 of this code.

302.3 Cutting, notching and boring in wood framing. The cutting, notching and boring of wood framing members shall comply with Sections 302.3.1 through ~~[302.3.4]~~ 302.3.5.

302.3.1 ~~[Joist notching]~~ Solid non-engineered joist notches and holes. Notches on the ends of the solid, non-engineered joists shall not exceed one-fourth the joist depth. Notches in the top or bottom of joists shall not exceed one-sixth the depth, shall not be longer than one-third the depth and shall not be located in the middle third of the span. Holes bored in joists shall not be within 2 inches ([54] 50.8 mm) of the top or bottom of the joist, and the diameter of any such hole shall not exceed one-third the depth of the joist. [Notches in the top or bottom of joists shall not exceed one-sixth the depth and shall not be located in the middle third of the span.] Holes bored in the middle third of the span shall be located at the center of the joist depth. Clear distance between holes and notches shall be a minimum of 2 inches (50.8 mm). See Figure 2308.5.8 of the *New York City Building Code*.

302.3.2 Stud cutting and notching. In exterior walls and bearing partitions, ~~[any]~~ wood ~~[stud is]~~ studs are permitted to be cut or notched ~~[not to exceed 25 percent of its depth]~~ to a depth not exceeding than 25 percent of the width of the stud. Cutting or notching of studs to a depth not greater than 40 percent of ~~[their depth]~~ the width of the stud is permitted in nonbearing partitions supporting no loads other than the weight of the partition. See Figure 2308.5.8 of the *New York City Building Code*.

302.3.3 Bored holes in studs. ~~[A hole]~~ Bored holes not greater ~~[in diameter]~~ than 40 percent of the stud ~~[depth is]~~ width are permitted to be bored in any wood stud. Bored holes not greater than 60 percent of the ~~[depth of]~~ stud width are permitted in nonbearing partitions or in any wall where each bored stud is doubled, provided not more than two such successive doubled studs are so bored. In no case shall the edge of the bored hole be nearer than ~~[0.625 inch]~~ $\frac{5}{8}$ inch (15.9 mm) to the edge of the stud. Bored holes shall not be located at the same section of stud as a cut or notch. See Figure 2308.5.8 of the *New York City Building Code*.

302.3.4 Engineered wood products. Cuts, notches and holes bored in trusses, structural composite ~~[veneer]~~ lumber, structural glue-laminated members ~~[and]~~ or I-joists are prohibited except where permitted by the manufacturer's recommendations or where the effects of such alterations are specifically considered in the design of the member by a registered design professional.

302.3.5 Drilling and notching of top plate. When piping or ductwork is placed in or partly in an exterior wall or interior load-bearing wall, necessitating cutting, drilling or notching of the top plate by more than 50 percent of its width, a galvanized metal tie not less than 0.054 inch thick (1.37 mm) (16 ga) and 1½ inches (38.1 mm) wide shall be fastened across and to the plate at each side of the opening with not less than eight 10d (0.148 inch diameter) nails having a minimum length of 1½ inches (38.1 mm) at each side or equivalent. The metal tie must extend a minimum of 6 inches past the opening. See Figure 2308.5.8 of the *New York City Building Code*.

Exception: When the entire side of the wall with the notch or cut is covered by wood structural panel sheathing additional fastening is not required.

302.4 ~~[Alterations to trusses]~~ Trusses. Truss members of any material and components shall not be cut, drilled, notched, spliced or otherwise altered in any way without written concurrence and approval of a registered design professional. ~~[Alterations resulting in the addition of loads to any member (e.g., HVAC equipment, water heaters) shall not be permitted without verification that the truss is capable of supporting such additional loading.]~~

302.5 Cutting, notching and boring in steel framing. The cutting, notching and boring of steel framing members shall comply with Sections 302.5.1 through ~~[302.5.3]~~ 302.5.4.

302.5.1 ~~[Cutting, notching and boring holes in structural]~~ Structural steel framing. The cutting, notching and boring of holes in structural steel framing members shall be as prescribed by the registered design professional.

302.5.2 ~~[Cutting, notching and boring holes in cold-formed]~~ Cold-formed steel framing. Flanges and lips of load-bearing, cold-formed steel framing members shall not be cut or notched. Holes in webs of load-bearing, cold-formed steel framing members shall be permitted along the

centerline of the web of the framing member and shall not exceed the dimensional limitations, penetration spacing or minimum hole edge distance as prescribed by the registered design professional. [~~Cutting, notching and boring holes of steel floor/roof decking shall be as prescribed by the registered design professional.~~]

302.5.3 [~~Cutting, notching and boring holes in nonstructural~~ Nonstructural cold-formed steel wall framing. Flanges and lips of nonstructural cold-formed steel wall studs [~~shall not be cut or notched. Holes in webs of nonstructural cold formed steel wall studs~~] shall be permitted along the centerline of the web of the framing member, shall not exceed 1½ inches (~~[38]~~ 38.1 mm) in width or 4 inches (~~[102]~~ 101.6 mm) in length, and the holes shall not be spaced less than 24 inches (~~[610]~~ 609.6 mm) center to center from another hole or less than 10 inches (254 mm) from the bearing end.

302.5.4 Steel floor and roof decking. Cutting, notching and boring holes in steel floor and roof decking shall be as prescribed by the registered design professional.

302.6 Cutting, notching and coring into concrete. The cutting, notching or coring of concrete must comply with provisions of Chapter 19 of the *New York City Building Code* and is not permitted without prior approval of the registered design professional.

302.7 Protection of footings. Trenching installed parallel to footings and walls shall not extend into the bearing plane of a footing or wall. The upper boundary of the bearing plane is a line that extends downward, at an angle of 34 degrees (1:1.5 slope) from horizontal, from the outside bottom edge of the footing or wall.

302.8 Piping materials exposed within plenums. Piping materials exposed within plenums shall comply with this code.

SECTION MC 303 EQUIPMENT AND APPLIANCE LOCATION

303.1 General. Equipment and appliances shall be located as required by this section, specific requirements elsewhere in this code and the conditions of the equipment and appliance listing.

303.2 Hazardous locations. Appliances shall not be located in a hazardous location unless listed and approved for the specific installation.

303.3 Prohibited locations. Appliances shall not be located in sleeping rooms, bathrooms, toilet rooms, storage closets or surgical rooms, or in a space that opens only into such rooms or spaces, except where the installation complies with one of the following exceptions:

Exceptions: This section shall not apply to the following appliances:

1. In rooms other than those used for sleeping purposes, direct-vent appliances that obtain all combustion air directly from the outdoors and are installed in accordance with the conditions of the listing and manufacturer's instructions.
2. In rooms other than those used for sleeping purposes, vented room heaters, wall furnaces, vented decorative appliances, vented gas fireplaces, vented gas fireplace heaters and

decorative appliances for installation in vented solid fuel-burning fireplaces that are installed in rooms that meet the required volume criteria of Section 702.

3. In rooms other than those used for sleeping purposes, [Appliances] appliances installed in a dedicated enclosure in which all combustion air is taken directly from the outdoors, in accordance with Section 703. Access to such enclosure shall be through a solid door, weather-stripped in accordance with the exterior door air leakage requirements of the *New York City Energy Conservation Code* and equipped with an approved self-closing device.

303.4 Protection from physical damage. Appliances shall not be installed in a location where subject to physical damage, including vehicular impact, unless protected by approved barriers meeting the requirements of the *New York City Fire Code*.

303.5 Indoor locations. ~~[Fuel-fired furnaces, water heaters]~~ Furnaces and boilers installed in closets and alcoves shall be listed for such installation. ~~[For purposes of this section, a closet or alcove shall be defined as a room or space having a volume less than 12 times the total volume of fuel-fired appliances other than boilers and less than 16 times the total volume of boilers. Room volume shall be computed using the gross floor area and the actual ceiling height up to a maximum computation height of 8 feet (2438 mm).]~~

303.6 Outdoor locations. Appliances installed in other than indoor locations shall be listed and labeled for outdoor installation.

303.7 Pit locations. Appliances installed in pits or excavations shall not come in direct contact with the surrounding soil. The sides of the pit or excavation shall be held back ~~[a minimum of]~~ not less than 12 inches ([305] 304.8 mm) from the appliance. Where the depth exceeds 12 inches (~~[305]~~ 304.8 mm) below adjoining grade, the walls of the pit or excavation shall be lined with concrete or masonry. Such concrete or masonry shall extend ~~[a minimum of]~~ not less than 4 inches ([402] 101.6 mm) above adjoining grade and shall have sufficient lateral load-bearing capacity to resist collapse. The appliance shall be protected from flooding.

303.8 Elevator shafts. Mechanical systems shall not be located in an elevator shaft.

SECTION MC 304 INSTALLATION

304.1 General. Equipment and appliances shall be installed as required by the terms of their approval, in accordance with the conditions of the listing, the manufacturer's ~~[installation]~~ instructions and this code. Manufacturer's ~~[installation]~~ instructions shall be available on the job site at the time of inspection.

304.2 Conflicts. Where conflicts between this code and the conditions of listing or the manufacturer's ~~[installation]~~ instructions occur, the provisions of this code shall apply.

Exception: Where a code provision is less restrictive than the conditions of the listing of the equipment or appliance or the manufacturer's ~~[installation]~~ instructions, the conditions of the listing and the manufacturer's ~~[installation]~~ instructions shall apply.

304.3 Elevation of ignition source. Equipment and appliances having an ignition source and located in hazardous locations and public garages, private garages, repair garages, automotive motor fuel-dispensing facilities and parking garages shall be elevated such that the source of ignition is not less than 18 inches (~~[457]~~ 457.2 mm) above the floor surface on which the equipment or appliance rests. For the purpose of this section, rooms or spaces that are not part of the living space of a dwelling unit and that communicate directly with a private garage through openings shall be considered to be part of the private garage.

Exception: Elevation of the ignition source is not required for appliances that are listed as flammable vapor ignition resistant.

304.3.1 Parking garages. Connection of a parking garage with any room in which there is a fuel-fired appliance shall be by means of a vestibule providing a two-doorway separation, except that a single door is permitted where the sources of ignition in the appliance are elevated in accordance with Section 304.3.

Exception: This section shall not apply to appliance installations complying with Section 304.6.

304.4 Prohibited equipment and appliance location. Equipment and appliances having an ignition source shall not be installed in Group H occupancies or control areas where open use, handling or dispensing of combustible, flammable or explosive materials occurs.

304.5 Hydrogen generating and refueling operations. Hydrogen generating and refueling operations shall be prohibited except as permitted by the Commissioner of the Fire Department.

304.6 Public garages. Appliances located in public garages, motor fueling-dispensing facilities, repair garages or other areas frequented by motor vehicles, shall be installed [~~a minimum of~~] not less than 8 feet (~~[2438]~~ 2438.4 mm) above the floor. Where motor vehicles are capable of passing under an appliance, the appliance shall be installed at the clearances required by the appliance manufacturer and not less than 1 foot (~~[305]~~ 304.8 mm) higher than the tallest vehicle garage door opening.

Exception: The requirements of this section shall not apply where the appliances are protected from motor vehicle impact and installed in accordance with NFPA 30A and Section 304.3 of this code [~~and NFPA 30A~~].

304.7 Private garages. Appliances located in private garages and carports shall be installed with a minimum clearance of 6 feet (~~[1829]~~ 1828.8 mm) above the floor.

Exception: The requirements of this section shall not apply where the appliances are protected from motor vehicle impact and installed in accordance with Section 304.3.

304.8 Construction and protection. Boiler rooms and furnace rooms shall be protected as required by the *New York City Building Code*.

304.9 Clearances to combustible construction. Heat-producing equipment and appliances shall be installed to maintain the required clearances to combustible construction as specified in the listing and manufacturer's instructions. Such clearances shall be reduced only in accordance with Section

308. Clearances to combustibles shall include such considerations as door swing, drawer pull, overhead projections or shelving and window swing, shutters, coverings and drapes. Devices such as doorstops or limits, closers, drapery ties or guards shall not be used to provide the required clearances.

304.10 Clearances from grade. Equipment and appliances installed at grade level shall be supported on a level concrete slab or other approved material extending not less than 3 inches (~~[76]~~ 76.2 mm) above adjoining grade or shall be suspended not less than 6 inches (~~[152]~~ 152.4 mm) above adjoining grade. Such support shall be in accordance with the manufacturer's ~~[installation]~~ instructions.

304.11 Guards. Guards shall be provided where appliances, equipment, fans or other components that require service and roof hatch openings are located within 10 feet (3048 mm) of a roof edge or open side of a walking surface and such edge or open side is located more than 30 inches (762 mm) above the floor, roof, or grade below. The guard shall extend not less than 30 inches (762 mm) beyond each end of such appliances, equipment, fans, components and roof hatch openings and the top of the guard shall be located not less than 42 inches (~~[1067]~~ 1066.8 mm) above the elevated surface adjacent to the guard. The guard shall be constructed so as to prevent the passage of a 21-inch-diameter (~~[533]~~ 533.4 mm) sphere and shall comply with the loading requirements for guards specified in the *New York City Building Code*.

304.12 Area served. Appliances serving different areas of a building other than where they are installed shall be permanently marked in an approved manner that uniquely identifies the appliance and the area it serves.

304.13 Rooftop access and obstructions. Equipment and appliances installed on rooftops of buildings shall be installed in accordance with the requirements of the *New York City Fire Code* regarding rooftop access and obstructions, and shall not obstruct or interfere with firefighting operations or the operation of any doors, windows, fire escapes, or other means of egress or other building components requiring operation or access.

SECTION MC 305 PIPING SUPPORT

305.1 General. ~~[All mechanical]~~ Mechanical system piping shall be supported in accordance with this section.

305.2 Materials. Pipe hangers and supports shall have sufficient strength to withstand all anticipated static and specified dynamic loading conditions associated with the intended use.

Pipe hangers and supports that are in direct contact with piping shall be of materials that are compatible with the piping and that will not promote galvanic action.

305.3 Structural attachment. Hangers and anchors shall be attached to the building structure. Post-installed anchors shall be subject to special inspection in accordance with Section 1705.37 of the *New York City Building Code*.

305.4 Interval of support. Piping shall be supported at distances not exceeding the spacing specified in Table 305.4, or in accordance with ~~[MSS SP-69]~~ ANSI/MSS SP-58.

**TABLE 305.4
PIPING SUPPORT SPACING^a**

PIPING MATERIAL	MAXIMUM HORIZONTAL SPACING (feet)	MAXIMUM VERTICAL SPACING (feet)
ABS pipe	4	10 ^c
Aluminum pipe and tubing	10	15
Brass pipe	10	10
Brass tubing, 1/4-inch diameter and smaller	6	10
Brass tubing, 1/2-inch diameter and larger	10	10
Cast-iron pipe ^b	5	15
Copper or copper-alloy pipe	12	10
Copper or copper-alloy tubing, 1/4-inch diameter and smaller	6	10
Copper or copper-alloy tubing, 1/2-inch diameter and larger	10	10
CPVC pipe or tubing, 1 inch and smaller	3	10 ^c
CPVC pipe or tubing, 1/4-inch and larger	4	10 ^c
Lead pipe	Continuous	4
PB pipe or tubing	2 ² / ₃ (32 inches)	4
<u>PE-RT < 1 inches</u>	<u>2²/₃ (32 inches)</u>	<u>10^c</u>
<u>PE-RT > 1/4 inches</u>	<u>4</u>	<u>10^c</u>
PEX tubing	2 ² / ₃ (32 inches)	10 ^c
Polypropylene (PP) pipe or tubing, 1 inch or smaller	2 ² / ₃ (32 inches)	10 ^c
Polypropylene (PP) pipe or tubing 1/4 inches or larger	4	10 ^c
PVC pipe	4	10 ^c
Steel tubing	8	10
Steel pipe	12	15

For SI: 1 inch = 25.4 mm, 1 foot = 304.8 mm.

- a. See Section [304-15] 301.18.
- b. The maximum horizontal spacing of cast-iron pipe hangers shall be increased.
- c. Mid-story guide [-].

305.5 Protection against physical damage. In concealed locations where piping, other than cast-iron or steel, is installed through holes or notches in studs, joists, rafters or similar members less than 1 1/2 inches ([~~38~~] 38.1 mm) from the nearest edge of the member, the pipe shall be protected by shield plates. Protective steel shield plates having a minimum thickness of [~~thick 0.0575 inch~~] 0.0575 inch (1.463 mm) (No. 16 gage) shall cover the area of the pipe where the member is notched or bored, and shall extend [~~a minimum of~~] not less than 2 inches ([~~51~~] 50.8 mm) above sole plates and below top plates.

SECTION MC 306 ACCESS AND SERVICE SPACE

306.1 Access [~~for maintenance and replacement~~]. Appliances, control devices, heat exchangers and HVAC system components that require maintenance shall be accessible for inspection, service, repair and replacement without disabling the function of a fire-resistance-rated assembly or removing permanent construction, other appliances, venting systems or any other piping or ducts not connected to the appliance being inspected, serviced, repaired or replaced. A level working space [~~at least~~] not less than 30 inches deep and 30 inches wide (762 mm by 762 mm) shall be provided in front of the

control side to service an appliance. Clearance shall also be provided as required by the *New York City Electrical Code*. [7]

306.1.1 Central furnaces. Central furnaces within compartments or alcoves shall have a minimum working space clearance of 3 inches (~~[76]~~ 76.2 mm) along the sides, back and top with a total width of the enclosing space being [~~at least~~] not less than 12 inches (~~[305]~~ 304.8 mm) wider than the furnace. Furnaces having a firebox open to the atmosphere shall have [~~at least~~] not less than 6 inches (~~[152]~~ 152.4 mm) working space along the front combustion chamber side. Combustion air openings at the rear or side of the compartment shall comply with the requirements of Chapter 7.

Exception: This section shall not apply to replacement appliances installed in existing compartments and alcoves where the working space clearances are in accordance with the equipment or appliance manufacturer's [~~installation~~] instructions.

306.2 Appliances in rooms. Rooms containing appliances shall be provided with a door and an unobstructed passageway measuring not less than 36 inches (~~[914]~~ 914.4 mm) wide and 80 inches (2032 mm) high.

Exception: Within a dwelling unit, appliances installed in a compartment, alcove, basement or similar space shall be accessed by an opening or door and an unobstructed passageway measuring not less than 24 inches (~~[610]~~ 609.6 mm) wide and large enough to allow removal of the largest appliance in the space, provided that a level service space of not less than 30 inches (762 mm) deep and the height of the appliance, but not less than 30 inches (762 mm), is present at the front or service side of the appliance with the door open.

306.3 Appliances in attics. Attics containing appliances shall be provided with an opening and unobstructed passageway large enough to allow removal of the largest appliance. The passageway shall be not [~~be~~] less than 30 inches (762 mm) high and 22 inches (~~[559]~~ 558.8 mm) wide and not more than 20 feet (6096 mm) in length measured along the centerline of the passageway from the opening to the appliance. The passageway shall have continuous solid flooring not less than 24 inches (~~[610]~~ 609.6 mm) wide. A level service space not less than 30 inches (762 mm) deep and 30 inches (762 mm) wide shall be present at the front or service side of the appliance. The clear access opening dimensions shall be [~~a minimum of~~] not less than 20 inches by 30 inches (508 mm by 762 mm), and large enough to allow removal of the largest appliance.

Exceptions:

1. The passageway and level service space are not required where the appliance is capable of being serviced and removed through the required opening.
2. [~~Where the passageway is not less than 6 feet (1829 mm) high for its entire length, the passageway shall be not greater than 50 feet (15 250 mm) in length.~~] Where the passageway is unobstructed and not less than 6 feet (~~[1829]~~ 1828.8 mm) high and [~~22~~] 24 inches (~~[559]~~ 609.6 mm) wide for its entire length, the passageway shall be not greater than 50 feet (15 250 mm) in length.

306.3.1 Electrical requirements. A luminaire controlled by a switch located at the required passageway opening and a receptacle outlet shall be provided at or near the appliance location in accordance with the *New York City Electrical Code*.

306.4 Appliances under floors. ~~[Under-floor]~~ Under-floor spaces containing appliances shall be provided with an access opening and unobstructed passageway large enough to remove the largest appliance. The passageway shall be not ~~[be]~~ less than 30 inches (762 mm) high and 22 inches (~~[559]~~ 558.8 mm) wide, nor more than 20 feet (6096 mm) in length measured along the centerline of the passageway from the opening to the appliance. A level service space not less than 30 inches (762 mm) deep and 30 inches (762 mm) wide shall be present at the front or service side of the appliance. If the depth of the passageway or the service space exceeds 12 inches (~~[305]~~ 304.8 mm) below the adjoining grade, the walls of the passageway shall be lined with concrete or masonry. Such concrete or masonry shall extend ~~[a minimum of]~~ not less than 4 inches (~~[102]~~ 101.6 mm) above the adjoining grade and shall have sufficient lateral-bearing capacity to resist collapse. The clear access opening dimensions shall be ~~[a minimum of]~~ not less than 22 inches by 30 inches (~~[559]~~ 558.8 mm by 762 mm), and large enough to allow removal of the largest appliance.

Exceptions ~~[Exceptions]:~~

1. The passageway is not required where the level service space is present when the access is open and the appliance is capable of being serviced and removed through the required opening.
2. ~~[Where the passageway is not less than 6 feet high (1829 mm) for its entire length, the passageway shall not be limited in length.]~~ Where the passageway is unobstructed and not less than 6 feet (~~[1829]~~ 1828.8 mm) high and 22 inches (~~[559]~~ 558.8 mm) wide for its entire length, the passageway shall not be limited in length.

306.4.1 Electrical requirements. A luminaire controlled by a switch located at the required passageway opening and a receptacle outlet shall be provided at or near the appliance location in accordance with the *New York City Electrical Code*.

306.5 Equipment and appliances on roofs or elevated structures. Where equipment ~~[and]~~ or appliances requiring access are ~~[installed]~~ located on ~~[roofs or]~~ an elevated ~~[structures at]~~ structure or the roof of a ~~[height exceeding]~~ building such that personnel will have to climb higher than 16 feet (~~[4877]~~ 4876.8 mm) ~~[,such]~~ above grade, roof or floor level to access such equipment or appliances, an interior or exterior means of access shall be provided ~~[by a permanent approved means of access, the extent of which shall be from grade or floor level to the equipment and appliances' level service space].~~ Such access shall not require climbing over obstructions greater than 30 inches (762 mm) ~~[high]~~ in height or walking on roofs having a slope greater than 4 units vertical in 12 units horizontal (33-percent slope). Such access to the roof or elevated structure and access from the roof or elevated structure to equipment requiring maintenance shall not require the use of portable ladders. Where access involves climbing over parapet walls, the height shall be measured to the top of the parapet wall.

Permanent ladders installed to provide the required access shall comply with the following minimum design criteria:

1. The side railing shall extend above the parapet or roof edge not less than 30 inches (762 mm).
2. Ladders shall have rung spacing not to exceed 12 inches (~~[305]~~ 304.8 mm) on center. The uppermost rung shall be not more than 24 inches (609.6 mm) below the upper edge of the roof hatch, roof or parapet, or equipment access platform, as applicable.
3. Ladders shall have a toe spacing not less than 7 inches (177.8 mm) deep.
4. There shall be ~~[a minimum of]~~ not less than 18 inches (~~[457]~~ 457.2 mm) between rails.
5. Rungs shall have a ~~[minimum]~~ diameter not less than 0.75-inch (19 mm) ~~[diameter]~~ and be capable of withstanding a 300-pound (136.1 kg) load.
6. Where a cage, well or ladder safety device is prohibited, ladders over 20 feet (6096 mm) in height shall be provided with landing platforms for each 30 feet (9144 mm) of height. Where a cage, well or ladder safety device is not provided, ladders over 20 feet (6096 mm) in height shall be provided with landing platforms for each 20 feet (6096 mm) of height. Landings shall be capable of withstanding 100 pounds (488.2 kg/m²) per square foot. ~~[Landing dimensions shall be not less than 30 inches (762 mm) in length and not less than 24 inches (610 mm) in width.]~~ A guard rail and toeboard shall be provided on all open sides of the landing.
7. ~~[Where ladder extensions are installed, the side rails of through or side step ladder extensions shall extend 3½ feet (1067 mm) above the parapets and landings. For through ladder extensions, the rungs shall be omitted from the extensions and shall have not less than 18 (457 mm) nor more than 24 inches (610 mm) of clearance between rails. For side step or offset fixed ladder sections, at landings, the side rails and rungs shall be carried to the next regular rung beyond or above the 3½ feet (1067 mm) minimum.]~~

Climbing clearance. The distance from the centerline of the rungs to the nearest permanent object on the climbing side of the ladder shall be not less than 30 inches (762 mm) measured perpendicular to the rungs. This distance shall be maintained from the point of ladder access to the bottom of the roof hatch. A minimum clear width of 15 inches (381 mm) shall be provided on both sides of the ladder measured from the midpoint of and parallel with the rungs except where cages or wells are installed.

8. Landing required. The ladder shall be provided with a clear and unobstructed bottom landing area having a minimum dimension of 30 inches by 30 inches (762 mm by 762 mm) centered in front of the ladder.
9. Ladders shall be protected against corrosion by approved means.
- ~~[9.]~~ 10. Service personnel shall have access to ladders at all times.

11. Where ladder extensions are installed, the side rails of through or side-step ladder extensions shall extend 3½ feet (1066.8 mm) above the parapets and landings. For through ladder

extensions, the rungs shall be omitted from the extensions and shall have not less than 18 inches (457.2 mm) nor more than 24 inches (609.6 mm) of clearance between rails. For side-step or offset fixed ladder sections, at landings, the side rails and rungs shall be carried to the next regular rung beyond or above the 3½ feet (1066.8 mm) minimum.

Catwalks installed to provide the required access shall be not less than 24 inches (~~610~~ 609.6 mm) wide and shall have railings as required for service platforms.

Exception: This section shall not apply to Group R-3 occupancies.

306.5.1 Sloped roofs. Where appliances, equipment, fans or other components that require service are installed on a roof having a slope of [~~3~~] three units vertical in 12 units horizontal (25-percent slope) or greater and having an edge more than 30 inches (762 mm) above grade at such edge, a level platform shall be provided on each side of the appliance or equipment to which access is required for service, repair or maintenance. The platform shall be not less than 30 inches (762 mm) in any dimension and shall be provided with guards. The guards shall extend not less than 42 inches (~~1067~~] 1066.8 mm) above the platform, shall be constructed so as to prevent the passage of a 21-inch (~~533~~] 533.4 mm) diameter sphere and shall comply with the loading requirements for guards specified in the *New York City Building Code*. Access shall not require walking on roofs having a slope greater than four units vertical in 12 units horizontal (33-percent slope). Where access involves obstructions greater than 30 inches (762 mm) in height, such obstructions shall be provided with ladders installed in accordance with Section 306.5 or [~~stairs~~] stairways installed in accordance with the requirements specified in the *New York City Building Code* in the path of travel to and from appliances, fans or equipment requiring service.

306.5.2 Electrical requirements. A receptacle outlet shall be provided at or near the equipment location in accordance with the *New York City Electrical Code*.

SECTION MC 307 CONDENSATE DISPOSAL

307.1 Fuel-burning appliances. Liquid combustion by-products of condensing appliances shall be collected and discharged to [~~a~~] an approved plumbing fixture or disposal area in accordance with the manufacturer's [~~installation~~] instructions. Condensate piping shall be of approved corrosion-resistant material in accordance with Section 803 of the *New York City Plumbing Code* and shall not be smaller than the drain connection on the appliance. Such piping shall maintain a minimum horizontal slope in the direction of discharge of not less than [~~1/8~~] one-eighth unit vertical in 12 units horizontal (1-percent slope). Piping shall be configured to permit clearing of blockages and performance of maintenance without requiring the drain line to be cut.

307.1.1 Condensate disposal. Condensate from all fuel-burning appliances and associated flues shall be neutralized to a pH of at least 6 and no more than 8 prior to disposal to a sanitary system.

307.2 Evaporators and cooling coils. Condensate drain systems shall be provided for equipment and appliances containing evaporators or cooling coils. Condensate drain systems shall be designed, constructed and installed in accordance with Sections 307.2.1 through [~~307.2.4~~] 307.2.6.

Exception: Evaporators and cooling coils that are designed to operate in sensible cooling only and not support condensation shall not be required to meet the requirements of this section.

307.2.1 Condensate disposal. Condensate from all cooling coils and evaporators shall be conveyed from the drain pan outlet to an approved place of disposal. Such piping shall maintain a minimum horizontal slope in the direction of discharge of not less than one-eighth unit vertical in 12 units horizontal (1-percent slope). Condensate shall not discharge into a street, alley or other areas so as to cause a nuisance.

307.2.2 Drain pipe materials and sizes. Components of the condensate disposal system shall be cast iron, galvanized steel, copper, cross-linked polyethylene, ~~polybutylene,~~ polyethylene, ABS, CPVC, or PVC pipe or tubing. Polypropylene tubing may be used in lengths that do not exceed 12 inches (304.8 mm) for an individual drain application. ~~All components~~ Components shall be selected for the pressure and temperature rating of the installation. Joints and connections shall be made in accordance with the applicable provisions of Chapter 7 of the *New York City Plumbing Code* relative to the material type. Condensate waste and drain line size shall be not less than ~~3/4 inch (19 mm)~~ 3/4-inch (19.1 mm) internal diameter and shall not decrease in size from the drain pan connection to the place of condensate disposal. Where the drain pipes from more than one unit are manifolded together for condensate drainage, the pipe or tubing shall be sized in accordance with Table 307.2.2.

**TABLE 307.2.2
CONDENSATE DRAIN SIZING**

EQUIPMENT CAPACITY	MINIMUM CONDENSATE PIPE DIAMETER
Up to 20 tons of refrigeration	3/4 inch
Over 20 tons to 40 tons of refrigeration	1 inch
Over 40 tons to 90 tons of refrigeration	1 1/4 inch inches
Over 90 tons to 125 tons of refrigeration	1 1/2 inch inches
Over 125 tons to 250 tons of refrigeration	2 inch inches

For SI: 1 inch = 25.4 mm, 1 ton = 3.517 kW.

307.2.3 Auxiliary and secondary drain systems. In addition to the requirements of Section 307.2.1, where damage to any building components could occur as a result of overflow from the equipment primary condensate removal system, one of the following auxiliary protection methods shall be provided for each cooling coil or fuel-fired appliance that produces condensate:

1. An auxiliary drain pan with a separate drain shall be provided under the coils on which condensation will occur. The auxiliary pan drain shall discharge to a conspicuous point of disposal to alert occupants in the event of a stoppage of the primary drain. The pan shall have a ~~minimum~~ depth of not less than 1 1/2 inches ([38] 38.1 mm), shall be not ~~be~~ less than 3 inches (~~[76] 76.2 mm~~) larger than the unit, or the coil dimensions in width and length and shall be constructed of corrosion-resistant material. Metallic pans shall have a ~~minimum~~ thickness of not less than 0.0236 ~~inches~~ inch (0.6010 mm) (No. 24 gage) for galvanized sheet metal pans, 0.0179 ~~inches~~ inch (0.4546 mm) (No. 26 gage) for stainless steel pans, or 0.0320 ~~inches~~ inch (0.8128 mm) (No. 20 gage) for aluminum pans. Nonmetallic pans shall have a ~~minimum~~ thickness of not less than 0.0625 inch (1.6 mm). [.]

2. A separate overflow drain line shall be connected to the drain pan provided with the equipment. Such overflow drain shall discharge to a conspicuous point of disposal to alert occupants in the event of a stoppage of the primary drain. The overflow drain line shall connect to the drain pan at a higher level than the primary drain connection.
3. An auxiliary drain pan without a separate drain line shall be provided under the coils on which condensate will occur. Such pan shall be equipped with a listed water-level detection device that will shut off the equipment served prior to overflow of the pan. The auxiliary drain pan shall be constructed in accordance with Item 1 of this section.
4. A listed water-level detection device shall be provided that will shut off the equipment served in the event that the primary drain is blocked. The device shall be installed in the primary drain line, the overflow drain line, or in the equipment-supplied drain pan, located at a point higher than the primary drain line connection and below the overflow rim of such pan.

[Exception: Fuel-fired] Exceptions:

1. An auxiliary drain protection method shall not be required for fuel-fired appliances that automatically shut down operation in the event of a stoppage in the condensate drainage system.
2. An auxiliary drain protection method shall not be required where a suitably sized and located floor drain is provided.

307.2.3.1 Water-level monitoring devices. On down-flow units and all other coils that do not have a secondary drain or provisions to install a secondary or auxiliary drain pan, a water-level monitoring device shall be installed inside the primary drain pan. This device shall shut off the equipment served in the event that the primary drain becomes restricted. Devices installed in the drain line shall not be permitted.

307.2.3.2 Appliance, equipment or insulation in pans. Where an appliance, equipment or insulation is subject to water damage when auxiliary drain pans fill, that portion of the appliance, equipment or insulation shall be installed above the rim of the pans. Supports located inside of the pans to support the appliance or equipment or insulation shall be water resistant and approved.

307.2.4 Traps. Condensate drains shall be trapped as required by the equipment or appliance manufacturer.

307.2.5 Drain line maintenance. Condensate drain lines shall be configured to permit the clearing of blockages and performance of maintenance without requiring the drain line to be cut.

307.2.6 Condensate discharge. Where multiple evaporators and/or condensate pumps discharge into the same piping system, it shall be piped to prevent the discharge of condensate from one appliance to another.

307.3 Exceptions. This section applies to permanently installed equipment. Window units and through-the-wall air-conditioning units are exempt from the requirements of this section.

SECTION MC 308 CLEARANCE REDUCTION

308.1 Scope. This section shall govern the reduction in required clearances to gypsum board, combustibles materials and combustibles assemblies for chimneys, vents, kitchen exhaust equipment, mechanical appliances, and mechanical devices and equipment.

308.2 Listed appliances and equipment. The reduction of the required clearances to combustibles for listed and labeled appliances and equipment shall be in accordance with the requirements of this section except that such clearances shall not be reduced where reduction is specifically prohibited by the terms of the appliance or equipment listing.

308.3 Protective assembly construction and installation. Reduced clearance protective assemblies, including structural and support elements, shall be constructed of noncombustible materials. Spacers utilized to maintain an airspace between the protective assembly and the protected material or assembly shall be noncombustible. Where a space between the protective assembly and protected combustible material or assembly is specified, the same space shall be provided around the edges of the protective assembly and the spacers shall be placed so as to allow air circulation by convection in such space. Protective assemblies shall not be placed less than 1 inch (~~[25]~~ 25.4 mm) from the mechanical appliances, devices or equipment, regardless of the allowable reduced clearance.

308.4 Allowable reduction. The reduction of required clearances to combustibles assemblies or combustibles materials shall be based on the utilization of a reduced clearance protective assembly in accordance with Section ~~[308.5]~~ 308.4.1 or ~~[308.6]~~ 308.4.2.

~~[308.5]~~ **308.4.1 Labeled assemblies.** The allowable clearance reduction shall be based on a reduced clearance protective assembly that has been tested and bears the label of an approved agency.

~~[308.6]~~ **308.4.2 Reduction table.** The allowable clearance reduction shall be based on one of the methods specified in Table ~~[308.6]~~ 308.4.2. Where required clearances are not listed in Table ~~[308.6]~~ 308.4.2, the reduced clearances shall be determined by linear interpolation between the distances listed in the table. Reduced clearances shall not be derived by extrapolation below the range of the table.

**TABLE ~~[308.6]~~ 308.4.2
CLEARANCE REDUCTION METHODS^b**

TYPE OF PROTECTIVE ASSEMBLY ^a	REDUCED CLEARANCE WITH PROTECTION (inches) ^a							
	Horizontal combustible assemblies located above the heat source				Horizontal combustible assemblies located beneath the heat source and all vertical combustible assemblies			
	Required clearance to combustibles without protection (inches) ^a				Required clearance to combustible without protection (inches) ^a			
	36	18	9	6	36	18	9	6
Galvanized sheet metal, minimum nominal thickness of 0.0296 inch (No. 22 Gage), mounted on 1-inch glass fiber or mineral wool batt reinforced with wire on the back, 1 inch off the combustible assembly	18	9	5	3	12	6	3	3
Two layers of galvanized sheet metal, minimum nominal thickness of 0.0240 inch (No. 24 Gage), having a 1-inch airspace between layers, spaced 1 inch off the combustible assembly	18	9	5	3	12	6	3	3
Two layers of galvanized sheet metal, minimum nominal thickness of 0.0240 inch (No. 24 Gage), having 1 inch of fiberglass insulation between layers, spaced 1 inch off the combustible assembly	18	9	5	3	12	6	3	3
0.5-inch inorganic insulating board, over 1 inch of fiberglass or mineral wool batt, against the combustible assembly	24	12	6	4	18	9	5	3
3.5-inch brick wall, spaced 1 inch off the combustible wall	—	—	—	—	12	6	6	6
3.5-inch brick wall, against the combustible wall	—	—	—	—	24	12	6	5

For SI: 1 inch = 25.4 mm, °C = [(°F) - 32] / 1.8, 1 pound per cubic foot = 16.02 kg/m³, 1.0 Btu • in / [ft² • h • °F] (ft² • h • °F) = 0.144 W/m² • K.

- a. Mineral wool and glass fiber batts (blanket or board) shall have a minimum density of 8 pounds per cubic foot and a minimum melting point of 1,500°F. Insulation material utilized as part of a clearance reduction system shall have a thermal conductivity of 1.0 Btu • in / (ft² • h • °F) or less. Insulation board shall be formed of noncombustible material.
- b. For limitations on clearance reduction for solid fuel-burning appliances, masonry chimneys, connector pass-throughs, masonry fireplaces and kitchen ducts, see Sections ~~[308.7]~~ 308.4.2.1 through ~~[308.11]~~ 308.4.2.5.

~~[308.7]~~ 308.4.2.1 Solid fuel-burning appliances. The clearance reduction methods specified in Table ~~[308.6]~~ 308.4.2 shall not be utilized to reduce the clearance required for solid fuel-burning appliances that are labeled for installation with clearances of 12 inches (~~[305]~~ 304.8 mm) or less. Where appliances are labeled for installation with clearances of greater than 12 inches (~~[305]~~ 304.8 mm), the clearance reduction methods of Table ~~[308.6]~~ 308.4.2 shall not reduce the clearance to less than 12 inches (~~[305]~~ 304.8 mm).

~~[308.8]~~ 308.4.2.2 Masonry chimneys. The clearance reduction methods specified in Table ~~[308.6]~~ 308.4.2 shall not be utilized to reduce the clearances required for masonry chimneys as specified in ~~[Chapter 8 of this code and]~~ the *New York City Building Code* and Chapter 8 of this code.

~~[308.9]~~ **308.4.2.3 Chimney connector pass-throughs.** The clearance reduction methods specified in Table ~~[308.6]~~ 308.4.2 shall not be utilized to reduce the clearances required for chimney connector pass-throughs as specified in Section 803.10.4.

~~[308.10]~~ **308.4.2.4 Masonry fireplaces.** The clearance reduction methods specified in Table ~~[308.6]~~ 308.4.2 shall not be utilized to reduce the clearances required for masonry fireplaces as specified in ~~[Chapter 8 of this code and]~~ the *New York City Building Code* and Chapter 8 of this code.

~~[308.11]~~ **308.4.2.5 Kitchen exhaust ducts.** The clearance reduction methods specified in Table ~~[308.6]~~ 308.4.2 shall not be utilized to reduce the minimum clearances required by Section ~~[506.3.10]~~ 506.3.11 for kitchen exhaust ducts enclosed in a shaft.

SECTION MC 309 TEMPERATURE CONTROL

309.1 Space-heating systems. Interior spaces intended for human occupancy shall be provided with active or passive space-heating systems capable of maintaining ~~[a minimum]~~ an indoor temperature of not less than 68°F (20°C) at a point 3 feet (~~[914]~~ 914.4 mm) above floor on the design heating day. The installation of portable space heaters shall not be used to achieve compliance with this section. Refer to Section 1204 of the *New York City Building Code*.

Exception: Interior spaces where the primary purpose is not associated with human comfort.

SECTION MC 310 EXPLOSION CONTROL

310.1 Required. Structures occupied for purposes involving explosion hazards shall be provided with explosion control in compliance with rules of the Commissioner of the Fire Department. Explosion control systems shall be designed and installed in accordance with the *New York City Fire Code*.

SECTION MC 311 SMOKE AND HEAT VENTS

311.1 Required. Approved smoke and heat vents shall be installed in the roofs of one-story buildings where required by the *New York City Fire Code*. Smoke and heat vents shall be designed and installed in accordance with the *New York City Fire Code*.

SECTION MC 312 HEATING AND COOLING LOAD CALCULATIONS

312.1 Load calculations. Heating and cooling system design loads for the purpose of sizing systems, appliances and equipment shall be determined in accordance with the procedures described in the ~~[ASHRAE Handbook of Fundamentals. Heating and cooling loads shall be adjusted to account for load reductions that are achieved when energy recovery systems are utilized in the HVAC system in accordance with the ASHRAE Handbook—HVAC Systems and Equipment]~~ ASHRAE ACCA

Standard 183. Alternatively, design loads shall be determined by an approved equivalent computation procedure, using the design parameters specified in [~~Chapter 3 of~~] the *New York City Energy Conservation Code*. Heating and cooling system design loads for the purpose of sizing systems, appliances and equipment shall also comply with the requirements of Section 1204 of the *New York City Building Code*.

SECTION MC 313 **NOISE CONTROL AND VIBRATION ISOLATION REQUIREMENTS**

313.1 General. Interior and exterior mechanical equipment and systems shall comply with the provisions of this section.

313.2 Noise from exterior mechanical equipment. Mechanical equipment located outside of the building in a yard or court or on a roof, or located inside a building but open to the exterior of the building, shall comply with the requirements of Sections 313.2.1 and 313.2.2.

313.2.1 Design and installation. The applicant shall select and design any such exterior mechanical equipment in order to achieve compliance with the applicable requirements of Sections 24-218, 24-227, 24-228 and 24-232 of the *Administrative Code*, also known as the *New York City Noise Control Code*, in accordance with generally acceptable engineering practices.

313.2.2 Operation. The operation of such exterior mechanical equipment shall comply with any applicable requirements of Sections 24-218, 24-227, 24-228 and 24-232 of the *New York City Noise Control Code*, as enforced by the Department of Environmental Protection.

313.3 Minimum structure-borne noise and vibration isolation requirements. All isolators shall comply with the requirements of Sections 313.3.1 through 313.3.10. Where vibration isolation of equipment and appliances is employed, supplemental restraint shall be used to accomplish the support and restraint.

Exception: When specified by the registered design professional, the requirements of Sections 313.3.1 through 313.3.10 may be modified provided that the equipment, appliances, and supports shall be designed and installed so that continuous or intermittent vibration transmitted to structural slabs shall not exceed the following values between 8 Hz and 80 Hz on the structural slab in the affected occupancy space:

1. Group E, I or R occupancies: 5,600 microinches (142.4 um) per second.
2. All other occupancies: 16,000 microinches (406.4 um) per second.

For the purposes of this exception, transmitted vibration shall be in accordance with the following parameters:

1. The peak third-octave band RMS velocity measurements.
2. The method shall be in accordance with ANSI/ASA S2.71.

313.3.1 Boiler rooms. Boilers, boiler breeching, and boiler piping shall be isolated in accordance with the applicable requirements of Sections 313.3.1.1 and 313.3.1.2.

313.3.1.1 Boilers. All boilers supported on floors directly above a story having dwelling units shall be supported on resilient isolators having a minimum static deflection of 1 inch (25.4 mm). The isolators shall be installed directly under the structural frame of the boiler.

313.3.1.2 Boiler breeching and piping. When boilers are equipped with mechanical draft fans, the boiler breeching and piping that are supported from or on slabs, floors or walls that are contiguous to the dwelling unit shall be supported for a distance of 50 pipe diameters on or from resilient isolators. Each isolator shall have a minimum static deflection of 1 inch (25.4 mm).

313.3.2 Refuse charging chutes. Metal chutes, chute supports, and chute bracing shall be installed in accordance with Section 313.3.2.1. Masonry chutes must comply with Section 313.3.2.2.

313.3.2.1 Metal chutes. Metal chutes, metal chute supports, and/or metal chute bracing shall be free of direct contact with the shaft enclosure and the openings provided in the floor construction. Metal chutes shall be resiliently supported at each structural support location. Isolators shall provide a minimum static deflection of 0.30 inches (7.62 mm). All chutes shall be plumb.

313.3.2.2 Masonry chutes. The interior chute wall shall be plumb and without obstructions for the full height of the shaft and shall have a smooth interior finish.

313.3.3 Piping. Equipment piping shall be installed as follows:

- 1. Metal piping connected to power driven equipment shall be resiliently supported from or on the building structure for a distance of 50 pipe diameters from the power driven equipment. The resilient isolators shall have a minimum static deflection of 1 inch (25.4 mm) for all piping with a 4 inch (101.6 mm) or larger in actual outside diameter and ½ inch (12.7 mm) for piping with less than 4 inches (101.6 mm) in actual outside diameter. Piping connected to fluid pressure-reducing valves shall be resiliently isolated for a distance of 50 pipe diameters from pressure-reducing valves and isolators shall provide a minimum static deflection of ½ inch (12.7 mm).**
- 2. Equipment such as heat exchangers, absorption refrigeration machines, or similar equipment, that is located on any floor or roof other than a floor on grade, and that is not power driven but is connected by metal piping to power driven equipment, shall be resiliently supported from or on the building structure, for a distance of 50 pipe diameters from the power driven equipment. The resilient supports shall be vibration isolators having a minimum static deflection of 1 inch (25.4 mm) and shall incorporate approved resilient pads having a minimum thickness of ¼ inch (6.4 mm).**

313.3.4 Fans. All fan equipment with motors in excess of ½ horsepower (0.37 kW), located on any roof or floor other than a floor on grade shall be mounted on or from vibration isolators. Fan equipment with motor drives separated from the fan equipment shall be supported on an isolated

integral rigid structural base supporting both the fan and motor. Fan equipment with motor drives supported from the fan equipment shall be mounted directly on vibration isolators. Each isolator shall have provision for leveling. Isolators shall incorporate resilient pads having a minimum thickness of ¼ inch (6.4 mm). The vibration isolators shall provide a minimum isolation efficiency of 90 percent at fan rotor rpm with a maximum deflection of 2 inches ([54] 50.8 mm). Fans and compressors assembled in unitary containers may meet this requirement with isolators internal to the container providing the isolators meet the above minimum isolator efficiencies.

313.3.5 Pumps. All pumps of 3 horsepower (2.24 kW) or more located on any floor other than a floor on grade shall be supported on vibration isolators having a minimum isolation efficiency of 90 percent at the lowest disturbing frequency. Each isolator shall incorporate a leveling device and a resilient pad having a minimum thickness of ¼ inch (6.4 mm).

313.3.6 Compressors. Compressors and drives located on a floor other than a floor on grade shall be mounted on vibration isolators having a minimum isolation efficiency of 90 percent at the lowest disturbing frequency. Each isolator shall incorporate a leveling device and a resilient pad having a minimum thickness of ¼ inch (6.4 mm).

313.3.7 Cooling towers and fluid coolers. All moving parts of cooling towers located on a roof or floor other than a floor on grade shall be installed on vibration isolators providing a minimum isolation efficiency of 90 percent at fan rotor rpm with a maximum static deflection of 4 inches (101.6 mm). Each isolator shall incorporate a leveling device and a resilient pad having a minimum thickness of ¼ inch (6.4 mm). Vibration cutoff switches shall be provided.

313.3.8 Evaporative condensers. Evaporative and air cooled condensers located on a roof or floor other than a floor on grade shall be mounted on vibration isolators providing a minimum isolation efficiency of 90 percent at fan rotor rpm with a maximum static deflection of 4 inches (101.6 mm). Each isolator shall incorporate a leveling device and a resilient pad having a minimum thickness of ¼ inch (6.4 mm). Vibration cutoff switches shall be provided on evaporative condensers.

313.3.9 Duct connections to fans. Flexible connections shall be installed between fan equipment and connecting ductwork.

313.3.10 Ceiling suspended packaged HVAC units with compressors. Equipment such as heat pumps, air-conditioning units, or similar equipment, that is suspended from a structure shall be resiliently supported from or on the building structure. Vibration isolators shall have a minimum isolation efficiency of 90 percent at the lowest disturbing frequency.

§ 5. Chapter 4 of the New York city mechanical code, as amended by local law number 141 for the year 2013, section 401.5 as amended by local law number 51 for the year 2014, and section 403.3 as amended by local law number 187 for the year 2017, is amended to read as follows:

CHAPTER 4 VENTILATION

SECTION MC 401 GENERAL

401.1 Scope. This chapter shall govern the ventilation of spaces within a building intended to be occupied. Mechanical exhaust systems, including exhaust systems serving clothes dryers and cooking appliances; hazardous exhaust systems; dust, stock and refuse conveyor systems; subslab soil exhaust systems; smoke control systems; energy recovery ventilation systems and other systems specified in Section 502 shall comply with Chapter 5.

401.2 Ventilation required. Habitable and occupiable spaces shall be provided with ventilation in accordance with this section.

1. Every occupiable space shall be:

1.1. Naturally ventilated [by natural means] in accordance with Section 402 and mechanically exhausted in accordance with Table 403.3.1.1; or

1.2. [by mechanical means] Mechanically ventilated in accordance with Section 403.

2. All habitable spaces and occupiable spaces provided with air conditioning shall be mechanically ventilated in accordance with Section 403.

3. Every habitable space shall be naturally ventilated [by natural means] in accordance with Section 402 [and,].

4. Every habitable space shall be mechanically ventilated if required by [Table 403.3, by mechanical means in accordance with] Section 403.

Ambulatory care facilities (Group B) and Group I-2 occupancies shall be ventilated by mechanical means in accordance with Section 407.

401.3 When required. Ventilation shall be provided during the periods that the room or space is occupied or during operation of gas appliances.

401.4 Intake [Opening] opening location. [A]# Ventilation air intake openings shall comply with all of the following:

1. Intake openings shall be located [a minimum of] not less than 10 feet (3048 mm) from lot lines or buildings on the same lot. For buildings on lots measuring less than 20 feet (6096 mm) in width, intake openings shall be located at the centerline between lot lines. Where openings front on a street or public way, the distance shall be measured to the centerline of the street or public way.

2. Outdoor air intakes for [high-rise] office [buildings] occupancies having occupied floors located more than 75 feet (22 860 mm) above the lowest level of fire department vehicle access serving spaces above the second story and serving spaces greater than 10,000 square

feet (929 m²) of floor area shall be located at least 20 feet (6096 mm) above ground level, at least 30 feet (9144 mm) from exhaust outlets and other exhaust discharges, and at least 20 feet (6096 mm) from areas that may collect vehicular exhaust, such as off street loading bays.

3. Mechanical and gravity outdoor air intake openings shall be located not less than 10 feet (3048 mm) horizontally from any hazardous or noxious contaminant source, such as vents, exhausts (including but not limited to exhaust from dry cleaning establishments, spray booths, and cooling towers), streets, alleys, parking lots and loading docks, except as specified in Item 3 of Section ~~[501.2.1]~~ 501.3.1. Outdoor air intake openings shall be permitted to be located less than 10 feet (3048 mm) horizontally from streets, alleys, parking lots and loading docks provided that the openings are located not less than 25 feet (7620 mm) vertically above such locations. Where openings front on a street or public way, the distance shall be measured from the closest edge of the street or public way.
4. Where the requirements of Item 3 above cannot be achieved, intake openings shall be located not less than 3 feet (~~[914]~~ 914.4 mm) below contaminant sources where such sources are located within 10 feet (3048 mm) of the opening.
5. Intake openings in Group I occupancies shall comply with ANSI/ASHRAE/ASHE 170, as required.
6. Intake openings on structures in flood hazard areas shall comply with the additional requirements of Appendix G of the New York City Building Code.

Exception: Group R-3 occupancies are not required to comply with Section 401.4. [-]

[401.4] 401.4.1 Required dampers in intake openings. ~~[An outdoor air intake opening with gross area of more than 144 square inches (0.0929 m²) shall be provided with fire dampers and smoke dampers, or combined fire and smoke dampers when such opening is located as follows:]~~
Outdoor air intakes shall be provided with dampers in accordance with Chapter 6.

~~[1. Less than 30 feet (9144 mm) above grade.]~~

~~[2. Less than 30 feet (9144 mm) in any direction from any opening in another building.]~~

~~[3. Less than 15 feet (4572 mm) from a lot line.]~~

~~[4. Less than 50 feet (15 240 mm) above and less than 50 feet (15 240 mm) in any direction from a roof constructed of combustible material or a building in which the exterior walls are constructed wholly or partly of wood.]~~

~~[5. Where fire dampers are required by Section 607.5.6.]~~

[Exceptions:]

- ~~[1. Smoke dampers shall not be required for outdoor air intake openings installed in any construction required to have a fire resistance rating that is less than 2 hours.]~~

[2. Smoke dampers shall not be required for outdoor air intake openings of systems greater than 15,000 cfm (7.1 m³/s) which are provided with smoke dampers in accordance with Chapter 6 of this code and arranged so as to not introduce smoke into the building or space in which the equipment is located.]

401.5 Intake opening protection. Air intake openings that terminate outdoors shall be protected with corrosion-resistant screens, louvers or grilles. Openings in louvers, grilles and screens shall be sized in accordance with Table [401.6] 401.5, and shall be protected against local weather conditions. Outdoor air intake openings located in exterior walls shall meet the provisions for exterior wall opening protectives in accordance with Section 705 of the New York City Building Code.

**TABLE 401.5
OPENING SIZES IN LOUVERS, GRILLES AND SCREENS PROTECTING OUTDOOR EXHAUST AND
AIR INTAKE OPENINGS**

OUTDOOR OPENING TYPE	MINIMUM AND MAXIMUM OPENING SIZES IN LOUVERS, GRILLES AND SCREENS MEASURED IN ANY DIRECTION
Intake openings in residential occupancies	Not < ¼ inch and not > ½ inch
Intake openings in other than residential occupancies	[Not < ¼] ≥ ¼ inch and not > 1 inch

For SI: 1 inch = 25.4 mm.

401.6 Contaminant sources. Stationary local sources producing air-borne particulates, heat, odors, fumes, spray, vapors, smoke or gases in such quantities as to be irritating or injurious to health shall be provided with an exhaust system in accordance with Chapter 5 or a means of collection and removal of the contaminants. Such exhaust shall discharge directly to an approved location at the exterior of the building.

401.6.1 Wind-driven rain [rating]. All exterior louvers for building ventilation systems shall [either:] conform to the requirements of Chapter 16 of the *New York City Building Code*, where applicable, and the following:

1. [Receive an A rating according to] Comply with the requirements of AMCA 550 [for wind driven rain penetration for a 50 mile per hour (80.4 km/h) wind velocity with a rainfall rate of 8 inches (203 mm) per hour]. Louvers shall comply with the intrusion requirements of wind-driven rain without the use of a damper. Outdoor air intake openings located in exterior walls shall meet the provisions for exterior wall opening protectives in accordance with Chapter 16 of the New York City Building Code; or
2. Be installed on a plenum configured to intercept any wind-driven rain penetrating the louver and to prevent the rain from entering the building ductwork system. Such plenum shall be waterproofed and equipped with a drainage system to convey water penetrating the louver [to storm or sanitary drains] directly to the outdoors or in accordance with the New York City Plumbing Code.

SECTION MC 402 NATURAL VENTILATION

402.1 General. Natural ventilation of [~~occupied~~] occupiable and habitable spaces shall comply with Chapter 12 of the *New York City Building Code*.

402.2 Reserved.

402.3 Reserved.

402.4 Reserved.

SECTION MC 403 MECHANICAL VENTILATION

403.1 Ventilation system. Mechanical ventilation shall be provided by a method of supply air and return or exhaust air. The amount of supply air shall be approximately equal to the amount of return and exhaust air. The system shall not be prohibited from producing negative or positive pressure; such pressures shall not result in door opening forces in excess of those indicated in the *New York City Building Code* and shall not prevent doors from closing as required by the *New York City Building Code*. The [~~system~~] method to convey ventilation air shall be designed and installed in accordance with Chapter 6.

403.2 Outdoor air required. The minimum outdoor airflow rate shall be determined in accordance with Section [~~403.3~~] 403.3.1.1. [~~Ventilation supply systems shall be designed to deliver the required rate of outdoor airflow to the breathing zone within each occupiable space.~~]

Exception: [~~Where a registered design professional demonstrates that an engineered ventilation system design will prevent the maximum concentration of contaminants from exceeding that obtainable by the rate of outdoor air ventilation determined in accordance with Section 403.3, the minimum required rate of outdoor air shall be reduced in accordance with such engineered system design.~~] The minimum required rate of outdoor air may be reduced where the registered design professional demonstrates that an engineered ventilation system is designed in accordance with ASHRAE 62.1 Indoor Air Quality Procedure.

403.2.1 Recirculation of air. The outdoor air required by Section [~~403.3~~] 403.3.1.1 shall not be recirculated. Air in excess of that required by Section [~~403.3~~] 403.3.1.1 shall not be prohibited from being recirculated as a component of supply air to building spaces, except that:

1. Ventilation air shall not be recirculated from one dwelling unit to another or to dissimilar occupancies.
2. Supply air to a swimming pool and associated deck areas shall not be recirculated unless such air is dehumidified to maintain the relative humidity of the area at 60 percent or less. Air from this area shall not be recirculated to other uses or occupancies.
3. Where mechanical exhaust is required by Note b [~~of~~] in Table [~~403.3~~] 403.3.1.1, recirculation of air from such spaces shall be prohibited. [~~At~~] Recirculation of air that is contained completely within such spaces shall not be prohibited. Where recirculation of

air is prohibited, all air supplied to such spaces shall be exhausted, including any air in excess of that required by Table [403.3] 403.3.1.1.

4. Where mechanical exhaust is required by Note g [ø] in Table [403.3] 403.3.1.1, mechanical exhaust is required and recirculation is prohibited. Recirculation of air that is contained completely within such spaces shall not be prohibited.

403.2.2 Transfer air. Except where recirculation from such spaces is prohibited by Table [403.3] 403.3.1.1, air transferred from occupiable spaces is not prohibited from serving as makeup air for required exhaust systems in such spaces as kitchens, baths, toilet rooms, elevators and smoking lounges. The amount of transfer air and exhaust air shall be sufficient to provide the flow rates as specified in Section [403.3] 403.3.1.1. The required outdoor airflow rates specified in Table [403.3] 403.3.1.1 shall be introduced directly into such spaces or into the occupied spaces from which air is transferred or a combination of both.

403.3 Outdoor air and local exhaust airflow rates. Buildings that are not more than three stories in height above grade plane, and that (i) are within Occupancy Group R-2 or Occupancy Group R-3, (ii) are adult homes or enriched living housing as described in Section 308.3.1 of the *New York City Building Code*, within Occupancy Group I-1 and have 16 occupants or fewer, or (iii) are community residences or intermediate-care facilities as described in Section 308.3.2 of the *New York City Building Code*, shall be provided with outdoor air and local exhaust in accordance with Section 403.3.1.1.2. All other buildings intended to be occupied shall be provided with outdoor air and local exhaust in accordance with Sections 403.3.1.1 through 403.3.1.6.

403.3.1 Reserved.

403.3.1.1 Outdoor airflow rate. Ventilation systems shall be designed to have the capacity to supply the minimum outdoor airflow rate [·] determined in accordance with this section. In each occupiable space and, where required, each habitable space, the ventilation system shall be designed to deliver the required rate of outdoor airflow to the breathing zone. The occupant load utilized for design of the ventilation system shall be not [ø] less than the number determined from the estimated maximum occupant load rate indicated in Table [403.3] 403.3.1.1. Ventilation rates for occupancies not represented in Table [403.3] 403.3.1.1 shall be those for a listed occupancy classification that is most similar in terms of occupant density, activities and building construction; or shall be determined by an approved engineering analysis. The ventilation system shall be designed to supply the required rate of ventilation air continuously during the period the building is occupied, except as otherwise stated in other provisions of the code.

With the exception of non-tobacco hookah establishments, the ventilation rates in Table [403.3] 403.3.1.1 are based on the absence of smoking in occupiable spaces. Where smoking is anticipated in a space other than a non-tobacco hookah establishment, the ventilation system serving the space shall be designed to provide ventilation over and above that required by Table [403.3] 403.3.1.1 in accordance with accepted engineering practice.

[Exception] Exceptions:

1. The occupant load is not required to be determined [5] based on the estimated maximum occupant load rate indicated in Table [403.3] 403.3.1.1 [5] where approved statistical data documents the accuracy of an alternate anticipated occupant ~~density~~ load.
2. The occupant load used in computing the required ventilation shall be the maximum number who will occupy the room or space simultaneously during any 2-hour period.
3. Dynamic reset (Demand Controlled Ventilation). The system may be designed to reset the design outdoor air intake airflow and/or space or zone airflow as operating conditions change. Dynamic reset shall be designed in accordance with ASHRAE 62.1 and comply with footnote k of Table 403.3.1.1. These conditions include, but are not limited to:
 - 3.1 Variations in occupancy or ventilation airflow in one or more individual zones for which ventilation airflow requirements will be reset. Note: Examples of measures for estimating such variations include: occupancy scheduled by time of day, a direct count of occupants, or an estimate of occupancy or ventilation rate per person using occupancy sensors such as those based on indoor CO₂ concentrations.
 - 3.2 Variations in the efficiency with which outdoor air is distributed to the occupants under different ventilation system airflows and temperatures.
 - 3.3 A higher fraction of outdoor air in the air supply due to intake of additional outdoor air for free cooling or exhaust air makeup.

**TABLE [403.3] 403.3.1.1
MINIMUM VENTILATION RATES**

OCCUPANCY CLASSIFICATION	<u>OCCUPANT DENSITY</u> #/1000 FT ^{2a}	PEOPLE OUTDOOR AIRFLOW RATE IN BREATHING ZONE, R _b CFM/PERSON	AREA OUTDOOR AIRFLOW RATE IN BREATHING ZONE R _a CFM/FT ^{2a}	[DEFAULT OCCUPANT DENSITY #/1000 FT ^{2a}]	EXHAUST AIRFLOW RATE CFM/FT ^{2a}
Correctional facilities					
<u>Booking/waiting</u>	<u>50</u>	<u>7.5</u>	<u>0.06</u>		=
Cells					
without plumbing fixtures	<u>25</u>	5	0.12	[25]	—
with plumbing fixtures ^g	<u>25</u>	5	0.12	[25]	1.0
<u>Day room</u>	<u>30</u>	<u>5</u>	<u>0.06</u>		=
Dining halls (see food and beverage service)	=	—	—	[—]	—
Guard stations	<u>15</u>	5	0.06	[15]	—
[Day room]		[5]	[0.06]	[30]	[—]
[Booking/waiting]		[7.5]	[0.06]	[50]	[—]
Dry cleaners, laundries					
Coin-operated dry cleaner	<u>20</u>	15	—	[20]	—
Coin-operated laundries	<u>20</u>	7.5	0.06	[20]	—
Commercial dry cleaner ^l	<u>30</u>	30	—	[30]	—
Commercial laundry	<u>10</u>	25	—	[10]	—
Storage, pick up	<u>30</u>	7.5	0.12	[30]	—
Education					
<u>Art classroom^e</u>	<u>20</u>	<u>10</u>	<u>0.18</u>		<u>0.7</u>
Auditoriums	<u>150</u>	5	0.06	[150]	—
Classrooms (ages 5-8)	<u>25</u>	<u>10</u>	<u>0.12</u>		=
Classrooms (age 9 plus)	<u>35</u>	<u>10</u>	<u>0.12</u>		=
Computer lab	<u>25</u>	<u>10</u>	<u>0.12</u>		=
Corridors (see public spaces)	=	—	—	[—]	—
Day care (through age 4)	<u>25</u>	<u>10</u>	<u>0.18</u>		=
Lecture classroom	<u>65</u>	<u>7.5</u>	<u>0.06</u>		=
Lecture hall (fixed seats)	<u>150</u>	<u>7.5</u>	<u>0.06</u>		=
Locker/dressing rooms ^g	=	=	=		<u>0.25</u>
Media center	25	10	0.12	[25]	—
Multiuse assembly	<u>100</u>	<u>7.5</u>	<u>0.06</u>		=
Music/theater/dance	<u>35</u>	<u>10</u>	<u>0.06</u>		=
Science laboratories ^{e,k}	<u>25</u>	<u>10</u>	<u>0.18</u>		1.0
Sports locker rooms ^g	=	—	—	[—]	0.5
[Music/theater/dance]		[10]	[0.06]	[35]	[—]
[Smoking lounges ^h]		[60]	[—]	[70]	[—]
[Day care (through age 4)]		[10]	[0.18]	[25]	[—]
[Classrooms (ages 5-8)]		[10]	[0.12]	[25]	[—]
[Classrooms (age 9 plus)]		[10]	[0.12]	[35]	[—]
[Lecture classroom]		[7.5]	[0.06]	[65]	[—]
[Lecture hall (fixed seats)]		[7.5]	[0.06]	[150]	[—]
[Art classroom]		[10]	[0.18]	[20]	[0.7]
[Science laboratories ^{e,k}]		[10]	[0.18]	[25]	[1.0]
Wood/metal shops ^g	<u>20</u>	10	0.18	[20]	0.5
[Computer lab]		[10]	[0.12]	[25]	[—]
[Multiuse assembly]		[7.5]	[0.06]	[100]	[—]
[Locker/dressing rooms ^g]		[—]	[—]	[—]	[0.25]
Food and beverage service					
Bars, cocktail lounges	<u>100</u>	7.5	0.18	[100]	—
Cafeteria, fast food	<u>100</u>	7.5	0.18	[100]	—

**TABLE [403.3] 403.3.1.1
MINIMUM VENTILATION RATES**

OCCUPANCY CLASSIFICATION	OCCUPANT DENSITY #/1000 FT ^{2a}	PEOPLE OUTDOOR AIRFLOW RATE IN BREATHING ZONE, R _b CFM/PERSON	AREA OUTDOOR AIRFLOW RATE IN BREATHING ZONE R _a CFM/FT ^{2a}	[DEFAULT OCCUPANT DENSITY #/1000 FT ^{2a}]	EXHAUST AIRFLOW RATE CFM/FT ^{2a}
Dining rooms	<u>70</u>	7.5	0.18	[70]	—
Kitchens (cooking) ^b	—	—	—	[—]	0.7
[Non-tobacco] Non-tobacco smoking establishments ^b	<u>70</u>	60	—	[70]	—
[Hospitals, nursing and convalescent homes]					
[Autopsy rooms] ^b		[—]	[—]	[—]	[0.5]
[Medical procedure rooms]		[45]	[—]	[20]	[—]
[Operating rooms]		[30]	[—]	[20]	[—]
[Patient rooms]		[25]	[—]	[10]	[—]
[Physical therapy]		[45]	[—]	[20]	[—]
[Recovery and ICU]		[45]	[—]	[20]	[—]
Hotels, motels, resorts and dormitories					
[Multipurpose assembly]		[5]	[0.06]	[120]	[—]
Bathrooms/toilet—private ^e	-	—	—	[—]	25/50 ^f
Bedroom/living room	<u>10</u>	5	0.06	[10]	—
Conference/meeting	<u>50</u>	5	0.06	[50]	—
Dormitory sleeping areas	<u>20</u>	5	0.06	[20]	—
Gambling casinos	<u>120</u>	7.5	0.18	[120]	—
Lobbies/prefunction	<u>30</u>	7.5	0.06	[30]	—
<u>Multipurpose assembly</u>	<u>120</u>	<u>5</u>	<u>0.06</u>		—
Laboratories ^{[M] i}					
Biological		—	1.0	—	1.0
Chemical		—	1.0	—	1.0
Industrial and nonteaching		—	1.0	—	1.0
Nonproduction chemical labs		—	1.0	—	1.0
Offices					
Conference rooms	<u>50</u>	5	0.06	[50]	—
<u>Main entry lobbies</u>	<u>10</u>	<u>5</u>	<u>0.06</u>		—
Office spaces	<u>5</u>	5	0.06	[5]	—
Reception areas	<u>30</u>	5	0.06	[30]	—
Telephone/data entry	<u>60</u>	5	0.06	[60]	—
[<u>Main entry lobbies</u>]		[5]	[0.06]	[10]	[—]
Private dwellings, single and multiple					
Garages, common for multiple units ^b	—	—	—	[—]	0.75
[Garages, separate for each dwelling] ^b		[—]	[—]	[—]	[100 cfm per car]
Kitchens and Kitchenettes ^{b,m}	—	—	—	[—]	25/100 ^f
Living areas ^{e,i}	<u>Based upon number of bedrooms. First bedroom, 2; each additional</u>	0.35 ACH but not less than 15 cfm/person	—	<u>Based upon number of bedrooms. First bedroom, 2; each additional bedroom,</u>	—
Toilet rooms and bathrooms ^e	—	—	—	[—]	20/50 ^f
Public spaces					
Corridors	—	—	0.06	[—]	—
<u>Courtrooms</u>	<u>70</u>	<u>5</u>	<u>0.06</u>		—
Elevator car	—	—	—	[—]	1.0
<u>Legislative chambers</u>	<u>50</u>	<u>5</u>	<u>0.06</u>		—

**TABLE [403.3] 403.3.1.1
MINIMUM VENTILATION RATES**

OCCUPANCY CLASSIFICATION	OCCUPANT DENSITY #/1000 FT ^{2a}	PEOPLE OUTDOOR AIRFLOW RATE IN BREATHING ZONE, R _b CFM/PERSON	AREA OUTDOOR AIRFLOW RATE IN BREATHING ZONE R _a CFM/FT ^{2a}	[DEFAULT OCCUPANT DENSITY #/1000 FT ^{2a}]	EXHAUST AIRFLOW RATE CFM/FT ^{2a}
Libraries	10	5	0.12		=
Museums (children's)	40	7.5	0.12		=
Museums/galleries	40	7.5	0.06		=
Places of religious worship	120	5	0.06		=
Shower room (per shower head) ^g	=	—	—	[—]	50/20 ^f
[Smoking lounges ^b]		[60]	[—]	[70]	[—]
Toilet rooms – public ^g	=	—	—	[—]	50/70 ^e
[Places of religious worship]		[5]	[0.06]	[120]	[—]
[Courtrooms]		[5]	[0.06]	[70]	[—]
[Legislative chambers]		[5]	[0.06]	[50]	[—]
[Libraries]		[5]	[0.12]	[10]	[—]
[Museums (children's)]		[7.5]	[0.12]	[40]	[—]
[Museums/galleries]		[7.5]	[0.06]	[40]	[—]
Retail stores, sales floors and showroom floors					
[Sales (except as below)]		[7.5]	[0.12]	[15]	[—]
Dressing rooms	=	—	—	[—]	0.25
Mall common areas	40	7.5	0.06	[40]	—
Sales	15	7.5	0.12		=
Shipping and receiving	=	—	0.12	[—]	—
Smoking lounges and non-tobacco smoking establishments ^b	70	60	—	[70]	—
Storage rooms	=	—	0.12	[—]	—
Warehouses (see storage)	=	—	—	[—]	—
Specialty shops					
Automotive motor-fuel dispensing stations ^b	=	—	—	[—]	1.5
Barber	25	7.5	0.06	[25]	0.5
Beauty [and nail] salons (without nail salon services) ^{b, h, i}	25	20	0.12	[25]	0.6
Nail salons ^{b, h}	25	20	0.12		0.6
Embalming room ^b	=	—	—	[—]	2.0
Pet shops (animal areas) ^b	10	7.5	0.18	[40]	0.9
Supermarkets	8	7.5	0.06	[8]	—
Sports and amusement					
[Disco/dance floors]		[20]	[0.06]	[100]	[—]
Bowling alleys (seating areas)	40	10	0.12	[40]	—
Disco/dance floors	100	20	0.06		=
Game arcades	20	7.5	0.18	[20]	—
[Ice arenas without combustion engines]		[—]	[0.30]	[—]	[0.5]
Gym, stadium, arena (play area)	=	—	0.30	[—]	—
Health club/aerobics room	40	20	0.06		=
Health club/weight room	10	20	0.06		=
Ice arenas without combustion engines	=	=	0.30		0.5
Spectator areas	150	7.5	0.06	[150]	—
Swimming pools (pool and deck area)	=	—	0.48	[—]	—
[Health club/aerobics room]		[20]	[0.06]	[40]	[—]
[Health club/weight room]		[20]	[0.06]	[40]	[—]
Storage					
Repair garages, enclosed parking garages ^{b, d}	=	—	—	[—]	0.75
Warehouses	=	—	0.06	[—]	—
Theaters					

**TABLE [403.3] 403.3.1.1
MINIMUM VENTILATION RATES**

OCCUPANCY CLASSIFICATION	<u>OCCUPANT DENSITY #/1000 FT^{2a}</u>	PEOPLE OUTDOOR AIRFLOW RATE IN BREATHING ZONE, <u>R_b</u> CFM/PERSON	AREA OUTDOOR AIRFLOW RATE IN BREATHING ZONE <u>R_a</u> CFM/FT ^{2a}	[DEFAULT OCCUPANT DENSITY #/1000 FT ^{2a}]	EXHAUST AIRFLOW RATE CFM/FT ^{2a}
Auditoriums (see education)	—	—	—	[—]	—
Lobbies	<u>150</u>	5	0.06	[150]	—
Stages, studios	<u>70</u>	10	0.06	[70]	—
Ticket booths	<u>60</u>	5	0.06	[60]	—
Transportation					
Platforms	<u>100</u>	7.5	0.06	[100]	—
Transportation waiting	<u>100</u>	7.5	0.06	[100]	—
Workrooms					
Bank vaults/safe deposit	<u>5</u>	5	0.06	[5]	—
Computer (without printing)	<u>4</u>	<u>5</u>	<u>0.06</u>		—
<u>Copy, printing rooms</u>	<u>4</u>	<u>5</u>	<u>0.06</u>		<u>0.5</u>
Darkrooms	—	—	—	[—]	1.0
[Copy, printing rooms]		[5]	[0.06]	[4]	[0.5]
Meat processing ^c	<u>10</u>	15	—	[10]	—
Pharmacy (prep. area)	<u>10</u>	5	0.18	[10]	—
Photo studios	<u>10</u>	5	0.12	[10]	—
[Computer (without printing)]		[5]	[0.06]	[4]	[—]

For SI: 1 cubic foot per minute = 0.0004719 m³/s, 1 ton = 908 kg, 1 cubic foot per minute per square foot = 0.00508m³/(s • m²), °C = ((°F) -32) /1.8, 1 square foot = 0.0929 m².

- a. Based upon net occupiable floor area.
- b. Mechanical exhaust required and the recirculation of air from such spaces is prohibited (see Section 403.2.1, Item [4] 3).
- c. Spaces unheated or maintained below 50°F are not covered by these requirements unless the occupancy is continuous.
- d. Ventilation systems in enclosed parking garages shall comply with Section 404.
- e. Rates are per water closet or urinal. The higher rate shall be provided where [periods of heavy use are expected to occur, such as toilets in theaters, schools and sports facilities] the exhaust system is designed to operate intermittently. The lower rate shall be permitted only where [periods of heavy use are not expected] the exhaust system is designed to operate continuously while the space served by the toilet facilities is occupied.
- f. Rates are per room unless otherwise indicated. The higher rate shall be provided where the exhaust system is designed to operate intermittently. The lower rate shall be permitted only where the exhaust system is designed to operate continuously [during normal hours of use] while the dwelling unit or sleeping unit served by the toilet facility is occupied.
- g. Mechanical exhaust is required and recirculation from such spaces is prohibited (see Section 403.2.1, Item 4).
- h. For nail salons, [the required exhaust shall include ventilation tables or other systems that capture the contaminants and odors at their source and are capable of exhausting a minimum of 50 cfm/ft² per station] each manicure and pedicure station shall be provided with a source capture system capable of exhausting not less than 50 cfm per station. Exhaust inlets shall be located in accordance with Section 502.20. Where one or more required source capture systems operate continuously during occupancy, the exhaust rate from such systems shall be permitted to be applied to the exhaust flow rate required by Table 403.3.1.1 for the nail salon.
- i. [For R-2 buildings less than 125 feet in height, outdoor ventilation air provided by mechanical means serving dwelling units designed to exceed 100 cfm per dwelling unit, whether intermittent or continuous, shall be required. For buildings 125 feet and greater, outdoor ventilation air shall be provided by mechanical means when the sum of the exhaust designed to exceed 75 cfm, whether continuous or intermittent, per dwelling unit. Manually operated openable exterior wall openings shall not be used to provide outside ventilation air except where calculations are submitted showing that such openings are located at or below the lowest calculated neutral pressure plane (calculated at the winter outdoor design temperature, and taking into account a composite mass flow air balance of the building including all mechanical systems).] For each dwelling unit within R-2 occupancies, outdoor ventilation air shall be provided by mechanical means when the sum of all exhaust air flow rates, whether continuous or intermittent, is designed to exceed 75 cfm. When provided, mechanical ventilation air flow rate shall be approximately equal to the exhaust air flow rate in accordance with Section 403.1 and shall not be less than that required by the air flow rates prescribed in Table 403.3.1.1. For such dwelling units, manually operated openable exterior wall openings shall not be used to provide required mechanical ventilation air.
- j. During unoccupied hours the ventilation rate and exhaust rates may be reduced to 0.5 cfm/ft².
- k. When an educational science laboratory is occupied and hoods are not in use and hazardous materials are not present, then ventilation rates shall be consistent with actual use of the space, but not less than 0.5 cfm/ft².
- l. See Section 502.6 for additional requirements.
- m. Exception: kitchens and kitchenettes in dwelling units of R-2 occupancy may be naturally ventilated in accordance with Section 402.

[403.3.1] 403.3.1.1.1 Zone outdoor airflow. The minimum outdoor airflow required to be supplied to each zone shall be determined as a function of occupancy classification and space air distribution effectiveness in accordance with Sections [403.3.1.1] 403.3.1.1.1.1 through [403.3.1.3] 403.3.1.1.1.3.

[403.3.1.1] 403.3.1.1.1 Breathing zone outdoor airflow. The outdoor airflow rate required in the breathing zone V_{bz} of the occupiable space or spaces in a zone shall be determined in accordance with Equation 4-1.

$$V_{bz} = R_p P_z + R_a A_z \quad \text{(Equation 4-1)}$$

where:

A_z = Zone floor area: the net occupiable floor area of the space or spaces in the zone.

P_z = Zone population: the number of people in the space or spaces in the zone.

R_p = People outdoor air rate: the outdoor airflow rate required per person from Table [403.3] 403.3.1.1.

R_a = Area outdoor air rate: the outdoor airflow rate required per unit area from Table [403.3] 403.3.1.1.

[403.3.1.2] 403.3.1.1.2 Zone air distribution effectiveness. The zone air distribution effectiveness (E_z) shall be determined using Table [403.3.1.2] 403.3.1.1.2.

**TABLE [403.3.1.2] 403.3.1.1.2
ZONE AIR DISTRIBUTION EFFECTIVENESS^{a,b,c,d [e]}**

AIR DISTRIBUTION CONFIGURATION	E_z
Ceiling or floor supply of cool air	1.0 ^{[f] e}
Ceiling or floor supply of warm air and floor return	1.0
Ceiling supply of warm air and ceiling return	0.8 ^{[g] f}
Floor supply of warm air and ceiling return	0.7
Makeup air drawn in on the opposite side of the room from the exhaust and/or return	0.8
Makeup air drawn in near to the exhaust and/or return location	0.5

For SI: 1 foot = 304.8 mm, 1 foot per minute = 0.00506 m/s, °C = ((°F) - 32) / 1.8.

a. "Cool air" is air cooler than space temperature.

b. "Warm air" is air warmer than space temperature.

c. "Ceiling" includes any point above the breathing zone.

d. "Floor" includes any point below the breathing zone.

~~[e.] "Makeup air" is air supplied or transferred to a zone to replace air removed from the zone by exhaust or return systems.~~

[f.] e. Zone air distribution effectiveness of 1.2 shall be permitted for systems with a floor supply of cool air and ceiling return, provided that low-velocity displacement ventilation achieves unidirectional flow and thermal stratification.

[g.] f. Zone air distribution effectiveness of 1.0 shall be permitted for systems with a ceiling supply of warm air, provided that supply air temperature is less than 15°F above space temperature and provided that the 150 foot-per-minute supply air jet reaches to within 4½ feet of floor level.

[403.3.1.3] 403.3.1.1.3 Zone outdoor airflow. The zone outdoor [air flow] airflow rate (V_{oz}), shall be determined in accordance with Equation 4-2.

$$V_{oz} = \frac{V_{bz}}{E_z} \quad \text{(Equation 4-2)}$$

[403.3.2] 403.3.1.1.2 System outdoor airflow. The outdoor air required to be supplied by each ventilation system shall be determined in accordance with Sections [403.3.2.1] 403.3.1.1.2.1 through [403.3.2.3] 403.3.1.1.2.3 as a function of system type and zone outdoor airflow rates.

[403.3.2.1] 403.3.1.1.2.1 Single zone systems. Where one air handler supplies a mixture of outdoor air and recirculated return air to only one zone, the system outdoor air intake flow rate (V_{ot}) shall be determined in accordance with Equation 4-3.

$$V_{ot} = V_{oz} \quad \text{(Equation 4-3)}$$

[403.3.2.2] 403.3.1.1.2.2 100-percent outdoor air systems. Where one air handler supplies only outdoor air to one or more zones, the system outdoor air intake flow rate (V_{ot}) shall be determined using Equation 4-4.

$$V_{ot} = \sum_{\text{all zones}} V_{oz} \quad \text{(Equation 4-4)}$$

[403.3.2.3] 403.3.1.1.2.3 Multiple zone recirculating systems. Where one air handler supplies a mixture of outdoor air and recirculated return air to more than one zone, the system outdoor air intake flow rate (V_{ot}) shall be determined in accordance with Sections [403.3.2.3.1] 403.3.1.1.2.3.1 through [403.3.2.3.4] 403.3.1.1.2.3.4.

[403.3.2.3.1] 403.3.1.1.2.3.1 Primary outdoor air fraction. The primary outdoor air fraction (Z_p) shall be determined for each zone in accordance with Equation 4-5.

$$Z_p = V_{oz}/V_{pz} \quad \text{(Equation 4-5)}$$

where:

V_{pz} = Primary airflow: The airflow rate supplied to the zone from the air-handling unit at which the outdoor air intake is located. It includes outdoor intake air and recirculated air from that air-handling unit but does not include air transferred or air recirculated to the zone by other means. For design purposes, V_{pz} shall be the zone design primary airflow rate, except for zones with variable air volume supply and V_{pz} shall be the lowest expected primary air-flow rate to the zone when it is fully occupied.

[403.3.2.3.2] 403.3.1.1.2.3.2 System ventilation efficiency. The system ventilation efficiency (E_v) shall be determined using Table [403.3.2.3.2] 403.3.1.1.2.3.2 or Appendix A of ASHRAE 62.1.

TABLE [403.3.2.3.2] 403.3.1.1.2.3.2
SYSTEM VENTILATION EFFICIENCY^{a,b}

Max (Z_p)	E_v
[<0.15] ≤ 0.15	1
[<0.25] ≤ 0.25	0.9
[<0.35] ≤ 0.35	0.8
[<0.45] ≤ 0.45	0.7
[<0.55] ≤ 0.55	0.6
[<0.65] ≤ 0.65	0.5
[<0.75] ≤ 0.75	0.4
>0.75	0.3

a. Max (Z_p) is the largest value of Z_p calculated using Equation 4-5 among all the zones served by the system.

b. Interpolating between table values shall be permitted.

[403.3.2.3.3] 403.3.1.1.2.3.3 Uncorrected outdoor air intake. The uncorrected outdoor air intake flow rate (V_{ou}) shall be determined in accordance with Equation 4-6.

$$V_{ou} = D \sum_{\text{all zones}} R_p P_z + \sum_{\text{all zones}} R_a A_z \quad \text{(Equation 4-6)}$$

where:

D = Occupant diversity: the ratio of the system population to the sum of the zone populations, determined in accordance with Equation 4-7.

$$D = \frac{P_s}{\sum_{\text{all zones}} P_z} \quad \text{(Equation 4-7)}$$

where:

P_s = System population: The total number of occupants in the area served by the system. For design purposes, P_s shall be the maximum number of occupants expected to be concurrently in all zones served by the system.

[403.3.2.3.4] 403.3.1.1.2.3.4 Outdoor air intake flow rate. The outdoor air intake flow rate (V_{ot}) shall be determined in accordance with Equation 4-8.

$$V_{ot} = V_{ou}/E_v \quad \text{(Equation 4-8)}$$

[403.4] 403.3.1.2 Short-term conditions. If it is known that peak occupancy will be of short duration and/or ventilation will be varied or interrupted for a short period of time, the design may be based on the average conditions over a time period T determined by Equation 4-9.

$$[T = 3v/V_{bz}] \quad T = 3V/V_{bz} \quad \text{(Equation 4-9) (US)}$$

$$[T = 50v/V_{bz}] \quad T = 50V/V_{bz} \quad \text{(Equation 4-9) (SI)}$$

where:

T = averaging time period, minutes

V = the volume of the zone of which averaging is being applied, cubic feet

V_{bz} = the breathing zone outdoor airflow calculated using Equation 4-1 and design valve of the zone population P_z , cfm

Acceptable design adjustments based on this optional provision include the following:

1. Zone with fluctuating occupancy: the zone population (P_z) may be averaged over time, T.
2. Zone with intermittent interruption of supply air: the average outdoor airflow supplied to breathing zone over time T shall be no less than the breathing zone outdoor airflow (V_{bz}) calculated using ~~[equation]~~ Equation 4-1.
3. A system with intermittent closure of outdoor air intake: the average outdoor air intake over time T shall be no less than the minimum outdoor air intake (V_{ot}) calculated using ~~[equation]~~ Equation 4-3, 4-4 or 4-8, as appropriate.

[403.5] 403.3.1.3 Exhaust ventilation. Exhaust airflow rate shall be provided in accordance with the requirements ~~in~~ of Table ~~[403.3] 403.3.1.1~~. Exhaust makeup air shall be permitted to be any combination of outdoor air, recirculated air and transfer air, except as limited in accordance with Section 403.2.

[403.6] 403.3.1.4 System operation. The minimum flow rate of outdoor air that the ventilation system must be capable of supplying during its operation shall be permitted to be based on the rate per person indicated in Table ~~[403.3] 403.3.1.1~~ and the actual number of occupants present.

~~[403.7]~~ **403.3.1.5 Variable air volume system control.** Variable air volume air distribution systems, other than those designed to supply only 100-percent outdoor air, shall be provided with controls to regulate the flow of outdoor air. Such control system shall be designed to maintain the flow rate of outdoor air at a rate of not less than that required by Section ~~[403.3]~~ 403.3.1.1 over the entire range of supply air operating rates.

~~[403.8]~~ **403.3.1.6 Balancing.** The ventilation air distribution system shall be provided with means to adjust the system to achieve ~~[at least]~~ not less than the minimum ventilation airflow rate as required by Sections ~~[403.3]~~ 403.3.1.1 and ~~[403.4]~~ 403.3.1.2. Ventilation systems shall be balanced by an approved method. Such balancing shall verify that the ventilation system is capable of supplying and exhausting the airflow rates required by Sections ~~[403.3]~~ 403.3.1.1 and ~~[403.4]~~ 403.3.1.2.

SECTION MC 404 ENCLOSED PARKING GARAGES

404.1 Enclosed parking garages. ~~[Mechanical]~~ Where mechanical ventilation systems for enclosed parking garages ~~[shall be permitted to] operate intermittently [where the system is arranged to operate automatically upon detection of a concentration]~~ , such operation shall be automatic by means of carbon monoxide [of 25 parts per million (ppm) by approved automatic detection devices] detectors applied in conjunction with nitrogen dioxide detectors. Such detectors shall be installed in accordance with their manufacturers' instructions. Such systems shall operate automatically upon detection of a concentration of carbon monoxide of 25 parts per million (ppm) or nitrogen dioxide of 500 parts per billion (ppb).

404.2 Minimum ventilation. Automatic operation of the system shall not reduce the ventilation airflow rate below 0.05 cfm per square foot (0.00025 m³/s • m²) of the floor area and the system shall be capable of producing a ventilation airflow rate of 0.75 cfm per square foot (0.0038 m³/s • m²) of floor area.

404.3 Occupied spaces accessory to public garages. Connecting offices, waiting rooms, ticket booths and similar uses that are accessory to a public garage shall be maintained at a positive pressure and shall be provided with ventilation in accordance with Section 403.3.

SECTION MC 405 SYSTEMS CONTROL

405.1 General. Mechanical ventilation systems shall be provided with manual or automatic controls that will operate such systems whenever the spaces are occupied. Air-conditioning systems that supply required ventilation air shall be provided with controls designed to automatically maintain the required outdoor air supply rate during occupancy.

405.2 Manual control. Each air distribution system shall be provided with not less than one manual control to stop the operation of the supply, return, and exhaust fans(s) in an emergency. The manual control shall be provided at an approved location. A disconnect switch shall not be considered a manual control.

405.2.1 Office buildings. Any building where the main use or dominant occupancy is classified in Occupancy Group B having occupied floors located more than 75 feet (22 860 mm) above the lowest level of fire department vehicle access, where a system serves a floor or floors other than the floor on which the equipment is located, shall be provided with the following controls, in addition to the controls required by this chapter:

1. Manual controls for operating individually each air supply and each exhaust or return fan in the system located as follows:
 - 1.1. At the Fire Command Center, and
 - 1.2. In the room containing the affected air-handling fans.
2. Manual controls for operating individually or in groups each remote control reversible fire shutter, when such shutters are provided in accordance with the provisions of the *New York City Building Code*, or each smoke damper provided in accordance with the provisions of the *New York City Building Code*. Such controls shall be located at the Fire Command Center.

SECTION MC 406 VENTILATION OF UNINHABITED SPACES

406.1 General. Uninhabited spaces, such as crawl spaces and attics, shall be provided with natural ventilation openings as required by the *New York City Building Code* or shall be provided with a mechanical exhaust and supply air system. The mechanical exhaust rate shall be not less than 0.02 cfm per square foot (0.00001 m³/s • m²) of horizontal area and shall be automatically controlled to operate when the relative humidity in the space served exceeds 60 percent.

406.1.1 Methane and radon venting. The design and materials used in the installation of the methane and radon vent systems shall be approved by the commissioner and shall comply with all applicable rules of the Fire Department.

SECTION MC 407 AMBULATORY CARE FACILITIES AND GROUP I-2 OCCUPANCIES

407.1 General. Mechanical ventilation for ambulatory care facilities (Group B) and Group I-2 occupancies shall be designed and installed in accordance with all applicable federal, state and local regulations.

SECTION MC 408 VENTILATION OF NONPRODUCTION CHEMICAL LABORATORIES

[407.1] 408.1 General. Nonproduction chemical laboratories complying with the hazardous materials quantity limitations of Section [424] 427 of the *New York City Building Code* shall provide a mechanical ventilation system in accordance with NFPA 45 and Table [403.3] 403.3.1.1 of this code [~~and NFPA 45~~], except that ducts constructed of combustible materials shall not be permitted.

§ 6. Chapter 5 of the New York city mechanical code, as amended by local law number 141 for the year 2013, section 507.16 as amended by local law number 148 for the year 2013, and section 513.4.6 as amended by local law number 51 for the year 2014, is amended to read as follows:

CHAPTER 5 EXHAUST SYSTEMS

SECTION MC 501 GENERAL

501.1 Scope. This chapter shall govern the design, construction and installation of mechanical exhaust systems, including exhaust systems serving clothes dryers and cooking appliances; hazardous exhaust systems; dust, stock and refuse conveyor systems; subslab soil exhaust systems; smoke control systems; energy recovery ventilation systems and other systems specified in Section 502.

501.2 Independent system required. Single or combined mechanical exhaust systems for environmental air shall be independent of all other exhaust systems except as permitted in Section 514. Dryer exhaust shall be independent of all other systems. Type I exhaust systems shall be independent of all other exhaust systems except as provided in Section 506.3.5. Single or combined Type II exhaust systems for food-processing operations shall be independent of all other exhaust systems. Kitchen exhaust systems shall be constructed in accordance with Section 505 for domestic equipment and Sections 506 through 509 for commercial equipment.

501.3 Exhaust discharge. The air removed by every mechanical exhaust system shall be discharged outdoors at a point where it will not cause a public nuisance and the air shaft will be located not less than the distances specified in Section ~~[501.2.1]~~ 501.3.1. The air shall be discharged to a location from which it cannot again be readily drawn in by a ventilating system. Air shall not be exhausted into an attic or crawl space.

Exceptions:

1. Whole-house ventilation-type attic fans shall be permitted to discharge into the attic space of dwelling units having private attics.
2. Commercial cooking recirculating systems.
3. Where installed in accordance with the manufacturer's instructions and where mechanical or natural ventilation is otherwise provided in accordance with Chapter 4, listed and labeled domestic ductless range hoods shall not be required to discharge to the outdoors.

~~[501.2.1]~~ **501.3.1 Location of exhaust outlets.** The termination point of exhaust outlets and ducts discharging to the outdoors shall be located ~~[within]~~ with the ~~[following]~~ minimum distances ~~[:]~~ of separation specified in Items 1 through 6 of this section. Separation shall not be required between an air intake and the discharge air from non-evaporative heat rejection or heat absorption

appliances such as air-cooled condensers, dry coolers, or heat pump evaporators; such air is not exhaust. The inlet and discharge of the appliance shall not reduce the effective separation of other exhausts from ventilation intakes to less than the required minimums.

1. For ducts conveying noxious, toxic, explosive or flammable vapors, fumes or dusts (including but not limited to exhaust from dry cleaning establishments and spray booths): 30 feet (9144 mm) from property lines; 10 feet (3048 mm) from operable openings into buildings; 6 feet ([1829] 1828.8 mm) from exterior walls and roofs; 30 feet (9144 mm) from combustible walls and operable openings into buildings which are in the direction of the exhaust discharge; 10 feet (3048 mm) above adjoining grade. Additional requirements may apply to Hazardous Exhaust Systems; see Section 510.
2. For other product-conveying outlets: 10 feet (3048 mm) from the property lines; 3 feet ([914] 914.4 mm) from exterior walls and roofs; 10 feet (3048 mm) from operable openings into buildings; 10 feet (3048 mm) above adjoining grade; 10 feet from any exterior fire escape, stair, or balcony.
3. For all environmental air exhaust outlets: 3 feet ([914] 914.4 mm) from property lines separating lots; 3 feet ([914] 914.4 mm) from operable openings into buildings for all occupancies other than Group U, and 10 feet (3048 mm) from mechanical air intakes. Such exhaust outlets shall not be considered hazardous or noxious.

Exception: A 10 foot (3048 mm) separation is not required between a mechanical air intake and an exhaust outlet which serve either of the following:

1. a single room, dwelling or sleeping unit with less than 750 cfm (354 L/s) Class 1 exhaust air; or
2. a single dwelling or sleeping unit with less than 400 cfm (189 L/s) Class 2 exhaust air.

For this exception, the sum of any energy recovery device cross contamination and any re-entrainment of exhaust through the intake shall be less than 10% of the intake air flow as established by the manufacturer. The distance requirements from property lines and operable openings shall be maintained. Air Class shall be determined in accordance with ASHRAE Standard 62.1.

4. Exhaust outlets and openings serving structures in flood hazard areas shall [~~be installed in accordance~~] comply with the additional requirements of Appendix G of the *New York City Building Code*.
5. For specific systems see the following sections:
 - 5.1. Clothes dryer exhaust, Section 504.4.
 - 5.2. Kitchen hoods and other kitchen exhaust equipment, Sections [~~506.3.12~~] 506.3.13, 506.4 and 506.5.
 - 5.3. Dust stock and refuse conveying systems, Section 511.

- 5.4. Subslab soil exhaust systems, Section 512.4.
 - 5.5. Smoke control systems, Section ~~[513.10.3]~~ 909.10.3 of the *New York City Building Code*.
 - 5.6. Refrigerant discharge, Section 1105.7.
 - 5.7. Machinery room discharge, Section 1105.6.1.
6. In Occupancy Groups R-2 and R-3, each dwelling unit may be individually exhausted directly to the outdoors with a dedicated [7] exhaust fan and shall comply with the following:
- 6.1. The exhaust system for the kitchen and the toilet/baths may be combined to the inlet of a [~~continuously operated~~] single fan, provided such exhaust system serves only one dwelling unit.
 - 6.2. The dedicated exhaust from each dwelling unit shall be directed away from any window serving the same dwelling unit from which the exhaust is taken, and in addition, such exhaust opening shall terminate at least:
 - 6.2.1. Two feet (~~[610]~~ 609.6 mm) from any operational window or door serving the same dwelling unit.
 - 6.2.2. Three feet (~~[1219]~~ 914.4 mm) from any operational window or door serving an adjoining dwelling unit.
 - 6.2.3. Three feet (~~[1219]~~ 914.4 mm) from any operational window or door serving another occupancy group in the same building.
 - 6.2.4. Ten feet (3048 mm) from any outdoor air intake opening other than intakes serving the same dwelling unit.
 - 6.2.5. Ten feet (3048 mm) above the public sidewalk adjoining the same building.
 - 6.2.6. All other minimum distances prescribed in Items 1 through 5 of Section ~~[501.2.1]~~ 501.3.1 shall be satisfied.

~~[501.2.2]~~ 501.3.2 Exhaust opening protection. Exhaust openings that terminate outdoors shall be protected with corrosion-resistant screens, louvers or grilles. Openings in screens, louvers and grilles shall be sized not less than ¼ inch (~~[6]~~ 6.4 mm) and not larger than ½ inch (~~[13]~~ 12.7 mm). Openings shall be protected against local weather conditions. Louvers that protect exhaust openings shall comply with AMCA Standard 550. Outdoor openings located in exterior walls shall meet the provisions for exterior wall opening protective in accordance with the *New York City Building Code*.

[501.2.2.1] 501.3.2.1 Wind-driven rain [rating]. All exterior louvers for building exhaust systems shall ~~[either:]~~ conform to the requirements of Chapter 16 of the *New York City Building Code*, where applicable, and the following:

1. ~~[Receive an A rating according to AMCA Standard 550 for wind driven rain penetration for a 50 mile per hour (80.4 km/h) wind velocity with a rainfall rate of 8 inches (203 mm) per hour]~~ Comply with the requirements of AMCA Standard 550. Louvers shall comply with the intrusion requirements of wind-driven rain without the use of a damper. Exhaust openings located in exterior walls shall meet the provisions for exterior wall opening protectives in accordance with Chapter 16 of the *New York City Building Code*; or
2. Be installed on a plenum configured to intercept any wind-driven rain penetrating the louver and to prevent the rain from entering the building ductwork system. Such plenum shall be waterproofed and equipped with a drainage system to convey water penetrating the louver ~~[to storm or sanitary drains]~~ directly to the outdoors or in accordance with the *New York City Plumbing Code*.

[501.3] 501.4 Pressure equalization. Mechanical exhaust systems shall be sized to remove the quantity of air required by this chapter to be exhausted. The system shall operate when air is required to be exhausted. Where mechanical exhaust is required in a room or space in other than occupancies in R-3, such space shall be maintained with a neutral or negative pressure. If a greater quantity of air is supplied by a mechanical ventilating supply system than is removed by a mechanical exhaust for a room, adequate means shall be provided for the natural or mechanical exhaust of the excess air supplied. If only a mechanical exhaust system is installed for a room or if a greater quantity of air is removed by a mechanical exhaust system than is supplied by a mechanical ventilating supply system for a room, adequate makeup air consisting of supply air, transfer air or outdoor air shall be provided to satisfy ~~[the deficiency]~~ the deficiency. The calculated building infiltration rate and openable area shall not be used to satisfy the requirements of this section.

[501.4] 501.5 Ducts. Where exhaust duct construction is not specified in this chapter, such construction shall comply with Chapter 6.

[501.5] 501.6 Independent system required. The following shall be independent of other exhaust systems:

1. Single or combined mechanical exhaust systems from bath, toilet, urinal, locker, service sink closets and similar rooms shall be independent of all other exhaust systems, except as permitted in Section ~~[501.2.1]~~ 501.3.1.
2. A separate grease duct system shall be provided for each Type I hood except as provided in Section 506.3.5.
3. Hazardous exhaust systems shall be independent of other types of exhaust systems as provided in Section 510.

SECTION MC 502 REQUIRED SYSTEMS

502.1 General. An exhaust system shall be provided, maintained and operated as specifically required by this section and for all occupied areas where machines, vats, tanks, furnaces, forges, salamanders and other appliances, equipment and processes in such areas produce or throw off dust or particles sufficiently light to float in the air, or which emit heat, odors, fumes, spray, gas or smoke, in such quantities so as to be irritating or injurious to health or safety.

502.1.1 Exhaust location. The inlet to an exhaust system shall be located in the area of heaviest concentration of contaminants.

502.1.2 Fuel-dispensing areas. The bottom of an air inlet or exhaust opening in fuel-dispensing areas shall be located not more than 18 inches (~~[457]~~ 457.2 mm) above the floor.

502.1.3 Equipment, appliance and service rooms. Equipment, appliance and system service rooms that house sources of odors, fumes, noxious gases, smoke, steam, dust, spray or other contaminants shall be designed and constructed so as to prevent spreading of such contaminants to other occupied parts of the building.

502.1.4 Hazardous exhaust. The mechanical exhaust of high concentrations of dust or hazardous vapors shall conform to the requirements of Section 510.

502.2 Aircraft fueling and defueling. Compartments housing piping, pumps, air eliminators, water separators, hose reels and similar equipment used in aircraft fueling and defueling operations shall be adequately ventilated [~~in an approved manner~~] at floor level or within the floor itself.

502.3 Battery-charging areas for powered vehicles and equipment. Ventilation shall be provided in an approved manner in battery-charging areas to prevent a dangerous accumulation of flammable gases.

Exception: Lithium-ion batteries shall not require ventilation.

502.4 Stationary storage battery systems. Stationary storage battery systems, as regulated by Section 608 of the *New York City Fire Code*, shall be provided with ventilation in accordance with this chapter [~~and~~], Section 502.4.3 and either Section 502.4.1 or 502.4.2.

Exception: Lithium-ion batteries shall not require ventilation.

502.4.1 Hydrogen limit [~~limit~~] in rooms. For flooded lead acid, flooded nickel cadmium and VRLA batteries, the ventilation system shall be designed to limit the maximum concentration of hydrogen to 1.0 percent of the total volume of the room.

502.4.2 Ventilation rate in rooms. Continuous ventilation shall be provided at a rate of not less than 1 cubic foot per minute per square foot (cfm/ft²) (0.00508 m³/(s • m²)) of floor area of the room.

502.4.3 Supervision. Mechanical ventilation systems required by Section 502.4 shall be supervised with proof of airflow by a central, proprietary system or remote station service or shall initiate an audible and visual signal at a constantly attended on-site location.

502.5 Valve-regulated lead-acid batteries in cabinets. Valve-regulated lead-acid (VRLA) [~~battery systems~~] batteries installed in cabinets, as regulated by Section 608.6.2 of the *New York City Fire Code*, shall be provided with ventilation in accordance with Section 502.5.3 and either Section 502.5.1 or 502.5.2.

502.5.1 Hydrogen limit in cabinets. The cabinet ventilation system shall be designed to limit the maximum concentration of hydrogen to 1.0 percent of the total volume of the cabinet during the worst-case event of simultaneous boost charging of all batteries in the cabinet.

502.5.2 Ventilation rate in cabinets. Continuous cabinet ventilation shall be provided at a rate of not less than 1 cubic foot per minute per square foot (cfm/ft²) (0.00508 m³/(s • m²)) of the floor area covered by the cabinet. The room in which the cabinet is installed shall [~~also~~] be ventilated as required by Section 502.4.1 or 502.4.2.

502.5.3 Supervision. Mechanical ventilation systems required by Section 502.5 shall be supervised with proof of airflow by a central, proprietary system or remote station service or shall initiate an audible and visual signal at a constantly attended on-site location.

502.6 Dry cleaning plants. Mechanical ventilation in dry cleaning plants shall be provided and shall be adequate to protect employees and the public in accordance with this section and DOL 29 CFR Part 1910.1000, where applicable. Dry cleaning separations must comply with the requirements of Section [~~415.6.4~~] 415.9.3 of the *New York City Building Code* and NFPA 32.

502.6.1 Type II and III systems. Type II and III dry cleaning systems shall be provided with a mechanical ventilation system that is designed to exhaust 1 cubic foot of air per minute for each square foot of floor area (1 cfm/ft²) (0.00508 m³/(s • m²)) in dry cleaning rooms and in drying rooms. The ventilation system shall operate automatically when the dry cleaning equipment is in operation and shall have manual controls at an approved location.

502.6.2 Type IV and V systems. Type IV and V dry cleaning systems shall be provided with an automatically activated exhaust ventilation system to maintain [~~a minimum of~~] an air velocity of not less than 100 feet per minute (0.51 m/s) [~~air velocity~~] through the loading door when the door is opened.

Exception: Dry cleaning units are not required to be provided with exhaust ventilation where an exhaust hood is installed immediately outside of and above the loading door which operates at an airflow rate as follows:

$$Q = 100 \times A_{LD} \qquad \text{(Equation 5-1)}$$

where:

Q = Flow rate exhausted through the hood, cubic feet per minute.

A_{LD} = Area of the loading door, square feet.

502.6.3 Spotting and pretreating. Scrubbing tubs, scouring, brushing or spotting operations shall be located such that solvent vapors are captured and exhausted by the ventilating system.

502.7 Application of flammable finishes. Mechanical exhaust as required by this section shall be provided for operations involving the application of flammable finishes and shall comply with the *New York City Fire Code*.

502.7.1 During construction. Ventilation shall be provided for operations involving the application of materials containing flammable solvents in the course of construction, alteration or demolition of a structure.

502.7.2 Limited spraying spaces. Positive mechanical ventilation [~~which~~] that provides [~~a minimum of~~] not less than six complete air changes per hour shall be installed in limited spraying spaces. Such system shall meet the requirements of the *New York City Fire Code* for handling flammable vapors. Explosion venting is not required.

502.7.3 Flammable vapor areas. Mechanical ventilation of flammable vapor areas shall be provided in accordance with the *New York City Fire Code* and Sections 502.7.3.1 through 502.7.3.6 of this code.

502.7.3.1 Operation. Mechanical ventilation shall be kept in operation at all times while spraying operations are being conducted and for a sufficient time thereafter to allow vapors from drying coated articles and finishing material residue to be exhausted. Spraying equipment shall be interlocked with the ventilation of the flammable vapor area such that spraying operations cannot be conducted unless the ventilation system is in operation.

502.7.3.2 Recirculation. Air exhausted from spraying operations shall not be recirculated.

Exceptions:

1. Air exhausted from spraying operations shall be permitted to be recirculated as makeup air for unmanned spray operations provided that:
 - 1.1. [~~Solid~~] The solid particulate has been removed.
 - 1.2. The vapor concentration is less than 25 percent of the lower flammable limit (LFL).
 - 1.3. Approved equipment is used to monitor the vapor concentration.
 - 1.4. An alarm is sounded and spray operations are automatically shut down if the vapor concentration exceeds 25 percent of the LFL.
 - 1.5. In the event of shutdown of the vapor concentration monitor, 100 percent of the air volume specified in Section 510 is automatically exhausted.
2. Air exhausted from spraying operations is allowed to be recirculated as makeup air to manned spraying operations where all of the conditions provided in Exception 1 are included in the installation and documents have been prepared to

show that the installation does not pose a life safety ~~[hazards]~~ hazard to personnel inside the spray booth, spraying space or spray room.

502.7.3.3 Air velocity. ~~[Ventilation systems shall be designed, installed and maintained such that the average air velocity over the open face of the booth, or booth cross section in the direction of airflow during spraying operations, is not less than 100 feet per minute (0.51 m/s).]~~ The ventilation system shall be designed, installed and maintained so that the flammable contaminants are diluted in noncontaminated air to maintain concentrations in the exhaust air flow below 25 percent of the contaminant's lower flammable limit (LFL). In addition, the spray booth shall be provided with mechanical ventilation so that the average air velocity through openings is in accordance with Sections 502.7.3.3.1 and 502.7.3.3.2.

502.7.3.3.1 Open face or open front spray booth. For spray application operations conducted in an open face or open front spray booth, the ventilation system shall be designed, installed and maintained so that the average air velocity into the spray booth through all openings is not less than 100 feet per minute (0.51 m/s).

Exception: For fixed or automated electrostatic spray application equipment, the average air velocity into the spray booth through all openings shall be not less than 50 feet per minute (0.25 m/s).

502.7.3.3.2 Enclosed spray booth or spray room with openings for product conveyance. For spray application operations conducted in an enclosed spray booth or spray room with openings for product conveyance, the ventilation system shall be designed, installed and maintained so that the average air velocity into the spray booth through openings is not less than 100 feet per minute (0.51 m/s). For occupied spray booths and occupied spray rooms, the air velocity at the point of application shall not be less than 100 feet per minute (0.51 m/s).

Exceptions:

1. For fixed or automated electrostatic spray application equipment, the average air velocity into the spray booth through all openings shall be not less than 50 feet per minute (0.25 m/s).
2. Where methods are used to reduce cross drafts that can draw vapors and overspray through openings from the spray booth or spray room, the average air velocity into the spray booth or spray room shall be that necessary to capture and confine vapors and overspray to the spray booth or spray room.

502.7.3.4 Ventilation obstruction. Articles being sprayed shall be positioned in a manner that does not obstruct collection of overspray.

502.7.3.5 Independent ducts. Each spray booth and spray room shall have an independent exhaust duct system discharging to the outdoors.

Exceptions:

1. Multiple spray booths having a combined frontal area of 18 square feet (1.67 m²) or less are allowed to have a common exhaust where identical spray-finishing material is used in each booth. If more than one fan serves one booth, such fans shall be interconnected so that all fans operate simultaneously.
2. Where treatment of exhaust is necessary for air pollution control or energy conservation, ducts shall be allowed to be manifolded if all of the following conditions are met:
 - 2.1. The sprayed materials used are compatible and will not react or cause ignition of the residue in the ducts.
 - 2.2. Nitrocellulose-based finishing material shall not be used.
 - 2.3. A filtering system shall be provided to reduce the amount of overspray carried into the duct manifold.
 - 2.4. Automatic sprinkler protection shall be provided at the junction of each booth exhaust with the manifold, in addition to the protection required by this chapter.

[502.7.3.7] 502.7.3.6 Fan motors and belts. Electric motors driving exhaust fans shall not be placed inside booths or ducts. Fan rotating elements shall be nonferrous or nonsparking or the casing shall consist of, or be lined with, such material. Belts shall not enter the duct or booth unless the belt and pulley within the duct are tightly enclosed.

502.7.4 Dipping operations. Flammable vapor areas of dip tank operations shall be provided with mechanical ventilation adequate to prevent the dangerous accumulation of vapors. Required ventilation systems shall be so arranged that the failure of any ventilating fan will automatically stop the dipping conveyor system.

502.7.5 Electrostatic apparatus. The flammable vapor area in spray-finishing operations involving electrostatic apparatus and devices shall be ventilated in accordance with Section 502.7.3.

502.7.6 Powder coating. Exhaust ventilation for powder-coating operations shall be sufficient to maintain the atmosphere below one-half of the minimum explosive concentration for the material being applied. Nondeposited, air-suspended powders shall be removed through exhaust ducts to the powder recovery system.

502.7.7 Floor resurfacing operations. To prevent the accumulation of flammable vapors during floor resurfacing operations, mechanical ventilation at a minimum rate of 1 cfm/ft² (0.00508 m³/(s • m²)) of area being finished shall be provided. Such exhaust shall be by approved temporary or portable means. Vapors shall be exhausted to the exterior of the building. Such exhaust equipment shall be kept in operation while the floor finishing operations are conducted and until any flammable vapors have been exhausted to the exterior of the building.

502.7.8 Resin application areas. Exhaust ventilation for resin application areas shall comply with Section 502.7.3.

Exception: Mechanical ventilation is not required for buildings that are unenclosed for at least 75 percent of the perimeter.

502.8 Hazardous materials—general requirements. Exhaust ventilation systems for structures containing hazardous materials shall be provided as required in Sections 502.8.1 through 502.8.5 and shall comply with the *New York City Fire Code*.

502.8.1 Storage in excess of the maximum allowable quantities. Indoor storage areas and storage buildings for hazardous materials in amounts exceeding the maximum allowable quantity per control area, as defined by the *New York City Fire Code*, shall be provided with mechanical exhaust ventilation or natural ventilation where natural ventilation can be shown to be acceptable for the materials as stored.

[Exception:] Exceptions:

1. Storage areas for flammable solids complying with the *New York City Fire Code*.
2. Storage areas and storage buildings for fireworks and explosives complying with the *New York City Fire Code*.

502.8.1.1 System requirements. Exhaust ventilation systems shall comply with all of the following:

1. The installation shall be in accordance with this code.
2. Mechanical ventilation shall be provided at a rate of not less than 1 cfm/ft² (0.00508 m³/(s • m²)) of floor area over the storage area.
3. The systems shall operate continuously unless alternate designs are approved.
4. A manual shutoff control shall be provided outside of the room in a position adjacent to the access door to the room or in another approved location. The switch shall be a break-glass or other approved type and shall be labeled: VENTILATION SYSTEM EMERGENCY SHUTOFF.
5. The exhaust ventilation shall be designed to consider the density of the potential fumes or vapors released. For fumes or vapors that are heavier than air, exhaust shall be taken from a point within 12 inches (~~[305]~~ 304.8 mm) of the floor. For fumes or vapors that are lighter than air, exhaust shall be taken from a point within 12 inches (~~[305]~~ 304.8 mm) of the highest point of the room.
6. The location of both the exhaust and inlet air openings shall be designed to provide air movement across all portions of the floor or room to prevent the accumulation of vapors.

7. The exhaust air shall not be recirculated to occupied areas if the materials stored are capable of emitting hazardous vapors and contaminants have not been removed. Air contaminated with explosive or flammable vapors, fumes or dusts; flammable, highly toxic or toxic gases; or radioactive materials shall not be recirculated.

502.8.2 Gas rooms, exhausted enclosures and gas cabinets. The ventilation system for gas rooms, exhausted enclosures and gas cabinets for any quantity of hazardous material shall be designed to operate at a negative pressure in relation to the surrounding area. Highly toxic and toxic gases shall ~~[also]~~ comply with Sections 502.9.7.1, 502.9.7.2 and 502.9.8.4.

502.8.3 Indoor dispensing and use. Indoor dispensing and use areas for hazardous materials in amounts exceeding the maximum allowable quantity per control area shall be provided with exhaust ventilation in accordance with Section 502.8.1.

Exception: Ventilation is not required for dispensing and use of flammable solids other than finely divided particles.

502.8.4 Indoor dispensing and ~~[use-point]~~ use—point sources. Where gases, liquids or solids in amounts exceeding the maximum allowable quantity per control area and having a hazard ranking of 3 or 4 in accordance with NFPA 704 are dispensed or used, mechanical exhaust ventilation shall be provided to capture gases, fumes, mists or vapors at the point of generation.

Exception: Where it can be demonstrated that the gases, liquids or solids do not create harmful gases, fumes, mists or vapors.

502.8.5 Closed systems. Where closed systems for the use of hazardous materials in amounts exceeding the maximum allowable quantity per control area are designed to be opened as part of normal operations, ventilation shall be provided in accordance with Section 502.8.4.

502.9 Hazardous materials—requirements for specific materials. Exhaust ventilation systems for specific hazardous materials shall be provided as required in Section 502.8 and Sections 502.9.1 through 502.9.11 and shall comply with the *New York City Fire Code*.

502.9.1 Compressed ~~[gases-medical]~~ gases—medical gas systems. Rooms for the storage of compressed medical gases ~~[in amounts exceeding the maximum allowable exempt quantity per control area]~~ where the amounts being stored require a permit in accordance with the *New York City Fire Code*, and ~~[which]~~ that do not have an exterior wall, shall be exhausted through a duct to the exterior of the building. Each space shall be separately exhausted, and each exhaust air stream shall be enclosed in a 1-hour-rated shaft enclosure from the room to the exterior. Approved mechanical ventilation shall be provided at a minimum rate of 1 cfm/ft² (0.00508 m³/(s • m²)) of the area of the room.

Gas cabinets for the storage of compressed medical gases ~~[in amounts exceeding the maximum allowable exempt quantity per control area]~~ where the amounts being stored require a permit in accordance with the *New York City Fire Code* shall be connected to an exhaust system. The average velocity of ventilation at the face of access ports or windows shall be not less than 200 feet per minute (1.02 m/s) with a minimum velocity of 150 feet per minute (0.76 m/s) at any point at the access port or window.

502.9.2 Corrosives. Where corrosive materials in amounts exceeding the maximum allowable quantity per control area are dispensed or used, mechanical exhaust ventilation in accordance with Section 502.8.4 shall be provided.

502.9.3 Cryogenics. Storage areas for stationary or portable containers of cryogenic fluids in any quantity shall be ventilated in accordance with Section 502.8. Indoor areas where cryogenic fluids in any quantity are dispensed shall be ventilated in accordance with the requirements of Section 502.8.4 in a manner that captures any vapor at the point of generation.

Exception: Ventilation for indoor dispensing areas is not required where it can be demonstrated that the cryogenic fluids do not create harmful vapors.

502.9.4 Explosives. Squirrel cage blowers shall not be used for exhausting hazardous fumes, vapors or gases in operating buildings and rooms for the manufacture, assembly or testing of explosives. Only nonferrous fan blades shall be used for fans located within the ductwork and through which hazardous materials are exhausted. Motors shall be located outside the duct.

502.9.5 Flammable and combustible liquids. Exhaust ventilation systems shall be provided as required by Sections 502.9.5.1 through 502.9.5.5 for the storage, use, dispensing, mixing and handling of flammable and combustible liquids. Unless otherwise specified, this section shall apply to any quantity of flammable and combustible liquids.

Exception: This section shall not apply to flammable and combustible liquids that are exempt from the *New York City Fire Code*.

502.9.5.1 Vaults. Vaults that contain tanks of Class I liquids shall be provided with continuous ventilation at a rate of not less than 1 cfm/ft² of floor area (0.00508 m³/(s • m²)), but not less than 150 cfm (4 m³/min). Failure of the exhaust airflow shall automatically shut down the dispensing system. The exhaust system shall be designed to provide air movement across all parts of the vault floor. Supply and exhaust ducts shall extend to a point not greater than 12 inches ([305] 304.8 mm) and not less than 3 inches ([76] 76.2 mm) above the floor. The exhaust system shall be installed in accordance with the provisions of NFPA 91. Means shall be provided to automatically detect any flammable vapors and to automatically shut down the dispensing system upon detection of such flammable vapors in the exhaust duct at a concentration of 25 percent of the LFL.

502.9.5.2 Storage rooms and warehouses. Liquid storage rooms and liquid storage warehouses for quantities of liquids exceeding those specified in the *New York City Fire Code* shall be ventilated in accordance with Section 502.8.1.

502.9.5.3 Cleaning machines. Areas containing machines used for parts cleaning in accordance with the *New York City Fire Code* shall be adequately ventilated to prevent accumulation of vapors.

502.9.5.4 Use, dispensing and mixing. Continuous mechanical ventilation shall be provided for the use, dispensing and mixing of flammable and combustible liquids in open or closed systems in amounts exceeding the maximum allowable quantity per control area and for bulk transfer and process transfer operations. The ventilation rate shall be not less than 1

cfm/ft²(0.00508 m³/(s • m²)) of floor area over the design area. Provisions shall be made for the introduction of makeup air in a manner that will include all floor areas or pits where vapors can collect. Local or spot ventilation shall be provided where needed to prevent the accumulation of hazardous vapors.

502.9.5.5 Bulk plants or terminals. Ventilation shall be provided for portions of properties where flammable and combustible liquids are received by tank vessels, pipelines, tank cars or tank vehicles and which are stored or blended in bulk for the purpose of distributing such liquids by tank vessels, pipelines, tank cars, tank vehicles or containers as required by Sections 502.9.5.5.1 through 502.9.5.5.3.

502.9.5.5.1 General. Ventilation shall be provided for rooms, buildings and enclosures in which Class I liquids are pumped, used or transferred. Design of ventilation systems shall consider the relatively high specific gravity of the vapors. Where natural ventilation is used, adequate openings in outside walls at floor level, unobstructed except by louvers or coarse screens, shall be provided. Where natural ventilation is inadequate, mechanical ventilation shall be provided. The natural ventilation design shall be approved for each specific application by the commissioner prior to installation and/or use.

502.9.5.5.2 Basements and pits. Class I liquids shall not be stored or used within a building having a basement or pit into which flammable vapors can travel, unless such area is provided with ventilation designed to prevent the accumulation of flammable vapors therein.

502.9.5.5.3 Dispensing of Class I liquids. Containers of Class I liquids shall not be drawn from or filled within buildings unless a provision is made to prevent the accumulation of flammable vapors in hazardous concentrations. Where mechanical ventilation is required, it shall be kept in operation while flammable vapors could be present.

502.9.6 Highly toxic and toxic liquids. Ventilation exhaust shall be provided for highly toxic and toxic liquids as required by Sections 502.9.6.1 and 502.9.6.2.

502.9.6.1 Treatment system. This provision shall apply to indoor and outdoor storage and use of highly toxic and toxic liquids in amounts exceeding the maximum allowable quantities per control area. Exhaust scrubbers or other systems for processing vapors of highly toxic liquids shall be provided where a spill or accidental release of such liquids can be expected to release highly toxic vapors at normal temperature and pressure.

502.9.6.2 Open and closed systems. Mechanical exhaust ventilation shall be provided for highly toxic and toxic liquids used in open systems in accordance with Section 502.8.4. Mechanical exhaust ventilation shall be provided for highly toxic and toxic liquids used in closed systems in accordance with Section 502.8.5.

Exception: Liquids or solids that do not generate highly toxic or toxic fumes, mists or vapors.

502.9.7 Highly toxic and toxic compressed gases—any quantity. Ventilation exhaust shall be provided for highly toxic and toxic compressed gases in any quantity as required by Sections 502.9.7.1 and 502.9.7.2.

502.9.7.1 Gas cabinets. Gas cabinets containing highly toxic or toxic compressed gases in any quantity shall comply with Section 502.8.2 and the following requirements:

1. The average ventilation velocity at the face of gas cabinet access ports or windows shall be not less than 200 feet per minute (1.02 m/s) with a minimum velocity of 150 feet per minute (0.76 m/s) at any point at the access port or window.
2. Gas cabinets shall be connected to an exhaust system.
3. Gas cabinets shall not be used as the sole means of exhaust for any room or area.

502.9.7.2 Exhausted enclosures. Exhausted enclosures containing highly toxic or toxic compressed gases in any quantity shall comply with Section 502.8.2 and the following requirements:

1. The average ventilation velocity at the face of the enclosure shall be not less than 200 feet per minute (1.02 m/s) with a minimum velocity of 150 feet per minute (0.76 m/s).
2. Exhausted enclosures shall be connected to an exhaust system.
3. Exhausted enclosures shall not be used as the sole means of exhaust for any room or area.

502.9.8 Highly toxic and toxic compressed gases—quantities exceeding the maximum allowable quantity per control area. Ventilation exhaust shall be provided for highly toxic and toxic compressed gases in amounts exceeding the maximum allowable quantities per control area as required by Sections 502.9.8.1 through 502.9.8.6.

502.9.8.1 Ventilated areas. The room or area in which indoor gas cabinets or exhausted enclosures are located shall be provided with exhaust ventilation. Gas cabinets or exhausted enclosures shall not be used as the sole means of exhaust for any room or area.

502.9.8.2 Local exhaust for portable tanks. A means of local exhaust shall be provided to capture leakage from indoor and outdoor portable tanks. The local exhaust shall consist of portable ducts or collection systems designed to be applied to the site of a leak in a valve or fitting on the tank. The local exhaust system shall be located in a gas room. Exhaust shall be directed to a treatment system where required by the *New York City Fire Code*.

502.9.8.3 Piping and controls—stationary tanks. Filling or dispensing connections on indoor stationary tanks shall be provided with a means of local exhaust. Such exhaust shall be designed to capture fumes and vapors. The exhaust shall be directed to a treatment system where required by the *New York City Fire Code*.

502.9.8.4 Gas rooms. The ventilation system for gas rooms shall be designed to operate at a negative pressure in relation to the surrounding area. The exhaust ventilation from gas rooms shall be directed to an exhaust system.

502.9.8.5 Treatment system. The exhaust ventilation from gas cabinets, exhausted enclosures and gas rooms, and local exhaust systems required in Sections 502.9.8.2 and 502.9.8.3 shall be directed to a treatment system where required by the *New York City Fire Code*.

502.9.8.6 Process equipment. Effluent from indoor and outdoor process equipment containing highly toxic or toxic compressed gases which could be discharged to the atmosphere shall be processed through an exhaust scrubber or other processing system. Such systems shall be in accordance with the *New York City Fire Code*.

502.9.9 Ozone gas generators. Ozone cabinets and ozone gas-generator rooms for systems having a maximum ozone-generating capacity of one-half pound (0.23 kg) or more over a 24-hour period shall be mechanically ventilated at a rate of not less than six air changes per hour. For cabinets, the average velocity of ventilation at makeup air openings with cabinet doors closed shall be not less than 200 feet per minute (1.02 m/s).

502.9.10 LP-gas distribution facilities. LP-gas distribution facilities shall conform to the requirements of the *New York City Fire Code*.

502.9.11 Silane gas. Exhausted enclosures and gas cabinets for the indoor storage of silane gas in amounts exceeding the maximum allowable quantities per control area shall comply with this section.

1. Exhausted enclosures and gas cabinets shall be in accordance with Section 502.8.2.
2. The velocity of ventilation across unwelded fittings and connections on the piping system shall not be less than 200 feet per minute (1.02 m/s).
3. The average velocity at the face of the access ports or windows in the gas cabinet shall not be less than 200 feet per minute (1.02 m/s) with a minimum velocity of 150 feet per minute (0.76 m/s) at any point at the access port or window.

502.10 Hazardous production materials (HPM). Exhaust ventilation systems and materials for ducts utilized for the exhaust of HPM shall comply with this section, other applicable provisions of this code, the *New York City Building Code* and the *New York City Fire Code*.

502.10.1 Where required. Exhaust ventilation systems shall be provided in the following locations in accordance with the requirements of this section and the *New York City Building Code*:

1. Fabrication areas: Exhaust ventilation for fabrication areas shall comply with the *New York City Building Code*. Additional manual control switches shall be provided where required by the commissioner.

2. Workstations: A ventilation system shall be provided to capture and exhaust gases, fumes and vapors at workstations.
3. Liquid storage rooms: Exhaust ventilation for liquid storage rooms shall comply with Section 502.8.1.1 and the *New York City Building Code*.
4. HPM rooms: Exhaust ventilation for HPM rooms shall comply with Section 502.8.1.1 and the *New York City Building Code*.
5. Gas cabinets: Exhaust ventilation for gas cabinets shall comply with Section 502.8.2. The gas cabinet ventilation system is allowed to connect to a workstation ventilation system. Exhaust ventilation for gas cabinets containing highly toxic or toxic gases shall also comply with Sections 502.9.7 and 502.9.8.
6. Exhausted enclosures: Exhaust ventilation for exhausted enclosures shall comply with Section 502.8.2. Exhaust ventilation for exhausted enclosures containing highly toxic or toxic gases shall also comply with Sections 502.9.7 and 502.9.8.
7. Gas rooms: Exhaust ventilation for gas rooms shall comply with Section 502.8.2. Exhaust ventilation for gas cabinets containing highly toxic or toxic gases shall also comply with Sections 502.9.7 and 502.9.8.

502.10.2 Penetrations. Exhaust ducts penetrating fire barrier assemblies constructed in accordance with Section 707 of the *New York City Building Code* or horizontal assemblies constructed in accordance with Section 711 of the *New York City Building Code* shall be contained in a shaft of equivalent [~~fire-resistive~~] fire-resistance-rated construction. Exhaust ducts shall not penetrate [~~building-separation~~] fire walls. Fire dampers shall not be installed in exhaust ducts.

502.10.3 Treatment systems. Treatment systems for highly toxic and toxic gases shall comply with the *New York City Fire Code*.

502.11 Motion picture projectors. Motion picture projectors shall be exhausted in accordance with Section 502.11.1 or 502.11.2.

502.11.1 Projectors with an exhaust discharge. Projectors equipped with an exhaust discharge shall be directly connected to a mechanical exhaust system. The exhaust system shall operate at an exhaust rate as indicated by the manufacturer's [~~installation~~] instructions.

502.11.2 Projectors without exhaust connection. Projectors without an exhaust connection shall have contaminants exhausted through a mechanical exhaust system. The exhaust rate for electric arc projectors shall be [~~a minimum of~~] not less than 200 cubic feet per minute (cfm) (0.09 m³/s) per lamp. The exhaust rate for xenon projectors shall be [~~a minimum of~~] not less than 300 cfm (0.14 m³/s) per lamp. Xenon projector exhaust shall be at a rate such that the exterior temperature of the lamp housing does not exceed 130°F ([~~54~~] 54.4°C). The lamp and projection room exhaust systems, whether combined or independent, shall not be interconnected with any other exhaust or return system within the building.

502.12 Organic coating processes. Enclosed structures involving organic coating processes in which Class I liquids are processed or handled shall be ventilated at a rate of not less than 1 cfm/ft² (0.00508 m³/(s • m²)) of solid floor area. Ventilation shall be accomplished by exhaust fans that intake at floor levels and discharge to a safe location outside the structure. Noncontaminated intake air shall be introduced in such a manner that all portions of solid floor areas are provided with continuous uniformly distributed air movement.

502.13 Public garages. Mechanical exhaust systems for public garages, as required in Chapter 4, shall operate continuously or in accordance with Section 404.

502.14 Motor vehicle operation. In areas where motor vehicles operate, mechanical ventilation shall be provided in accordance with Section 403. Additionally, areas in which stationary motor vehicles are operated shall be provided with a source capture system that connects directly to the motor vehicle exhaust systems. Such system shall be engineered by a registered design professional or shall be factory-built equipment designed and sized for the purpose.

Exceptions:

1. This section shall not apply where the motor vehicles being operated or repaired are electrically powered.
2. This section shall not apply to one- and two-family dwellings.
3. This section shall not apply to motor vehicle service areas where engines are operated inside the building only for the duration necessary to move the motor vehicles in and out of the building.

502.15 Repair garages. Where Class I liquids or LP-gas are stored or used within a building having a basement or pit wherein flammable vapors could accumulate, the basement or pit shall be provided with ventilation at a minimum rate of 1.5 cubic feet per minute per square foot (cfm/ft²) (0.008 m³/(s • m²)) designed to prevent the accumulation of flammable vapors therein.

502.16 Repair garages for natural gas- and hydrogen-fueled vehicles. Repair garages used for the repair of natural gas- or hydrogen-fueled vehicles shall be provided with an approved mechanical ventilation system. The mechanical ventilation system shall be in accordance with Sections 502.16.1 and 502.16.2.

Exception: Where approved by the commissioner, natural ventilation shall be permitted in lieu of mechanical ventilation.

502.16.1 Design. Indoor locations shall be ventilated utilizing air supply inlets and exhaust outlets arranged to provide uniform air movement to the extent practical. Inlets shall be uniformly arranged on exterior walls near floor level. Outlets shall be located at the high point of the room in exterior walls or the roof.

1. Ventilation shall be by a continuous mechanical ventilation system or by a mechanical ventilation system activated by a continuously monitoring natural gas detection system, or for hydrogen, a continuously monitoring flammable gas detection system, each

activating at a gas concentration of 25 percent of the lower flammable limit (LFL). In all cases, the system shall shut down the fueling system in the event of failure of the ventilation system.

2. The ventilation rate shall be [~~at least~~] not less than 1 cubic foot per minute per 12 cubic feet (0.00138 m³/(s • m³)) of room volume.

502.16.2 Operation. The mechanical ventilation system shall operate continuously.

Exceptions:

1. Mechanical ventilation systems that are interlocked with a gas detection system designed in accordance with the *New York City Building Code*.
2. Mechanical ventilation systems in garages that are used only for the repair of vehicles fueled by liquid fuels or odorized gases, such as CNG, where the ventilation system is electrically interlocked with the lighting circuit.

502.17 Tire rebuilding or recapping. Each room where rubber cement is used or mixed, or where flammable or combustible solvents are applied, shall be ventilated in accordance with the applicable provisions of NFPA 91.

502.17.1 Buffing machines. Each buffing machine shall be connected to a dust-collecting system that prevents the accumulation of the dust produced by the buffing process.

502.18 Specific rooms. Specific rooms, including bathrooms, locker rooms, smoking lounges and toilet rooms, shall be exhausted in accordance with the ventilation requirements of Chapter 4.

~~[502.19 Domestic kitchen exhaust systems. In all Group R occupancies a minimum of No. 18 Gage galvanized sheet metal shall be used, except that ductwork that complies with Section 603.6.1.2 shall be permitted for independent apartment exhaust systems providing general exhaust ventilation of kitchen and toilet areas.]~~

~~[502.20 Nonproduction chemical laboratories. Nonproduction chemical laboratories shall comply with Section 424 of the *New York City Building Code* and NFPA 45.]~~

~~[502.21] **502.19 Indoor firing ranges.** Ventilation shall be provided in an approved manner in areas utilized as indoor firing ranges. Firing ranges shall comply with all applicable laws and the requirements of the *New York City Department of Health and Mental Hygiene*.~~

502.20 Manicure and pedicure stations. Manicure and pedicure stations shall be provided with an exhaust system in accordance with Table 403.3.1.1, Note h. Manicure tables and pedicure stations not provided with factory-installed exhaust inlets shall be provided with exhaust inlets located not more than 12 inches (304.8 mm) horizontally and vertically from the point of chemical application.

502.21 Domestic kitchen exhaust systems. In all Group R occupancies, a minimum of No. 18 Gage galvanized sheet metal shall be used, except that ductwork that complies with Section 603.6.1.2 shall be permitted for independent apartment exhaust systems providing general exhaust ventilation of kitchen and toilet areas.

502.22 Nonproduction chemical laboratories. Nonproduction chemical laboratories shall comply with the *New York City Building Code* and NFPA 45.

SECTION MC 503 MOTORS AND FANS

503.1 General. Motors and fans shall be sized to provide the required air movement. Motors in areas that contain flammable vapors or dusts shall be of a type approved for such environments. A manually operated remote control installed at an approved location shall be provided to shut off fans or blowers in flammable vapor or dust systems. Electrical equipment and appliances used in operations that generate explosive or flammable vapors, fumes or dusts shall be interlocked with the ventilation system so that the equipment and appliances cannot be operated unless the ventilation fans are in operation. Motors for fans used to convey flammable vapors or dusts shall be located outside the duct or shall be protected with approved shields and dustproofing. Motors and fans shall be provided with a means of access for servicing and maintenance.

503.2 Fans. Parts of fans in contact with explosive or flammable vapors, fumes or dusts shall be of nonferrous or nonsparking materials, or their casing shall be lined or constructed of such material. [~~When~~] Where the size and hardness of materials passing through a fan are capable of producing a spark, both the fan and the casing shall be of nonsparking materials. [~~When~~] Where fans are required to be spark resistant, their bearings shall not be within the airstream, and all parts of the fan shall be grounded. Fans in systems-handling materials that are capable of clogging the blades, and fans in buffing or woodworking exhaust systems, shall be of the radial-blade or tube-axial type.

503.3 Equipment and appliance identification plate. Equipment and appliances used to exhaust explosive or flammable vapors, fumes or dusts shall bear an identification plate stating the ventilation rate for which the system was designed.

503.4 Corrosion-resistant fans. Fans located in systems conveying corrosives shall be of materials that are resistant to the corrosive or shall be coated with corrosion-resistant materials.

503.5 Fan location. Fans exhausting noxious, toxic, hot vapor or grease-laden air shall be located as close to the terminus as practicable, at the roof or within a mechanical equipment room, immediately below the roof.

[~~Exception: Where the fan is listed or approved for such an application.~~]

SECTION MC 504 CLOTHES DRYER EXHAUST

504.1 Installation. Clothes dryers shall be exhausted in accordance with the manufacturer's instructions. Dryer exhaust systems shall be independent of all other systems and shall convey the moisture and any products of combustion to the outside of the building. For the installation of gas dryers, refer to [~~Section 614 of~~] the *New York City Fuel Gas Code*.

Exception: This section shall not apply to listed and labeled condensing (ductless) electric clothes dryers.

504.2 Exhaust duct penetrations. Where a clothes dryer exhaust duct penetrates a wall or ceiling membrane, the annular space shall be sealed with noncombustible material, approved fire caulking or a noncombustible dryer exhaust duct wall receptacle. Ducts that exhaust clothes dryers shall not penetrate or be located within any fireblocking, draftstopping or any wall, floor/ceiling or other assembly required by the *New York City Building Code* to be fire-resistance rated, unless such duct is constructed of galvanized steel or aluminum of the thickness specified in Section 603.4 and the fire-resistance rating is maintained in accordance with the *New York City Building Code*. Fire dampers, combination fire/smoke dampers and any similar devices that will obstruct the exhaust flow shall be prohibited in clothes dryer exhaust ducts.

504.3 Cleanout. Each vertical riser shall be provided with a means for cleanout.

504.4 Exhaust installation. Dryer exhaust ducts for clothes dryers shall terminate on the outside of the building. Single dryer installations shall be equipped with a backdraft damper. Multiple dryer installations shall not have a backdraft damper. Screens shall not be installed at the duct termination. Ducts shall not be connected or installed with sheet metal screws or other fasteners that will obstruct the exhaust flow. Clothes dryer exhaust ducts shall not be connected to a vent connector, vent or chimney. Clothes dryer exhaust ducts shall not extend into or through ducts or plenums.

504.5 Dryer exhaust duct power ventilators. Domestic dryer exhaust duct power ventilators shall be listed and labeled to UL 705 for use in dryer exhaust duct systems. The dryer exhaust duct power ventilator shall be installed in accordance with the manufacturer's instructions.

504.6 Makeup air. Installations exhausting more than 200 cfm (0.09 m³/s) shall be provided with makeup air. Where a closet is designed for the installation of a clothes dryer, an opening having an area of not less than 100 square inches (0.0645 m²) shall be provided in the closet enclosure or makeup air shall be provided by other approved means.

504.7 Protection required. Protective shield plates shall be placed where nails or screws from finish or other work are likely to penetrate the clothes dryer exhaust duct. Shield plates shall be placed on the finished face of all framing members where there is less than 1¼ inches (31.8 mm) between the duct and the finished face of the framing member. Protective shield plates shall be constructed of steel, have a thickness of 0.062 inch (1.6 mm) and extend not less than 2 inches ([5¼] 50.8 mm) above sole plates and below top plates.

[504.6] 504.8 Domestic clothes dryer ducts. Exhaust ducts for domestic clothes dryers shall conform to the requirements of Sections [504.6.1] 504.8.1 through [504.6.7] 504.8.6.

[504.6.1] 504.8.1 Material and size. Exhaust ducts shall have a smooth interior finish and shall be constructed of metal a minimum 0.016 inch (0.4 mm) thick. The exhaust duct size shall be 4 inches ([402] 101.6 mm) nominal in diameter, unless a larger duct size is specifically required by the dryer manufacturer. Exhaust ducts larger than 20 square inches (12 903.2 mm²) shall be individually exhausted.

Exception: Where the make and model of the clothes dryer to be installed is known and the manufacturer's ~~[installation]~~ instructions for such dryer are provided, the maximum length of the exhaust duct, including any transition duct, shall be permitted to be in accordance with the dryer manufacturer's ~~[installation]~~ instructions.

[504.6.2] 504.8.2 Duct installation. Exhaust ducts shall be supported at 4-foot (~~[1219]~~ 1219.2 mm) intervals and secured in place. The insert end of the duct shall extend into the adjoining duct or fitting in the direction of airflow. Ducts servicing a single appliance shall not be joined with screws or similar fasteners that protrude more than 1/8 inch (3.2 mm) into the inside of the duct.

[504.6.3] 504.8.3 Transition ducts. Transition ducts used to connect the dryer to the exhaust duct system shall be a single length that is listed and labeled in accordance with UL 2158A. Transition ducts shall be ~~[a maximum of]~~ not greater than 8 feet (~~[2438]~~ 2438.4 mm) in length and shall not be concealed within construction.

[504.6.4] 504.8.4 Duct length. The maximum allowable exhaust duct length shall be determined by one of the methods specified in ~~[Section 504.6.4.1 or 504.6.4.2]~~ Sections 504.8.4.1 through 504.8.4.3.

[504.6.4.1] 504.8.4.1 Specified length. The maximum length of the exhaust duct shall be 35 feet (10 668 mm) from the connection to the transition duct from the dryer to the outlet terminal or to a common or central exhaust system. Where fittings are used, the maximum length of the exhaust duct shall be reduced in accordance with Table ~~[504.6.4.1]~~ 504.8.4.1.

**TABLE ~~[504.6.4.1]~~ 504.8.4.1
DRYER EXHAUST DUCT FITTING EQUIVALENT LENGTH^a**

DRYER EXHAUST DUCT FITTING TYPE	EQUIVALENT LENGTH
4" radius mitered 45-degree elbow	2 feet 6 inches
4" radius mitered 90-degree elbow	5 feet
6" radius smooth 45-degree elbow	1 foot
6" radius smooth 90-degree elbow	1 foot 9 inches
8" radius smooth 45-degree elbow	1 foot
8" radius smooth 90-degree elbow	1 foot 7 inches
10" radius smooth 45-degree elbow	9 inches
10" radius smooth 90-degree elbow	1 foot 6 inches

For SI: 1 inch = 25.4 mm, 1 foot = 304.8 mm, 1 degree = 0.0175 rad.

a. The equivalent length column of the table indicates how much length must be added to the exhaust duct total length for each fitting used.

[504.6.4.2] 504.8.4.2 Manufacturer's instructions. The maximum length of the exhaust duct shall be determined by the dryer manufacturer's ~~[installation]~~ instructions. The ~~[code official]~~ special inspector shall be provided with a copy of the ~~[installation]~~ instructions for the make and model of the dryer. Where the exhaust duct is to be concealed, the installation instructions shall be provided to the ~~[code official]~~ special inspector prior to the concealment inspection. In the absence of fitting equivalent length calculations from the clothes dryer manufacturer, Table ~~[504.6.4.1]~~ 504.8.4.1 shall be used.

504.8.4.3 Dryer exhaust duct power ventilator length. The maximum length of the exhaust duct shall be determined by the dryer exhaust duct power ventilator manufacturer's instructions.

~~[504.6.5]~~ **504.8.5 Length identification.** Where the ~~[exhaust duct is concealed within the building construction,]~~ equivalent length of the exhaust duct exceeds 35 feet (10 668 mm) to the outlet terminal, common exhaust, or power ventilator, the equivalent length of the exhaust duct shall be identified on a permanent label or tag. The label or tag shall be located within 6 feet (~~[1829]~~ 1828.8 mm) of the exhaust duct connection.

~~[504.6.6]~~ **504.8.6 Exhaust duct required.** Where space for a clothes dryer is provided, an exhaust duct system shall be installed. Where the clothes dryer is not installed at the time of occupancy, the exhaust duct shall be capped at the location of the future dryer.

Exception: Where a listed condensing clothes dryer is installed prior to occupancy of structure.

~~[504.6.7 Protection required. Protective shield plates shall be placed where nails or screws from finish or other work are likely to penetrate the clothes dryer exhaust duct. Shield plates shall be placed on the finished face of all framing members where there is less than 1¼ inches (32 mm) between the duct and the finished face of the framing member. Protective shield plates shall be constructed of steel, have a thickness of 0.062 inch (1.6 mm) and extend a minimum of 2 inches (51 mm) above sole plates and below top plates.]~~

~~[504.7]~~ **504.9 Commercial clothes dryers.** The installation of dryer exhaust ducts serving ~~[Type 2]~~ commercial clothes dryers shall comply with the appliance manufacturer's ~~[installation]~~ instructions and NFPA 54. Exhaust fan motors installed in exhaust systems shall be located outside of the airstream. In multiple installations, the fan shall operate continuously or be interlocked to operate when any individual unit is operating. Ducts shall have a minimum clearance of 6 inches (~~[152]~~ 152.4 mm) to combustible materials. Clothes dryer transition ducts used to connect the appliance to the exhaust duct system shall be limited to single lengths not to exceed 8 feet (~~[2438]~~ 2438.4 mm) in length and shall be listed and labeled for the application. Transition ducts shall not be concealed within construction.

~~[504.8 Common exhaust systems for clothes dryers located in multistory structures.]~~ **504.10 Common multistory exhaust systems for clothes dryers.** Where a common multistory duct system is designed and installed to convey exhaust from multiple clothes dryers, the construction of the system shall be in accordance with all of the following:

1. The shaft in which the duct is installed shall be constructed and fire-resistance rated as required by the *New York City Building Code*.
2. Dampers and subducts shall be prohibited in the exhaust duct.
3. Rigid metal ductwork shall be installed within the shaft to convey the exhaust. The ductwork shall be constructed of sheet steel having a minimum thickness of 0.0187 inch (~~[0.47]~~ 0.4712 mm) (No. 26 gage) and in accordance with ~~[SMACNA]~~ SMACNA/ANSI Duct Construction Standards. The common ductwork ducts shall not be connected or installed with sheet metal screws or other fasteners that will obstruct the exhaust flow.
4. Exhaust ducts 20 square inches (129 cm²) or less connected into ~~[dryer exhaust shafts]~~ a common multi-story exhaust system shall not require fire dampers when the exhaust fan runs

continuously. Exhaust ducts greater than 20 square inches (129 cm²) shall not be connected into a common [~~shaft with other laundry exhausts~~] multi-story exhaust system.

5. The exhaust fan motor design shall be in accordance with Section 503.2.
6. The exhaust fan motor shall be located outside of the airstream.
7. The exhaust fan shall run continuously, and shall be connected to a standby power source, where a building standby power source is required per the *New York City Building Code*.
8. Exhaust fan operation shall be monitored in an approved location and shall initiate an audible or visual signal when the fan is not in operation.
9. Makeup air shall be provided for the exhaust system.
10. A cleanout opening shall be located at the base of the shaft [~~and~~], at all offsets and at all changes of direction to provide access to the duct to allow for cleaning and inspection. The finished opening shall be not less than 12 inches by 12 inches (~~[305]~~ 304.8 mm by ~~[305]~~ 304.8 mm).
11. Screens shall not be installed at the termination.
12. The common multistory duct system shall serve only clothes dryers and shall be independent of other exhaust systems.

SECTION MC 505 **DOMESTIC KITCHEN EXHAUST EQUIPMENT [~~EXHAUST~~]**

505.1 Domestic systems. Where domestic range hoods [~~and~~] or domestic appliances equipped with downdraft exhaust are [~~located within dwelling units~~] provided, such hoods and appliances shall discharge to the outdoors through ducts constructed of galvanized steel, stainless steel, aluminum or copper. Such ducts shall have smooth inner walls [~~and~~] , shall be air tight [~~and~~] , shall be equipped with a backdraft damper and shall be independent of all other exhaust systems. Such exhaust system shall be installed in strict compliance with the manufacturer's [~~recommendations~~] instructions as well as the requirements of the listing.

Exceptions:

1. [~~Where~~] In other than Group I-1 and I-2, where installed in accordance with the manufacturer's [~~installation~~] instructions and where mechanical or natural ventilation is otherwise provided in accordance with Chapter 4, listed and labeled ductless range hoods shall not be required to discharge to the outdoors.
2. Ducts for domestic kitchen cooking appliances equipped with downdraft exhaust systems shall be permitted to be constructed of Schedule 40 PVC pipe and fittings provided that the installation complies with all of the following:
 - 2.1. The duct shall be installed under a concrete slab poured on grade.

- 2.2. The underfloor trench in which the duct is installed shall be completely backfilled with sand or gravel.
- 2.3. The PVC duct shall extend not [~~greater~~] more than 1 inch (~~[25]~~ 25.4 mm) above the indoor concrete floor surface.
- 2.4. The PVC duct shall extend not [~~greater~~] more than 1 inch (~~[25]~~ 25.4 mm) above grade outside of the building.
- 2.5. The PVC ducts shall be solvent cemented.

505.2 Makeup air required. Exhaust hood systems [~~capable of exhausting in excess of 400 cfm (0.19 m³/s)] where required by Chapter 4 shall be provided with makeup air at a rate in accordance with Table [~~403.3~~] 403.3.1.1. Such makeup air systems shall be equipped with a means of closure and shall be automatically controlled to start and operate simultaneously with the exhaust system.~~

505.3 Reserved.

505.4 Other than Group R. All domestic cooking appliances installed in cafeterias and in Group A-1, A-2, A-4, A-5, and M occupancies shall be provided with hoods and exhaust systems as required for the type of appliances and processes in accordance with Sections 506 and 507. In other than Group R occupancies, domestic appliances may be provided with domestic kitchen exhaust systems ducted to outdoors in accordance with this section provided that the installation complies with all of the following:

1. No more than two domestic cooking appliances are installed in each fire separated room or tenancy in other than Group E occupancies;
2. Each appliance shall have electric or gas connections and nameplate ratings not to exceed 10kW for electric appliances or 75,000 Btu/h for gas appliances. Branch gas connections shall not be larger than ¾ inch (19.1 mm) pipe;
3. The appliances shall not include open top broilers or fryers; and
4. The appliances are used for periodic, non-commercial, non-revenue generating purposes, except for in Group A-3 occupancies, where such appliances may be used a maximum of 8 hours per week to generate revenue.

SECTION MC 506 COMMERCIAL KITCHEN HOOD VENTILATION SYSTEM DUCTS AND EXHAUST EQUIPMENT

506.1 General. Commercial kitchen hood ventilation ducts and exhaust equipment shall comply with the requirements of this section. Commercial kitchen grease ducts shall be designed for the type of cooking appliance and hood served. All ducts shall lead directly to the exterior of the building and terminate as required by Section [~~506.3.12~~] 506.3.13 for Type I hoods and Section 506.4.2 for Type II hoods [;].

Exception: Recirculating hoods that comply with Exception 2 of Section 507.1 do not require ducting in accordance with this section.

506.2 Corrosion protection. Ducts exposed to the outside atmosphere or subject to a corrosive environment shall be protected against corrosion [~~in accordance with the following:~~].

~~[1. At the base of each duct and at its termination point a clearly identifiable permanent sign shall be installed identifying the facility from which the duct originates. All exterior ducts shall be protected on the exterior by paint or other weatherproof protective coating. Stainless steel ducts shall not require paint or weatherproof protective coating.]~~

~~[2. No portion of an exterior metal duct shall be nearer than 24 inches (610 mm) to any door or window or to any exit, or located where it would be readily accessible to the public, unless it is insulated or shielded to avoid injury to any person coming in contact with the duct.]~~

~~[**Exception:** Listed and labeled factory built commercial kitchen grease ducts may be used when installed in accordance with Section 304.1.]~~

506.3 Ducts serving Type I hoods. Type I exhaust ducts shall be independent of all other exhaust systems except as provided in Section 506.3.5. Commercial kitchen duct systems serving Type I hoods shall be designed, constructed and installed in accordance with Sections 506.3.1 through ~~[506.3.12.3]~~ 506.3.13.3.

506.3.1 Duct materials. Ducts serving Type I hoods shall be constructed of materials in accordance with Sections 506.3.1.1 and 506.3.1.2.

506.3.1.1 Grease duct materials. Grease ducts serving Type I hoods, and located within buildings, shall be constructed as follows:

1. Ducts with a cross-sectional area up to and including 155 square inches [~~(100 000 mm²)~~] (1.0 square meters) shall be constructed of 0.0598-inch (1.52 mm) No. 16 Gage steel;
2. Ducts with a cross-sectional area over 155 square inches (100 000 mm²), but not more than 200 square inches (0.129 m²) shall be constructed of 0.074-inch (1.9 mm) No. 14 Gage steel; and
3. Ducts with a cross-sectional area equal to or more than 200 square inches (0.129 m²) shall be constructed of 0.1046-inch (2.66 mm) No. 12 Gage steel.

If stainless steel is used for ducts of any of the cross-sectional areas listed above, the Gage steel may be increased upwards (resulting in a smaller thickness) by 1 even Gage size.

Exception: Listed and labeled factory-built commercial kitchen grease ducts shall be listed and labeled in accordance with UL 1978 and installed in accordance with Section 304.1 and as approved by the commissioner.

506.3.1.2 Makeup air ducts. ~~[Make-up]~~ Makeup air ducts connecting to or within 18 inches (~~[457]~~ 457.2 mm) of a Type I hood shall be constructed and installed in accordance with

Sections 603.1, 603.3, 603.4, 603.9, 603.10 and 603.12. Duct insulation installed within 18 inches ([457] 457.2 mm) of a Type I hood shall be noncombustible or shall be listed for the application.

506.3.2 Joints, seams and penetrations of grease ducts. Joints, seams and penetrations of grease ducts shall be made with a continuous liquid-tight weld or braze made on the external surface of the duct system.

Exceptions:

1. Penetrations shall not be required to be welded or brazed where sealed by devices that are listed for the application.
2. Internal welding or brazing shall not be prohibited provided that the joint is formed or ground smooth and is provided with ready access for inspection.
3. Factory-built commercial kitchen grease ducts listed and labeled in accordance with UL 1978 and installed in accordance with Section 304.1 of this code.

506.3.2.1 Duct joint types. Duct joints shall be butt joints, welded flange joints with a maximum flange depth of ½ inch (12.7 mm) or overlapping duct joints of either the telescoping or bell type. Overlapping joints shall be installed to prevent ledges and obstructions from collecting grease or interfering with gravity drainage to the intended collection point. The difference between the inside cross-sectional dimensions of overlapping sections of duct shall not exceed ¼ inch (6.4 mm). The length of overlap for overlapping duct joints shall not exceed 2 inches (~~[54]~~ 50.8 mm).

506.3.2.2 Duct-to-hood joints. Duct-to-hood joints shall be made with continuous internal or external liquid-tight welded or brazed joints. Such joints shall be smooth, accessible for inspection, and without grease traps.

Exceptions: This section shall not apply to:

1. A vertical duct-to-hood collar connection made in the top plane of the hood in accordance with all of the following:
 - 1.1. The hood duct opening shall have a 1-inch-deep (~~[25]~~ 25.4 mm), full perimeter, welded flange turned down into the hood interior at an angle of 90 degrees (1.57 rad) from the plane of the opening.
 - 1.2. The duct shall have a 1-inch-deep (~~[25]~~ 25.4 mm) flange made by a 1-inch by 1-inch (~~[25]~~ 25.4 mm by ~~[25]~~ 25.4 mm) angle iron welded to the full perimeter of the duct not less than 1 inch (~~[25]~~ 25.4 mm) above the bottom end of the duct.
 - 1.3. A gasket rated for use at not less than 1,500°F (~~[815°C]~~ 815.6°C) is installed between the duct flange and the top of the hood.

- 1.4. The duct-to-hood joint shall be secured by stud bolts not less than ¼ inch (6.4 mm) in diameter welded to the hood with a spacing not greater than 4 inches (~~1402~~ 101.6 mm) on center for the full perimeter of the opening. ~~At~~ The bolts and nuts ~~are to~~ shall be secured with lockwashers.
2. Listed and labeled duct-to-hood collar connections installed in accordance with Section 304.1.

506.3.2.3 Duct-to-exhaust fan connections. Duct-to-exhaust fan connections shall be flanged and gasketed at the base of the fan for vertical discharge fans; shall be flanged, gasketed and bolted to the inlet of the fan for side-inlet utility fans; and shall be flanged, gasketed and bolted to the inlet and outlet of the fan for in-line fans. Approved flexible connectors may be provided. Gasket and sealing materials shall be rated for continuous duty at a temperature of not less than 1,500°F (815.6°C).

506.3.2.4 Vibration isolation. A vibration isolation connector for connecting a duct to a fan shall consist of noncombustible packing in a metal sleeve joint of approved design or shall be a coated-fabric flexible duct connector listed and labeled for the application. Vibration isolation connectors shall be installed only at the connection of a duct to a fan inlet or outlet.

506.3.2.5 Grease duct test. Prior to the use or concealment of any portion of a grease duct system, a leakage test shall be performed. Ducts shall be considered to be concealed where installed in shafts or covered by coatings or wraps that prevent the ductwork from being visually inspected on all sides. The duct installer shall be responsible for providing the necessary equipment and performing the grease duct leakage test. A duct leakage test, in accordance with this section, shall be performed for the entire duct system, including the hood-to-duct connection. The duct work shall be permitted to be tested in sections, provided that every joint is tested.

To determine the tightness of the grease duct construction, a smoke test shall be made in accordance with the following conditions and requirements:

1. The test shall be performed in the presence of the special inspector.
2. The grease duct shall be filled with a thick penetrating smoke produced by one or more smoke machines, or smoke bombs. A static pressure equal to or not less than 2 inches water gauge (500 Pa) shall be maintained throughout the test. The test shall be applied for a length of time sufficient to permit the inspection of the grease duct.
3. If the test shows any evidence of leakage or other defects, such defects shall be corrected in accordance with the requirements of this chapter, and the test shall be repeated until there is no visible smoke observed.

506.3.3 Grease duct supports. Grease duct bracing and supports shall be of noncombustible material securely attached to the structure and designed to carry gravity and seismic loads within the stress limitations of the *New York City Building Code*. Bolts, screws, rivets and other mechanical fasteners shall not penetrate duct walls.

506.3.4 Air velocity. Grease duct systems serving a Type I hood shall be designed and installed to provide an air velocity within the duct system of not less than 500 feet per minute (2.5 m/s).

Exception: The velocity limitations shall not apply within duct transitions utilized to connect ducts to differently sized or shaped openings in hoods and fans, provided that such transitions do not exceed 3 feet (~~914~~ 914.4 mm) in length and are designed to prevent the trapping of grease.

506.3.5 Separation of grease duct system. A separate grease duct system shall be provided for each Type I hood.

Exceptions:

1. A separate grease duct system is not required where all of the following conditions are met:
 - 1.1. All interconnected hoods are located within the same story, provided that they are part of the same facility and under the control of one owner or tenant.
 - 1.2. All interconnected hoods are located within the same room or in adjoining rooms, provided that they are part of the same facility and under the control of one owner or tenant.
 - 1.3. Interconnecting ducts do not penetrate assemblies required to be fire-resistance rated.
 - 1.4. The grease duct system does not serve solid fuel-fired appliances.
2. Branch ducts from other equipment in the same kitchen area, or from registers exhausting the kitchen space in general, may be connected to the main hood exhaust duct if the following requirements are complied with:
 - 2.1. A fusible link fire damper of the same gage as the hood exhaust duct shall be added at the point of connection of the branch duct to the exhaust duct.
 - 2.2. If the branch connection is made to the portion of the ductwork that will contain the fire-extinguishing medium, then the fire dampers required in Exception 2.1 shall be arranged to close automatically upon the operation of the fire-extinguishing system.
 - 2.3. The branch connection shall be made in either the top or sides of the main duct in a manner to prevent grease from flowing into the branch duct.
 - 2.4. The branch ducts shall be constructed of steel, aluminum, or copper of the gages and weights required in Chapter 6, and they shall be insulated with 2 inches (~~51~~ 50.8 mm) of magnesia or other material having equivalent insulative and fire resistance qualities.

- 2.5. All registers in these branches shall have fusible link actuated dampers.
- 2.6. Where branch ductwork is to be used to exhaust vapors from dishwashers, pot sinks, or other similar equipment of a commercial type from which moisture is emitted, copper or aluminum of the minimum gage and weights required in Chapter 6 shall be used. Such ductwork shall be installed so that condensate cannot leak from it.
- 2.7. Type I and Type II exhaust systems can be interconnected downstream of filters with a fire damper at the connection to the exhaust system.

506.3.6 Grease duct clearances. Where enclosures are not required, grease duct systems and exhaust equipment serving a Type I hood shall have a clearance to combustible construction of not less than 18 inches (~~[457]~~ 457.2 mm), and shall have a clearance to noncombustible construction and gypsum wallboard attached to noncombustible structures of not less than 3 inches (~~[76]~~ 76.2 mm).

Exceptions:

1. For factory-built commercial kitchen grease ducts [~~5~~] listed and labeled in accordance with UL 1978, the required clearance shall be in accordance with the listing of such material and as approved by the commissioner.
2. Listed and labeled exhaust equipment installed in accordance with Section 304.1.
3. Where commercial kitchen grease ducts are continuously covered on all sides with a listed and labeled field-applied grease duct enclosure material, system, product or method of construction specifically evaluated for such purpose in accordance with ASTM E 2336, the required clearance shall be in accordance with the listing of such material, system, product or method.
4. Grease ducts protected with a minimum insulation covering of 2 inches (~~[51]~~ 50.8 mm) of magnesium or calcium silicate block, with staggered joints, attached with galvanized steel wire or material assembly equivalent in insulating and fire-resistant qualities which cannot be penetrated by grease [~~5~~]. Such protection shall be applied to all ducts inside of the building as approved by the commissioner.

506.3.7 Prevention of grease accumulation in grease ducts. Duct systems serving a Type I hood shall be constructed and installed so that grease cannot collect in any portion thereof, and the system shall slope not less than one-fourth unit vertical in 12 units horizontal (2-percent slope) toward the hood or toward ~~[an approved]~~ a grease reservoir designed and installed in accordance with Section 506.3.7.1. Where horizontal ducts exceed 75 feet (22 860 mm) in length, the slope shall be not ~~[be]~~ less than one unit vertical in 12 units horizontal (8.3-percent slope). Dampers shall not be installed in the grease duct systems, except as required by Section 506.3.5, Exception 2.

506.3.7.1 ~~[Residue trap. A residue trap shall be provided at the base of each vertical riser with provision for cleanout in accordance with NFPA 96.]~~ **Grease duct reservoirs.** Grease duct reservoirs shall:

1. Be constructed as required for the grease duct they serve.
2. Be located on the bottom of the horizontal duct or the bottommost section of the duct riser.
3. Extend across the full width of the duct and have a length of not less than 12 inches (304.8 mm).
4. Have a depth of not less than 1 inch (25.4 mm).
5. Have a bottom that slopes to a capped drain connection.
6. Be provided with a cleanout opening constructed in accordance with Section 506.3.8 and installed to provide direct access to the reservoir. The cleanout opening shall be located on a side or on top of the duct so as to permit cleaning of the reservoir.
7. Be installed in accordance with the manufacturer's instructions where manufactured devices are utilized.

506.3.8 Grease duct cleanouts and other openings. Grease duct systems shall not have openings therein other than those required for proper operation and maintenance of the system. Any portion of such system having sections not provided with access from the duct entry or discharge shall be provided with cleanout openings. Cleanout openings shall be provided at every change in direction, within 3 feet (~~[914]~~ 914.4 mm) of the exhaust fan, and as required under Section 506.3.9. Cleanout openings shall be equipped with tight-fitting doors constructed of steel having a thickness not less than that required for the duct. Doors shall be equipped with a substantial method of latching, sufficient to hold the door tightly closed. Doors shall be designed so that they are operable without the use of a tool. Door assemblies shall have a gasket or sealant that is noncombustible and liquid tight, and shall not have fasteners that penetrate the duct. Listed and labeled access door assemblies shall be installed in accordance with the terms of the listing. Signage shall be provided at all required access doors and openings in accordance with Section ~~[506.3.11]~~ 506.3.12.

506.3.8.1 Personnel entry. Where ductwork is large enough to allow entry of personnel, not less than one approved or listed opening having dimensions not less than 22 inches by 20 inches (~~[559]~~ 558.8 mm by 508 mm) shall be provided in the horizontal sections, and in the top of vertical risers. Where such entry is provided, the duct and its supports shall be capable of supporting the additional load, and the cleanouts specified in Section 506.3.8 are not required. Where personnel entry is not possible for cleaning the interior of vertical ducts, suitable provisions shall be made to clean the vertical duct in its entirety as well as ~~[for]~~ for cleaning the base of the vertical riser.

506.3.8.2 Cleanouts serving in-line fans. A suitable cleanout shall be provided for both the inlet side and outlet side of an in-line fan except where a duct does not connect to the fan.

Such cleanouts shall be located within 3 feet ([914] 914.4 mm) of the fan duct connections to permit a thorough cleaning of the inlet and discharge ducts connected to the in-line fan as well as the interior of the fan itself.

Exception: Where suitable cleanouts for in-line fans cannot be provided, the in-line fan shall be of “clam shell” construction which shall permit the fan to be opened and thoroughly cleaned while remaining in place.

506.3.9 Grease duct horizontal cleanouts. Cleanouts located on horizontal sections of ducts shall be spaced not more than 20 feet (6096 mm) apart, unless the opening prescribed by Section 506.3.8.1 is not possible, in which case openings large enough to permit thorough cleaning shall be provided at 12-foot [feet] ([3658] 3657.6 mm) intervals. The cleanouts shall be located on the side of the duct with the opening not less than 1.5 inches ([38] 38.1 mm) above the bottom of the duct, and not less than 1 inch ([25] 25.4 mm) below the top of the duct. The opening minimum dimensions shall be 12 inches ([305] 304.8 mm) on each side. Where the dimensions of the side of the duct prohibit the cleanout installation prescribed herein, the openings shall be on the top of the duct or the bottom of the duct. Where located on the top of the duct, the opening edges shall be a minimum of 1 inch ([25] 25.4 mm) from the edges of the duct. Where located in the bottom of the duct, cleanout openings shall be designed to provide internal damming grease down the duct around the dam, and shall be approved for the application. Where the dimensions of the sides, top or bottom of the duct preclude the installation of the prescribed minimum-size cleanout opening, the cleanout shall be located on the duct face that affords the largest opening dimension and shall be installed with the opening edges at the prescribed distances from the duct edges as previously set forth in this section.

506.3.10 Underground and raised floor cavity grease duct installation. Grease ducts shall not be installed underground or in raised floor cavities.

506.3.11 Grease duct enclosure. [~~A grease duct serving a Type I hood that penetrates a ceiling, wall or floor shall be enclosed from the first point of penetration to the outlet terminal. A duct shall penetrate exterior walls only at locations where unprotected openings are permitted by the *New York City Building Code*. The duct enclosure shall serve a single grease duct and shall not contain other ducts, piping or wiring systems. Duct enclosures shall be either field-applied or factory-built. Duct enclosures shall have a fire-resistance rating not less than that of the fire-resistance-rated assembly penetrated, but need not exceed 2 hours. Duct enclosures shall be as prescribed by Section 506.3.10.1, 506.3.10.2 or 506.3.10.3.] A commercial kitchen grease duct serving a Type I hood that penetrates a ceiling, wall, floor or any concealed space shall be enclosed from the first point of penetration to the outlet terminal. In-line exhaust fans not located outdoors shall be enclosed as required for grease ducts. A duct shall penetrate exterior walls only at locations where unprotected openings are permitted by the *New York City Building Code*. The duct enclosure shall serve a single grease duct and shall not contain other ducts, piping or wiring systems. Duct enclosures shall be a shaft enclosure in accordance with Section 506.3.11.1, a field-applied enclosure assembly in accordance with Section 506.3.11.2 or a factory-built enclosure assembly in accordance with Section 506.3.11.3. Duct enclosures shall have a fire-resistance rating of not less than that of the fire-resistance-rated assembly penetrated and not less than 1 hour. Fire dampers and smoke dampers shall not be installed in grease ducts.~~

Exception: A duct enclosure shall not be required for a grease duct that penetrates only a nonfire-resistance-rated roof/ceiling assembly.

[506.3.10.1] 506.3.11.1 Shaft enclosure. [~~Commercial kitchen grease~~] Grease ducts constructed in accordance with Section 506.3.1 shall be permitted to be enclosed in accordance with the *New York City Building Code* requirements for shaft construction. Such grease duct systems and exhaust equipment shall have a clearance to combustible construction of not less than 18 inches (~~[457]~~ 457.2 mm), and shall have a clearance to noncombustible construction and gypsum wallboard attached to noncombustible structures of not less than 6 inches (~~[452]~~ 152.4 mm). Duct enclosures shall be sealed around the duct at the point of penetration and vented to the outside of the building through the use of weather-protected openings.

Exceptions:

1. The shaft enclosure provisions of this section shall not be required where a duct penetration is protected with a through-penetration firestop system classified in accordance with ASTM E 814 and having an “F” and “T” rating equal to the fire-resistance rating of the assembly being penetrated and where the surface of the duct is continuously covered on all sides from the point at which the duct penetrates a ceiling, wall or floor to the outlet terminal with a classified and labeled material, system, method of construction or product specifically evaluated for such purpose, which material, system, method of construction or product is approved by the commissioner and installed according to the manufacturer’s instructions. Exposed duct wrap systems shall be protected where subject to physical damage.
2. As an alternative to Exception 1 [~~4~~] of this section, a minimum insulation covering of 2 inches (~~[51]~~ 50.8 mm) of magnesium or calcium silicate block, with staggered joints, attached with galvanized steel wire or material assembly equivalent in insulating and fire-resistant qualities which cannot be penetrated by grease, and as approved by the commissioner, shall be applied to all ducts inside of the building.
3. A duct enclosure shall not be required for a grease duct that penetrates only a nonfire-resistance-rated roof/ceiling assembly.
4. A listed and labeled factory-built commercial kitchen grease duct system, evaluated as an enclosure system for reduced clearances to combustibles, and approved by the commissioner and installed according to manufacturer’s instructions.

[506.3.10.2] 506.3.11.2 Field-applied grease duct enclosure. [~~Commercial kitchen grease~~] Grease ducts constructed in accordance with Section 506.3.1 shall be enclosed by a listed and labeled field-applied grease duct enclosure [~~that is a listed and labeled~~] material, [~~system~~] systems, product, or method of construction specifically evaluated for such purpose in accordance with ASTM E 2336. The surface of the duct shall be continuously covered on all sides from the point at which the duct originates to the outlet terminal. Duct penetrations shall

be protected with a through-penetration firestop system ~~[classified]~~ tested and listed in accordance with ASTM E 814 or UL 1479 and having an “F” and “T” rating equal to the fire-resistance rating of the assembly being penetrated. ~~[Such systems]~~ The grease duct enclosure and firestop system shall be installed in accordance with the listing and the manufacturer’s ~~[installation]~~ instructions. Exposed ~~[duct wrap]~~ duct-wrap systems shall be protected where subject to physical damage.

[506.3.10.3] 506.3.11.3 Factory-built grease duct enclosure assemblies. Factory-built grease ~~[duct assemblies]~~ ducts incorporating integral enclosure materials shall be listed and labeled for use as ~~[commercial kitchen]~~ grease duct enclosure assemblies specifically evaluated for such purpose in accordance with UL 2221. Duct penetrations shall be protected with a through-penetration firestop system ~~[classified]~~ tested and listed in accordance with ASTM E 814 or UL 1479 and having an “F” and “T” rating equal to the fire-resistance rating of the assembly being penetrated. ~~[Such assemblies]~~ The grease duct enclosure assembly and firestop system shall be installed in accordance with the listing and the manufacturer’s ~~[installation]~~ instructions.

[506.3.10.4 Duct enclosure not required. A duct enclosure shall not be required for a grease duct that penetrates only a nonfire-resistance-rated roof/ceiling assembly.]

[506.3.11] 506.3.12 Grease duct fire-resistive access opening. Where cleanout openings are located in ducts within a fire-resistance-rated enclosure, access openings shall be provided in the enclosure at each cleanout point. Access openings shall be equipped with tight-fitting sliding or hinged doors that are equal in fire-resistive protection to that of the shaft or enclosure. An approved sign shall be placed on access opening panels with wording as follows: “ACCESS PANEL. DO NOT OBSTRUCT.” Cleanout openings provided in ducts that are not located within a fire-resistance-rated enclosure shall be provided with sign- age at the required opening that contains the same wording.

[506.3.12] 506.3.13 Exhaust outlets serving Type I hoods. Exhaust outlets for grease ducts serving Type I hoods shall conform to the requirements of Sections ~~[506.3.12.1]~~ 506.3.13.1 through ~~[506.3.12.3]~~ 506.3.13.3.

[506.3.12.1] 506.3.13.1 Termination above the roof. Exhaust outlets that terminate above the roof shall have the discharge opening located not less than 40 inches (1016 mm) above the roof surface. The exhaust flow shall be directed away from the surface of the roof.

[506.3.12.2] 506.3.13.2 Termination through an exterior wall. Exhaust outlets shall be permitted to terminate through exterior walls where the smoke, grease, gases, vapors and odors in the discharge from such terminations do not create a public nuisance or a fire hazard. Such terminations shall not be located where protected openings are required by the *New York City Building Code*. Other exterior openings shall not be located within 3 feet (~~[914]~~ 914.4 mm) of such terminations.

[506.3.12.3] 506.3.13.3 Termination location. Exhaust outlets shall be located not less than 10 feet (3048 mm) horizontally from parts of the same or contiguous buildings, adjacent buildings and adjacent property lines and shall be located not less than 10 feet (3048 mm) above the adjoining grade level. Exhaust outlets shall be located not less than 10 feet (3048

mm) horizontally from and not less than 3 feet (~~[914]~~ 914.4 mm) above air intake openings into any building.

Exception: Exhaust outlets shall terminate not less than 5 feet (1524 mm) horizontally from parts of the same or contiguous building, an adjacent building, adjacent property line and air intake openings into a building where air from the exhaust outlet discharges away from such locations.

506.4 Ducts serving Type II hoods. [~~Single or combined Type II exhaust systems for food processing operations shall be independent of all other exhaust systems.~~] Commercial kitchen exhaust systems serving Type II hoods shall comply with Sections 506.4.1 and 506.4.2.

506.4.1 Ducts. Ducts and plenums serving Type II hoods shall be constructed of rigid metallic materials. Duct construction, installation, bracing and supports shall comply with Chapter 6. Ducts subject to positive pressure and ducts conveying moisture-laden or waste-heat-laden air shall be constructed, joined and sealed in an approved manner.

506.4.2 Type II terminations. Exhaust outlets serving Type II hoods shall terminate in accordance with the hood manufacturer's [~~installation~~] instructions and shall comply with all of the following:

1. [~~Exhaust outlets~~] Outlets shall terminate not less than 3 feet (~~[914]~~ 914.4 mm) in any direction from openings into the building.
2. Outlets shall terminate not less than 10 feet (3048 mm) from property lines or buildings on the same lot.
3. Outlets shall terminate not less than 10 feet (3048 mm) above grade.
4. Outlets that terminate above a roof shall terminate not less than 30 inches (762 mm) above the roof's surface.
5. Outlets shall terminate not less than 30 inches (762 mm) from exterior vertical walls.
6. Outlets shall be protected against local weather conditions.
7. Outlets shall not be directed onto walkways.
8. Outlets shall [~~be in accordance with~~] meet the provisions for exterior wall opening protectives in accordance with the *New York City Building Code*.

506.4.2.1 Cooking spaces. For all buildings other than those classified as residential occupancy, a minimum of No. 16 Gage for galvanized sheet duct shall be used for nongrease duct exhaust applications.

506.5 Exhaust equipment. Exhaust equipment, including fans and grease reservoirs, shall comply with Sections 506.5.1 through 506.5.5 and shall be of an approved design or shall be listed for the application.

506.5.1 Exhaust fans. Exhaust fan housings serving a Type I hood shall be constructed as required for grease ducts in accordance with Section 506.3.1.1.

Exception: Fans listed and labeled in accordance with UL 762.

506.5.1.1 Fan motor. Exhaust fan motors shall be located outside of the exhaust airstream.

506.5.1.2 In-line fan location. Where enclosed duct systems are connected to in-line fans not located outdoors, the fan shall be located in a room or enclosure having the same fire-resistance rating as the duct enclosure. Access shall be provided for servicing and cleaning of fan components. Such rooms or enclosures shall be ventilated in accordance with the fan manufacturer's instructions.

506.5.2 Exhaust fan discharge. Exhaust fans shall be positioned so that the discharge will not impinge on the roof, other equipment or appliances or parts of the structure. A vertical discharge fan serving a Type I hood shall be manufactured with an approved drain outlet at the lowest point of the housing to permit drainage of grease to an approved grease reservoir.

506.5.3 Exhaust fan mounting. ~~[An upblast fan shall be hinged and supplied with a flexible weatherproof electrical cable to permit inspection and cleaning. The ductwork shall extend a minimum of 18 inches (457 mm) above the roof surface.]~~ Up-blast fans serving Type I hoods and installed in a vertical or horizontal position shall be hinged, supplied with a flexible weatherproof electrical cable to permit inspection and cleaning and shall be equipped with a means of restraint to limit the swing of the fan on its hinge. The ductwork shall extend not less than 18 inches (457.2 mm) above the roof surface.

506.5.4 Reserved.

506.5.5 Termination location. The outlet of exhaust equipment serving Type I hoods shall be in accordance with Section ~~[506.3.12]~~ 506.3.13.

Exception: The minimum horizontal distance between vertical discharge fans and parapet-type building structures shall be 2 feet (~~[610]~~ 609.6 mm) provided that such structures are not higher than the top of the fan discharge opening.

506.5.6 Exhaust fan operation. The operation of the exhaust fan shall be in accordance with the following requirements:

1. The hood exhaust fan(s) shall continue to operate after the extinguishing system has been activated unless fan shutdown is required by a listed component of the ventilation system or by the design of the extinguishing system.
2. The hood exhaust fan shall not be required to start automatically upon activation of the extinguishing system if the exhaust fan and all cooking equipment served by the fan have previously been shut down.
3. The cooking appliances shall be interlocked with the exhaust hood system to prevent appliance operation when the exhaust hood system is not operating.

506.6 Exterior duct installations. The installation of exterior ducts shall comply with the following requirements:

1. The exterior portion of the ductwork shall be vertical wherever possible and shall be installed and supported on the exterior of a building.
2. Bolts, screws, rivets, and other mechanical fasteners shall not penetrate duct walls.
3. Clearance of any ducts shall comply with Section 506.3.6.
4. All ducts shall be protected on the exterior by paint or other suitable weather-protective coating.
5. Ducts constructed of stainless steel shall not be required to have additional paint or weather-protective coatings.
6. Ductwork subject to corrosion shall have minimal contact with the building surface.
7. No portion of an exterior metal duct shall be nearer than 24 inches ([610] 609.6 mm) to any door or window or to any exit, or located where it would be readily accessible to the public, unless it is insulated or shielded to avoid injury to any person coming in contact with the duct.

Exception: Listed and labeled factory-built commercial kitchen grease ducts may be used when installed in accordance with Section 304.1.

506.7 Identification of ducts. All duct systems serving Type I and Type II exhaust equipment shall be permanently labeled: “CAUTION: KITCHEN EXHAUST SYSTEM.” At the base of each duct and at its termination point, a clearly identifiable permanent sign shall be installed identifying the facility from which the duct originates.

SECTION MC 507 COMMERCIAL KITCHEN HOODS

507.1 General. Commercial kitchen exhaust hoods shall comply with the requirements of this section. Hoods shall be Type I or [Type] II and shall be designed to capture and confine cooking vapors and residues. [~~Commercial kitchen exhaust hood systems shall operate at all times while cooking equipment is in operation. For additional interlock requirements pertaining to gas appliances, refer to Section 505.1 of the *New York City Fuel Gas Code*.~~] A Type I or Type II hood shall be installed at or above all commercial cooking appliances in accordance with Section 507.2 and 507.3. Where any cooking appliance under a single hood requires a Type I hood, a Type I hood shall be installed. Where a Type II hood is required, a Type I or Type II hood shall be installed. Where a Type I hood is installed, the installation of the entire system, including the hood, ducts, exhaust equipment and makeup air system shall comply with the requirements of Sections 506, 507, 508 and 509. Where total kitchen hood exhaust airflow rate is greater than 5,000 cfm or as required by the *New York City Energy Conservation Code*, each hood shall be a factory-built commercial exhaust hood listed by a nationally recognized testing laboratory in compliance with UL 710.

Exceptions:

1. ~~[Factory built commercial exhaust hoods which are tested in accordance with UL 710, listed, labeled and installed in accordance with Section 304.1 shall not be required to comply with Sections 507.4, 507.7, 507.11, 507.12, 507.13, 507.14 and 507.15.] Factory-built commercial exhaust hoods that are listed and labeled in accordance with UL 710, and installed in accordance with Section 304.1, shall not be required to comply with Sections 507.1.5, 507.2.3, 507.2.5, 507.2.8, 507.3.1, 507.3.3, 507.4 and 507.5.~~
2. Hoods used with electric cooking equipment shall be in accordance with UL 710B and have a grease removal and fire suppression system.
3. ~~[Net exhaust volumes for hoods shall be permitted to be reduced during part load cooking conditions, where engineered or listed multispeed or variable speed controls automatically operate the exhaust system to maintain capture and removal of cooking effluents as required by this section. Reduced volumes shall not be below that required to maintain capture and removal of effluents from the idle cooking appliances that are operating in a standby mode.] Where cooking appliances are equipped with integral down-draft exhaust systems and such appliances and exhaust systems are listed and labeled for the application in accordance with NFPA 96, a hood shall not be required at or above them.~~

~~[507.2 Where required. A Type I or Type II hood shall be installed at or above all commercial cooking appliances in accordance with Sections 507.2.1 and 507.2.2. Where any cooking appliance at or under a single hood requires a Type I hood, a Type I hood shall be installed. Where a Type II hood is required, a Type I or Type II hood shall be installed.]~~

~~[507.2.1 Type I hoods. Type I hoods shall be installed where cooking appliances produce grease or smoke. Type I hoods shall be installed over medium duty, heavy duty and extra heavy duty cooking appliances. Type I hoods shall be installed over light duty cooking appliances that produce grease or smoke.]~~

~~[507.2.1.1 Operation. Type I hood systems shall be designed and installed to automatically activate the exhaust fan whenever cooking operations occur. The activation of the exhaust fan shall occur through an interlock with the cooking appliances, by means of heat sensors or by means of other approved methods. Commercial cooking appliances equipped with integral down-draft exhaust shall meet the requirements of Section 507.2.]~~

~~[507.2.2 Type II hoods. Type II hoods shall be installed above dishwashers and light duty appliances that produce heat or moisture and do not produce grease or smoke except where the heat and moisture loads from such appliances are incorporated into a separate removal system. Type II hoods shall be installed above all light duty appliances that produce products of combustion and do not produce grease or smoke. Spaces containing cooking appliances that do not require Type II hoods shall be ventilated in accordance with Section 403.3. For the purpose of determining the floor area required to be ventilated, each individual appliance that is not required to be installed under a Type II hood shall be considered as occupying not less than 100 square feet (9.3 m²). Type II hoods or heat and water exhaust systems installed in accordance with the manufacturer's recommendations are required for commercial dishwashers and pot washer equipment.]~~

507.1.1 Operation. Commercial kitchen exhaust hood systems shall operate while cooking equipment is in operation. The hood exhaust rate shall comply with the listing of the hood or shall comply with Section 507.5. The exhaust fan serving a Type I hood shall have automatic controls that will activate the fan when any appliance that requires such Type I Hood is turned on, or a means of interlock shall be provided that will prevent operation of such appliances when the exhaust fan is not turned on. Where one or more temperature or radiant energy sensors are used to activate a Type I hood exhaust fan, the fan shall activate not more than 15 minutes after the first appliance served by that hood has been turned on. A method of interlock between an exhaust hood system and appliances equipped with standing pilot burners shall not cause the pilot burners to be extinguished. A method of interlock between an exhaust hood system and cooking appliances shall not involve or depend upon any component of a fire-extinguishing system.

Hood exhaust volumes may be reduced during part-load cooking conditions only for listed hoods that are provided with variable speed or multispeed controls from or as approved by the hood manufacturer. Such controls shall automatically operate the exhaust system to maintain capture and removal of cooking effluents as required by this section. Reduced volumes shall maintain capture and removal of effluents from the idle cooking appliances that are operating in a standby mode. Minimum duct velocities shall be maintained during part load operation. The replacement air system shall be operated in coordination with the variable flow operation of the exhausts.

507.1.1.1 Multiple hoods utilizing a single exhaust system. Where heat or radiant energy sensors are utilized in hood systems consisting of multiple hoods served by a single exhaust system, such sensors shall be provided in each hood. Sensors shall be capable of being accessed from the hood outlet or from a cleanout location.

~~[507.2.3]~~ **507.1.2 Domestic cooking appliances used for commercial purposes.** ~~[Domestic cooking appliances utilized for commercial purposes shall be provided with Type I or Type II hoods as required for the type of appliances and processes in accordance with Sections 507.2, 507.2.1 and 507.2.2.]~~ Domestic cooking appliances utilized for commercial purposes and all domestic cooking appliances installed in cafeterias and Group A-1, A-2, A-4, A-5, and M occupancies shall be provided with Type I, Type II, or UL 710B hoods as required for the type of appliances and processes in accordance with Sections 507.2 and 507.3. Refer to Section 505.4 for qualifying non-commercial uses.

~~[507.2.4 Extra-heavy-duty. Type I hoods for use over extra heavy duty cooking appliances shall not cover heavy, medium or light duty appliances. Such hoods shall discharge to an exhaust system that is independent of other exhaust systems.]~~

~~[507.3]~~ **507.1.3 Fuel-burning appliances.** Where vented fuel-burning appliances are located in the same room or space as the hood, provisions shall be made to prevent the hood system from interfering with normal operation of the appliance vents.

507.1.4 Cleaning. A hood shall be designed to facilitate thorough cleaning of the entire hood.

507.1.5 Exhaust outlets. Exhaust outlets located within the hood shall be located to optimize the capture of particulate matter. Each outlet shall serve not more than a 12-foot (3657.6 mm) section of hood.

507.2 Type I hoods. Type I hoods shall be installed where cooking appliances produce grease or smoke as a result of the cooking process. Type I hoods shall be installed over medium-duty, heavy-duty and extra-heavy-duty cooking appliances.

Exception: A Type I hood shall not be required for an electric cooking appliance where an approved testing agency provides documentation that the appliance effluent contains 5 mg/m³ or less of grease when tested at an exhaust flow rate of 500 cfm (0.236 m³/s) in accordance with UL 710B.

507.2.1 Type I exhaust flow rate label. Type I hoods shall bear a label indicating the minimum exhaust flow rate in cfm per linear foot (L/s per linear meter) of hood that provides for capture and containment of the exhaust effluent for the cooking appliances served by the hood, based on the cooking appliance duty classifications defined in this code.

507.2.2 Type I extra-heavy-duty. Type I hoods for use over extra-heavy-duty cooking appliances shall not cover heavy-, medium- or light-duty appliances. Such hoods shall discharge to an exhaust system that is independent of other exhaust systems.

~~[507.4]~~ **507.2.3 Type I materials.** Type I hoods shall be constructed of steel having a minimum thickness of 0.0466 inch (~~[1-18]~~ 1.181 mm) (No. 18 gage) or stainless steel not less than 0.0335 inch (0.8525 mm) (No. 20 MSG) in thickness.

~~[507.5 Type II hood materials.~~ Type II hoods shall be constructed of steel having a minimum thickness of 0.0296 inch (0.7534 mm) (No. 22 gage) stainless steel not less than 0.0220 inch (0.5550 mm) (No. 24 gage) in thickness, copper sheets weighing not less than 24 ounces per square foot (7.3Kg/m²) or of other approved material and gage.]

~~[507.6 Supports.]~~ **507.2.4 Type I supports.** Type I hoods shall be secured in place by noncombustible supports. [AH] Type I [and Type II] hood supports shall be adequate for the applied load of the hood, the unsupported ductwork, the effluent loading and the possible weight of personnel working in or on the hood.

~~[507.7 Hood joints, seams and penetrations.~~ Hood joints, seams and penetrations shall comply with Sections 507.7.1 and 507.7.2.]

~~[507.7.1 Type I hoods.]~~ **507.2.5 Type I hood joints, seams and penetrations.** External hood joints, seams and penetrations for Type I hoods shall be made with a continuous external liquid-tight weld or braze to the lowest outermost perimeter of the hood. Internal hood joints, seams, penetrations, filter support frames and other appendages attached inside the hood shall not be required to be welded or brazed but shall be otherwise sealed to be grease tight.

Exceptions:

1. Penetrations shall not be required to be welded or brazed where sealed by devices that are listed for the application.

2. Internal welding or brazing of seams, joints and penetrations of the hood shall not be prohibited provided that the joint is formed smooth or ground so as to not trap grease, and is readily cleanable.

~~[507.7.2 Type II hoods. Joints, seams and penetrations for Type II hoods shall be constructed as set forth in Chapter 6, shall be sealed on the interior of the hood and shall provide a smooth surface that is readily cleanable and water tight.]~~

~~[507.8 Cleaning and grease gutters. A hood shall be designed to provide for thorough cleaning of the entire hood. Grease gutters shall drain to an approved collection receptacle that is fabricated, designed and installed to allow access for cleaning.]~~

~~[507.9] 507.2.6 Clearances for Type I hood. A Type I hood shall be installed with a clearance to combustibles of not less than 18 inches ([457] 457.2 mm).~~

Exception: Clearance shall not be required from gypsum wallboard or ½-inch (12.7 mm) or thicker cementitious wallboard attached to noncombustible structures provided that a smooth, cleanable, nonabsorbent and noncombustible material is installed between the hood and the gypsum or cementitious wallboard over an area extending not less than 18 inches ([457] 457.2 mm) in all directions from the hood.

~~[507.10 Hoods penetrating a ceiling.] 507.2.7 Type I hoods penetrating a ceiling. Type I hoods or portions thereof penetrating a ceiling, wall or furred space shall comply with [all the requirements of Section 506.3.10.] Section 506.3.11. Field-applied grease duct enclosure systems, as addressed in Section 506.3.11.2, shall not be utilized to satisfy the requirements of this section.~~

~~[507.11 Grease filters.] 507.2.8 Type I grease filters. Type I hoods shall be equipped with [UL 1046 listed] grease filters [designed for the specific purpose. Grease collecting equipment] listed and labeled in accordance with UL 1046. Grease filters shall be provided with access for cleaning or replacement. The lowest edge of a grease filter located above the cooking surface shall be not less than the height specified in Table [507.11] 507.2.8.~~

**TABLE [507.11] 507.2.8
MINIMUM DISTANCE BETWEEN THE LOWEST EDGE OF A GREASE FILTER
AND THE COOKING SURFACE OR THE HEATING SURFACE**

TYPE OF COOKING APPLIANCE	HEIGHT ABOVE COOKING SURFACE (feet)
Without exposed flame	0.5
Exposed flame and burners	2
Exposed charcoal and charbroil type	4

For SI: 1 foot = 304.8 mm.

~~[507.11.1] 507.2.8.1 Criteria. Filters shall be of such size, type and arrangement as will permit the required quantity of air to pass through such units at rates not exceeding those for which the filter or unit was designed or approved. Filter units shall be installed in frames or holders so as to be readily removable without the use of separate tools, unless designed and installed to be cleaned in place and the system is equipped for such cleaning in place. [Removable] Where filters are designed and required to be cleaned, removable filter units shall be of a size that will allow them to be cleaned in a dishwashing machine or pot sink.~~

Filter units shall be arranged in place or provided with drip-intercepting devices to prevent grease or other condensate from dripping into food or on food preparation surfaces.

~~[507.11.2 Mounting position.]~~ **507.2.8.2 Mounting position of grease filters.** Filters shall be installed at an angle of not less than 45 degrees (0.79 rad) from the horizontal and shall be equipped with a drip tray beneath the lower edge of the filters.

507.2.9 Grease gutters for Type I hood. Grease gutters shall drain to an approved collection receptacle that is fabricated, designed and installed to allow access for cleaning.

507.3 Type II hoods. Type II hoods shall be installed above dishwashers and appliances that produce heat or moisture and do not produce grease or smoke as a result of the cooking process, except where the heat and moisture loads from such appliances are incorporated into the HVAC system design or into the design of a separate removal system. Type II hoods shall be installed above all appliances that produce products of combustion and do not produce grease or smoke as a result of the cooking process. Spaces containing cooking appliances that do not require Type II hoods shall be provided with exhaust at a rate of 0.70 cfm per square foot (0.00033 m³/s). For the purpose of determining the floor area required to be exhausted, each individual appliance that is not required to be installed under a Type II hood shall be considered as occupying not less than 100 square feet (9.3 m²). Such additional square footage shall be provided with exhaust at a rate of 0.70 cfm per square foot (0.00356 m³/(s × m²)).

507.3.1 Type II hood materials. Type II hoods shall be constructed of steel having a minimum thickness of 0.0296 inch (0.7534 mm) (No. 22 gage) or stainless steel not less than 0.0220 inch (0.5550 mm) (No. 24 gage) in thickness, copper sheets weighing not less than 24 ounces per square foot (7.3 kg/m²) or of other approved material and gage.

~~[507.11.3 Filter servicing. Filters shall be serviced and replaced regularly by qualified employees of the owner or by a cleaning agency. A record indicating the name of the person or firm doing the servicing and the dates when filters were cleaned or replaced shall be available for inspection by the commissioner. They shall be cleaned or replaced as frequently as necessary, but at least every 3 months, and no exhaust system shall be operated while cooking is being carried on without the filters installed in place.]~~

507.3.2 Type II supports. Type II hood supports shall be adequate for the applied load of the hood, the unsupported ductwork, the effluent loading and the possible weight of personnel working in or on the hood.

507.3.3 Type II hood joints, seams and penetrations. Joints, seams and penetrations for Type II hoods shall be constructed as set forth in Chapter 6, shall be sealed on the interior of the hood and shall provide a smooth surface that is readily cleanable and water tight.

507.4 Hood size and location. Hoods shall comply with the overhang, setback and height requirements in accordance with Sections 507.4.1 and 507.4.2, based on the type of hood.

~~[507.12]~~ **507.4.1 Canopy size and location.** The inside lower edge of canopy-type Type I and II commercial hoods shall overhang or extend a horizontal distance of not less than 6 inches ([152] 152.4 mm) beyond the edge of the top horizontal surface of the appliance on all open sides. The

vertical distance between the front lower lip of the hood and such surface shall not exceed 4 feet (~~[1219]~~ 1219.2 mm).

Exception: The hood shall be permitted to be flush with the outer edge of the cooking surface where the hood is closed to the appliance side by a noncombustible wall or panel.

507.4.2 Noncanopy size and location. Noncanopy-type hoods shall be located not greater than 3 feet (914.4 mm) above the cooking surface. The edge of the hood shall be set back not greater than 1 foot (304.8 mm) from the edge of the cooking surface.

~~[507.13]~~ **507.5 Capacity of hoods.** Commercial food service hoods shall exhaust a minimum net quantity of air determined in accordance with this section and Sections ~~[507.13.1]~~ 507.5.1 through ~~[507.13.5]~~ 507.5.5. The net quantity of exhaust air shall be calculated by subtracting any airflow supplied directly to a hood cavity from the total exhaust flow rate of a hood. Where any combination of heavy-duty, medium-duty and light-duty cooking appliances are utilized under a single hood, the exhaust rate required by this section for the heaviest duty appliance covered by the hood shall be used for the entire hood.

~~[507.13.1]~~ **507.5.1 Extra-heavy-duty cooking appliances.** The minimum net airflow for hoods, as determined by Section ~~[507.2]~~ 507.1, used for extra-heavy-duty cooking appliances shall be determined as follows:

Type of Hood	CFM per linear foot of hood
Backshelf/pass-over	Not allowed
Double island canopy (per side)	550
Eyebrow	Not allowed
Single island canopy	700
Wall-mounted canopy	550

For SI: 1 cfm per linear foot = 1.55 L/s per linear meter.

~~[507.13.2]~~ **507.5.2 Heavy-duty cooking appliances.** The minimum net airflow for hoods, as determined by Section ~~[507.2]~~ 507.1, used for heavy-duty cooking appliances shall be determined as follows:

Type of Hood	CFM per linear foot of hood
Backshelf/pass-over	400
Double island canopy (per side)	400
Eyebrow	Not allowed
Single island canopy	600
Wall-mounted canopy	400

For SI: 1 cfm per linear foot = 1.55 L/s per linear meter.

[507.13.3] 507.5.3 Medium-duty cooking appliances. The minimum net airflow for hoods, as determined by Section [507.2] 507.1, used for medium-duty cooking appliances shall be determined as follows:

Type of Hood	CFM per linear foot of hood
Backshelf/pass-over	300
Double island canopy (per side)	300
Eyebrow	250
Wall-mounted canopy	300
Single island canopy	500
<u>Wall-mounted canopy</u>	<u>300</u>

For SI: 1 cfm per linear foot = 1.55 L/s per linear meter.

[507.13.4] 507.5.4 Light-duty cooking appliances. The minimum net airflow for hoods, as determined by Section [507.2] 507.1, used for ~~light-duty~~ light-duty cooking appliances and food service preparation shall be determined as follows:

Type of Hood	CFM per linear foot of hood
Backshelf/pass-over	250
Double island canopy (per side)	250
Eyebrow	250
Single island canopy	400
Wall-mounted canopy	200

For SI: 1 cfm per linear foot = 1.55 L/s per linear meter.

[507.13.5] 507.5.5 Dishwashing appliances. The minimum net airflow for Type II hoods used for dishwashing appliances shall be 100 ~~[CFM]~~ cfm per linear foot (155 L/s per linear meter) of hood length.

Exception: Dishwashing appliances and equipment installed in accordance with Section [507.2.2] 507.3.

~~**[507.14 Noncanopy size and location.** Noncanopy type hoods shall be located a maximum of 3 feet (914 mm) above the cooking surface. The edge of the hood shall be set back a maximum of 1 foot (305 mm) from the edge of the cooking surface.]~~

~~**[507.15 Exhaust outlets.** Exhaust outlets located within the hood shall be located so as to optimize the capture of particulate matter.]~~

[507.16] 507.6 Performance test. A performance test shall be conducted upon completion and witnessed by a representative of the Fire Department before final approval of the installation of a ventilation system serving commercial cooking appliances. The test shall verify the rate of exhaust airflow required by Section [507.13] 507.5, makeup airflow required by Section 508 and proper operation as specified in this chapter. The permit holder shall furnish the necessary test equipment and devices required to perform the tests.

SECTION MC 508 COMMERCIAL KITCHEN MAKEUP AIR

508.1 Makeup air. Makeup air shall be supplied during the operation of commercial kitchen exhaust systems that are provided for commercial cooking appliances. The amount of makeup air supplied to the building from all sources shall be approximately equal to the amount of exhaust air for all exhaust systems for the building. The makeup air shall not reduce the effectiveness of the exhaust system. Makeup air shall be provided by gravity or mechanical means or both. Mechanical makeup air systems shall be automatically controlled to start and operate simultaneously with the exhaust system. Makeup air intake opening locations shall comply with Section 401.4. Makeup air shall be provided in accordance with the *New York City Energy Conservation Code*.

508.1.1 Makeup air temperature. The temperature differential between makeup air delivered to the space and the air in the conditioned space shall not exceed 10°F (6°C) except where the ~~[added heating and cooling loads of the makeup air do not exceed the capacity of the HVAC system.]~~ makeup air contributes to satisfying the heating or cooling loads of the space and such temperature differential does not exceed 25°F (-38.9°C). The makeup air delivered to a compensating hood with front facing or side facing discharges shall be considered as being delivered to the space for the purposes of this section.

508.1.2 Air balance. Design plans for a commercial kitchen ventilation system shall include a schedule or diagram indicating the design air balance of the kitchen and all communicating spaces clearly indicating makeup, transfer, exhaust and infiltration air flow rates. Negative pressurization caused by the kitchen exhaust system shall not cause improper operation of systems in communicating spaces or cause door opening forces in the building to exceed the limits set forth in Chapter 10 of the *New York City Building Code*.

508.2 Compensating hoods. Manufacturers of compensating hoods shall provide a label indicating minimum exhaust flow and/or maximum makeup airflow that provides capture and containment of the exhaust effluent.

Exception: Compensating hoods with makeup air supplied only from the front face discharge and side face discharge openings shall not be required to be labeled with the maximum makeup airflow.

SECTION MC 509 FIRE SUPPRESSION SYSTEMS

509.1 Where required. Commercial cooking appliances required by Section ~~[507.2.4]~~ 507.2 to have a Type I hood shall be provided with an approved automatic fire suppression system complying with the *New York City Building Code* and the *New York City Fire Code*.

SECTION MC 510 HAZARDOUS EXHAUST SYSTEMS

510.1 General. This section shall govern the design and construction of duct systems for hazardous exhaust and shall determine where such systems are required. Hazardous exhaust systems are systems designed to capture and control hazardous emissions generated from product handling or processes,

and convey those emissions to the outdoors. Hazardous emissions include flammable vapors, gases, fumes, mists or dusts, and volatile or airborne materials posing a health hazard, such as toxic or corrosive materials. For the purposes of this section, the health-hazard rating of materials shall be as specified in NFPA 704.

For the purposes of the provisions of Section 510, a laboratory shall be defined as a building or portion thereof wherein chemicals or gases are used or synthesized on a nonproduction basis for testing, research, experimental, instructional or educational purposes.

510.2 Where required. A hazardous exhaust system shall be required wherever operations involving the handling or processing of hazardous materials, in the absence of such exhaust systems and under normal operating conditions, have the potential to create one of the following conditions:

1. A flammable vapor, gas, fume, mist or dust is present in concentrations exceeding 25 percent of the lower flammability limit of the substance for the expected room temperature.
2. A vapor, gas, fume, mist or dust with a health-hazard rating of 4 is present in any concentration.
3. A vapor, gas, fume, mist or dust with a health-hazard rating of 1, 2 or 3 is present in concentrations exceeding 1 percent of the median lethal concentration of the substance for acute inhalation toxicity.

Exception: Laboratories, as defined in Section 510.1, except where the concentrations listed in Item 1 are exceeded, or a vapor, gas, fume, mist or dust with a health-hazard rating of 1, 2, 3 or 4 is present in concentrations exceeding 1 percent of the median lethal concentration of the substance for acute inhalation toxicity.

510.2.1 Lumber yards and woodworking facilities. Equipment or machinery located inside buildings at lumber yards and woodworking facilities [~~which~~] that generates or emits combustible dust shall be provided with an approved dust-collection and exhaust system installed in accordance with this section and the *New York City Fire Code*. Equipment and systems that are used to collect, process or convey combustible dusts shall be provided with an approved explosion-control system.

510.2.2 Combustible fibers. Equipment or machinery within a building [~~which~~] that generates or emits combustible fibers shall be provided with an approved dust-collecting and exhaust system. Such systems shall comply with this code and the *New York City Fire Code*.

510.3 Design and operation. The design and operation of the exhaust system shall be such that flammable contaminants are diluted in noncontaminated air to maintain concentrations in the exhaust flow below 25 percent of the contaminant's lower flammability limit.

510.4 Independent system. Hazardous exhaust systems shall be independent of other types of exhaust systems.

510.5 Incompatible materials and common shafts. Incompatible materials, as defined in the *New York City Fire Code*, shall not be exhausted through the same hazardous exhaust system. Hazardous

exhaust systems shall not share common shafts with other duct systems, except where such systems are hazardous exhaust systems originating in the same fire area.

Exception: The provisions of this section shall not apply to laboratory exhaust systems where all of the following conditions apply:

1. All of the hazardous exhaust ductwork and other laboratory exhaust within both the occupied space and the shafts are under negative pressure while in operation.
2. The hazardous exhaust ductwork manifolded together within the occupied space must originate within the same fire area.
3. Hazardous exhaust ductwork originating in different fire areas and manifolded together in a common shaft shall use steel sub-ducts in accordance with Chapter 6.
- ~~[3.]~~ 4. Each control branch has a flow regulating device.
- ~~[4.]~~ 5. Perchloric acid hoods and connected exhaust shall be prohibited from manifolding.
- ~~[5.]~~ 6. Radioisotope hoods are equipped with filtration ~~[and/or]~~ , carbon beds, or both where required by the registered design professional.
- ~~[6.]~~ 7. Biological safety cabinets are filtered.
- ~~[7. Provision is made for continuous maintenance of negative static pressure in the ductwork.]~~

~~[Contaminated air shall not be recirculated to occupiable areas. Air containing explosive or flammable vapors, fumes or dusts; flammable, highly toxic or toxic gases; or radioactive material shall be considered to be contaminated.]~~

8. Each hazardous exhaust duct system shall be served by redundant exhaust fans that comply with either of the following:
 - 8.1. The fans shall operate simultaneously in parallel and each fan shall be individually capable of providing the required exhaust rate.
 - 8.2. Each of the redundant fans is controlled so as to operate when the other fan has failed or is shut down for servicing.

~~[510.5]~~ **510.6 Design.** Systems for removal of vapors, gases and smoke shall be designed by the constant velocity or equal friction methods. Systems conveying particulate matter shall be designed employing the constant velocity method.

~~[510.5.1]~~ **510.6.1 Balancing.** Systems conveying explosive or radioactive materials shall be prebalanced by duct sizing. Other systems shall be balanced by duct sizing with balancing devices, such as dampers. Dampers provided to balance air flow shall be provided with securely fixed minimum-position blocking devices to prevent restricting flow below the required volume or velocity.

[510.5.2] 510.6.2 Emission control. The design of the system shall be such that the emissions are confined to the area in which they are generated by air currents, hoods or enclosures and shall be exhausted by a duct system to a safe location or treated by removing contaminants.

[510.5.3] 510.6.3 Hoods required. Hoods or enclosures shall be used where contaminants originate in a limited area of a space. The design of the hood or enclosure shall be such that air currents created by the exhaust systems will capture the contaminants and transport them directly to the exhaust duct.

[510.5.4] 510.6.4 Contaminant capture and dilution. The velocity and circulation of air in work areas shall be such that contaminants are captured by an airstream at the area where the emissions are generated and conveyed into a product-conveying duct system. Contaminated air from work areas where hazardous contaminants are generated shall be diluted below the thresholds specified in Section 510.2 with air that does not contain other hazardous contaminants.

[510.5.5] 510.6.5 Makeup air. Makeup air shall be provided at a rate approximately equal to the rate that air is exhausted by the hazardous exhaust system. Makeup air intakes shall be located ~~so as to avoid recirculation of contaminated air~~ in accordance with Section 401.4.

[510.5.6] 510.6.6 Clearances. The minimum clearance between hoods and combustible construction shall be the clearance required by the duct system.

[510.5.7] 510.6.7 Ducts. Hazardous exhaust duct systems shall extend directly to the exterior of the building and shall not extend into or through ducts and plenums.

[510.6] 510.7 Penetrations. Penetrations of structural elements by a hazardous exhaust system shall conform to Sections ~~[510.6.1]~~ 510.7.1 through ~~[510.6.4]~~ 510.7.4.

Exception: Duct penetrations within Group H-5 occupancies as allowed by the *New York City Building Code*.

[510.6.1] 510.7.1 Fire dampers and smoke dampers. Fire dampers and smoke dampers are prohibited in hazardous exhaust ducts.

510.7.1.1 Shaft penetrations. Hazardous exhaust ducts that penetrate fire-resistance-rated shafts shall comply with Section 714.3.1 or 714.3.1.2 of the *New York City Building Code*.

[510.6.2] 510.7.2 Floors. Hazardous exhaust systems that penetrate a floor/ceiling assembly shall be enclosed in a fire-resistance-rated shaft constructed in accordance with the *New York City Building Code*.

[510.6.3] 510.7.3 Wall assemblies. Hazardous exhaust duct systems that penetrate fire-resistance-rated wall assemblies shall be enclosed in fire-resistance-rated construction from the point of penetration to the outlet terminal, except where the interior of the duct is equipped with an approved automatic fire suppression system. Ducts shall be enclosed in accordance with the *New York City Building Code* requirements for shaft construction and such enclosure shall have a minimum ~~[fire-resistance-rating]~~ fire-resistance rating of not less than the highest fire-resistance-rated wall assembly penetrated.

~~[510.6.4]~~ **510.7.4 Fire walls.** Ducts shall not penetrate a fire wall.

~~[510.7]~~ **510.8 Suppression required.** Ducts shall be protected with an approved automatic fire suppression system installed in accordance with the *New York City Building Code*.

Exceptions:

1. An approved automatic fire suppression system shall not be required in ducts conveying materials, fumes, mists and vapors that are nonflammable and noncombustible under all conditions and at any concentrations.
2. Automatic fire suppression systems shall not be required in metallic and noncombustible, nonmetallic exhaust ducts in semiconductor fabrication facilities.
- ~~[2.]~~ 3. An approved automatic fire suppression system shall not be required in ducts where the largest cross-sectional diameter of the duct is less than 10 inches (254 mm).
- ~~[3.]~~ 4. For laboratories, as defined in Section 510.1, approved automatic fire suppression systems shall not be required in laboratory hoods or exhaust systems

~~[510.8]~~ **510.9 Duct construction.** ~~[Ducts utilized to convey hazardous exhaust shall be constructed of approved G90 galvanized sheet steel, with a minimum nominal thickness as specified in Table 510.8. Nonmetallic ducts utilized in systems exhausting nonflammable corrosive fumes or vapors shall be listed and labeled. Nonmetallic ducts shall have a flame spread index of 25 or less and a smoke developed index of 50 or less, when tested in accordance with ASTM E 84 or UL 723. Ducts shall be approved for installation in such an exhaust system.]~~ Ducts used to convey hazardous exhaust shall be constructed of materials approved for installation in such an exhaust system and shall comply with one of the following:

1. Ducts shall be constructed of approved G90 galvanized sheet steel, with a minimum nominal thickness as specified in Table 510.9.
2. Ducts used in systems exhausting nonflammable corrosive fumes or vapors shall be constructed of nonmetallic materials that exhibit a flame spread index of 25 or less and a smoke-developed index of 50 or less when tested in accordance with ASTM E 84 or UL 723 and that are listed and labeled the application.

Where the products being exhausted are detrimental to the duct material, the ducts shall be constructed of alternative materials that are compatible with the exhaust.

~~[TABLE 510.8
MINIMUM DUCT THICKNESS]
TABLE ~~[510.8]~~ 510.9
MINIMUM DUCT THICKNESS~~

DIAMETER OF DUCT [Ø] OR MAXIMUM SIDE DIMENSION	MINIMUM NOMINAL THICKNESS		
	Nonabrasive materials	Nonabrasive/ [Abrasive] <u>abrasive materials</u>	Abrasive materials
0-8 inches	0.028 inch (No. 24 [Gage] <u>gage</u>)	0.034 inch (No. 22 [Gage] <u>gage</u>)	0.040 inch (No. 20 [Gage] <u>gage</u>)

**[TABLE 510.8
MINIMUM DUCT THICKNESS]
TABLE [510.8] 510.9
MINIMUM DUCT THICKNESS**

DIAMETER OF DUCT [Ø] OR MAXIMUM SIDE DIMENSION	MINIMUM NOMINAL THICKNESS		
	Nonabrasive materials	Nonabrasive/ [Abrasive] abrasive materials	Abrasive materials
9-18 inches	0.034 inch (No. 22 [Gage] gage)	0.040 inch (No. 20 [Gage] gage)	0.052 inch (No. 18 [Gage] gage)
19-30 inches	0.040 inch (No. 20 [Gage] gage)	0.052 inch (No. 18 [Gage] gage)	0.064 inch (No. 16 [Gage] gage)
Over 30 inches	0.052 inch (No. 18 [Gage] gage)	0.064 inch (No. 16 [Gage] gage)	0.079 inch (No. 14 [Gage] gage)

For SI: 1 inch = 25.4 mm.

[510.8.1] 510.9.1 Duct joints. Ducts shall be made tight with lap joints having a minimum lap of 1 inch ([25] 25.4 mm). Joints used in SMACNA/ANSI Round Industrial Duct Construction Standards and SMACNA/ANSI Rectangular Industrial Duct Construction Standards are also acceptable.

[510.8.2] 510.9.2 Clearance to combustibles. Ducts shall have a clearance to combustibles in accordance with Table [510.8.2] 510.9.2. Exhaust gases having temperatures in excess of 600°F (316°C) shall be exhausted to a chimney in accordance with Section 511.2.

**TABLE [510.8.2] 510.9.2
CLEARANCE TO COMBUSTIBLES**

TYPE OF EXHAUST OR TEMPERATURE OF EXHAUST (°F)	CLEARANCE TO COMBUSTIBLES (inches)
Less than 100	1
100-600	12
Flammable vapors	6

For SI: 1 inch = 25.4 mm, [°C = (°F) - 32] °C = ((°F) - 32)/1.8.

[510.8.3] 510.9.3 Explosion relief. Systems exhausting potentially explosive mixtures shall be protected with an approved explosion relief system or by an approved explosion prevention system designed and installed in accordance with NFPA 69. An explosion relief system shall be designed to minimize the structural and mechanical damage resulting from an explosion or deflagration within the exhaust system. An explosion prevention system shall be designed to prevent an explosion or deflagration from occurring.

[510.9] 510.10 Supports. Ducts shall be supported at intervals not exceeding 10 feet (3048 mm). Supports shall be constructed of noncombustible material.

SECTION MC 511 DUST, STOCK AND REFUSE CONVEYING SYSTEMS

511.1 Dust, stock and refuse conveying systems. Dust, stock and refuse conveying systems shall comply with the provisions of Section 510 and Sections 511.1.1 through 511.2.

511.1.1 Collectors and separators. Collectors and separators involving such systems as centrifugal separators, bag filter systems and similar devices, and associated supports shall be constructed of noncombustible materials and shall be located on the exterior of the building or structure. A collector or separator shall not be located nearer than 10 feet (3048 mm) to combustible construction or to an unprotected wall or floor opening, unless the collector is provided with a metal vent pipe that extends above the highest part of any roof within a distance of 30 feet (9144 mm).

Exceptions:

1. [~~Collectors~~] Where dust producing equipment requires an aggregate dust collection flowrate less than 1,500 ft³ per min (708 liters per second), collectors such as “Point of Use” collectors, close extraction weld fume collectors, spray finishing booths, stationary grinding tables, sanding booths, and integrated or machine-mounted collectors shall be permitted to be installed indoors provided the installation is in accordance with the *New York City Fire Code* and [~~NFPA 70~~] the *New York City Electrical Code*.
2. Collectors in independent exhaust systems handling combustible dusts shall be permitted to be installed indoors provided that such collectors are installed in compliance with the *New York City Fire Code* and [~~NFPA 70~~] the *New York City Electrical Code*.

511.1.2 Discharge pipe. Discharge piping shall conform to the requirements for ducts, including clearances required for high-heat appliances, as contained in this code. A delivery pipe from a centrifugal separator collector shall not convey refuse directly into the firebox of a boiler, furnace, dutch oven, refuse burner, incinerator or other appliance.

511.1.3 Conveying systems exhaust discharge. An exhaust system shall discharge to the outside of the building either directly by flue or indirectly through the [5] bin or vault into which the system discharges except where the contaminants have been removed. Exhaust system discharge shall be permitted to be recirculated provided that the solid particulate has been removed at a minimum efficiency of 99.9 percent at 10 microns (10.01 mm), vapor concentrations are less than 25 percent of the LFL, and approved equipment is used to monitor the vapor concentration.

511.1.4 Spark protection. The outlet of an open-air exhaust terminal shall be protected with an approved metal or other noncombustible screen to prevent the entry of sparks.

511.1.5 Explosion relief vents. A safety or explosion relief vent shall be provided on all systems that convey combustible refuse or stock of an explosive nature, in accordance with the requirements of the *New York City Building Code*.

511.1.5.1 Screens. Where a screen is installed in a safety relief vent, the screen shall be attached so as to permit ready release under the explosion pressure.

511.1.5.2 Hoods. The relief vent shall be provided with an approved noncombustible cowl or hood, or with a counterbalanced relief valve or cover arranged to prevent the escape of hazardous materials, gases or liquids.

511.2 Exhaust outlets. Outlets for exhaust that exceed 600°F (315°C) shall be designed as a chimney in accordance with Table 511.2.

**TABLE 511.2
CONSTRUCTION, CLEARANCE AND TERMINATION REQUIREMENTS FOR SINGLE-WALL METAL
DUST, STOCK AND REFUSE CONVEYING SYSTEMS**

SERVING TEMPERATURE RANGE	MINIMUM THICKNESS		TERMINATION				CLEARANCE			
	Walls (inch)	Lining	Above roof opening (feet)	Above any part of building within (feet)			Combustible construction (inches)		Noncombustible construction	
				10	25	50	Interior inst.	Exterior inst.	Interior inst.	Exterior inst.
High-heat appliances (Over 2,000°F) ^a	0.127 (No. 10 MSG)	4½" laid on 4½" bed	20	—	—	20	See Note c			
Low-heat appliances(1,000°F normal operation)	0.127 (No. 10 MSG)	None	3	2	—	—	18	6	Up to 18" diameter, 2" Over 18" diameter, 4"	
Medium-heat appliances (2,000°F maximum) ^b	0.127 (No. 10 MSG)	Up to 18" dia.— 2½" Over 18"— 4½" On 4½" bed	10	—	10	—	36	24	Up to 18" diameter, 2" Over 18" diameter, 4"	

For SI: 1 inch = 25.4 mm, 1 foot = 304.8 mm, °C = ((°F)-32)/1.8.

a. Lining shall extend from bottom to top of outlet.

b. Lining shall extend from 24 inches below connector to 24 feet above.

c. Clearance shall be as specified by the design engineer and shall have sufficient clearance from buildings and structures to avoid overheating combustible materials (maximum 160°F).

SECTION MC 512 SUBSLAB SOIL EXHAUST SYSTEMS

512.1 General. ~~[When]~~ Where a subslab soil exhaust system is provided, the duct shall conform to the requirements of this section.

512.2 Materials. Subslab soil exhaust system duct material shall be air duct material listed and labeled to the requirements of UL 181 for Class 0 air ducts, or any of the following piping materials that comply with the *New York City Plumbing Code* as building sanitary drainage and vent pipe: cast iron; galvanized steel; brass or copper pipe; copper tube of a weight not less than that of copper drainage tube, Type DWV; and plastic piping.

512.3 Grade. Exhaust system ducts shall not be trapped and shall have a minimum slope of one-eighth unit vertical in 12 units horizontal (1-percent slope).

512.4 Termination. Subslab soil exhaust system ducts shall extend through the roof and terminate ~~[at least]~~ not less than 6 inches (~~[152]~~ 152.4 mm) above the roof and ~~[at least]~~ not less than 10 feet (3048 mm) from any operable openings or air intake.

512.5 Identification. Subslab soil exhaust ducts shall be permanently identified within each floor level by means of a tag, stencil or other approved marking.

SECTION MC 513 SMOKE CONTROL SYSTEMS

513.1 Scope and purpose. This section applies to mechanical and passive smoke control systems that are required by the *New York City Building Code*. A smoke control system, where required, facilitates the evacuation of the occupants. Smoke control systems not required by the *New York City Building Code* shall not be installed unless approved by the Department. The purpose of this section is to establish minimum requirements for the design, installation and acceptance testing of smoke control systems that are intended to provide a tenable environment for the evacuation or relocation of occupants. These provisions are not intended for the preservation of contents, the timely restoration of operations, or for assistance in fire suppression or ~~[overhaul activities]~~ post-fire smoke purge. Smoke control systems regulated by this section serve a different purpose than the smoke and heat-venting provisions found in Section 910 of the *New York City Building Code*. Mechanical smoke control systems shall not be considered exhaust systems under Chapter 5.

513.2 General design requirements. ~~[Buildings, structures, or parts thereof required by this code to have a smoke control system or systems shall have such systems designed in accordance with the applicable requirements of Section 909 of the *New York City Building Code* and the generally accepted and well-established principles of engineering relevant to the design. The construction documents shall include sufficient information and detail to describe adequately the elements of the design necessary for the proper implementation of the smoke control systems. These documents shall be accompanied with sufficient information and analysis to demonstrate compliance with these provisions.]~~ Smoke control systems shall be designed and installed in accordance with Section 909 of the *New York City Building Code*.

~~**513.3 Special inspection and test requirements.** In addition to the ordinary inspection and test requirements which buildings, structures and parts thereof are required to undergo, smoke control systems subject to the provisions of Section 909 of the *New York City Building Code* shall undergo special inspections and tests sufficient to verify the proper commissioning of the smoke control design in its final installed condition. The design submission accompanying the construction documents shall clearly detail procedures and methods to be used and the items subject to such inspections and tests. Such commissioning shall be in accordance with generally accepted engineering practice and, where possible, based on published standards for the particular testing involved. The special inspections and tests required by this section shall be conducted under the same terms as found in Section 1704 of the *New York City Building Code*.]~~

~~**513.4 Analysis.** A rational analysis supporting the types of smoke control systems to be employed, their methods of operation, the systems supporting them, and the methods of construction to be utilized shall accompany the submitted construction documents and shall include, but not be limited to, the items indicated in Sections 513.4.1 through 513.4.6.]~~

~~**513.4.1 Stack effect.** The system shall be designed such that the maximum probable normal or reverse stack effects will not adversely interfere with the system's capabilities. In determining the maximum probable stack effects, altitude, elevation, weather history and interior temperatures shall be used.]~~

~~[513.4.2 Temperature effect of fire. Buoyancy and expansion caused by the design fire in accordance with Section 513.9 shall be analyzed. The system shall be designed such that these effects do not adversely interfere with its capabilities.]~~

~~[513.4.3 Wind effect. The design shall consider the adverse effects of wind. Such consideration shall be consistent with the wind loading provisions of the *New York City Building Code*.]~~

~~[513.4.4 HVAC systems. The design shall consider the effects of the heating, ventilating and air-conditioning (HVAC) systems on both smoke and fire transport. The analysis shall include all permutations of systems' status. The design shall consider the effects of fire on the HVAC systems.]~~

~~[513.4.5 Climate. The design shall consider the effects of low temperatures on systems, property and occupants. Air inlets and exhausts shall be located so as to prevent snow or ice blockage.]~~

~~[513.4.6 Duration of operation. All portions of active or passive smoke control systems shall be capable of continued operation after detection of the fire event for a period of not less than 20 minutes or 1.5 times the calculated egress time, whichever is more.]~~

~~[513.5 Smoke barrier construction. Smoke barriers shall comply with the *New York City Building Code*. Smoke barriers shall be constructed and sealed to limit leakage areas exclusive of protected openings. The maximum allowable leakage area shall be the aggregate area calculated using the following leakage area ratios:]~~

~~[1. Walls: $A/A_w = 0.00100$]~~

~~[2. Exit enclosures: $A/A_w = 0.00035$]~~

~~[3. All other shafts: $A/A_w = 0.00150$]~~

~~[4. Floors and roofs: $A/A_F = 0.00050$ where:]~~

~~[A = Total leakage area, square feet (m^2).]~~

~~[A_F = Unit floor or roof area of barrier, square feet (m^2).]~~

~~[A_w = Unit wall area of barrier, square feet (m^2).]~~

~~[The leakage area ratios shown do not include openings due to doors, operable windows or similar gaps. These shall be included in calculating the total leakage area.]~~

~~[513.5.1 Leakage area. Total leakage area of the barrier is the product of the smoke barrier gross area times the allowable leakage area ratio, plus the area of other openings such as gaps and operable windows. Compliance shall be determined by achieving the minimum air pressure difference across the barrier with the system in the smoke control mode for mechanical smoke control systems. Passive smoke control systems tested using other approved means such as door fan testing shall be as approved by the commissioner.]~~

~~[513.5.2 Opening protection. Openings in smoke barriers shall be protected by automatic-closing devices actuated by the required controls for the mechanical smoke control system. Door openings shall be protected by door assemblies complying with the requirements of the *New York City Building Code* for doors in smoke barriers.]~~

~~[Exceptions:]~~

- ~~[1. Passive smoke control systems with automatic-closing devices actuated by spot-type smoke detectors listed for releasing service installed in accordance with the *New York City Building Code*.]~~
- ~~[2. Fixed openings between smoke zones which are protected utilizing the airflow method.]~~
- ~~[3. In Group I-2 where such doors are installed across corridors, a pair of opposite-swinging doors without a center mullion shall be installed having vision panels with approved fire-rated glazing materials in approved fire-rated frames, the area of which shall not exceed that tested. The doors shall be close fitting within operational tolerances, and shall not have undercuts, louvers or grilles. The doors shall have head and jamb stops, astragals or rabbets at meeting edges and automatic-closing devices. Positive latching devices are not required.]~~
- ~~[4. Group I-3.]~~
- ~~[5. Openings between smoke zones with clear ceiling heights of 14 feet (4267 mm) or greater and bank down capacity of greater than 20 minutes as determined by the design fire size.]~~

~~[513.5.2.1 Ducts and air transfer openings. Ducts and air transfer openings are required to be protected with a minimum Class II, 250°F (121°C) smoke damper complying with the *New York City Building Code*.]~~

~~[513.6 Pressurization method. The primary mechanical means of controlling smoke shall be by pressure differences across smoke barriers. Maintenance of a tenable environment is not required in the smoke control zone of fire origin.]~~

~~[513.6.1 Minimum pressure difference. The minimum pressure difference across a smoke barrier shall be 0.05-inch water Gage (12.4 Pa) in fully sprinklered buildings. In buildings permitted to be other than fully sprinklered, the smoke control system shall be designed to achieve pressure differences at least two times the maximum calculated pressure difference produced by the design fire.]~~

~~[513.6.2 Maximum pressure difference. The maximum air pressure difference across a smoke barrier shall be determined by required door opening or closing forces. The actual force required to open exit doors when the system is in the smoke control mode shall be in accordance with the *New York City Building Code*. Opening and closing forces for other doors shall be determined by standard engineering methods for the resolution of forces and reactions. The calculated force to set a side-hinged, swinging door in motion shall be determined by:]~~

$$[F = F_{ae}K(WA\Delta P)/2(W - d)] \quad [(\text{Equation 5-2})]$$

[where:]

[A = Door area, square feet (m²).]

[d = Distance from door handles to latch edge of door feet (m).]

[F = Total door opening force, pounds (N).]

[F_{ae} = Force required to overcome closing device, pounds (N).]

[K = Coefficient 5.2 (1.0).]

[W = Door width, feet (m).]

[ΔP = Design pressure difference, inches (Pa) water gage.]

[513.7 Airflow design method. When approved by the commissioner, smoke migration through openings fixed in a permanently open position, which are located between smoke control zones by the use of the airflow method, shall be permitted. The design airflows shall be in accordance with this section. Airflow shall be directed to limit smoke migration from the fire zone. The geometry of openings shall be considered to prevent flow reversal from turbulent effects.]

[513.7.1 Velocity. The minimum average velocity through a fixed opening shall not be less than:]

$$[v = 217.2[h(T_f - T_o)/(T_f + 460)]^{1/2}] \quad [(\text{Equation 5-3})]$$

$$[\text{For SI: } v = 119.9[h(T_f - T_o)/T_f]^{1/2}]$$

[where:]

[H = Height of opening, feet (m).]

[T_f = Temperature of smoke, °F (K).]

[T_o = Temperature of ambient air, °F (K).]

[v = Air velocity, feet per minute (m/minute).]

[513.7.2 Prohibited conditions. This method shall not be employed where either the quantity of air or the velocity of the airflow will adversely affect other portions of the smoke control system, unduly intensify the fire, disrupt plume dynamics or interfere with exiting. In no case shall airflow toward the fire exceed 200 feet per minute (1.02 m/s). Where the formula in Section 513.7.1 requires airflow to exceed this limit, the airflow method shall not be used.]

[513.8 Exhaust method. When approved by the commissioner, mechanical smoke control for large enclosed volumes, such as in atriums or malls, shall be permitted to utilize the exhaust method. Smoke control systems using the exhaust method shall be designed in accordance with NFPA 92B.]

[513.8.1 Exhaust rate. The height of the lowest horizontal surface of the accumulating smoke layer shall be maintained at least 6 feet (1829 mm) above any walking surface which forms a portion of a required egress system within the smoke zone.]

~~[513.9 Design fire. The design fire shall be based on a rational analysis performed by the registered design professional and approved by the commissioner. The design fire shall be based on the analysis in accordance with Section 513.4 and this section.]~~

~~[513.9.1 Factors considered. The engineering analysis shall include the characteristics of the fuel, fuel load, effects included by the fire, and whether the fire is likely to be steady or unsteady.]~~

~~[513.9.2 Design fire fuel. Determination of the design fire shall include consideration of the type of fuel, fuel spacing and configuration.]~~

~~[513.9.3 Heat release assumptions. The analysis shall make use of the best available data from approved sources and shall not be based on excessively stringent limitations of combustible material.]~~

~~[513.9.4 Sprinkler effectiveness assumptions. A documented engineering analysis shall be provided for conditions that assume fire growth is halted at the time of sprinkler activation.]~~

~~[513.10 Equipment. Equipment such as, but not limited to, fans, ducts, automatic dampers and balance dampers shall be suitable for their intended use, suitable for the probable exposure temperatures that the rational analysis indicates, and as approved by the commissioner.]~~

~~[513.10.1 Exhaust fans. Components of exhaust fans shall be rated and certified by the manufacturer for the probable temperature rise to which the components will be exposed. This temperature rise shall be computed by:]~~

$$[T_s = (Q_e/mC) + (T_a)] \qquad \qquad \qquad \text{[(Equation 5-4)]}$$

[where:]

[C = Specific heat of smoke at smoke layer temperature, Btu/lb°F (kJ/kg × K).]

[m = Exhaust rate, pounds per second (kg/s).]

[Q_e = Convective heat output of fire, Btu/s (kW).]

[T_a = Ambient temperature, °F (K).]

[T_s = Smoke temperature, °F (K).]

~~[Exception: Reduced T_s as calculated based on assurance on inadequate dilution air.]~~

~~[513.10.2 Ducts. Duct materials and joints shall be capable of withstanding the probable temperatures and pressures to which they are exposed as determined in accordance with Section 513.10.1. Ducts shall be constructed and supported in accordance with Chapter 6. Ducts shall be leak tested to 1.5 times the maximum design operating pressure in accordance with nationally accepted practices. Measured leakage shall not exceed 5 percent of design flow. Results of such testing shall be a part of the documentation procedure. Ducts shall be supported directly from fire-resistance-rated structural elements of the building by substantial, noncombustible supports.]~~

~~[Exception: Flexible connections, for the purpose of vibration isolation, that are constructed of approved fire resistance-rated materials.]~~

~~[513.10.3 Equipment, inlets and outlets. Equipment shall be located so as to not expose uninvolved portions of the building to an additional fire hazard. Outdoor air inlets shall be located so as to minimize the potential for introducing smoke or flame into the building. Exhaust outlets shall be so located as to minimize reintroduction of smoke into the building and to limit exposure of the building or adjacent buildings to an additional fire hazard.]~~

~~[513.10.4 Automatic dampers. Automatic dampers, regardless of the purpose for which they are installed within the smoke control system, shall be listed and conform to the requirements of approved recognized standards.]~~

~~[513.10.5 Fans. In addition to other requirements, belt driven fans shall have 1.5 times the number of belts required for the design duty with the minimum number of belts being two. Fans shall be selected for stable performance based on normal temperature and, where applicable, elevated temperature. Calculations and manufacturer's fan curves shall be part of the documentation procedures. Fans shall be supported and restrained by noncombustible devices in accordance with the structural design requirements of the *New York City Building Code*. Motors driving fans shall not be operating beyond their nameplate horsepower (kilowatts) as determined from measurement of actual current draw. Motors driving fans shall have a minimum service factor of 1.15.]~~

~~[513.11 Power systems. The smoke control system shall be supplied with two sources of power. Primary power shall be the normal building power systems. Secondary power shall be from an approved standby power source complying with the *New York City Electrical Code*. The standby power source and its transfer switches shall be in a room separate from the normal power transformers and switch gear and ventilated directly to and from the exterior. The room shall be enclosed with not less than 2-hour fire resistance rated fire barriers constructed in accordance with Section 707 of the *New York City Building Code* or horizontal assemblies constructed in accordance with Section 712 of *New York City Building Code*, or both. Power distribution from the two sources shall be by independent routes. Transfer to full standby power shall be automatic and within 60 seconds of failure of the primary power. The systems shall comply with the *New York City Electrical Code*.]~~

~~[513.11.1 Power sources and power surges. Elements of the smoke management system relying on volatile memories or the like shall be supplied with integral uninterruptible power sources of sufficient duration to span 15-minute primary power interruption. Elements of the smoke management system susceptible to power surges shall be suitably protected by conditioners, suppressors or other approved means.]~~

~~[513.12 Detection and control systems. Fire detection systems providing control input or output signals to mechanical smoke control systems or elements thereof shall comply with the requirements of Chapter 9 of the *New York City Building Code* and NFPA 72. Such systems shall be equipped with a control unit complying with UL 864 and listed as smoke control equipment.]~~

~~[Control systems for mechanical smoke control systems shall include provisions for verification. Verification shall include positive confirmation of actuation, testing, manual override, the presence of power downstream of all disconnects and, through a preprogrammed weekly test sequence report abnormal conditions audibly, visually and by printed report.]~~

~~[513.12.1 Wiring. In addition to meeting the requirements of the *New York City Electrical Code*, all wiring, regardless of voltage, shall be fully enclosed within continuous raceways.]~~

~~[513.12.2 Activation. Smoke control systems shall be activated in accordance with the *New York City Building Code*.]~~

~~[513.12.3 Automatic control. Where completely automatic control is required or used, the automatic control sequences shall be initiated from an appropriately zoned automatic sprinkler system complying with Chapter 9 of the *New York City Building Code* or from manual controls that are readily accessible to the Fire Department, and any smoke detectors required by engineering analysis.]~~

~~[513.13 Control air tubing. Control air tubing shall be of sufficient size to meet the required response times. Tubing shall be flushed clean and dry prior to final connections. Tubing shall be adequately supported and protected from damage. Tubing passing through concrete or masonry shall be sleeved and protected from abrasion and electrolytic action.]~~

~~[513.13.1 Materials. Control air tubing shall be hard drawn copper, Type L, ACR in accordance with ASTM B 42, ASTM B 43, ASTM B 68, ASTM B 88, ASTM B 251 and ASTM B 280. Fittings shall be wrought copper or brass, solder type, in accordance with ASME B 16.18 or ASME B 16.22. Changes in direction shall be made with appropriate tool bends. Brass compression type fittings shall be used at final connection to devices; other joints shall be brazed using a BCuP 5 brazing alloy with solids above 1,100°F (593°C) and liquids below 1,500°F (816°C). Brazing flux shall be used on copper to brass joints only.]~~

~~[**Exception:** Nonmetallic tubing used within control panels and at the final connection to devices provided all of the following conditions are met:]~~

~~[1. Tubing shall be listed by an approved agency for flame and smoke characteristics.]~~

~~[2. Tubing and connected device shall be completely enclosed within a galvanized or paint grade steel enclosure having a minimum thickness of 0.0296 inch (0.7534 mm) (No. 22 gage). Entry to the enclosure shall be by copper tubing with a protective grommet of neoprene or or by suitable brass compression to male barbed adapter.]~~

~~[3. Tubing shall be identified by appropriately documented coding.]~~

~~[4. Tubing shall be neatly tied and supported within the enclosure. Tubing bridging cabinets and doors or moveable devices shall be of sufficient length to avoid tension and excessive stress. Tubing shall be protected against abrasion. Tubing serving devices on doors shall be fastened along hinges.]~~

~~[513.13.2 Isolation from other functions. Control tubing serving other than smoke control functions shall be isolated by automatic isolation valves or shall be an independent system.]~~

~~[513.13.3 Testing. Test control air tubing at three times the operating pressure for not less than 30 minutes without any noticeable loss in gauge pressure prior to final connection to devices.]~~

~~[513.14 Marking and identification. The detection and control systems shall be clearly marked at all junctions, accesses and terminations.]~~

~~[513.15 Control diagrams. Identical control diagrams shall be provided and maintained as required by the *New York City Fire Code*.]~~

~~[513.16 Fire fighter's smoke control panel. A fire fighter's smoke control panel for Fire Department emergency response purposes only shall be provided in accordance with the *New York City Fire Code*.]~~

~~[513.17 System response time. Smoke control system activation shall comply with the *New York City Fire Code*.]~~

~~[513.18 Acceptance testing. Devices, equipment, components and sequences shall be tested in accordance with the *New York City Fire Code*.]~~

~~[513.19 System acceptance. Acceptance of the smoke control system shall be in accordance with the *New York City Fire Code*.]~~

SECTION MC 514 ENERGY RECOVERY VENTILATION SYSTEMS

514.1 General. Energy recovery ventilation systems shall be installed in accordance with this section. Where required for purposes of energy conservation, energy recovery ventilation systems shall ~~[also]~~ comply with the *New York City Energy Conservation Code*. Ducted heat recovery ventilators shall be listed and labeled in accordance with UL 1812. Nonducted heat recovery ventilators shall be listed and labeled in accordance with UL 1815.

514.2 Prohibited applications. ~~[Energy]~~ Unless specifically designed or listed for the specific applications and as part of an engineered system, energy recovery ventilation systems shall not be used in the following systems ~~[, unless specifically designed and/or listed for the specific applications and as part of an engineered system.]:~~

1. Hazardous exhaust systems covered in Section 510.
2. Dust, stock and refuse systems that convey explosive or flammable vapors, fumes or dust.
3. Smoke control systems covered in Section 513.
4. Commercial kitchen exhaust systems serving Type I ~~[and]~~ or Type II hoods.
5. Clothes dryer exhaust systems covered in Section 504.

Exception: The application of energy recovery ventilation equipment that recovers sensible heat only utilizing coil-type heat exchangers shall not be limited by this section.

514.3 Access. A means of access shall be provided to the heat exchanger and other components of the system as required for service, maintenance, repair or replacement.

514.4 Recirculated air. Class 1 or Class 2 air as described in ASHRAE 62.1 that is conveyed within energy recovery systems shall not be considered as recirculated air where the energy recovery ventilation system is constructed to limit cross-leakage between air streams to less than 10 percent of the total airflow design capacity.

514.5 Combined system allowed. Environmental exhaust air and toilet exhaust may be combined in any occupancy downstream of all air inlets of the system provided that such exhaust cannot be recirculated. In Group R occupancies, exhaust from domestic kitchens and toilets/baths from one or more dwelling or sleeping units may be combined at a point downstream of all air inlets of the system.

SECTION MC 515 POSTFIRE SMOKE PURGE SYSTEMS

515.1 General. Postfire smoke purge systems shall be provided as required by Chapter 9 of the *New York City Building Code*.

SECTION MC 515 POSTFIRE SMOKE PURGE SYSTEMS

515.1 General. Postfire smoke purge systems shall be provided as required by Chapter 9 of the *New York City Building Code*.

§ 7. Chapter 6 of the New York city mechanical code, as amended by local law number 141 for the year 2013, is amended to read as follows:

CHAPTER 6 DUCT SYSTEMS

SECTION MC 601 GENERAL

601.1 Scope. Duct systems used for the movement of air in air-conditioning, heating, ventilating and exhaust systems shall conform to the provisions of this chapter except as otherwise specified in Chapters 5 and 7.

Exception: Ducts discharging combustible material directly into any combustion chamber shall conform to the requirements of NFPA 82.

601.2 Air movement in corridors. Corridors shall not be used as a portion of direct supply, return, or exhaust air system serving adjoining areas. Air transfer opening(s) shall not be permitted in walls or in doors separating public corridors from adjoining areas.

Exceptions:

1. Where located within dwelling units, the use of corridors for conveying return air shall not be prohibited.

2. Where located within tenant spaces of 1,000 square feet (93 m²) or less in area, the use of corridors for conveying return air is permitted. [-]
3. Corridors in Group B office buildings equipped throughout with an automatic sprinkler system in accordance with Section 903.3.1.1 of the *New York City Building Code*.
4. Incidental air movement from pressurized rooms within health care facilities, provided that the corridor is not the primary source of supply or return to the room.
5. Air transfer openings serving toilet rooms, bathrooms, shower rooms, sink closets, and similar auxiliary spaces opening onto the public corridor.
6. Group I-3 detention and correctional occupancies with corridor separations of open construction (e.g., grating doors or grating partitions).
7. Air transfer in openings because of pressure differential in Group I-2 health care occupancies from corridors is permitted.
8. Where door clearances do not exceed those specified for fire doors in the *New York City Building Code*, air transfer caused by pressure differentials shall be permitted.
9. Use of egress corridors as part of an engineered smoke-control system is permitted.

601.2.1 Corridor ceiling. Use of the space between the corridor ceiling and the floor or roof structure above as a return air plenum is permitted for one or more of the following conditions:

1. The corridor is not required to be of fire-resistance-rated construction [;].
2. The corridor is separated from the plenum by fire-resistance-rated construction [;].
3. The air-handling system serving the corridor is shut down upon activation of the air-handling unit smoke detectors required by this code [;].
4. The air-handling system serving the corridor is shut down upon detection of sprinkler waterflow where the building is equipped throughout with an automatic sprinkler system [~~;~~].
5. The space between the corridor ceiling and the floor or roof structure above the corridor is used as a component of an approved engineered smoke control system.

601.3 Exits. Equipment and ductwork for exit enclosure ventilation shall comply with one of the following items:

1. Such equipment and ductwork shall be located exterior to the building and shall be directly connected to the exit enclosure by ductwork enclosed in construction as required by the *New York City Building Code* for shafts.
2. Where such equipment and ductwork is located within the exit enclosure, the intake air shall be taken directly from the outdoors and the exhaust air shall be discharged directly to the

outdoors, or such air shall be conveyed through ducts enclosed in construction as required by the *New York City Building Code* for shafts.

3. Where located within the building, such equipment and ductwork shall be separated from the remainder of the building, including other mechanical equipment, with construction as required by the *New York City Building Code* for shafts.

In each case, openings into fire-resistance-rated construction shall be limited to those needed for maintenance and operation and shall be protected by self-closing fire-resistance-rated devices in accordance with the *New York City Building Code* for enclosure wall opening protectives. Exit enclosure ventilation systems shall be independent of other building ventilation systems.

601.4 Contamination prevention. Exhaust ducts under positive pressure, chimneys [7] and vents shall not extend into or pass through ducts or plenums.

Exceptions:

1. Exhaust systems conveying Class 1 or Class 2 air in accordance with ASHRAE 62.1, located in return air plenums and that have exhaust duct joints, seams and connections that comply with Section 603.9 without taking any exceptions. Such exhaust system and plenum shall be subject to special inspection in accordance with Section 1705.39 of the *New York City Building Code* and shall be subject to periodic inspection in accordance with Section 602.6 of this code.
2. This section shall not apply to chimneys and vents for appliances with a heat input not greater than 350,000 Btu/hr (103 kW) that pass through plenums provided that such venting systems are subject to special inspection in accordance with Section 1705.39 of the *New York City Building Code* and shall be subject to periodic inspection in accordance with Section 602.6 of this code and comply with one of the following requirements:
 - 2.1. The venting system shall be listed for positive pressure applications and shall be sealed in accordance with the vent manufacturer's instructions.
 - 2.2. The venting system shall be installed such that fittings and joints between sections are not installed in the above ceiling space.
 - 2.3. The venting system shall be installed in a conduit or enclosure with sealed joints separating the interior of the conduit or enclosure from the ceiling space.

**SECTION MC 602
PLENUMS**

602.1 General. Supply, return, exhaust, relief and ventilation air plenums shall be limited to uninhabited crawl spaces, areas above a finished ceiling or below the finished floor, attic spaces and mechanical equipment rooms. Plenums shall be limited to one fire area. Air systems shall be fully ducted from the boundary of the fire area served to the air-handling equipment or associated mechanical room serving as a return air plenum. Fuel-fired appliances shall not be installed within a plenum.

Exception: In a fully sprinklered building, return air plenums may be separated by combination fire smoke dampers and a fully ducted return is not required. The requirements of Section 601.2.1 shall apply.

602.2 Construction. ~~Plenum [enclosures shall be constructed of material permitted for the type of construction classification of the building]~~ enclosure construction materials that are exposed to the airflow shall comply with the requirements of Section 703.5 of the *New York City Building Code* or such materials shall have a flame spread index of not more than 25 and a smoke-developed index of not more than 50 when tested in accordance with ASTM E 84 or UL 723. The temperature of air delivered to or through these plenums shall not exceed 250°F ([+24] 121.1°C), except where used as part of an engineered smoke control system.

The use of gypsum boards to form plenums shall be limited to systems where the air temperatures do not exceed 125°F ([52] 51.7°C) and the building and mechanical system design conditions are such that the gypsum board surface temperature will be maintained above the ~~[air stream]~~ airstream dew-point temperature. Air plenums formed by gypsum boards shall not be incorporated in air-handling systems utilizing evaporative coolers.

602.2.1 Materials within plenums. Except as required by Sections 602.2.1.1 through ~~[602.2.1.6]~~ 602.2.1.7, materials within plenums shall be noncombustible or shall ~~[have]~~ be listed and labeled as having a flame spread index of not more than 25 and a smoke-developed index of not more than 50 when tested in accordance with ASTM E 84 or UL 723.

Exceptions:

1. Rigid and flexible ducts and connectors shall conform to Section 603.
2. Duct coverings, linings, tape and connectors shall conform to Sections 603 and 604.
3. ~~[Materials]~~ This section shall not apply to materials exposed within plenums in one- and two-family dwellings.
4. ~~[Smoke]~~ This section shall not apply to smoke detectors.
5. Combustible materials fully enclosed ~~[in continuous]~~ within one of the following:
 - 5.1. Continuous noncombustible ~~[(+)]~~ raceways or enclosures ~~[-]~~.
 - 5.2. Approved gypsum ~~[(ii) approved gypsum]~~ board assemblies.
 - 5.3. Materials ~~[or (iii) materials]~~ listed and labeled for ~~[such application]~~ installation within a plenum.
6. Materials in Group H-5 fabrication areas and the areas above and below the fabrication area that share a common air recirculation path with the fabrication area.

602.2.1.1 Wiring. Combustible electrical [~~or electronic wiring methods and materials,~~] wires and cables and optical fiber [cable, and optical fiber raceway] cables exposed within a plenum shall [~~have a~~] be listed as having a maximum peak optical density [not greater than] of 0.50 or less, an average optical density [not greater than] of 0.15 or less, and a maximum flame spread [not greater than] distance of 5 feet (1524 mm) or less when tested in accordance with NFPA 262 or shall be installed in metal raceways or metal sheathed cable. Combustible optical fiber and communication raceways exposed within a plenum shall be listed as having a maximum peak optical density of 0.5 or less, an average optical density of 0.15 or less, and a maximum flame spread distance of 5 feet (1524 mm) or less when tested in accordance with UL 2024. Only [~~type OFNP (plenum rated)~~] plenum-rated [nonconductive optical fiber cable] wires and cables shall be installed in plenum-rated raceways. Electrical wires and cables, optical fiber [raceways. Wiring, cable,] cables and raceways addressed in this section shall be listed and labeled [~~as plenum-rated~~] and shall be installed in accordance with *New York City Electrical Code.*

602.2.1.2 Fire sprinkler piping. Plastic fire sprinkler piping exposed within a plenum shall be used only in wet pipe systems and shall have a peak optical density [~~not greater than~~] of 0.50 or less, an average optical density [not greater than] of 0.15 or less, and a flame spread of [not greater than] 5 feet (1524 mm) or less when tested in accordance with UL 1887. Piping shall be listed and labeled.

602.2.1.3 Pneumatic tubing. Combustible pneumatic tubing exposed within a plenum shall have a peak optical density [~~not greater than~~] of 0.50 or less, an average optical density [not greater than] of 0.15 or less, and a flame spread of [not greater than] 5 feet (1524 mm) or less when tested in accordance with UL 1820. Combustible pneumatic tubing shall be listed and labeled.

602.2.1.4 Electrical equipment in plenums. Electrical equipment exposed within a plenum shall comply with Sections 602.2.1.4.1 and 602.2.1.4.2.

602.2.1.4.1 Equipment in metallic enclosures. Electrical equipment with metallic enclosures exposed within a plenum shall be permitted.

602.2.1.4.2 Equipment in combustible enclosures. Electrical equipment with combustible enclosures exposed within a plenum shall be listed and labeled for such use in accordance with UL 2043.

602.2.1.5 Discrete plumbing and mechanical products in plenums. Where discrete plumbing and mechanical products and appurtenances are located in a plenum and have exposed combustible material, they shall be listed and labeled for such use in accordance with UL 2043.

602.2.1.6 Foam plastic insulation. Foam plastic insulation used in plenums as interior wall or ceiling finish [in plenums] or as interior trim shall exhibit a flame spread index of 75 or less and a [~~smoke developed~~] smoke-developed index of 450 or less when tested in accordance with ASTM E 84 or UL 723 and shall also comply with [~~Section~~] one or more of Sections [602.2.1.5.1] 602.2.1.6.1, [602.2.1.5.2] 602.2.1.6.2 [or] and [602.2.1.5.3] 602.2.1.6.3.

~~[602.2.1.5.1]~~ **602.2.1.6.1 Separation required.** The foam plastic insulation shall be separated from the plenum by a thermal barrier complying with Section 2603.4 of the *New York City Building Code* and shall exhibit a flame spread index of 75 or less and a smoke-developed index of 450 or less when tested in accordance with ASTM E 84 or UL 723 at the thickness and density intended for use.

~~[602.2.1.5.2]~~ **602.2.1.6.2 Approval.** The foam plastic insulation shall exhibit a flame spread index of 25 or less and a smoke-developed index of 50 or less when tested in accordance with ASTM E 84 or UL 723 at the thickness and density intended for use and shall meet the acceptance criteria of Section 803.1.2 of the *New York City Building Code* when tested in accordance with NFPA 286.

The foam plastic insulation shall be approved based on tests conducted in accordance with Section 2603.9 of the *New York City Building Code*.

~~[602.2.1.5.3]~~ **602.2.1.6.3 Covering.** The foam plastic insulation shall be covered by corrosion-resistant steel having a base metal thickness of not less than 0.0160 inch (0.4 mm) and shall exhibit a flame spread index of 75 or less and a smoke-developed index of 450 or less when tested in accordance with ASTM E 84 or UL 723 at the thickness and density intended for use.

~~[602.2.1.6 Semiconductor fabrication areas. Group H, Division 5 fabrication areas and the areas above and below the fabrication area that share a common air recirculation path with the fabrication area shall not be subject to the provisions of Section 602.2.1.]~~

602.2.1.7 Plastic pipe and tube. Plastic piping and tubing shall be listed and shall exhibit a flame spread index of not more than 25 and a smoke-developed index of not more than 50 when tested in accordance with ASTM E 84 or UL 723.

602.3 Stud cavity and joist space plenums. Stud wall cavities and the spaces between solid floor joists to be utilized as air plenums shall comply with the following conditions:

1. Such cavities or spaces shall not be utilized as a plenum for supply air.
2. Such cavities or spaces shall not be part of a required fire-resistance-rated assembly.
3. Stud wall cavities shall not convey air from more than one floor level.
4. Stud wall cavities and joist space plenums shall comply with the floor penetration protection requirements of the *New York City Building Code*.
5. Stud wall cavities and joist space plenums shall be isolated from adjacent concealed spaces by approved fireblocking as required in the *New York City Building Code*.
6. Stud wall cavities in the outside walls of building envelope assemblies shall not be utilized as air plenums.

602.4 Flood hazard. For structures located in [~~areas of special~~] flood hazard areas, plenum spaces shall comply with the additional requirements of Appendix G of the *New York City Building Code*.

602.5 Firestopping. Where required by the *New York City Building Code*, through penetrations shall be firestopped in accordance with Section [713] 714 of the *New York City Building Code*.

602.6 ~~[Materials. Materials used in the construction of a plenum shall be suitable for continuous exposure to the temperature and humidity conditions of the environmental air in the plenum.]~~
Periodic inspections to prevent contamination of mechanical systems. Covered buildings, as described in Section 28-325.1 of the *New York City Administrative Code*, shall be subject to periodic inspections to prevent contamination of mechanical systems in accordance with Section 28-325.2 of the *New York City Administrative Code*.

**SECTION MC 603
 DUCT CONSTRUCTION AND INSTALLATION**

603.1 General. An air distribution system shall be designed and installed to supply the required distribution of air. The installation of an air distribution system shall not affect the fire protection requirements specified in the *New York City Building Code*. Ducts shall be constructed, braced, reinforced and installed to provide structural strength and durability.

603.2 Duct sizing. Ducts installed within a single dwelling unit shall be sized in accordance with ACCA Manual D, the appliance manufacturer’s instructions or other approved methods. Ducts installed within all other buildings shall be sized in accordance with the ASHRAE Handbook of Fundamentals or other equivalent computation procedure.

603.3 Duct classification. Ducts shall be classified based on the maximum operating pressure of the duct at pressures of positive or negative 0.5, 1.0, 2.0, 3.0, 4.0, 6.0 or 10.0 inches (1 inch w.c. = 248.7 Pa) of water column. The pressure classification of ducts shall equal or exceed the design pressure of the air distribution in which the ducts are utilized.

603.4 Metallic ducts. ~~[All metallic]~~ Metallic ducts shall be constructed as specified in the ~~[SMACNA]~~ SMACNA /ANSI HVAC Duct Construction Standards—Metal and Flexible.

Exception: Ducts installed within single dwelling units shall have a minimum thickness as specified in Table 603.4.

~~[TABLE 603.4
 DUCT CONSTRUCTION MINIMUM SHEET METAL THICKNESSES
 FOR SINGLE DWELLING UNITS~~

DUCT SIZE	GALVANIZED		ALUMINUM MINIMUM THICKNESS (inches)
	Minimum thickness (inches)	Equivalent Galvanized Gage No.	
Round ducts and enclosed Rectangular ducts			

**[TABLE 603.4
DUCT CONSTRUCTION MINIMUM SHEET METAL THICKNESSES
FOR SINGLE DWELLING UNITS**

DUCT SIZE	GALVANIZED		ALUMINUM MINIMUM THICKNESS (inches)
	Minimum thickness (inches)	Equivalent Galvanized Gage No.	
14 inches or less	0.0157	28	0.0175
16 and 18 inches	0.0187	26	0.018
20 inches or over	0.0236	24	0.023
Exposed rectangular ducts			
14 inches or less	0.0157	28	0.0175
14 inches ^a	0.0187	26	0.018

For SI: 1 inch = 25.4 mm. 1 inch water gage = 249 Pa.

a. For duct gages and reinforcements at static pressure of 1/2 inch, 1 inch and 2 inch w.g. SMACNA HVAC Duct Construction Standards, Tables 2-1, 2-2 and 2-3, shall apply.]

TABLE 603.4**DUCT CONSTRUCTION MINIMUM SHEET METAL THICKNESS FOR SINGLE DWELLING UNITS^a**

ROUND DUCT DIAMETER (inches)	STATIC PRESSURE			
	½-inch water gage		1-inch water gage	
	Thickness (inches)		Thickness (inches)	
	Galvanized	Aluminum	Galvanized	Aluminum
<u>< 12</u>	<u>0.013</u>	<u>0.018</u>	<u>0.013</u>	<u>0.018</u>
<u>12 to 14</u>	<u>0.013</u>	<u>0.018</u>	<u>0.016</u>	<u>0.023</u>
<u>15 to 17</u>	<u>0.016</u>	<u>0.023</u>	<u>0.019</u>	<u>0.027</u>
<u>18</u>	<u>0.016</u>	<u>0.023</u>	<u>0.024</u>	<u>0.034</u>
<u>19 to 20</u>	<u>0.019</u>	<u>0.027</u>	<u>0.024</u>	<u>0.034</u>
RECTANGULAR DUCT DIMENSION (inches)	STATIC PRESSURE			
	½-inch water gage		1-inch water gage	
	Thickness (inches)		Thickness (inches)	
	Galvanized	Aluminum	Galvanized	Aluminum
<u>≤ 8</u>	<u>0.013</u>	<u>0.018</u>	<u>0.013</u>	<u>0.018</u>
<u>9 to 10</u>	<u>0.013</u>	<u>0.018</u>	<u>0.016</u>	<u>0.023</u>
<u>11 to 12</u>	<u>0.016</u>	<u>0.023</u>	<u>0.019</u>	<u>0.027</u>
<u>13 to 16</u>	<u>0.019</u>	<u>0.027</u>	<u>0.019</u>	<u>0.027</u>
<u>17 to 18</u>	<u>0.019</u>	<u>0.027</u>	<u>0.024</u>	<u>0.034</u>
<u>19 to 20</u>	<u>0.024</u>	<u>0.034</u>	<u>0.024</u>	<u>0.034</u>

For SI: 1 inch = 25.4 mm, 1-inch water gage = 249 Pa.

a. Ductwork that exceeds 20 inches by dimension or exceeds a pressure of 1-inch water gage shall be constructed in accordance with SMACNA/ANSI HVAC Duct Construction Standards—Metal and Flexible.

603.4.1 Minimum fasteners. Round metallic ducts shall be mechanically fastened by means of [at least] not less than three sheet metal screws or rivets spaced equally around the joint.

Exception: Where a duct connection is made that is partially inaccessible, three screws or rivets shall be equally spaced on the exposed portion so as to prevent a hinge effect.

603.4.2 Duct lap. Crimp joints for round and oval metal ducts shall be lapped not less than 1 inch (25.4 mm) and the male end of the duct shall extend into the adjoining duct in the direction of airflow.

603.5 Nonmetallic ducts. Nonmetallic ducts shall be constructed with Class 0 or Class 1 duct material [~~in accordance~~] and shall comply with UL 181. Fibrous duct construction shall conform to the [~~SMACNA~~] SMACNA /ANSI Fibrous Glass Duct Construction Standards or NAIMA Fibrous Glass Duct Construction Standards. The [~~maximum~~] air temperature within nonmetallic ducts shall not exceed 250°F ([~~124~~] 121.1°C).

603.6 Air ducts and air connectors. Air ducts, both metallic and nonmetallic, shall comply with Section 603.6.1. Air connectors, both metallic and nonmetallic, shall comply with Sections [~~606.6.2~~] 603.6.2 and 603.6.3.

603.6.1 Air ducts. Air ducts shall be permitted to be rigid or flexible and shall be constructed of materials that are reinforced and sealed to satisfy the requirements for the use of the air duct system, such as the supply air system, the return or exhaust air system, and the variable volume/pressure air system.

603.6.1.1 Materials. All air duct materials shall be suitable for continuous exposure to the temperature and humidity conditions of the environmental air in the air duct. Air ducts shall be constructed of any of the following materials:

1. Iron, steel, aluminum, copper, concrete, masonry or clay tile.
2. Class 0 or Class 1 rigid or flexible air ducts tested in accordance with UL 181 and installed in conformance with the conditions of the listing.

Exceptions:

1. Class 0 or Class 1 rigid or flexible air duct shall not be used as a vertical air duct that is more than two stories in height.
2. Class 0 or Class 1 rigid or flexible air ducts shall not be used for air ducts containing air at temperatures in excess of 250°F ([~~124~~] 121.1°C).
3. Where the temperature of the conveyed air does not exceed 125°F ([~~52~~] 51.7°C) in normal service, negative pressure exhaust or return air ducts shall be permitted to be constructed of gypsum board having a maximum flame spread index/rating of 25 without evidence of continued progressive combustion and a maximum [~~smoke-developed~~] smoke-developed index/rating of 50. Air ducts formed by gypsum boards shall have a surface temperature maintained above the [~~air-stream~~] airstream dew-point temperature, and shall not be used in air-handling systems utilizing evaporative coolers.

Exception: The maximum conveyed air temperature of 125°F ([~~52~~] 51.7°C) shall not apply to gypsum board material used for post-fire smoke purge.

603.6.1.2 Installation. The materials, thickness, construction, and installation of ducts shall provide structural strength and durability in conformance with recognized good practice. Air ducts shall be considered to be in compliance with this requirement where constructed and installed in accordance with the *New York City Building Code*. Where no standard exists for the construction of air ducts, they shall be constructed to withstand both the positive and negative pressures of the system.

603.6.2 Air connectors. Air connectors are limited-use, flexible air ducts that are required to conform to other provisions applicable to air ducts and shall meet the following requirements:

1. Air connectors shall conform to the requirements for Class 0 or Class 1 connectors when tested and approved in accordance with UL 181.
2. Class 0 or Class 1 air connectors shall not be used for ducts containing air at temperatures in excess of 250°F (~~[+24]~~ 121.1°C).
3. Air connector runs shall not exceed 14 feet (~~[4267]~~ 4267.2 mm) in length.
4. Air connectors shall not penetrate any rated wall, partition, or shaft that is required to have a [~~fire-resistance~~] fire-resistance rating of 1 hour or more.
5. Air connectors shall not pass through floors.

603.6.3 Flexible air duct and air connector clearance. Flexible air ducts and air connectors shall be installed with a minimum clearance to an appliance as specified in the appliance manufacturer's [~~installation~~] instructions.

603.7 Rigid duct penetrations. Duct system penetrations of walls, floors, ceilings and roofs and air transfer openings in such building components shall be protected as required by Section 607. Ducts in a private garage [~~and ducts penetrating the walls~~] that penetrate a wall or [ceilings separating] ceiling that separates a dwelling from a private garage shall be continuous [~~and~~], shall be constructed of [a minimum 26 gage] sheet steel having a thickness of not less than 0.0187 inch (0.4712 mm) [~~galvanized sheet metal~~] (No. 26 gage) and shall not have openings into the garage. Fire and smoke dampers are not required in such ducts passing through the wall or ceiling separating a dwelling from a private garage except where required by Chapter 7 of the *New York City Building Code*.

603.8 Underground ducts. Ducts shall be approved for underground installation. Metallic ducts not having an approved protective coating shall be completely encased in [~~a minimum of~~] not less than 2 inches (~~[54]~~ 50.8 mm) of concrete.

603.8.1 Slope. Ducts shall have a minimum slope of 1/8 inch per foot (10.4 mm/m) to allow drainage to a point provided with access.

603.8.2 Sealing. Ducts shall be sealed and secured prior to pouring the concrete encasement.

603.8.3 Plastic ducts and fittings. Plastic ducts shall be constructed of PVC having a minimum pipe stiffness of 8 psi (~~[55]~~ 55.1 kPa) at [~~5 percent~~] 5-percent deflection when tested in accordance with ASTM D 2412. Plastic duct fittings shall be constructed of either PVC or high-density polyethylene. Plastic duct and fittings shall be utilized in underground installations only. The

maximum design temperature for systems utilizing plastic duct and fittings shall be 150°F ([66]65.6°C).

603.9 Joints, seams and connections. All longitudinal and transverse joints, seams and connections in metallic and nonmetallic ducts shall be constructed as specified in [~~SMACNA~~] SMACNA/ANSI HVAC Duct Construction Standards—Metal and Flexible and NAIMA Fibrous Glass Duct Construction Standards. All joints [~~;~~ and] ~~;~~ longitudinal and transverse seams and connections in ductwork shall be securely fastened and sealed with [~~the New York City Energy Conservation Code~~] welds, gaskets, mastics (adhesives), mastic-plus-embedded-fabric systems, liquid sealants or tapes. [~~Closure systems~~] Tapes and mastics used to seal fibrous glass ductwork shall be listed and labeled in accordance with UL 181A and shall be marked “181 A-P” for pressure-sensitive tape, “181 A-M” for mastic or “181 A-H” for heat-sensitive tape. [~~Closure systems~~] Tapes and mastics used to seal metallic and flexible air ducts and flexible air connectors shall comply with UL 181B and shall be marked “181 B-FX” for pressure-sensitive tape or “181 B-M” for mastic. Duct connections to flanges of air distribution system equipment shall be sealed and mechanically fastened. Mechanical fasteners for use with flexible nonmetallic air ducts shall comply with UL 181B and shall be marked “181 B-C.” Closure systems used to seal [~~metal~~] all ductwork shall be installed in accordance with the manufacturer’s [~~installation~~] instructions. [~~Unlisted duct tape is not permitted as a sealant on any metal ducts.~~]

Exception: [~~Continuously welded and locking type longitudinal joints and seams in~~] For ducts [~~operating at~~] having a static [~~pressures~~] pressure classification of less than 2 inch w.c. ([500] 497.7 Pa) [~~pressure classification shall not require~~] , additional closure systems shall not be required for continuously welded joints and seams and locking-type joints and seams of other than the snap-lock and buttonlock types.

603.10 Supports. Ducts shall be supported [~~with approved hangers at intervals not exceeding 10 feet (3048 mm) or by other approved duct support systems designed~~] in accordance with [~~the New York City Building Code~~] SMACNA/ANSI HVAC Duct Construction Standards—Metal and Flexible. Flexible and other factory-made ducts shall be supported in accordance with the manufacturer’s [~~installation~~] instructions. Ducts shall not be hung from or supported by suspended ceilings.

603.11 Furnace connections. Ducts connecting to a furnace shall have a clearance to combustibles in accordance with the furnace manufacturer’s [~~installation~~] instructions.

603.11.1 Air duct at heat sources. Where heat sources from electrical equipment, fossil fuel-burning equipment, or solar energy collection equipment are installed in air ducts, the installation shall avoid the creation of a fire hazard. Air ducts rated as Class 1 in accordance with UL 181, air duct coverings, and linings shall be interrupted at the immediate area of operation of such heat sources in order to meet the clearances specified in the equipment listing.

1. Appliances listed for zero clearance from combustibles where installed with the conditions of their listings.
2. Insulation specifically suitable for the maximum temperature that reasonably can be anticipated on the duct surface shall be permitted to be installed at the immediate area of operation of such appliances.

603.12 Condensation. Provisions shall be made to prevent the formation of condensation on the exterior of any duct.

603.13 Flood hazard areas. For structures in [~~areas of special~~] flood hazard areas, ducts shall comply with the additional requirements of Appendix G of the *New York City Building Code*.

603.14 Location. Ducts shall not be installed in or within 4 inches (~~[+02]~~ 101.6 mm) of the earth, except where such ducts comply with Section 603.8.

603.15 Mechanical protection. Ducts installed in locations where they are exposed to mechanical damage by vehicles or from other causes shall be protected by approved vehicle barriers as required by the *New York City Building Code*.

603.16 Weather protection. [~~All ducts~~] Ducts including linings, coverings and vibration isolation connectors installed on the exterior of the building shall be [~~adequately~~] protected against the elements.

603.17 Air dispersion systems. Air dispersion systems shall:

1. Be installed entirely in exposed locations or in underfloor air supply plenums.
2. Be utilized in systems under positive pressure.
3. Not pass through or penetrate fire-resistant-rated construction.
4. Be listed and labeled in compliance with UL 2518.

603.18 Registers, grilles and diffusers. Duct registers, grilles and diffusers shall be installed in accordance with the manufacturer's [~~installation~~] instructions and securely fastened to the ductwork. Volume dampers or other means of supply air adjustment shall be provided in the branch ducts or at each individual duct register, grille or diffuser. Each volume damper or other means of supply air adjustment used in balancing shall be [~~accessible~~] provided with access.

~~[603.17.1]~~ **603.18.1 Floor registers.** Floor registers shall resist, without structural failure, a [~~200 pound~~] 200-pound (90.8 kg) concentrated load on a 2-inch-diameter (~~[54]~~ 50.8 mm) disc applied to the most critical area of the exposed face.

~~[603.17.2]~~ **603.18.2 Prohibited locations.** [~~Duct~~] Diffusers, registers [,] and grilles [~~and diffusers~~] shall be prohibited in the floor or its upward extension within toilet and bathing [~~room~~ rooms ~~and their upward extensions, to the extent those areas are~~] rooms required by the *New York City Building Code* to have smooth, hard [~~and~~] , nonabsorbent surfaces.

Exception: In R-3 occupancies.

~~[603.18]~~ **603.19 Vibration isolation connectors.** Vibration isolation connectors in duct systems shall be made of an approved flame-retardant fabric or shall consist of sleeve joints with packing of approved material, each having a maximum flame spread index/rating of 25 and a maximum [~~smoke developed~~] smoke-developed rating of 50. The fabric shall have a maximum length of 10 inches (254 mm) in the direction of airflow.

SECTION MC 604 INSULATION

604.1 General. Duct insulation shall conform to the requirements of Sections 604.2 through 604.13 and the *New York City Energy Conservation Code*.

604.2 Surface temperature. Ducts that operate at temperatures exceeding 120°F ([49] 48.9°C) shall have sufficient thermal insulation to limit the exposed surface temperature to 120°F ([49] 48.9°C).

604.3 Coverings and linings. Coverings and linings, including adhesives [~~when~~ where] used, shall have a flame spread index not more than 25 and a smoke-developed index not more than 50, when tested in accordance with ASTM E 84 or UL 723, using the specimen preparation and mounting procedures of ASTM E 2231. Duct coverings and linings shall not flame, glow, smolder or smoke when tested in accordance with ASTM C 411 at the temperature to which they are exposed in service. The test temperature shall not fall below 250°F ([424] 121.1°C). Coverings and linings shall be listed and labelled.

604.4 Foam plastic insulation. Foam plastic used as duct coverings and linings shall conform to the requirements of Section 604.

604.5 Appliance insulation. Listed and labeled appliances that are internally insulated shall be considered as conforming to the requirements of Section 604.

604.6 Penetration of assemblies. Duct coverings shall not penetrate a wall or floor required to have a fire-resistance rating or required to be fireblocked.

604.7 Identification. External duct insulation, except spray polyurethane foam, and factory-insulated flexible duct shall be legibly printed or identified at intervals not greater than 36 inches ([914] 914.4 mm) with the name of the manufacturer, the thermal resistance R-value at the specified installed thickness and the flame spread and smoke-developed indexes of the composite materials. [~~All duct~~] Duct insulation [~~product~~] R-values shall be based on insulation only, excluding air films, vapor retarders or other duct components, and shall be based on tested C-values at 75°F ([24] 23.9°C) mean temperature at the installed thickness, in accordance with recognized industry procedures. The installed thickness of duct insulation used to determine its [~~R-values~~] R-value shall be determined as follows:

1. For duct board, duct liner and factory-made rigid ducts not normally subjected to compression, the nominal insulation thickness shall be used.
2. For duct wrap, the installed thickness shall [~~be assumed to~~] be 75 percent (25 percent compression) of nominal thickness.
3. For factory-made flexible air ducts, the installed thickness shall be determined by dividing the difference between the actual outside diameter and nominal inside diameter by two.
4. For spray polyurethane foam, the aged R-value per inch, measured in accordance with recognized industry standards, shall be provided to the customer in writing at the time of foam application.

604.8 Lining installation. Linings shall be interrupted at the area of operation of a fire damper and at ~~[a minimum of]~~ not less than 6 inches (~~[152]~~ 152.4 mm) upstream of and 6 inches (~~[152]~~ 152.4 mm) downstream of electric-resistance and fuel-burning heaters in a duct system. Metal nosings or sleeves shall be installed over exposed duct liner edges that face opposite the direction of airflow, and all exposed edges, joints and seams shall be sealed.

604.9 Thermal continuity. Where a duct liner required for thermal insulation or condensation control has been interrupted, a duct covering of equal thermal performance shall be installed.

604.10 Service openings. Service openings shall not be concealed by duct coverings unless the exact location of the opening is properly identified.

604.11 Vapor retarders. Where ducts used for cooling are externally insulated, the insulation shall be covered with a vapor retarder having a maximum permeance of 0.05 perm (2.87 ng/(~~[Pa·s·m²]~~ Pa·s·m²)) or aluminum foil having a minimum thickness of 2 mils (~~[0.054]~~ 0.051 mm). Insulations having a permeance of 0.05 perm (2.87 ng/(~~[Pa·s·m²]~~ Pa·s·m²)) or less shall not be required to be covered. All joints and seams shall be sealed to maintain the continuity of the vapor retarder.

604.12 Weatherproof barriers. Insulated exterior ducts shall be protected with an ~~[approved]~~ adequate weatherproof barrier.

604.13 Internal insulation. Materials used as internal insulation and exposed to the airstream in ducts shall be shown to be durable when tested in accordance with UL 181. Exposed internal insulation that is not impermeable to water shall not be used to line ducts or plenums from the exit of a cooling coil to the downstream end of the drain pan.

SECTION MC 605 AIR FILTERS

605.1 General. Heating and air-conditioning systems ~~[of the central type]~~ shall be provided with approved air filters. Filters shall be installed ~~[in the]~~ such that all return air [system], outdoor air and makeup air is filtered upstream from any heat exchanger or coil ~~[;].~~ Filters shall be installed in an ~~[approved convenient]~~ accessible location. Liquid adhesive coatings used on filters shall have a flash point not lower than 325°F (~~[163]~~ 162.8°C).

605.2 Standards. Media-type and electrostatic-type air filters shall be listed and labeled. Media-type air filters shall comply with UL 900. ~~[High efficiency]~~ High efficiency particulate air filters shall comply with UL 586. Electrostatic-type air filters shall comply with UL 867. Air filters utilized within dwelling units shall be designed for the intended application and shall not be required to be listed and labeled.

605.2.1 Standards for air-handling units. Air-handling units of mechanical ventilation systems, any portion of which provide outdoor air ventilation, shall be equipped with a particulate matter filtration system in accordance with ASHRAE 62.1 or ASHRAE 62.2 and shall have a minimum efficiency reporting value (MERV) of 11 or greater in accordance with ASHRAE 52.2.

Exceptions:

1. This section shall not apply to the alteration or repair of a mechanical ventilation system that was installed prior to January 1, 2013 unless such alteration or repair includes the replacement or addition of an air-handling unit in such system.
 2. [~~This section shall not apply to the replacement of an air handling unit in a mechanical ventilation system installed prior to January 1, 2013 if the department determines that the design of such replacement air handling unit cannot be made to comply with the allowable fan system power limitations of the *New York City Energy Conservation Code*.~~]
- [3.] This section shall not apply to any air-handling unit with a design capacity of less than 5,000 cfm (2.4 m³/s).
- [4] 3. This section shall not apply for combustion outside air, dilution air, ventilation air for mechanical room and [~~inhabitable~~] spaces not intended for occupancy.

605.3 Airflow over the filter. Ducts shall be constructed to allow an even distribution of air over the entire filter.

605.4 Liquid adhesive tanks. Tanks for liquid adhesives, into which removable filters are dipped, shall be [~~located either outside the building or, if such a location is not available, in a separate fire-resistive room and stored in accordance with NFPA 30. Such tanks shall be metal, equipped with tight fitting covers and shall be kept tightly covered when not in actual use~~] prohibited.

605.5 Filter maintenance. All air filters shall be kept free of excess dust and combustible material. Unit filters shall be renewed or cleaned when the resistance to airflow has increased to two times the original resistance or when the resistance has reached a value of recommended replacement by the manufacturer. A permanently installed draft gauge or differential pressure transmitter shall be provided for all systems equal to or greater than 4000 cfm (1.89 m³/s). [~~Where the filters are of the automatic liquid adhesive type, sludge shall be removed from the liquid adhesive reservoir regularly.~~]

SECTION MC 606 SMOKE DETECTION SYSTEMS CONTROL

606.1 Controls required. Air distribution systems shall be equipped with smoke detectors listed and labeled for installation in air distribution systems, as required by this section. Duct smoke detectors shall comply with UL 268A. Other smoke detectors shall comply with UL 268.

606.2 Where required. Smoke detectors shall be installed where indicated in Sections 606.2.1 through 606.2.4.

[~~**Exception:** Smoke detectors shall not be required where air distribution systems are incapable of spreading smoke beyond the enclosing walls, floors and ceilings of the room or space in which the smoke is generated.~~]

606.2.1 Return air systems. Smoke detectors shall be installed in return air systems with a design capacity greater than 2,000 cfm (0.9 m³/s), in the return air duct or plenum upstream of any filters, exhaust air connections, outdoor air connections, or decontamination equipment and appliances.

Exception: Smoke detectors are not required in the return air system where all portions of the building served by the air distribution system are protected by area smoke detectors connected to a fire alarm system in accordance with the *New York City [Fire] Building Code*. The area smoke detection system shall comply with Section 606.4.

606.2.2 Common supply and return air systems. Where multiple air-handling systems share common supply or return air ducts or plenums with a combined design capacity greater than 2,000 cfm (0.9 m³/s), the return air system shall be provided with smoke detectors in accordance with Section 606.2.1.

Exception: Individual smoke detectors shall not be required for each fan-powered terminal unit, provided that such units do not have an individual design capacity greater than 2,000 cfm (0.9 m³/s) and will be shut down by activation of one of the following:

1. Smoke detectors required by Sections 606.2.1 and 606.2.3.
2. An approved area smoke detector system located in the return air plenum serving such units.
3. An area smoke detector system as prescribed in the exception to Section 606.2.1.

In all cases, the smoke detectors shall comply with Sections 606.4 and 606.4.1.

606.2.3 Return air risers. Where return air risers serve two or more stories and serve any portion of a return air system having a design capacity greater than 15,000 cfm (7.1 m³/s), smoke detectors shall be installed at each story. Such smoke detectors shall be located [~~up stream~~] upstream of the connection between the return air riser and any air ducts or plenums.

606.2.4 Supply air systems. Smoke detectors listed for use in air distribution systems shall be installed downstream of the air filters and [~~ahead~~] upstream of any branch connections in air supply systems having a capacity greater than 2,000 cfm (0.9 m³/s).

606.3 Installation. Smoke detectors required by this section shall be installed in accordance with the *New York City Electrical Code*. The required smoke detectors shall be installed to monitor the entire airflow conveyed by the system. Access shall be provided to smoke detectors for inspection and maintenance.

606.4 Controls operation. Upon activation, the smoke detectors shall shut down all operational capabilities of the air distribution systems serving the affected areas in accordance with the listing and labeling of appliances used in the system. Air distribution systems that are part of a smoke control system shall switch to the smoke control mode upon activation of a detector.

606.4.1 Supervision. The duct smoke detectors shall be connected to a fire alarm system where a fire alarm system is required by Section 907.2 of the *New York City Building Code*. The

actuation of a duct smoke detector shall activate a visible and audible alarm signal at a constantly attended location.

Exceptions:

1. The alarm signal at a constantly attended location is not required where the duct smoke detector activates the building's alarm-indicating appliances.
2. In occupancies not required to be equipped with a fire alarm system, actuation of either area or duct smoke detector shall activate a visible and an audible alarm signal in an approved location. Additionally, duct smoke detector trouble conditions shall activate a visible or audible alarm signal in an approved location and shall be identified as air duct detector trouble.

606.4.2 Fan shutdown for recirculating air systems. When any building or floor is provided with an air system [~~utilizing~~] designed to use recirculated air and is protected by an automatic sprinkler system or an automatic fire alarm system, [~~provisions shall be made to automatically stop~~] the fans recirculating air serving the affected area shall automatically stop when [~~the~~] sprinkler water flow [system] or a fire [alarm system are installed] condition is detected in the area [~~, it shall be required to have only one of these systems arranged to stop the fans~~]. For the purposes of this section, 100 percent outdoor air systems shall not be considered recirculating systems.

Exceptions:

1. Activation of a manual pull station shall not be required to automatically stop the fans.
2. Systems having a capacity of 2,000 cfm (~~[0.2]~~ 0.9 m³/s) or less or serving not more than one floor.
3. In Group R-2 and R-3 occupancies with energy recovery systems complying with Section 514.4 and not serving public corridors.

606.4.3 Manual restart of fans after automatic fire detecting device or fire alarm system shut down. Fans or fan systems which have been automatically shut down on activation of an automatic fire detecting device or fire alarm system shall be arranged and equipped so that they do not automatically restart when either the automatic fire detecting device or fire alarm system is reset. The manual means of restarting the fans or fan system shall function independently from the manual resetting of either the automatic fire detecting device or fire alarm system.

606.5 Manual control. Manual controls of fans shall be provided in accordance with Section 405.2.

**SECTION MC 607
DUCTS AND AIR TRANSFER OPENINGS**

607.1 General. The provisions of this section shall govern the protection of duct penetrations and air transfer openings in fire-resistance-rated assemblies required to be protected.

607.1.1 Ducts and air transfer openings. Ducts transitioning horizontally between shafts shall comply with one of the following:

1. The horizontal enclosure between shafts shall match the required rating of the shafts.
2. Fire-resistive duct assemblies shall be provided in accordance with Section 604. The duct assembly shall comply with all of the following:
 - 2.1. Ducts shall not be within the scope of Sections 502.10, 504, 506.3, 510, or 511; and
 - 2.2. Ducts shall not be lined with nor convey combustible materials; and
 - 2.3. Ducts shall not be constructed of materials that are sensitive to thermal shock.
3. The horizontal offset duct shall be provided with combination fire-smoke dampers at the penetration of each shaft. The duct system shall comply with all of the following:
 - 3.1. Ducts shall not be within the scope of Sections 502.10, 504, 506.3, 510, or 511; and
 - 3.2. The duct system shall be a type permitted to include dampers; and
 - 3.3. Protection of penetrations of the shaft enclosure shall not utilize exceptions requiring continuous air movement.

607.1.2 Ducts that penetrate fire-resistance-rated assemblies without dampers. Ducts that penetrate fire-resistance-rated assemblies and are not required by this section to have dampers [~~by this section~~] shall comply with the requirements of Sections [~~713.2~~] 714.2 through [~~713.3.3~~] 714.3.3 of the *New York City Building Code*. Ducts that penetrate horizontal assemblies not required to be contained within a shaft and not required by this section to have dampers shall comply with the requirements of Sections [~~713.4 through 713.4.2.2~~] 714.4 of the *New York City Building Code*.

[Exception: ~~Ducts 20 square inches (129 cm²) or less passing through fire-resistance-rated assemblies shall not require fire dampers or fire smoke dampers.]~~

[607.1.1.1] 607.1.2.1 Ducts that penetrate nonfire-resistance-rated assemblies. The space around a duct penetrating a nonfire-resistance-rated floor assembly shall comply with Section [~~716.6.3~~] 717.6.3 of the *New York City Building Code*.

607.2 Installation. Fire dampers, smoke dampers, combination fire/smoke dampers and ceiling radiation dampers located within air distribution and smoke control systems shall be installed in accordance with the requirements of this section, and the manufacturer's [~~installation~~] instructions and [~~the damper's~~] listing.

607.2.1 Smoke control system. Where the installation of a fire damper will interfere with the operation of a required smoke control system in accordance with Section 909 of the *New York City Building Code*, approved alternative protection shall be used. Where mechanical systems including ducts and dampers used for normal building ventilation serve as part of the smoke

control system, the expected performance of these systems in smoke control mode shall be addressed in the rational analysis required by Section 909.4 of the *New York City Building Code*.

607.2.1.1 Remote operation. Combination fire and smoke dampers shall be operable by remote controls where necessary for smoke removal. Such dampers shall have provisions that allow them to reclose automatically upon reaching the damper's maximum degradation test temperature in accordance with UL 555S.

607.2.2 Hazardous exhaust ducts. Fire dampers for hazardous exhaust duct systems shall comply with Section 510.

607.2.3 Supply air systems. Smoke dampers listed for use in air distribution systems shall be installed both upstream and downstream of filters and ahead of any branch connections in supply air-handling apparatus and systems having a capacity equal to or greater than 15,000 cfm (7.1 m³/s).

Exceptions:

1. Where the air-handling unit is located on the floor that it serves and serves only that floor.
2. Where the air-handling unit is located on the roof and serves only the floor immediately below the roof.

607.3 Damper testing, ratings and actuation. Damper testing, ratings and actuation shall be in accordance with Sections 607.3.1 through 607.3.3.

607.3.1 Damper testing. Dampers shall be listed and bear the label of an approved testing agency indicating compliance with the standards in this section. Fire dampers shall comply with the requirements of UL 555. Only fire dampers and ceiling radiation dampers labeled for use in dynamic systems shall be installed in heating, ~~[ventilation]~~ ventilating and air-conditioning systems designed to operate with fans on during a fire. Smoke dampers shall comply with the requirements of UL 555S. Combination fire/smoke dampers shall comply with the requirements of both UL 555 and UL 555S. Ceiling radiation dampers shall comply with the requirements of UL 555C-Ceiling Dampers.

607.3.2 Damper ~~[ratings]~~ rating. Damper ratings shall be in accordance with Sections 607.3.2.1 through 607.3.2.3.

607.3.2.1 Fire damper ratings. Fire dampers shall have the minimum fire protection rating specified in Table 607.3.2.1 for the type of penetration.

**TABLE 607.3.2.1
FIRE DAMPER RATING**

TYPE OF PENETRATION	MINIMUM DAMPER RATING (hour)
Less than 3-hour fire-resistance-rated assemblies	1½
3-hour or greater fire-resistance-rated assemblies	3

607.3.2.2 Smoke damper ratings. Smoke damper leakage ratings shall ~~not~~ be ~~less than~~ Class I or II. Elevated temperature ratings shall ~~not~~ be not less than 250°F (~~121~~ 121.1°C).

607.3.2.3 Combination fire/smoke damper ratings. Combination fire/smoke dampers shall have the minimum fire protection rating specified for fire dampers in Table 607.3.2.1 for the type of penetration and shall ~~also~~ have a minimum ~~Class II leakage~~ smoke damper rating ~~[and a minimum elevated temperature rating of 250°F (121°C)]~~ as specified in Section 607.3.2.2.

607.3.3 Damper actuation. Damper actuation shall be in accordance with Sections 607.3.3.1 through 607.3.3.4 as applicable.

607.3.3.1 Fire damper actuation device. The fire damper actuation device shall meet one of the following requirements:

1. The operating temperature shall be approximately 50°F (~~28~~ 10°C) above the normal temperature within the duct system, but not less than 160°F (~~71~~ 71.1°C).
2. The operating temperature shall be not more than 350°F (~~177~~ 176.7°C) where located in a smoke control system complying with Section 909 of the *New York City Building Code*.

607.3.3.2 Smoke damper actuation. The smoke damper shall close upon actuation of a listed smoke detector or detectors installed in accordance with Section 606 of this code and Section 907.3 of the *New York City Building Code* and one of the following methods, as applicable:

1. Where a smoke damper is installed within a duct, a smoke detector shall be installed ~~in~~ inside the duct or outside the duct with sampling tubes protruding into the duct. The detector or tubes within the duct shall be within 5 feet (1524 mm) of the damper ~~[with no air].~~ Air outlets ~~or~~ and inlets shall not be located between the detector or tubes and the damper. The detector shall be listed for the air velocity, temperature and humidity anticipated at the point where it is installed. Other than in mechanical smoke control systems, dampers shall be closed upon fan shutdown where local smoke detectors require a minimum velocity to operate.

[Exceptions] Exception: Duct smoke detectors will not be required at each smoke or combination fire smoke damper provided:

1. ~~[Duct smoke detectors will not be required at each fire smoke damper provided the]~~ The supply fan shall shut down and all the smoke and combination fire smoke dampers associated with the supply system automatically close upon actuation of any automatic alarm initiating device on the floor(s).
2. ~~[Duct smoke detectors will be required within 5 feet (1.5 m) downstream of any electric duct reheat coil.]~~
- ~~[3.]~~ ~~[Non-ducted]~~ Nonducted return air systems shall have a smoke detector located within 5 feet (1.5 m) upstream of each return air ~~[protected]~~ or transfer opening in a ~~[2-hour fire-rated barrier]~~ fire barrier rated 2-hour or greater.
- ~~[4.]~~ 3. Ducted return air systems shall have a duct smoke detector located within 5 feet (1.5 m) of a smoke damper; additional smoke detectors ~~[will not be]~~ are not required at smoke and combination fire smoke dampers located downstream where there are no additional return air inlets.
2. Where a smoke damper is installed above smoke barrier doors in a smoke barrier, a spot-type detector ~~[listed for releasing service]~~ shall be installed on either side of the smoke barrier door opening. The detector shall be listed for releasing service if used for direct interface with the damper.
3. Where a smoke damper is installed within an unducted opening in a wall, a spot-type detector ~~[listed for releasing service]~~ shall be installed within 5 feet (1524 mm) horizontally of the damper. The detector shall be listed for releasing service if used for direct interface with the damper.
4. Where a smoke damper is installed in a corridor wall or ceiling, the damper shall be permitted to be controlled by a smoke detection system installed in the corridor.
5. Where a ~~[total coverage]~~ smoke ~~[detector]~~ detection system is ~~[provided within]~~ installed in all areas served by ~~[an HVAC system,]~~ the duct in which the damper will be located, the smoke dampers shall be permitted to be controlled by the smoke detection system.
6. Smoke dampers that are part of an engineered smoke control system shall be capable of being positioned manually from a command station. Such positioning devices shall be provided for supply and return/exhaust dampers grouped by floor and by type. Damper switch positions shall indicate whether the related dampers are commanded to be either open or closed. Smoke damper positioning switches shall be located at the Fire Command Station, or in a Mechanical Control Center in buildings without a Fire Command Station.

607.3.3.3 Combination fire/smoke damper actuation. Combination fire/smoke damper actuation shall be in accordance with Sections 607.3.3.1 and 607.3.3.2. Combination fire/smoke dampers installed in smoke control system shaft penetrations shall not be activated by local area smoke detection unless it is secondary to the smoke management system controls.

607.3.3.4 Ceiling radiation damper actuation. The operating temperature of a ceiling radiation damper actuation device shall be 50°F (~~28~~ 10°C) above the normal temperature within the duct system, but not less than 160°F (~~74~~ 71.1°C).

607.4 Access and identification. Fire and smoke dampers shall be provided with an approved means of access, large enough to permit inspection and maintenance of the damper and its operating parts. The access shall not affect the integrity of fire-resistance-rated assemblies. The access openings shall not reduce the fire-resistance rating of the assembly. Access points shall be permanently identified on the exterior by a label having letters not less than 0.5 inch (12.7 mm) in height reading: FIRE/SMOKE DAMPER, SMOKE DAMPER or FIRE DAMPER, followed by an identification marking that is individual and unique to the damper accessed. Access doors in ducts shall be tight fitting and suitable for the required duct construction.

607.5 Where required. Fire dampers, smoke dampers, and combination fire/smoke dampers shall be provided at the locations prescribed in ~~[this section]~~ Sections 607.5.1 through 607.5.7. Where an assembly is required to have both fire dampers and smoke dampers, combination fire/smoke dampers or a fire damper and ~~[a]~~ smoke damper shall be ~~[required]~~ provided.

Exceptions:

1. Ducts 20 square inches (~~[129 cm²]~~ 12 903 mm²) or less passing through fire-resistance-rated assemblies other than fire walls shall not require fire dampers or smoke dampers.
2. Smoke dampers shall not be required to be located ~~[within a prescribed distance of a fire rated enclosure]~~ within a prescribed distance of a fire-rated enclosure and where isolation smoke dampers are used in air-handling equipment. [↔]

607.5.1 Fire walls. Ducts and air transfer openings permitted in firewalls in accordance with Section 706.11 of the *New York City Building Code* shall be protected with listed fire dampers and smoke dampers installed in accordance with their listing.

Exception: Smoke dampers shall not be required in ducts where the air continues to move and the air-handling system installed is arranged to prevent recirculation of exhaust or return air under fire emergency conditions or loss of normal power by provision of standby power in accordance with Chapter 27 of the *New York City Building Code*.

607.5.1.1 Horizontal exits. A listed smoke damper designed to resist the passage of smoke shall be provided at each point that a duct or air transfer opening penetrates a fire wall that serves as a horizontal exit.

Exception: Smoke dampers shall not be required in ducts where the air continues to move and the air-handling system installed is arranged to prevent recirculation of exhaust or

return air under fire emergency conditions or loss of normal power by provision of standby power in accordance with Chapter 27 of the *New York City Building Code*.

607.5.2 Fire barriers. Ducts and air transfer openings that penetrate fire barriers shall be protected with listed fire dampers installed in accordance with their listing. Ducts and air transfer openings shall not penetrate ~~[exit]~~ enclosures for interior exit stairways and ramps and exit passageways except as permitted by Sections ~~[4022.4]~~ 1023.5 and ~~[4022.6]~~ 1024.6, respectively, of the *New York City Building Code*. In addition, smoke dampers shall be installed in penetrations of public corridor and horizontal exit walls in accordance with Section 607.5.2.1.

Exceptions: Fire dampers are not required at penetrations of fire barriers where any of the following apply:

1. Penetrations are tested in accordance with ASTM E 119 or UL 263 as part of the fire-resistance-rated assembly.
2. Ducts are used as part of an engineered smoke control system in accordance with Section 513 of this code and Section 909 of the *New York City Building Code* and where the fire damper would interfere with the operation of the smoke control system.
3. Such walls are penetrated by ducted HVAC systems, have a required fire-resistance rating of 1 hour or less, are in areas other than Group H and are in buildings equipped throughout with an automatic sprinkler system in accordance with Section 903.3.1.1 or 903.3.1.2 of the *New York City Building Code*. For the purposes of this exception, a ducted HVAC system shall be a duct system for the structure's HVAC system. Such a duct system shall be constructed of sheet metal not less than 26 gage (0.0217-inch) ~~[[0.55 mm]]~~ (0.55 mm) thickness and shall be continuous from the air-handling appliance or equipment to the air outlet and inlet terminals.

607.5.2.1 Horizontal exits. A listed smoke damper designed to resist the passage of smoke shall be provided at each point that a duct or air transfer opening penetrates a fire barrier that serves as a horizontal exit.

Exception: Smoke dampers shall not be required in ducts where the air continues to move and the air-handling system installed is arranged to prevent recirculation of exhaust or return air under fire emergency conditions.

607.5.2.2 Public corridors. A listed smoke damper designed to resist the passage of smoke shall be provided at each point a duct or air transfer opening penetrates a public corridor wall constructed as a fire barrier.

Exceptions:

1. Smoke dampers are not required where the building is equipped throughout with an approved smoke control system in accordance with Section 909 of the *New York City Building Code*, and smoke dampers are not necessary for the operation and control of the system.

2. Smoke dampers are not required in corridor penetrations where the duct is constructed of steel not less than 0.019-inch (0.48 mm) in thickness and there are no openings serving the corridor.
3. Smoke dampers are not required in corridor penetrations in Group R-2 buildings and public corridors serving R-2 spaces in mixed use buildings.
4. Smoke dampers shall not be required in ducts where the air continues to move and the air-handling system installed is arranged to prevent recirculation of exhaust or return air under fire emergency conditions or loss of normal power by provision of standby power in accordance with Chapter 27 of the New York City Building Code.

607.5.3 Fire partitions. Ducts and air transfer openings that penetrate fire partitions shall be protected with listed fire dampers installed in accordance with their listing.

Exceptions: In occupancies other than Group H, fire dampers are not required where any of the following apply:

1. The partitions are tenant separation and corridor walls in buildings equipped throughout with an automatic sprinkler system in accordance with Section 903.3.1.1 or 903.3.1.2 of the *New York City Building Code* and the duct is protected as a through penetration in accordance with Section 714 of the New York City Building Code.
2. The partitions are tenant partitions in covered and open mall buildings where the walls are not required by provisions elsewhere in the *New York City Building Code* to extend to the underside of the floor or roof sheathing, slab or deck above.
3. The duct system is constructed of approved materials in accordance with ~~[this]~~ code and the duct penetrating the wall ~~[meets]~~ complies with all of the following ~~[minimum]~~ requirements.
 - 3.1. The duct shall not exceed 100 square inches (0.06 m²).
 - 3.2. The duct shall be constructed of steel ~~[a minimum of 0.0217-inch]~~ not less than 0.0217 inch (0.55 mm) in thickness.
 - 3.3. The duct shall not have openings that communicate the corridor with adjacent spaces or rooms.
 - 3.4. The duct shall be installed above a ceiling.
 - 3.5. The duct shall not terminate at a wall register in the fire-resistance-rated wall.
 - 3.6. A minimum 12-inch-long (~~[304.8]~~ 305 mm) by 0.060-inch-thick (1.52 mm) steel sleeve shall be centered in each duct opening. The sleeve shall be secured to both sides of the wall and all four sides of the sleeve with minimum ~~[1½-inch]~~ 1½-inch by 1½-inch by 0.060-inch (~~[38]~~ 38.1 mm by ~~[38]~~ 38.1 mm by 1.52 mm) steel retaining angles. The retaining angles shall be secured to the sleeve and the

wall with No. 10 (M5) screws. The annular space between the steel sleeve and the wall opening shall be filled with rock (mineral) wool batting or approved equivalent on all sides.

4. Such partitions are penetrated by ducted HVAC systems, have a required fire-resistance rating of 1 hour or less, and are in areas of other than Group H and are in buildings equipped throughout with an automatic sprinkler system in accordance with Section 903.3.1.1 or 903.3.1.2 of the *New York City Building Code*. For the purposes of this exception, a ducted HVAC system shall be a duct system for conveying supply, return or exhaust air as part of the structure's HVAC system. Such a duct system shall be constructed of sheet steel not less than 26 gage in thickness and shall be continuous from the air-handling appliance or equipment to the air outlet and inlet terminals.

607.5.4 Smoke barriers. A listed smoke damper designed to resist the passage of smoke shall be provided at each point where a duct or an air transfer opening penetrates a smoke barrier wall enclosure required to have smoke and draft control doors in accordance with the *New York City Building Code*. Smoke dampers and smoke damper actuation methods shall comply with Section 607.5.4.1.

Exceptions:

1. Smoke dampers are not required in smoke barrier penetrations where the openings in ducts are limited to a single smoke compartment and the ducts are constructed of steel.
2. Smoke dampers are not required in ducts where the air continues to move and the air-handling system installed is arranged to prevent recirculation of exhaust or return air under fire emergency conditions.

607.5.4.1 Smoke damper. The smoke damper shall close upon actuation of a listed smoke detector or detectors installed in accordance with the *New York City Building Code* and Section 607.3.3.2.

607.5.5 Shaft enclosures. Ducts and air transfer openings shall not penetrate a shaft serving as an exit enclosure except as permitted by Section 1022.4 of the *New York City Building Code*. Shaft enclosures that are permitted to be penetrated by ducts and air transfer openings shall be protected with approved fire and smoke dampers installed in accordance with their listing.

Exceptions:

1. Fire dampers are not required at penetrations of shafts where any of the following apply:
 - 1.1. In buildings equipped throughout with an automatic sprinkler system in accordance with Chapter 9 of the *New York City Building Code*, where [Steel] steel exhaust subducts have a minimum thickness of 0.0187 inch (0.4712 mm) (No. 26 gage) and extend [at least] not less than 22 inches ([559] 558.8 mm) vertically in exhaust shafts, provided that there is a continuous airflow upward to the [outside, or] outdoors whenever the building is occupied.

- 1.2. Penetrations are tested in accordance with ASTM E 119 or UL 263 as part of the fire-resistance-rated assembly [~~7-06~~].
- 1.3. Ducts are used as part of an engineered smoke control system designed and installed in accordance with Section 909 of the *New York City Building Code*, and where the fire damper will interfere with the operation of the smoke control system [~~7-06~~].
- 1.4. The penetrations are in parking garage exhaust or supply shafts that are separated from other building shafts by not less than 2-hour fire-resistance-rated construction.
2. [~~In Group B and R occupancies, equipped throughout with an automatic sprinkler system in accordance with Section 903.3.1.1 of the *New York City Building Code*, smoke dampers are not required at penetrations of shafts where kitchen, bathroom and toilet room exhaust openings with steel exhaust subducts, having a wall minimum thickness of at least 0.0187 inch (0.4712 mm) (No. 26 gage), extend at least 22 inches (559 mm) vertically and where the exhaust fan at the upper terminus is powered continuously and maintains airflow upward to the outdoors.~~] Smoke dampers are not required in exhaust ducts or shafts where the exhaust fan is maintained in operation whenever the building is occupied, in bathrooms and toilet room exhausts.
3. Smoke dampers are not required at [~~penetration~~] penetrations of exhaust or supply shafts in parking garages that are separated from other building shafts by not less than 2-hour fire-resistance-rated construction.
4. Smoke dampers are not required at penetrations of shafts where ducts are used as part of an engineered mechanical smoke control system designed in accordance with Section 909 of the *New York City Building Code* and where the smoke damper will interfere with the operation of the smoke control system.
5. Fire dampers and/or smoke dampers are not required at a shaft where the shaft is acting as an extension of the mechanical equipment room that it serves and the shaft and mechanical equipment room maintain fire and smoke separation required by the greater of the two spaces from the occupied portions of the building and meet the requirements of [~~Section 708.11~~] Sections 713.11 and 713.12 of the *New York City Building Code*.
6. Smoke dampers are not required to be located within a prescribed distance of a fire-rated enclosure within which the air handling equipment is located and where isolation smoke dampers are used in air-handling equipment. See Section 607.2.3 for additional requirements.
7. Smoke dampers are not required in ducts where the air continues to move and the air-handling system installed is arranged to prevent recirculation of exhaust or return

air during a fire emergency condition. Such fans shall be provided with standby power in accordance with Chapter 27 of the *New York City Building Code*.

~~[8. Smoke dampers are not required in exhaust ducts or shafts where the exhaust fan is maintained in operation during occupancy, such as in bathrooms and toilet room exhausts.]~~

607.5.5.1 Enclosure at the bottom. Shaft enclosures that do not extend to the bottom of the building or structure shall be protected in accordance with Section ~~[708.11]~~ 713.11 of the *New York City Building Code*.

607.5.5.2 Limitations. Shafts that constitute air ducts or that enclose air ducts used for the movement of environmental air shall not enclose:

1. Exhaust ducts used for the removal of smoke and grease-laden vapors from cooking equipment;
2. Ducts used for removal of flammable vapors;
3. Ducts used for moving, conveying, or transporting stock, vapor or dust;
4. Ducts used for the removal of nonflammable corrosive fumes and vapors;
5. Refuse and linen chutes; or
6. Piping.

Exception: Shafts that constitute air ducts or that enclose air ducts used for the movement of environmental air may enclose noncombustible piping conveying water or other nonhazardous or nontoxic materials.

607.5.6 Exterior walls. Ducts and air transfer openings in fire-resistance-rated exterior walls required to have protected openings in accordance with Section 705.10 of the *New York City Building Code* shall be protected with listed fire dampers installed in accordance with their listing.

607.5.6.1 Outdoor air intake openings. An outdoor air intake opening with gross area of more than 144 square inches (92 903 mm²) shall be provided with fire dampers and smoke dampers, or combined fire and smoke dampers when such opening is located as follows (intake and exhaust separation requirements of Chapters 4 and 5 shall also be maintained):

1. Less than 30 feet (9144 mm) above grade.
2. Less than 30 feet (9144 mm) in any direction from any opening in another building.
3. Less than 15 feet (4572 mm) from a lot line.
4. Less than 50 feet (15 240 mm) above and less than 50 feet (15 240 mm) in any direction from a roof constructed of combustible material or a building in which the exterior walls are constructed wholly or partly of wood.

Exceptions:

1. Smoke dampers shall not be required for outdoor air intake openings of systems greater than 15,000 cfm (7.1 m³/s) which are provided with smoke dampers in accordance with Chapter 6 and arranged so as to not introduce smoke into the building or space in which the equipment is located.
2. A damper is not required where the combustion air intake duct, boiler room, and combustion air intake louver for such boiler room are enclosed with construction having a fire-resistance rating not less than the rating of the exterior wall, boiler room and any intervening space.

607.5.7 Smoke partitions. A listed smoke damper designed to resist the passage of smoke shall be provided at each point where an air transfer opening penetrates a smoke partition. Smoke dampers and smoke damper actuation methods shall comply with Section 607.3.3.2.

Exceptions:

1. Where the installation of a smoke damper will interfere with the operation of a required smoke control system in accordance with Section 513, approved alternate protection shall be used.
2. Smoke dampers shall not be required in ducts where the air continues to move and the air-handling system installed is arranged to prevent recirculation of exhaust or return air under fire emergency conditions.

607.6 Horizontal assemblies. Penetrations by air ducts of a floor, floor/ceiling assembly or the ceiling membrane of a roof/ceiling assembly shall be protected by a shaft enclosure that complies with the *New York City Building Code* or shall comply with this section.

607.6.1 Through penetrations. In occupancies other than Groups I-2 and I-3, a duct and air transfer opening system constructed of approved materials in accordance with this code that penetrates a fire-resistance-rated floor/ceiling assembly that connects not more than two stories is permitted without shaft enclosure protection [-] provided that a listed fire damper is installed at the floor line and the penetration is firestopped or the duct is protected in accordance with Section [713.4] 714.4 of the *New York City Building Code*. For air transfer openings, see [~~Exception 7~~] Item 6, Section [~~708.2~~] 712.1.9 of the *New York City Building Code*.

Exception: A duct serving a dwelling unit is permitted to penetrate three floors or less without a fire damper at each floor provided such duct meets all of the following requirements.

1. The duct is contained and located within the cavity of a wall and is constructed of steel having a minimum thickness of 0.0187 inch (0.4712 mm) (No. 26 gage) [~~in thickness~~].
2. The duct opens into only one dwelling or sleeping unit and the duct system is continuous from the unit to the exterior of the building.

3. The duct does not exceed a 5-inch (127 mm) nominal diameter and the total area of such ducts does not exceed 100 square inches (64 516 mm²) for any 100 square feet (9.3 m²) of the floor area.
4. The annular space around the duct is protected with materials that prevent the passage of flame and hot gases sufficient to ignite cotton waste where subjected to ASTM E 119 or UL 263 time-temperature conditions under a minimum positive pressure differential of 0.01 inch (2.49 Pa) of water at the location of the penetration for the time period equivalent to the fire-resistance rating of the construction penetrated.
5. Grille openings located in a ceiling of a fire-resistance-rated floor/ceiling or roof/ceiling assembly ~~is~~ are protected with a listed ceiling radiation damper installed in accordance with Section 607.6.2.1.

607.6.2 Membrane penetrations. Ducts and air transfer openings constructed of approved materials, in accordance with Section 603, that penetrate the ceiling membrane of a fire-resistance-rated floor/ceiling or roof/ceiling assembly shall be protected with one of the following:

1. A shaft enclosure in accordance with Section ~~[708]~~ 713 of the *New York City Building Code*.
2. A listed ceiling radiation damper and firestopping installed at the ceiling line where a duct penetrates the ceiling of a fire-resistance-rated floor/ceiling or roof/ceiling assembly.
3. A listed ceiling radiation damper and firestopping installed at the ceiling line where a diffuser with no duct attached penetrates the ceiling of a ~~[fire-resistance-rated]~~ fire-resistance-rated floor/ceiling or roof/ceiling assembly.

607.6.2.1 Ceiling radiation dampers. Ceiling radiation dampers shall be tested ~~[as part of a fire-resistance-rated floor/ceiling or roof/ceiling assembly]~~ in accordance with ~~[ASTM E 119 or UL 263]~~ Section 607.3.1. Ceiling radiation dampers shall be installed in accordance with the details listed in the fire-resistance-rated assembly and the manufacturer's ~~[installation]~~ instructions and ~~[the]~~ listing. Ceiling radiation dampers are not required where ~~[either]~~ any of the following ~~[applies]~~ apply:

1. Tests in accordance with ASTM E 119 or UL 263 have shown that ceiling radiation dampers are not necessary to maintain the fire-resistance rating of the assembly.
2. ~~[Exhaust]~~ Where exhaust duct penetrations are protected in accordance with Section ~~[713.4.1.2]~~ 714.4.2 of the *New York City Building Code*, are located within the cavity of a wall, and do not pass through another dwelling unit or tenant space.
3. Where duct and air transfer openings are protected with a duct outlet protection system tested as part of a fire-resistance-rated assembly in accordance with ASTM E 119 or UL 263 and the building is protected throughout with an automatic sprinkler system in accordance with Chapter 9 of the *New York City Building Code*.

607.6.3 Nonfire-resistance-rated floor assemblies. Duct systems constructed of approved materials in accordance with Section 603 that penetrate nonfire-resistance-rated floor assemblies shall be protected by any of the following methods:

1. A shaft enclosure in accordance with Section ~~[708]~~ 713 of the *New York City Building Code*.
2. The duct connects not more than two stories, and the annular space around the penetrating duct is protected with an approved noncombustible material that resists the free passage of flame and the products of combustion.
3. ~~[The]~~ In floor assemblies composed of noncombustible materials, a shaft shall not be required where the duct connects not more than three stories, ~~[and]~~ the annular space around the penetrating duct is protected with an approved noncombustible material that resists the free passage of flame and the products of combustion ~~[,]~~ and a ~~[listed]~~ fire damper is installed at each floor line.

Exception: Fire dampers are not required in ducts within individual residential dwelling units.

607.7 Flexible ducts and air connectors. Flexible ducts and air connectors shall not pass through any fire-resistance-rated assembly. Flexible air connectors shall not pass through any wall, floor or ceiling.

SECTION MC 608 AIR OUTLETS AND AIR INLETS

608.1 Air outlets. Air outlets shall comply with Sections 608.1.1 through 608.1.3.

608.1.1 General. Air supplied to any space shall not contain flammable vapors, flyings, or dust in quantities and concentrations that would introduce a hazardous condition.

608.1.2 Construction of air outlets. Air outlets shall be constructed of noncombustible material or a material that has a maximum ~~[smoke-developed]~~ smoke-developed index/rating of 50 and a maximum flame spread index/rating of 25.

608.1.3 Location of air outlets. The location of air outlets shall comply with the following requirements:

1. Air outlets shall be located at least 3 inches (~~[76]~~ 76.2 mm) above the floor.

Exception: Air outlets may be located less than 3 inches (~~[76]~~ 76.2 mm) above the floor where provisions have been made to prevent dirt and dust accumulations from entering the system.

2. Where located less than 7 feet (~~[2134]~~ 2133.6 mm) above the floor, outlet openings shall be protected by a grille or screen having openings through which a ½-inch (12.7 mm) sphere cannot pass.

3. Grilles may be located in floors provided they are installed so that they may be removed for cleaning purposes and provided they are constructed as follows:
 - 3.1. Grilles up to 3 square feet (0.2787 m²) in gross area shall be designed to support a concentrated live load of 250 pounds ([114] 113.4 kg) on any 4 square inches ([2580] 2580.6 mm²) of surface.
 - 3.2. Grilles over 3 square feet (0.2787 m²) in gross area shall be designed to support the same loads as the floor in the area where used.
 - 3.3. If located where they may be walked upon, the opening in grilles shall reject a ½-inch (12.7 mm) sphere.

608.2 Air inlets (return or exhaust or return and exhaust). Air inlets shall be constructed in accordance with Sections 608.2.1 through 608.2.3.

608.2.1 General. Air shall not be recirculated from any space in which flammable vapors, flyings, or dust is present in quantities and concentrations that would introduce a hazardous condition into the return air system.

608.2.2 Construction of air inlets. Air inlets shall be constructed of noncombustible material or a material that has a maximum flame spread index/rating of 25 and a maximum smoke-developed index/rating of 50.

608.2.3 Location of air inlets. The location of air inlets shall comply with the following requirements.

1. Air inlets shall be located at least 3 inches ([76] 76.2 mm) above the floor.

Exception: Air inlets may be located less than 3 inches ([76] 76.2 mm) above the floor where provisions have been made to prevent dirt and dust accumulations from entering the system.

2. Where located less than 7 feet ([2134] 2133.6 mm) above the floor, inlet openings shall be protected by a grille or screens having openings through which a ½-inch (12.7 mm) sphere cannot pass.
3. Grilles may be located in floors provided they are installed so that they may be removed for cleaning purposes and provided they are constructed as follows:
 - 3.1. Grilles up to 3 square feet (0.2787 m²) in gross area shall be designed to support a concentrated live load of 250 pounds ([114] 113.4 kg) on any 4 square inches ([2580] 2580.6 mm²) of surface.
 - 3.2. Grilles over 3 square feet (0.2787 m²) in gross area shall be designed to support the same loads as the floor in the area where used.
 - 3.3. If located where they may be walked upon, the opening in grilles shall reject a ½-inch (12.7 mm) sphere.

SECTION MC 609 SERVICE OPENINGS

609.1 General. Horizontal air ducts and plenums shall be provided with service openings to facilitate the removal of accumulations of dust and combustible materials. Service openings shall be located at approximately [~~20-foot~~] 20-foot (6096 mm) intervals along the air duct and at the base of each vertical riser.

Exceptions:

1. Removable air outlet or air inlet devices of adequate size shall be permitted in lieu of service openings.
2. Service openings shall not be required in supply ducts where the supply air has previously passed through an air filter, air cleaner, or water spray. Such air filters and air cleaners shall be properly maintained and replaced when needed.
3. Service openings shall not be required where all of the following conditions exist:
 - 3.1. The occupancy has no process producing combustible material such as dust, lint, or greasy vapors. Such occupancies include banks, office buildings, houses of worship, hotels, and health care facilities (but not kitchens, laundries, and manufacturing portions of such facilities).
 - 3.2. The air inlets are at least 7 feet (~~2134~~] 2133.6 mm) above the floor or are protected by corrosion-resistant metal screens of at least 14 mesh (0.07 inches) (1.8 mm) that are installed at the inlets so that they cannot draw papers, refuse, or other combustible solids into the return air duct.
 - 3.3. The minimum design velocity in the return duct for the particular occupancy is 1000 feet/minute (5.080 m/s).

§ 8. Chapter 7 of the New York city mechanical code, as amended by local law number

141 for the year 2013, is amended to read as follows:

CHAPTER 7 COMBUSTION, VENTILATION, AND DILUTION AIR

SECTION MC 701 GENERAL

701.1 Scope. The provisions of this chapter shall govern the requirements for combustion, ventilation, and dilution air for fuel-burning appliances other than gas-fired appliances. The requirements for combustion, ventilation, and dilution air for gas-fired appliances shall be in accordance with *the New York City Fuel Gas Code*.

701.2 Combustion, ventilation, and dilution air required. Every room or space containing fuel-burning appliances shall be provided with combustion, ventilation, and dilution air as required by

this code. Combustion, ventilation, and dilution air shall be provided in accordance with Section 702, 703, 704, 705, 706 or 707 [~~of this code~~]. Direct-vent appliances or equipment that do not draw combustion air from inside of the building are not required to be considered in the determination of the combustion and dilution air requirements and shall be installed in accordance with the equipment manufacturer's instructions and listing. Combustion air requirements shall be determined based on the simultaneous operation of all fuel-burning appliances drawing combustion, ventilation, and dilution air from the room or space. Combustion, ventilation, and dilution air shall be obtained solely from the outdoors for fuel-burning appliances with an input greater than 350,000 Btu/h (~~[1025]~~ 102.6 kW). The room or space containing fuel-burning appliances shall comply with the requirements of Sections C402.5.3 and R402.4.4, as applicable, of the *New York City Energy Conservation Code* and Section 1012 of this code.

701.3 Circulation of air. The equipment and appliances within every room containing fuel-burning appliances shall be installed so as to allow free circulation of air. Provisions shall be made to allow for the simultaneous operation of mechanical exhaust systems, fireplaces or other equipment and appliances operating in the same room or space from which combustion, ventilation, and dilution air is being drawn. Such provisions shall prevent the operation of such appliances, equipment and systems from affecting the supply of combustion, ventilation, and dilution air.

701.3.1 Makeup air for fuel-burning devices. Where exhaust fans are installed, makeup air shall be provided to replace the exhausted air. Calculations shall be provided on the construction documents to validate the use of the exhaust fan(s) and compliance with this chapter.

701.3.2 Ventilation air for fuel-burning devices. Where ventilation air is brought in by mechanical means for heat generation mitigation, provisions must be made for proper air balance to prevent a negative or positive pressure in the boiler and to discharge the ventilation air directly to the outside.

For the purposes of this chapter, an opening to a naturally ventilated crawl space or attic space shall be considered equivalent to an opening to the outdoors.

701.4.1 Crawl space. Where lower combustion air openings connect with crawl spaces, such spaces shall have unobstructed openings to the outdoors at least twice that required for the combustion air openings. The height of the crawl space shall comply with the requirements of the *New York City Building Code* and shall be without obstruction to the free flow of air.

701.4.2 Attic space. Where combustion air is obtained from an attic area, the attic ventilating openings shall not be subject to ice or snow blockage, and the attic shall have not less than 30 inches (762 mm) vertical clear height at its maximum point. Attic ventilation openings shall be sufficient to provide the required volume of combustion air and the attic ventilation required by the *New York City Building Code*. The combustion air openings shall be provided with a sleeve of not less than 0.019 inch (0.48 mm) (No.26 Gage) galvanized steel or other approved material extending from the appliance enclosure to at least 6 inches (~~[152]~~ 152.4 mm) above the top of the ceiling joists and insulation.

701.5 Prohibited sources. Openings and ducts shall not connect appliance enclosures with a space in which the operation of a fan will adversely affect the flow of the combustion, ventilation, and dilution air. Combustion, ventilation, and dilution air shall not be subject to ice or snow blockage. No combustion, ventilation, and dilution air inlet shall be less than 30 inches (762 mm) above grade. Combustion, ventilation, and dilution air shall not be obtained from a hazardous location, except where the fuel-fired appliances are located within the hazardous location and are installed in accordance with this code. Combustion, ventilation, and dilution air shall not be taken from a refrigeration machinery room, except where a refrigerant vapor detector system is installed to automatically shut off the combustion process in the event of refrigerant leakage. For structures in ~~[areas of special]~~ flood hazard areas, air shall be obtained from a location complying with the additional requirements of Appendix G of the *New York City Building Code*.

SECTION MC 702 INSIDE AIR

702.1 All air from indoors. Combustion, ventilation, and dilution air shall be permitted to be obtained entirely from the indoors in buildings that are not of unusually tight construction. In buildings of unusually tight construction, combustion air shall be obtained from the outdoors in accordance with Section 703, 705, 706 or 707.

702.2 Air from the same room or space. The room or space containing fuel-burning appliances shall be an unconfined space as defined in Section 202.

702.3 Air from adjacent spaces. Where the volume of the room in which the fuel-burning appliances are located does not comply with Section 702.2, additional inside combustion, ventilation, and dilution air shall be obtained by opening the room to adjacent spaces so that the combined volume of all communicating spaces meets the volumetric requirement of Section 702.2. Openings connecting the spaces shall comply with Sections 702.3.1, 702.3.2 and Figure A-1 of Appendix A ~~[of this code]~~.

702.3.1 Number and location of openings. Two openings shall be provided, one within 1 foot (~~[305]~~ 304.8 mm) of the ceiling of the room and one within 1 foot (~~[305]~~ 304.8 mm) of the floor.

702.3.2 Size of openings. The net free area of each opening, calculated in accordance with Section 708, shall be a minimum of 1 square inch per 1,000 Btu/h (2201 mm²/kW) of input rating of the fuel-burning appliances drawing combustion, ventilation, and dilution air from the communicating spaces and shall be not less than 100 square inches (64 516 mm²).

SECTION MC 703 OUTDOOR AIR

703.1 All air from the outdoors. Where all combustion, ventilation, and dilution air is to be provided by outdoor air, the required combustion, ventilation, and dilution air shall be obtained by direct opening by louver or a duct(s) from the boiler room to the outdoors. Openings connecting the room to the outdoor air shall comply with Sections 703.1.1 through ~~[703.1.4]~~ 703.1.2 of this code, and Figures ~~[A-2]~~ 304.6.1(1), ~~[A-3 and A-4]~~ 304.6.1(2), 304.6.1(3) and 304.6.2 of ~~[Appendix A of this code]~~ the *New York City Fuel Gas Code*. The size of the openings connecting the room to the outdoor

air supply shall also comply with any applicable rules of the New York City Department of Environmental Protection.

703.1.1 Two-permanent-openings method. Two permanent openings, one commencing within 12 inches (~~[305]~~ 304.8 mm) at the top and one commencing within 12 inches (~~[305]~~ 304.8 mm) of the bottom of the room, shall be provided. The openings shall communicate directly, or by ducts, with the outdoors or spaces that freely communicate with the outdoors as follows:

1. Where directly communicating with the outdoors, or where communicating with the outdoors through vertical ducts, each opening shall have a minimum free area of 1 square inch per 4,000 Btu/h (550 mm²/kW) of total input rating of all equipment in the room.
2. Where communicating with the outdoors through horizontal ducts, each opening shall have a minimum free area of not less than 1 square inch per 2,000 Btu/H (1100 mm²/kW) of total input rating of all equipment in the room.

703.1.2 One-permanent-opening method. One permanent opening, commencing within 12 inches (~~[305]~~ 304.8 mm) of the top of the enclosure, shall be provided. The equipment shall have clearances of at least 1 inch (~~[25]~~ 25.4 mm) from the sides and back and 6 inches (~~[152]~~ 152.4 mm) from the front of the appliance. The opening shall directly communicate with the outdoors or through a vertical or horizontal duct to the outdoors or spaces that freely communicate with the outdoors and shall have a minimum free area of 1 square inch per 3,000 Btu/h (734 mm²/kW) of the total input rating of all equipment located in the enclosure, and not less than the sum of the areas of all vent connectors in the space.

SECTION MC 704 COMBINED USE OF INSIDE AND OUTDOOR AIR (CONDITION 1)

704.1 Combination of air from inside and outdoors. This section shall apply only to appliances located in confined spaces in buildings not of unusually tight construction. Where the volumes of rooms and spaces are combined for the purpose of providing indoor combustion air, such rooms and spaces shall communicate through permanent openings in compliance with Sections 702.3.1 and 702.3.2. The required combustion, ventilation, and dilution air shall be obtained by opening the room to the outdoors using a combination of inside and outdoor air, prorated in accordance with Section 704.1.6. The ratio of interior spaces shall comply with Section 704.1.5. The number, location and ratios of openings connecting the space with the outdoor air shall comply with Sections 704.1.1 through 704.1.4.

704.1.1 Number and location of openings. At least two openings shall be provided, one within 1 foot (~~[305]~~ 304.8 mm) of the ceiling of the room and one within 1 foot (~~[305]~~ 304.8 mm) of the floor.

704.1.2 Ratio of direct openings. Where direct openings to the outdoors are provided in accordance with Section 703.1, the ratio of direct openings shall be the sum of the net free areas of both direct openings to the outdoors, divided by the sum of the required areas for both such openings as determined in accordance with Section 703.1.2.

704.1.3 Ratio of horizontal openings. Where openings connected to the outdoors through horizontal ducts are provided in accordance with Section 703.1, the ratio of horizontal openings shall be the sum of the net free areas of both such openings, divided by the sum of the required areas for both such openings as determined in accordance with Section 703.1.3.

704.1.4 Ratio of vertical openings. Where openings connected to the outdoors through vertical ducts are provided in accordance with Section 703.1, the ratio of vertical openings shall be the sum of the net free areas of both such openings, divided by the sum of the required areas for both such openings as determined in accordance with Section 703.1.4.

704.1.5 Ratio of interior spaces. The ratio of interior spaces shall be the available volume of all communicating spaces, divided by the required volume as determined in accordance with Sections 702.2 and 702.3.

704.1.6 Prorating of inside and outdoor air. In spaces that utilize a combination of inside and outdoor air, the sum of the ratios of all direct openings, horizontal openings, vertical openings and interior spaces shall equal or exceed 1.

SECTION MC 705 COMBINED USE OF INSIDE AND OUTDOOR AIR (CONDITION 2)

705.1 General. This section shall apply only to appliances located in unconfined spaces in buildings of unusually tight construction. Combustion air supplied by a combined use of indoor and outdoor air shall be supplied through openings and ducts extending to the appliance room or to the vicinity of the appliance.

705.1.1 Openings and supply ducts. Openings shall be provided, located and sized in accordance with Sections 702.3.1 and 702.3.2; additionally, there shall be one opening to the outdoors having a free area of at least 1 square inch per 5,000 Btu/h (440 mm²/kW) of total input of all appliances in the space.

SECTION MC 706 MECHANICAL COMBUSTION AIR SUPPLY

706.1 Rate of air supplied. Where all combustion air is provided by a mechanical air supply system, the combustion air shall be supplied from the outdoors at a rate of not less than 0.35 cubic feet per minute per 1,000 Btu/h (0.034 m³/min per kW) of total input rating for all the fuel-burning appliances located within the space. Combustion air rates shall also comply with any applicable rules of the New York City Department of Environmental Protection. The mechanical air supply shall be sufficient to accommodate combustion air, ventilation air, and dilution air requirements of the installation.

706.1.1 Appliance interlock. Each of the appliances served shall be interlocked with the mechanical air supply system to prevent main burner operation when the mechanical air supply system is not in operation. The air flow and the damper operation shall be proven prior to burner operation.

SECTION MC 707 DIRECT CONNECTION

707.1 General. Fuel-burning appliances that are listed and labeled for direct combustion air connection to the outdoors shall be installed in accordance with the manufacturer's ~~[installation]~~ instructions.

SECTION MC 708 COMBUSTION AIR DUCTS

708.1 General. Combustion air ducts shall comply with all of the following:

1. Be of galvanized steel complying with Chapter 6 or of equivalent corrosion-resistant material approved for this application.

Exception: Within dwelling units, unobstructed stud and joist spaces shall not be prohibited from conveying combustion air, provided that not more than one required fireblock is removed.

2. Have a minimum ~~[cross-sectional]~~ dimension of 3 inches (~~[76]~~ 76.2 mm) in all directions.
3. Terminate in an unobstructed space allowing free movement of combustion air to the appliances.
4. Have the same cross-sectional areas as the free area of the openings to which they connect.
5. Serve a single appliance enclosure.
6. Not serve both upper and lower combustion air openings where both such openings are used. The separation between ducts serving upper and lower combustion air openings shall be maintained to the source of combustion air.
7. Not be screened where terminating in an attic space.
8. Not slope downward toward the source of combustion air, where serving the upper required combustion air opening.
9. Be constructed so that the remaining space surrounding a chimney or chimney liner, installed within a masonry, metal or factory-built chimney cannot be used to supply combustion, ventilation and dilution air, except for direct vent appliances designed and installed in accordance with the equipment manufacturer's instructions and listing.

10. Be insulated in accordance with Section C402.5.3 of the *New York City Energy Conservation Code.*

SECTION MC 709 OPENING OBSTRUCTIONS

709.1 General. The required size of openings for combustion, ventilation, and dilution air shall be based on the net free area of each opening. The net free area of an opening shall be that specified by the manufacturer of the opening covering. In the absence of such information, openings covered with metal louvers shall be deemed to have a net free area of 60 percent of the area of the opening, and openings covered with wood louvers shall be deemed to have a net free area of 10 percent of the area of the opening. Louvers and grills shall be fixed in the open position.

Exception: Operable louvers shall be interlocked with the appliance so that they are proven to be in the full open position prior to main burner ignition and during main burner operation. Means shall be provided to prevent the main burner from igniting if the louvers fail to open during burner startup and to shut down the main burner if the louvers close during operation.

709.2 Dampered openings. Where the combustion air openings are provided with automatic, smoke or fire dampers, the dampers shall be electrically interlocked with the appliances served, so as to prevent operation of any appliance that draws combustion and dilution air from the room when any of the dampers are closed. Manually operated dampers shall not be installed in combustion air openings. The damper opening shall be proven prior to burner operation. Dampers shall be provided in accordance with Chapter 6.

709.3 Caution sign. A sign stating, "Louvers, dampers and/or ventilation openings must not be blocked or disabled." shall be permanently affixed, in clear view, and adjacent to the opening(s) within the room containing the equipment. The letters used on the sign shall be at least [~~1 inch~~] 1 inch (~~[25]~~ 25.4 mm) in height.

SECTION MC 710 OPENING LOCATION AND PROTECTION

710.1 General. Combustion air openings to the outdoors shall comply with the location and protection provisions applicable to outside air intake openings of Sections 401.5 and 401.6 [~~of this code~~].

§ 9. Chapter 8 of the New York city mechanical code, as amended by local law number 141 for the year 2013, and sections 804.1 and 804.2 as amended by local law number 51 for the year 2014, is amended to read as follows:

CHAPTER 8 CHIMNEYS AND VENTS

SECTION MC 801 GENERAL

801.1 Scope. This chapter shall govern the installation, maintenance, design, minimum safety requirements, repair and approval of factory-built chimneys, chimney liners, vents and connectors, and field-built chimneys and connectors for all [~~non-gas-fired~~] nongas-fired appliances. This chapter shall also govern the utilization of masonry chimneys. Gas-fired appliances shall be vented in

accordance with the *New York City Fuel Gas Code*. The construction, repair, maintenance and approval of masonry chimneys shall be regulated by the *New York City Building Code*. Venting systems shall be designed in accordance with this chapter and comply with the requirements of the *New York City Air Pollution Control Code*.

801.1.1 [Adjoining] Existing chimneys and vents. [Adjoining] Existing chimneys and vents shall ~~[be in accordance with]~~ comply with the requirements of Section 28-104.13 of the *New York City Administrative Code* and Sections 801.1.1.1 through 801.1.1.8 of this code.

801.1.1.1 Responsibility of owner of taller building. Whenever a building is erected, enlarged, or increased in height so that any portion of such building, except chimneys or vents, extends higher than the top of any ~~[previously constructed]~~ existing chimneys or vents within 100 feet (30 480 mm), the owner of such new or altered building shall have the responsibility of altering such chimneys or vents to make them conform with the requirements of this chapter. A chimney or vent that is no longer connected with a fireplace or combustion or other equipment for which a chimney or vent was required shall be exempt from this requirement. Such alterations shall be accomplished by one of the following means or a combination thereof:

1. Carry up the ~~[previously constructed]~~ existing chimneys or vents to the height required in this chapter.
2. Offset such chimneys or vents to a distance beyond that required in ~~[Chapter 5]~~ this chapter from the new or altered building provided that the new location of the outlet of the offset chimney or vent shall otherwise comply with the requirements of this chapter.

Such requirements shall not dispense with or modify any additional requirements that may be applicable pursuant to rules of the *New York City Department of Environmental Protection*.

801.1.1.1.1 Chimney and vent plan. Applications for a new or altered building shall include a chimney and vent plan submitted pursuant to Section 107.18 of the *New York City Building Code*.

801.1.1.2 Protection of draft. After the alteration of a chimney or vent as required by this section, it shall be the responsibility of the owner of the new or altered building to provide any mechanical equipment or devices necessary to maintain the proper draft in the equipment.

801.1.1.3 Written notification, plans and required documents. The owner of the new or altered building shall notify the owner of ~~[the]~~ any building that may require a chimney or vent to be altered. Notification, plans and required documents shall comply with the requirements of Sections 801.1.1.3.1 through 801.1.1.3.3. ~~[affected in writing at least 45 days before starting the work required and request written consent to do such work. Such notice shall be accompanied by plans indicating the manner in which the proposed alterations are to be made.]~~

801.1.1.3.1 First notice. Written notice in a form acceptable to the department shall be provided to the building owner not less than 60 days prior to a request for permit for construction on the new or altered building. Such notice shall include a request for access to determine the need to alter the existing chimney or vent and a description of such work. Notice shall be sent by regular mail and certified mail, return receipt requested. A copy of such return receipt shall be filed with the department.

801.1.1.3.2 Second notice. Written notice in a form acceptable to the department shall be provided to the building owner not more than 45 days following commencement of work after a permit has been issued for the new or altered building. Such notice shall include a request for access to determine the need to alter the existing chimney or vent and a description of such work. Notice shall be sent by regular mail and certified mail, return receipt requested. The second notice shall also be posted by a licensed process server at the public entrance of the building requiring a chimney or vent to be altered. A copy of such return receipt and proof of service by the licensed process server shall be filed with the department.

Exceptions:

1. A second notice shall not be required where an application to alter the affected chimney or vent has been filed with the department.
2. A second notice shall not be required where access is granted and conditions are observed that result in a determination that chimney or vent alteration is not required and a revised chimney and vent plan is submitted to the department.

801.1.1.3.3 Plans and required documentation for alteration work. Where access is granted and conditions are observed that result in a determination that chimney or vent alteration is required, plans for such alteration work shall be provided to the owner of the existing building and a request for written consent to submit construction documents and perform such work shall be made.

801.1.1.4 Approval. The [~~plans and method of~~] construction documents for the proposed chimney extension, alteration or relocation shall be [~~subject~~] submitted to the [~~approval of the commissioner~~] department pursuant to Section 28-104 of the *New York City Administrative Code*. No certificate of occupancy shall be issued for the new building pursuant to Section 28-118.23 of the *New York City Administrative Code* until the work associated with such construction documents for the proposed chimney extension, alteration or relocation has been signed-off by the department.

Exceptions:

1. A certificate of occupancy may be issued where access is granted and conditions are observed that result in a determination that chimney or vent alteration is not required and a revised chimney or vent plan is submitted pursuant to Section 107.18 of the *New York City Building Code* documenting such.

2. A certificate of occupancy may be issued in accordance with Section 28-118.23, Exception 2 of the *New York City Administrative Code*.

801.1.1.5 Refusal of consent. If consent is not granted by the owner of the [~~previously constructed~~] affected building to do the alteration work required by this section, such owner shall signify his or her refusal in writing to the owner of the new or altered building and to the commissioner; and the owner of the new or altered building having [~~submitted plans that conform to the requirements of this section,~~] provided the notices required by Section 801.1.1.3 shall thereupon be released from any responsibility for the proper operation of the equipment due to loss of draft and for any health hazard or nuisance that may occur as a result of the new or altered building. Such responsibilities shall then be assumed by the owner of the previously constructed building. Similarly, should such owner fail to grant consent within 45 days from the date of [~~written request~~] the second notice or fail to signify his or her refusal, he or she shall then assume all responsibilities as prescribed above.

801.1.1.6 Procedure. It shall be the obligation of the owner of the new or altered building to:

1. Prepare and submit a chimney and vent plan to the department pursuant to Section 107.18 of the *New York City Building Code*.
2. Provide required notification pursuant to Section 801.1.1.3 of this code.
3. Provide plans pursuant to Section 801.1.1.3.3 of this code.
4. Prepare and submit construction documents to the department pursuant to Section 28-104 of the *New York City Administrative Code* for the alteration of existing chimneys or vents which conform to the requirements of this chapter;
5. Obtain permit(s) for the proposed work in accordance with Section 28-105 of the *New York City Administrative Code*;
6. Schedule this work so as to create a minimum of disturbance to the occupants of the affected building;
- [2] 7. Provide such essential services as are normally supplied by the equipment while it is out of service;
- [3] 8. Where necessary, support such extended chimneys, vents and equipment from this building or to carry up such chimneys or vents within his or her building;
- [4] 9. Provide for the maintenance, repair, and/or replacement of such extensions and added equipment; [~~and~~]
- [5] 10. Make such alterations of the same material as the original chimney or vent so as to maintain the same quality and appearance, except where the owner of the chimney or vent shall give his or her consent to do otherwise. All work shall be done in such fashion as to maintain the architectural aesthetics of the existing building. Where

there is practical difficulty in complying strictly with the provisions of this item, the commissioner may permit an equally safe alternative[-];

11. Comply with the tenant protection plan requirements of Section 28-120 of the *New York City Administrative Code*; and

12. Comply with inspection and sign-off requirements of Section 28-116 of the *New York City Administrative Code*.

801.1.1.7 Existing violations. Any existing violations on the previously constructed equipment shall be corrected by the owner of the equipment before any equipment is added or alterations made at the expense of the owner of the new or altered building.

801.1.1.8 Variance. The commissioner may grant a variance in accordance with the provisions of this code.

801.2 General. Every fuel-burning appliance shall discharge the products of combustion to a vent, factory-built chimney or masonry chimney, except for appliances vented in accordance with Section 804. The chimney or vent shall be designed for the type of appliance being vented.

Exception: Commercial cooking appliances vented by a Type I hood installed in accordance with Section 507.

801.2.1 Design. Chimneys and vents shall be designed and constructed so as to provide the necessary draft and capacity for each appliance connected to completely exhaust the products of combustion to the outside air. The temperature on adjacent combustible surfaces shall not be raised above 160°F (~~[74]~~ 71.1°C). Chimneys and vents shall be designed to resist the effects of condensation that would cause deterioration of the chimney or vent.

801.2.2 Outlets. The outlet shall be arranged so that the flue gases are not directed so that they jeopardize people, overheat combustible structures, or enter building openings in the vicinity of the outlet.

801.2.3 Support. Chimneys and vents shall not be supported by the equipment they serve unless such equipment has been specifically designed for such loads.

801.2.4 Oil-fired appliances. Oil-fired appliances shall be vented in accordance with this code and NFPA 31.

801.2.5 Gas-fired appliances. Gas-fired appliances shall be vented in accordance with the *New York City Fuel Gas Code*.

801.3 Masonry chimneys. Masonry chimneys shall be constructed in accordance with the *New York City Building Code*.

801.4 Positive flow. Venting systems shall be designed and constructed so as to develop a positive flow adequate to convey all combustion products to the outside atmosphere.

801.5 Design. Venting systems shall be designed in accordance with this chapter and comply with the requirements of the *New York City Air Pollution Control Code*.

801.6 Minimum size of chimney or vent. Except as otherwise provided for in this chapter, the size of the chimney or vent, serving a single appliance, except engineered systems, shall have a minimum area equal to the area of the appliance connection.

801.7 Solid ~~[fuel]~~ fuel-burning appliance flues. The cross-sectional area of a flue serving a ~~[solid-fuel-burning]~~ solid fuel-burning appliance shall be not greater than three times the cross-sectional area of the appliance flue collar or flue outlet.

801.8 Abandoned inlet openings. Abandoned inlet openings in chimneys and vents shall be closed by an approved method, sealed air-tight and permanently labeled as abandoned.

801.9 Positive pressure. Where an appliance equipped with a forced or induced draft system creates a positive pressure in the venting system, the venting system shall be designed and listed for positive pressure applications.

801.10 Connection to fireplace. Connection of appliances to chimney flues serving fireplaces shall be in accordance with Sections 801.10.1 through 801.10.3.

801.10.1 Closure and access. A noncombustible seal shall be provided below the point of connection to prevent entry of room air into the flue. Means shall be provided for access to the flue for inspection and cleaning.

801.10.2 Connection to factory-built fireplace flue. An appliance shall not be connected to a flue serving a factory-built fireplace unless the appliance is specifically listed for such installation. The connection shall be made in accordance with the appliance manufacturer's ~~[installation]~~ instructions.

801.10.3 Connection to masonry fireplace flue. A connector shall extend from the appliance to the flue serving a masonry fireplace such that the flue gases are exhausted directly into the flue. The connector shall be provided with access or shall be removable for inspection and cleaning of both the connector and the flue. Listed direct connection devices shall be installed in accordance with their listing.

801.11 Multiple solid ~~[fuel]~~ fuel-burning appliances prohibited. A solid fuel-burning appliance or fireplace shall not connect to a chimney ~~[passage-way]~~ passageway venting another appliance.

801.12 Chimney entrance. Connectors shall connect to a chimney flue at a point not less than 12 inches (~~[305]~~ 304.8 mm) above the lowest portion of the interior of the chimney flue.

801.13 Cleanouts. Factory-built chimneys and vents shall be provided with a cleanout opening or access door at the base of the chimney or vent installed in accordance with the manufacturer's instructions. Masonry ~~[chimney flues]~~ and metal chimneys shall be provided with a cleanout opening having a minimum height of 6 inches (~~[152]~~ 152.4 mm). The upper edge of the opening shall be located not less than 6 inches (~~[152]~~ 152.4 mm) below the lowest chimney inlet opening. The cleanout shall be provided with a tight-fitting, noncombustible cover of a minimum size

of 8 inches by 8 inches (~~[203]~~ 203.2 mm by ~~[203]~~ 203.2 mm). Cleanouts shall comply with the requirements of the *New York City Air Pollution Control Code*.

Exception: Cleanouts shall not be required for chimney flues serving masonry fireplaces, if such flues are provided with access through the fireplace opening.

801.14 Connections to exhauster. ~~[All appliance]~~ Appliance connections to a chimney or vent equipped with a power exhauster shall be made on the inlet side of the exhauster. ~~[All joints]~~ Joints and piping on the positive pressure side of the exhauster shall be listed for positive pressure applications as specified by the manufacturer's ~~[installation]~~ instructions for the exhauster or in accordance with this code.

801.15 Fuel-fired appliances. Masonry chimneys utilized to vent fuel-fired appliances shall be located, constructed and sized as specified in the manufacturer's ~~[installation]~~ instructions for the appliances being vented.

801.16 Flue lining. Masonry chimneys shall be lined. The lining material shall be compatible with the type of appliance connected, in accordance with the appliance listing and manufacturer's ~~[installation]~~ instructions. Listed materials used as flue linings shall be installed in accordance with their listings and the manufacturer's ~~[installation]~~ instructions.

801.16.1 Residential and low-heat appliances (general). Flue lining systems for use with residential-type and low-heat appliances shall be limited to the following:

1. Clay flue lining complying with the requirements of ASTM C 315 or equivalent. Clay flue lining shall be installed in accordance with the *New York City Building Code*.
2. Listed and labeled chimney lining systems complying with UL 1777 (new and existing chimneys) or ULC-S635 (existing chimneys) or ULC-S640 (new chimneys).
3. Other approved materials that will resist, without cracking, softening or corrosion, flue gases and condensate at temperatures up to 1,800°F (~~[982]~~ 982.2°C).
4. Existing firebrick chimneys may be used to vent appliances if the firebrick is acid resistant and lab tested. The brick and mortar must be inspected in accordance with Section 1705.32 of the *New York City Building Code*.

801.17 Space around lining. The space surrounding a flue lining system or other vent installed within a masonry chimney shall not be used to vent any other appliance. This shall not prevent the installation of a separate flue lining in accordance with the manufacturer's ~~[installation]~~ instructions and this code.

801.18 Existing chimneys and vents. Where an appliance is permanently disconnected from an existing chimney or vent, or where an appliance is connected to an existing chimney or vent during the process of a new installation, the chimney or vent shall comply with Sections 801.18.1 through 801.18.4.

801.18.1 Size. The chimney or vent shall be resized as necessary to control flue gas condensation in the interior of the chimney or vent and to provide the appliance or appliances served with the

required draft. For the venting of oil-fired appliances to masonry chimneys, the resizing shall be in accordance with NFPA 31.

801.18.2 Flue passageways. The flue gas passageway shall be free of obstructions and combustible deposits and shall be cleaned if previously used for venting a solid or liquid fuel-burning appliance or fireplace. The flue liner, chimney inner wall or vent [~~inner wall~~] inner wall shall be continuous and shall be free of cracks, gaps, perforations or other damage or deterioration which would allow the escape of combustion products, including gases, moisture and creosote. Where an oil-fired appliance is connected to an existing masonry chimney, such chimney flue shall be repaired or relined in accordance with NFPA 31.

801.18.3 Cleanout. Masonry chimneys shall be provided with a cleanout opening complying with Section 801.13.

801.18.4 Clearances. Chimneys and vents shall have [~~air space~~] airspace clearance to combustibles in accordance with the *New York City Building Code* and the chimney or vent manufacturer's [~~installation~~] instructions.

Exception: Masonry chimneys without the required airspace clearances shall be permitted to be used if lined or relined with a chimney lining system listed for use in chimneys with reduced clearances in accordance with UL 1777 or ULC-S635. The chimney clearance shall be not less than permitted by the terms of the chimney liner listing and the manufacturer's instructions.

801.18.4.1 Fireblocking. Noncombustible fireblocking shall be provided in accordance with the *New York City Building Code*.

801.19 Multistory prohibited. Common venting systems for appliances located on more than one floor level shall be prohibited.

801.20 Reserved.

801.21 Termination requirements. Terminations shall comply with the appliance listing and manufacturer's instructions, and the following:

1. Chimneys, vents and flues serving appliances or fireplaces with outlet temperatures less than 600°F ([346] 315.6°C) shall extend at least 3 feet ([914] 914.4 mm) above the highest construction, such as a roof ridge, parapet wall or penthouse [~~, but~~] within 10 feet (3048 mm) of the chimney vent or flue outlet, whether the construction is on the same building as the chimney or on another building. Any [~~chimney~~] chimneys, vents or flues located in an area that is more than 10 feet (3048 mm) from such construction, but not more than the distance determined by Equation 8-1, shall be at least as high as the highest construction in such area. For purposes of determining the required height of a chimney, such construction shall not include other chimneys, vents or open structural framing.

2. Chimneys serving appliances or fireplaces with outlet temperatures between 600°F ([316] 315.6°C) and 1000°F ([538] 537.8°C) shall extend at least 10 feet (3048 mm) above the highest construction, such as a roof ridge, or parapet wall or penthouse within 20 feet (6096 mm) of the chimney outlet, whether the construction is on the same building as the chimney or on another building. Any ~~[chimney]~~ chimneys located in an area more than 20 feet (6096 mm) from such construction, but not more than the distance determined from Equation 8-1, shall be at least as high as the highest construction in such area. For purposes of determining the required height of the chimney, such construction does not include other chimneys, vents or open structural framing.
3. Chimneys serving appliances or fireplaces with outlet temperatures greater than 1000°F ([538] 537.8°C) shall extend at least 20 feet (6096 mm) above the highest construction, such as roof ridge, parapet wall, penthouse, or other obstruction within 50 feet (15 240 mm) of the chimney outlet, whether the construction is on the same building as the chimney or in another building. Any ~~[chimney;]~~ chimneys located in an area that is more than 50 feet (15 240 mm) from such construction, but not more than the distance determined from Equation 8-1, shall be at least as high as the highest construction located in such area. For purposes of determining the required height of the chimney, such construction does not include other chimneys, vents, or open structural framing.
4. ~~[Reserved.]~~ Termination caps shall not be permitted. A drain shall be installed in accordance with Section 801.22. A positive means shall be provided to prevent water from entering the appliance.

Exception: Termination caps shall be permitted on listed factory-built chimneys unless otherwise prohibited by the *New York City Air Pollution Control Code*.

5. Decorative shrouds shall not be installed at the termination of factory-built chimneys except where such shrouds are listed and labeled for use with the specific factory-built chimney system and are installed in accordance with the manufacturers' instructions.
6. The following formula shall be used in order to determine the distance referred to in Items 1, 2 and 3 of this section:

$$D = F \times \sqrt{A} \qquad \qquad \qquad \text{(Equation 8-1)}$$

where:

D = Distance, in feet, measured from the center of the chimney, vent or flue outlet to the nearest edge of the construction. If a single chimney is divided into multiple smaller flues or chimneys, measure from the center of the chimney outlet that is closest to the nearest edge of the construction.

F = Value determined from Table ~~[801-20]~~ 801.21.

A = Free area, in square inches, of chimney flue space outlet. If a single chimney is divided into multiple smaller flues or chimneys, the total aggregate free area of such flue and chimney outlets shall be used to calculate "A".

TABLE [801.20] 801.21
“F” FACTOR FOR DETERMINING CHIMNEY DISTANCES

TYPE OF FUEL	“F” FACTOR		
	600°F ([316] 315.6°C) and less	600°F ([316] 315.6°C) to 1000°F ([538] 537.8°C)	Greater than 1000°F ([538] 537.8°C)
No. 2 Fuel Oil	2.5	2.5	3
No. 4, 6 Fuel Oil, Solid Fuels	3	3	3

[801.21] 801.22 Drains. A drain shall be provided for all chimneys and gas vents to remove rain water and condensation. The drain shall ~~be a minimum of~~ be not less than 1 inch (~~[25]~~ 25.4 mm) in ~~[size]~~ diameter and shall be equipped with an appropriately-sized p-trap with automatic trap seal primer in accordance with Section 1002 of the *New York City Plumbing Code* or a float drain trap installed in accordance with the manufacturer’s ~~[installation]~~ requirements. The drain shall be sized by the design engineer and shall be suitable for the chimney area. For listed chimneys and gas vents, the connection tap into the chimney shall be determined by the manufacturer and connected to the drain piping in accordance with the listing and installation instructions. On all outdoor chimneys and gas vents, the connection and drain shall be installed indoors as close as practicable to the chimney base to prevent freezing.

801.23 Draft controls. The installation of draft controls shall comply with Sections 801.23.1 through 801.23.5.

801.23.1 Draft control devices. Where a draft control device is part of the appliance or is supplied by the appliance manufacturer, it shall be installed in accordance with the manufacturers’ instructions. In the absence of manufacturers’ instructions, the device shall be attached to the flue collar of the appliance or as near to the appliance as practical.

801.23.2 Additional devices. Appliances requiring a controlled chimney draft shall be permitted to be equipped with a listed barometric draft regulator or automatic damper installed and adjusted in accordance with the manufacturers’ instructions. Automatic dampers shall be installed in accordance with Section 803.6.

[801.22] 801.23.3 Thermal safety (spill) switches. Thermal safety (spill) switches shall be installed on barometric ~~[dampers, draft hoods, draft diverters,]~~ draft regulators and all other ~~[appurtenances]~~ appurtenances that allow dilution air into chimneys or ~~[gas]~~ vents. Thermal safety (spill) switches shall be interlocked with all of the appliances connected to the same chimney or ~~[gas]~~ vent.

801.23.4 Location. Barometric draft regulators shall be installed in the same room or enclosure as the appliance in such a manner as to prevent any difference in pressure between the regulator and the combustion air supply.

801.23.5 Positioning. Barometric draft regulators shall be installed in the position for which they were designed with reference to the horizontal and vertical planes and shall be located so that the relief opening is not obstructed by any part of the appliance, adjacent construction or installation hardware.

801.24 Obstructions. Devices or items that protrude into, impede or restrict the flow of vent gases shall not be installed in a vent connector, chimney, or vent.

801.25 Outdoor chimneys and vents. Outdoor portions of chimneys or vents shall be provided with integral R-8 insulation or be provided with an R-8 insulation enclosure, where exposed to the outdoors for more than 5 feet (1524 mm).

**SECTION MC 802
VENTS**

802.1 General. ~~[All vent]~~ Vent systems shall be listed and labeled or field fabricated in accordance with NFPA 211. Type L vents shall be tested in accordance with UL 641.

802.2 Vent application. The application of vents shall be in accordance with Table 802.2.

**TABLE 802.2
VENT APPLICATION**

VENT TYPES	APPLIANCE TYPES
Type L oil vents	Oil-burning appliances listed and labeled for venting with Type L vents; gas appliances listed and labeled for venting with Type B vents.

802.3 Installation. Vent systems shall be sized, installed and terminated in accordance with the vent and appliance manufacturer's ~~[installation]~~ instructions.

802.4 Vent termination caps. Vent termination caps shall not be permitted and a drain installed to receive condensed or rain water shall be required. A positive means, such as offsets, shall be provided to prevent water from entering the appliance.

Exception: Termination caps shall be permitted on listed factory-built chimneys unless otherwise prohibited by the *New York City Air Pollution Control Code*.

802.5 Type L vent terminations. Type L vents shall terminate in accordance with Section ~~[801.20]~~ 801.21.

802.6 Minimum vent heights. Vents shall terminate not less than 5 feet (1524 mm) in vertical height above the highest connected appliance flue collar.

Exceptions:

1. Venting systems of direct vent appliances shall be installed in accordance with the appliance and the vent manufacturer's instructions.
2. Appliances listed for outdoor installations incorporating integral venting means shall be installed in accordance with their listings and the manufacturer's ~~installation~~ instructions.

802.7 Support of vents. All portions of vents shall be installed in accordance with the manufacturer's ~~listing and installation~~ instructions and shall be adequately supported for the design and weight of the materials employed.

802.8 Insulation shield. Where vents pass through insulated assemblies, an insulation shield constructed of not less than No. 26 ~~Gage~~ gage sheet metal shall be installed to provide clearance between the vent and the insulation material. The clearance shall be not less than the clearance to combustibles specified by the vent manufacturer's ~~installation~~ instructions. Where vents pass through attic space, the shield shall terminate not less than 2 inches (~~54~~ 50.8 mm) above the insulation materials and shall be secured in place to prevent displacement. Insulation shields provided as part of a listed vent system shall be installed in accordance with the manufacturer's ~~installation~~ instructions.

802.9 Door swing. Appliance and equipment vent terminals shall be located such that doors cannot swing within 12 inches (304.8 mm) horizontally of the vent terminals. Doorstops or closers shall not be installed to obtain this clearance.

SECTION MC 803 CONNECTORS

803.1 Connectors required. Connectors shall be used to connect appliances to the vertical chimney or vent, except where the chimney or vent is attached directly to the appliance.

803.2 Location. Connectors shall be located entirely within the room in which the connecting appliance is located, except as provided for in Section 803.10.4. Where passing through an unheated space, a connector shall not be constructed of ~~single-wall~~ single-wall pipe.

803.3 Size. The connector shall not be smaller than the size of the flue collar supplied by the manufacturer of the appliance. Where the appliance has more than one flue outlet, and in the absence of the manufacturer's specific instructions, the connector area shall be not less than the combined area of the flue outlets for which it acts as a common connector.

803.4 Branch connections. ~~All branch~~ Branch connections to the vent connector shall be made in accordance with the vent manufacturer's instructions.

803.5 Manual dampers. Manual dampers shall not be installed in connectors except in chimney connectors serving solid fuel-burning appliances.

803.6 Automatic dampers. ~~Automatic~~ Automatically operated dampers shall be ~~listed and labeled in accordance with UL-17 for oil fired heating appliances.~~ equipped with safety controls and shall

be of a listed type. Such safety controls shall be capable of demonstrating operation of the damper and appropriate draft before appliance operation. The automatically operated dampers shall be installed in accordance with the manufacturer's [installation] instructions. An automatic vent damper device shall not be installed on an existing appliance unless the appliance is listed and labeled and the device is installed in accordance with the terms of its listing. The name of the installer and date of installation shall be marked on a label affixed to the damper device.

803.7 Connectors serving two or more appliances. Where two or more connectors enter a common vent or chimney, the smaller connector shall enter at the highest level consistent with available headroom or clearance to combustible material.

803.8 Vent connector construction. A vent connector for a nonresidential, low-heat appliance shall be a factory-built chimney section or steel pipe having resistance to heat and corrosion equivalent to that for the appropriate galvanized pipe as specified in Table 803.8. Factory-built chimney sections shall be joined together in accordance with the chimney manufacturer's instructions.

**TABLE 803.8
MINIMUM THICKNESS FOR GALVANIZED STEEL VENT
CONNECTORS FOR LOW-HEAT APPLIANCES**

DIAMETER OF CONNECTOR (inches)	MINIMUM THICKNESS (inch)
Less than 6	0.019 (No. 28 gage)
6 to less than 10	0.023 (No. 26 gage)
10 to 12 inclusive	0.029 (No. 24 gage)
14 to 16 inclusive	0.034 (No. 22 gage)
Over 16	0.056 (No. 16 gage)

For SI: 1 inch = 25.4 mm.

803.9 Chimney connector construction. Chimney connectors for low-heat appliances shall be of sheet steel pipe having resistance to corrosion and heat not less than that of galvanized steel specified in Table 803.9(1). Connectors for medium-heat appliances and high-heat appliances shall be of sheet steel not less than the thickness specified in Table 803.9(2).

**TABLE 803.9(1)
MINIMUM CHIMNEY CONNECTOR THICKNESS FOR LOW-HEAT
APPLIANCES**

DIAMETER OF CONNECTOR (inches)	MINIMUM NOMINAL THICKNESS (galvanized) (inches)
5 and smaller	0.022 (No. 26 [Gage] gage)
Larger than 5 and up to 10	0.028 (No. 24 [Gage] gage)
Larger than 10 and up to 16	0.034 (No. 22 [Gage] gage)

TABLE 803.9(1)
MINIMUM CHIMNEY CONNECTOR THICKNESS FOR LOW-HEAT
APPLIANCES

DIAMETER OF CONNECTOR (inches)	MINIMUM NOMINAL THICKNESS (galvanized) (inches)
Larger than 16	0.064 (No. 16 [Gage] <u>gage</u>)

For SI: 1 inch = 25.4 mm.

TABLE 803.9(2)
MINIMUM CHIMNEY CONNECTOR THICKNESS FOR MEDIUM- AND HIGH-HEAT
APPLIANCES

AREA (square inches)	EQUIVALENT ROUND DIAMETER (inches)	MINIMUM [NOMINAL] THICKNESS (inches)
0-154	0-14	0.0575 (No. 16 [Gage] <u>gage</u>)
155-201	15-16	0.075 (No. 14 [Gage] <u>gage</u>)
202-254	17-18	0.0994 (No. 12 [Gage] <u>gage</u>)
Greater than 254	Greater than 18	0.1292 (No. 10 [Gage] <u>gage</u>)

For SI: 1 inch = 25.4 mm, 1 square inch = 645.16 mm².

803.10 Installation. Connectors shall be installed in accordance with Sections 803.10.1 through 803.10.6.

803.10.1 Supports and joints. Connectors shall be supported in an approved manner, and overlapping joints shall be tight-fitting and fastened with sheet metal screws, rivets, welds or other approved means.

803.10.2 Length. The maximum horizontal length of a single-wall connector shall not affect the capability of the system to produce adequate draft.

803.10.3 Connection. The connector shall extend to the inner face of the chimney or vent liner, but not beyond. A connector entering a masonry chimney shall be cemented to masonry in an approved manner. Where thimbles are installed to facilitate removal of the connector from the masonry chimney, the thimble shall be permanently cemented in place with high-temperature cement.

803.10.4 Connector pass-through. Chimney connectors shall not pass through any floor or ceiling, nor through a fire-resistance-rated wall assembly. Chimney connectors for domestic-type appliances shall not pass through walls or partitions constructed of combustible material to reach a [~~masonry~~] chimney [~~unless~~] or vent, except where such chimney connector complies with Section 803.10.4.1 or 803.10.4.2.

803.10.4.1 Manufactured insulated chimney connectors. Manufactured insulated chimney connectors for domestic-type appliances that pass through walls or partitions of combustible construction must comply with the following:

1. The connector is labeled for wall pass-through and is installed in accordance with the manufacturer's instructions; or
2. The connector is put through a device labeled for wall pass-through; or
3. The connector has a diameter not larger than 10 inches (254 mm) and is installed in accordance with one of the methods in Table 803.10.4. Concealed metal parts of the pass-through system in contact with flue gases shall be of stainless steel or equivalent material that resists corrosion, softening or cracking up to 1,800°F ([980] 982°C).

803.10.4.2 Field-applied insulation for chimney connectors. Chimney connectors of appliances with flue gas temperatures less than 500°F (260°C) that pass through walls or partitions of combustible construction shall be insulated with a field-applied flexible wrap assembly tested in accordance with either ASTM E2816 or ASTM E2336. The connector shall comply with all of the following:

1. The insulated vent connectors pass-through assemblies and through penetration assemblies shall be tested for F and T ratings in accordance with ASTM E 814. The F and T rating of the assembly shall be equal to or exceed the fire-resistance rating of the mechanical/boiler room.
2. Bracing and supports shall be of noncombustible material securely attached to the structure and designed to carry gravity and seismic loads within the stress limitations of Chapter 16 of the *New York City Building Code*. Bolts, screws, rivets and other mechanical fasteners shall not penetrate connector walls.
3. Insulated vent connector pass-through assemblies shall not pass through ceilings or floors.
4. Insulated vent connector pass-through assemblies shall not run through occupied spaces, corridors, sleeping rooms and spaces with hazardous materials.
5. Insulated vent connector pass-through assemblies material shall meet the requirements for minimum chimney connector thicknesses for medium and high-heat appliances in accordance with Table 803.9(2).
6. Insulated vent connector pass-through assemblies fittings shall be welded or shall be factory fabricated UL listed construction suitable for external flexible wrap insulation.
7. The draft calculations shall account for the insulating value of the field-applied flexible wrap insulation.

TABLE 803.10.4
CHIMNEY CONNECTOR SYSTEMS AND CLEARANCES
TO COMBUSTIBLE WALL MATERIALS FOR DOMESTIC HEATING
APPLIANCES^{A,B,C,D}

System A (12-inch clearance)	A 3.5-inch-thick brick wall shall be framed into the combustible wall. A 0.625-inch-thick fire-clay liner (ASTM C 315 or equivalent) ^e shall be firmly cemented in the center of the brick wall maintaining a 12-inch clearance to combustibles. The clay liner shall run from the outer surface of the bricks to the inner surface of the chimney liner.
System B (9-inch clearance)	A labeled solid-insulated factory-built chimney section (1-inch insulation) the same inside diameter as the connector shall be utilized. Sheet steel supports cut to maintain a 9-inch clearance to combustibles shall be fastened to the wall surface and to the chimney section. Fasteners shall not penetrate the chimney flue liner. The chimney length shall be flush with the masonry chimney liner and sealed to the masonry with water-insoluble refractory cement. Chimney manufacturers' parts shall be utilized to securely fasten the chimney connector to the chimney section.
System C (6-inch clearance)	A sheet metal (minimum [number] No. 24 [Gage] gage) ventilated thimble having a minimum thickness of 0.0236 inch (No. 24 gage) having two 1-inch air channels shall be installed. Steel supports shall be cut to maintain a 6-inch clearance with a sheet steel chimney connector between the thimble and combustibles. The chimney connector and steel supports shall have a minimum thickness of 0.0236 inch (No. 24 gage). One side of the support shall be fastened to the wall on all sides. Glass-fiber insulation shall fill the 6-inch space between the thimble and the supports.
System D (2-inch clearance)	A labeled solid-insulated factory-built chimney section (1-inch insulation) with a diameter 2 inches larger than the chimney connector shall be installed with a steel chimney connector having a minimum thickness of 0.0236 inch (No. 24 gage) [-]. Sheet steel supports shall be positioned to maintain a 2-inch clearance to combustibles and to hold the chimney connector to ensure that a 1-inch airspace surrounds the chimney connector through the chimney section. The steel support shall be fastened to the wall on all sides and the chimney section shall be fastened to the supports. Fasteners shall not penetrate the liner of the chimney section.

For SI: 1 inch = 25.4 mm, 1.0 Btu × in/ft² · h · °F = 0.144 W/m² · K.

- a. Insulation material that is part of the wall pass-through system shall be noncombustible and shall have a thermal conductivity of 1.0 Btu × in/ft² · h · °F or less.
- b. All clearances and thicknesses are minimums.
- c. Materials utilized to seal penetrations for the connector shall be non-combustible.
- d. Connectors for all systems except System B shall extend through the wall pass-through system to the inner face of the flue liner.
- e. ASTM C 315.

803.10.5 Pitch. Connectors shall rise vertically to the chimney or vent with a minimum pitch equal to one-fourth unit vertical in 12 units horizontal (2-percent slope).

803.10.6 Clearances. Connectors shall have a minimum clearance to combustibles in accordance with Table 803.10.6. The clearances specified in Table 803.10.6 apply, except where the listing and labeling of an appliance specifies a different clearance, in which case the labeled clearance shall apply. The clearance to combustibles for connectors shall be reduced only in accordance with Section 308 or via the use of a listed chimney or vent connector system.

**TABLE 803.10.6
CONNECTOR CLEARANCES TO COMBUSTIBLES**

TYPE OF APPLIANCE	MINIMUM CLEARANCE (inches)
Domestic-type appliances	
Chimney and vent connectors	
Electric and oil incinerators	18
Oil and solid fuel appliances <u>fuel-burning appliances</u>	18
Oil appliances labeled for venting with Type L vents	9
Commercial, industrial-type appliances	
Low-heat appliances	
Chimney connectors	
Oil and solid fuel boilers, furnaces and water heaters	18
Oil unit heaters	18
Other low-heat industrial appliances	18
Medium-heat appliances	
Chimney connectors	
All oil and solid fuel appliances <u>fuel-burning appliances</u>	36
High-heat appliances	
Masonry or metal connectors	In accordance with NFPA 211
All oil and solid fuel appliances <u>fuel-burning appliances</u>	

For SI: 1 inch = 25.4 mm.

SECTION MC 804
DIRECT-VENT, INTEGRAL VENT AND MECHANICAL DRAFT SYSTEMS

804.1 Direct-vent terminations. Vent terminals for direct-vent appliances shall be installed in accordance with the manufacturer's [~~installation~~] instructions. In addition, direct vent terminations shall comply with the following requirements:

1. Where located adjacent to walkways, the termination shall be not less than 7 feet (~~[2134]~~ 2133.6 mm) above the level of the walkway.
2. Vents shall terminate at least 3 feet (~~[914]~~ 914.4 mm) above any forced air inlet, other than the forced air inlet for the subject direct vent appliance, located within 10 feet (3048 mm).
3. The vent system shall terminate at least 4 feet (~~[1219]~~ 1219.2 mm) below, 4 feet (~~[1219]~~ 1219.2 mm) horizontally from or 1 foot (~~[305]~~ 304.8 mm) above any door, window or gravity air inlet into the building.
4. The vent termination point shall not be located closer than 3 feet (~~[914]~~ 914.4 mm) to an interior corner formed by two walls perpendicular to each other.
5. The vent termination shall not be mounted directly above or within 3 feet (~~[914]~~ 914.4 mm) horizontally from any gas or electric metering, regulating, venting relief equipment or other building opening.
6. The bottom of the vent termination shall be located at least ~~[24]~~ 36 inches (~~[610]~~ 914.4 mm) above finished grade.
7. The maximum heat input of an appliance served by single horizontal vent termination shall be 350,000 Btu/h (~~[1025]~~ 102.6 kW), unless otherwise approved by the commissioner.
8. The maximum heat input of all appliances served by horizontal vent terminations located within a 10 foot (3048 mm) radius shall be 350,000 Btu/h (~~[1025]~~ 102.6 kW), unless otherwise approved by the commissioner.
9. The vent termination shall be located a minimum of 4 feet (1219.2 mm) from the lot line or from adjacent buildings. The termination shall be installed in accordance with the vent manufacturer's [~~listing and installation~~] instructions.

804.2 Appliances with integral vents. Appliances incorporating integral venting means shall be installed in accordance with their listings and the manufacturer's [~~installation~~] instructions. In addition, integral vent terminals shall comply with the following requirements:

1. Where located adjacent to walkways, the vent terminal shall be not less than 7 feet (~~[2134]~~ 2133.6 mm) above the level of the walkway.
2. The vent terminal shall be at least 3 feet (~~[914]~~ 914.4 mm) above any forced air inlet, other than the forced air inlet for the subject integral vent appliance, located within 10 feet (3048 mm).

3. The vent terminal shall be at least 4 feet (~~[1219]~~ 1219.2 mm) below, 4 feet (~~[1219]~~ 1219.2 mm) horizontally from or 1 foot (~~[305]~~ 304.8 mm) above any door, window or gravity air inlet into the building.
4. The vent terminal shall not be located closer than 3 feet (~~[914]~~ 914.4 mm) to an interior corner formed by two walls perpendicular to each other.
5. The vent terminal shall not be mounted directly above or within 3 feet (~~[914]~~ 914.4 mm) horizontally from any gas or electric metering, regulating, venting relief equipment or other building opening.
6. The bottom of the vent terminal shall be located at least ~~[24]~~ 36 inches (~~[610]~~ 914.4 mm) above finished grade.
7. The maximum heat input of an appliance served by single horizontal vent terminal shall be 350,000 Btu/h (~~[1025]~~ 102.6 kW), unless otherwise approved by the commissioner.
8. The maximum heat input of all appliances served by horizontal vent terminals located within a 10 foot (3048 mm) radius shall be 350,000 Btu/h (~~[1025]~~ 102.6 kW), unless otherwise approved by the commissioner.
9. The vent terminal shall be located a minimum of 4 feet (1219.2 mm) from the lot line or from adjacent buildings. The termination shall be installed in accordance with the vent manufacturer's [~~listing and installation~~] instructions.

804.2.1 Reserved.

804.3 Mechanical draft systems. Mechanical draft systems of either forced or induced draft design shall be listed and labeled in accordance with UL 378 and shall comply with Sections 804.3.1 through 804.3.8.

804.3.1 Forced draft systems. Forced draft systems and all portions of induced draft systems under positive pressure during operation shall be designed and installed so as to be gas tight to prevent leakage of combustion products into a building.

804.3.2 Automatic shutoff. Power exhausters serving [~~automatically-fired~~] automatically fired appliances shall be electrically connected to each appliance to prevent operation of the appliance when the power exhauster is not in operation.

804.3.3 Termination. The termination of chimneys or vents equipped with power exhausters shall be located [~~a minimum of~~] not less than 10 feet (3048 mm) from the lot line or from adjacent buildings, unless otherwise approved by the [~~Commissioner~~] commissioner. The exhaust shall be directed vertically away from the building.

804.3.4 Horizontal terminations. Horizontal terminations [~~shall~~] and discharges, including any horizontal direct vent terminations subject to Section 804.1 and horizontal integral vent terminals subject to Section 804.2, shall not be permitted, unless otherwise authorized by the [~~Commissioner~~] commissioner.

804.3.5 Vertical terminations. Vertical terminations and discharges shall comply with Section ~~[801.20]~~ 801.21.

804.3.6 Exhauster connections. An appliance vented by natural draft shall not be connected into a vent, chimney or vent connector on the discharge side of a mechanical flue or power exhauster.

804.3.7 Exhauster sizing. Mechanical flue or power exhausters and the chimney or vent system served shall be sized and installed in accordance with the manufacturer's ~~[installation]~~ instructions.

804.3.8 Mechanical draft systems for manually fired appliances and fireplaces. A mechanical draft system shall be permitted to be used with manually fired appliances and fireplaces where such system complies with all of the following requirements:

1. The mechanical draft device shall be listed and labeled in accordance with UL 378, and shall be installed in accordance with the manufacturer's ~~[installation]~~ instructions.
2. A device shall be installed in the room with the appliance or fireplace that produces visible and audible warning upon failure of the mechanical draft device or loss of electrical power, at any time that the mechanical draft device is turned on. This device shall be equipped with a battery backup if it receives power from the building wiring.
3. A smoke detector or alarm, and a carbon monoxide detector or alarm, shall be installed in the room with the appliance or fireplace. This device shall be equipped with a battery backup if it receives power from the building wiring.

SECTION MC 805 FACTORY-BUILT CHIMNEYS

805.1 Listing. Factory-built chimneys shall be listed and labeled and shall be installed and terminated in accordance with this code and the manufacturer's ~~[installation]~~ instructions.

805.2 Solid ~~[fuel]~~ fuel-burning appliances. Factory-built chimneys installed in dwelling units with solid fuel-burning appliances shall comply with the Type HT requirements of UL 103 and shall be marked "Type HT" and "Residential Type and Building Heating Appliance Chimney."

Exceptions:

1. Chimneys for use with open combustion chamber fireplaces shall comply with the requirements of UL 103 and shall be marked "Residential Type and Building Heating Appliance Chimney."
2. Chimneys for use with open combustion chamber appliances installed in buildings other than dwelling units shall comply with the requirements of UL 103 and shall be marked "Building Heating Appliance Chimney" or "Residential Type and Building Heating Appliance Chimney."

805.3 ~~[Factory-built fireplaces.~~ Chimneys for use with factory-built fireplaces shall comply with the requirements of UL 127.] Factory-built chimney offsets. Where a factory-built chimney serving

a solid fuel-burning appliance or fireplace incorporates offsets, no part of the chimney shall be at an angle of more than 30 degrees (0.52 rad) from vertical at any point in the assembly and the chimney assembly shall not include more than four elbows.

Exception: Factory-built chimneys listed to UL103 Type HT serving a solid fuel-burning appliance or fireplace may offset at angles greater than 30 degrees from vertical if listed for such angles and installed in accordance with manufacturer's instructions. Cleanouts shall be installed in accordance with Section 801.13.

805.4 Support. Where factory-built chimneys are supported by structural members, such as joists and rafters, such members shall be designed to support the additional load.

805.5 Medium-heat appliances. Factory-built chimneys for medium-heat appliances producing flue gases having a temperature above 1,000°F ([538] 537.8°C), measured at the entrance to the chimney [7] shall comply with UL 959.

805.6 Decorative shrouds. Decorative shrouds shall not be installed at the termination of factory-built chimneys except where such shrouds are listed and labeled for use with the specific factory-built chimney system and are installed in accordance with Section 304.1.

805.7 Factory-built fireplaces. Chimneys for use with factory-built fireplaces shall comply with the requirements of UL 127.

SECTION MC 806 METAL CHIMNEYS

806.1 General. Metal chimneys shall be constructed and installed in accordance with NFPA 211.

806.2 Exterior metal chimneys. Exterior metal chimneys shall be stainless steel [~~or galvanized, painted on the exterior surface with a heat-resisting paint~~].

SECTION MC 807 CHANGES IN APPLIANCE FUELS

807.1 Changes in appliance fuels. Conversion of appliances from solid or liquid fuel to, or the addition of, natural gas shall be installed per the *New York City Fuel Gas Code*. Conversion from natural gas to, or the addition of, #2 fuel oil for a heating appliance shall be made only if:

1. The chimney design meets the requirements of this chapter for the conversion fuel, and the chimney is test run and smoke tested in accordance with Section 810.
2. The chimney is sized to provide adequate draft and vent the combustion products for the new fuel.
3. The chimney is thoroughly cleaned prior to the conversion to remove collected flue deposits.

**SECTION MC 808
REDUCTION OF FLUE SIZE**

808.1 Reduction of flue size. Conversion from one fuel to another or the use of an existing chimney to service a fireplace or wood-burning appliance may require a flue size change for proper operation. This may be done if the redesigned flue meets the criteria for the fuel and chimney type to be used as set forth in this chapter.

**SECTION MC 809
CHIMNEY SUPPORTED FROM EQUIPMENT**

809.1 Chimney support. Chimneys shall not be supported by the equipment they serve, unless such equipment has been specifically designed for such loads.

**SECTION MC 810
TEST RUN AND SMOKE TEST**

810.1 Test run. All new and altered chimneys, and chimneys to which a new appliance has been connected, shall be test run under operating conditions to demonstrate fire safety and the complete exhausting of smoke and the products of combustion to the outer air. The test run shall be conducted by a registered design professional or special inspector responsible for the test, and the results of such test run shall be certified as correct by such professional or special inspector and submitted in writing to the department. Refer to Section 1705.32 of the *New York City Building Code* for additional requirements.

810.2 Requirement of a smoke test. A smoke test shall be made as outlined in Section 810.3. Any faults or leaks found shall be corrected. Such smoke test shall be witnessed by a representative of the commissioner. In lieu thereof, the commissioner may accept the test report of a registered design professional or special inspector responsible for the test [~~which~~] that shall be submitted in writing to the department..

810.3 Smoke test. To determine the tightness of chimney construction, a smoke test shall be made in accordance with the following conditions and requirements:

1. The equipment, materials, power and labor necessary for such test shall be furnished by, and at the expense of, the owner or holder of the work permit.
2. If the test shows any evidence of leakage or other defects, such defects shall be corrected in accordance with the requirements of this chapter, and the test shall be repeated until the results are satisfactory.
3. The chimney shall be filled with a thick penetrating smoke produced by one or more smoke machines, or smoke bombs, or other equivalent method. As the smoke appears at the stack opening on the roof, such opening shall be tightly closed and a pressure equivalent to ½-inch (13 mm) column of water measured at the base of the stack, shall be applied. The test shall be applied for a length of time sufficient to permit the inspection of the chimney.

4. Refer to Section 1704.32 of the *New York City Building Code* for requirements for existing and new negative pressure chimneys and vents.

SECTION MC 811

EXHAUST GASES FROM INTERNAL COMBUSTION ENGINES AND TURBINES

811.1 Exhaust [pipe] system construction. The exhaust [pipe] system from internal combustion engines shall be constructed in accordance with NFPA 211, NFPA 37, and based on the temperature of the [gases] flue gas entering the exhaust [pipe] system, and in accordance with the following:

1. The exhaust [pipe] system, if factory [~~fabricated~~] built, shall be installed in accordance with its listing and manufacturer's instructions.
 - 1.1. Exhaust systems with flue gas temperatures greater than 300°F (148.9°C) shall be listed to UL 103 or UL 2561 and be rated for a minimum of 60 inch w.c. (14 934.3 Pa).
 - 1.2. Exhaust systems with flue gas temperatures not more than 300°F (148.9°C) and that are capable of causing excessive condensate production in the exhaust system shall be listed to UL 103 or UL 2561 and UL 1738 and be rated for a pressure suitable for the operating conditions.
2. The exhaust [pipe] system, if field fabricated, shall be constructed of at least ³/₁₆-inch ([~~5~~] 4.8 mm) steel, or of other equivalent metal of similar strength and resistance to the temperature and corrosive action of the exhaust gases. No lining shall be required.
3. Where the exhaust [pipe] system runs inside a building, it shall be insulated [~~with insulation adequate~~] adequately for the [~~temperature of the pipe~~] equipment operating temperature, so that the surface temperature shall be not more than 200°F ([~~93~~] 93.3°C).
4. Where the exhaust [pipe] system runs inside a building outside of the room containing the equipment, it shall be enclosed in fire-rated construction with a fire rating equal to the fire rating of the construction of the room.
5. All joints shall be constructed so as to be gas tight under all operating conditions and tested in accordance with Section 810.

811.2 Emergency and standby generator discharge opening termination requirements. The location of discharge [~~openings~~] outlets for emergency and standby internal combustion engines shall comply with the requirements of NFPA 37 so that the flue gases are not directed to jeopardize the health or safety of people, overheat combustible structures, nor enter building openings in the vicinity of the outlet, nor shall the location of such openings cause the condensate leaving the outlet to come into contact with people.

811.2.1 Interference. No discharge opening shall be located and constructed so as to interfere with the proper functioning of other openings in the same building or adjoining buildings, to interfere unreasonably with the occupants of the same building or adjoining buildings, or with the general public, or to create a fire or health hazard.

811.2.2 Chimneys. The exhaust pipe may be connected to a chimney used for other equipment, provided that the operation of the engine does not adversely affect the operation of the other equipment so that it is in violation of the *New York City Air Pollution Control Code*.

811.3 All other engine and turbine discharge opening termination requirements. The location of the discharge outlet from all other engines and turbines shall comply with the termination requirements of Section [801.20.2] 801.21, Item 2 or Section [801.20.3] 801.21, Item 3 based on the temperature of the [~~gases~~] flue gas entering the exhaust [~~pipe~~] system.

811.4 Chimneys. The exhaust system may be connected to a chimney used for other appliances, provided that the chimney complies with Section 811.1, Item 1 or Section 811.1, Item 2 and the operation of the engine does not adversely affect the operation of the other appliances and is in accordance with the *New York City Air Pollution Control Code*.

§ 10. Chapter 9 of the New York city mechanical code, as amended by local law 141 for the year 2013, section 901.3 of such chapter, as added by local law number 38 for the year 2015, and sections 901.4, 901.5, 901.6 and 901.7 of such chapter, as amended by local law number 141 for the year 2013 and renumbered by local law number 38 for the year 2015, is amended to read as follows:

CHAPTER 9

SPECIFIC APPLIANCES [~~, FIREPLACES, SOLID FUEL BURNING~~] AND EQUIPMENT [~~, AND NOISE CONTROL REQUIREMENTS~~]

SECTION MC 901 GENERAL

901.1 Scope. This chapter shall govern the approval, design, installation, construction, maintenance, alteration and repair of the appliances and equipment specifically identified herein and factory-built fireplaces. The approval, design, installation, construction, maintenance, alteration and repair of gas-fired appliances shall be regulated by the *New York City Fuel Gas Code*.

901.2 General. The requirements of this chapter shall apply to the mechanical equipment and appliances regulated by this chapter, in addition to the other requirements of this code, and installed in accordance with the requirements of NFPA 31, NFPA 54 and NFPA 211.

901.3 Solid fuel-burning fireplaces and appliances. All solid fuel-burning fireplaces and appliances shall be installed, altered and maintained in buildings in conformity with the applicable provisions of the *New York City Air Pollution Control Code* and no new solid fuel-burning fireplaces or appliances shall be permitted except those that burn the types of fuel allowed by such code.

901.4 Hazardous locations. Fireplaces and solid fuel-burning appliances shall not be installed in hazardous locations.

~~[901.5 Fireplace accessories. Listed fireplace accessories shall be installed in accordance with the conditions of the listing and the manufacturer's installation instructions.]~~

[901.6] 901.5 Inspection of solid fuel-burning heating appliances, chimneys and flues. Inspections of solid fuel-burning heating appliances, chimneys and flues shall be in accordance with the *New York City Building Code*.

[901.7] 901.6 Fireplaces. Fireplaces (solid-fuel-type or ANSI Z21.50) shall be installed with tight-fitting noncombustible fireplace doors to control infiltration losses in construction types listed here:

1. Masonry or factory-built fireplaces designed to allow an open burn.
2. Decorative appliances (ANSI Z21.60 gas-log style unit) installed in a vented solid fuel fireplace.
3. Vented decorative gas fireplace appliances (ANSI Z21.50 unit).

Fireplaces shall be provided with a source of combustion air as required by the fireplace construction provisions of the *New York City Building Code* and Chapter 7 of this code.

SECTION MC 902 MASONRY FIREPLACES

902.1 General. Masonry fireplaces shall be constructed in accordance with the *New York City Building Code*.

902.2 Fireplace accessories. Listed and labeled fireplace accessories shall be installed in accordance with the conditions of the listing and the manufacturer's instructions. Fireplace accessories shall comply with UL 907.

SECTION MC 903 FACTORY-BUILT FIREPLACES

903.1 General. Factory-built fireplaces shall be listed and labeled and shall be installed in accordance with the conditions of the listing. Factory-built fireplaces shall be tested in accordance with UL 127.

903.2 Hearth extensions. Hearth extensions of approved factory-built fireplaces [~~and fireplace stoves~~] shall be installed in accordance with the listing of the fireplace. The hearth extension shall be readily distinguishable from the surrounding floor area. Listed and labeled hearth extensions shall comply with UL 1618.

903.3 Unvented gas log heaters. The installation of unvented gas-fired space heaters, gas stoves, gas logs, gas fireplaces and gas fireplace inserts is prohibited.

903.4 Gasketed fireplace doors. A gasketed fireplace door shall not be installed on a factory-built fireplace except where the fireplace system has been specifically tested, listed and labeled for such use in accordance with UL 127.

903.5 Flues. Separate flues shall be provided for every fireplace and fireplace stove.

~~[903.5]~~ **903.6 Combustion air supply.** All installations of factory-built fireplaces shall comply with the requirements of the *New York City Energy Conservation Code* concerning combustion air supply.

SECTION MC 904 PELLET FUEL-BURNING APPLIANCES

904.1 General. Pellet fuel-burning appliances shall be listed and labeled in accordance with ASTM E 1509 and shall be installed in accordance with the terms of the listing. If permitted, such appliances shall be operated in accordance with the *New York City Air Pollution Control Code*.

SECTION MC 905 FIREPLACE STOVES AND ROOM HEATERS

905.1 General. Fireplace stoves and solid-fuel-type room heaters shall be listed and labeled and shall be installed in accordance with the conditions of the listing. Fireplace stoves shall be tested in accordance with UL 737. Solid-fuel-type room heaters shall be tested in accordance with UL 1482. Fireplace inserts intended for installation in fireplaces shall be listed and labeled in accordance with the requirements of UL 1482 and shall be installed in accordance with the manufacturer's ~~[installation]~~ instructions.

905.2 Connection to fireplace. The connection of solid fuel appliances to chimney flues serving fireplaces shall comply with Sections 801.7 and 801.10.

905.3 Hearth extensions. Hearth extensions for fireplace stoves shall be installed in accordance with the listing of the fireplace stove. The hearth extension shall be readily distinguishable from the surrounding floor area. Listed and labeled hearth extensions shall comply with UL 1618.

905.4 Air pollution. All fireplace stoves and room heaters shall comply with the requirements of the *New York City Air Pollution Control Code*.

~~[905.4]~~ **905.5 Combustion air supply.** All fireplace stoves and room heaters shall comply with the requirements of the *New York City Energy Conservation Code* concerning combustion air supply.

~~[905.5]~~ **905.6 Flues.** Separate flues and independent combustion air source shall be provided for every fireplace stove and room heater. Combustion air shall be provided in accordance with the manufacturer's recommendations and Chapter 7.

SECTION MC 906 FACTORY-BUILT BARBECUE APPLIANCES

906.1 General. Factory-built barbecue appliances shall be ~~[of an approved type]~~ listed and labeled for the use intended and shall be installed in accordance with the manufacturer's ~~[installation]~~ instructions, this chapter, ~~[Chapters 3, 5, 7, 8 of this code, and]~~ the *New York City Fuel Gas Code*, and Chapter 3, 5, 7, 8 of this code. ~~[All provisions for the construction and installation of fireplaces shall be complied within the construction and installation of barbecue grills.]~~ The construction and installation of chimneys serving barbeque appliances shall comply with all construction and installation requirements of fireplaces.

SECTION MC 907 INCINERATORS AND CREMATORIES

907.1 General. Incinerators and crematories shall be listed and labeled in accordance with UL 791 and NFPA 82 and shall be installed in accordance with the manufacturer's ~~[installation]~~ instructions.

907.2 Compliance. All incinerators and crematories shall be installed, altered and maintained in buildings in conformity with the applicable provisions of the *Administrative Code* and the *New York City Air Pollution Control Code*.

SECTION MC 908 COOLING TOWERS, EVAPORATIVE CONDENSERS AND FLUID COOLERS

908.1 General. A cooling tower used in conjunction with an air-conditioning appliance shall be installed in accordance with the manufacturer's ~~[installation]~~ instructions.

908.2 Access. Cooling towers, evaporative condensers and fluid coolers shall be provided with ready access.

908.3 Location. Cooling towers, evaporative condensers and fluid coolers shall be located to prevent the discharge vapor plumes from entering occupied spaces. Plume discharges shall be not less than 5 feet (1524 mm) above or 20 feet (6096 mm) away from any ventilation inlet to a building. Location on the property shall be as required for buildings in accordance with the *New York City Building Code*.

908.3.1 Indoor. Cooling towers, evaporative condensers and fluid coolers located inside of buildings shall be constructed of noncombustible materials including fill and drift eliminators.

908.3.2 Outside. Cooling towers shall be constructed of noncombustible materials.

Exceptions:

1. Fill and drift eliminators of limited combustible materials may be considered ~~[non-combustible]~~ noncombustible if the cooling towers are provided with automatic sprinkler protection in compliance with Chapter 9 of the *New York City Building Code*.
2. Fill and drift eliminators for any individual cooling tower cell may be made of limited combustible materials provided all the following conditions are met:
 - 2.1. The cooling tower is located on a building of construction Types IA or IB of the *New York City Building Code*.
 - 2.2. The cooling tower ~~[, fill and drift eliminators are]~~ cell is located at least 30 feet (9144 mm) away from windows or fresh air intakes which are at an elevation above the roof on which the cooling tower is located, whether in the same building or in an adjoining building.

- 2.3. The cooling tower cell is located not less than 15 feet (4572 mm) from the lot line.
- 2.4. The cooling tower cell is located not less than 10 feet (3048 mm) from any chimney, except that the distance shall not be less than 20 feet (6096 mm) from a chimney venting products of combustion other than from gas- or oil-fired appliances, whether on the same or an adjoining building.

908.4 Support and anchorage. Supports for cooling towers, evaporative condensers and fluid coolers shall be designed in accordance with the *New York City Building Code*. Seismic restraints shall be as required by the *New York City Building Code*. Adequate vibration isolation shall be provided in accordance with the manufacturer's ~~[installation]~~ guidelines and as required for the supporting structure, and in accordance with Sections ~~[928.3.7]~~ 313.3.7 and ~~[928.3.8]~~ 313.3.8.

908.5 Water supply. ~~[Water supplies]~~ Cooling towers, evaporative condensers and fluid coolers shall be provided with an approved water supply, sized for peak demand. The quality of water shall be provided in accordance with the equipment manufacturer's recommendations. The piping system and protection of the potable water supply system shall be installed as required by the *New York City Plumbing Code*.

908.6 Drainage. Drains, overflows and blowdown provisions shall be indirectly connected to an approved disposal location. Discharge of chemical waste shall be approved by the appropriate regulatory authority.

908.7 Refrigerants and hazardous fluids. Heat exchange equipment that contains a refrigerant and that is part of a closed refrigeration system shall comply with Chapter 11. Heat exchange equipment containing heat transfer fluids which are combustible or hazardous shall comply with the *New York City Fire Code*. Flammable heat transfer fluids are prohibited.

908.8 Cooling towers. Cooling towers, both open circuit and closed circuit type, and evaporative condensers shall comply with Sections 908.8.1 and 908.8.2.

908.8.1 Conductivity or flow-based control of cycles of concentration. Cooling towers and evaporative condensers shall include controls that automate system bleed based on conductivity, fraction of metered makeup volume, metered bleed volume, recirculating pump run time or bleed time.

908.8.2 Drift eliminators. Cooling towers and evaporative condensers shall be equipped with drift eliminators that have a maximum drift rate of 0.005 percent of the circulated water flow rate as established in the equipment's design specifications.

908.9 Additional requirements. The installation and maintenance of all cooling towers, evaporative condensers, and fluid coolers shall comply with the requirements of Article 317 of Chapter 3 of Title 1 of the *Administrative Code*.

SECTION MC 909 VENTED WALL FURNACES

909.1 General. Vented wall furnaces shall be installed in accordance with their listing and the manufacturer's [~~installation~~] instructions. Oil-fired furnaces shall be tested in accordance with UL 730.

909.2 Location. Vented wall furnaces shall be located so as not to cause a fire hazard to walls, floors, combustible furnishings or doors. Vented wall furnaces installed between bathrooms and adjoining rooms shall not circulate air from bathrooms to other parts of the building.

909.3 Door swing. Vented wall furnaces shall be located so that a door cannot swing within 12 inches (~~[305]~~ 304.8 mm) of an air inlet or air outlet of such furnace measured at right angles to the opening. Doorstops or door closers shall not be installed to obtain this clearance.

909.4 Ducts prohibited. Ducts shall not be attached to wall furnaces. Casing extension boots shall not be installed unless listed as part of the appliance.

909.5 Manual shutoff valve. A manual shutoff valve shall be installed ahead of all controls.

909.6 Access. Vented wall furnaces shall be provided with access for cleaning of heating surfaces, removal of burners, replacement of sections, motors, controls, filters and other working parts, and for adjustments and lubrication of parts requiring such attention. Panels, grilles and access doors that must be removed for normal servicing operations shall not be attached to the building construction.

SECTION MC 910 FLOOR FURNACES

910.1 General. Floor furnaces shall be installed in accordance with their listing and the manufacturer's [~~installation~~] instructions. Oil-fired furnaces shall be tested in accordance with UL 729. Unvented floor furnaces are prohibited.

910.2 Placement. Floor furnaces shall not be installed in any corridor, in the floor of any aisle or passageway of any auditorium, public hall, place of assembly, or in any egress element from any such room or space.

With the exception of wall register models, a floor furnace shall not be placed closer than 6 inches (~~[152]~~ 152.4 mm) to the nearest wall, and wall register models shall not be placed closer than 6 inches (~~[152]~~ 152.4 mm) to a corner.

The furnace shall be placed such that a drapery or similar combustible object will not be nearer than 12 inches (~~[305]~~ 304.8 mm) to any portion of the register of the furnace. Floor furnaces shall not be installed in concrete floor construction built on grade. The controlling thermostat for a floor furnace shall be located within the same room or space as the floor furnace or shall be located in an adjacent room or space that is permanently open to the room or space containing the floor furnace. Floor furnaces shall be located so as to be accessible. Floor furnaces shall be installed only in floors of noncombustible construction having at least a 2-hour fire rating, except as where required for one- and two-family dwellings.

910.3 Bracing. The floor around the furnace shall be braced and headed with a support framework design in accordance with the *New York City Building Code*.

910.4 Clearance. The lowest portion of the floor furnace shall have not less than a 6-inch ([152] 152.4 mm) clearance from the grade level; except where the lower 6-inch ([152] 152.4 mm) portion of the floor furnace is sealed by the manufacturer to prevent entrance of water, the minimum clearance shall be reduced to not less than 2 inches ([51] 50.8 mm). Where these clearances are not present, the ground below and to the sides shall be excavated to form a pit under the furnace so that the required clearance is provided beneath the lowest portion of the furnace. A 12-inch ([305] 304.8 mm) minimum clearance shall be provided on all sides except the control side, which shall have an 18-inch ([457] 457.2 mm) minimum clearance.

910.5 Enclosures. Enclosures of floor furnaces shall be constructed entirely of noncombustible materials with a fire-resistance rating of at least 1 hour and shall be provided with adequate outdoor air to ensure proper combustion. The enclosure shall be provided with adequate means of access for servicing the furnace.

910.6 Duct temperature. The outlet duct temperature of warm air heating furnaces shall not be greater than 250°F ([124] 121.1°C).

910.7 One- and two- family dwellings. Floor furnace enclosures shall be constructed of noncombustible materials with a fire-resistance rating of at least 1 hour. Means shall be provided for supporting the furnace when the grille is removed. Clearances shall be provided as per NFPA 54.

SECTION MC 911 DUCT FURNACES AND HEATERS

911.1 General. Duct furnaces and heaters shall be installed in accordance with the manufacturer's [~~installation~~] instructions. Electric furnaces and duct heaters shall [~~be tested in accordance~~] comply with UL 1995 or UL 1996, as applicable. Unvented fuel-fired duct furnaces are prohibited.

911.2 Access panels. Ducts connected to duct furnaces shall have removable access panels on both the upstream and downstream sides of the furnace.

911.3 Location of draft hood and controls. The controls, combustion air inlets and draft hoods for duct furnaces shall be located outside of the ducts. The draft hood shall be located in the same enclosure from which combustion air is taken.

911.4 Circulating air. Where a duct furnace is installed so that supply ducts convey air to areas outside the space containing the furnace, the return air shall also be conveyed by a duct(s) sealed to the furnace casing and terminating outside the space containing the furnace. The duct furnace shall be installed on the positive pressure side of the circulating air blower.

911.5 Duct temperature. The outlet duct temperature of duct furnaces shall not be greater than 250°F ([124] 121.1°C).

SECTION MC 912 INFRARED RADIANT HEATERS

912.1 General. Electric infrared radiant heaters shall comply with UL 499.

912.2 Support. Infrared radiant heaters shall be fixed in a position independent of fuel and electric supply lines. Hangers and brackets shall be noncombustible material.

~~912.2~~ **912.3 Clearances.** Heaters shall be installed with clearances from combustible material in accordance with the manufacturer's ~~installation~~ instructions.

SECTION MC 913 CLOTHES DRYERS

913.1 General. Clothes dryers shall be installed in accordance with the manufacturer's ~~installation~~ instructions~~[-]~~ and shall comply with the following as applicable:

1. Electric commercial clothes dryers shall be tested in accordance with UL 1240.
2. Electric residential ~~and~~ clothes dryers shall be tested in accordance with UL 2158.
3. Electric coin-, ticket-, or card-operated clothes dryers shall be tested in accordance with UL 2158.

913.2 Exhaust required. Clothes dryers shall be exhausted in accordance with Section 504.

Exception: Electric clothes dryers provided with a condensate drain. Spaces containing such dryers shall be provided with transfer air openings or other approved means to provide adequate air exchanges with adjacent spaces.

913.3 Clearances. Clothes dryers shall be installed with clearance to combustibles in accordance with the manufacturer's instructions.

SECTION MC 914 SAUNA HEATERS

914.1 Location and protection. Sauna heaters shall be located so as to minimize the possibility of accidental contact by a person in the room.

914.1.1 Guards. Sauna heaters shall be protected from accidental contact by an approved guard or barrier of material having a low coefficient of thermal conductivity. The guard shall not substantially affect the transfer of heat from the heater to the room.

914.2 Installation. Sauna heaters shall be listed and labeled in accordance with UL 875 and shall be installed in accordance with their listing and the manufacturer's ~~installation~~ instructions.

914.3 Access. Panels, grilles and access doors that are required to be removed for normal servicing operations shall not be attached to the building.

914.4 Heat and time controls. Sauna heaters shall be equipped with a thermostat that will limit room temperature to 194°F (90°C). If the thermostat is not an integral part of the sauna heater, the heat-sensing element shall be located within 6 inches (~~[152]~~ 152.4 mm) of the ceiling. If the heat-sensing element is a capillary tube and bulb, the assembly shall be attached to the wall or other support, and shall be protected against physical damage.

914.4.1 Timers. A timer, if provided to control main burner operation, shall have a maximum operating time of 1 hour. The control for the timer shall be located outside the sauna room.

914.5 Sauna room. A ventilation opening into the sauna room shall be provided. The opening shall be not less than 4 inches by 8 inches (~~[102]~~ 101.6 mm by ~~[203]~~ 203.2 mm) located near the top of the door into the sauna room.

914.5.1 Warning notice. The following permanent notice, constructed of approved material, shall be mechanically attached to the sauna room on the outside:

WARNING: DO NOT EXCEED 30 MINUTES IN SAUNA. EXCESSIVE EXPOSURE CAN BE HARMFUL TO HEALTH. ANY PERSON WITH POOR HEALTH SHOULD CONSULT A PHYSICIAN BEFORE USING SAUNA.

The words shall contrast with the background and the wording shall be in letters not less than ~~[0.25-inch]~~ ¼-inch (6.4 mm) high.

Exception: This section shall not apply to one- and two-family dwellings.

SECTION MC 915

ENGINE AND GAS TURBINE-POWERED EQUIPMENT AND APPLIANCES

915.1 General. The installation of liquid-fueled stationary internal combustion engines and gas turbines, including combustion air, exhaust, fuel storage and piping, shall meet the requirements of NFPA 37 and Chapters 7, 8, and 13 of this code. Stationary engine generator assemblies shall meet the requirements of UL 2200.

915.2 Powered equipment and appliances. Permanently installed equipment and appliances powered by internal combustion engines and turbines shall be installed in accordance with the manufacturer's ~~[installation]~~ instructions and NFPA 37.

SECTION MC 916

POOL AND SPA HEATERS

916.1 General. Pool and spa heaters shall be installed in accordance with the manufacturer's ~~[installation]~~ instructions. Oil-fired pool and spa heaters shall be tested in accordance with UL 726. Electric pool and spa heaters shall be tested in accordance with UL 1261.

SECTION MC 917

COOKING APPLIANCES

917.1 Cooking appliances. Cooking appliances that are designed for permanent installation, including ranges, ovens, stoves, broilers, grills, fryers ~~[;]~~ and griddles ~~[and barbecues,]~~ shall be listed,

labeled and installed in accordance with the manufacturer's [~~installation~~] instructions. Oil-fired cooking appliances are prohibited. Commercial electric cooking appliances shall be listed and labeled in accordance with UL 197. Household electric ranges shall be listed and labeled in accordance with UL 858. Microwave cooking appliances shall be listed and labeled in accordance with UL 923. Oil-burning stoves shall be listed and labeled in accordance with UL 896. Solid-fuel-fired ovens shall be listed and labeled in accordance with UL 2162.

917.2 Prohibited location. Cooking appliances designed, tested, listed and labeled for use in commercial occupancies shall not be installed within dwelling units or within any area where domestic cooking operations occur.

917.3 Domestic appliances. Cooking appliances installed within dwelling units and within areas where domestic cooking operations occur shall be listed and labeled as household-type appliances for domestic use.

917.4 Domestic range installation. Domestic ranges installed on combustible floors shall be set on their own bases or legs and shall be installed with clearances of not less than that shown on the label.

917.5 Open-top broiler unit hoods. A ventilating hood shall be provided above a domestic open-top broiler unit, unless otherwise listed for forced down draft ventilation.

917.5.1 Clearances. A minimum clearance of 24 inches (~~[610]~~ 609.6 mm) shall be maintained between the cooking top and combustible material above the hood. The hood shall be at least as wide as the open-top broiler unit and be centered over the unit.

917.6 Commercial cooking appliance venting. Commercial cooking appliances, other than those exempted by Section 501.8 of the *New York City Fuel Gas Code*, shall be vented by connecting the appliance to a vent or chimney in accordance with this code and the appliance manufacturer's instructions or the appliance shall be vented in accordance with Section 505.1.1 of the *New York City Fuel Gas Code*.

917.7 Domestic ventilation. When a hood is required for proper ventilation of a domestic cooking appliance, the exhaust and make-up air systems shall be properly engineered and designed in accordance with Chapter 5.

SECTION MC 918 FORCED-AIR WARM-AIR FURNACES

918.1 Forced-air furnaces. Oil-fired furnaces shall be tested in accordance with UL 727. Electric furnaces shall be tested in accordance with UL 1995. Solid fuel furnaces shall be tested in accordance with UL 391. Forced-air furnaces shall be installed in accordance with the listings and the manufacturer's [~~installation~~] instructions. Forced-air warm-air furnaces shall be installed in accordance with the requirements of NFPA 31 and the *New York City Fuel Gas Code*. Unvented fuel-fired furnaces are prohibited.

~~**918.2 Minimum duct sizes.** The minimum unobstructed total area of the outside and return air ducts or openings to a forced air warm air furnace shall be not less than 2 square inches per 1,000 Btu/h (4402 mm²/kW) output rating capacity of the furnace and not less than that specified in the furnace~~

~~manufacturer's installation instructions. The minimum unobstructed total area of supply ducts from a forced air warm air furnace shall not be less than 2 square inches for each 1,000 Btu/h (4402 mm²/kW) output rating capacity of the furnace and not less than that specified in the furnace manufacturer's installation instructions.]~~

~~[**Exception:** The total area of the supply air ducts and outside and return air ducts shall not be required to be larger than the minimum size required by the furnace manufacturer's installation instructions and in accordance with NFPA54.]~~

~~[**918.3** **918.2 Heat pumps.** [The minimum unobstructed total area of the outside and return air ducts or openings to a heat pump shall be not less than 6 square inches per 1,000 Btu/h (13 208 mm²/kW) output rating or as indicated by the conditions of listing of the heat pump. Electric heat pumps shall be tested in accordance with UL 1995.] Electric heat pumps shall be tested in accordance with UL 1995 or UL 60335-2-40.~~

~~[**918.4** **918.3 Dampers.** Volume dampers shall not be placed in the air inlet to a furnace in a manner that will reduce the required air to the furnace.~~

~~[**918.5** **918.4 Circulating air ducts for forced-air warm-air furnaces.** Circulating air for fuel-burning, forced-air-type, warm-air furnaces shall be conducted into the blower housing from outside the furnace enclosure by continuous air-tight ducts.~~

~~[**918.6 Prohibited sources.** Outdoor or return air for a forced air heating system shall not be taken from the following locations:]~~

~~[1. Less than 10 feet (3048 mm) from an appliance vent outlet, a vent opening from a plumbing drainage system or the discharge outlet of an exhaust fan, unless the outlet is 3 feet (914 mm) above the outdoor air inlet.]~~

~~[2. Where there is the presence of objectionable odors, fumes or flammable vapors; or where located less than 10 feet (3048 mm) above the surface of any abutting public way or driveway; or where located at grade level by a sidewalk, street, alley or driveway.]~~

~~[3. A hazardous or unsanitary location or a refrigeration machinery room as defined in this code.]~~

~~[4. A room or space, the volume of which is less than 25 percent of the entire volume served by such system. Where connected by a permanent opening having an area sized in accordance with Sections 918.2 and 918.3, adjoining rooms or spaces shall be considered as a single room or space for the purpose of determining the volume of such rooms or spaces.]~~

~~[**Exception:** The minimum volume requirement shall not apply where the amount of return air taken from a room or space is less than or equal to the amount of supply air delivered to such room or space.]~~

~~[5. A closet, bathroom, toilet room, kitchen, garage, mechanical room, boiler room, furnace room or unconditioned attic.]~~

~~[Exception: Where return air intakes are located not less than 10 feet (3048 mm) from cooking appliances, and serve the kitchen area only, taking return air from a kitchen shall not be prohibited.]~~

~~[6. An unconditioned crawl space by means of direct connection to the return side of a forced air system. Transfer openings in the crawl space enclosure shall not be prohibited.]~~

~~[7. A room or space containing a fuel burning appliance where such room or space serves as the sole source of return air.]~~

[Exceptions:]

~~[1. This shall not apply where the fuel burning appliance is a direct vent appliance.]~~

~~[2. This shall not apply where the room or space complies with the following requirements:]~~

~~[2.1. The return air shall be taken from a room or space having a volume exceeding 1 cubic foot for each 10 Btu/h (9.6 L/W) of combined input rating of all fuel-burning appliances therein.]~~

~~[2.2. The volume of supply air discharged back into the same space shall be approximately equal to the volume of return air taken from the space.]~~

~~[2.3. Return air inlets shall not be located within 10 feet (3048 mm) of any appliance firebox or draft hood in the same room or space.]~~

~~[3. This shall not apply to rooms or spaces containing solid fuel burning appliances, provided that return air inlets are located not less than 10 feet (3048 mm) from the firebox of such appliances.]~~

918.5 Outdoor and return air openings. Outdoor intake openings shall be located in accordance with Section 401.4. Return air openings shall be located in accordance with Section 618.4 of the *New York City Fuel Gas Code*.

[918.7 Outside] 918.6 Outdoor opening protection. Outdoor air intake openings shall be protected in accordance with Section 401.5.

[918.8 Return-air limitation. Return air from one dwelling unit shall not be discharged into another dwelling unit.]

SECTION MC 919 CONVERSION BURNERS

919.1 Conversion burners. The installation of conversion burners shall conform to ANSI Z21.8 and the applicable requirements of Chapter 10 of this code.

SECTION MC 920 UNIT HEATERS

920.1 General. Unit heaters shall be installed in accordance with the listing and the manufacturer's ~~[installation]~~ instructions. Oil-fired unit heaters shall be tested in accordance with UL 731.

920.2 Support. Suspended-type unit heaters shall be supported by elements that are designed and constructed to accommodate the weight and dynamic loads. Hangers and brackets shall be of noncombustible material. Suspended-type oil-fired unit heaters shall be installed in accordance with NFPA 31.

920.3 Ductwork. A unit heater shall not be attached to a warm-air duct system unless listed for such installation.

SECTION MC 921 VENTED ROOM HEATERS

921.1 General. Vented room heaters shall be listed and labeled and shall be installed in accordance with the conditions of the listing and the manufacturer's instructions.

SECTION MC 922 KEROSENE AND OIL-FIRED STOVES

922.1 General. The installation of kerosene and oil-fired stoves is prohibited.

SECTION MC 923 ~~[SMALL]~~ CERAMIC KILNS

923.1 General. ~~[The provisions of this section shall apply to kilns that are used for ceramics, have a maximum interior volume of 20 cubic feet (0.566 m³) and are used for hobby and noncommercial purposes.]~~ Kilns shall be listed and labeled unless otherwise approved in accordance with Section 105.1 Electric kilns shall comply with UL 499. The approval of unlisted appliances in accordance with Section 105.1 shall be based on approved engineering evaluation.

923.1.1 Installation. Kilns shall be installed in accordance with the manufacturer's ~~[installation]~~ instructions and the provisions of this code.

SECTION MC 924 STATIONARY FUEL CELL POWER PLANTS

924.1 General. Stationary fuel cell power plants having a power output not exceeding ~~[1,000 kW]~~ 10 MW, shall be tested in accordance with ~~[ANSI Z21.83]~~ ANSI/CSA America FC1 and shall be installed in accordance with the manufacturer's [installation] instructions and NFPA 853. [Only fuel cell plants that derive hydrogen from natural gas shall be used. No on site storage of hydrogen, natural gas or any other flammable gas shall be allowed.] Such fuel cell plants shall be powered by hydrogen derived on-site from piped natural gas, except where the storage, handling and use of hydrogen or other flammable gas is authorized by the New York City Fire Code for such purposes and approved by the fire commissioner.

**SECTION MC 925
MASONRY HEATERS**

925.1 General. Masonry heaters shall be constructed in accordance with the *New York City Building Code*.

**SECTION MC 926
GASEOUS HYDROGEN SYSTEMS**

926.1 Installation. The installation of gaseous hydrogen systems shall be in accordance with the applicable requirements of this code, the *New York City Fire Code*, the *New York City Fuel Gas Code* and the *New York City Building Code*.

**SECTION MC 927
~~[HEAT RECOVERY VENTILATORS]~~ ELECTRIC RADIANT HEATING SYSTEMS**

927.1 ~~[Ducted heat recovery ventilators.~~ ~~Ducted heat recovery ventilators shall be listed and labeled in accordance with UL 1812.]~~ **General.** Electric radiant heating systems shall be installed in accordance with the manufacturer's instructions and shall be listed for the application.

927.2 ~~[Nonducted heat recovery ventilators.~~ ~~Nonducted heat recovery ventilators shall be listed and labeled in accordance with UL 1815.]~~ **Clearances.** Clearances for radiant heating panels or elements to any wiring, outlet boxes and junction boxes used for installing electrical devices or mounting luminaires shall be in accordance with the *New York City Building Code* and the *New York City Electrical Code*.

927.3 Installation on wood or steel framing. Radiant panels installed on wood or steel framing shall conform to the following requirements:

1. Heating panels shall be installed parallel to framing members and secured to the surface of framing members or shall be mounted between framing members.
2. Mechanical fasteners shall penetrate only the unheated portions provided for this purpose. Panels shall not be fastened at any point closer than 1/4 inch (6.4 mm) to an element. Other methods of attachment of the panels shall be in accordance with the panel installation instructions.
3. Unless listed and labeled for field cutting, heating panels shall be installed as complete units.

927.4 Installation in concrete or masonry. Radiant heating systems installed in concrete or masonry shall conform to the following requirements:

1. Radiant heating systems shall be identified as being suitable for the installation, and shall be secured in place as specified in the manufacturer's instructions.
2. Radiant heating panels and radiant heating panel sets shall not be installed where they bridge expansion joints unless they are protected from expansion and contraction.

927.5 Finish surfaces. Finish materials installed over radiant heating panels and systems shall be installed in accordance with the manufacturer's instructions. Surfaces shall be secured so that fasteners do not pierce the radiant heating elements.

SECTION MC 928
[NOISE CONTROL REQUIREMENTS] EVAPORATIVE COOLERS

928.1 General. ~~[Interior and exterior mechanical equipment and systems shall comply with the provisions of this section.]~~ Evaporative cooling equipment shall:

1. Be installed in accordance with the manufacturer's instructions.
2. Be installed on level platforms and in accordance with Section 304.10.
3. Have openings in exterior walls or roofs flashed in accordance with the *New York City Building Code*.
4. Be provided with an approved water supply, sized for peak demand. The quality of water shall be provided in accordance with the equipment manufacturer's recommendations. The piping system and protection of the potable water supply system shall be installed as required by the *New York City Plumbing Code*.
5. Have ventilation air intake opening locations in accordance with Section 401.4.

~~**[928.2 Noise from exterior mechanical equipment.** Mechanical equipment located outside of the building in a yard or court or on a roof, or located inside a building but open to the exterior of the building, shall comply with the requirements of Sections 928.2.1 and 928.2.2.]~~

~~**[928.2.1 Design and installation.** The applicant shall select and design any such exterior mechanical equipment in order to achieve compliance with the applicable requirements of Sections 24-218, 24-227, 24-228 and 24-232 of the *Administrative Code*, also known as the *New York City Noise Control Code*, in accordance with generally acceptable engineering practices.]~~

~~**[928.2.2 Operation.** The operation of such exterior mechanical equipment shall comply with any applicable requirements of Sections 24-218, 24-227, 24-228 and 24-232 of the *New York City Noise Control Code*, as enforced by the Department of Environmental Protection.]~~

~~**[928.3 Minimum structure-borne noise and vibration isolation requirements.** All isolators shall comply with the requirements of Sections 928.3.1 through Section 928.3.10.]~~

~~**[928.3.1 Boiler rooms.]**~~

~~**[928.3.1.1 Boilers.** All boilers supported on floors directly above a story having dwelling units shall be supported on resilient isolators having a minimum static deflection of 1 inch (25 mm). The isolators shall be installed directly under the structural frame of the boiler.]~~

~~**[928.3.1.2 Boiler breeching and piping.** When boilers are equipped with mechanical draft fans, the boiler breeching and piping that are supported from or on slabs, floors or walls that are contiguous to the dwelling unit shall be supported for a distance of 50 pipe diameters on~~

or from resilient isolators. Each isolator shall have a minimum static deflection of 1 inch (25 mm).]

[928.3.2 Refuse charging chutes.]

[928.3.2.1 Metal chutes. Metal chutes, metal chute supports, and/or metal chute bracing shall be free of direct contact with the shaft enclosure and the openings provided in the floor construction. Metal chutes shall be resiliently supported at each structural support location. Isolators shall provide a minimum static deflection of 0.30 inches (7.62 mm). All chutes shall be plumb.]

[928.3.2.2 Masonry chutes. The interior chute wall shall be plumb and without obstructions for the full height of the shaft and shall have a smooth interior finish.]

[928.3.3 Piping. Equipment piping shall be installed as follows:]

[1. Metal piping connected to power driven equipment shall be resiliently supported from or on the building structure for a distance of 50 pipe diameters from the power driven equipment. The resilient isolators shall have a minimum static deflection of 1 inch (25 mm) for all piping with a 4 inch (102 mm) or larger in actual outside diameter and $^{+1}/_{2}$ inch (12.7 mm) for piping with less than 4 inches (102 mm) in actual outside diameter. Piping connected to fluid pressure reducing valves shall be resiliently isolated for a distance of 50 pipe diameters from pressure reducing valves and isolators shall provide a minimum static deflection of $^{+1}/_{2}$ inch (12.7 mm).]

[2. Equipment such as heat exchangers, absorption refrigeration machines, or similar equipment, that is located on any floor or roof other than a floor on grade, and that is not power driven but is connected by metal piping to power driven equipment, shall be resiliently supported from or on the building structure, for a distance of 50 pipe diameters from the power driven equipment. The resilient supports shall be vibration isolators having a minimum static deflection of 1 inch (25 mm) and shall incorporate approved resilient pads having a minimum thickness of $^{+1}/_{4}$ inch (6.4 mm).]

[928.3.4 Fans. All fan equipment with motors in excess of $1/2$ horsepower (0.37 kW), located on any roof or floor other than a floor on grade shall be mounted on or from vibration isolators. Fan equipment with motor drives separated from the fan equipment shall be supported on an isolated integral rigid structural base supporting both the fan and motor. Fan equipment with motor drives supported from the fan equipment shall be mounted directly on vibration isolators. Each isolator shall have provision for leveling. Isolators shall incorporate resilient pads having a minimum thickness of $^{+1}/_{4}$ inch (6.4 mm). The vibration isolators shall provide a minimum isolation efficiency of 90 percent at fan rotor rpm with a maximum deflection of 2 inches (51 mm). Fans and compressors assembled in unitary containers may meet this requirement with isolators internal to the container providing the isolators meet the above minimum isolator efficiencies.]

[928.3.5 Pumps. All pumps of 3 horsepower (2.25 kW) or more located on any floor other than a floor on grade shall be supported on vibration isolators having a minimum isolation efficiency of 90 percent at the lowest disturbing frequency. Each isolator shall incorporate a leveling device and a resilient pad having a minimum thickness of $^{+1}/_{4}$ inch (6.4 mm).]

~~[928.3.6 Compressors. Compressors and drives located on a floor other than a floor on grade shall be mounted on vibration isolators having a minimum isolation efficiency of 90 percent at the lowest disturbing frequency. Each isolator shall incorporate a leveling device and a resilient pad having a minimum thickness of $\frac{1}{4}$ inch (6.4 mm).]~~

~~[928.3.7 Cooling towers and fluid coolers. All moving parts of cooling towers located on a roof or floor other than a floor on grade shall be installed on vibration isolators providing a minimum isolation efficiency of 90 percent at fan rotor rpm with a maximum static deflection of 4 inches (102 mm). Each isolator shall incorporate a leveling device and a resilient pad having a minimum thickness of $\frac{1}{4}$ inch (6.4 mm). Vibration cutoff switches shall be provided.]~~

~~[928.3.8 Evaporative condensers. Evaporative and air-cooled condensers located on a roof or floor other than a floor on grade shall be mounted on vibration isolators providing a minimum isolation efficiency of 90 percent at fan rotor rpm with a maximum static deflection of 4 inches (102 mm). Each isolator shall incorporate a leveling device and a resilient pad having a minimum thickness of $\frac{1}{4}$ inch (6.4 mm). Vibration cutoff switches shall be provided on evaporative condensers.]~~

~~[928.3.9 Duct connections to fans. Flexible connections shall be installed between fan equipment and connecting ductwork.]~~

~~[928.3.10 Ceiling suspended packaged HVAC units with compressors. Equipment such as heat pumps, AC units, or similar equipment, that is suspended from a structure shall be resiliently supported from or on the building structure. Vibration isolators shall have a minimum isolation efficiency of 90 percent at the lowest disturbing frequency.]~~

§ 11. Chapter 10 of the New York city mechanical code, as amended by local law

number 141 for the year 2013, is amended to read as follows:

CHAPTER 10

BOILERS, WATER HEATERS AND PRESSURE VESSELS

SECTION MC 1001 GENERAL

1001.1 Scope. This chapter shall establish the minimum safety requirements for and shall govern the installation, alteration and repair of boilers, water heaters and pressure vessels.

Exceptions:

1. Pressure vessels used for unheated water supply.
2. Portable unfired pressure vessels and Interstate Commerce Commission containers.
3. Containers for bulk oxygen and medical gas.

4. Unfired pressure vessels having a volume of 5 cubic feet (0.14 m³) or less operating at pressures not exceeding 250 pounds per square inch (psi) (~~[1724]~~ 1723.7 kPa) and located within occupancies of Groups B, F, H, M, R, S and U.
5. Pressure vessels used in refrigeration systems that are regulated by Chapter 11~~[of this code]~~.
6. Pressure tanks used in conjunction with coaxial cables, telephone cables, power cables and other similar humidity control systems.
7. Any boiler or pressure vessel subject to inspection by federal inspectors.

1001.2 Thermal safety (spill) switches. Thermal safety (spill) switches shall be installed ~~[on barometric dampers, draft hoods, draft diverters, and all other appurtenances that allow dilution air into a chimney or gas vent. Thermal safety (spill) switches shall be interlocked with all of the appliances connected to the same chimney or gas vent]~~ in accordance with Section 801.23.3.

1001.3 Clearances. Minimum clearances at boilers, water heaters and pressure vessels shall be maintained in accordance with Chapter 3.

SECTION MC 1002 WATER HEATERS

1002.1 General. Potable water heaters and hot water storage tanks shall be listed and labeled and installed in accordance with the manufacturer's ~~[installation]~~ instructions, the *New York City Plumbing Code* and this code. All water heaters shall be capable of being removed without first removing a permanent portion of the building structure. The potable water connections and relief valves for all water heaters shall conform to the requirements of the *New York City Plumbing Code*. Domestic electric water heaters shall comply with UL 174 or UL 1453. Commercial electric water heaters shall comply with UL 1453. Oil-fired water heaters shall comply with UL 732. Approval for oil-fired water heaters 350,000 Btu/h input (~~[1025]~~ 103 kW) and above shall be obtained from the New York City Department of Environmental Protection. Thermal solar water heaters shall comply with UL 174 or UL 1453, and Chapter 14 of this code. Heat pump water heaters shall comply with UL 174 or UL 1995.

1002.2 Water heaters utilized for space heating. Water heaters utilized both to supply potable hot water and provide hot water for space-heating applications shall be listed and labeled for such applications by the manufacturer ~~[;]~~ and shall be built in accordance with Section IV of the *ASME Boiler and Pressure Vessel Code* with an "H" code stamp. ~~[They]~~ Water heaters shall be installed in accordance with the manufacturer's ~~[installation]~~ instructions, the *ASME Boiler and Pressure Vessel Code* and the *New York City Plumbing Code*. Oil-fired heaters shall comply with UL 732 and shall have an "HW" stamp.

1002.2.1 Sizing. Water heaters utilized for both potable water heating and space-heating applications shall be sized to prevent the space-heating load from diminishing the required potable water-heating capacity.

1002.2.2 Temperature limitation. Where a combination potable water-heating and space-heating system requires water for space heating [~~at temperatures higher than 140°F (60°C)~~], a temperature actuated mixing valve [~~that conforms to ANSI/ASSE 1017~~] complying with ASSE 1017 shall be provided to temper the water supplied to the potable hot water distribution system [~~to a temperature of 140°F (60°C) or less~~] in accordance with Section 607 of the *New York City Plumbing Code*.

1002.2.3 Cross-connection. Water heaters utilized for both potable hot water and hot water for space-heating applications shall have separate heating sections and connections for distribution systems and shall not be cross-connected. The potability of the domestic water shall be maintained throughout the system in accordance with the *New York City Plumbing Code*.

1002.3 Supplemental water-heating devices. Potable water-heating devices that utilize refrigerant-to-water heat exchangers shall be approved and installed in accordance with the *New York City Plumbing Code*, the applicable provisions of the *New York City Energy Conservation Code* and the manufacturer's [~~installation~~] instructions.

SECTION MC 1003 PRESSURE VESSELS

1003.1 General. All pressure vessels shall be constructed and certified in accordance with the *ASME Boiler and Pressure Vessel Code*, and shall bear the label of an approved agency. Pressure vessels shall be installed in accordance with the manufacturer's [~~installation~~] instructions and nationally recognized standards. Directly fired pressure vessels shall meet the requirements of Section 1004.

1003.2 Piping. All piping materials, fittings, joints, connections and devices associated with systems utilized in conjunction with pressure vessels shall be designed for the specific application and shall comply with the *ASME Boiler and Pressure Vessel Code* and this code.

1003.3 Welding. Welding on pressure vessels shall be performed by welders certified in compliance with nationally recognized standards, including the *National Board Inspection Code* and *ASME Boiler and Pressure Vessel Code*, Section IX [;]. Such welders shall also comply with 12 NYCRR 4-6.2 [;] , and 12 NYCRR 14-3.3 through 14-3.18.

SECTION MC 1004 BOILERS

1004.1 Standards. [~~Oil-fired boilers and their control systems shall be listed and labeled in accordance with UL 726. Electric boilers and their control systems shall be listed and labeled in accordance with UL 834. Boilers shall be designed and constructed in accordance with the requirements of ASME CSD-1 and as applicable: the *ASME Boiler and Pressure Vessel Code*; *12 NYCRR Parts 4 and 14*; and NFPA 85. Approval for oil-fired boilers 350,000 Btu/h input (1025 kW) and above shall be obtained from the New York City Department of Environmental Protection.] Boilers shall be designed, constructed and certified in accordance with the *ASME Boiler and Pressure Vessel Code*, Section I or IV, and 12 NYCRR Parts 4 and 14. Controls and safety devices for boilers with fuel input ratings of 12,500,000 Btu/h (3663 kW) or less shall meet the requirements of ASME CSD-1. Controls and safety devices for boilers with inputs greater than 12,500,000 Btu/h (3663 kW) shall meet the requirements of NFPA 85. Packaged oil-fired boilers shall be listed and labeled in~~

accordance with UL 726. Packaged electric boilers shall be listed and labeled in accordance with UL 834. Approval for oil-fired boilers 350,000 Btu/h input (102.6 kW) and above shall be obtained from the New York City Department of Environmental Protection.

1004.1.1 Field erected boilers requirements. Field erected boiler installations shall comply with the following:

1. The vessel erector shall hold the appropriate ASME stamp for vessel construction.
2. The licensed installer is responsible for the installation of all controls and burners which shall be designed and constructed in accordance with the requirements of ASME CSD-1 and, as applicable, the *ASME Boiler and Pressure Vessel Code*, 12 NYCRR Parts 4 and 14, and NFPA 85.
3. The New York City Department of Environmental Protection shall approve the installation of the boiler and burner for compatibility, controls and safety devices.
4. Boiler vessels shall comply with one of the following listings:
 - 4.1. UL 726 or UL 795 as applicable; or
 - 4.2. UL 2106 [~~;-0F~~].

Exception: Unlisted equipment shall obtain [~~Department~~] approval from the department.

5. Controls and safety devices shall be tested and inspected in accordance with ASME CSD-1 and, as applicable, the *ASME Boiler and Pressure Vessel Code*, 12 NYCRR Parts 4 and 14, and NFPA 85. Testing and inspection shall be performed by the burner manufacturer's authorized representative in the presence of the licensed installer.
6. Inspection of the installed boiler assembly shall be performed by the department.

1004.2 Installation. In addition to the requirements of this code, the installation of boilers shall conform to the manufacturer's instructions. Operating instructions of a permanent type shall be located in the boiler room and readily accessible. Boilers shall have all controls set, adjusted and tested by the installer. The manufacturer's rating data and the nameplate shall be attached to the boiler.

1004.3 Working clearance. Clearances shall be maintained around boilers, generators, heaters, tanks and related equipment and appliances so as to permit inspection, servicing, repair, replacement and visibility of all gauges. When boilers are installed or replaced, clearance shall be provided to allow access for maintenance and repair per the boiler's listing and manufacturer's [~~installation~~] instructions. Passageways for inspection around all sides of boilers shall have an unobstructed width of not less than 18 inches ([~~457~~] 457.2 mm) unless the boiler's listing or department approval or manufacturer's [~~installation~~] instructions state otherwise.

1004.3.1 Top clearance. [~~High-pressure steam boilers having a steam-generating capacity in excess of 5,000 pounds per hour (2268 kg/h) or having a heating surface in excess of 1,000 square feet (93 m²) or input in excess of 5,000,000 Btu/h (1465 kW) shall have a minimum clearance of 7 feet (2134 mm) from the top of the boiler to the ceiling. Steam-heating boilers and hot-water-heating boilers that exceed one of the following limits: 5,000,000 Btu/h input (1465 kW); 5,000 pounds of steam per hour (2268 kg/h) capacity or a 1,000-square-foot (93 m²) heating surface; and high-pressure steam boilers that do not exceed one of the following limits: 5,000,000 Btu/h input (1465 kW); 5,000 pounds of steam per hour (2268 kg/h) capacity or a 1,000-square-foot (93 m²) heating surface; and all boilers with manholes on top of the boiler, shall have a minimum clearance of 3 feet (914 mm) from the top of the boiler to the ceiling. Package boilers, steam-heating boilers and hot-water-heating boilers without manholes on top of the shell and not exceeding one of the limits of this section shall have a minimum clearance of 2 feet (610 mm) from the ceiling.~~]

Clearances from the tops of boilers to the ceiling or other overhead obstruction shall be in accordance with Table 1004.3.1.

**TABLE 1004.3.1
BOILER TOP CLEARANCES**

<u>BOILER TYPE</u>	<u>MINIMUM CLEARANCES FROM TOP OF BOILER TO CEILING OR OTHER OVERHEAD OBSTRUCTION (feet)</u>
<u>All boilers with manholes on top of the boiler except where a greater clearance is required in this table.</u>	<u>3</u>
<u>All boilers without manholes on top of the boiler except high-pressure steam boilers and where a greater clearance is required in this table.</u>	<u>2</u>
<u>High-pressure steam boilers with steam generating capacity not exceeding 5,000 pounds per hour.</u>	<u>3</u>
<u>High-pressure steam boilers with steam generating capacity exceeding 5,000 pounds per hour.</u>	<u>7</u>
<u>High-pressure steam boilers having heating surface not exceeding 1,000 square feet.</u>	<u>3</u>
<u>High-pressure steam boilers having heating surface in excess of 1,000 square feet.</u>	<u>7</u>
<u>High-pressure steam boilers with input not exceeding 5,000,000 Btu/h.</u>	<u>3</u>
<u>High-pressure steam boilers with input in excess of 5,000,000 Btu/h.</u>	<u>7</u>
<u>Steam-heating boilers and hot water-heating boilers with input exceeding 5,000,000 Btu/h.</u>	<u>3</u>
<u>Steam-heating boilers exceeding 5,000 pounds of steam per hour.</u>	<u>3</u>

**TABLE 1004.3.1
BOILER TOP CLEARANCES**

<u>BOILER TYPE</u>	<u>MINIMUM CLEARANCES FROM TOP OF BOILER TO CEILING OR OTHER OVERHEAD OBSTRUCTION (feet)</u>
<u>Steam-heating boilers and hot water-heating boilers having heating surface exceeding 1,000 square feet.</u>	<u>3</u>

For SI: 1 foot = 304.8 mm, 1 square foot = 0.0929 m², 1 pound per hour = 0.4536 kg/h, 1 Btu/hr = 0.293 W.

1004.4 Mounting. Equipment and appliances shall be set or mounted on a level base capable of supporting and distributing the weight contained thereon. Boilers, tanks and equipment shall be securely anchored to the structure. Equipment and appliances requiring vibration isolation shall be installed as designed by a registered design professional in accordance with the manufacturer's [installation] instructions.

1004.5 Floors. Boilers shall be mounted on floors of noncombustible construction, unless listed for mounting on combustibile flooring. Vibration isolation shall be in accordance with Section 313. In buildings with residential occupancies, boilers shall be installed in accordance with the requirements of Section 313.

1004.6 Boiler rooms and enclosures. Boiler rooms and enclosures and access thereto shall comply with Chapters 5 and 10 of the New York City Building Code and Chapter 3 of this code. Boiler rooms shall be equipped with a floor drain or other approved means for disposing of liquid waste in accordance with the *New York City Plumbing Code*.

1004.7 Operating adjustments and instructions. Hot water and steam boilers shall have all operating and safety controls set and operationally tested by the installing contractor. A complete control diagram and boiler operating instructions shall be furnished by the installer for each installation. A complete control diagram of a permanent type shall be located in the boiler room and shall be readily accessible.

1004.8 Burner controls. Gas and oil modulating burners shall be provided with burner controls (oil and gas equivalent ratings) in accordance with [~~Table 1004.8~~] ASME CSD-1 and NFPA 85.

**[TABLE 1004.8
MINIMUM CONTROL REQUIREMENTS**

<u>TYPE OF CONTROL</u>	<u>GROSS OUTPUT FIRING RATE OF THE BOILER OR THE BURNER OIL DELIVERY RATE (gph), WHICHEVER IS CREATED</u>		
	<u>#6 Oil</u>	<u>#4 Oil</u>	<u>#2 Oil</u>
<u>On-Off</u>	—	—	<10
<u>Low-High-Off with low fire start</u>	20 to <30	10 to <30	10 to <30

**[TABLE 1004.8
MINIMUM CONTROL REQUIREMENTS**

TYPE OF CONTROL	GROSS OUTPUT FIRING RATE OF THE BOILER OR THE BURNER OIL DELIVERY RATE (gph), WHICHEVER IS CREATED		
	#6 Oil	#4 Oil	#2 Oil
Low High Low Off with proven low fire start	30 to < 50	30 to < 50	30 to < 50
Full Modulation with proven low fire start	≥ 50	≥ 50	≥ 50
Full Modulation with proven low fire start as well as cross limited oxygen trim (dry cell electrochemical type)	≥ 350	≥ 350	≥ 350

1004.9 Conversion burners. Conversion burners shall be installed in accordance with ANSI Z21.8.

SECTION MC 1005 BOILER CONNECTIONS

1005.1 Valves. Every boiler or modular boiler shall have a shutoff valve in the supply and return piping. For multiple boiler or multiple modular boiler installations, each boiler or modular boiler shall have individual shutoff valves in the supply and return piping.

Exception: Shutoff valves are not required in a system having a single low-pressure steam boiler of 350,000 Btu/h (103 kW) output or less.

1005.2 Potable water supply. The water supply to all boilers, including but not limited to backflow prevention, shall be connected in accordance with the *New York City Plumbing Code*.

SECTION MC 1006 SAFETY AND PRESSURE RELIEF VALVES AND CONTROLS

1006.1 Safety valves for steam boilers. ~~[All steam]~~ Steam boilers shall be protected with a safety valve in accordance with the *ASME Boiler and Pressure Vessel Code* or ASME CSD-1.

1006.2 Safety relief valves for hot water boilers. Hot water boilers shall be protected with a safety relief valve in accordance with the *ASME Boiler and Pressure Vessel Code* or ASME CSD-1.

1006.3 Pressure relief for pressure vessels. ~~[All pressure]~~ Pressure vessels shall be protected with a pressure relief valve or pressure-limiting device as required by the manufacturer's ~~[installation]~~ instructions for the pressure vessel and in accordance with the *ASME Boiler and Pressure Vessel Code* or ASME CSD-1.

1006.4 Standards of safety and safety relief valves. Safety and safety relief valves shall be listed and labeled, and shall have a minimum rated capacity for the equipment or appliances served. Safety

and safety relief valves shall be set at ~~[a maximum of]~~ not greater than the nameplate pressure rating of the boiler or pressure vessel and shall be in accordance with the ASME Boiler and Pressure Vessel Code or the ASME CSD-1.

1006.5 Installation. Safety or relief valves shall be installed directly into the safety or relief valve opening on the boiler or pressure vessel. Valves shall not be located on either side of a safety or relief valve connection. The ~~[safety or]~~ relief valve drain shall discharge by gravity to a nonhazardous point of discharge without obstruction ~~[to a nonhazardous point of discharge]. [The discharge piping shall drain by gravity without traps.]~~

1006.6 Safety and relief valve discharge. Safety and relief valve discharge pipes shall be of rigid pipe that is approved for the temperature of the system. The discharge pipe shall, at a minimum, be the same diameter as the safety or relief valve outlet. Safety and relief valve discharge pipes shall be properly supported to prevent stress on the valve and vessel. Safety and relief valves shall not discharge so as to be a hazard, a potential cause of damage or otherwise a nuisance. Discharge of hazardous materials must be properly contained in a method approved by the department. High-pressure-steam safety valves shall be vented to the outside of the structure. Where a low-pressure safety valve or a relief valve discharges to the drainage system, the installation shall conform to the *New York City Plumbing Code*.

1006.7 Boiler safety devices. Boilers shall be equipped with controls and limit devices as required by the manufacturer's ~~[installation]~~ instructions and the conditions of the listing.

1006.8 Electrical requirements. The power supply to the electrical control system shall be from a two-wire branch circuit that has a grounded conductor, or from an isolation transformer with a two-wire secondary. Where an isolation transformer is provided, one conductor of the secondary winding shall be grounded. Control voltage shall not exceed 150 volts nominal, line to line. Control and limit devices shall interrupt the ungrounded side of the circuit. A means of manually disconnecting the control circuit shall be provided and controls shall be arranged so that when deenergized, the burner shall be inoperative. Such disconnecting means shall be capable of being locked in the off position and shall be provided with ready access.

1006.8.1 Remote control (shutdown). A remote control shall be provided to stop the flow of oil and/or gas and combustion air to any burner or fuel-burning internal combustion equipment. Such a control shall be ~~[located outside of]~~ provided along every means of egress ~~[to]~~ from the room in which the burner or equipment is located ~~[and as close to such entrances as practicable, except that when an outside location is impracticable, such control may be located immediately inside the room in which the burner or equipment is located, provided such location is accessible at all times]. [All such controls]~~ Each remote control shall be located outside of, but as close as practicable to the burner or equipment room itself and shall be labeled: "REMOTE CONTROL FOR BURNER."

Exception: Where an outside location is impracticable, the remote control shutdown may be provided immediately inside the room in which the burner or equipment is located. Such location must be accessible at all times.

1006.9 Carbon monoxide detectors. Carbon monoxide detectors shall be provided in all fuel-fired appliance rooms to detect the level of carbon monoxide in the room and signal an alarm. Such

detectors shall be listed and installed in accordance with Chapter 9 of the *New York City Building Code*.

SECTION MC 1007 BOILER LOW-WATER CUTOFF

1007.1 General. ~~[All steam]~~ Steam and hot water boilers shall be protected with dual low-water cutoff control, with each control independently piped to the pressure vessel in accordance with ASME CSD-1. For hydronic boilers, the low-water cut out may be located in the supply piping above the boiler before any intervening valve. A flow-sensing control installed in accordance with ASME CSD-1 shall be considered a low-water cutoff for the purposes of this section.

Exception: Hot water boilers located within a dwelling unit supplying only that unit and having a total heat input of less than ~~[350,000]~~ 400,000 Btu/h (~~[1025]~~ 117.2 kW) may be protected by only one ~~[low water]~~ low-water cutoff control.

1007.2 Operation. ~~[The low]~~ Low-water cutoff controls and flow-sensing controls required by Section 1007.1 shall automatically stop the combustion operation of the appliance when the water level drops below the lowest safe water level as established by the manufacturer and in accordance with ASME CSD-1, or when water circulation stops, respectively.

1007.3 Low-water cut out maintenance and testing. Low-water cut outs shall be maintained in accordance with ASME CSD-1 and the manufacturer's specifications. An operator shall test low-water cut outs as follows: (1) high pressure steam boilers every shift, (2) low pressure steam boilers daily and (3) hot water boilers monthly. Slow drain tests shall be conducted for steam boilers every six months. Every year, low-water cut outs and associated piping for steam boilers shall be opened, cleaned and inspected. Records of all testing, cleaning, and inspection required by this section shall be maintained, and made available to the department upon request.

SECTION MC 1008 BOILER BLOWOFF/BLOWDOWN VALVES

1008.1 General. Every boiler shall be equipped with blowoff/blowdown valve(s). The valve(s) shall be installed in the openings provided on the boiler. The minimum quantity and size of ~~[each valve]~~ the valve(s) and associated piping shall be the quantity and size specified by the boiler manufacturer or the quantity and size of the boiler blowoff/blowdown valve opening. Where the maximum allowable working pressure of the boiler exceeds 15 psig (103.4 kPa), two bottom blowoff valves shall be provided consisting of either two slow-opening valves in series or one quick-opening valve and one slow-opening valve in series, with the quick-opening valve installed closest to the boiler.

1008.2 Discharge. Blowoff/blowdown valves shall discharge to a safe place of disposal. Where discharging to the drainage system, the installation shall conform to the *New York City Plumbing Code*.

1008.3 Maintenance. Blowdown lines shall be inspected annually to verify they are free of deposits and in good working condition.

**SECTION MC 1009
HOT WATER BOILER EXPANSION TANK**

1009.1 Where required. An expansion tank shall be installed in every hot water system. For multiple boiler installations, ~~[a minimum of]~~ not less than one expansion tank is required. Expansion tanks shall be of the closed or open type. Tanks shall be rated for the pressure of the hot water system. Lockable shutoff valves shall be installed at connections to all expansion tanks. Valves shall remain locked in the open position.

1009.2 Closed-type expansion tanks. Closed-type expansion tanks shall be installed in accordance with the manufacturer’s instructions. Expansion tanks for systems designed to have an operating pressure in excess of 30 psi (205.8 kPa) shall be constructed and certified in accordance with the ASME Boiler and Pressure Vessel Code. The size of the tank shall be based on the capacity of the hot-water-heating system. The minimum size of the tank shall be determined in accordance with the following equation where all necessary information is known:

$$V_t = \frac{(0.00041T - 0.0466)V_s}{\left(\frac{P_a}{P_f}\right) - \left(\frac{P_a}{P_o}\right)} \quad \text{(Equation 10-1)}$$

For SI: $V_t = \frac{(0.000738T - 0.03348)V_s}{\left(\frac{P_a}{P_f}\right) - \left(\frac{P_a}{P_o}\right)}$

where:

- V_t = Minimum volume of tanks (gallons) (L).
- V_s = Volume of system, not including expansion tanks (gallons) (L).
- T = Average operating temperature (°F) (°C).
- P_a = Atmospheric pressure (psi) (kPa).
- P_f = Fill pressure (psi) (kPa).
- P_o = Maximum operating pressure (psi) (kPa).

Where all necessary information is not known, the minimum size of the tank shall be determined from Table 1009.2.

**TABLE 1009.2
CLOSED-TYPE EXPANSION TANK SIZING**

SYSTEM VOLUME IN GALLONS	TANK CAPACITIES IN GALLONS	
	Pressurized Diaphragm Type	Nonpressurized Type
<u>100</u>	<u>9</u>	<u>15</u>
<u>200</u>	<u>17</u>	<u>30</u>
<u>300</u>	<u>25</u>	<u>45</u>
<u>400</u>	<u>33</u>	<u>60</u>
<u>500</u>	<u>42</u>	<u>75</u>
<u>1,000</u>	<u>83</u>	<u>150</u>

**TABLE 1009.2
CLOSED-TYPE EXPANSION TANK SIZING**

SYSTEM VOLUME IN GALLONS	TANK CAPACITIES IN GALLONS	
	Pressurized Diaphragm Type	Nonpressurized Type
<u>2,000</u>	<u>165</u>	<u>300</u>

For SI: 1 gallon = 3.795 L.

1009.3 Open-type expansion tanks. Open-type expansion tanks shall be located [~~a minimum of~~] not less than 4 feet ([~~1219~~] 1219.2 mm) above the highest heating element. The tank shall be adequately sized for the hot water system. An overflow with a minimum diameter of 1 inch (~~[25]~~ 25.4 mm) shall be installed at the top of the tank. The overflow shall discharge to the drainage system in accordance with the *New York City Plumbing Code*.

SECTION MC 1010 GAUGES

1010.1 Hot water boiler gauges. Every hot water boiler shall have a pressure gauge and a temperature gauge, or a combination pressure and temperature gauge. The gauges shall indicate the temperature and pressure within the normal range of the system's operation.

1010.2 Steam boiler gauges. Every steam boiler shall have a water-gauge glass and a pressure gauge with a siphon. The pressure gauge [~~installed with a siphon~~] shall indicate the pressure within the normal range of the system's operation.

1010.2.1 Water-gauge glass. The gauge glass shall be installed [~~so that the midpoint is at the normal boiler water level~~] in accordance with the ASME Boiler and Pressure Vessel Code or ASME CSD-1.

SECTION MC 1011 TESTS

1011.1 Tests. Upon completion of the assembly and installation of boilers and pressure vessels, acceptance tests shall be conducted in accordance with the requirements of the *ASME Boiler and Pressure Vessel Code*. Boilers shall not be placed in operation upon completion of construction until they have been inspected and tested and a certificate of compliance has been issued by the commissioner. All final inspections and tests for boilers shall be [~~made~~] witnessed by a qualified boiler inspector in the employ of the department or a duly authorized insurance company as provided in Section 204 of the Labor Law of the State of New York. Equipment having an input of not more than 350,000 Btu/h (103 kW) shall be exempt from this requirement. Where field assembly of pressure vessels or boilers is required, a copy of the completed H-2, P-2 or U-1 Manufacturer's Data Report and the completed Appendix C of ASME CSD-1 required by the *ASME Boiler and Pressure Vessel Code* shall be submitted to the department.

1011.1.1 Fitness for service. When a boiler or pressure vessel has exceeded its useful life or has been subjected to an event that may have impacted the integrity of the pressure vessel, the department may require that a fitness for service study be completed. The study shall be completed in accordance with the National Board Inspection Code Part 2, Section 4, and documented in accordance with the National Board 403 form.

1011.2 Test gauges. An indicating test gauge shall be connected directly to the boiler or pressure vessel where it is visible to the operator throughout the duration of the test. The pressure gauge scale shall be graduated over a range of not less than one and one-half times and not greater than four times the maximum test pressure. ~~[All gauges]~~ Gauges utilized for testing shall be calibrated and certified annually in accordance with ASME B40.100 by the test operator.

1011.3 Periodic boiler inspections. Periodic boiler inspections shall be performed in accordance with ~~[Section 28-303]~~ Article 303 of Chapter 3 of the *Administrative Code* and Section 1007.3 of this code. In addition, boiler inspections shall:

1. Be completed in accordance with the *National Board Inspection Code*.
2. Include the review of testing documentation for all controls and safety devices.
3. Verify that the flue connection from the boiler to the chimney is properly sealed and in good working condition.
4. Verify that the combustion air system as originally designed is operational.
5. Verify that the High Pressure Operators' licenses are current and that Low Pressure Operators are qualified per New York State requirements.
6. Include a permanent record of the visit.
7. Be subject to the quality control measures of the department.

1011.4 Pressurized systems containing hazardous materials. Any pressurized system that contains hazardous materials or presents a physical hazard by release shall be pre-approved for installation, subject to testing, and subject to inspection by the department.

1011.5 Nondestructive examination. When required by the department, the nondestructive examination (NDE) requirements, including technique, extent of coverage, procedures, personnel qualification, and acceptance criteria, shall be performed in accordance with the applicable provisions of the edition of the code of construction for the pressure-vessel in effect at the time of installation. Weld repairs and alterations shall be subject to the same nondestructive examination requirements. Where this is not possible or practicable, alternative NDE methods acceptable to the inspector and the department may be used.

SECTION MC 1012 MAXIMUM TEMPERATURE

1012.1 Maximum temperature. Maximum indoor temperature in spaces surrounding boilers, water heaters, and pressure vessels shall not exceed the operational temperature of the installed equipment or 104°F (40°C).

§ 12. Chapter 11 of the New York city mechanical code, as amended by local law number 141 for the year 2013, is amended to read as follows:

CHAPTER 11 REFRIGERATION

SECTION MC 1101 GENERAL

1101.1 Scope. This chapter shall govern the design, installation, construction, alteration and repair of refrigeration systems that vaporize and liquefy a fluid during the refrigerating cycle. Refrigerant piping design and installation, including pressure vessels and pressure relief devices, shall conform to this code. Permanently installed refrigerant storage systems and other components shall be considered as part of the refrigeration system to which they are attached. This chapter shall also govern the change of refrigerants in existing refrigerating systems having a different safety group classification.

1101.2 Factory-built equipment and appliances. Listed and labeled self-contained, factory-built equipment and appliances shall be tested in accordance with UL 207, 412, 471 or 1995. Such equipment and appliances are deemed to meet the design, manufacture and factory test requirements of this code if installed in accordance with their listing and the manufacturer's [~~installation~~] instructions.

1101.3 Protection. Any portion of a refrigeration system that is subject to physical damage shall be protected in an approved manner.

1101.4 Water connection. Water supply and discharge connections associated with refrigeration systems shall be made in accordance with this code and the *New York City Plumbing Code*.

1101.5 Fuel-oil and fuel-gas connection. Refrigeration system devices, equipment and appliances utilizing fuel oil or fuel gas for combustion shall be installed in accordance with the applicable provisions of the *New York City Fuel Gas Code* and this code.

1101.6 General. Refrigeration systems shall comply with the requirements of this code and, except as modified by this code, ASHRAE 15. Ammonia-refrigerating systems shall comply with this code and, except as modified by this code, ASHRAE 15 and IIAR 2. Such systems shall be maintained in accordance with the *New York City Fire Code*.

1101.7 Maintenance. Mechanical refrigeration systems shall be maintained in proper operating condition, free from accumulations of oil, dirt, waste, excessive corrosion, other debris and leaks.

1101.8 Change in refrigerant type. The type of refrigerant in refrigeration systems having a refrigerant circuit containing more than 220 pounds (99.8 kg) of Group A1 or 30 pounds (13.6 kg) of any other group refrigerant shall not be changed without prior notification to the commissioner and compliance with the applicable code provisions for the new refrigerant type. The refrigerant being considered shall be evaluated for suitability by an engineer. Whenever change in the type of refrigerant is to be done, consideration shall be given to the following:

1. The effects of the substitute refrigerant on materials in the system;

2. The possibility of overloading the liquid receiver, which shall not be more than 80 percent full of liquid;
3. The possibility of exceeding motor rating, design working pressure, or other requirements that would violate any of the provisions of this code;
4. The proper size of refrigerant controls;
5. The effect of the operation and setting of safety devices;
6. The possible hazards created by mixture of the original and the substituted refrigerant; and
7. The effect of the classification of the refrigerant as provided.

1101.9 Refrigerant discharge. Notification of refrigerant discharge shall be provided in accordance with the *New York City Fire Code*.

1101.10 Gas- and oil-fired absorption systems. Refrigeration systems utilizing fuel oil or fuel gas for combustion shall be installed in accordance with the applicable provisions of the *New York City Fuel Gas Code* and this code.

1101.11 Signs, nameplates, and operation and emergency shut-down instructions. Signs, nameplates, and operation and emergency shut-down instructions for refrigeration systems shall comply with the following:

1. Sections 9.15, 11.2.1, 11.2.2, 11.2.4, and 11.7 of ASHRAE 15.
2. Each refrigeration unit or system shall be provided with a nameplate indicating the horsepower of the prime mover or compressor and the equivalent of such horsepower in kilowatts.
3. Section 1105.11 of this code.

1101.12 Locking access port caps. Refrigerant circuit access ports located outdoors shall be fitted with locking-type tamper-resistant caps requiring a special tool or key to open.

SECTION MC 1102 SYSTEM REQUIREMENTS

1102.1 General. The system classification, allowable refrigerants, maximum quantity, enclosure requirements, location limitations, and field pressure test requirements shall be determined as follows:

1. Determine the refrigeration [~~systems~~] system's classification, in accordance with Section 1103.3.
2. Determine the refrigerant classification in accordance with Section 1103.1.
3. Determine the maximum allowable quantity of refrigerant in accordance with Section 1104, based on type of refrigerant, system classification and occupancy.

4. Determine the system enclosure requirements in accordance with Section 1104.
5. Refrigeration equipment and appliance location and installation shall be subject to the limitations of Chapter 3.
6. Nonfactory-tested, field-erected equipment and appliances shall be pressure tested in accordance with Section 1108.

1102.2 Refrigerants. The refrigerant shall be that which the equipment or appliance was designed to utilize or converted to utilize. Refrigerants not identified in Table 1103.1 shall be approved by the department before use. Refrigerants not identified in Table 1103.1, other than those having a Safety Group Classification of A-1, shall also be approved by the Fire Department before use.

1102.2.1 Mixing. Refrigerants, including refrigerant blends, with different designations in ASHRAE 34 shall not be mixed in a system.

Exception: Addition of a second refrigerant is allowed where permitted by the equipment or appliance manufacturer to improve oil return at low temperatures. The refrigerant and amount added shall be in accordance with the manufacturer's instructions.

1102.2.2 Purity. Refrigerants used in refrigeration systems shall be new, recovered or reclaimed refrigerants in accordance with Section 1102.2.2.1, 1102.2.2.2 or 1102.2.2.3. Where required by the equipment or appliance owner, the installer shall furnish a signed declaration that the refrigerant used meets the requirements of Section 1102.2.2.1, 1102.2.2.2 or 1102.2.2.3.

Exception: The refrigerant used shall meet the purity specifications set by the manufacturer of the equipment or appliance in which such refrigerant is used where such specifications are different from that specified in Sections 1102.2.2.1, 1102.2.2.2 and 1102.2.2.3.

1102.2.2.1 New refrigerants. Refrigerants shall be of a purity level specified by the equipment or appliance manufacturer.

1102.2.2.2 Recovered refrigerants. Refrigerants that are recovered from refrigeration and air-conditioning systems shall not be reused in other than the system from which they were recovered and in other systems of the same owner. Recovered refrigerants shall be filtered and dried before reuse. Recovered refrigerants that show clear signs of contamination shall not be reused unless reclaimed in accordance with Section 1102.2.2.3.

1102.2.2.3 Reclaimed refrigerants. Used refrigerants shall not be reused in a different owner's equipment or appliances unless tested and found to meet the purity requirements of [ARI] AHRI 700. Contaminated refrigerants shall not be used unless reclaimed and found to meet the purity requirements of [ARI] AHRI 700.

1102.3 Access port protection. Refrigerant access ports shall be protected in accordance with Section 1101.12 whenever refrigerant is added to or recovered from refrigeration or air-conditioning systems.

SECTION MC 1103
REFRIGERATION SYSTEM CLASSIFICATION

1103.1 Refrigerant classification. Refrigerants shall be classified in accordance with ASHRAE 34 as listed in Table 1103.1.

TABLE 1103.1
REFRIGERANT DATA AND SAFETY CLASSIFICATIONS^a

Refrigerant Number	Chemical Name	Chemical Formula/ Composition Tolerances	OEL ^d ppm v/v	Safety ^c Group	RCL		
					(ppm v/v)	(g/m ³)	lb/M cf
Methane Series							
11 ^b	Trichlorofluoromethane	CCl ₃ F	1,000	A1	1,100	6.2	0.39
12 ^b	Dichlorodifluoromethane	CCl ₂ F ₂	1,000	A1	18,000	90	5.6
13 ^b	Chlorotrifluoromethane	CClF ₃	1,000	A1	-	-	-
13B1 ^b	Bromotrifluoromethane	CBF ₃	1,000	A1	-	-	-
14	tetrafluoromethane (carbon tetrafluoride)	CF ₄	1,000	A1	110,000	400	25
21	Dichlorofluoromethane	CHCl ₂ F	-	B1	-	-	-
22	Chlorodifluoromethane	CHClF ₂	1,000	A1	59,000	210	13
23	Trifluoromethane	CHF ₃	1,000	A1	41,000	120	7.3
30	dichloromethane (methylene chloride)	CH ₂ Cl ₂	-	B2	-	-	-
32	difluoromethane (methylene fluoride)	CH ₂ F ₂	1,000	A2L	36,000	77	4.8
40	chloromethane (methyl chloride)	CH ₃ Cl	-	B2	-	-	-
50	Methane	CH ₄	1,000	A3	-	-	-
Ethane Series							
113 ^b	1,1,2-trichloro-1,2,2- trifluoroethane	CCl ₂ CFClF ₂	1,000	A1	2,600	20	1.2
114 ^b	1,2-dichloro-1,1,2,2- tetrafluoroethane	CClF ₂ CClF ₂	1,000	A1	20,000	140	8.7
115 ^b	Chloropentafluoroethane	CClF ₂ CF ₃	1,000	A1	120,000	760	47
116	Hexafluoroethane	CF ₃ CF ₃	1,000	A1	97,000	550	34
123	2,2-dichloro-1,1,1,- trifluoroethane	CHCl ₂ CF ₃	50	B1	9,100	57	3.5
124	2-chloro-1,1,1,2- tetrafluoroethane	CHClCF ₃	1,000	A1	10,000	56	3.5
125	Pentafluoroethane	CHF ₂ CF ₃	1,000	A1	75,000	370	23
134 ^a	1,1,1,2-tetrafluoroethane	CH ₂ FCF ₃	1,000	A1	50,000	210	13
142 ^b	1-chloro-1, 1-difluoroethane	CH ₃ CClF ₂	1,000	A2	20,000	83	5.1
143 ^a	1,1,1-trifluoroethane	CH ₃ CF ₃	1,000	A2L	21,000	70	4.5
152 ^a	1,1-difluoroethane	CH ₃ CHF ₂	1,000	A2	12,000	32	2.0
170	Ethane	CH ₃ CH ₃	1,000	A3	7,000	8.7	0.54
Ethers							
E170	methoxymethane (dimethyl ether)	CH ₃ OCH ₃	1,000	A3	8,500	16	1.0
Propane							
218	Octafluoropropane	CF ₃ CF ₂ CF ₃	1,000	A1	90,000	690	43
227 ^{ea}	1,1,1,2,3,3,3-heptafluoropropane	CF ₃ CHF ₂ CF ₃	1,000	A1	84,000	580	36
236 ^{fa}	1,1,1,3,3,3-hexafluoropropane	CF ₃ CH ₂ CF ₃	1,000	A1	55,000	340	21
245 ^{fa}	1,1,1,3,3-pentafluoropropane	CHF ₂ CH ₂ CF ₃	300	B1	34,000	190	12
290	Propane	CH ₃ CH ₂ CH ₃	1,000	A3	5,300	9.5	0.56

**TABLE 1103.1
REFRIGERANT DATA AND SAFETY CLASSIFICATIONS^a**

Refrigerant Number	Chemical Name	Chemical Formula/ Composition Tolerances	OEL ^d ppm v/v	Safety ^c Group	RCL		
					(ppm v/v)	(g/m ³)	lb/M cf
Cyclic Organic Compounds							
C318	Octafluorocyclobutane	-(CF ₂) ₄ -	1,000	A1	80,000	660	41
Miscellaneous Organic Compounds Hydrocarbons							
600	Butane	CH ₃ CH ₂ CH ₂ CH ₃	1,000	A3	-	-	0.51
600 ^a	2-methylpropane (isobutane)	CH(CH ₃) ₂ CH ₃	1,000	A3	4,000	9.6	0.59
601	Pentane	CH ₃ CH ₂ CH ₂ CH ₂ CH ₃	600	A3	1,000	2.9	0.18
601 ^a	2-methylbutane (isopentane)	(CH ₃) ₂ CHCH ₂ CH ₃	600	A3	1,000	2.9	0.18
611	methyl formate	HCOOCH ₃	100	B2	-	-	-
Inorganic Compounds							
702	Hydrogen	H ₂	-	A3	-	-	-
704	Helium	He	-	A1	-	-	-
717	Ammonia	NH ₃	25	B2L	320	0.22	0.014
718	Water	H ₂ O	-	A1	-	-	-
720	Neon	Ne	-	A1	-	-	-
728	Nitrogen	N ₂	-	A1	-	-	-
740	Argon	Ar	-	A1	-	-	-
744	carbon dioxide	CO ₂	5000	A1	40,000	72	4.5
764	sulfur dioxide	SO ₂	-	B1	-	-	-
Unsaturated Organic Compounds							
1150	ethene (ethylene)	CH ₂ = CH ₂	200	A3	-	-	-
1234yf	2,3,3,3-tetrafluoro-1-propene	CF ₃ CF = CH ₂	500	A2L	16,000	75	4.7
1234ze(E)	trans-1,3,3,3-tetrafluoro-1-propene	CF ₃ CH = CHF	800	A2L	16,000	75	4.7
1270	propene (propylene)	CH ₃ CH = CH ₂	500	A3	1,000	1.7	0.1
Zetropes (Refrigerant Blends)							
400 (50%/50%) ^b	R-12/114 (50.0/50.0)		1,000	A1	28,000	160	10
400 (60%/40%) ^b	R-12/114 (60.0/40.0)		1,000	A1	30,000	170	11
401A	R-22/152a/124 (53.0/13.0/34.0)	(±2.0/+0.5, -1.5/±1.0)	1,000	A1	27,000	110	6.6
401B	R-22,/152a/124 (61.0/11.0/28.0)	(±2.0/+0.5, -1.5/±1.0)	1,000	A1	30,000	120	7.2
401C	R-22,/152a/124 (33.0/15.0/52.0)	(±2.0/+0.5, -1.5/±1.0)	1,000	A1	20,000	84	5.2
402A	R-125/290/22 (60.0/2.0/38.0)	(±2.0/+0.1, -1.0/±2.0)	1,000	A1	33,000	140	8.5
402B	R-125/290/22 (38.0/2.0/60.0)	(±2.0/+0.1, -1.0/±2.0)	1,000	A1	63,000	240	15
403A	R-290/22/218 (5.0/75.0/20.0)	(+2, -2.0/±2.0/±2.0)	1,000	A2	33,000	120	7.6
403B	R-290/22/218 (5.0/56.0/39.0)	(+2, -2.0/±2.0/±2.0)	1,000	A1	70,000	290	18
404A	R-125/143a/134a (44.0/52.0/4.0)	(±2.0/±1.0/±2.0)	1,000	A1	130,000	500	31
406A	R-22/600a/142b (55.0/4.0/41.0)	(±2.0/±1.0/±1.0)	1,000	A2	21,000	25	4.7
407A	R-32/125/134a (20.0/40.0/40.0)	(±2.0/±2.0/±2.0)	1,000	A1	83,000	300	19
407B	R-32/125/134a (10.0/70.0/20.0)	(±2.0/±2.0/±2.0)	1,000	A1	79,000	330	21
407C	R-32/125/134a (23.0/25.0/52.0)	(±2.0/±2.0/±2.0)	1,000	A1	81,000	290	18
407D	R-32/125/134a (15.0/15.0/70.0)	(±2.0/±2.0/±2.0)	1,000	A1	68,000	250	16
407E	R-32/125/134a (25.0/15.0/60.0)	(±2.0/±2.0/±2.0)	1,000	A1	80,000	280	17

**TABLE 1103.1
REFRIGERANT DATA AND SAFETY CLASSIFICATIONS^a**

Refrigerant Number	Chemical Name	Chemical Formula/ Composition Tolerances	OEL ^d ppm v/v	Safety ^c Group	RCL		
					(ppm v/v)	(g/m ³)	lb/M cf
407F	R-32/125/134a (30.0/30.0/40.0)	(±2.0/±2.0/±2.0)	1,000	A1	95,000	320	20
408A	R-125/143a/22 (7.0/46.0/47.0)	(±2.0/±1.0/±2.0)	1,000	A1	95,000	110	21
409A	R-22/124/142b (60.0/25.0/15.0)	(±2.0/±2.0/±1.0)	1,000	A1	29,000	120	7.1
409B	R-22/124/142b (65.0/25.0/10.0)	(±2.0/±2.0/±1.0)	1,000	A1	30,000	390	7.3
410A	R-32/125 (50.0/50.0)	(+0.5, -1.5/+1.5, -0.5)	1,000	A1	140,000	420	26
410B	R-32/125 (45.0/55.0)	(±1.0/±1.0)	1,000	A1	140,000	430	27
411A	R-1270/22/152a (1.5/87.5/11.0)	(+0.0, -1.0/+2.0, -0.0/+0.0, -1.0)	990	A2	14,000	46	2.9
411B	R-1270/22/152a (3.0/94.0/3.0)	(+0.0, -1.0/+2.0, -0.0/+0.0, -1.0)	980	A2	13,000	45	2.8
412A	R-22/218/142b (70.0/5.0/25.0)	(±2.0/±2.0/±1.0)	1,000	A2	22,000	82	5.1
413A	R-218/134a/600a (9.0/88.0/3.0)	±1.0/±2.0/+0.0,-1.0)	1,000	A2	22,000	95	5.8
414A	R-22/124/600a/142b (51.0/28.5/4.0/16.5)	(±2.0/±2.0/±0.5 / +0.5, -1.0)	1,000	A1	26,000	100	6.4
414B	R-22/124/600a/142b (50.0/39.0/1.5/9.5)	(±2.0/±2.0/±0.5 / +0.5, -1.0)	1,000	A1	23,000	95	6.0
415A	R-22/152a (82.0/18.0)	(±1.0/±1.0)	1,000	A2	57,000	190	12
415B	R-22/152a (25.0/75.0)	(±1.0/±1.0)	1,000	A2	52,000	120	9.3
416A	R-134a/124/600 (59.0/39.5/1.5)	(+0.5, -1.0/+1.0, -0.5/+1.0, -0.2)	1,000	A1	14,000	62	3.9
417A	R-125/134a/600 (46.6/50.0/3.4)	(±1.1/±1.0/+0.1,-0.4)	1,000	A1	13,000	56	3.5
417B	R-125/134a/600 (79.0/18.3/2.7)	(±1.0/±1.0/+0.1,-0.5)	1,000	A1	15,000	70	4.3
418A	R-290/22/152a (1.5/96.0/2.5)	(±0.5/±1.0/±0.5)	1,000	A2	59,000	200	13
419A	R-125/134a/E170 (77.0/19.0/4.0)	(1.0/1.0/1.0)	1,000	A2	70,000	310	19
420A	R-134a/142b (88.0/12.0)	(+1.0,-0.0/+0.0,-1.0)	1,000	A1	45,000	190	12
421A	R-125/134a (58.0/42.0)	(±1.0/±1.0)	1,000	A1	61,000	280	17
421B	R-125/134a (85.0/15.0)	(±1.0/±1.0)	1,000	A1	69,000	330	21
422A	R-125/134a/600a (55.0/42.0/3.0)	(±1.0/±1.0/+0.1,-0.4)	1,000	A1	63,000	290	18
422B	R-125/134a/600a (82.0/15.0/3.0)	(±1.0/±1.0/+0.1,-0.5)	1,000	A1	56,000	250	16
422C	R-125/134a/600a (82.0/15.0/3.0)	(±1.0/±1.0/+0.1,-0.5)	1,000	A1	62,000	290	18
422D	R-125/134a/600a (65.1/31.5/3.4)	(+0.9,-1.1/±1.0/+0.1,-0.4)	1,000	A1	58,000	260	16
423A	R-134a/227ea (52.5/47.5)	(±1.0/±1.0)	1,000	A1	59,000	310	19
424A	R-125/134a/600a/600/601a (50.5/47.0/0.9/1.0/0.6)	(±1.0/±1.0/+0.1,-0.2/ +0.1, +0.2/+0.1,-0.2)	970	A1	23,000	100	6.2
425A	R-32/134a/227ea (18.5/69.5/12.0)	(±0.5/±0.5/±0.5)	1,000	A1	72,000	260	16
426A	R-125/134a/600/601a (5.1/93.0/1.3/0.6)	(±1.0/±1.0/+0.1,-0.2/ +0.1, -0.2)	990	A1	20,000	83	5.2

**TABLE 1103.1
REFRIGERANT DATA AND SAFETY CLASSIFICATIONS^a**

Refrigerant Number	Chemical Name	Chemical Formula/ Composition Tolerances	OEL ^d ppm v/v	Safety ^c Group	RCL		
					(ppm v/v)	(g/m ³)	lb/M cf
427A	R-32/125/143a/134a (15.0/25.0/10.0/50.0)	(±2.0/±2.0/±2.0/±2.0)	1,000	A1	79,000	290	18
428A	R-125/143a/290/600a (77.5/20.0/0.6/1.9)	(±1.0/±1.0/+0.1,- 0.2/ +0.1, -0.2)	1,000	A1	83,000	370	23
429A	R-E170/152a/600a (60.0/10.0/30.0)	(±1.0/±1.0/±1.0)	1,000	A3	6,300	13	0.81
430A	R-152a/600a (76.0/24.0)	(±1.0/±1.0)	1,000	A3	8,000	21	1.3
431A	R-290/152a (71.0/29.0)	(±1.0/±1.0)	1,000	A3	5,500	11	0.69
432A	R-1270/E170 (80.0/20.0)	(±1.0/±1.0)	710	A3	1,200	2.1	0.13
433A	R-1270/290 (30.0/70.0)	(±1.0/±1.0)	880	A3	3,100	5.5	0.34
433B	R-1270/290 (5.0/95.0)	(±1.0/±1.0)	950	A3	4,500	8.1	0.51
433C	R-1270/290 (25.0/75.0)	(±1.0/±1.0)	790	A3	3,600	6.6	0.41
434A	R-125/143a/134a/600a (63.2/18.0/16.0/2.8)	(±1.0/±1.0 ±1.0/+0.1,-0.2)	1,000	A1	73,000	320	20
435A	R-E170/152a (80.0/20.0)	(±1.0/±1.0)	1,000	A3	8,500	17	1.1
436A	R-290/600a (56.0/44.0)	(±1.0/±1.0)	1,000	A3	4,000	8.1	0.5
436B	R-290/600a (52.0/48.0)	(±1.0/±1.0)	1,000	A3	4,000	8.1	0.5
437A	R-125/134a/600/601 (19.5/78.5/1.4/0.6)	(+0.5,-1.8/+1.5,-0.7/ +0.1,-0.2/+0.1,-0.2)	990	A1	19,000	81	5.0
438A	R-32/125/134a/600/601a (8.5/45.0/44.2/1.7/0.6)	(+0.5,- 1.5/±1.5/±1.5/ +0.1,-0.2/+0.1,-0.2)	990	A1	20,000	79	4.9
439A	R-32/125/600a (50.0/47.0/3.0)	(±1.0/±1.0/±0.5)	990	A2	26,000	76	4.7
440A	R-290/134a/152a (0.6/1.6/97.8)	(±1.0/±0.6/±0.5)	1,000	A2	12,000	31	1.9
441A	R-179/290/600a/600 (3.1/54.8/6.0/36.1)	(±0.3/±2.0/±0.6/±2.0)	1,000	A3	3,200	6.3	0.39
Azeotropes (Refrigerant Blends)							
500 ^b	R-12/152a (73.8/26.2)	-	1,000	A1	30,000	120	7.6
501 ^b	R-22/12 (75.0/25.0)	-	1,000	A1	54,000	210	13
502 ^b	R-22/115 (48.8/51.2)	-	1,000	A1	73,000	330	21
504	R-32/115 (48.2/51.8)	-	1,000	-	140,000	450	28
507A	R-125/143a (50.0/50.0)	-	1,000	A1	130,000	520	32
508A	R-23/116 (39.0/61.0)	-	1,000	A1	55,000	220	14
508B	R-23/116 (46.0/54.0)	-	1,000	A1	52,000	200	13
509A	R-22/218 (44.0/56.0)	-	1,000	A1	75,000	390	24
510A	R-E170/600a (88.0/12.0)	(±0.5/±0.5)	1,000	A3	7,300	14	0.87
511A	R-290/E170 (95.0, 5.0)	(±1.0/±1.0)	1,000	A3	5,300	9.5	0.59

For SI: 1 pound = 0.454 kg, 1 cubic foot = 0.0283 m³.

- Data based on ASHRAE 34 including Addenda a through o. For more complete data, see ASHRAE 34 and Addenda. Use of Addenda issued after Addendum o is subject to approval as set forth in Section 1102.2.
- Class I ozone depleting refrigerant. Not permitted for new installations.
- Refrigerants in Safety Group "A2L" shall comply with all applicable requirements for "A2" refrigerants. Refrigerants in Safety Group "B2L" shall comply with all applicable requirements for "B2" refrigerants.
- OCCUPATIONAL EXPOSURE LIMIT (OEL).** The time-weighted average (TWA) concentration for a normal eight-hour workday and a 40-hour workweek to which nearly all workers can be repeatedly exposed without adverse effect, based on the OSHA PEL, ACGIH TLV-TWA, AIHA WEEL, or consistent value.

1103.2 Occupancy classification. Locations of refrigerating systems are described by occupancy classifications that consider the ability of people to respond to potential exposure to refrigerants.

Where equipment or appliances, other than piping, are located outside a building and within 20 feet (6096 mm) of any building opening, such equipment or appliances shall be governed by the occupancy classification of the building. Occupancy classifications of buildings shall be [∴] in accordance with the building classifications in the *New York City Building Code*.

1. Institutional occupancy shall include Occupancy Groups I-1, I-2, I-3 and I-4.
2. Public assembly occupancy shall include Occupancy Groups A-1, A-2, A-3, A-4, A-5 and E.
3. Residential occupancy shall include Occupancy Groups R-1, R-2 and R-3.
4. Commercial occupancy shall include Occupancy Groups M and B, except Occupancy Group M with retail stores having an occupant load of more than 100 persons on any floor other than street level.
5. Large mercantile occupancy shall include Occupancy Group M with retail stores having an occupant load of more than 100 persons on any floor other than street level.
6. Industrial occupancy shall include Occupancy Groups F-1, F-2, H-1, H-2, H-3, H-4, H-5, S-1 and S-2.
7. Mixed occupancy occurs [~~when~~] where two or more occupancies are located within the same building. [~~When~~] Where each occupancy is isolated from the rest of the building by tight walls, floors and ceilings and by self-closing doors, the requirements for each occupancy shall apply to its portion of the building. [~~When~~] Where the various occupancies are not so isolated, the occupancy having the most stringent requirements shall be the governing occupancy.

1103.3 System classification. Refrigeration systems shall be classified according to the degree of probability that refrigerant leaked from a failed connection, seal or component could enter an occupied area. The distinction is based on the basic design or location of the components.

1103.3.1 Low-probability systems. Double-indirect open-spray systems, indirect closed systems and indirect-vented closed systems shall be classified as low-probability systems, provided that all refrigerant-containing piping and fittings are isolated when the quantities in Table 1103.1 are exceeded.

1103.3.2 High-probability systems. Direct systems and indirect open-spray systems shall be classified as high-probability systems.

Exception: An indirect open-spray system shall not be required to be classified as a high-probability system if the pressure of the secondary coolant is at all times (operating and standby) greater than the pressure of the refrigerant.

SECTION MC 1104 SYSTEM APPLICATION REQUIREMENTS

1104.1 General. The refrigerant, occupancy and system classification cited in this section shall be determined in accordance with Sections 1103.1, 1103.2 and 1103.3, respectively. For refrigerant blends assigned dual classifications, as formulated and for the worst case of fractionation, the

classifications for the worst case of fractionation shall be used. For blends assigned only a single safety group classification in Table 1103.1 or ASHRAE 34, that classification shall be used. Use of a Group A3 or Group B3 refrigerant is prohibited. In an industrial occupancy, a Group A3 or Group B3 refrigerant may be used in high- or low-probability systems only when approved by the commissioner and the Commissioner of the Fire Department. Such use will be approved only if the applicant can demonstrate to the satisfaction of the commissioner and the Commissioner of the Fire Department that the use of the refrigerant is a necessity and does not represent a substantial risk to life, limb, health or property.

1104.2 Machinery room. Except as provided in Sections 1104.2.1 and 1104.2.2, all components containing the refrigerant shall be located either outdoors or in a machinery room where the quantity of refrigerant in an independent circuit of a system exceeds the amounts shown in Table 1103.1. For refrigerant names not listed in Table 1103.1, the same requirement shall apply when the amount for any named component exceeds that indicated in Table 1103.1 for that component. This requirement shall also apply when the combined amount of the named components exceeds a limit of 69,100 parts per million (ppm) by volume. Machinery rooms required by this section shall be constructed and maintained in accordance with Section 1105 for Group A1 and B1 refrigerants and in accordance with Sections 1105 and 1106 for Group A2, B2, A3 and B3 refrigerants. Nothing in this section shall be construed to allow the use of Group A3 and B3 refrigerants if otherwise prohibited.

Exceptions:

1. Machinery rooms are not required for listed equipment and appliances containing not more than 6.6 pounds (3 kg) of refrigerant, regardless of the refrigerant's safety classification, where installed in accordance with the equipment's or appliance's listing and the equipment or appliance manufacturer's installation instructions.
2. Piping in conformance with Section 1107 of this chapter and Section 8.10 of ASHRAE 15 is allowed in other locations to connect components installed in a machinery room with those installed outdoors.

1104.2.1 Institutional occupancies. The amounts shown in Table 1103.1 shall be reduced by 50 percent for all areas of institutional occupancies except kitchens, laboratories and mortuaries. The total of all Group A2, B2, A3 and B3 refrigerants shall not exceed 550 pounds (~~[250]~~ 249.4 kg) in occupied areas or machinery rooms. Nothing in this section shall be construed to allow the use of Group A3 and B3 refrigerants if otherwise prohibited.

1104.2.2 Industrial occupancies and refrigerated rooms. This section applies only to industrial occupancies and refrigerated rooms for manufacturing, food and beverage preparation, meat cutting, other processes and storage. Machinery rooms are not required where all of the following conditions are met:

1. The space containing the machinery is separated from other occupancies by tight construction with tight-fitting doors.
2. Access is restricted to authorized personnel.

3. The floor area per occupant is not less than 100 square feet (9.3 m²). Where provided with egress directly to the outdoors or into building exits meeting the requirements of the *New York City Building Code*, the minimum floor area shall not apply.
4. Refrigerant detectors are installed as required for machinery rooms in accordance with Section 1105.3.
5. Surfaces having temperatures exceeding 800°F ([427] 426.7°C) and open flames are not present where any Group A2, B2, A3 or B3 refrigerant is used (see Section 1104.3.3). Nothing in this section shall be construed to allow the use of Group A3 and B3 refrigerants if otherwise prohibited.
6. All electrical equipment and appliances conform to Class 1, Division 2, hazardous location classification requirements of the *New York City Electrical Code* where the quantity of any Group A2, B2, A3 or B3 refrigerant, other than ammonia, in a single independent circuit would exceed 25 percent of the lower flammability limit (LFL) upon release to the space based on the volume determined by Section 1104.4. Nothing in this section shall be construed to allow the use of Group A3 and B3 refrigerants if otherwise prohibited.
7. All refrigerant-containing parts in systems exceeding 100 hp (74.6 kW) drive power, except evaporators used for refrigeration or dehumidification; condensers used for heating; control and pressure relief valves for either; and connecting piping, shall be located either outdoors or in a machinery room.

1104.3 Refrigerant restrictions. Refrigerant applications, maximum quantities and use shall be restricted in accordance with Sections 1104.3.1 through 1104.3.3.

1104.3.1 Air-conditioning for human comfort. Group A2, A3, B1, B2 and B3 refrigerants shall not be used in high-probability air-conditioning systems for human comfort.

Exceptions:

1. Sealed absorption and unit air-conditioning systems having refrigerant quantities not exceeding those set forth in Table 1104.3.1.
2. Industrial occupancies.

Nothing in this section shall be construed to allow the use of Group A3 and B3 refrigerants if otherwise prohibited.

**TABLE 1104.3.1
SPECIAL QUANTITY LIMITS FOR SEALED AMMONIA/WATER ABSORPTION
AND SELF-CONTAINED SYSTEMS**

TYPE OF REFRIGERATION SYSTEM	MAXIMUM [Hb] POUNDS FOR VARIOUS OCCUPANCIES			
	Institutional	Public Assembly/ Large Mercantile	Residential	Commercial
Sealed Ammonia/Water Absorption System				
In exit access or lobbies	0	0	3.3	3.3
In adjacent outdoor locations	0	0	22	22
In other than exit access or lobbies	0	6.6	6.6	22
Unit Systems				
In other than exit access or lobbies	0	0	6.6	22

For SI: 1 pound = 0.454 kg.

1104.3.2 All occupancies. The total of all Group A2, B2, A3 and B3 refrigerants other than R-717, ammonia, shall not exceed 1,100 pounds (499 kg) except where approved. Nothing in this section shall be construed to allow the use of Group A3 and B3 refrigerants if otherwise prohibited.

1104.3.3 Protection from refrigerant decomposition. Where any device having an open flame or surface temperature greater than 800°F ([427] 426.7°C) is used in a room containing more than 6.6 pounds (3 kg) of refrigerant in a single independent circuit, a hood and exhaust system shall be provided in accordance with Section 510. Such exhaust system shall exhaust combustion products to the outdoors.

Exception: A hood and exhaust system shall not be required where any of the following apply:

1. [~~Where~~] The refrigerant is R-717, R-718 or R-744 [;].
2. [~~Where the~~] The combustion air is ducted from the outdoors in a manner that prevents leaked refrigerant from being combusted [; ~~or~~].
3. [~~Where a~~] A refrigerant detector is used to stop the combustion in the event of a refrigerant leak (see Sections 1105.3 and 1105.5).

1104.4 Volume calculations. Volume calculations shall be in accordance with Sections 1104.4.1 through 1104.4.3.

1104.4.1 Noncommunicating spaces. Where the refrigerant-containing parts of a system are located in one or more spaces that do not communicate through permanent openings or HVAC ducts, the volume of the smallest, enclosed occupied space shall be used to determine the permissible quantity of refrigerant in the system.

1104.4.2 Communicating spaces. Where an evaporator or condenser is located in an air duct system, the volume of the smallest, enclosed occupied space served by the duct system shall be used to determine the maximum allowable quantity of refrigerant in the system.

Exception: If airflow to any enclosed space cannot be reduced below one-quarter of its maximum, the entire space served by the air duct system shall be used to determine the maximum allowable quantity of refrigerant in the system.

1104.4.3 Plenums. Where the space above a suspended ceiling is continuous and part of the supply or return air plenum system, this space shall be included in calculating the volume of the enclosed space.

SECTION MC 1105 MACHINERY ROOM, GENERAL REQUIREMENTS

1105.1 Design and construction. Machinery rooms shall be designed and constructed in accordance with the *New York City Building Code* and this section.

1105.2 Openings. Ducts and air handlers in the machinery room that operate at a lower pressure than the room shall be sealed to prevent any refrigerant leakage from entering the airstream.

1105.3 Refrigerant detector. Refrigerant detectors in machinery rooms shall be provided as required by ASHRAE 15.

1105.4 Tests. Periodic tests of the mechanical ventilating system shall be performed in accordance with manufacturer's specifications and as required by the Commissioner of the Fire Department.

1105.5 Fuel-burning appliances. Open flames that use combustion air from the machinery room shall not be installed in a machinery room.

Exceptions:

1. Where the refrigerant is carbon dioxide or water.
2. Fuel-burning appliances shall not be prohibited in the same machinery room with refrigerant-containing equipment or appliances where combustion air is ducted from outside the machinery room and sealed in such a manner as to prevent any refrigerant leakage from entering the combustion chamber, or where a refrigerant vapor detector is employed to automatically shut off the combustion process in the event of refrigerant leakage.

1105.6 Ventilation. Machinery rooms shall be mechanically ventilated to the outdoors. [~~Mechanical ventilation shall be capable of exhausting the minimum quantity of air both at normal operating and emergency conditions. Multiple fans or multispeed fans shall be allowed in order to produce the emergency ventilation rate and to obtain a reduced airflow for normal ventilation.~~] Location of the mechanical ventilation openings within the machinery room shall be based on the relative density of the refrigerant to air. When compressors or self-contained unit system are housed in a machinery space, other than in a machinery room or plenum, the space shall be ventilated in accordance with the requirements of Section 1105.6.3.

Exception: Where a refrigerating system is located outdoors more than 20 feet (6096 mm) from any building opening and is enclosed by a penthouse, lean-to or other open structure, natural or mechanical ventilation shall be provided. Location of the openings shall be based on the relative

density of the refrigerant to air. The free-aperture cross section for the ventilation of the machinery room shall be not less than:

$$F = \sqrt{G} \quad \text{(Equation 11-1)}$$

For SI: $F = 0.138\sqrt{G}$

where:

F = The free opening area in square feet (m^2).

G = The mass of refrigerant in pounds (kg) in the largest system, any part of which is located in the machinery room.

1105.6.1 Discharge location. The discharge of the air shall be to the outdoors in accordance with Chapter 5. Exhaust from mechanical ventilation systems shall be discharged not less than 20 feet (6096 mm) from outdoor air intake or openings into buildings and 10 feet (3048 mm) from a fire escape or exterior stair.

1105.6.2 Makeup air. Provisions shall be made for makeup air to replace that being exhausted. Openings for makeup air shall be located to avoid intake of exhaust air. Supply and exhaust ducts ~~that~~ servicing the machinery room shall not serve ~~any~~ any other area, shall be constructed in accordance with Chapter 5 and shall be covered with corrosion-resistant screen of not less than ¼-inch (6.4 mm) mesh.

Exception: The requirement for supply and exhaust ducts to the machinery room to serve no other area shall not apply to a change in the type of refrigerant in a lawfully installed existing refrigerating system being maintained and operated in accordance with these approved installation requirements:

1. Where the replacement refrigerant has a safety classification of Group A1; or
2. Where the replacement refrigerant is R123 and the engineer or architect demonstrates to the satisfaction of the commissioner that providing such air supply and exhaust ducts represents a hardship and that the proposed alternative provides an equivalent level of safety.

1105.6.3 Ventilation rate. For other than ammonia systems, the mechanical ventilation systems shall be capable of exhausting the minimum quantity of air both at normal operating and emergency conditions, as required by Sections 1105.6.3.1 and 1105.6.3.2. The minimum required ventilation rate for ammonia shall be 30 air changes per hour in accordance with IIAR2. Multiple fans or multispeed fans shall be allowed to produce the emergency ventilation rate and to obtain a reduced airflow for normal ventilation.

1105.6.3.1 Quantity-normal ventilation. During occupied conditions, the mechanical ventilation system shall exhaust the larger of the following:

1. Not less than 0.5 cfm per square foot ($0.0025\text{m}^3/\text{s m}^2$) of machinery room area or 20 cfm ($0.009\text{ m}^3/\text{s}$) per person ~~per~~.

2. A volume required to limit the room temperature rise to 18°F ([10] -7.8°C) taking into account the ambient heating effect of all machinery in the room but not above a maximum temperature of 122°F (50°C).

[1105.6.4] 1105.6.3.2 Quantity-emergency conditions. Upon actuation of the refrigerant detector required in Section 1105.3, the mechanical ventilation system shall exhaust air from the machinery room in the following quantity:

$$Q = 100 \times \sqrt{G} \quad \text{(Equation 11-2)}$$

For SI: $Q = 0.07 \times \sqrt{G}$

where:

Q = The airflow in cubic feet per minute (m³/s).

G = The design mass of refrigerant in pounds (kg) in the largest system, any part of which is located in the machinery room.

1105.7 Termination of relief devices. In addition to the requirements of Section 9.7.8 of ASHRAE 15, pressure relief devices, fusible plugs and purge systems located within the machinery room shall terminate outside of the structure at a location not less than 15 feet (4572 mm) above the adjoining grade level and not less than 20 feet (6096 mm) from any window, ventilation opening or exit.

1105.7.1 Discharge of Group A2, B2, A3 and B3 refrigerants. Discharge of systems containing Group A2 or B2 refrigerants shall be acceptable to the commissioner. Discharge of systems containing Group A3 or B3 refrigerants shall be subject to the approval of the commissioner and the Commissioner of the Fire Department. Nothing in this section shall be construed to approve the use of Group A3 and B3 refrigerants if otherwise prohibited.

1105.7.2 Certificate of qualification. Discharge of pressure relief devices, fusible plugs and purge systems for refrigerating systems containing flammable, toxic and highly toxic refrigerants and ammonia shall comply with Section 606 of the *New York City Fire Code*.

1105.8 Ammonia discharge. Pressure relief valves for ammonia systems shall discharge in accordance with ASHRAE 15.

1105.9 Emergency pressure control system. ~~[Refrigeration]~~ Permanently installed refrigeration systems containing more than 6.6 pounds (3 kg) of a refrigerant other than a Group A1 refrigerant shall be provided with an emergency pressure control system in accordance with Sections 1105.9.1 and 1105.9.2.

1105.9.1 Automatic crossover valves. Each high- and intermediate-pressure zone in a refrigerating system shall be provided with a single automatic valve providing a crossover connection to a lower pressure zone. Such automatic crossover valves shall comply with Sections 1105.9.1.1 through 1105.9.1.3.

1105.9.1.1 Overpressure limit setpoint. Automatic crossover valves shall be arranged to automatically relieve excess system pressure to a lower pressure zone if the pressure in a high-

or intermediate-pressure zone rises to within 15 psi (108.4 kPa) of the [~~set point~~] setpoint for pressure-relief devices.

1105.9.1.2 Manual operation. Automatic crossover valves shall be capable of manual operation for refrigeration systems containing more than 200 pounds (90.8 kg) of refrigerant.

1105.9.1.3 System design pressure. Refrigerating system zones that are connected to a higher pressure zone by an automatic crossover valve shall be designed to safely contain the maximum pressure that can be achieved by interconnection of the two zones.

1105.9.2 Automatic emergency stop. An automatic emergency stop feature shall be provided in accordance with Sections 1105.9.2.1 and 1105.9.2.2.

1105.9.2.1 Automatic crossover valves. A refrigerating system equipped with an automatic crossover valve shall be designed, when such valve is activated, to cause all compressors on the affected system to immediately cease operating. Dedicated pressure-sensing devices located immediately adjacent to crossover valves may be used as a means for activating such crossover valve. To ensure that the automatic crossover valve system provides a redundant means of ceasing operation of the compressors in an overpressure condition, high-pressure cutout sensors associated with compressors shall not be used for purposes of activating such crossover valve.

1105.9.2.2 Overpressure in low-pressure zone. The lowest pressure zone in a refrigerating system shall be provided with a dedicated means of determining a rise in system pressure to within 15 psi (103.4 kPa) of the zone pressure relief device setpoint. Activation of such overpressure sensing device shall cause all compressors on the effected system to immediately cease operation.

1105.10 Remote control. A clearly identified switch of the break-glass type shall provide off-only control of the compressors in the machinery room. A second clearly identified switch of the break-glass type shall provide on-only control of the machinery room ventilation fans. Such switches shall be located outside each entrance to the machinery room and as close to the entrance as practicable, except that when an outside location is impracticable, such switches may be located immediately inside the machinery room provided such location is accessible at all times.

1105.11 Emergency signs. Signs shall comply with the following:

1. Sections 8.11.8 and 11.2.4 of ASHRAE 15.
2. Refrigeration units or systems having a refrigerant circuit containing more than 220 pounds ([~~100~~] 99.8 kg) of Group A1 or 30 pounds ([~~14~~] 13.6 kg) of any other group refrigerant shall be provided with approved emergency signs, charts, and labels in accordance with NFPA 704.

1105.12 Storing refrigerant. The total amount of refrigerant stored in a machinery room shall be the lesser of: (i) not more than twenty percent of the normal charge in the system; or (ii) not more than 330 pounds ([~~150~~] 149.7 kg) in addition to the charge in the system and the refrigerant contained

in a permanently attached receiver. Refrigerant shall be stored in containers meeting the requirements of the *New York City Fire Code*.

Exception: Recovery service containers used for storing refrigerant during periods of system maintenance or replacement may exceed 330 pounds (~~150~~ 149.7 kg) provided such containers are securely fixed in position and have pressure relief valves piped to the outside in conformance with this code.

SECTION MC 1106 MACHINERY ROOM, SPECIAL REQUIREMENTS

1106.1 General. Where required by Section 1104.2, the machinery room shall meet the requirements of this section in addition to the requirements of Section 1105.

1106.2 Elevated temperature. There shall not be an open flame-producing device or continuously operating hot surface over 800°F (~~427~~ 426.7°C) permanently installed in the room.

1106.3 Ammonia room ventilation. Ventilation systems in ammonia machinery rooms shall be operated continuously at the [~~emergency~~] ventilation rate [~~determined in accordance with Section 1105.6.4.~~] specified in Section 1105.6.3.

Exceptions:

1. Machinery rooms equipped with a vapor detector that will automatically start the ventilation system at the [~~emergency~~] ventilation rate [~~determined in accordance with Section 1105.6.4.~~] specified in Section 1105.6.3 and that will actuate an alarm at a detection level not to exceed 1,000 ppm [~~±0%~~].
2. Machinery rooms conforming to the Class 1, Division 2, hazardous location classification requirements of the *New York City Electrical Code*.

1106.4 Flammable refrigerants. Where refrigerants of Groups A2, A3, B2 [~~and~~] or B3 are used, the machinery room shall conform to the Class 1, Division 2, hazardous location classification requirements of the *New York City Electrical Code*.

Exception: Ammonia machinery rooms that are provided with ventilation in accordance with Section 1106.3. Nothing in this section shall be construed to approve the use of Group A3 and B3 refrigerants if otherwise prohibited.

1106.5 Remote controls. Remote control of the mechanical equipment and appliances located in the machinery room shall be provided at an accessible location immediately outside the machinery room and adjacent to its principal entrance and shall comply with Sections 1106.5.1 and 1106.5.2.

1106.5.1 Refrigeration system emergency shutoff. A clearly identified switch of the break-glass type or an approved tamper-resistant switch shall provide off-only control of [~~all electrically energized equipment and appliances in the machinery room, other than refrigerant leak detectors and machinery room ventilation.~~] refrigerant compressors, refrigerant pumps, and normally closed, automatic refrigerant valves located in the machinery room. Additionally, this equipment shall be automatically shut off whenever the refrigerant vapor concentration in the machinery

room exceeds the vapor detector's upper detection limit or 25 percent of the LEL, whichever is lower.

1106.5.2 Ventilation system. A clearly identified switch of the break-glass type or an approved tamper-resistant switch shall provide on-only control of the machinery room ventilation fans.

1106.6 Reserved.

SECTION MC 1107 REFRIGERANT PIPING

1107.1 General. ~~[A#]~~ The design of refrigerant piping shall be in accordance with ASME B31.5. Refrigerant piping shall be installed, tested and placed in operation in accordance with this chapter.

1107.1.1 Protection of refrigerant piping located inside buildings. All refrigerant piping and fittings installed at a height less than 7 feet 3 inches (~~[2210]~~ 2209.8 mm) above the floor shall be concealed or otherwise protected from mechanical damage except at the point of connection to terminal equipment.

1107.2 Piping location. Refrigerant piping that crosses an open space that affords passageway in any building shall be not less than 7 feet 3 inches (~~[2210]~~ 2209.8 mm) above the floor unless the piping is located against the ceiling of such space. Refrigerant piping shall not be placed in any elevator, dumbwaiter or other shaft containing a moving object or in any shaft that has openings to living quarters or to means of egress. Refrigerant piping shall not be installed in an enclosed public stairway, ~~[stair]~~ stairway landing or an exit.

1107.2.1 Piping in public corridors. Refrigerant piping shall not be installed in public corridors.

Exception: Refrigerant piping in public corridors that complies with ~~[a#]~~ either of the following conditions:

1. ~~[The refrigeration system to which the piping is associated utilizes a Group A-1 refrigerant and contains not more than 10 pounds (4.54 kg) of refrigerant per system, and there is not more than one system's refrigerant piping per tenant per public corridor; and]~~ Piping containing Group A1 refrigerant may be located in public corridors provided that the complete discharge of any one refrigerant system into the public corridor will not result in a refrigerant density equal to or greater than 50 percent of the allowable density set forth in Table 1103.1; and
 - 1.1. There is not more than one refrigerant system's piping per tenant; and
 - 1.2. Refrigerant piping and fittings are concealed or otherwise protected from mechanical damage; and either
 - 1.3. Refrigerant piping and fittings are installed with brazed joints; or
 - 1.4. The refrigerant equipment manufacturer provided pre-charged tubing systems installed in accordance with the refrigerant equipment manufacturer's instructions;

2. ~~[A complete discharge of any one refrigerant system's charge into the volume of the public corridor would be insufficient to achieve 50 percent of the allowable refrigerant densities set forth in Table 1103.1; and] Piping containing Group A1 refrigerant may be located in public corridors provided that the complete discharge of any one refrigerant system into the public corridor will not result in a refrigerant density of 100 percent of the allowable refrigerant density set forth in Table 1103.1; and
 - 2.1. Such system is provided with fast-acting shutoff valves on both high and low pressure refrigerant line sets, actuated by either local refrigerant monitors in the corridor, or on sensing a drop in pressure on either high or low pressure refrigerant line sets; and
 - 2.2. Upon accidental discharge, actuation of installed refrigerant shutoff valves shall initiate locally installed alarm; and
 - 2.3. Installation of fast-acting shutoff valves, refrigerant detectors, and alarms shall be in accordance with Appendix C; and
 - 2.4. There is not more than one refrigerant system's piping per tenant; and
 - 2.5. Refrigerant piping and fittings are concealed or otherwise protected from mechanical damage; and either
 - 2.6. Refrigerant piping and fittings are installed with brazed joints; or
 - 2.7. The refrigerant equipment manufacturer provided pre-charged tubing systems installed in accordance with the refrigerant equipment manufacturer's instructions.~~
- ~~[3. Refrigerant piping and fittings within a public corridor are installed with brazed joints or the refrigerant equipment manufacturer provided pre-charged tubing systems installed in accordance with the refrigerant equipment manufacturer's instructions. Refrigerant piping and fittings shall be concealed or otherwise protected from mechanical damage.]~~

1107.2.2 Piping in concrete floors. Refrigerant piping installed in concrete floors shall be encased in pipe ducts. The piping shall be isolated and supported to prevent damaging vibration, stress and corrosion.

1107.2.3 Refrigerant piping penetrations. Refrigerant piping shall not penetrate floors, ceilings or roofs.

Exceptions:

1. Penetrations connecting the basement and the first floor.
2. Penetrations connecting the top floor and a machinery penthouse or roof installation.
3. Penetrations connecting adjacent floors served by the refrigeration system.

4. Penetrations by piping in a direct system where the refrigerant quantity does not exceed Table 1103.1 for the smallest occupied space through which the piping passes.

5. Penetrations by piping in a direct system complying with Section 1107.2.3.1.

~~[5-]~~ 6. In other than industrial occupancies and where the refrigerant quantity exceeds Table 1103.1 for the smallest space, penetrations for piping that connects separate pieces of equipment that are either:

~~[5-1-]~~ 6.1. Enclosed by an approved gas-tight, fire-resistive duct or shaft with openings to those floors served by the refrigeration system; or

~~[5-2-]~~ 6.2. Located on the exterior of the building where vented to the outdoors or to the space served by the system and not used as an air shaft, closed court or similar space.

1107.2.3.1 Direct systems. Piping containing a quantity of Group A1 refrigerants in excess of Table 1103.1 for the smallest occupied space through which the piping passes, shall comply with Section 1107.9.

1107.3 Pipe enclosures. Rigid or flexible metal enclosures or pipe ducts shall be provided for soft, annealed copper tubing used for refrigerant piping erected on the premises and containing other than Group A1 refrigerant. Enclosures shall not be required for connections between condensing units and the nearest riser box(es), provided such connections do not exceed 6 feet (~~[1829]~~ 1828.8 mm) in length.

1107.4 Condensation. ~~[All refrigerating]~~ Refrigerating piping and fittings, brine piping and fittings that, during normal operation, will reach a surface temperature below the dew point of the surrounding air, and are located in spaces or areas where condensation will cause a safety hazard to the building occupants, structure, electrical equipment or any other equipment or appliances, shall be protected in an approved manner to prevent such damage.

1107.5 Materials for refrigerant pipe and tubing. Piping materials shall be as set forth in Sections 1107.5.1 through 1107.5.7.

1107.5.1 Steel pipe. Carbon steel pipe with a wall thickness not less than Schedule 80 shall be used for Group A2, A3, B2 or B3 refrigerant liquid lines for sizes 1.5 inches (~~[38]~~ 38.1 mm) and smaller. Carbon steel pipe with a wall thickness not less than Schedule 40 shall be used for Group A1 or B1 refrigerant liquid lines 6 inches (~~[152]~~ 152.4 mm) and smaller, Group A2, A3, B2 or B3 refrigerant liquid lines sizes 2 inches (~~[51]~~ 50.8 mm) through 6 inches (~~[152]~~ 152.4 mm) and all refrigerant suction and discharge lines 6 inches (~~[152]~~ 152.4 mm) and smaller. Type F steel pipe shall not be used for refrigerant lines having an operating temperature less than -20°F (~~[-29]~~ -28.9°C).

1107.5.2 Copper and brass pipe. Standard iron-pipe size, copper and red brass (not less than 80-percent copper) pipe shall conform to ASTM B 42 and ASTM B 43.

1107.5.3 Copper tube. Copper tube used for refrigerant piping erected on the premises shall be seamless copper tube of Type ACR (hard or annealed) complying with ASTM B 280. Where approved, copper tube for refrigerant piping erected on the premises shall be seamless copper tube of Type K or L (drawn or annealed) in accordance with ASTM B 88. Annealed temper copper tube shall not be used in sizes larger than a 2-inch (~~54~~ 50.8 mm) nominal size. Mechanical joints shall not be used on annealed temper copper tube in sizes larger than 7/8-inch (22.2 mm) OD size.

1107.5.4 Copper tubing joints. Copper tubing joints used in refrigerating systems containing Group A2, A3, B1, B2 or B3 refrigerants shall be brazed. Soldered joints shall not be used in such refrigerating systems. Brazed joints shall be made in accordance with ASME Boiler and Pressure Vessel Code, Section IX Welding and Brazing Qualifications or in accordance with American Welding Society AWS B2.2 Standard for Brazing Procedure and Performance Qualification.

1107.5.5 Soldered joints. Soldered joints shall be made as follows: soldered joint surfaces shall be cleaned, a flux conforming to ASTM B 813 shall be applied, and the joint shall be soldered with a solder conforming to ASTM B 32.

1107.5.6 Aluminum tube. Type 3 003-0 aluminum tubing with high-pressure fittings shall not be used with methyl chloride and other refrigerants known to deteriorate aluminum.

1107.5.7 Insulation. Pipe and other refrigerant-containing components' insulation shall meet the requirements of Section 1204.1 of this code.

1107.6 Joints and refrigerant-containing parts in air ducts. Joints and all refrigerant-containing parts of a refrigerating system located in an air duct of an air-conditioning system carrying conditioned air to and from human-occupied space shall be constructed to withstand, without leakage, a pressure of 150 percent of the higher of the design pressure or pressure relief device setting.

1107.7 Exposure of refrigerant pipe joints. Refrigerant pipe joints erected on the premises shall be exposed for visual inspection prior to being covered or enclosed.

1107.8 Stop valves. ~~[All systems]~~ Systems containing more than 6.6 pounds (3 kg) of a refrigerant in systems using positive-displacement compressors shall have stop valves installed as follows:

1. At the inlet of each compressor, compressor unit or condensing unit.
2. At the discharge outlet of each compressor, compressor unit or condensing unit and of each liquid receiver.

Exceptions:

1. Systems that have a refrigerant pumpout function capable of storing the entire refrigerant charge in a receiver or heat exchanger.
2. Systems that are equipped with provisions for pumpout of the refrigerant using either portable or permanently installed recovery equipment.
3. Self-contained systems.

1107.8.1 Liquid receivers. [~~All systems~~] Systems containing 100 pounds ([45] 45.4 kg) or more of a refrigerant, other than systems utilizing nonpositive displacement compressors, shall have stop valves, in addition to those required by Section [1107.7] 1107.8, on each inlet of each liquid receiver. Stop valves shall not be required on the inlet of a receiver in a condensing unit, nor on the inlet of a receiver which is an integral part of the condenser.

1107.8.2 Copper tubing. Stop valves used with soft annealed copper tubing or hard-drawn copper tubing ⁷/₈-inch (22.2 mm) OD standard size or smaller shall be securely mounted, independent of tubing fastenings or supports.

1107.8.3 Identification. Stop valves shall be identified where their intended purpose is not obvious. Numbers shall not be used to label the valves, unless a key to the numbers is located near the valves.

1107.9 Alternative refrigerant piping safety. Where refrigerant piping penetrates floors, ceilings, or roofs pursuant to Section 1107.2.3, it shall comply with the alternative safety requirements of Sections 1107.9.1 through 1107.9.5.

1107.9.1 Nongas tight enclosures. Where refrigerant piping and fittings pass through public corridors or occupied spaces in shafts or cavities that are not gas tight, such piping and fittings shall comply with the requirements of EN378 Part 1, Section 3.2.3.

1107.9.2 Occupied spaces. Refrigerant piping systems in occupied spaces shall comply with the requirements of EN378 Part 1, Section C.3.2.1.

1107.9.2.1 Space volume calculations. Space volume calculations shall comply with EN378 Part 1, Section 7.

1107.9.2.2 Dilution transfer openings. Where required, dilution transfer openings shall be provided in accordance with EN378 Part 3, Section 6.3.2.

1107.9.3 Refrigerant shutoff valves. Where required, refrigerant shutoff valves shall comply with the requirements of EN378 Part 3, Sections 6.4.1 through 6.4.3.

1107.9.4 Refrigerant safety alarms. Where required, refrigerant safety alarms shall comply with the requirements of EN378 Part 3, Sections 8.1 through 8.2.

1107.9.5 Refrigerant detectors. Where required, refrigerant detectors shall comply with the requirements of EN378 Part 3, Section 9.3.1.

SECTION MC 1108 FIELD TEST

1108.1 General. Every refrigerant-containing part of every system that is erected on the premises, except compressors, condensers, vessels, evaporators, safety devices, pressure gauges and control mechanisms that are listed and factory tested, shall be tested and proved tight after complete installation, and before operation. Tests shall include both the high- and low-pressure sides of each system at not less than the lower of the design pressures or the setting of the pressure relief device(s).

The design pressures for testing shall be those listed on the condensing unit, compressor or compressor unit name-plate, as required by ASHRAE 15.

Exceptions:

1. Gas bulk storage tanks that are not permanently connected to a refrigeration system.
2. Systems using an A1 refrigerant erected on the premises with copper tubing not exceeding $\frac{5}{8}$ -inch (15.8 mm) OD, with wall thickness as required by ASHRAE 15, shall be tested in accordance with Section 1108.1, or by means of refrigerant charged into the system at the saturated vapor pressure of the refrigerant at 70°F (~~[24]~~ 21.1°C) or higher.
3. Limited-charge systems equipped with a pressure relief device, erected on the premises, shall be tested at a pressure not less than one and one-half times the pressure setting of the relief device. If the equipment or appliance has been tested by the manufacturer at one and one-half times the design pressure, the test after erection on the premises shall be conducted at the design pressure.

1108.1.1 Booster compressor. Where a compressor is used as a booster to obtain an intermediate pressure and discharges into the suction side of another compressor, the booster compressor shall be considered a part of the low side, provided that it is protected by a pressure relief device.

1108.1.2 Centrifugal/nonpositive displacement compressors. In field-testing systems using centrifugal or other nonpositive displacement compressors, the entire system shall be considered as the low-side pressure for field test purposes.

1108.2 Test gases. Tests shall be performed with an inert dried gas including, but not limited to, nitrogen and carbon dioxide. Oxygen, air, flammable gases and mixtures containing such gases shall not be used.

Exceptions:

1. The use of air is allowed to test R-717, ammonia, systems provided that they are subsequently evacuated before charging with refrigerant.
2. Mixtures of dry nitrogen, inert gases, or a combination of them with nonflammable refrigerants in concentrations of a refrigerant weight fraction (mass fraction) not exceeding five are allowed for tests.

1108.3 Test apparatus. The means used to build up the test pressure shall have either a pressure-limiting device or a pressure-reducing device and a gauge on the outlet side.

1108.4 Declaration. A certificate of test shall be provided for all systems containing 55 pounds (~~[25]~~ 24.9 kg) or more of refrigerant. The certificate shall give the name of the refrigerant and the field test pressure applied to the high side and the low side of the system. The certification of test shall be signed by the installer and shall be made part of the public record.

SECTION MC 1109 PERIODIC TESTING

1109.1 Testing required. The following emergency devices and systems shall be periodically tested and the results logged in accordance with the manufacturer's instructions and as required by the Commissioner of the Fire Department:

1. Treatment and flaring systems.
2. Valves and appurtenances necessary to the operation of emergency refrigeration control boxes.
3. Fans and associated equipment intended to operate emergency purge ventilation systems.
4. Detection and alarm systems.

1109.2 Operation. Operating permits and qualification of operators for refrigeration systems shall comply with the requirements of the *New York City Fire Code*.

§ 13. Chapter 12 of the New York city mechanical code, as amended by local law number 141 for the year 2013, is amended to read as follows:

CHAPTER 12 HYDRONIC PIPING

SECTION MC 1201 GENERAL

1201.1 Scope. The provisions of this chapter shall govern the construction, installation, alteration and repair of hydronic piping systems. This chapter shall apply to hydronic piping systems that are part of heating, ventilation and air-conditioning systems. Such piping systems shall include steam, hot water, chilled water, condenser water, cooling coil condensate drain, steam condensate and [~~ground source~~ ground-source] ground-source heat pump loop systems. Potable cold and hot water distribution systems shall be installed in accordance with the *New York City Plumbing Code*.

1201.2 Sizing. Piping and piping system components for hydronic systems shall be sized for the design requirements of the system.

1201.3 Standards. As an alternative to the provisions of Sections 1202 and 1203, piping shall be designed, installed, inspected and tested in accordance with ASME B31.1 and ASME B31.9, as applicable.

SECTION MC 1202 MATERIAL

1202.1 Piping. Piping material, other than those contained within this section and conforming with the ASTM standards listed within this chapter, shall be of an approved type.

Exception: Embedded piping regulated by Section 1209, and ground-source heat pump loop systems regulated by Section 1210.

1202.2 Used existing materials. Reused pipe, fittings, valves or other materials shall be clean and free of foreign materials.

1202.3 Material rating. Materials shall be rated for the operating temperature and pressure of the hydronic system. Materials shall be suitable for the type of fluid in the hydronic system.

1202.4 Piping materials standards. Hydronic pipe shall conform to the standards listed in Table 1202.4. The exterior of the pipe shall be protected from corrosion and degradation.

**TABLE 1202.4
HYDRONIC PIPE**

MATERIAL	STANDARD (see Chapter 15)
Acrylonitrile butadiene styrene (ABS) plastic pipe	ASTM D 1527; ASTM [D 2282] <u>F 2806</u>
[Brass pipe]	[ASTM B 43]
[Brass tubing]	[ASTM B 135]
Chlorinated polyvinyl chloride (CPVC) plastic pipe	<u>ASTM D 2846</u> ; ASTM F 441; ASTM F 442
Copper, brass, or copper-alloy pipe	ASTM B 42; ASTM B 43; ASTM B 302
Copper, brass, or copper-alloy tube (Type K, L or M)	ASTM B 75; ASTM B 88; <u>ASTM B 135</u> ; ASTM B 251
[Chlorinated polyvinyl chloride (CPVC) plastic pipe]	[ASTM D 2846; ASTM F 441; ASTM F 442]
Cross-linked polyethylene/aluminum/cross-linked polyethylene (PEX-AL-PEX) pressure pipe	ASTM F 1281; CSA [CAN/CSA B137.10] <u>B137.10</u>
Cross-linked polyethylene (PEX) tubing	ASTM F 876; ASTM F 877
Ductile iron pipe	<u>AWWA C115/A21.15</u> ; AWWA C151/A21.51 [AWWA C115/A21.15]
Polyethylene/aluminum/polyethylene (PE-AL-PE) pressure pipe	ASTM F 1282; CSA B137.9
[Polyethylene (PE) pipe, tubing and fittings (for ground source heat pump loop systems)]	[ASTM D 2513; ASTM D 3035; ASTM D 2447; ASTM D 2683; ASTM F 1055; ASTM D 2837; ASTM D 3350; ASTM D 1693]
Polypropylene (PP) plastic pipe	ASTM F 2389
Polyvinyl chloride (PVC) plastic pipe	ASTM D 1785; ASTM D 2241
Raised temperature polyethylene (PE-RT)	ASTM F 2623; <u>ASTM F 2769</u>
Steel pipe	ASTM A 53/A 53M; ASTM A 106
Steel tubing	ASTM A 254

1202.5 Pipe fittings. Hydronic pipe fittings shall conform to the respective pipe standards or to the standards listed in Table 1202.5.

**TABLE 1202.5
HYDRONIC PIPE FITTINGS**

MATERIAL	STANDARD (see Chapter 15)
[Brass]	[ASTM F 1974]
[Bronze]	[ASME B16.24]

**TABLE 1202.5
HYDRONIC PIPE FITTINGS**

MATERIAL	STANDARD (see Chapter 15)
Copper, brass , and copper alloys	ASME B16.15; ASME B16.18; ASME B16.22; [ASME B16.23; <u>ASME B16.24</u> ; ASME B16.26; [ASME B16.29] <u>ASME B16.51</u> ; <u>ASTM F 1974</u>
<u>Ductile iron and gray iron</u>	<u>ANSI/AWWA C110/A21.10; AWWA C153/A21.53; ASTM A 126; ASTM A 395; ASTM A 536; ASTM F 1476; ASTM F 1548</u>
[Gray iron]	[ASTM A 126]
Malleable iron	ASME B16.3
<u>PE-RT fittings</u>	<u>ASTM F 1807; ASTM F 2098; ASTM F 2159; ASTM F 2735; ASTM F 2769</u>
<u>PEX fittings</u>	<u>ASTM F 877; ASTM F 1807; ASTM F 2159</u>
Plastic	ASTM D 2466; ASTM D 2467; ASTM [D 2468] <u>F 438</u> ; ASTM F [438; ASTM F] 439; ASTM F 877; <u>ASTM F 2389; ASTM F 2735</u>
Steel	ASME B16.5; ASME B16.9; ASME B16.11; ASME B16.28; <u>ASTM A 53/A 53M; ASTM A 106; ASTM A 234; ASTM A 420; ASTM A 536; ASTM A 395; ASTM F 1476; ASTM F 1548</u>

1202.6 Valves. Valves shall be constructed of materials that are compatible with the type of piping material and fluids in the system. Valves shall be rated for the temperatures and pressures of the systems in which the valves are installed.

1202.7 Flexible connectors, expansion and vibration compensators. Flexible connectors, expansion and vibration control devices and fittings, when used, shall protect the components of the hydronic system from damage caused by expansion, contraction, transverse movement, angular deflection and vibration, shall be rated for the temperatures and pressures of the systems in which the devices are installed, and shall be compatible with the fluid and all materials provided.

SECTION MC 1203 JOINTS AND CONNECTIONS

1203.1 Approval. Joints and connections, other than those contained in Section 1203 and conforming to the ASTM standards listed in Section 1203, shall be of an approved type. Joints and connections shall be tight for the pressure of the hydronic system.

1203.1.1 Joints between different piping materials. Joints between different piping materials shall be rated for the temperatures and pressures of the systems in which the devices are installed and shall be compatible with the fluid and all materials provided.

1203.1.2 Joints between dissimilar metallic piping materials. Joints between dissimilar metallic piping materials shall be provided to protect against galvanic corrosion. Such joints shall be made with dielectric fittings conforming to ANSI B16.39 or ASTM F 492, as applicable, shall be rated for the temperatures and pressures of the systems in which the devices are installed and shall be compatible with the fluid and all materials provided.

Exception: Dielectric fittings shall not be required for joints between dissimilar metal piping used within heat transfer appliances or equipment when such joints are provided by the appliance or equipment manufacturer, and such appliance or equipment is connected with isolation valves that are accessible.

1203.2 Preparation of pipe ends. Pipe shall be cut square, reamed and chamfered, and shall be free of burrs and obstructions. Pipe ends shall have full-bore openings and shall not be undercut.

1203.3 Joint preparation and installation. ~~[When]~~ Where required by Sections 1203.4 through 1203.14, the preparation and installation of brazed, mechanical, soldered, solvent-cemented, threaded and welded joints shall comply with Sections 1203.3.1 through ~~[1203.3.7]~~ 1203.3.8.

1203.3.1 Brazed joints. All joints shall be brazed with a brazing procedure developed and qualified in accordance with the ASME Boiler and Pressure Vessel Code, Section IX (Welding and Brazing Qualifications) or in accordance with AWS B2.2 Standard for Brazing Procedure and Performance Qualification.

1203.3.2 Mechanical joints. Mechanical joints shall be installed in accordance with the manufacturer's instructions.

1203.3.3 Soldered joints. Joint surfaces shall be cleaned. A flux conforming to ASTM B 813 shall be applied. The joint shall be soldered with a solder conforming to ASTM B 32.

1203.3.4 Solvent-cemented joints. Joint surfaces shall be clean and free of moisture. A primer, compatible with both the piping material and the cement shall be applied to pipe-joint surfaces, in accordance with the manufacturer's requirements. Joints shall be made while the cement is wet. Solvent cement conforming to the following standards shall be applied to all joint surfaces:

1. ASTM D 2235 for ABS joints.
2. ASTM F 493 for CPVC joints.
3. ASTM D 2564 for PVC joints.

1203.3.5 Threaded joints. Threads shall conform to ASME B1.20.1. Schedule 80 or heavier plastic pipe shall be threaded with dies specifically designed for plastic pipe. Thread lubricant, pipe-joint compound or tape shall be applied on the male threads only and shall be compatible for application on the piping material and fluid.

1203.3.6 Welded joints. All joints shall be welded with a welding procedure developed and qualified in accordance with the *ASME Boiler and Pressure Vessel Code*, Section IX (Welding and Brazing Qualifications) or in accordance with AWS B2.1 Specifications for Welding Procedure and Performance Qualification.

1203.3.7 Grooved and shouldered mechanical joints. Grooved and shouldered mechanical joints shall conform to the requirements of ASTM F 1476 and shall be installed in accordance with the manufacturer's ~~[installation]~~ instructions.

1203.3.8 Mechanically formed tee fittings. Mechanically extracted outlets shall have a height not less than three times the thickness of the branch tube wall.

1203.3.8.1 Full flow assurance. Branch tubes shall not restrict the flow in the run tube. A dimple/depth stop shall be formed in the branch tube to ensure that penetration into the outlet is of the correct depth. For inspection purposes, a second dimple shall be placed [~~0.25~~] $\frac{1}{4}$ inch (6.4 mm) above the first dimple. Dimples shall be aligned with the tube run.

1203.3.8.2 Brazed joints. Mechanically formed tee fittings shall be brazed in accordance with Section 1203.3.1.

1203.4 ABS plastic pipe. Joints between ABS plastic pipe or fittings shall be solvent-cemented or threaded joints conforming to Section 1203.3.

1203.5 Brass pipe. Joints between brass pipe or fittings shall be brazed, mechanical, threaded or welded joints conforming to Section 1203.3.

1203.6 Brass tubing. Joints between brass tubing or fittings shall be brazed, mechanical or soldered joints conforming to Section 1203.3.

1203.7 Copper or copper-alloy pipe. Joints between copper or copper-alloy pipe or fittings shall be brazed, mechanical, soldered, threaded or welded joints conforming to Section 1203.3.

1203.8 Copper or copper-alloy tubing. Joints between copper or copper-alloy tubing or fittings shall be brazed, mechanical or soldered joints conforming to Section 1203.3, flared joints conforming to Section 1203.8.1 or push-fit joints conforming to Section 1203.8.2.

1203.8.1 Flared joints. Flared joints shall be made by a tool designed for that operation.

1203.8.2 Push-fit joints. Push-fit joints shall be installed in accordance with the manufacturer's instructions.

1203.9 CPVC plastic pipe. Joints between CPVC plastic pipe or fittings shall be solvent-cemented or threaded joints conforming to Section 1203.3.

1203.10 Reserved.

1203.11 Cross-linked polyethylene (PEX) plastic tubing. Joints between cross-linked polyethylene plastic tubing and fittings shall conform to Sections 1203.11.1 and 1203.11.2. Mechanical joints shall conform to Section 1203.3.

1203.11.1 Compression-type fittings. [~~When~~] Where compression-type fittings include inserts and ferrules or O-rings, the fittings shall be installed without omitting the inserts and ferrules or O-rings.

1203.11.2 Plastic-to-metal connections. Soldering on the metal portion of the system shall be performed [~~at least~~] not less than 18 inches (~~[457]~~ 457.2 mm) from a plastic-to-metal adapter in the same water line.

1203.12 PVC plastic pipe. Joints between PVC plastic pipe and fittings shall be solvent-cemented or threaded joints conforming to Section 1203.3.

1203.13 Steel pipe. Joints between steel pipe or fittings shall be mechanical, threaded or welded joints conforming to Section 1203.3.

1203.14 Steel tubing. Joints between steel tubing or fittings shall be mechanical or welded joints conforming to Section 1203.3.

~~[1203.15 Polyethylene plastic pipe and tubing for ground source heat pump loop systems. Joints between polyethylene plastic pipe and tubing or fittings for ground source heat pump loop systems shall be heat fusion joints conforming to Section 1203.15.1, electrofusion joints conforming to Section 1203.15.2, or stab-type insertion joints conforming to Section 1203.15.3.]~~

~~[1203.15.1 Heat fusion joints. Joints shall be of the socket fusion, saddle fusion or butt fusion type, joined in accordance with ASTM D 2657. Joint surfaces shall be clean and free of moisture. Joint surfaces shall be heated to melt temperatures and joined. The joint shall be undisturbed until cool. Fittings shall be manufactured in accordance with ASTM D 2683 or ASTM D 3261.]~~

~~[1203.15.2 Electrofusion joints. Joints shall be of the electrofusion type. Joint surfaces shall be clean and free of moisture, and scoured to expose virgin resin. Joint surfaces shall be heated to melt temperatures for the period of time specified by the manufacturer. The joint shall be undisturbed until cool. Fittings shall be manufactured in accordance with ASTM F 1055.]~~

~~[1203.15.3 Stab-type insert fittings. Joint surfaces shall be clean and free of moisture. Pipe ends shall be chamfered and inserted into the fittings to full depth. Fittings shall be manufactured in accordance with ASTM F 1924.]~~

[1203.16] **1203.15 Polypropylene (PP) plastic.** Joints between PP plastic pipe and fittings shall comply with Sections [1203.16.1] 1203.15.1 and [1203.16.2] 1203.15.2.

[1203.16.1] **1203.15.1 Heat-fusion joints.** Heat-fusion joints for polypropylene (PP) pipe and tubing joints shall be installed with socket-type heat-fused polypropylene fittings, [electrofusion] electro-fusion polypropylene fittings or by butt fusion. Joint surfaces shall be clean and free from moisture. The joint shall be undisturbed until cool. Joints shall be made in accordance with ASTM F 2389.

[1203.16.2] **1203.15.2 Mechanical and compression sleeve joints.** Mechanical and compression sleeve joints shall be installed in accordance with the manufacturer's instructions.

[1203.17] **1203.16 Raised temperature polyethylene (PE-RT) plastic tubing.** Joints between raised temperature polyethylene tubing and fittings shall conform to Sections [1203.17.1] 1203.16.1 and [1203.17.2] 1203.16.2. Mechanical joints shall conform to Section 1203.3.

[1203.17.1] **1203.16.1 Compression-type fittings.** Where compression-type fittings include inserts and ferrules or O-rings, the fittings shall be installed without omitting the inserts and ferrules or O-rings.

~~[1203.17.2]~~ **1203.16.2 PE-RT-to-metal connections.** Solder joints in a metal pipe shall not occur within 18 inches (~~[457]~~ 457.2 mm) of a transition from such metal pipe to PE-RT pipe.

~~[1203.18]~~ **1203.17 Polyethylene/aluminum/polyethylene (PE-AL-PE) pressure pipe.** Joints between polyethylene/aluminum/polyethylene pressure pipe and fittings shall conform to Sections ~~[1203.18.1]~~ 1203.17.1 and ~~[1203.18.2]~~ 1203.17.2. Mechanical joints shall comply with Section 1203.3.

~~[1203.18.1]~~ **1203.17.1 Compression-type fittings.** Where compression-type fittings include inserts and ferrules or O-rings, the fittings shall be installed without omitting the inserts and ferrules or O-rings.

~~[1203.18.2]~~ **1203.17.2 PE-AL-PE-to-metal connections.** Solder joints in a metal pipe shall not occur within 18 inches (~~[457]~~ 457.2 mm) of a transition from such metal pipe to PE-AL-PE pipe.

~~[1203.19]~~ **1203.18 Cross-linked polyethylene/aluminum/cross-linked ~~[olyethylene]~~ polyethylene (PEX-AL-PEX) pressure pipe.** Joints between cross-linked polyethylene/aluminum/cross-linked polyethylene pressure pipe and fittings shall conform to Sections ~~[1203.19.1]~~ 1203.18.1 and ~~[1203.19.2]~~ 1203.18.2. Mechanical joints shall comply with Section 1203.3.

~~[1203.19.1]~~ **1203.18.1 Compression-type fittings.** Where compression-type fittings include inserts and ferrules or O-rings, the fittings shall be installed without omitting the inserts and ferrules or O-rings.

~~[1203.19.2]~~ **1203.18.2 PEX-AL-PEX-to-metal connections.** Solder joints in a metal pipe shall not occur within 18 inches (~~[457]~~ 457.2 mm) of a transition from such metal pipe to PEX-AL-PEX pipe.

SECTION MC 1204 PIPE INSULATION

1204.1 Insulation characteristics. Pipe insulation installed in buildings shall conform to the requirements of the *New York City Energy Conservation Code*, shall be tested in accordance with ASTM E 84 or UL 723, using the specimen preparation and mounting procedures of ASTM E 2231; and shall have a maximum flame spread index of 25 and a smoke-developed index not exceeding 450. Insulation installed in an air plenum shall comply with Section 602.2.1.

1204.2 Required thickness. Hydronic piping shall be insulated to the thickness required by the *New York City Energy Conservation Code*.

SECTION MC 1205 VALVES

1205.1 Where required. Shutoff valves shall be installed in hydronic piping systems in the locations indicated in Sections 1205.1.1 through 1205.1.6.

1205.1.1 Heat exchangers. Shutoff valves shall be installed on the supply and return side of a heat exchanger.

Exception: Shutoff valves shall not be required [~~when~~] where heat exchangers are integral with a boiler; or are a component of a manufacturer's boiler and heat exchanger packaged unit and are capable of being isolated from the hydronic system by the supply and return valves required by Section 1005.1.

1205.1.2 Central systems. Shutoff valves shall be installed on the building supply and return of central utility systems, and district heating and cooling systems.

1205.1.3 Pressure vessels. Shutoff valves shall be installed on the connection to any pressure vessel.

1205.1.4 Pressure-reducing valves. Shutoff valves shall be installed on both sides of a pressure-reducing valve.

1205.1.5 Equipment and appliances. Shutoff valves shall be installed on connections to mechanical equipment and appliances. This requirement does not apply to components of a hydronic system such as pumps, air separators, metering devices and similar equipment.

1205.1.6 Expansion tanks. Lockable shutoff valves shall be installed at connections to all expansion tanks. Valves shall be locked in the open position.

1205.2 Reduced pressure. A pressure relief valve shall be installed on the low-pressure side of a hydronic piping system that has been reduced in pressure. The relief valve shall be set at the maximum pressure of the system design. The valve shall be installed in accordance with Section 1006.

SECTION MC 1206 PIPING INSTALLATION

1206.1 General. Piping, valves, fittings and connections shall be installed in accordance with the conditions of approval.

1206.2 System drain down. Hydronic piping systems shall be designed and installed to permit the system to be drained. Where the system drains to the plumbing drainage system, the installation shall conform to the requirements of the *New York City Plumbing Code*.

Exception: The buried portions of systems embedded underground.

1206.3 Protection of potable water. The potable water system shall be protected from backflow in accordance with the *New York City Plumbing Code*.

1206.4 Pipe penetrations. Openings for pipe penetrations in walls, floors or ceilings shall be larger than the penetrating pipe. Openings through concrete or masonry building elements shall be sleeved. The annular space surrounding pipe penetrations shall be protected in accordance with the *New York City Building Code*.

1206.5 Clearance to combustibles. A pipe in a hydronic piping system in which the exterior temperature exceeds 250°F ([~~121~~] 121.1°C) shall have a minimum clearance of 1 inch ([~~25~~] 25.4 mm) to combustible materials.

1206.6 Contact with building material. A hydronic piping system shall not be in direct contact with building materials that cause the piping material to degrade or corrode, or that interfere with the operation of the system.

1206.7 Water hammer. The flow velocity of the hydronic piping system shall be controlled to reduce the possibility of water hammer. Where a quick-closing valve creates water hammer, an engineered water-hammer arrestor shall be installed. The arrestor shall be located within a range as specified by the manufacturer of the quick-closing valve.

1206.8 Steam piping pitch. Steam piping shall be installed to drain to the boiler or the steam trap. Steam systems shall not have drip pockets that reduce the capacity of the steam piping.

1206.9 Strains and stresses. Piping shall be installed so as to prevent detrimental strains and stresses in the pipe. Provisions shall be made to protect piping from damage resulting from expansion, contraction and structural settlement. Piping shall be installed so as to avoid structural stresses or strains within building components.

1206.9.1 Flood hazard. Piping located in [~~areas of special~~] flood hazard areas shall comply with Appendix G of the *New York City Building Code*.

1206.10 Pipe support. Pipe shall be supported in accordance with Section 305. Seismic supports shall be provided where required by the *New York City Building Code*.

1206.11 Condensation. Provisions shall be made to prevent the formation of condensation on the exterior of piping.

SECTION MC 1207 TRANSFER FLUID

1207.1 Flash point. The flash point of transfer fluid in a hydronic piping system shall be [~~a minimum of~~] not less than 50°F (~~[28°C]~~ 10°C) above the maximum system operating temperature.

1207.2 Makeup water. The transfer fluid shall be compatible with the makeup water supplied to the system.

SECTION MC 1208 TESTS

1208.1 General. Hydronic piping systems other than ground-source heat pump loop systems shall be tested hydrostatically at one and one half times the system design operating pressure, but not less than 100 psi (689 kPa). The duration of each test shall be not less than 2 hours. Ground-source heat pump loop systems shall be tested in accordance with Section [~~1208.1.1~~] 1210.10.

~~**1208.1.1 Ground source heat pump loop systems.** Before connection (header) trenches are backfilled, the assembled loop system shall be pressure tested with water at 100 psi (689 kPa)~~

~~for 30 minutes with no observed leaks. Flow and pressure loss testing shall be performed and the actual flow rates and pressure drops shall be compared to the calculated design values. If actual flow rate or pressure drop values differ from calculated design values by more than 10 percent, the problem shall be identified and corrected.]~~

SECTION MC 1209 EMBEDDED PIPING

1209.1 Materials. ~~[Piping for heating panels]~~ Embedded piping shall be ~~[standard weight steel pipe, Type L copper tubing, or]~~ plastic pipe or tubing, in accordance with Section 1202, rated at 100 psi (~~[689]~~ 689.5 kPa) at 180°F (~~[82]~~ 82.2°C).

1209.2 Pressurizing during installation. Piping to be embedded in concrete shall be pressure tested prior to pouring concrete. During pouring, the pipe shall be maintained at the proposed operating pressure.

1209.3 Embedded joints. Joints of pipe or tubing that are embedded in a portion of the building, such as concrete or plaster, shall be ~~[in accordance with the requirements of Sections 1209.3.1 and 1209.2]~~ thermally-fused.

~~[1209.3.1 Steel pipe joints. Steel pipe shall be welded by electrical arc or oxygen/acetylene method.]~~

~~[1209.3.2 Copper tubing joints. Copper tubing joints shall be brazed in accordance with Section 1203.3.]~~

1209.4 Not embedded related piping. Joints of other piping in cavities or running exposed shall be joined in accordance with manufacturer's ~~[installation]~~ instructions and related sections of this code.

1209.5 Thermal barrier required. Radiant floor heating systems shall be provided with a thermal barrier in accordance with Sections 1209.5.1 through 1209.5.4.

Exception: Insulation shall not be required in engineered systems where it can be demonstrated that the insulation will decrease the efficiency or have a negative effect on the installation.

1209.5.1 Slab-on-grade installation. Radiant piping utilized in slab-on-grade applications shall be provided with insulating materials installed beneath the piping having a minimum R-value of 5.

1209.5.2 Suspended floor installation. In suspended floor applications, insulation shall be installed in the joist bay cavity serving the heating space above and shall consist of materials having a minimum R-value of 11.

1209.5.3 Thermal break required. A thermal break shall be provided consisting of asphalt expansion joint materials or similar insulating materials at a point where a heated slab meets a foundation wall or other conductive slab.

1209.5.4 Thermal barrier material marking. Insulating materials utilized in thermal barriers shall be installed such that the manufacturer's R-value mark is readily observable upon inspection.

SECTION MC 1210
PLASTIC PIPE GROUND-SOURCE HEAT PUMP LOOP SYSTEMS

1210.1 Ground-source heat pump-loop water piping. Ground-source heat pump ground-loop piping and tubing material for water-based systems shall conform to the standards cited in this section.

1210.2 Used materials. Reused pipe, fittings, valves, and other materials shall not be permitted in ground-source heat pump loop systems.

1210.3 Material rating. Pipe and tubing shall be rated for the operating temperature and pressure of the ground-source heat pump loop system. Fittings shall be suitable for the pressure applications and recommended by the manufacturer for installation with the pipe and tubing material installed. Where used underground, materials shall be suitable for burial.

1210.4 Piping and tubing materials standards. Ground-source heat pump ground-loop pipe and tubing shall conform to the standards listed in Table 1210.4.

TABLE 1210.4
GROUND-SOURCE LOOP PIPE

<u>MATERIAL</u>	<u>STANDARD (see Chapter 15)</u>
<u>Chlorinated polyvinyl chloride (CPVC)</u>	<u>ASTM D 2846; ASTM F 441; ASTM F 442</u>
<u>Cross-linked polyethylene (PEX)</u>	<u>ASTM F 876; ASTM F 877; CSA B137.5</u>
<u>Polyethylene/aluminum/polyethylene (PE-AL-PE) pressure pipe</u>	<u>ASTM F 1282; CSA B137.9</u>
<u>High-density polyethylene (HDPE)</u>	<u>ASTM D 2737; ASTM D 3035; ASTM F 714; AWWA C901; CSA B137.1; CSA C448; NSF 358-1</u>
<u>Polypropylene (PP-R)</u>	<u>ASTM F 2389; CSA B137.11</u>
<u>Polyvinyl chloride (PVC)</u>	<u>ASTM D 1785; ASTM D 2241</u>
<u>Raised temperature polyethylene (PE-RT)</u>	<u>ASTM F 2623</u>

1210.5 Fittings. Ground-source heat pump pipe fittings shall conform to the standards listed in Table 1210.5 and, if installed underground, shall be suitable for burial.

TABLE 1210.5
GROUND-SOURCE LOOP PIPE FITTINGS

<u>PIPE MATERIAL</u>	<u>STANDARD (see Chapter 15)</u>
<u>Chlorinated polyvinyl chloride (CPVC)</u>	<u>ASTM D 2846; ASTM F 437; ASTM F 438; ASTM F 439; CSA B137.6</u>
<u>Cross-linked polyethylene (PEX)</u>	<u>ASTM F 877; ASTM F 1807; ASTM F 1960; ASTM F 2080; ASTM F 2159; ASTM F 2434; CSA B137.5</u>
<u>Polyethylene/aluminum/polyethylene (PE-AL-PE)</u>	<u>ASTM F 1282; ASTM F 2434; CSA B137.9</u>
<u>High Density Polyethylene (HDPE)</u>	<u>ASTM D 2683; ASTM D 3261; ASTM F 1055; CSA B137.1; CSA C448; NSF 358-1</u>
<u>Polypropylene (PP-R)</u>	<u>ASTM F 2389; CSA B137.11</u>
<u>Polyvinyl chloride (PVC)</u>	<u>ASTM D 2464; ASTM D 2466; ASTM D 2467; CSA B137.2; CSA B137.3</u>

TABLE 1210.5
GROUND-SOURCE LOOP PIPE FITTINGS

PIPE MATERIAL	STANDARD (see Chapter 15)
Raised temperature polyethylene (PE-RT)	ASTM D 3261; ASTM F 1807; ASTM F 2159; CSA B137.1

1210.6 Joints. Joints and connections, other than those covered by Section 1210 and conforming to the ASTM standards listed therein, shall be of an approved type. Joints and connections shall be tight for the pressure of the ground-source loop system. Joints used underground shall be in accordance with manufacturer's instructions for buried applications.

1210.6.1 Joints between different piping materials. Joints between different piping materials shall be made with transition fittings compatible with both materials and the fluid contained within the system. Transition fittings must be used in accordance with manufacturer's instructions.

1210.6.1.1 Plastic-to-metal connections. Soldering on the metal portion of the system shall be performed not less than 18 inches (457.2 mm) from a plastic-to-metal adapter in the same water line.

1210.6.2 Preparation of pipe ends. Pipe shall be cut square, be reamed, and be free of burrs and obstructions. CPVC, PE, and PVC pipe shall be chamfered. Pipe ends shall have full-bore openings and shall not be undercut.

1210.6.3 Joint preparation and installation. Where required by Sections 1210.6.4 through 1210.6.6, the preparation and installation of mechanical and thermoplastic-welded joints shall comply with Sections 1210.6.3.1 and 1210.6.3.2.

1210.6.3.1 Mechanical joints. Mechanical joints shall be installed in accordance with the manufacturer's instructions.

1210.6.3.2 Thermoplastic-welded joints. Joint surfaces for thermoplastic-welded joints shall be cleaned by a procedure in accordance with the manufacturer's instructions. Joints shall be welded in accordance with the manufacturer's instructions.

1210.6.4 CPVC plastic pipe. Joints between CPVC plastic pipe or fittings shall be solvent-cemented or threaded joints complying with Section 1203.3.

1210.6.5 Cross-linked polyethylene (PEX) plastic tubing. Joints between cross-linked polyethylene plastic tubing and fittings shall comply with Sections 1210.6.5.1 and 1210.6.5.2. Mechanical joints shall comply with Section 1210.6.3.

1210.6.5.1 Compression-type fittings. Where compression-type fittings include inserts and ferrules or O-rings, the fittings shall be installed without omitting the inserts and ferrules or O-rings.

1210.6.6 Polyethylene plastic pipe and tubing for ground-source heat pump loop systems. Joints between polyethylene plastic pipe and tubing or fittings for ground-source heat pump loop systems shall be heat fusion joints complying with Section 1210.6.6.1, electrofusion joints

complying with Section 1210.6.6.2, or stab-type insertion joints complying with Section 1210.6.6.3.

1210.6.6.1 Heat-fusion joints. Joints shall be of the socket-fusion, saddle-fusion or butt-fusion type, joined in accordance with ASTM D 2657. Joint surfaces shall be clean and free from moisture. Joint surfaces shall be heated to melt temperatures and joined. The joint shall be undisturbed until cool. Fittings shall be manufactured in accordance with ASTM D 2683 or ASTM D 3261.

1210.6.6.2 Electrofusion joints. Joints shall be of the electrofusion type. Joint surfaces shall be clean and free from moisture, and scoured to expose virgin resin. Joint surfaces shall be heated to melt temperatures for the period of time specified by the manufacturer. The joint shall be undisturbed until cool. Fittings shall be manufactured in accordance with ASTM F 1055.

1210.6.6.3 Stab-type insert fittings. Joint surfaces shall be clean and free from moisture. Pipe ends shall be chamfered and inserted into the fittings to full depth. Fittings shall be manufactured in accordance with ASTM F 1924.

1210.6.7 Polypropylene (PP) plastic. Joints between PP plastic pipe and fittings shall comply with Sections 1210.6.7.1 and 1210.6.7.2.

1210.6.7.1 Heat-fusion joints. Heat-fusion joints for polypropylene (PP) pipe and tubing joints shall be installed with socket-type heat-fused polypropylene fittings, electrofusion polypropylene fittings or by butt fusion. Joint surfaces shall be clean and free from moisture. The joint shall be undisturbed until cool. Joints shall be made in accordance with ASTM F 2389.

1210.6.7.2 Mechanical and compression sleeve joints. Mechanical and compression sleeve joints shall be installed in accordance with the manufacturer's instructions.

1210.6.8 Raised temperature polyethylene (PE-RT) plastic tubing. Joints between raised temperature polyethylene tubing and fittings shall comply with Sections 1210.6.8.1 and 1210.6.8.2. Mechanical joints shall comply with Section 1210.6.3.

1210.6.8.1 Compression-type fittings. Where compression-type fittings include inserts and ferrules or O-rings, the fittings shall be installed without omitting the inserts and ferrules or O-rings.

1210.6.9 PVC plastic pipe. Joints between PVC plastic pipe and fittings shall be solvent-cemented or threaded joints comply with Section 1203.3.

1210.7 Shutoff valves. Shutoff valves shall be installed in ground-source loop piping systems in the locations indicated in Sections 1210.7.1 through 1210.7.7.

1210.7.1 Heat exchangers. Shutoff valves shall be installed on the supply and return side of a heat exchanger.

Exception: Shutoff valves shall not be required where heat exchangers are integral with a boiler; or are a component of a manufacturer's boiler and heat exchanger packaged unit and are capable of being isolated from the hydronic system by the supply and return valves required by Section 1005.1.

1210.7.2 Central systems. Shutoff valves shall be installed on the building supply and return of a central utility system.

1210.7.3 Pressure vessels. Shutoff valves shall be installed on the connection to any pressure vessel.

1210.7.4 Pressure-reducing valves. Shutoff valves shall be installed on both sides of a pressure-reducing valve.

1210.7.5 Equipment and appliances. Shutoff valves shall be installed on connections to mechanical equipment and appliances. This requirement does not apply to components of a ground-source loop system such as pumps, air separators, metering devices, and similar equipment.

1210.7.6 Expansion tanks. Shutoff valves shall be installed at connections to nondiaphragm-type expansion tanks.

1210.7.7 Reduced pressure. A pressure relief valve shall be installed on the low-pressure side of a hydronic piping system that has been reduced in pressure. The relief valve shall be set at the maximum pressure of the system design. The valve shall be installed in accordance with Section 1006.

1210.8 Installation. Piping, valves, fittings, and connections shall be installed in accordance with the conditions of approval.

1210.8.1 Protection of potable water. Where ground-source heat pump ground-loop systems have a connection to a potable water supply, the potable water system shall be protected from backflow in accordance with the *New York City Plumbing Code*.

1210.8.2 Pipe penetrations. Openings for pipe penetrations in walls, floors and ceilings shall be larger than the penetrating pipe. Openings through concrete or masonry building elements shall be sleeved. The annular space surrounding pipe penetrations shall be protected in accordance with the *New York City Building Code*.

1210.8.3 Clearance from combustibles. A pipe in a ground-source heat pump piping system having an exterior surface temperature exceeding 250°F (121.1°C) shall have a minimum clearance of 1 inch (25.4 mm) from combustible materials.

1210.8.4 Contact with building material. A ground-source heat pump ground-loop piping system shall not be in direct contact with building materials that cause the piping or fitting material to degrade or corrode, or that interfere with the operation of the system.

1210.8.5 Strains and stresses. Piping shall be installed so as to prevent detrimental strains and stresses in the pipe. Provisions shall be made to protect piping from damage resulting from expansion, contraction and structural settlement. Piping shall be installed so as to avoid structural stresses or strains within building components.

1210.8.6 Flood hazard. Piping located in a flood hazard area shall be capable of resisting hydrostatic and hydrodynamic loads and stresses, including the effects of buoyancy, during the occurrence of flooding to the design flood elevation.

1210.8.7 Pipe support. Pipe shall be supported in accordance with Section 305.

1210.8.8 Velocities. Ground-source heat pump ground-loop systems shall be designed so that the flow velocities do not exceed the maximum flow velocity recommended by the pipe and fittings manufacturer and shall be controlled to reduce the possibility of water hammer.

1210.8.9 Labeling and marking. Ground-source heat pump ground-loop system piping shall be marked with tape, metal tags or other method where it enters a building indicating "GROUND-SOURCE HEAT PUMP LOOP SYSTEM." The marking shall indicate any antifreeze used in the system by name and concentration.

1210.8.10 Chemical compatibility. Antifreeze and other materials used in the system shall be chemically compatible with the pipe, tubing, fittings, and mechanical systems.

1210.9 Makeup water. The transfer fluid shall be compatible with the makeup water supplied to the system.

1210.10 Tests. Before connection header trenches are backfilled, the assembled loop system shall be pressure tested with water at 100 psi (689.5 kPa) for 15 minutes, in which time there shall not be observed leaks. Flow and pressure loss testing shall be performed and the actual flow rates and pressure drops shall be compared to the calculated design values. If actual flow rate or pressure drop values differ from calculated design values by more than 10 percent, the cause shall be identified and corrective action taken.

1210.11 Embedded piping. Ground-source heat pump ground-loop piping to be embedded in concrete shall be pressure tested prior to pouring concrete. During pouring, the pipe shall be maintained at the proposed operating pressure. Embedded piping shall comply with Section 1209.

SECTION MC ~~[4240]~~ 1211 HIGH-PRESSURE STEAM AND HIGH TEMPERATURE HOT WATER PIPING SYSTEMS

~~[4240.1]~~ 1211.1 Scope. The provisions of this section shall apply to high-pressure steam piping system, which is defined as a system operating at a steam pressure of more than 15 psi (~~[403]~~ 103.4 kPa), and high temperature water intended for operation at pressures in excess of 160 psi (~~[827]~~ 1103.2 kPa) and temperatures in excess of 250°F (~~[404]~~ 121.1°C). For purposes of this section, loops, bends or offsets of the piping shall not be considered expansion joints.

~~[1210.2]~~ **1211.2 New systems.** For purposes of this section, the replacement of existing steam piping systems, the installation of a new system in existing buildings, as well as installations in buildings hereafter constructed, shall be considered to be new high-pressure steam piping systems. The following requirements are applicable:

~~[1210.2.1]~~ **1211.2.1 Design.** The design of new steam piping systems shall be conducted as follows:

1. The system shall be designed by an engineer. An application and plans shall be filed and the approval of the department obtained. The plans and application shall contain, but not be limited to, the following information:
 - 1.1. Size and location of all steam piping.
 - 1.2. The operating pressures and temperatures.
 - 1.3. The location, type, specifications and details of all expansion joints.
 - 1.4. The design, size, material and location of all anchors, guides and auxiliary steel, and the stresses thereon.
2. Systems using utility street steam shall be designed for a pressure of 200 psig (1379 kPa) and 413°F (~~[212]~~ 211.7°C) up to and including the steam pressure reducing valve or valves which reduce the pressure of 90 psig (~~[621]~~ 620.5 kPa) or below. For steam pressures between 90 psig (~~[621]~~ 620.5 kPa) and 16 psig (~~[140]~~ 110.3 kPa), the system shall be designed for 125 psig (~~[108]~~ 861.8 kPa).
3. Steam distribution systems utilizing pressure reducing valves.
 - 3.1. Safety Shutoff Valves (~~[“]~~SSO~~[”]~~) to protect downstream piping from overpressure shall be allowed in lieu of a safety relief valve vented to the outdoors as required by Section 1006.6.
 - 3.2. SSO shall be designed to automatically close at or below the design pressure of the downstream piping system that is being protected, to provide positive shutoff against full upstream pressure. Manual reset shall be required to reopen the SSO.
 - 3.3. SSO shall be designed in accordance with the Steam Distribution Utility System requirements of the utility company having jurisdiction and ASME B31.1.
4. Bellows expansion joints shall not be utilized on high pressure steam piping.

Exception: Bellows expansion joints shall be permitted for final connection to equipment where readily accessible for inspection and service and within Mechanical Equipment Rooms.

[1210.2.2] 1211.2.2 Installation. The installation of new steam piping systems shall be conducted as follows:

1. Installations, including any welding, shall be subject to special inspection.
2. Welders shall be qualified for all required pipe sizes, wall thicknesses and positions in accordance with the *ASME Boiler and Pressure Vessel Code*, Section IX. Requalification is required every five years or sooner if the commissioner has a specific reason to doubt a welder's ability to make acceptable welds.
3. Welder qualification testing shall be performed by an approved agency listed with the department, and the inspector witnessing the test shall be an authorized AWS Certified Welding Inspector. If the testing is by radiography, the test specimen shall be evaluated by personnel having a minimum radiography qualification of Level II in accordance with the ASNT, Document No. SNT-TC-1A, Supplement A. A successful radiographic test of a production weld made within the 6 months prior to requalification may be considered as an acceptable requalification test.
4. Copies of the certified welder qualification reports shall be maintained by the responsible welding agency and the company performing the welding, and shall be made available upon request to the department.
5. No reports from any welding inspection agency shall be accepted unless such agency has first requested and obtained approval from the department in accordance with rules of the department.
6. Pipe welding shall conform to the following:
 - 6.1. All piping over 2 inches (~~[54]~~ 50.8 mm) shall be butt-welded. Piping 2 inches (~~[76 mm]~~) (50.8 mm) and under may be socket-welded or threaded, providing Schedule 80 piping is utilized.
 - 6.2. Threaded piping may continue to be used for existing construction in size of 6 inches (~~[152]~~ 152.4 mm) and under.
 - 6.3. Where welding is not feasible, the commissioner may allow an acceptable alternative.
7. Radiographic examination, when required, shall be performed on butt-welds in accordance with ASME B31.1 based on the piping system design pressure and shall be as follows:

Piping System Design Pressure	Percentage
90 psig ([624] <u>620.5</u> kPa) or below	Not Required
91 psig ([627] <u>627.4</u> kPa) to	
150 psig ([1034] <u>1034.2</u> kPa)	10 at Random

However, if, in the opinion of the engineer responsible for special inspection, radiographic examination is not required for piping at pressure between 90 psig (~~[624]~~ 620.5 kPa) and 150 psig (~~[1034]~~ 1034.2 kPa), the engineer shall so specify in writing, and the final report on the installation may omit the foregoing, and be predicated on all of the other requirements noted in this section, and a hydrostatic test.

~~[1210.2.3]~~ **1211.2.3 Testing.** Hydrostatic testing shall be conducted on the completed installation at 150 percent of the design pressure for all piping pressure. Where the changes in an existing steam system involve less than 30 percent of the piping in the system, the testing may be in accordance with ASME B31.1.

~~[1210.2.4]~~ **1211.2.4 Relocation.** The commissioner, where deemed necessary, shall require the replacement or relocation of any expansion joints, guides or anchors. The commissioner shall cause the expansion joints in potentially hazardous locations, such as those that are located adjacent to tenant occupied spaces, to be relocated, unless means exist or are provided for eliminating the hazard.

~~[1210.3]~~ **1211.3 Existing systems.** Existing steam piping systems shall be in accordance with Sections ~~[1210.3.1]~~ 1211.3.1 through ~~[1210.3.3]~~ 1211.3.2. Upon the completion of a new high-pressure steam piping system and department approval of same, the rules relating to maintenance requirements and the keeping of records for existing high-pressure steam piping systems shall apply.

~~[1210.3.1]~~ **1211.3.1 Maintenance inspections.** Expansion joints, anchorage and guides shall be inspected as follows:

1. Expansion joints shall be visually inspected monthly.
2. The anchorage and guides shall be visually inspected annually. Exposure of the structural attachments to the buildings of the anchorages or guides shall not be required.
3. A record of such inspections shall be kept by the person in charge of the mechanical equipment of the building or other qualified person designated by the owner and acceptable to the commissioner. The records shall be available at the premises and subject to inspection by the commissioner.

~~[1210.3.2]~~ **1211.3.2 Work approval.** No joint, anchorage or guides shall be repaired, replaced or relocated without a work permit issued by the department. The application for the permit shall contain all pertinent information and shall be filed by an engineer knowledgeable as to high-pressure steam piping systems. The engineer shall be responsible for the special inspection of the proposed work in accordance with the approved application. This provision shall not apply to the repacking of a slip or ball joint; however, records of such repacking shall be kept in the inspection records as provided in Section ~~[1210.3.1]~~ 1211.3.1, Item 3. When, in the opinion of the engineer, the requirement for prior department approval would create an imminent health or safety hazard, the engineer may permit the work to proceed

without prior approval. In such cases, the engineer shall, prior to the repair, replacement or relocation, notify by telephone the borough commissioner of the borough in which the building is located; and, if the emergency occurs at other than normal working hours, he or she shall notify the department in a manner prescribed by the commissioner. This shall be followed by the filing of the application for department approval as specified in Section 28-105.4.1 of the *Administrative Code*.

§14. Chapter 13 of the New York city mechanical code, as amended by local law number 141 for the year 2013, exception 3 of section 1305.11.1.2 as amended by local law number 195 for the year 2018, is amended to read as follows:

CHAPTER 13 FUEL-OIL PIPING AND STORAGE

SECTION MC 1301 GENERAL

1301.1 Scope. This chapter shall govern the design, installation, construction and repair of fuel-oil storage and piping systems. The storage of flammable and combustible liquids not addressed in this chapter shall be in accordance with the *New York City Fire Code*.

1301.2 Storage and piping systems. Fuel-oil storage and piping systems shall comply with the requirements of [~~Chapter 13~~] this chapter, Appendix C and, to the extent not otherwise provided for in this code, shall comply with the requirements of NFPA 31. All [~~above-ground~~] above-ground and underground storage facilities [~~with a combined storage capacity of over 1,100 gallons (4160 L)~~] shall also comply with the requirements of the *New York State Department of Environmental Conservation's Petroleum Bulk Storage Code*.

1301.3 Fuel type. An appliance shall be designed for use with the type of fuel to which it will be connected. Such appliance shall not be converted from the fuel specified on the rating plate for use with a different fuel without conforming with its listing and manufacturers specifications and securing reapproval from the commissioner.

1301.4 Fuel tanks, piping and valves. The tank, piping and valves for appliances burning oil shall be installed in accordance with the requirements of this chapter. [~~When oil-burning equipment is~~] Where oil-burning appliances are served by a tank located such that any part of the tank is above the level of the burner inlet connection and where the fuel supply line is taken from the top of the tank, an approved anti-siphon valve or other siphon-breaking device shall be installed. The anti-siphon valve or siphon-breaking device shall be located at the highest point in the supply line.

Exceptions: An anti-siphon valve or other siphon-breaking device shall not be required where either:

1. An approved foot valve is used in the tank, or
2. No. 6 fuel oil is used.

1301.5 Tanks abandoned or removed. All exterior above-grade fill piping shall be removed when tanks are abandoned or removed. Tank abandonment and removal shall be in accordance with Section 3404 of the *New York City Fire Code*.

1301.6 Out of service system. Fuel-oil storage systems that are temporarily or permanently taken out of service shall comply with the requirements of the *New York City Fire Code* and of the *New York State Department of Environmental Conservation's Petroleum Bulk Storage Code*.

1301.7 Fuel-oil spill and overfill prevention equipment. Fuel-oil spill and overfill prevention equipment shall comply with EPA 40 CFR Parts 280, and Section 1305.6.6.

1301.8 Portable fire extinguishers. Portable fire extinguishers shall be provided as required by the *New York City Fire Code* and NFPA 10.

1301.9 Absorbent materials. The building owner shall maintain a sufficient quantity of absorbent materials near fuel-oil storage tanks, pumps, and related equipment to control leaks and slipping hazards.

1301.10 Certificate of fitness. Where fuel-oil piping systems utilize pumps to transfer fuel oil to equipment at levels above the lowest floor or to storage tanks at levels above the lowest floor in buildings, a qualified employee or contracted general company holding a certificate of fitness from the Fire Department shall maintain the fuel-oil system.

SECTION MC 1302 MATERIAL

1302.1 General. Piping materials shall conform to the ASTM standards cited in this section.

1302.2 Rated for system. All materials shall be rated for the operating temperatures and pressures of the system, and shall be compatible with the type of liquid being handled by the system.

1302.3 Pipe standards. Fuel-oil pipe shall comply with ~~[the standards listed in Table 1302.3]~~ Sections 1302.3.1 and 1302.3.2.

1302.3.1 Fuel-oil pipe. Fuel-oil pipe shall comply with the standards listed in Table 1302.3.

[Exception:] 1302.3.2 Systems serving appliances above ground above the lowest floor. Piping for fuel-oil systems utilizing a transfer pump to ~~[equipment]~~ appliances at levels above ground above the lowest floor or to storage tanks at levels above the lowest floor in buildings shall comply with the requirements of Section 1305.9.5.

TABLE 1302.3 ^(a)
[FUEL OIL] FUEL-OIL PIPING

MATERIAL	STANDARD (see Chapter 15)
[Brass pipe]	[ASTM B 43]
Copper, brass, or copper-alloy pipe	ASTM B 42; <u>ASTM B 43</u> ; ASTM B 302
Copper or copper-alloy tubing (Type K, or L (PVC coated))	ASTM B 75; ASTM B 88; ASTM B 280
[Labeled pipe]	[(See Section 1302.4)]
Nonmetallic pipe	ASTM D 2996
<u>Flexible pipe systems</u>	<u>(See Section 1302.9)</u>
Steel pipe	ASTM A <u>53/A 53M</u> ; ASTM A 106
Steel tubing ^{(b) a}	ASTM A 254 [; <u>ASTM A 539</u>]

a. ~~[Brass tubing, and copper tubing type M are not permitted.]~~

~~[b-]~~ Steel tubing shall only be permitted when installed by the equipment manufacturer in accordance with UL 2200 and UL labeled.

1302.4 Nonmetallic pipe. ~~[All nonmetallic]~~ Nonmetallic pipe shall be listed and labeled as being acceptable for the intended application for flammable and combustible liquids. Nonmetallic pipe shall be installed only outside, underground.

1302.5 Fittings and valves. Fittings and valves for the piping systems shall be compatible with, or shall be of the same material as, the pipe or tubing, and shall conform with Table ~~[4202]~~ 1302.5.

TABLE 1302.5
PIPE FITTINGS

<u>MATERIAL</u>	<u>STANDARD</u>
<u>Copper, brass, and copper alloys</u>	<u>ASME B16.15; ASME B16.18; ASME B16.22; ASME B16.24</u>
<u>Labeled pipe</u>	<u>In accordance with the piping system label and Section 1302.4</u>
<u>Nonmetallic pipe fittings</u>	<u>In accordance with the piping system label and Section 1302.4</u>
<u>Flexible pipe systems</u>	<u>Fittings are allowed in the FO pump room and in the room where the appliance served is located. Intermediate fittings are not allowed inside the buildings.</u>
<u>Steel</u>	<u>ASME B16.5; ASME B16.9; ASME B16.11; ASME B16.28; ASTM A 53/A 53M; ASTM A 106; ASTM A 234; ASTM A 420</u>

1302.6 Bending of pipe. Pipe shall be suitable for bending and shall conform with Table 1302.3. Pipe bends shall be made with approved equipment. The bend shall not exceed the structural limitations of the pipe.

1302.7 Pumps. Pumps that are not part of an appliance shall be of a positive-displacement type. The pump shall automatically shut off the supply when not in operation. ~~[Pumps shall be listed and labeled in accordance with UL 343.]~~

1302.8 Flexible connectors and hoses. Flexible metal connectors and hoses used where rigid connections are impractical or to reduce the effect of jarring and vibration shall be listed and labeled in accordance with ~~[UL 536]~~ UL 2039 and shall be installed in compliance with its label

and the manufacturer's installation instructions and shall not exceed 18 inches ([457] 457.2 mm). Connectors made from combustible materials shall not be used inside buildings or above ground outside of buildings.

1302.9 Flexible fuel-oil piping systems with continuous vacuum leak detection. Flexible fuel-oil piping systems with continuous vacuum leak detection consisting of a single wall or double wall metallic primary carrier encased with outer polymer jacket shall comply with the requirements of Sections 1302.9.1 through 1302.9.2.

1302.9.1 Listing: Flexible fuel-oil piping systems with continuous leak detection shall be tested and evaluated in accordance with ULC-S667 and shall be listed and labeled by an approved agency.

1302.9.2 Design and Installation. Flexible fuel-oil piping systems with continuous leak detection shall comply with the requirements of Sections 1302.9.2.1 through 1302.9.2.6.

1302.9.2.1 Installation. Flexible fuel-oil piping systems shall be designed and installed in accordance with this code, manufacturer's recommendation, and their listing.

1302.9.2.2 Outdoor applications. Flexible fuel-oil piping systems with continuous vacuum leak detection may be used for above ground outdoor applications, if such systems are double metallic piping with polymer protective cover for exterior exposure to the elements. A fire-resistance-rated enclosure shall not be required for such applications.

1302.9.2.3 Continuous pipe run. Flexible fuel-oil piping systems shall be installed with a single continuous pipe run from the transfer pump to the appliance or storage tank it serves. Intermediate couplings are not allowed within buildings.

1302.9.2.4 Levels above the lowest floor. Where installed above ground, flexible fuel-oil piping systems connecting a transfer pump to equipment at levels above the lowest floor or storage tanks at levels above the lowest floor in buildings shall also comply with the requirements of Section 1305.9.

1302.9.2.5. Horizontal offsets. Horizontal offsets shall comply with Section 1305.9.3.

1302.9.2.6 Leak detection and alarm. Flexible fuel-oil piping systems shall be installed with continuous vacuum leak detection and alarm. The alarm shall sound and the transfer pump shall stop when a leak is detected. The alarm shall be connected to a local audible alarm and to a remote alarm located at a supervising station. The wiring shall comply with the *New York City Electrical Code*.

SECTION MC 1303 JOINTS AND CONNECTIONS

1303.1 General. Joints and connections shall conform to the ASTM Standards listed in [~~Section 4203~~] Table 1302.5, shall be of a type approved for fuel-oil piping systems, shall be rated for the temperatures and pressures of the systems in which the devices are installed, and shall be compatible with the fluid and all materials used. All threaded joints and connections shall be made

tight with suitable lubricant or pipe compound. Unions and flanges, right or left couplings, and sweat fittings shall be brazed in accordance with ASME Boiler and Pressure Vessel Code, Section IX (Welding and Brazing Qualifications) or in accordance with AWS B2.2 Standard for Brazing Procedure and Performance Qualification. Cast-iron fittings shall not be used. Joints and connections shall be tight for the pressure required by test. Flanged joints requiring gaskets or packing shall be equipped with gaskets rated for a minimum of 750°F ([399]398.9°C).

1303.1.1 Joints between different piping materials. Joints between different piping materials shall be made with adapter fittings. Joints between different metallic piping materials shall be made with approved dielectric fittings. All such fittings shall conform with the requirements of Section 1203.

1303.2 Reserved.

1303.3 Joint preparation and installation. Where required by Sections 1303.4 through 1303.10, the preparation and installation of brazed, [~~mechanical,~~] threaded and welded joints shall comply with Sections 1303.3.1 through 1303.3.4.

1303.3.1 Brazed joints. All joints shall be brazed in accordance with ASME Boiler and Pressure Vessel Code, Section IX Welding and Brazing Qualifications or in accordance with American Welding Society AWS B2.2 Standard for Brazing Procedure and Performance Qualification.

1303.3.2 [~~Mechanical joints. Mechanical joints utilizing an elastomeric and/or compression seal are not permitted.~~] Reserved.

1303.3.3 Threaded joints. Threads shall conform to ASME B1.20.1. Pipe-joint compound or tape shall be applied on the male threads only and shall be compatible for application on the piping material and fluid.

1303.3.4 Welded joints. All joints shall be welded in accordance with ASME Boiler and Pressure Vessel Code, Section IX Welding and Brazing Qualifications or in accordance with AWS B2.1 Specifications for Welding Procedure and Performance Qualification.

1303.4 Brass pipe. Joints between brass pipe or fittings shall be brazed, [~~mechanical,~~] threaded or welded joints complying with Section 1303.3.

1303.5 Reserved.

1303.6 Copper or copper-alloy pipe. Joints between copper or copper-alloy pipe or fittings shall be brazed, [~~mechanical,~~] threaded or welded joints complying with Section 1303.3.

1303.7 Copper or copper-alloy tubing. Joints between copper or copper-alloy tubing or fittings shall be brazed [~~or mechanical~~] joints complying with Section 1303.3 or flared joints. Flared joints shall be made by a tool designed for that operation.

1303.8 Nonmetallic pipe. Joints between nonmetallic pipe or fittings shall be installed in accordance with the manufacturer's instructions for the labeled pipe and fittings.

1303.9 Steel pipe. Joints between steel pipe or fittings shall be threaded or welded joints complying with Section 1303.3.

1303.10 Reserved.

1303.11 Piping protection. Proper allowance shall be made for expansion, contraction, jarring and vibration. Piping other than tubing, connected to underground tanks, except straight fill lines and test wells, shall be arranged to permit the tanks to settle without impairing the tightness of the piping connections. Piping serving equipment at levels above the lowest floor or storage tanks at levels above the lowest floor in buildings shall also comply with the requirements of Sections 1305.9.6 and 1305.9.7. Piping that is routed outside of the building or on the roof shall be provided with a protective coating to prevent rust. Supports for such piping shall be made of stainless steel or other corrosion resistive material.

SECTION MC 1304 PIPING SUPPORT

1304.1 General. Pipe supports shall be in accordance with Section 305. Piping serving equipment at levels above the lowest floor or storage tanks at levels above the lowest floor in buildings shall also comply with the requirements of Sections 1305.9.6 and 1305.9.7.

SECTION MC 1305 FUEL-OIL SYSTEM INSTALLATION

1305.1 General. Fuel-oil piping systems shall be installed in accordance with this section.

1305.2 Protection of pipe, equipment and appliances. All fuel-oil pipe, equipment and appliances shall be protected from physical damage. Piping serving equipment at levels above the lowest floor or storage tanks at levels above the lowest floor in buildings shall also comply with the requirements of Section 1305.9.

1305.2.1 Flood hazard. All fuel-oil pipe, tanks, equipment and appliances located in [~~areas of special~~] flood hazard areas shall comply with Appendix G of the *New York City Building Code*.

1305.2.2 Identification of concealed fuel-oil piping. Where horizontal fuel-oil piping is concealed within the building construction, such piping at intervals not more than 40 feet (12 192 mm) in length and at all changes of direction shall be identified by a permanent label or tag. The label or tag shall be located outside of the enclosure.

1305.3 [~~Supply piping. Supply piping~~] Piping. Piping shall comply with the requirements of Sections 1305.3.1 through [~~1305.3.7~~] 1305.3.9.

1305.3.1 Size. The fuel-oil system shall be sized for the maximum capacity of fuel oil required. The minimum size of a supply line shall be $\frac{3}{8}$ -inch (9.5 mm) inside diameter nominal pipe or $\frac{3}{8}$ -inch (9.5 mm) OD tubing.

1305.3.2 Connections to tank. Supply piping shall connect to the top of the fuel-oil tank.

Exception: Storage tanks in buildings that comply with all of the following conditions:

1. The tank is located above ground on the lowest floor;
2. The tank does not exceed 330 gallons (~~[1250]~~ 1249.2 L); and
3. The tank is provided with a [³/₄-] 1/2-inch (~~[19.1]~~ 12.7 mm) opening for gravity discharge ~~[and a 1-inch (25 mm) opening]~~ in the bottom of the tank ~~[for cleaning and protection against corrosion].~~

1305.3.3 Pumps. Fuel oil shall be supplied by a transfer pump or automatic pump ~~[or by other approved means].~~

1305.3.4 [~~Smoke~~] Safeties and heat detectors. Appropriate safeties shall be provided so that detection of ~~[smoke or]~~ heat within the generator or equipment room shall prevent additional fuel oil from being pumped into the piping system within such room, including ~~[a]~~ fusible link operated ~~[valve]~~ valves in the supply pipe at the ~~[wall of]~~ suction side of the fuel oil transfer pump and in the supply pipe entering the generator ~~[or]~~ fuel oil burning equipment room or rooftop equipment enclosure.

1305.3.5 Horizontal runouts. Horizontal runouts from risers to the generator or equipment room shall follow as direct a route as practicable.

1305.3.6 Supply piping. Supply piping from a transfer pump to appliances at levels above the lowest floor or storage tanks at levels above the lowest floor in buildings shall also comply with the requirements of Section 1305.9.

1305.3.7 Return piping. In direct feed systems, the minimum size of a return line shall be no less than the size of the supply piping specified in Section 1305.3.1. Valves shall not be installed on return piping unless a means of relieving overpressure is provided. Return piping serving equipment at levels above the lowest floor in buildings shall also comply with the requirements of Section 1305.9.

1305.3.8 Overflow piping. In systems with fuel oil storage tanks above the lowest level, overflow piping from tanks installed above the lowest floor shall be piped by gravity into the top of the tank at the lowest floor that supplies fuel to such tank. The overflow pipe shall be minimum two pipe sizes larger than fuel oil supply pipe. Valves shall not be installed on overflow piping.

1305.3.9 Direct feed. Systems where day tanks are absent (such as generator installations where fuel oil is taken directly from a fuel-oil pipe or header into the engine) shall comply with Section 1305.9.12.

~~[1305.3.7 Piping from transfer pump to equipment or storage tanks above the lowest floor. Supply piping from a transfer pump to equipment at levels above the lowest floor or storage tanks at levels above the lowest floor in buildings shall also comply with the requirements of Section 1305.9.]~~

1305.4 [Return piping.] ~~Return piping shall connect to the top of the fuel-oil tank. The minimum size of a return line shall be no less than the size of the supply piping specified in Section 1305.3.1. Valves shall not be installed on return piping unless a means of relieving overpressure is provided. Return piping serving equipment at levels above the lowest floor or storage tanks at levels above the lowest floor in buildings shall also comply with the requirements of Section 1305.9.]~~
Reserved.

1305.5 System pressure. The system shall be designed for the maximum pressure required by the fuel-oil-burning appliance. Air or other gases shall not be used to pressurize tanks. Pressure in a storage tank for the purpose of discharging oil shall be prohibited.

1305.6 Fill piping. Fill piping shall comply with the requirements of Sections 1305.6.1 through 1305.6.6.

1305.6.1 Size. Fill piping shall be a minimum of 2 inches (~~[54]~~ 50.8 mm) in diameter or 3 inches (~~[76]~~ 76.2 mm) for No. 6 fuel oil.

1305.6.2 Termination location. A fill pipe shall terminate outside of a building at or above grade at a point [~~at least~~] not less than 2 feet (~~[610]~~ 609.6 mm) from any building opening and not less than 5 feet (1524 mm) away from any subway grating at the same or lower level. A fill pipe shall terminate in a manner designed to minimize spilling when the filling hose is disconnected. Where No. 6 fuel oil is used, the fill pipe terminal shall be within 3 feet (~~[914]~~ 914.4 mm) of the curb unless otherwise required by the Department of Transportation or the Transit Authority. If facilities exist for an oil delivery truck to drive onto the premises, the fuel-oil terminal may be located elsewhere other than the curb.

1305.6.3 Separate fill piping. Each storage tank shall be provided with a separate fill pipe, except that where a battery of tanks containing the same grade of oil is installed, a common fill and header pipe may be installed.

1305.6.4 [~~Check valve~~] Storage tank above the fill terminal. Where the top of the storage tank is above the fill pipe terminal, the fill pipe shall be connected to the top of the tank and provided with [~~a~~] one of the following:

1. A shutoff valve and swing check valve [~~both of which shall be~~] located at the fill pipe terminal [~~The shutoff valve and swing check valve may be~~] or installed in an accessible location inside the building at or below the level of the fill pipe terminal.
2. A dry disconnect fitting with a ball and a check valve located at the fill pipe terminal.

1305.6.5 Terminal opening. The fill opening shall be equipped with a tight metal cover designed to discourage tampering. All fill pipe terminals shall be of an approved type and shall be provided with lugs for embedding in concrete. In lieu of lugs, a set screw or threads to fasten the terminal to the fill pipe may be used. The outer flange of the fill pipe terminal or the seal cap shall be permanently marked: FUEL OIL. The fill pipe terminal shall be right-handed thread or provided with other equivalent means to receive the seal cap. The seal cap shall be suitably slotted for receiving an opening wrench, and an oilproof gasket inserted in a groove in the fill pipe terminal shall be provided so as to make the seal cap leakproof. A

strainer shall not be required but if used, shall be of at least 1/8-inch (3.2 mm) mesh. Where a storage system for volatile flammable oil and a storage system for fuel oil are to be used in the same premises, the terminal of the volatile oil pipe shall be provided with a left-handed thread and the fill pipe fitting shall be of a different size than that required for the fill pipes to the tanks containing the volatile flammable oil.

1305.6.6 Spill containment. For fill terminal openings serving underground storage tanks greater than 110 gallons (416.4 L) and above-ground storage tanks greater than 660 gallons ([2500] 2498.4 L), an approved overflow/spill containment device shall be provided.

1305.7 Normal vent piping. Normal vent piping shall comply with the requirements of Sections 1305.7.1 through 1305.7.9.

1305.7.1 Size. Normal vent sizes shall comply with the sizes listed in Tables 1305.7(1) and 1305.7(2); provided, however, for tanks other than those complying with the alternate tank design and construction standards contained in Section 1305.14, the normal vent shall not be smaller in size than the ~~[supply]~~ fill pipe.

**TABLE 1305.7(1)
VENT PIPING FOR UNDERGROUND TANKS**

TANK SIZE	MINIMUM VENT DIAMETER
660 gallons [(2500 L)] (2498 L) or less	1¼ inch ([32] <u>31.8</u> mm)
661 gallons (2505 L) to 3,000 gallons (11 355 L)	1½ inch ([38] <u>38.1</u> mm)
3,001 gallons (11 360 L) to 10,000 gallons (37 850 L)	2 inch ([54] <u>50.8</u> mm)
10,001 gallons (37 855 L) to 20,000 gallons (75 700 L)	2½ inch ([64] <u>63.5</u> mm)
Larger than 20,000 gallons (75 700 L)	3 inch ([76] <u>76.2</u> mm)

TABLE 1305.7(2)
NORMAL VENT PIPING FOR TANKS INSTALLED INSIDE
BUILDINGS

TANK SIZE	MINIMUM VENT DIAMETER
660 gallons [(2500 L)] (<u>2498 L</u>) or less	1 ¹ / ₄ inch ((32) <u>31.8 mm</u>) ^a
Larger than 660 gallons [(2500 L)] (<u>2498.4 L</u>)	Sized to prevent abnormal pressure in the tank during filling but not smaller than the pipe size specified in Table 1305.7(1)

a. For tanks constructed to UL 80 specifications, the minimum vent diameter shall be 2 inches (~~(51)~~ 50.8 mm). For tanks constructed to UL 142 specifications, the minimum vent diameter shall not be less than as required by Section 1305.8.4.

1305.7.2 Termination location. The location of the normal vent pipe terminations shall comply with the following:

1. Liquid fuel normal vent pipes shall terminate outside of buildings in a nonhazardous location at a point not less than 2 feet (~~(610)~~ 609.6 mm) measured vertically or horizontally from any building opening and not less than 2 feet (~~(610)~~ 609.6 mm) nor more than 12 feet (~~(3658)~~ 3657.6 mm) above the fill pipe terminal.
2. If the normal vent pipe terminal is not visible from the fill pipe terminal location, an electronic overfill alarm system or a 1-inch (~~(25)~~ 25.4 mm) tell-tale line shall be connected to the tank and shall parallel the fill pipe and terminate at the fill pipe terminal with an unthreaded end. Such tell-tale lines shall be provided with a check valve set to prevent flow of surface water to the storage tank.
3. Normal vent pipes shall terminate sufficiently above the ground to avoid being obstructed with snow or ice.
4. Normal vent pipes from tanks containing heaters shall be extended to a location where oil vapors discharging from the normal vent will be readily diffused.

1305.7.3 Termination caps. Outer ends of normal vent pipes shall terminate in a weatherproof vent cap or fitting or be provided with a weatherproof hood. All normal vent caps shall have a minimum free open area equal to the cross-sectional area of the normal vent pipe and shall not employ screens finer than No. 4 mesh.

1305.7.4 Tank pressure. The tank shall be designed for the maximum static head that will be imposed with the normal vent piping filled with oil.

1305.7.5 Multiple tanks. A normal vent pipe shall be provided for each storage tank. Normal vent piping from multiple tanks of the same grade oil with not more than 660 gallons ([~~2500~~] 2498.3 L) aggregate capacity may be combined. Where a battery of storage tanks complying with the alternate tank design and construction standards contained in Section 1305.14

designed to hold the same grade of oil with not more than 660 gallons (~~[2500]~~ 2498.3 L) aggregate capacity is installed, normal vent pipes may be run into a main header.

1305.7.6 Pitch. Normal vent pipes shall drain toward the tank. The normal vent pipes shall have no sags or traps where liquid can collect.

1305.7.7 Protection. Normal vent pipes shall be located so that they are not subjected to physical damage.

1305.7.8 Cross-connection. Liquid fuel normal vent pipes shall not be cross-connected with fill pipes, supply lines to, or return lines from burners or ~~[overflow lines from auxiliary tanks]~~ other fuel-burning equipment.

1305.7.9 Tanks ~~[above the lowest floor]~~ served by pumps. For tanks ~~[installed above the lowest floor]~~ on any floor served by pumps, the normal vent shall be connected to the overflow pipe, shall be piped ~~[, in an approved manner, into the vent or top of tank of the lowest floor storage tank that supplies the fuel to such tank]~~ a minimum of 8 feet (2438.4 mm) above the overflow pipe and terminated directly to the outdoors. A liquid sensor shall be installed in the vent of the remotely served tank in order to shut down oil supply in the event of an overflow.

1305.8 Emergency relief vent piping. Each primary tank, the interstitial space of a secondary containment tank and each compartment of a compartment tank complying with UL 142 shall be provided with emergency relief venting. A tank's emergency relief vent piping and normal vent piping ~~[shall]~~ may be combined. The design and installation of the combined normal and emergency relief vent shall be in accordance with Section 1305.7 and Sections 1305.8.1 through 1305.8.4. Tanks designed in accordance with Section 1305.14 shall not require emergency relief vent piping. The use of a self-closing manway cover, a manway cover provided with long bolts that permit the cover to lift under internal pressure, or other type of emergency relief vent device inside the building, shall be prohibited.

1305.8.1 Piping. The combination normal and emergency relief venting shall be provided through an open vent pipe ~~[connected directly, as applicable, to the primary tank, interstitial space or compartment. The use of a self-closing man-way cover, a manway cover provided with long bolts that permit the cover to lift under internal pressure, or other type emergency relief vent device, shall be prohibited]~~ and shall be terminated outdoors.

1305.8.2 ~~[Termination. Combination normal and emergency relief vent piping shall terminate outdoors.]~~ Reserved.

1305.8.3 ~~[Tanks above the lowest floor. For tanks installed inside of buildings above the lowest floor, the combination normal and emergency vent piping shall be piped, in an approved manner, into the vent or top of tank of the lowest floor storage tank that supplies the fuel to such tank. Normal and emergency vents are to be sized in accordance with NFPA 30.]~~ Reserved.

1305.8.4 Capacity. The total relief venting capacity of the combination normal and emergency relief venting shall be in accordance with Section ~~[4.2.5.2]~~ 22.7 of NFPA 30. Construction documents shall include calculations demonstrating that the extension of the

normal and emergency vent piping is adequately sized to provide the required emergency vent flow while limiting the backpressure to less than the maximum pressure permitted by the design of the tank. Additionally, consistent with Section [4.2.5.2.5] 27.7.3.4 of NFPA 30, where the design provides for a reduction in the required emergency relief venting capacity based upon the properties of the fuel oil to be stored in the tank, the construction documents shall include supporting calculations.

1305.9 Supplemental requirements for piping from transfer pumps to [equipment] appliances or storage tanks above lowest floor. Fuel-oil piping systems utilizing pumps to transfer fuel oil to equipment at levels above the lowest floor or storage tanks at levels above the lowest floor in buildings shall comply with the requirements of Sections 1305.9.1 through 1305.9.12.

1305.9.1 Shaft enclosure. The piping from a transfer pump to equipment at levels above the lowest floor or storage tanks at levels above the lowest floor in buildings, the return or overflow piping, and vent piping where required to be connected to the main storage tank shall be enclosed in a shaft constructed of 4-inch ([402] 101.6 mm) concrete or masonry having a 4-inch ([402] 101.6 mm) clearance from all pipe or pipe covering [~~except that no such enclosures shall be required within the room containing the pump, tank, or equipment where such room is itself enclosed with construction and materials having at least a 2-hour fire-resistance rating~~] in accordance with the *New York City Building Code*. Multiple fuel oil risers serving multiple systems are permitted within a common shaft enclosure. All shaft penetrations [~~must~~] shall be fire stopped.

Exceptions:

1. An enclosure shall not be required for piping located within the same room as the pump, tank, or equipment where such room is itself enclosed with construction and materials having at least a 2-hour fire-resistance rating.
2. An enclosure shall not be required for outdoor piping in existing buildings in compliance with Section 1305.9.13.
3. A concrete or masonry shaft enclosure shall not be required for metallic double wall flexible fuel-oil piping installed in a shaft enclosure having a fire-resistance rating of at least 2-hours and that complies with Sections 703.2 and 708 of the *New York City Building Code*.

1305.9.2 Ducts or other piping in shafts. Pipe shafts containing fuel-oil piping shall not be penetrated by or contain other piping or ducts.

1305.9.3 Horizontal offsets. Where it is necessary to make horizontal offsets [~~in the supply and overflow/return~~] in the fuel-oil piping and pipe shafts, including the lowest level, such piping shall be enclosed in a [sleeve of other piping] fully welded outer containment of at least No. 10 standard Gage steel [~~two sizes larger than the supply piping and arranged to drain into the shaft. Horizontal piping offsets shall be further enclosed in construction having a 2-hour fire-resistance rating except that no such enclosure or pipe sleeve shall be required for the pipes serving the equipment within the room containing the pump, tank, or equipment~~]

~~where such room is itself enclosed with construction and materials having at least a 2-hour fire-resistance rating. Horizontal piping shall include all piping at or above the roof level. No 2-hour fire-resistance-rated enclosure is required for horizontal piping offsets located outside the building].~~

Exceptions:

1. The containment enclosure may be omitted on horizontal piping along the roof for a maximum length of 72 inches (1828.8 mm) from the enclosure, tank or the equipment served for hard piped connections and valves as required.
2. The containment enclosure may be omitted where a double metallic wall flexible fuel-oil piping system is installed as a horizontal offset, such pipe system does not need to be enclosed in an additional containment enclosure.

1305.9.3.1 Drainage and leak detection. Horizontal offsets shall be arranged to drain by gravity toward the tank room on the lowest level. Where the length of the horizontal offset exceeds 25 feet (7620 mm), the containment enclosure shall be constructed with an integral leakage collection reservoir of a cross-section area equal to the containment enclosure and at a minimum 6 inches (152.4 mm) deep. The reservoir shall be provided with a leak detection alarm. Where provided, all leak detection alarms shall be connected to a local audible alarm and to a remote alarm located at a supervising station. The wiring shall comply with the *New York City Electrical Code*.

Exception: A leak collection reservoir is not required where double metallic wall flexible fuel-oil piping is installed as a horizontal offset in accordance with Section 1302.9.

1305.9.3.2 Size. The containment enclosure shall be two sizes larger than the enclosed pipe for single pipe enclosures. Enclosures containing multiple pipes shall be sized to provide a minimum ½-inch (12.7 mm) clearance around the pipe bundle.

1305.9.3.3 Fire-resistance rating. In addition to the outer containment enclosure, horizontal piping offsets shall be further enclosed in construction having a 2-hour fire-resistance rating.

Exceptions:

1. A containment enclosure and 2-hour fire-resistance-rated enclosure are not required for the pipes serving the equipment or appliance within the room containing the pump, tank, or fuel-burning appliance where such room is itself enclosed with construction and materials having at least a 2-hour fire-resistance-rating.
2. A 2-hour fire-resistance-rated enclosure is not required for horizontal piping offsets located outside the building or on the roof.

1305.9.3.4 Horizontal offsets on roofs. Horizontal offsets on roofs shall be limited to a maximum vertical rise of one story.

1305.9.4 Drain pan at base of shafts [;] with leak detection. A metal drain [pipe] pan shall be installed at the base of [shafts] every vertical shaft enclosing the [supply and overflow/return] fuel-oil piping. [~~The pipe shall lead to a dedicated sump or minimum 55-gallon (208 L) container with a leak detection alarm, arranged so as to sound an alarm and stop the transfer pump. The alarm shall be connected to a local audible alarm and to a remote alarm located at a supervising station. The wiring shall comply with the *New York City Electrical Code.*]~~ Where the bottom of the shaft is located outside the fuel oil storage tank room, the drain pan shall be connected to and drained into a containment enclosure at the horizontal offset of fuel-oil piping. On the lowest level in the building, the outer containment of horizontal offsets shall be terminated inside the main storage tank room or transfer pump room. A drain pipe shall be provided from the lowest point in the containment enclosure to a minimum 55-gallon (208.2 L) container with a leak detection alarm, arranged so as to sound an alarm and stop the transfer pump.

1305.9.5 Piping materials. Oil lines for appliances, equipment or tanks shall be steel pipe ASTM A 53/A 53M or ASTM A 106, grade B seamless Schedule 40 with welded connections up to the oil tank or equipment, except that fittings at the tank or equipment, shutoff valves and other fuel-oil flow and control devices may be screwed or flanged.

Exception: Flexible fuel-oil piping systems with continuous vacuum leak detection in accordance with Section 1302.9.

1305.9.6 Expansion. Provision shall be made for expansion in piping without the use of expansion joints.

1305.9.7 Movement and vibration. The piping shall be located and secured from movement so as to prevent undue stress on the piping and to isolate the piping from vibrations from any equipment.

1305.9.8 Connections to header. Pipe connections to the main header (supply or return) shall be made from the top of the header [~~except for~~].

Exception: [~~systems~~] Systems with [~~equipment~~] appliances above the lowest floor where such [~~equipment is~~] appliances are designed to operate utilizing fuel pumped as needed from the lowest floor and without utilizing fuel oil stored via header above the lowest floor.

1305.9.9 [~~Air vents and breakers~~] Vacuum breaking devices. [~~Required air vents and vacuum breakers~~] Vacuum breaking devices shall be designed for their required use. Vacuum breaking devices shall be hard-piped to a reservoir with a leak detection alarm, arranged so as to sound an alarm. The alarm shall be connected to a local audible alarm and to a remote alarm located at a supervising station. The wiring shall comply with the *New York City Electrical Code.*

1305.9.10 ~~[Curb or pan. All air vents and vacuum breakers shall be hard piped to a curb or pan.]~~ **Reserved.**

1305.9.11 Pipe size; fuel storage tank above the lowest floor. In systems with ~~[equipment]~~ appliances above the lowest floor where such ~~[equipment is]~~ appliances are designed to operate utilizing fuel stored above the lowest floor, piping diameters shall not exceed 4 inches (~~[402]~~ 101.6 mm). ~~[However, where]~~

Exception: Where an applicant demonstrates, by ~~[the inclusion of]~~ calculations in the construction documents, that a greater diameter is necessary to ensure the proper flow for the functioning of the system ~~[, such greater diameter may be permitted. Piping shall not be used for fuel storage purposes].~~

1305.9.12 Pipe size; direct feed without fuel storage above the lowest floor. In systems with ~~[equipment]~~ appliances above the lowest floor, where such ~~[equipment is]~~ appliances are designed to operate utilizing fuel pumped as needed from the lowest floor ~~[and without utilizing fuel oil stored above the lowest floor, piping diameters throughout such systems shall not exceed the design flow (three times the maximum firing rate as calculated by the engineer or architect). However, piping]~~ on demand sequenced with the equipment operation, piping diameters shall not exceed 4 inches (101.6 mm). Piping shall not be used for fuel storage purposes.

Exceptions:

1. Piping diameters may exceed 4 inches (101.6 mm) where an applicant demonstrates, by calculations in the construction documents, that a greater diameter is necessary to ensure the proper flow for the functioning of the system.
2. Piping diameters within rooms containing ~~[such]~~ fuel-burning equipment may exceed the calculated design flow pipe size to provide limited ~~[reservoir]~~ storage to prime equipment, provided such ~~[reservoir]~~ storage is counted toward the maximum permitted oil storage per story, as provided for in Section 1305.11.1.3.

1305.9.13 Outdoor fuel-oil piping in existing buildings. Outdoor fuel-oil piping in existing buildings, including vertical piping, utilizing pumps to transfer fuel oil to appliances at levels above the lowest floor or to storage tanks at levels above the lowest floor in buildings shall additionally comply with the following:

1. Piping shall be located a minimum of 10 feet (3048 mm) from lot lines or a 2-hour fire-rated-enclosure shall be provided.
2. Piping shall be located a minimum of 3 feet (914.4 mm) from building openings and combustible construction.
3. Vertical outdoor fuel-oil piping shall be enclosed in a fully welded outer containment of at least No. 10 standard Gage steel sized in accordance with Section 1305.9.3.2.

4. Horizontal outdoor fuel-oil piping shall comply with Section 1305.9.3.
5. In addition to the requirement of Section 1305.9.4, a drain pipe shall also be provided from the lowest point in the vertical outdoor containment enclosure to a minimum 55-gallon (~~208~~ 208.2 L) container with a leak detection alarm, arranged so as to sound an alarm and stop the transfer pump. The container may be located immediately inside the building.
6. Materials and supports directly exposed to the weather shall be stainless steel or other corrosion resistive material.
7. Details shall be provided for piping supports and connections to building structure.
8. Penetrations of building walls shall be encased in a protective pipe sleeve. The annular space between the piping and the sleeve shall be sealed in accordance with the *New York City Building Code*.
9. Piping shall be grounded in accordance with the *New York City Electrical Code* Section 250.104 (B).
10. Piping shall be protected from vehicle impact and physical damage.
11. Flexible fuel-oil piping systems shall not be utilized.
12. Egress paths shall not be obstructed.
13. Roof access shall comply with Section 306.5.
14. Piping shall be identified by a permanent label or tag at intervals not more than 40 feet (12 192 mm) in length and at all changes of direction. The label or tag shall be located outside of the enclosure.

1305.10 Devices to control flow to oil-burning [equipment] appliances including generators.

The following requirements shall apply:

1. The pressure in oil lines to oil-burning [equipment] appliances located above the lowest floor of a building shall not be more than is required to circulate oil to and from the burners, and all parts of the oil system shall be capable of withstanding the maximum working pressure in that part of the system.
2. A remote control shall be provided to stop the flow of oil to any burner wherever located, and to any oil-burning [equipment] appliances located on levels above the lowest floor in buildings as well as the fuel oil transfer pumps. Such control shall be located outside the entrance to the room in which the burner is located and as close to such entrance as practicable, except that when an outside location is impracticable, such control may be located immediately inside the room in which the burner is located, provided such location is accessible at all times. All such controls shall be permanently labeled: "REMOTE CONTROL FOR BURNER," or as appropriate to the oil-burning [equipment] appliance.

On storage tanks of 60 gallons (~~[227]~~ 227.1 L) or less capacity used with manually operated ~~[equipment]~~ appliances, such remote control may be installed in the supply lines between tank and burner.

3. In systems where either steam or air is used for atomizing the oil, the oil and the atomizing supply shall be interlocked so that where the supply of either is interrupted, the supply of the other will be immediately cut off.

1305.11 Limitations on quantities of fuel-oil storage. Quantities of fuel-oil storage shall be limited in accordance with the provisions of this section. For the purposes of this section, fuel oil stored on roofs shall be deemed inside of buildings and located on the floor to which they are adjacent.

1305.11.1 Inside of buildings. A total of not more than 100,000 gallons (~~[378-000]~~ 378 541.2 L) shall be stored inside of any building. Oil storage inside of buildings shall also comply with applicable requirements of Sections 1305.11.1.1 through 1305.11.1.3.

1305.11.1.1 Inside of buildings; below ground. The maximum size of each below-ground oil-storage tank inside of a building shall be 35,000 gallons (~~[132-475]~~ 132 489.4 L).

1305.11.1.2 Inside of buildings; above ground on the lowest floor. Fuel-oil storage tanks installed above ground on the lowest floor of a building shall be mounted on and anchored by adequate noncombustible supports. The maximum size of each individual tank shall be 660 gallons (~~[2500]~~ 2498.4 L), and a total of not more than 1375 gallons (~~[5200]~~ 5204.9 L) shall be stored within the same 2-hour fire ~~[area]~~ and smoke barrier construction.

Exceptions. Fuel-oil storage tanks shall be permitted to exceed 660 gallons (~~[2500]~~ 2498.4 L), and the total quantity within a fire area shall be permitted to exceed 1375 gallons (~~[5200]~~ 5204.9 L) in accordance with any one of the following options:

1. **Buildings of Type I, II, IIIA, IV or VA construction with a total limit of 15,000 gallons (56 781.1 L).** The maximum size of each individual tank shall be 15,000 gallons (~~[56-775]~~ 56 781.1 L) provided that all such tanks are located in a room or enclosure dedicated to oil storage that is separated from the rest of the building by ~~[fire-resistance-rated]~~ fire and smoke barrier construction of at least 3 hours. Notwithstanding Section 1305.11.1, in such cases, the maximum total quantity in the building shall be limited to 15,000 gallons (~~[56 775]~~ 56 781.1 L).
2. **Buildings of Type IIIB or VB construction with a total limit of 10,000 gallons (37 854.1 L).** The maximum size of each individual tank shall be 10,000 gallons (~~[37-850]~~ 37 854.1 L) provided that all such tanks are located in a room or enclosure dedicated to oil storage that is separated from the rest of the building by ~~[fire-resistance-rated]~~ fire and smoke barrier construction of at least 3 hours. Notwithstanding Section 1305.11.1, in such cases, the maximum total quantity in the building shall be limited to 10,000 gallons (~~[56 775]~~ 37 854.1 L).

3. **Buildings of any type construction with a total limit of 100,000 gallons (378 541.8 L).** The maximum size of each individual tank shall be 25,000 gallons (~~[94-625]~~ 94 635.3 L) provided that all such tanks are enclosed in a vault (i) with walls, floor, and top having a ~~[fire-resistance-rating]~~ fire and smoke barrier construction of not less than 3 hours, (ii) with such walls bonded to the floor, and (iii) with such top and walls of the vault independent of the building structure. An exterior building wall having a ~~[fire-resistance-rating]~~ fire and smoke barrier construction of not less than 3 hours shall be permitted to serve as a wall of the vault. The vault shall be located in a dedicated room or area of the building that is cut off vertically and horizontally from other areas and floors of the building by assemblies having a ~~[fire-resistance-rating]~~ fire and smoke barrier construction of not less than 2 hours. Where the aggregate fuel-oil storage on the lowest level of the building exceeds 50,000 gallons (~~[189-250]~~ 189 270.6 L), such storage shall be protected with an alternate extinguishing system complying with the New York City Fire Code and Section 904 of the New York City Building Code.

1305.11.1.3 Inside of buildings; above the lowest floor. Fuel oil above the lowest floor inside of a building shall be limited to 330 gallons (~~[1249]~~ 1249.1 L) per story. The maximum quantity shall include oversized piping as described in Section 1305.9.12. Piping installations shall comply with the requirements of Section 1305.9.

Exception: Fuel-oil storage capacity in ~~[areas of]~~ special flood hazard areas and shaded X-Zones, as defined in ~~[Section G201.2 of Appendix G]~~ Chapter 2 of the *New York City Building Code*, shall comply with Section G307.4 of Appendix G of the *New York City Building Code*.

1305.11.2 Outside of buildings. Oil storage outside of buildings shall comply with applicable requirements of Sections 1305.11.2.1 and 1305.11.2.2.

1305.11.2.1 Outside of buildings; below ground. The maximum size of each below-ground oil-storage tank outside of a building shall be 35,000 gallons (~~[132-475]~~ 132 489.4 L).

1305.11.2.2 Outside of buildings; above ground. The maximum size of each above-ground oil-storage tank outside of a building shall be 100,000 gallons (~~[378-000]~~ 378 541.2 L).

1305.12 Standards for tank design. Tanks shall be designed and constructed in compliance with Sections 1305.12.1 and 1305.12.2.

1305.12.1 Below ground. Tanks located below ground, inside or outside of buildings, shall comply with any one of the following design standards, as appropriate for the specific installation as determined by the engineer [=:]. Cathodic protection shall be provided in accordance with subpart 613-2 of the New York State Department of Environmental Conservation's Petroleum Bulk Storage Code.

1. UL 58; such tanks shall be listed and labeled;

2. UL 1316; such tanks shall be listed and labeled; or
3. Alternate tank design and construction standards contained in Section 1305.14.

1305.12.2 Above ground. Tanks located above ground, inside or outside of buildings, shall comply with any one of the following design standards, as appropriate for the specific installation as determined by the engineer:

1. UL 80; such tanks shall be listed and labeled;
2. UL 142; such tanks shall be listed and labeled;
3. UL 2258; such tanks shall be installed only in one or two-family dwellings in accordance with Section 1305.15 and shall be listed and labeled;

[3-] 4. ASME Boiler and Pressure Vessel Code, Section VIII, Division 1 or 2; such tanks shall be labeled; or

[4-] 5. Alternate tank design and construction standards contained in Section 1305.14.

1305.13 Installation of tanks. Tanks shall be installed in accordance with the provisions of Sections 1305.13.1 through 1305.13.4. For the purposes of this section, fuel oil stored on roofs shall be deemed inside of buildings. At least 15 inches (381 mm) clearance shall be provided over tanks and on all sides between the tanks and the enclosure, embankment or dike or greater clearance as required by the manufacturer's instructions.

1305.13.1 Below ground. Tanks located below ground, inside or outside of buildings, shall comply with the following requirements:

1. **Containment.** Fuel-oil tanks having a capacity of more than 660 gallons ([~~2500~~] 2498.4L) shall be provided with secondary containment intended to prevent any leakage of fuel oil from the tank from entering the environment. The capacity of the containment shall equal or exceed the capacity of the tank served.
2. **Burial.** Regardless of capacity, fuel-oil tanks shall be buried with the top of the tank at least 2 feet ([~~610~~] 609.6 mm) below ground. Tanks shall be placed in firm soil and shall be surrounded by clean sand or well-tamped earth, free from ashes or other corrosive substance, and free from stones that will not pass a 1-inch ([~~25~~] 25.4 mm) mesh.
3. **Anchorage.** When necessary to prevent floating, fuel-oil tanks, regardless of capacity, shall be securely anchored.
4. **Distance to foundations.** Regardless of capacity, no fuel-oil tank shall be buried within 3 feet ([~~914~~] 914.4 mm) of any foundation wall or footing.

5. **Special limitations near subways.** Regardless of capacity, no fuel-oil tank shall be placed within 20 feet (6096 mm) of the outside line of a subway wall. For the purpose of the foregoing requirement, a subway shall be deemed to include any subsurface railroad or rapid transit roadbed.

1305.13.2 Above ground; on the lowest floor inside a building. Tanks located above ground, on the lowest floor inside of buildings, shall comply with the following requirements:

1. **Enclosure of room.** Installation of tank(s) and enclosure of room shall comply with Section 1305.11.1.2.
2. **Fire-extinguishing system.** Fire extinguishing systems shall comply with Section 1305.11.1.2.
3. **Ventilation.** Rooms containing fuel-oil tanks [~~which exceed 1375 gallons (5200 L)~~] shall be ventilated to limit the concentration of vapors within the room at or below 25 percent of the Lower Flammable Limit (LFL) of the fuel oil being used.
4. **Containment.** Fuel-oil tanks having a capacity of more than 660 gallons [~~(2500 L)~~] (2498.4 L) storage shall be provided with secondary containment intended to capture any leakage of fuel oil from the tank. The capacity of the containment shall equal or exceed the capacity of the tank served. For fuel storage, the capacity shall include the portion of the tank up to the height of the containment.
5. **Special limitations near subways.** Regardless of capacity, fuel-oil tanks located within the outer lines of the subway, or within 20 feet (6096 mm) of the outside line of a subway shall be placed within a welded steel oil-tight pan of not less than No. 18 Gage metal suitably reinforced and of capacity to contain the contents of the tank. For the purpose of the foregoing requirement, a subway shall be deemed to include any subsurface railroad or rapid transit roadbed.

1305.13.3 Above ground; above the lowest floor inside a building. Regardless of capacity, fuel-oil tanks and fuel-oil-burning [~~equipment~~] appliances located above ground, above the lowest floor inside of buildings, shall comply with the following requirements:

1. **Enclosure of room.** Fuel-oil tanks and fuel-oil-burning [~~equipment~~] appliances shall be located in a dedicated room or enclosure, having a fire-resistance rating of at least 2 hours. Rooftop tanks need not be enclosed provided that all exterior walls and [~~roof surfaces~~] roofs within 10 feet (3048 mm) horizontally and 20 feet (6096 mm) vertically have a fire-resistance rating of at least 2 hours or are otherwise separated by a constructed assembly with a fire-resistance rating of at least 2 hours.
2. **Fire-extinguishing system.** Rooms containing fuel-oil tanks and fuel-oil-burning [~~equipment~~] appliances shall be equipped with an automatic sprinkler system in accordance with Section 903.3.1 of the *New York City Building Code*. To prevent overfilling of the containment barriers, sprinkler shut-offs shall be located on the outside of tank and generator rooms and prominently placarded for immediate control by the Fire Department.

3. **Smoke detection.** Rooms containing fuel-oil tanks and fuel-oil-burning ~~[equipment]~~ appliances shall be equipped with automatic smoke detection in accordance with Section 907 of *the New York City Building Code*, except that heat detectors may be utilized where, during normal operation, products of combustion are present in sufficient quantity to actuate a smoke detector.
4. **Ventilation.** Rooms containing fuel-oil tanks shall be ventilated to limit the concentration of vapors within the room at or below 25 percent of the Lower Flammable Limit (LFL) of the fuel oil being used.
5. **Containment.** Fuel-oil tanks, fuel-oil-burning ~~[equipment]~~ appliances, and related equipment shall be provided with secondary containment area intended to capture any leakage of fuel oil. Floor drains shall be prohibited in containment areas. For tanks, the capacity of the containment area shall equal or exceed 2 times the capacity of the tank served. For fuel storage, the capacity shall include the portion of the tank up to the height of the containment. For fuel-oil-burning ~~[equipment]~~ appliances and related equipment, the capacity of the containment area shall equal or exceed 1.5 times the fuel capacity of the equipment or appliance.
6. **Transfer pumps.** Fuel-oil tanks shall be filled by means of a transfer pump supplied from a primary storage tank located on the lowest floor. A separate transfer pump and piping circuit shall be provided for each storage tank installed above the lowest floor. No intermediate pumping stations shall be provided between the storage tank and the transfer pump. Appropriate devices shall be provided for the automatic and manual starting and stopping of the transfer pumps so as to prevent the overflow of oil from these storage tanks. The transfer pumps shall be located above the tank secondary containment level or outside the tank containment area.
7. **Indicators and alarms.** Indicators and alarms shall be provided for fuel-oil tanks and rooms containing fuel-oil-burning ~~[equipment]~~ appliances, including a level sensor for height and capacity of fuel oil, high and low levels, and leak detection. The float switch shall be provided within the containment areas and shall be arranged so as to sound an alarm and stop the transfer pump in case of failure of the tank or the control in the tank. These indicators shall be connected to a local audible alarm in the tank room and to a remote alarm located at a supervising station. The wiring shall comply with the *New York City Electrical Code*.
8. **Weekly testing.** The operation of the float switch shall be tested at least once each week by the holder of the certificate of fitness as provided for in Sections 1301.10 and 1308.3.

1305.13.4 Above ground; outside a building. Tanks located above ground, outside of buildings, shall comply with the following requirements:

1. **Containment.** Regardless of capacity, each fuel-oil storage tank shall be protected by an embankment or dike. Such protection shall have a capacity at least 1½ times the capacity of the tank so surrounded (including the portion of the tank up to the height

of the containment) and shall be at least 4 feet (~~[1219]~~ 1219.2 mm) high, but in no case shall the protection be higher than one-quarter the height of the tank when the height of the tank exceeds 16 feet (~~[4877]~~ 4876.8 mm). Embankments or dikes shall be made of earthwork with clay core, of masonry, of reinforced concrete or of steel. ~~[Earth work]~~ Earthwork embankments shall be firmly and compactly built of good earth free from stones, vegetable matter, or other similar material, and shall have a flat section of at least 3 feet (~~[914]~~ 914.4 mm) at the top and a slope of at least 1½ feet (~~[457]~~ 457.2 mm) rise to 2 feet (~~[610]~~ 609.6 mm) of run on all sides. Concrete, masonry or steel dikes shall be designed so as to contain safely all of the oil in the tank so surrounded. Embankments or dikes shall be continuous and unpierced, and the outside toe shall be located at least 5 feet (1524 mm) inside of the property line, and no less than 5 feet (1524 mm) from a driveway or parking area.

2. **Distances to buildings, lot lines and other tanks.** Fuel oil storage tanks shall be located in accordance with the following:

2.1. Storage tanks of a capacity greater than 330 gallons (~~[1250]~~ 1249.2 L) shall be not less than 1¼ tank diameters and in no case less than 10 feet (3048 mm) from the tax lot line, the nearest building not served by such tanks or ~~[adjacent]~~ other fuel oil storage tank. However, in no case shall the clearance between individual tanks and the tax lot line be less than the distance fixed by the following formula:

$$\text{M.C.} = 10 + 4 ((G - 275) / 5000) \quad \text{[(Equation 13-1)]}$$

$$\text{M.C.} = 10 + 4 ((G - 330) / 5000) \quad \text{[Equation 13-1]}$$

where:

M.C. = Minimum clearance from nearest surface of tank to tax lot line, in feet.

G = Capacity of tank, in gallons.

2.2. Storage tanks with a capacity of not more than 330 gallons (1249.2 L) shall be not less than 5 feet (1524 mm) from the tax lot line, the nearest neighboring building or other fuel oil storage tank.

3. **Means of egress.** Tanks shall be located so as not to obstruct or interfere with any means of egress.

1305.14 Alternate tank design and construction standards. Oil-storage tanks, other than those conforming to ASME Boiler and Pressure Vessel Code, Section VIII, Division 1 or 2, UL 58, UL 80, UL 142, or UL 1316 shall be designed, constructed and installed in accordance with the requirements of Sections 1305.14.1 through 1305.14.5.

1305.14.1 General construction standards. All tanks shall comply with the requirements of Sections 1305.14.1.1 through 1305.14.1.9.

1305.14.1.1 Materials and workmanship. All fuel-oil storage tanks shall be built of steel plates or sheets, made by the open hearth or basic oxygen process. Such steel shall be free from physical imperfections, and shall be new, in good condition and free from rust.

1305.14.1.2 Assembly. Tanks, flanges or other pipe connections shall be welded. Filler of any kind between plates shall be prohibited.

1305.14.1.3 Corrosion resistance. Tanks to be buried shall be cleaned and then coated on the outside with two coats of corrosion protective material. They shall be further protected by a coating of hot tar, asphalt, or equivalent rust-resistive material, applied at the work site. Tanks installed inside buildings above ground shall be coated with one coat of corrosion protective material.

1305.14.1.4 External loads on underground tanks. All buried storage tanks shall be constructed of at least ¼-inch-thick (6.4 mm) metal and shall be designed to withstand any external loads to which the tank may be subjected.

1305.14.1.5 Identification. At the time of installation, all storage tanks shall bear a permanently fixed plate, spot welded or equivalent, bearing the name of the tank manufacturer, the gage of the material, and capacity of the tank. Shop-fabricated storage tanks shall be installed without structural alteration.

1305.14.1.6 Openings. All openings shall be through the top of the storage tank, except that storage tanks of ~~[275] 330~~ gallon (~~[1041] 1249.2~~ L) capacity or less, located above ground ~~[but below]~~ on the lowest story, may be provided with a ~~[¾-inch] ½-inch~~ (~~[19.1] 12.7~~ mm) opening for gravity discharge ~~[and a 1-inch (25 mm) opening]~~ in the bottom of the storage tank ~~[for cleaning and protection against corrosion].~~

1305.14.1.7 Manholes. Tanks for No. 1, No. 2, No. 3 and No. 4 commercial-grade oils need not have manholes. However, if manholes are used for tanks containing such oils, the manhole covers shall be bolted and made gas tight. Tanks for No. 5 and No. 6 commercial-grade oils shall have manhole covers bolted or otherwise secured to the tanks and kept hydrostatically tight at all times. Tanks ~~[275] 330~~ gallon (~~[1041] 1249.2~~ L) capacity or less, and all other tanks without manholes, shall be provided with a ~~[2] two~~ screwed connection on the top of the tank to permit measuring the level of the oil within.

1305.14.1.8 Electrical grounding. Tanks outside of buildings shall be electrically grounded in accordance with the requirements for equipment grounding of the *New York City Electrical Code*.

1305.14.1.9 Protection from heat and flame. Tanks shall be located at least 7 feet (~~[2134] 2133.6~~ mm), measured in the most direct manner, from any source of exposed flame unless protected as provided in Section 1305.11.1.2, Exception 3, and at least 2 feet (~~[610] 609.6~~ mm) from any surface where the temperature exceeds 165°F (~~[74] 73.9~~°C).

1305.14.2 Additional construction standards for cylindrical tanks exceeding ~~[275] 330~~ gallons (~~[1041] 1249.2~~ L). Cylindrical tanks, including oval, elongated oval, or round tanks, exceeding ~~[275] 330~~ gallons (~~[1041] 1249.2~~ L) shall comply with the requirements of Sections 1305.14.2.1 through 1305.14.2.3.

Exception: Such above-ground vertical tanks that are outside of buildings shall comply with Sections 1305.14.1 and 1305.14.5.

1305.14.2.1 Thickness. The minimum thickness shall be as follows:

1. Tanks 36 inches (~~[914]~~ 914.4 mm) in diameter or less shall have at least a ¼-inch (6.4 mm) shell and ¼-inch (6.4 mm) heads.
2. Tanks 37 inches (940 mm) to 72 inches (~~[1829]~~ 1828.8 mm) in diameter shall have at least a ¼-inch (6.4 mm) shell and ⁵/₁₆-inch (7.9 mm) heads.
3. Tanks 73 inches (1854 mm) to 120 inches (3048 mm) in diameter shall have at least a ⁵/₁₆-inch (7.9 mm) shell and ³/₈-inch (9.5 mm) heads.
4. Tanks over 120 inches (3048 mm) in diameter shall be of at least ³/₈-inch (9.5 mm) steel and shall be stiffened by angle rings or equivalent members so as to retain their cylindrical form.

1305.14.2.2 Dished heads. Dished heads for such tanks shall have a curvature the radius of which is not greater than the diameter of the tank. Dished heads shall be formed with an adequate cylindrical extension rim to provide a welding surface.

1305.14.2.3 Flat heads. If flat heads are used, they shall be braced in the same manner as described for the bracing of flat sides of rectangular tanks as provided for in Section 1305.14.3.

1305.14.3 Additional construction standards for rectangular tanks exceeding ~~[275]~~ 330 gallon (~~[1041]~~ 1249.2 L). Rectangular tanks exceeding ~~[275]~~ 330-gallon (~~[1241]~~ 1249.2 L) capacity shall comply with the requirements of Sections 1305.14.3.1 through 1305.14.3.6.

1305.14.3.1 Thickness. Plates for rectangular tanks of more than ~~[275]~~ 330 gallon (~~[1040]~~ 1249.2 L) capacity shall be at least ⁵/₁₆ inch (7.9 mm) thick.

1305.14.3.2 Corners. Corners may be made up by bending the plates or by using angles.

1305.14.3.3 Seams. All tanks shall have full penetration ⁵/₁₆ welds at all seams.

1305.14.3.4 Bracing. All flat surfaces of rectangular tanks shall be braced by structural members or rods.

1305.14.3.5 Structural work. All structural members shall be designed in accordance with the requirements of the *New York City Building Code*.

1305.14.3.6 Connections. Connections between bracing members and the sides of the tank shall be designed so that the connection will not fail before the member will fail.

1305.14.4 Additional construction standards for tanks [275] 330 gallons ([1041] 1249.2 L) or less. Storage tanks with a capacity of less than or equal to [275] 330 gallons ([1041] 1249.2 L) shall have a minimum thickness of shell and head plates of No. 10 manufacturer's standard Gage steel plate. Storage tanks of 60 gallon ([227] 227.1 L) capacity or less shall be similarly constructed but need not be thicker than No.14 manufacturer's standard Gage.

Exceptions:

1. Such vertical above-ground cylindrical tanks outside of buildings shall comply with Sections 1305.14.1 and 1305.14.5.
2. Such underground tanks need comply only with Section 1305.14.1.
3. Storage containers of 6 gallons ([23] 22.7 L) or less used with burners or oil-burning heaters need only be designed so as to withstand a hydrostatic pressure test of at least 5 psi ([34] 34.5 kPa) without permanent deformation, rupture, or leakage, and shall be approved. Such containers shall be installed with rigid metal fasteners for wall, floor, or stand-type installations, and shall be protected against mechanical damage. Portable storage containers of 6 gallons ([23] 22.7 L) or less may be filled by a pump mounted on a storage tank, provided that the pump is approved.

1305.14.5 Additional construction standards for vertical above-ground cylindrical tanks outside of buildings exceeding 6 gallons ([23] 22.7 L). Vertical above-ground cylindrical storage tanks exceeding 6 gallons ([23] 22.7 L) that are located outside of buildings shall comply with the requirements of Sections 1305.14.5.1 through 1305.14.5.3.

1305.14.5.1 Plates. Such tanks shall be built of steel plates of the quality required for cylindrical tanks in accordance with Section 1305.14.2.

1305.14.5.2 Thickness. The minimum thickness of shell or bottom plates shall be ¼ inch (6.4 mm), and the minimum thickness of roof plates ⅛ inch (3.2 mm). The thickness of shell plates shall be determined in accordance with the following formula:

$$t = \frac{P \times R \times F}{T \times E} \quad \text{(Equation 13-2)}$$

where:

t = Thickness of shell plate in inches.

P = Head pressure at bottom of ring under consideration in psi.

R = Radius of shell, in inches.

F = Factor of safety (taken as 5).

T = Tensile strength of plate, in psi, as verified by mill test certificate.

E = Efficiency of vertical joint in ring under consideration. E shall in no case be taken greater than 1.00.

1305.14.5.3 Seams. Roof plates shall have welded water-tight seams, and the roof shall be built to shed water. Bottom plates shall have welded seams. Shell plate seams shall be designed to develop the full strength of the plate.

1305.15 Above-ground nonmetallic fuel-oil storage tanks for one- and two-family dwellings.

Above-ground nonmetallic fuel-oil storage tanks may be used for indoor and outdoor storage and supply of fuel-oil in accordance with this section.

1305.15.1 Use. Nonmetallic tanks shall be permitted for one- and two-family dwellings only. Use of nonmetallic tanks in multi-family dwellings is prohibited. Nonmetallic fuel-oil tanks shall not be used for storage of waste-oil and flammable liquids.

1305.15.2 Capacity. The capacity of nonmetallic fuel-oil storage tanks shall be not less than 60 gallons (227.1 L) and not more than 660 gallons (2498.4 L).

1305.15.3 Construction Standards. Nonmetallic tanks shall be constructed per Sections 7, 8, 9, 10, 11 and 12 of UL 2258 and Chapter 7 of NFPA 31 and shall consist of a non-metallic primary tank and a metallic secondary tank.

1305.15.4 Identification. Above-ground nonmetallic fuel-oil storage tanks shall be marked in accordance with Sections 40, 41 and 42 of UL 2258. The label shall also include the biodiesel percentage as identified in the scope of UL 2258.

1305.15.5 Location. Above-ground nonmetallic fuel-oil storage tanks installed indoors shall not be exposed to sunlight on any plastic parts. Above-ground nonmetallic fuel-oil storage tanks installed outdoors shall be assembled with a required cover per the manufacturer's recommendations. Outdoor installations shall comply with Section 1305.13.4.

1305.15.6 Installation. Nonmetallic fuel-oil tanks shall be installed in accordance with the manufacturer's instructions, this code and NFPA 31. Installation of above-ground nonmetallic fuel-oil storage tanks shall be performed by an oil-burning equipment installer licensed by the department with training and experience certified by the manufacturer.

1305.15.7 Testing. Nonmetallic fuel-oil tanks shall be tested in accordance with UL 2258.

1305.16 Method of ventilation of fuel oil storage tank rooms. Where required by this code, fuel oil storage tank rooms shall be ventilated to limit the concentration of vapors within the room at or below 25 percent of the Lower Flammable Limit (LFL) of the fuel oil being used via an independent exhaust system to the outdoors complying with the following:

1. The exhaust system shall operate continuously at a rate of two air changes per hour.

Exception: Continuous operation shall not be required where listed detection devices are interlocked to operate such exhaust system to maintain concentration of vapors below 25 percent of LFL.

2. Multiple tank rooms may be served by a shared exhaust system.

3. Make-up air shall be provided via a ducted building ventilation system.
4. All dampers, including smoke dampers, shall be interlocked with the exhaust air system.

1305.16.1 Replacement of tanks in prior code buildings. Replacement of tanks in prior code buildings may utilize an existing gravity ventilation system complying with the following:

1. The total net free area of supply and exhaust openings shall be equal to at least 1 percent of the floor area of the room, equally divided between the supply and exhaust; and
2. Independent supply and exhaust openings to the outside; or
3. Independent supply and exhaust ducts to the outside.

SECTION MC 1306 OIL GAUGING

1306.1 Level indication. All tanks located inside buildings shall be equipped with a method of determining the oil level.

1306.2 Test wells. Test wells shall not be installed inside buildings. Unused tank openings shall be permanently sealed. For outside service, test wells shall be equipped with a tight metal cover designed to discourage tampering.

1306.3 Inside tanks. The gauging of inside tanks by means of measuring sticks shall not be permitted. An inside tank provided with fill and vent pipes shall be provided with a device to indicate either visually or audibly at the fill point when the oil in the tank has reached a predetermined safe level.

1306.4 Gauging devices. Gauging devices such as liquid level indicators or signals shall be designed and installed so that oil vapor will not be discharged into a building from the liquid fuel supply system.

1306.5 Gauge glass. A tank used in connection with any oil burner shall not be equipped with a glass gauge or any gauge which, when broken, will permit the escape of oil from the tank.

1306.6 Storage above lowest floors. Fuel oil stored above the lowest floor shall also comply with the indicator requirements of Section 1305.13.3, Item 7.

SECTION MC 1307 FUEL-OIL VALVES

1307.1 Building shutoff. For outside or below ground tanks, a shutoff valve shall be installed on the fuel-oil supply line at the entrance to the building. Inside or above-ground tanks shall have valves installed at the tank. The valve shall be capable of stopping the flow of fuel oil to the building or to the appliance served where the valve is installed at a tank inside the building. Valves shall comply with UL 842.

1307.2 Appliance shutoff. A shutoff valve shall be installed at the supply connection to each appliance and a check valve installed at the return connection.

1307.3 Pump relief valve. A relief valve shall be installed on the pump discharge line where a valve is located downstream of the pump.

1307.4 Fuel-oil heater relief valve. A relief valve shall be installed on the discharge line of fuel-oil-heating appliances.

1307.5 Relief valve operation. Relief valves shall be set to discharge at not more than 1½ times the maximum working pressure of the system. The discharge from relief valves shall be returned to the storage tank or to the supply line. Shutoff valves are not permitted in the line of relief.

SECTION MC 1308 TESTING

1308.1 Testing required. Fuel-oil storage tanks, other than tanks complying with the alternate tank design and construction standards contained in Section 1305.14, shall be tested in accordance with NFPA 31.

1308.2 Hydrostatic test. All liquid-fuel piping, and all tanks complying with the alternate tank design and construction standards contained in Section 1305.14, shall be hydrostatically tested for tightness by the contractor who made the installation before the work is closed in and before the system is operated. The piping shall be tested at 1½ times the maximum working pressure applicable to that part of the piping system but at a pressure not less than the test pressure required for the storage tank. The minimum pressure for testing tanks shall be 1½ times the maximum working pressure applicable to the tank but in no case less than 25 psig (~~[172]~~ 172.4 kPag), except as provided for containers 6 gallons (~~[23]~~ 22.7 L) or less in capacity as provided for in Section 1305.14.4, Exception 3. The hydrostatic pressure shall be maintained until all joints and connections have been visually inspected for leaks, but in no case for less than ½ hour. The tank shall not show any permanent deformation as a result of the test. A record shall be kept of the pressure tests showing the name of the contractor and the pressures at which the piping and the tank were tested.

1308.3. Weekly testing. For fuel-oil tanks and fuel-oil-burning equipment located above ground, above the lowest floor inside of buildings, the operation of the float switch shall be tested at least once each week by the holder of the certificate of fitness as provided for in Sections 1301.9 and 1305.13.3, Item 8.

§ 15. Chapter 14 of the New York city mechanical code, as added by local law number 33 for the year 2007, section 1402.1 as amended by local law number 141 for the year 2013, is amended to read as follows:

CHAPTER 14 SOLAR SYSTEMS

SECTION MC 1401 GENERAL

1401.1 Scope. This chapter shall govern the design, construction, installation, alteration and repair of systems, equipment and appliances intended to utilize solar energy for space heating or cooling, domestic hot water heating, swimming pool heating or process heating.

1401.2 Potable water supply. Potable water supplies to solar systems shall be protected against contamination in accordance with the New York City Plumbing Code.

Exception: Where all solar system piping is a part of the potable water distribution system, in accordance with the requirements of the New York City Plumbing Code, and all components of the piping system are listed for potable water use, [~~cross-connection~~] cross-connection protection measures shall not be required.

1401.3 Heat exchangers. Heat exchangers used in domestic water-heating systems shall be approved for the intended use. The system shall have adequate protection to ensure that the potability of the water supply and distribution system is properly safeguarded.

1401.4 Solar energy equipment and appliances. Solar energy equipment and appliances shall conform to the requirements of this chapter and shall be installed in accordance with the manufacturer's [~~installation~~] instructions.

1401.5 Ducts. Ducts utilized in solar heating and cooling systems shall be constructed and installed in accordance with Chapter 6 of this code.

SECTION MC 1402 INSTALLATION

1402.1 Access. Access shall be provided to solar energy equipment and appliances for maintenance. Solar systems and appurtenances shall be installed in accordance with the requirements of Chapter 5 of the *New York City Fire Code* regarding rooftop access and obstructions, and shall not obstruct or interfere with fire-fighting operations or the operation of any doors, windows, fire escapes, or other means of egress or other building components requiring operation or access.

1402.2 Protection of equipment. Solar equipment exposed to vehicular traffic shall be installed not less than 6 feet (~~[1829]~~ 1828.8 mm) above the finished floor.

Exception: This section shall not apply where the equipment is protected from motor vehicle impact.

1402.3 Controlling condensation. Where attics or structural spaces are part of a passive solar system, ventilation of such spaces, as required by Section 406, is not required where other approved means of controlling condensation are provided.

1402.4 Roof-mounted collectors. Roof-mounted solar collectors that also serve as a roof covering shall conform to the requirements for roof coverings in accordance with the *New York City Building Code*.

Exception: The use of plastic solar collector covers shall be limited to those approved plastics meeting the requirements for plastic roof panels in the *New York City Building Code*.

1402.4.1 Collectors mounted above the roof. [~~When~~] Where mounted on or above the roof covering, the collector array and supporting construction shall be constructed of noncombustible materials or fire-retardant-treated wood conforming to the *New York City Building Code* to the extent required for the type of roof construction of the building to which the collectors are accessory.

Exception: The use of plastic solar collector covers shall be limited to those approved plastics meeting the requirements for plastic roof panels in the *New York City Building Code*.

1402.5 Equipment. The solar energy system shall be equipped in accordance with the requirements of Sections 1402.5.1 through 1402.5.4.

1402.5.1 Pressure and temperature. Solar energy system components containing pressurized fluids shall be protected against pressures and temperatures exceeding design limitations with a pressure and temperature relief valve. Each section of the system in which excessive pressures are capable of developing shall have a relief device located so that a section cannot be valved off or otherwise isolated from a relief device. Relief valves shall comply with the requirements of Section 1006.4 and discharge in accordance with Section 1006.6.

1402.5.2 Vacuum. The solar energy system components that are subjected to a vacuum while in operation or during shutdown shall be designed to withstand such vacuum or shall be protected with vacuum relief valves.

1402.5.3 Protection from freezing. System components shall be protected from damage by freezing of heat transfer liquids at the lowest ambient temperatures that will be encountered during the operation of the system.

1402.5.4 Expansion tanks. Liquid single-phase solar energy systems shall be equipped with expansion tanks sized in accordance with Section 1009.

1402.6 Penetrations. Roof and wall penetrations shall be flashed and sealed to prevent entry of water, rodents and insects.

1402.7 Filtering. Air transported to occupied spaces through rock or dust-producing materials by means other than natural convection shall be filtered at the outlet from the heat storage system.

SECTION MC 1403 HEAT TRANSFER FLUIDS

1403.1 Flash point. The flash point of the actual heat transfer fluid utilized in a solar system shall be not less than 50°F (~~28~~ 10°C) above the design maximum nonoperating (no-flow) temperature of the fluid attained in the collector.

1403.2 Flammable gases and liquids. A flammable liquid or gas shall not be utilized as a heat transfer fluid.

SECTION MC 1404 MATERIALS

1404.1 Collectors. Factory-built collectors shall be listed and labeled, and bear a label showing the manufacturer's name and address, model number, collector dry weight, collector maximum allowable operating and nonoperating temperatures and pressures, minimum allowable temperatures and the types of heat transfer fluids that are compatible with the collector. The label shall clarify that these specifications apply only to the collector.

1404.1.1 Types of collectors. The following types of collectors may be installed:

1. Flat-plate collectors.
2. Evacuated-tube collectors.
3. Integral collector storage systems.
4. Alternative collectors as approved by the commissioner in accordance with Section 28-113.2 of the *Administrative Code*.

1404.2 Thermal storage units. Pressurized thermal storage units shall be listed and labeled, and bear a label showing the manufacturer's name and address, model number, serial number, storage unit maximum and minimum allowable operating temperatures, storage unit maximum and minimum allowable operating pressures and the types of heat transfer fluids compatible with the storage unit. The label shall clarify that these specifications apply only to the thermal storage unit.

§16. Chapter 15 of the New York city mechanical code is REPEALED and a new Chapter 15 is added to read as follows:

CHAPTER 15 **REFERENCED STANDARDS**

SECTION MC 1501 **GENERAL**

1501.1 General. This chapter lists the standards that are referenced in various sections of this document. The standards are listed herein by the promulgating agency of the standard, the standard

identification, the effective date and title and the section or sections of this document that reference the standard.

1501.2 Subsequent additions, modifications or deletions. Refer to the rules of the department for any subsequent additions, modifications or deletions that may have been made to these standards in accordance with Section 28-103.19 of the *Administrative Code*.

1501.3 Applicability. The application of the referenced standards shall be as specified in Section 102.8.

SECTION MC 1502
STANDARDS

<u>ACCA</u>	<u>Air Conditioning Contractors of America</u> <u>2800 Shirlington Road, Suite 300</u> <u>Arlington, VA 22206</u>	
<u>Standard reference number</u>	<u>Title</u>	<u>Referenced in code section number</u>
<u>Manual D—2011</u>	<u>Residential Duct Systems</u>	<u>603.2</u>
<u>183—2007 (reaffirmed 2011)</u>	<u>Peak Cooling and Heating Load Calculations in Buildings Except Low-rise Residential Buildings</u>	<u>312.1</u>

<u>AHRI</u>	<u>Air-Conditioning, Heating and Refrigeration Institute</u> <u>4100 North Fairfax Drive, Suite 200</u> <u>Arlington, VA 22203</u>	
<u>Standard reference number</u>	<u>Title</u>	<u>Referenced in code section number</u>
<u>700—2011 With Addendum 1</u>	<u>Purity Specifications for Fluorocarbon and Other Refrigerants</u>	<u>1102.2.2.3</u>

<u>AMCA</u>	<u>Air Movement and Control Association International</u> <u>30 West University Drive</u> <u>Arlington Heights, IL 60004</u>	
<u>Standard reference number</u>	<u>Title</u>	<u>Referenced in code section number</u>
<u>550—18</u>	<u>Test Method for High Velocity Wind Driven Rain Resistant Louvers</u>	<u>401.6.1, 501.3.2, 501.3.2.1</u>

<u>ANSI</u>	<u>American National Standards Institute</u> <u>11 West 42nd Street</u> <u>New York, NY 10036</u>	
<u>Standard reference number</u>	<u>Title</u>	<u>Referenced in code section number</u>
<u>ANSI/ASA S2.71—1983 (R2012)</u>	<u>Guide to the Evaluation of Human Exposure to Vibration in Buildings</u>	<u>313.3</u>
<u>ANSI/ASHRAE/ASHE 170—2008</u>	<u>Ventilation of Health Care Facilities</u>	<u>401.4</u>
<u>Z21.8—1994 (R2002)</u>	<u>Installation of Domestic Gas Conversion Burners</u>	<u>919.1, 1004.9</u>
<u>Z21.50—2012</u>	<u>Vented Gas Fireplaces</u>	<u>901.6</u>
<u>Z21.60—2012</u>	<u>Decorative Gas Appliances for Installation in Solid-Fuel-Burning Fireplaces.</u>	<u>901.6</u>

<u>ASHRAE</u>	<u>ASHRAE</u> <u>1791 Tullie Circle, NE</u> <u>Atlanta, GA 30329</u>	
<u>Standard reference number</u>	<u>Title</u>	<u>Referenced in code section number</u>
<u>ASHRAE—2005</u>	<u>ASHRAE Fundamentals Handbook—2005</u>	<u>603.2</u>
<u>15—2013</u>	<u>Safety Standard for Refrigeration Systems</u>	<u>1101.6, 1101.11, 1104.2, 1105.3, 1105.7, 1105.8, 1105.11, 1108.1</u>
<u>34—2013</u>	<u>Designation and Safety Classification of Refrigerants</u>	<u>202 (FLAMMABILITY CLASSIFICATION; REFRIGERANT SAFETY CLASSIFICATIONS; TOXICITY CLASSIFICATION), 1102.2.1, 1103.1, Table 1103.1, 1104.1</u>
<u>52.2—2012</u>	<u>Method of Testing General Ventilation Air-Cleaning Devices for Removal Efficiency by Particle Size</u>	<u>605.2.1</u>

<u>ASHRAE</u>	<u>ASHRAE</u> <u>1791 Tullie Circle, NE</u> <u>Atlanta, GA 30329</u>	
<u>Standard reference number</u>	<u>Title</u>	<u>Referenced in code section number</u>
<u>62.1—2016</u>	<u>Ventilation for Acceptable Indoor Air Quality</u>	<u>403.2, 403.3.1.1</u> <u>403.3.1.1.2.3.2,</u> <u>501.3.1, 514.4,</u> <u>601.4, 605.2.1</u>
<u>62.2—2016</u>	<u>Ventilation and Acceptable Indoor Air Quality in Low-Rise Residential Buildings</u>	<u>605.2.1</u>
<u>ANSI/ASHRAE/ ASH170—2008</u>	<u>Ventilation of Health Care Facilities</u>	<u>401.4</u>

<u>ASME</u>	<u>American Society of Mechanical Engineers</u> <u>Three Park Avenue</u> <u>New York, NY 10016-5990</u>	
<u>Standard reference number</u>	<u>Title</u>	<u>Referenced in code section number</u>
<u>B1.20.1—1983 (R2006)</u>	<u>Pipe Threads, General Purpose (Inch)</u>	<u>1203.3.5,</u> <u>1303.3.3</u>
<u>B16.3—2011</u>	<u>Malleable Iron Threaded Fittings, Classes 150 & 300</u>	<u>Table 1202.5</u>
<u>B16.5—2009</u>	<u>Pipe Flanges and Flanged Fittings NPS 1/2 through NPS 24</u>	<u>Table 1202.5,</u> <u>Table 1302.5</u>
<u>B16.9—2007</u>	<u>Factory Made Wrought Steel Buttwelding Fittings</u>	<u>Table 1202.5,</u> <u>Table 1302.5</u>
<u>B16.11—2011</u>	<u>Forged Fittings, Socket-welding and Threaded</u>	<u>Table 1202.5,</u> <u>Table 1302.5</u>
<u>B16.15—2011</u>	<u>Cast Bronze Threaded Fittings</u>	<u>Table 1202.5,</u> <u>Table 1302.5</u>
<u>B16.18—2012</u>	<u>Cast Copper Alloy Solder Joint Pressure Fittings</u>	<u>Table 1202.5,</u> <u>Table 1302.5</u>
<u>B16.22—(R2010)</u>	<u>Wrought Copper and Copper Alloy Solder Joint Pressure Fittings</u>	<u>Table 1202.5,</u> <u>Table 1302.5</u>
<u>B16.24—2011</u>	<u>Cast Copper Alloy Pipe Flanges and Flanged Fittings: Class 150, 300, 400, 600, 900, 1500 and 2500</u>	<u>Table 1202.5,</u> <u>Table 1302.5</u>
<u>B16.26—2011</u>	<u>Cast Copper Alloy Fittings for Flared Copper Tubes</u>	<u>Table 1202.5</u>
<u>B16.28—1994</u>	<u>Wrought Steel Buttwelding Short Radius Elbows and Returns</u>	<u>Table 1202.5,</u> <u>Table 1302.5</u>
<u>B16.39—2014</u>	<u>Malleable Iron Threaded Pipe Unions</u>	<u>1203.1.2</u>
<u>B31.1—2012</u>	<u>Power Piping Code</u>	<u>1201.3,</u> <u>1211.2.1,</u>

<u>ASME</u>	<u>American Society of Mechanical Engineers</u> <u>Three Park Avenue</u> <u>New York, NY 10016-5990</u>	
<u>Standard reference number</u>	<u>Title</u>	<u>Referenced in code section number</u>
		<u>1211.2.2,</u> <u>1211.2.3</u>
<u>B16.51—2011</u>	<u>Copper and Copper Alloy Press-Connect Pressure Fittings</u>	<u>Table 1202.5</u>
<u>B31.5—2010</u>	<u>Refrigeration Piping and Heat Transfer Components</u>	<u>1107.1</u>
<u>B31.9—2011</u>	<u>Building Services Piping</u>	<u>1201.3</u>
<u>B40.100-2013</u>	<u>Pressure Gauges and Gauge Attachments</u>	<u>1011.2</u>
<u>BPVC—2010/2011 addenda</u>	<u>ASME Boiler & Pressure Vessel Code</u>	<u>1002.2, 1003.1,</u> <u>1003.2, 1003.3,</u> <u>1004.1, 1004.1.1,</u> <u>1006.1, 1006.2,</u> <u>1006.3, 1006.4,</u> <u>1009.2, 1010.2.1,</u> <u>1011.1, 1107.5.4,</u> <u>1203.3.1,</u> <u>1203.3.6,</u> <u>1211.2.2,</u> <u>1303.1,</u> <u>1303.3.1,</u> <u>1303.3.4,</u> <u>1305.12.2,</u> <u>1305.14, Figure C101.1(1),</u> <u>Figure C101.1(3)</u>
<u>CSD-1—2011</u>	<u>Controls and Safety Devices for Automatically Fired Boilers</u>	<u>1004.1, 1004.1.1,</u> <u>1004.8, 1006.1,</u> <u>1006.2, 1006.3,</u> <u>1006.4, 1007.1,</u> <u>1007.2, 1007.3,</u> <u>1010.2.1, 1011.1</u>

<u>ASNT</u>	<u>American Society for Nondestructive Testing</u> <u>PO Box 28518</u> <u>1/11 Arlington Lane</u> <u>Columbus, OH 43228</u>	
<u>Standard reference number</u>	<u>Title</u>	<u>Referenced in code section number</u>
<u>SNT—TC—1A—2016</u>	<u>Recommended Practice</u>	<u>1211.2.2</u>

<u>ASSE</u>	<u>American Society of Sanitary Engineers</u> <u>901 Canterbury, Suite A</u> <u>Westlake, OH 44145</u>	
<u>Standard reference number</u>	<u>Title</u>	<u>Referenced in code section number</u>
<u>1017—2010</u>	<u>Performance Requirements for Temperature Actuated Mixing Values for Hot Water Distribution Systems</u>	<u>1002.2.2</u>

<u>ASTM</u>	<u>ASTM International</u> <u>100 Barr Harbor Drive</u> <u>West Conshohocken, PA 19428</u>	
<u>Standard reference number</u>	<u>Title</u>	<u>Referenced in code section number</u>
<u>A 53/A 53M—12</u>	<u>Specification for Pipe, Steel, Black and Hot-dipped, Zinc-coated Welded and Seamless</u>	<u>Table 1202.4,</u> <u>Table 1202.5,</u> <u>Table 1302.3,</u> <u>Table 1302.5,</u> <u>1305.9.5</u>
<u>A 106/A106M—11</u>	<u>Specification for Seamless Carbon Steel Pipe for High-Temperature Service</u>	<u>Table 1202.4,</u> <u>Table 1202.5,</u> <u>Table 1302.3,</u> <u>Table 1302.5,</u> <u>1305.9.5</u>
<u>A 126—09</u>	<u>Specification for Gray Iron Castings for Valves, Flanges and Pipe Fittings</u>	<u>Table 1202.5</u>
<u>A 234/A234M—11a</u>	<u>Standard Specification for Piping Fittings of Wrought Carbon Steel And Alloy Steel For Moderate and High Temperature Service</u>	<u>Table 1202.5,</u> <u>Table 1302.5</u>
<u>A 254—97 (2007)</u>	<u>Specification for Copper Brazed Steel Tubing</u>	<u>Table 1202.4,</u> <u>Table 1302.3</u>
<u>A 395/A395M-99(2009)</u>	<u>Standard Specification for Ferritic Ductile Iron Pressure-Retaining Castings for Use at Elevated Temperatures</u>	<u>Table 1202.5</u>
<u>A 420/A 420M—10A</u>	<u>Specification for Piping Fittings of Wrought Carbon Steel and Alloy Steel for Low-Temperature Service</u>	<u>Table 1202.5,</u> <u>Table 1302.5</u>
<u>A 536-84(2009)</u>	<u>Standard Specification for Ductile Iron Castings</u>	<u>Table 1202.5</u>
<u>B 32—08</u>	<u>Specification for Solder Metal</u>	<u>1203.3.3,</u> <u>1107.5.5</u>
<u>B 42—10</u>	<u>Specification for Seamless Copper Pipe, Standard Sizes</u>	<u>1107.5.2,</u> <u>Table 1202.4,</u> <u>Table 1302.3</u>

<u>ASTM</u>	ASTM International 100 Barr Harbor Drive West Conshohocken, PA 19428	
<u>Standard reference number</u>	<u>Title</u>	<u>Referenced in code section number</u>
<u>B 43—09</u>	<u>Specification for Seamless Red Brass Pipe, Standard Sizes</u>	<u>1107.5.2,</u> <u>Table 1202.4,</u> <u>Table 1302.3</u>
<u>B75—11</u>	<u>Specification for Seamless Copper Tube</u>	<u>Table 1202.4,</u> <u>Table 1302.3</u>
<u>B 88—09</u>	<u>Specification for Seamless Copper Water Tube</u>	<u>1107.5.3,</u> <u>Table 1202.4,</u> <u>Table 1302.3</u>
<u>B 135—10</u>	<u>Specification for Seamless Brass Tube</u>	<u>Table 1202.4</u>
<u>B 251—10</u>	<u>Specification for General Requirements for Wrought Seamless Copper and Copper-alloy Tube</u>	<u>Table 1202.4</u>
<u>B 280—08</u>	<u>Specification for Seamless Copper Tube for Air Conditioning and Refrigeration Field Service</u>	<u>1107.5.3,</u> <u>Table 1302.3</u>
<u>B 302—12</u>	<u>Specification for Threadless Copper Pipe, Standard Sizes</u>	<u>Table 1202.4,</u> <u>Table 1302.3</u>
<u>B 813—10</u>	<u>Specification for Liquid and Paste Fluxes for Soldering of Copper and Copper Alloy Tube</u>	<u>1203.3.3,</u> <u>1107.5.5</u>
<u>C 315—07(2011)</u>	<u>Specification for Clay Flue Liners and Chimney Pots</u>	<u>801.16.1,</u> <u>Table 803.10.4</u>
<u>C 411—11</u>	<u>Test Method for Hot-surface Performance of High-temperature Thermal Insulation</u>	<u>604.3</u>
<u>D 56—05(2010)</u>	<u>Test Method for Flash Point by Tag Closed Tester</u>	<u>202</u> <u>(FLASHPOINT)</u>
<u>D 93—12</u>	<u>Test Method for Flash Point of Pensky-Martens Closed Cup Tester</u>	<u>202</u> <u>(FLASHPOINT)</u>
<u>D 1527—99(2005)</u>	<u>Specification for Acrylonitrile-Butadiene-Styrene (ABS) Plastic Pipe, Schedules 40 and 80</u>	<u>Table 1202.4</u>
<u>D 1785—12</u>	<u>Specification for Poly (Vinyl Chloride)(PVC) Plastic Pipe, Schedules 40, 80 and 120</u>	<u>Table 1202.4,</u> <u>Table 1210.4</u>
<u>D 2235—04(2011)</u>	<u>Specifications for Solvent Cement for Acrylonitrile-Butadiene-Styrene (ABS) Plastic Pipe and Fittings</u>	<u>1203.3.4</u>
<u>D 2241—09</u>	<u>Specification for Poly (Vinyl Chloride)(PVC) Pressure-rated Pipe (SDR-Series)</u>	<u>Table 1202.4,</u> <u>Table 1210.4</u>
<u>D 2412—11</u>	<u>Test Method for Determination of External Loading Characteristics of Plastic Pipe by Parallel-plate Loading</u>	<u>603.8.3</u>
<u>D 2466—06</u>	<u>Specification for Poly (Vinyl Chloride)(PVC) Plastic Pipe Fittings, Schedule 40</u>	<u>Table 1202.5,</u> <u>Table 1210.5</u>
<u>D 2467—06</u>	<u>Specification for Poly (Vinyl Chloride)(PVC) Plastic Pipe Fittings, Schedule 80</u>	<u>Table 1202.5,</u> <u>Table 1210.5</u>
<u>D 2564—12</u>	<u>Specification for Solvent Cements for Poly (Vinyl</u>	<u>1203.3.4</u>

<u>ASTM</u>	<u>ASTM International</u> <u>100 Barr Harbor Drive</u> <u>West Conshohocken, PA 19428</u>	
<u>Standard reference number</u>	<u>Title</u>	<u>Referenced in code section number</u>
	<u>Chloride) (PVC) Plastic Piping Systems</u>	
<u>D 2657—07</u>	<u>Standard Practice for Heat Fusion Joining of Polyolefin Pipe and Fittings</u>	<u>1210.6.6.1</u>
<u>D 2683—2010E1</u>	<u>Specification for Socket-type Polyethylene Fittings for Outside Diameter-controlled Polyethylene Pipe and Tubing</u>	<u>Table 1210.5,</u> <u>1210.6.6.1</u>
<u>D2737—12A</u>	<u>Standard Specification for Polyethylene (PE) Plastic Tubing</u>	<u>Table 1210.4</u>
<u>D 2846/D 2846M—09BE1</u>	<u>Specification for Chlorinated Poly (Vinyl Chloride) (CPVC) Plastic Hot and Cold Water Distribution Systems</u>	<u>Table 1202.4,</u> <u>Table 1210.4,</u> <u>Table 1210.5</u>
<u>D 2996—01 (2007)e01</u>	<u>Specification for Filament-wound Fiberglass (Glass Fiber Reinforced Thermosetting Resin) Pipe</u>	<u>Table 1302.3</u>
<u>D 3035—2012E1</u>	<u>Specification for Polyethylene (PE) Plastic Pipe (DR-PR) Based on Controlled Outside Diameter</u>	<u>Table 1210.4</u>
<u>D 3261—12</u>	<u>Specification for Butt Heat Fusion Polyethylene (PE) Plastic Fittings for Polyethylene (PE) Plastic Pipe and Tubing</u>	<u>Table 1210.5,</u> <u>1210.6.6.1</u>
<u>D 3278—1996(2011)</u>	<u>Test Methods for Flash Point of Liquids by Small Scale Closed-cup Apparatus</u>	<u>202</u> <u>(FLASHPOINT)</u>
<u>E 84—2013A</u>	<u>Test Method for Surface Burning Characteristics of Building Materials</u>	<u>202</u> <u>(FLAME SPREAD INDEX, SMOKE-DEVELOPE D INDEX),</u> <u>510.9, 602.2,</u> <u>602.2.1, 602.2.1.6,</u> <u>602.2.1.6.1,</u> <u>602.2.1.6.2,</u> <u>602.2.1.6.3,</u> <u>602.2.1.7, 604.3,</u> <u>1204.1</u>
<u>E 119—2012a</u>	<u>Test Method for Fire Tests of Building Construction and Materials</u>	<u>607.5.2, 607.5.5,</u> <u>607.6.1,</u> <u>607.6.2.1,</u> <u>607.2.1</u>
<u>E 136—2012</u>	<u>Test Method for Behavior of Materials in a Vertical Tube Furnace at 750 Degrees C</u>	<u>202</u> <u>(NONCOMBUSTIBLE MATERIALS)</u>

<u>ASTM</u>	<u>ASTM International</u> <u>100 Barr Harbor Drive</u> <u>West Conshohocken, PA 19428</u>	
<u>Standard reference number</u>	<u>Title</u>	<u>Referenced in code section number</u>
<u>E 814—2013</u>	<u>Test Method for Fire Tests of Through-penetration Fire Stops</u>	<u>506.3.11.1,</u> <u>506.3.11.2,</u> <u>506.3.11.3,</u> <u>803.10.4.2</u>
<u>E 1509—12</u>	<u>Specification for Room Heaters, Pellet Fuel-burning Type</u>	<u>904.1</u>
<u>E 2231—09</u>	<u>Standard Practice For Specimen Preparation and Mounting of Pipe and Duct Insulation Materials to Assess Surface Burning Characteristics</u>	<u>604.3, 1204.1</u>
<u>E 2336—04(2013)</u>	<u>Standard Test Methods for Fire Resistive Grease Duct Enclosure Systems</u>	<u>506.3.6,</u> <u>506.3.11.2</u>
<u>E 2816—17</u>	<u>Standard Test Methods for Fire Resistive Metallic HVAC Duct Systems</u>	<u>803.10.4.2</u>
<u>F 437—09</u>	<u>Specification for Threaded Chlorinated Poly (Vinyl Chloride) (CPVC) Plastic Pipe Fittings, Schedule 80</u>	<u>Table 1210.5</u>
<u>F 438—09</u>	<u>Specification for Socket Type Chlorinated Poly (Vinyl Chloride) (CPVC) Plastic Pipe Fittings, Schedule 40</u>	<u>Table 1202.5,</u> <u>Table 1210.5</u>
<u>F 439—12</u>	<u>Specification for Socket Type Chlorinated Poly (Vinyl Chloride) (CPVC) Plastic Pipe Fittings, Schedule 80</u>	<u>Table 1202.5,</u> <u>Table 1210.5</u>
<u>F 441/F 441M—13</u>	<u>Specification for Chlorinated Poly (Vinyl Chloride) (CPVC) Plastic Pipe, Schedules 40 and 80</u>	<u>Table 1202.4,</u> <u>Table 1210.4</u>
<u>F 442/F 442M13</u>	<u>Specification for Chlorinated Poly (Vinyl Chloride) (CPVC) Plastic Pipe (SDR-PR)</u>	<u>Table 1202.4,</u> <u>Table 1210.4</u>
<u>F 492-95</u>	<u>Specification for Propylene and Polypropylene (PP) Plastic-Lined Ferrous Metal Pipe and Fittings</u>	<u>1203.1.2</u>
<u>F 493—10</u>	<u>Specification for Solvent Cements for Chlorinated Poly(Vinyl Chloride) (CPVC) Plastic Pipe and Fittings</u>	<u>1203.3.4</u>
<u>F 714—13</u>	<u>Standard Specification for Polyethylene (PE) Plastic Pipe (SDR-PR) based on Outside Diameter</u>	<u>Table 1210.4</u>
<u>F 876—13</u>	<u>Specification for Cross-linked Polyethylene (PEX) Tubing</u>	<u>Table 1202.4,</u> <u>Table 1210.4</u>
<u>F 877—2011A</u>	<u>Specification for Cross-linked Polyethylene (PEX) Plastic Hot and Cold Water Distribution Systems</u>	<u>Table 1202.4,</u> <u>Table 1202.5,</u> <u>Table 1210.4,</u> <u>Table 1210.5</u>
<u>F 1055—13</u>	<u>Specification for Electrofusion Type Polyethylene Fittings for Outside Diameter Controlled Polyethylene and Cross-linked Polyethylene Pipe and Tubing</u>	<u>Table 1210.5,</u> <u>1210.6.6.2</u>
<u>F 1281—11</u>	<u>Specification for Cross-linked Polyethylene/Aluminum/Crosslinked Polyethylene(PEX-AL-PEX) Pressure Pipe</u>	<u>Table 1202.4</u>

<u>ASTM</u>	ASTM International 100 Barr Harbor Drive West Conshohocken, PA 19428	
<u>Standard reference number</u>	<u>Title</u>	<u>Referenced in code section number</u>
<u>F 1282—10</u>	<u>Standard Specification for Polyethylene/Aluminum/Polyethylene (PE-AL-PE) Composite Pressure Pipe</u>	<u>Table 1202.4, Table 1210.4, Table 1210.5</u>
<u>F 1476—07</u>	<u>Specification for Performance of Gasketed Mechanical Couplings for Use in Piping Applications</u>	<u>Table 1202.5, 1203.3.7</u>
<u>F 1548—01(2006)</u>	<u>Standard Specification for the Performance of Fittings for Use with Gasketed Mechanical Couplings Used in Piping Applications</u>	<u>Table 1202.5</u>
<u>F 1807—13</u>	<u>Standard Specification for Metal Insert Fittings Utilizing a Copper Crimp Ring for SDR 9 Cross-linked Polyethylene (PEX) Tubing and SDR9 Polyethylene of Raised Temperature (PE-RT) Tubing</u>	<u>Table 1202.5, Table 1210.5</u>
<u>F 1924—12</u>	<u>Standard Specification for Plastic Mechanical Fittings for Use on Outside Diameter Controlled Polyethylene Gas Distribution Pipe and Tubing</u>	<u>1210.6.6.3</u>
<u>F1960—12</u>	<u>Specification for Cold-Expansion Fittings with PEX Reinforcing Rings for Use with Cross-linked Polyethylene (PEX) Tubing</u>	<u>Table 1210.5</u>
<u>F 1974—09</u>	<u>Standard Specification for Metal Insert Fittings for Polyethylene/Aluminum/Polyethylene and Cross-linked Polyethylene/Aluminum/Cross-linked Polyethylene Composite Pressure Pipe</u>	<u>Table 1202.5</u>
<u>F 2080—12</u>	<u>Specification for Cold-Expansion Fittings with Metal Compression-Sleeves for Cross-linked Polyethylene (PEX) Pipe</u>	<u>Table 1210.5</u>
<u>F 2098—08</u>	<u>Standard Specification for Stainless Steel Clamps for SDR9 Cross-linked Polyethylene (PEX) Tubing to Metal and Plastic Insert Fittings</u>	<u>Table 1202.5</u>
<u>F 2159—11</u>	<u>Standard Specification for Plastic Insert Fittings Utilizing a Copper Crimp Ring for SDR 9 Cross-linked Polyethylene (PEX) Tubing and SDR9 Polyethylene of Raised Temperature (PE-RT) Tubing</u>	<u>Table 1202.5, Table 1210.5</u>
<u>F 2389—10</u>	<u>Specification for Pressure-rated Polypropylene Piping Systems</u>	<u>Table 1202.4, Table 1202.5, 1203.15.1, Table 1210.4, Table 1210.5, 1210.6.7.1</u>

<u>ASTM</u>	<u>ASTM International</u> <u>100 Barr Harbor Drive</u> <u>West Conshohocken, PA 19428</u>	
<u>Standard reference number</u>	<u>Title</u>	<u>Referenced in code section number</u>
<u>F2434—09</u>	<u>Standard Specification for Metal Insert Fittings Utilizing a Copper Crimp ring for SDR9 Cross-linked Polyethylene (PEX) Tubing and SDR9 Cross-linked Polyethylene/Aluminum/Cross-linked Polyethylene (PEX-AL-PEX) Tubing</u>	<u>Table 1210.5</u>
<u>F 2623—08</u>	<u>Standard Specification for Polyethylene of Raised Temperature (PE-RT) SDR 9 Tubing1</u>	<u>Table 1202.4,</u> <u>Table 1210.4</u>
<u>F 2735—09</u>	<u>Standard Specification for Plastic Insert Fittings for SDR 9 Cross-linked Polyethylene (PEX) and Polyethylene of Raised Temperature (PE-RT) Tubing</u>	<u>Table 1202.5</u>
<u>F 2769—10</u>	<u>Polyethylene of Raised Temperature (PE-RT) Plastic Hot- and Cold-water Tubing and Distribution Systems</u>	<u>Table 1202.4,</u> <u>Table 1202.5</u>
<u>F 2806—10</u>	<u>Standard Specification for Acrylonitrile-Butadiene-Styrene (ABS) Plastic Pipe (Metric SDR-PR)</u>	<u>Table 1202.4</u>

<u>AWS</u>	<u>American Welding Society</u> <u>8669 NW 36 Street, #130</u> <u>Doral, FL 33166</u>	
<u>Standard reference number</u>	<u>Title</u>	<u>Referenced in code section number</u>
<u>B2.1-2014</u>	<u>Specification for Brazing Procedure and Performance Qualification</u>	<u>1203.3.6</u>
<u>B2.2-2016</u>	<u>Specification for Brazing Procedure and Performance Qualification</u>	<u>1107.5.4,</u> <u>1203.3.1,</u> <u>1303.1,</u> <u>1303.3.1</u>

<u>AWWA</u>	<u>American Water Work Association</u> <u>6666 West Quincy Avenue</u> <u>Denver, CO 80235</u>	
<u>Standard reference number</u>	<u>Title</u>	<u>Referenced in code section number</u>
<u>C901—08</u>	<u>Polyethylene (PE) Pressure Pipe and Tubing, 1/2 in. (13mm) through 3 in. (76mm) for Water Service</u>	<u>Table 1210.4</u>

<u>AWWA</u>	<u>American Water Work Association</u> <u>6666 West Quincy Avenue</u> <u>Denver, CO 80235</u>	
<u>Standard reference number</u>	<u>Title</u>	<u>Referenced in code section number</u>
<u>C110/A21.10—12</u>	<u>Standard for Ductile Iron & Gray Iron Fittings</u>	<u>Table 1202.5</u>
<u>C115/A21.15—11</u>	<u>Standard for Flanged Ductile-Iron Pipe with Ductile Iron or Grey-Iron Threaded Flanges</u>	<u>Table 1202.4</u>
<u>C151/A21.51—09</u>	<u>Standard for Ductile-Iron Pipe, Centrifugally Cast for Water</u>	<u>Table 1202.4</u>
<u>C153/A21.53—11</u>	<u>Standard for Ductile-Iron Compact Fittings for Water Service</u>	<u>Table 1202.5</u>

<u>BSI</u>	<u>BSI Standards (British Standards Institution)</u> <u>12950 Worldgate Drive, Suite 800</u> <u>Herndon, VA 20170</u>	
<u>Standard reference number</u>	<u>Title</u>	<u>Referenced in code section number</u>
<u>EN 378-1—2016</u>	<u>Refrigerating Systems and Heat Pumps - Safety and Environmental Requirements - Part 1: Basic Requirements, Definitions, Classification and Selection Criteria</u>	<u>1107.9.1,</u> <u>1107.9.2,</u> <u>1107.9.2.1</u>
<u>EN 378-3—2016</u>	<u>Refrigerating Systems and Heat Pumps - Safety and Environmental Requirements - Part 3: Installation Site and Personal Protection</u>	<u>1107.9.2.2,</u> <u>1107.9.3,</u> <u>1107.9.4,</u> <u>1107.9.5</u>

<u>CAN/ULC</u>	<u>Standards Council of Canada</u> <u>270 Albert Street, Suite 200</u> <u>Ottawa ON K1P 6N7</u> <u>Canada</u>	
<u>Standard reference number</u>	<u>Title</u>	<u>Referenced in code section number</u>
<u>S635—16</u>	<u>Standard for Lining Systems for Existing Masonry or Factory-Built Chimneys and Vents</u>	<u>801.16.1,</u> <u>801.18.4</u>
<u>S640—16</u>	<u>Standard for Lining Systems for New Masonry Chimneys</u>	<u>801.16.1</u>
<u>S667—11</u>	<u>Metallic Underground Piping for Flammable and Combustible Liquids</u>	<u>1302.9.1</u>

<u>CSA</u>	<u>CSA Group</u> <u>8501 East Pleasant Valley Road</u> <u>Cleveland, OH 44131-5516</u>	
<u>Standard reference number</u>	<u>Title</u>	<u>Referenced in code section number</u>
<u>B137.2—13</u>	<u>Polyvinylchloride (PVC) Injection-moulded Gasketed Fittings for Pressure Applications</u>	<u>Table 1210.5</u>
<u>B137.3—13</u>	<u>Rigid Poly (Vinyl Chloride) (PVC) Pipe for Pressure Applications</u>	<u>Table 1210.5</u>
<u>B137.6—13</u>	<u>Chlorinated Polyvinylchloride (CPVC) Pipe, Tubing and Fittings for Hot- and Cold-water Distribution Systems</u>	<u>Table 1210.5</u>
<u>B137.9—13</u>	<u>Polyethylene/Aluminum/Polyethylene (PE-AL-PE) Composite Pressure-Pipe Systems</u>	<u>Table 1202.4,</u> <u>Table 1210.4,</u> <u>Table 1210.5,</u>
<u>B137.10—13</u>	<u>Cross-linked Polyethylene/Aluminum/ Cross-linked Polyethylene (PEX-AL-PEX) Composite Pressure-Pipe Systems</u>	<u>Table 1202.4</u>
<u>CSA C448 Series—02</u> <u>CAN/CSA 2002</u>	<u>Design and Installation of Earth Energy Systems—First Edition; Update 2: October 2009; CAN/CSA 2002 Consolidated Reprint 10/2009</u>	<u>Table 1210.4,</u> <u>Table 1210.5</u>
<u>B137.1—13</u>	<u>Polyethylene (PE) Pipe, Tubing and Fittings for Cold Water Pressure Services</u>	<u>Table 1210.4,</u> <u>Table 1210.5</u>
<u>B137.5—13</u>	<u>Cross-linked Polyethylene (PEX) Tubing Systems for Pressure Applications</u>	<u>Table 1210.4,</u> <u>Table 1210.5</u>
<u>B137.11—13</u>	<u>Polypropylene (PP-R) Pipe and Fittings for Pressure Applications</u>	<u>Table 1210.4,</u> <u>Table 1210.5</u>
<u>ANSI/CSA America FC1—2012</u>	<u>Stationary Fuel Cell Power Systems</u>	<u>924.1</u>

<u>DOL</u>	<u>Department of Labor</u> <u>Occupational Safety and Health Administration</u> <u>c/o Superintendent of Documents</u> <u>US Government Printing Office</u> <u>Washington, DC 20402-9325</u>	
<u>Standard reference number</u>	<u>Title</u>	<u>Referenced in code section number</u>
<u>29 CFR Part 1910.1000 (2009)</u>	<u>Air Contaminants</u>	<u>502.6</u>

<u>EN</u>	<u>BSI Standards (British Standards Institution)</u> <u>12950 Worldgate Drive, Suite 800</u> <u>Herndon, VA 20170</u>	
<u>Standard reference number</u>	<u>Title</u>	<u>Referenced in code section number</u>
<u>EN 378-1—2016</u>	<u>Refrigerating Systems and Heat Pumps - Safety and Environmental Requirements - Part 1: Basic Requirements, Definitions, Classification and Selection Criteria</u>	<u>1107.9.1,</u> <u>1107.9.2,</u> <u>1107.9.2.1</u>
<u>EN 378-3—2016</u>	<u>Refrigerating Systems and Heat Pumps - Safety and Environmental Requirements - Part 3: Installation Site and Personal Protection</u>	<u>1107.9.2.2,</u> <u>1107.9.3,</u> <u>1107.9.4,</u> <u>1107.9.5</u>

<u>IIAR</u>	<u>International Institute of Ammonia Refrigeration</u> <u>1110 North Glebe Road</u> <u>Arlington, VA 22201</u>	
<u>Standard reference number</u>	<u>Title</u>	<u>Referenced in code section number</u>
<u>2—2014</u>	<u>Standard for Safe Design of Closed-Circuit Ammonia Refrigeration Systems</u>	<u>1101.6, 1105.6.3</u>

<u>MSS</u>	<u>Manufacturers Standardization Society of the Valve & Fittings Industry, Inc.</u> <u>127 Park Street, N.E.</u> <u>Vienna, VA 22180</u>	
<u>Standard reference number</u>	<u>Title</u>	<u>Referenced in code section number</u>
<u>ANSI/SP-58—2009</u>	<u>Pipe Hangers and Supports—Materials Design and Manufacture, Selection, Application and Installation</u>	<u>305.4</u>

<u>NAIMA</u>	<u>North American Insulation Manufacturers Association</u> <u>44 Canal Center Plaza, Suite 310</u> <u>Alexandria, VA 22314</u>	
<u>Standard reference number</u>	<u>Title</u>	<u>Referenced in code section number</u>
AH116—09	Fibrous Glass Duct Construction Standards	603.5, 603.9

<u>NBBI</u>	<u>National Board of Boiler and Pressure Vessel Inspectors</u> <u>1055 Crupper Avenue</u> <u>Columbus, OH 43229-1183</u>	
<u>Standard reference number</u>	<u>Title</u>	<u>Referenced in code section number</u>
NBIC-2011	<u>National Board Inspection Code, Part 3</u>	<u>1003.3, 1011.1.1,</u> <u>1011.3</u>

<u>NFPA</u>	<u>National Fire Protection Association</u> <u>1 Batterymarch Park</u> <u>Quincy, MA 02169-7471</u>	
<u>Standard reference number</u>	<u>Title</u>	<u>Referenced in code section number</u>
10—13	<u>Portable Fire Extinguishers</u>	<u>1301.8</u>
30A—15	<u>Code for Motor Fuel-dispensing Facilities and Repair Garages</u>	<u>304.6</u>
30—12	<u>Flammable and Combustible Liquids Code</u>	<u>1305.8.4</u>
31—11	<u>Standard for the Installation of Oil-burning Equipment</u>	<u>801.2.4, 801.18.1,</u> <u>801.18.2, 901.2,</u> <u>918.1, 920.2,</u> <u>1301.2, 1305.15.3,</u> <u>1305.15.6, 1308.1</u>
32—16	<u>Standard for Drycleaning Plants</u>	<u>502.6</u>
37—15	<u>Standard for the Installation and Use of Stationary Combustion Engines and Gas Turbines</u>	<u>811.1, 811.2, 915.1,</u> <u>915.2</u>
45—15	<u>Fire Protection for Laboratories Using Chemicals</u>	<u>408.1, 502.22</u>
54—16	<u>National Fuel Gas Code</u>	<u>504.9, 901.2, 910.7</u>
69—14	<u>Standard on Explosion Prevention Systems</u>	<u>510.9.3</u>
82—14	<u>Standard on Incinerators and Waste and Linen Handling Systems and Equipment</u>	<u>907.1, 601.1</u>
85—15	<u>Boiler and Combustion Systems Hazards Code</u>	<u>1004.1, 1004.1.1,</u> <u>1004.8</u>
91—15	<u>Standard for Exhaust Systems for Air Conveying of Vapors, Gases, Mists, and Noncombustible Particulate Solids</u>	<u>502.9.5.1, 502.17</u>

<u>NFPA</u>	<u>National Fire Protection Association</u> <u>1 Batterymarch Park</u> <u>Quincy, MA 02169-7471</u>	
<u>Standard reference number</u>	<u>Title</u>	<u>Referenced in code section number</u>
<u>96—14</u>	<u>Standard for Ventilation Control and Fire Protection of Commercial Cooking Operations</u>	<u>507.1</u>
<u>211—13</u>	<u>Standard for Chimneys, Fireplaces, Vents and Solid Fuel-burning Appliances</u>	<u>802.1,</u> <u>Table 803.10.6,</u> <u>806.1, 811.1, 901.2</u>
<u>262—15</u>	<u>Standard Method of Test for Flame Travel and Smoke of Wires and Cables for Use in Air-handling Spaces</u>	<u>602.2.1.1</u>
<u>286—15</u>	<u>Standard Methods of Fire Tests for Evaluating Contribution of Wall and Ceiling Interior Finish to Room Fire Growth</u>	<u>602.2.1.6.2</u>
<u>704—12</u>	<u>Standard System for Identification of the Hazards of Materials for Emergency Response</u>	<u>502.8.4, 510.1,</u> <u>1105.11</u>
<u>853—15</u>	<u>Standard on Installation of Stationary Fuel Power Plants</u>	<u>924.1</u>

<u>NSF</u>	<u>NSF International</u> <u>789 Dixboro Road, P. O. Box 130140</u> <u>Ann Arbor, MI 48113-0140</u>	
<u>Standard reference number</u>	<u>Title</u>	<u>Referenced in code section number</u>
<u>NSF 358-1—2011</u>	<u>Polyethylene Pipe and Fittings for Water Based Ground Source “Geothermal” Heat Pump Systems</u>	<u>Table 1210.4,</u> <u>Table 1210.5</u>

<u>SMACNA</u>	<u>Sheet Metal & Air-Conditioning Contractors National Assoc., Inc.</u> <u>4201 Lafayette Center Drive</u> <u>Chantilly, VA 20151-1209</u>	
<u>Standard reference number</u>	<u>Title</u>	<u>Referenced in code section number</u>
<u>SMACNA/ANSI—2005</u>	<u>HVAC Duct Construction Standards-Metal and Flexible 4th Edition (ANSI)</u>	<u>504.10, 603.4,</u> <u>Table 603.4, 603.9,</u> <u>603.10</u>
<u>SMACNA/ANSI—2011</u>	<u>Rectangular Industrial Duct Construction Standards</u>	<u>510.9.1</u>
<u>SMACNA/ANSI—2013</u>	<u>Round Industrial Duct Construction Standards</u>	<u>510.9.1</u>
<u>SMACNA—10</u>	<u>Fibrous Glass Duct Construction Standards</u>	<u>603.5</u>

<u>UL</u>	<u>UL LLC</u> <u>333 Pfingsten Road</u> <u>Northbrook, IL 60062-2096</u>	
<u>Standard reference number</u>	<u>Title</u>	<u>Referenced in code section number</u>
<u>58—96</u>	<u>Steel Underground Tanks for Flammable and Combustible Liquids</u>	<u>1305.12.1,</u> <u>1305.14</u>
<u>80—07</u>	<u>Steel Tanks for Oil-Burner Fuel- with revisions through August 2009</u>	<u>Table 1305.7(2),</u> <u>1305.12.2,</u> <u>1305.14, Figure</u> <u>C101.1(1), Figure</u> <u>C101.1(3)</u>
<u>103—2010</u>	<u>Factory-built Chimneys, Residential Type and Building Heating Appliance—with revisions through July 2012</u>	<u>805.2, 805.3, 811.1</u>
<u>127—2011</u>	<u>Factory-built Fireplaces</u>	<u>805.7, 903.1, 903.4</u>
<u>142—2006</u>	<u>Aboveground Tanks for Flammable and Combustible Liquids</u>	<u>Table 1305.7(2),</u> <u>1305.8, 1305.12.2,</u> <u>1305.14, Figure</u> <u>C101.1(2), Figure</u> <u>C101.1(3)</u>
<u>174—04</u>	<u>Household Electric Storage Tank Water Heaters—with revisions through September 2012</u>	<u>1002.1</u>
<u>181—2013</u>	<u>Factory-made Air Ducts and Air Connectors—with revisions through October 2008</u>	<u>512.2, 603.5,</u> <u>603.6.1.1, 603.6.2,</u> <u>603.11.1, 604.13</u>
<u>181A—2013</u>	<u>Closure Systems for Use with Rigid Air Ducts and Air Connectors</u>	<u>603.9</u>
<u>181B—2013</u>	<u>Closure Systems for Use with Flexible Air Ducts and Air Connectors</u>	<u>603.9</u>
<u>197—10</u>	<u>Commercial Electric Cooking Appliances—with revisions through June 2011</u>	<u>917.1</u>
<u>207—2009</u>	<u>Refrigerant-containing Components and Accessories, Nonelectrical</u>	<u>1101.2</u>
<u>263—2011</u>	<u>Standard for Fire Test of Building Construction and Materials</u>	<u>607.5.2, 607.5.5,</u> <u>607.6.1, 607.6.2.1</u>
<u>268—2009</u>	<u>Smoke Detectors for Fire Alarm Systems</u>	<u>606.1</u>
<u>268A—2009</u>	<u>Smoke Detectors for Duct Application—with revisions through September 2009</u>	<u>606.1</u>
<u>378—06</u>	<u>Draft Equipment—with revisions through January 2010</u>	<u>804.3, 804.3.8</u>
<u>391—2010</u>	<u>Solid-fuel and Combination-fuel Central and Supplementary Furnaces— with revisions through March 2010</u>	<u>918.1</u>
<u>412—2011</u>	<u>Refrigeration Unit Coolers— with revisions through August 2012</u>	<u>1101.2</u>

<u>UL</u>	<u>UL LLC</u> <u>333 Pfingsten Road</u> <u>Northbrook, IL 60062-2096</u>	
<u>Standard reference number</u>	<u>Title</u>	<u>Referenced in code section number</u>
<u>471—2010</u>	<u>Commercial Refrigerators and Freezers— with revisions through December 2012</u>	<u>1101.2</u>
<u>499—05</u>	<u>Electric Heating Appliances—with revisions through February 2013</u>	<u>912.1, 923.1</u>
<u>555—06</u>	<u>Fire Dampers— with revisions through May 2012</u>	<u>607.3.1</u>
<u>555C—06</u>	<u>Ceiling Dampers— with revisions through May 2010</u>	<u>607.3.1</u>
<u>555S—99</u>	<u>Smoke Dampers—with revisions through May 2012</u>	<u>607.2.1.1, 607.3.1</u>
<u>586—2009</u>	<u>High-Efficiency, Particulate, Air Filter Units</u>	<u>605.2</u>
<u>641—2010</u>	<u>Type L Low-temperature Venting Systems—with revisions through May 2013</u>	<u>802.1</u>
<u>705—2004</u>	<u>Standard for Power Ventilators—with revisions through March 2012</u>	<u>504.5</u>
<u>710—2012</u>	<u>Exhaust Hoods for Commercial Cooking Equipment</u>	<u>507.1</u>
<u>710B—2011</u>	<u>Recirculating Systems</u>	<u>507.1, 507.1.2, 507.2</u>
<u>723—2008</u>	<u>Standard for Test for Surface Burning Characteristics of Building Materials</u>	<u>202 (FLAME SPREAD INDEX), 510.9, 602.2, 602.2.1, 602.2.1.6, 602.2.1.6.1, 602.2.1.6.2, 602.2.1.6.3, 602.2.1.7, 604.3, 1204.1</u>
<u>726—95</u>	<u>Oil-fired Boiler Assemblies—with revisions through April 2011</u>	<u>916.1, 1004.1, 1004.1.1</u>
<u>727—06</u>	<u>Oil-fired Central Furnaces—with revisions through April 2010</u>	<u>918.1</u>
<u>729—03</u>	<u>Oil-fired Floor Furnaces—with revisions through August 2012</u>	<u>910.1</u>
<u>730—03</u>	<u>Oil-fired Wall Furnaces—with revisions through August 2012</u>	<u>909.1</u>
<u>731—95</u>	<u>Oil-fired Unit Heaters— with revisions through August 2012</u>	<u>920.1</u>
<u>732—95</u>	<u>Oil-fired Storage Tank Water Heaters—with revisions through April 2010</u>	<u>1002.1, 1002.2</u>
<u>737—2011</u>	<u>Fireplace Stoves</u>	<u>905.1</u>
<u>762—2010</u>	<u>Outline of Investigation for Power Ventilators for Restaurant Exhaust Appliances</u>	<u>506.5.1</u>
<u>791—06</u>	<u>Residential Incinerators—with revisions through April 2010</u>	<u>907.1</u>
<u>795-16</u>	<u>Commercial-Industrial Gas Heating Equipment.</u>	<u>1004.1.1</u>

<u>UL</u>	<u>UL LLC</u> <u>333 Pfingsten Road</u> <u>Northbrook, IL 60062-2096</u>	
<u>Standard reference number</u>	<u>Title</u>	<u>Referenced in code section number</u>
<u>834—04</u>	<u>Heating, Water Supply and Power Boilers Electric—with revisions through January 2013</u>	<u>1004.1</u>
<u>842—07</u>	<u>Valves for Flammable Fluids—with revisions through October 2012</u>	<u>1307.1</u>
<u>858—05</u>	<u>Household Electric Ranges—with revisions through April 2012</u>	<u>917.1</u>
<u>867—2011</u>	<u>Electrostatic Air Cleaners—with revisions through February 2013</u>	<u>605.2</u>
<u>875—09</u>	<u>Electric Dry Bath Heater—with revisions through November 2011</u>	<u>914.2</u>
<u>896—93</u>	<u>Oil-burning Stoves—with revisions through August 2012</u>	<u>917.1</u>
<u>900—04</u>	<u>Air Filter Units—with revisions through February 2012</u>	<u>605.2</u>
<u>907—94</u>	<u>Fireplace Accessories—with revisions through April 2010</u>	<u>902.2</u>
<u>923—2013</u>	<u>Microwave Cooking Appliances-</u>	<u>917.1</u>
<u>959—2010</u>	<u>Medium Heat Appliance Factory-Built Chimneys</u>	<u>805.5</u>
<u>1046—2010</u>	<u>Grease Filters for Exhaust Ducts—with revisions through January 2012</u>	<u>507.2.8</u>
<u>1240—2012</u>	<u>Electric Commercial Clothes—Drying Equipment—with revisions through October 2012</u>	<u>913.1</u>
<u>1261—01</u>	<u>Electric Water Heaters for Pools and Tubs—with revisions through July 2012</u>	<u>916.1</u>
<u>1316—94</u>	<u>Glass-Fiber Reinforced Plastic Underground Storage Tanks for Petroleum Products, Alcohols, and Alcohol-Gasoline Mixtures.</u>	<u>1305.12.1,</u> <u>1305.14</u>
<u>1453—04</u>	<u>Electric Booster and Commercial Storage Tank Water Heaters—with revisions through July 2011</u>	<u>1002.1</u>
<u>1479—03</u>	<u>Fire Tests of Through-penetration Firestops—with revisions through October 2012</u>	<u>506.3.11.2,</u> <u>506.3.11.3</u>
<u>1482—2011</u>	<u>Solid-fuel Type Room Heaters with</u>	<u>905.1</u>
<u>1618—09</u>	<u>Wall Protectors, Floor Protectors and Hearth Extensions—with revisions through May 2013</u>	<u>903.2, 905.3</u>
<u>1738—10</u>	<u>Standard for Venting Systems for Gas-Burning Appliances, Categories II, III, and IV</u>	<u>811.1</u>
<u>1777—2007</u>	<u>Chimney Liners—with revisions through July 2009</u>	<u>801.16.1, 801.18.4</u>
<u>1812—2013</u>	<u>Standard for Ducted Heat Recovery Ventilators</u>	<u>514.1</u>
<u>1815—2012</u>	<u>Standard for Nonducted Heat Recovery Ventilators</u>	<u>514.1</u>
<u>1820—04</u>	<u>Fire Test of Pneumatic Tubing for Flame and Smoke Characteristics—with revisions through May 2013</u>	<u>602.2.1.3</u>
<u>1887—04</u>	<u>Fire Tests of Plastic Sprinkler Pipe for Visible Flame and Smoke Characteristics—with revisions through May 2013</u>	<u>602.2.1.2</u>

<u>UL</u>	<u>UL LLC</u> <u>333 Pfingsten Road</u> <u>Northbrook, IL 60062-2096</u>	
<u>Standard reference number</u>	<u>Title</u>	<u>Referenced in code section number</u>
<u>1978—2010</u>	<u>Grease Ducts</u>	<u>506.3.1.1, 506.3.2, 506.3.6</u>
<u>1995—2011</u>	<u>Heating and Cooling Equipment</u>	<u>911.1, 918.1, 918.2, 1002.1, 1101.2</u>
<u>1996—2009</u>	<u>Electric Duct Heaters—with revisions through November 2011</u>	<u>911.1</u>
<u>2024—2011</u>	<u>Standard for Safety Optical-Fiber and Communications Cable Raceway—with revisions through April 2011</u>	<u>602.2.1.1</u>
<u>2039—2016</u>	<u>Flexible Connector Piping for Fuels</u>	<u>1302.8</u>
<u>2043—2008</u>	<u>Fire Test for Heat and Visible Smoke Release for Discrete Products and their Accessories Installed in Air-handling Spaces</u>	<u>602.2.1.4.2, 602.2.1.5</u>
<u>2106—09</u>	<u>Standard for Field Erected Boiler Assemblies</u>	<u>1004.1.1</u>
<u>2158—97</u>	<u>Electric Clothes Dryers—with Revisions through March 2009</u>	<u>913.1</u>
<u>2158A—2010</u>	<u>Outline of Investigation for Clothes Dryer Transition Duct</u>	<u>504.8.3</u>
<u>2162—01</u>	<u>Outline of Investigation for Commercial Wood-fired Baking Ovens-Refractory Type</u>	<u>917.1</u>
<u>2200—2012</u>	<u>Stationery Engine Generator Assemblies—with revisions through June 2013</u>	<u>915.1, Table 1302.3</u>
<u>2221—2010</u>	<u>Tests of Fire Resistive Grease Duct Enclosure Assemblies</u>	<u>506.3.11.3</u>
<u>2258—2010</u>	<u>Outline of Investigation for Nonmetallic Tanks for Oil-Burner Fuels and Other Combustible Liquids</u>	<u>1305.12.2, 1305.15.3, 1305.15.4, 1305.15.7</u>
<u>2518—05</u>	<u>Air Dispersion System Materials</u>	<u>603.17</u>
<u>2561—16</u>	<u>Standard for 1400 Degree Fahrenheit Factory Built Chimneys</u>	<u>811.1</u>
<u>60335-2-40—2012</u>	<u>Safety of Household and Similar Electrical Appliances, Part 2-40: Particular Requirements for Electrical Heat Pumps, Air Conditioners and Dehumidifiers</u>	<u>918.2</u>

§ 17. Appendix A of the New York city mechanical code is REPEALED and a new appendix A is added to read as follows:

APPENDIX A
CHIMNEY CONNECTOR PASS-THROUGHS

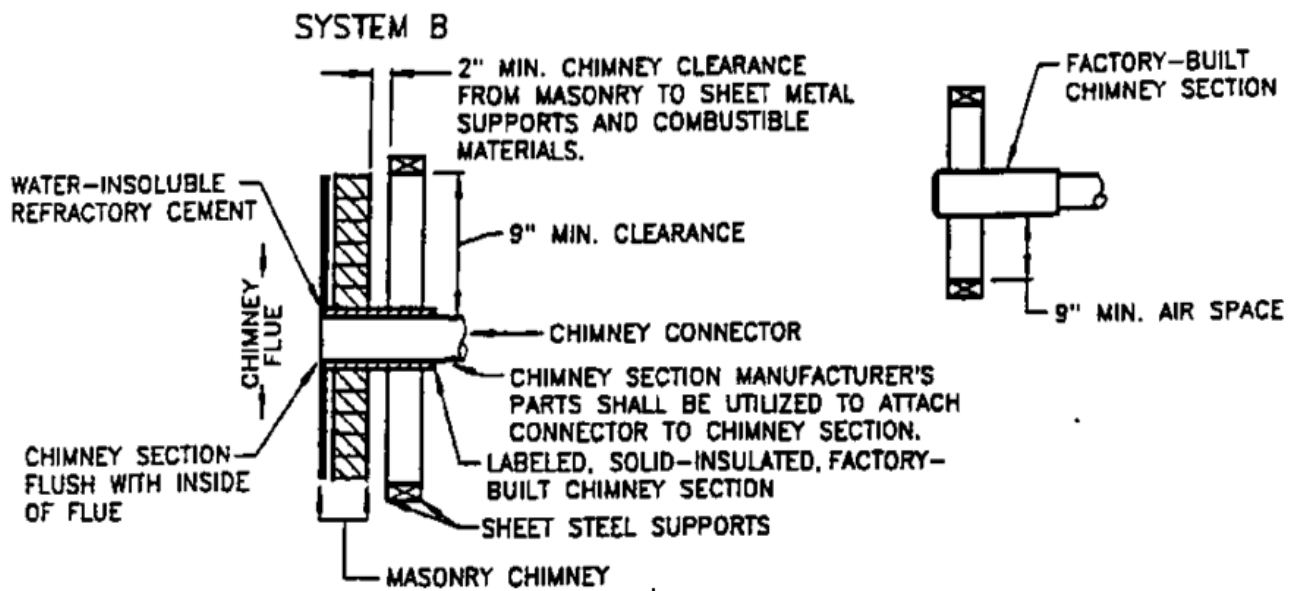
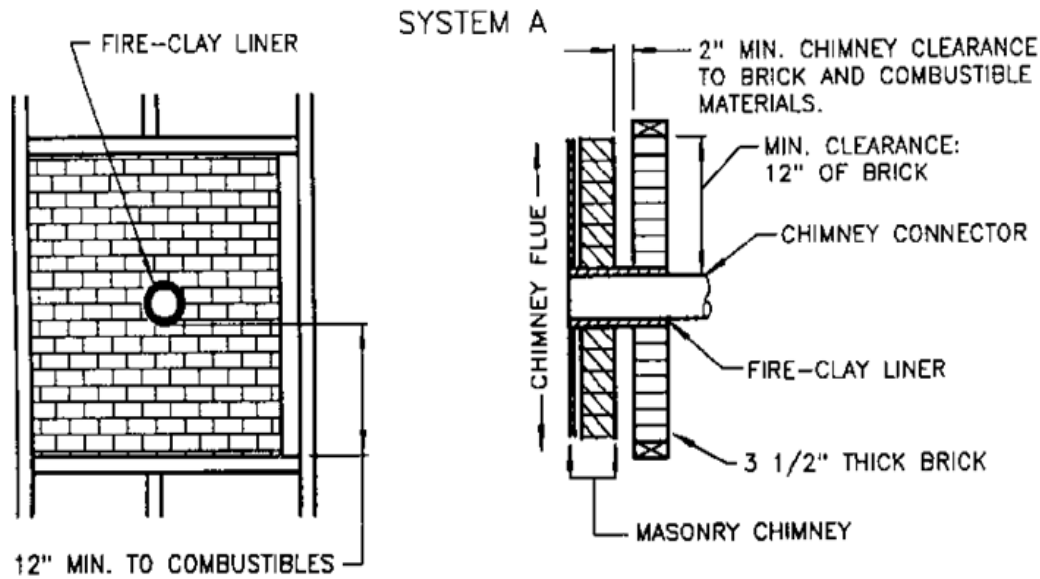

FIGURE A-1
CHIMNEY CONNECTOR SYSTEMS

For SI: 1 inch = 25.4 mm.

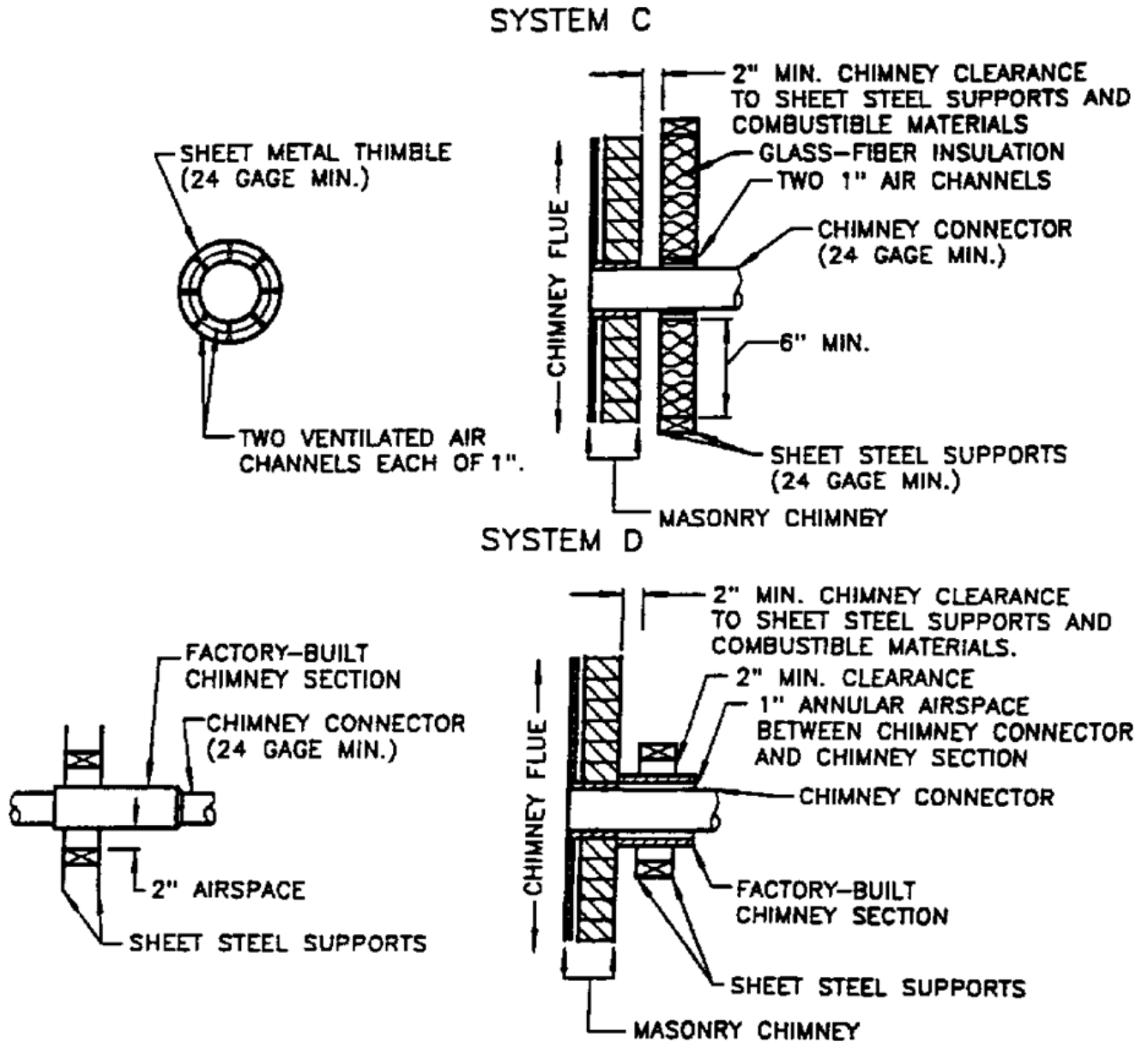

FIGURE A-1—continued
CHIMNEY CONNECTOR SYSTEMS

For SI: 1 inch = 25.4 mm.

§18. The New York city mechanical code is amended by adding a new appendix C, to read as follows:

APPENDIX C
FUEL OIL STORAGE TANK VENTING OPTIONS

SECTION MC C101
GENERAL

C101.1 Scope. The figures in this appendix shall supplement the provisions for venting of tanks in Section 1305 and are intended for illustrative purposes. Where there is a conflict between the figures in this appendix and the provisions in Section 1305, the provisions of Section 1305 shall govern.

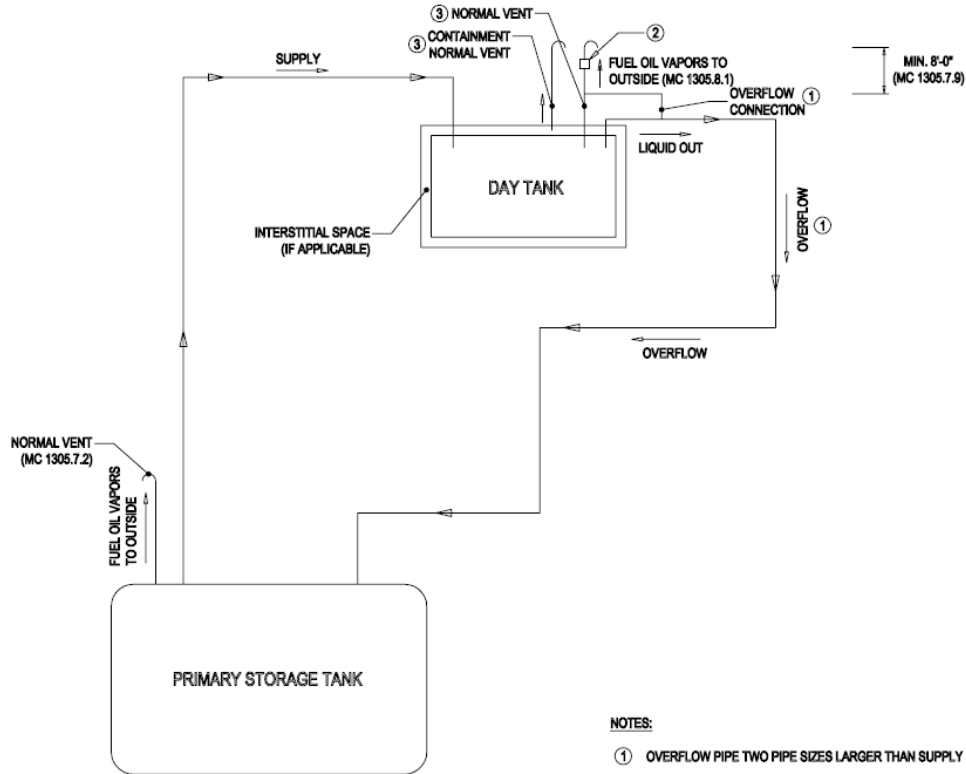

NOTES:

- ① OVERFLOW PIPE TWO PIPE SIZES LARGER THAN SUPPLY PIPE (MC 1305.3.8).
- ② SENSOR TO SHUT DOWN TRANSFER PUMPS (MC. 1305.7.9).
- ③ VENTS MAY BE COMBINED (MC 1305.7.5).

FIGURE C101.1(1)
PRIMARY TANK: UL 80, ASME BPVC, OR NYC ALTERNATE TANK
DAY TANK: UL 80, ASME BPVC, OR NYC ALTERNATE TANK

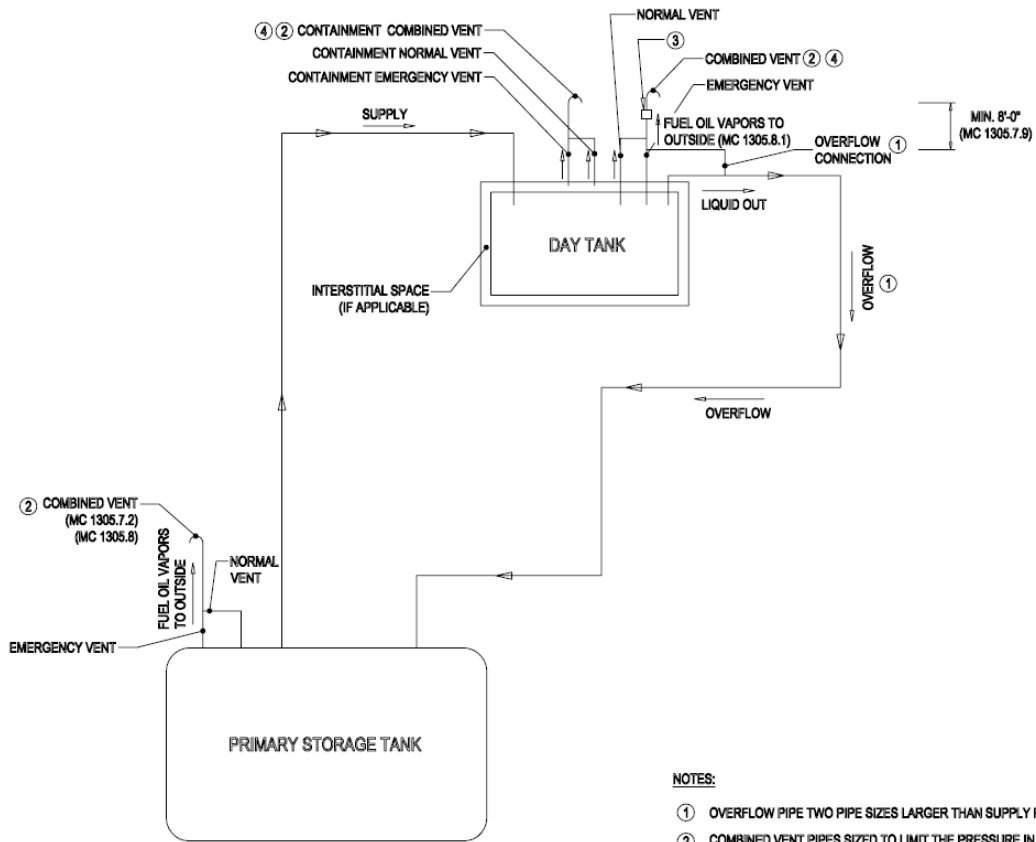

NOTES:

- ① OVERFLOW PIPE TWO PIPE SIZES LARGER THAN SUPPLY PIPE (MC 1305.3.8).
- ② COMBINED VENT PIPES SIZED TO LIMIT THE PRESSURE IN THE STORAGE TANK PER MC 1305.8.4. CALCULATIONS TO BE PROVIDED ON DRAWINGS.
- ③ SENSOR TO SHUT DOWN TRANSFER PUMPS (MC. 1305.7.9).
- ④ VENTS MAY BE COMBINED (MC 1305.7.5).

FIGURE C101.1(2)
PRIMARY TANK: UL 142 OR DUAL LABEL TANK
DAY TANK: UL 142 OR DUAL LABEL TANK

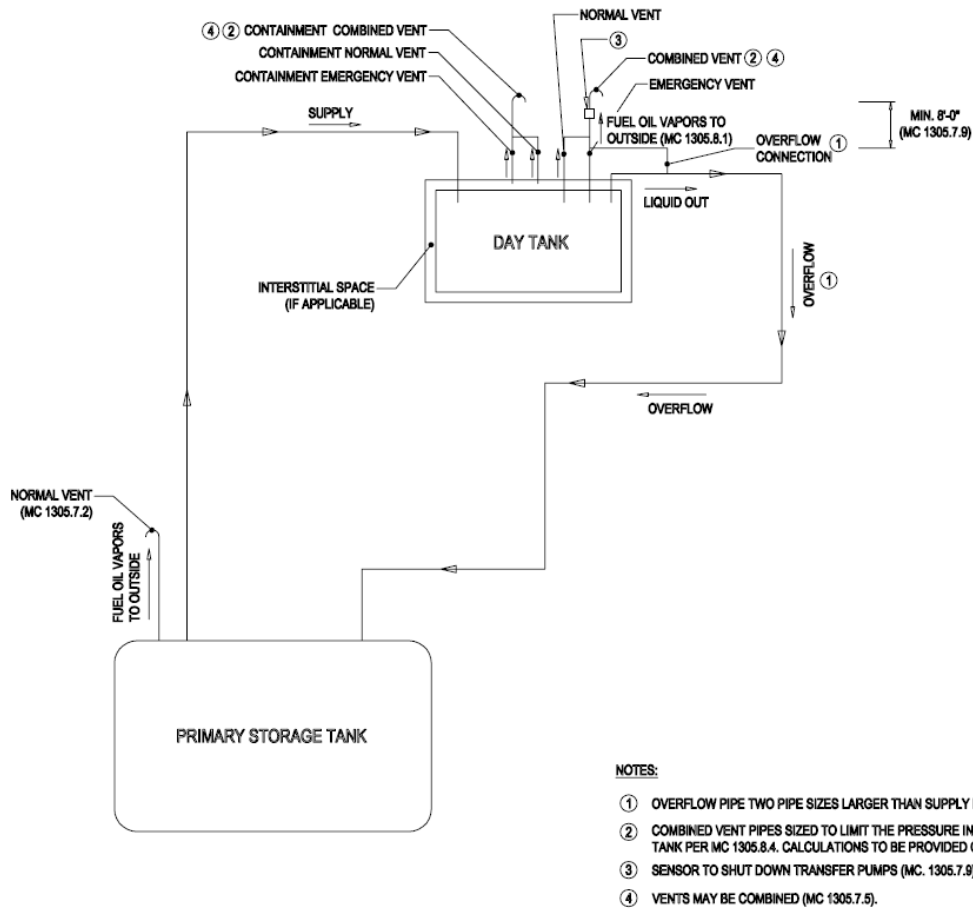

FIGURE C101.1(3)
PRIMARY TANK: UL 80, ASME BPVC, OR NYC ALTERNATE TANK
DAY TANK: UL 142 OR DUAL LABEL TANK

§ 2. Chapter 1 of the New York city fuel gas code, as amended by local law number 141 for the year 2013, is amended to read as follows:

**CHAPTER 1
ADMINISTRATION**

**SECTION FGC 101
GENERAL**

101.1 Title. This code shall be known and may be cited as the “*New York City Fuel Gas Code*,” “NYCFGC” or “FGC.” All section numbers in this code shall be deemed to be preceded by the designation “FGC.”

101.2 Scope. This code shall apply to the installation of fuel-gas piping systems, fuel-gas appliances and related accessories in accordance with Sections 101.2.2 through 101.2.5.

101.2.1 Reserved.

101.2.2 Piping systems. These regulations cover piping systems for natural gas. High pressure natural gas installations at pressures of 15 psig (~~[103]~~ 103.4 kPa gauge) or above shall also comply with the requirements of Appendix G of this code. Coverage shall extend to the outlet of the appliance shutoff valves. Piping system requirements shall include design, materials, components, fabrication, assembly, installation, testing, inspection, operation and maintenance.

101.2.3 Gas utilization appliances. Requirements for gas appliances and related accessories shall include installation, combustion and ventilation air and venting and connections to piping systems.

101.2.4 Systems and equipment outside the scope. This code shall not apply to the following:

1. Portable LP-gas appliances and equipment of all types that are not connected to a fixed fuel piping system.
2. Oxygen-fuel gas cutting and welding systems.
3. Industrial gas applications using gases such as acetylene and acetylenic compounds, hydrogen, ammonia, carbon monoxide, oxygen and nitrogen.
4. Petroleum refineries, pipeline compressor or pumping stations, loading terminals, compounding plants, refinery tank farms and natural gas processing plants.
5. Integrated chemical plants or portions of such plants where flammable or combustible liquids or gases are produced by, or used in, chemical reactions.
6. LP-gas installations at utility gas plants.
7. Liquefied natural gas (LNG) installations.
8. Fuel gas piping in public utility power plants and atomic energy plants.
9. Components within proprietary items of equipment, apparatus or instruments such as gas-generating sets, compressors and calorimeters.

10. LP-gas equipment for vaporization, gas mixing and gas manufacturing.
11. Temporary LP-gas piping for buildings under construction or renovation that is not to become part of the permanent piping system.
12. Installation of LP-gas systems for railroad switch heating.
13. Installation of hydrogen gas, LP-gas and compressed natural gas (CNG) systems on vehicles.
14. Except as provided in Section 401.1.1 and Appendices E and G, gas piping, meters, gas pressure regulators and other appurtenances used by the serving gas supplier in the distribution of gas, other than undiluted LP-gas.
15. Building design and construction, except as specified herein.
16. Piping systems for mixtures of gas and air within the flammable range with an operating pressure greater than 10 psig (~~69~~ 68.9 kPa gauge).
17. Portable fuel cell appliances that are neither connected to a fixed piping system nor interconnected to a power grid.

101.2.5 Other fuels. The requirements for the design, installation, maintenance, alteration and inspection of mechanical systems operating with fuels other than fuel gas shall be regulated by the *New York City Mechanical Code*.

101.3 Reserved.

101.4 Intent. The purpose of this code is to provide minimum standards to safeguard life or limb, health, property, public welfare and the environment by regulating and controlling the design, construction, installation, quality of materials, location, operation and maintenance or use of fuel gas systems.

101.5 Severability. If a section, subsection, sentence, clause or phrase of this code is, for any reason, held to be unconstitutional, such decision shall not affect the validity of the remaining portions of this code.

SECTION FGC 102 APPLICABILITY

102.1 General. Where there is a conflict between a general requirement and a specific requirement, the specific requirement shall govern. Where, in a specific case, different sections of this code specify different materials, methods of construction or other requirements, the most restrictive shall govern.

102.2 Existing installations. Except as otherwise provided for in this chapter or elsewhere in this code, a provision in this code shall not require the removal, alteration or abandonment of, nor prevent the continued utilization and maintenance of, existing installations lawfully in existence on the effective date of this code.

102.2.1 Existing buildings. Additions, alterations, renovations or repairs related to building or structural issues shall be governed by Chapter 1 of Title 28 of the *Administrative Code*, the *New York City Building Code* and the *1968 Building Code*, as applicable.

102.3 Maintenance. Installations, both existing and new, and parts thereof shall be maintained in proper operating condition in accordance with the original design and in a safe condition. Devices or safeguards that are required by this code shall be maintained in compliance with the applicable provisions under which they were installed.

102.3.1 Owner responsibility. The owner or the owner's designated agent shall be responsible for maintenance of installations. To determine compliance with this provision, the commissioner shall have the authority to require an existing installation to be inspected.

102.4 Additions, alterations or repairs. Additions, alterations, renovations or repairs to installations shall conform to that required for new installations without requiring the existing installation to comply with all of the requirements of this code. Additions, alterations or repairs shall not cause an existing installation to become unsafe, hazardous or overloaded.

102.4.1 Minor additions, alterations, renovations and repairs. Minor additions, alterations, renovations and repairs to existing installations shall meet the provisions for new construction, unless such work is done in the same manner and arrangement as was in the existing system, is not hazardous and is approved.

102.4.2 Special provisions for prior code buildings. In addition to the requirements of Sections 102.4 and 102.4.1, the provisions of Sections ~~[102.4.1.1]~~ 102.4.2.1 through ~~[102.4.1.4]~~ 102.4.2.4 shall apply to prior code buildings.

102.4.2.1 Fuel gas piping in ~~[fire-resistance-rated assemblies]~~ prohibited locations. For prior code buildings, the replacement of existing fuel gas piping in the same locations shall not be subject to Section ~~[404.1, Item 5,]~~ 404.3 when approved by the commissioner.

102.4.2.2 Guards and access to roofs and elevated structures. The provisions of Section 306.6 relating to guards and Section 306.5 relating to permanent means of access shall not apply where the equipment or appliances replace existing equipment or appliances in the same location.

102.4.2.3 Seismic supports. For prior code buildings, the determination as to whether seismic requirements apply to an alteration shall be made in accordance with the *1968 Building Code* and interpretations by the department relating to such determinations. Any applicable seismic loads and requirements shall be permitted to be determined in accordance with Chapter 16 of the *New York City Building Code* or the *1968 Building Code* and Reference Standard RS 9-6 of such code.

102.4.2.4 Wind resistance. For prior code buildings, equipment, appliances and supports that are exposed to wind shall be designed and installed to resist the wind pressures determined in accordance with Chapter 16 of the *New York City Building Code*.

102.5 Change in occupancy. Refer to Chapter 1 of Title 28 of the *Administrative Code*.

102.6 Reserved.

102.7 Reserved.

102.8 Referenced standards. The standards referenced in this code shall be those that are listed in Chapter 8 and in the rules of the department and such standards shall be considered part of the requirements of this code to the prescribed extent of each such reference. Where differences occur between provisions of this code and the referenced standards, the provisions of this code shall apply. Refer to Article 103 of Chapter 1 of Title 28 of the *Administrative Code* for additional provisions relating to referenced standards.

102.8.1 Editions of referenced standards. References to standards in this code shall be to the editions of those standards provided for in Chapter 8 of this code, or as otherwise provided by rule.

102.9 Requirements not covered by code. Requirements necessary for the strength, stability or proper operation of an existing or proposed installation, or for the public safety, health and general welfare, not specifically covered by this code, shall be determined by the commissioner.

102.10 Application of references. Reference to chapter section numbers, or to provisions not specifically identified by number, shall be construed to refer to such chapter, section or provision of this code.

**SECTION FGC 103
DEPARTMENT OF BUILDINGS**

103.1 Enforcement agency. Refer to the New York City Charter and Chapter 1 of Title 28 of the *Administrative Code*.

103.2 Reserved.

103.3 Reserved.

103.4 Reserved.

**SECTION FGC 104
DUTIES AND POWERS OF THE COMMISSIONER
OF BUILDINGS**

104.1 General. The commissioner shall have the authority to render interpretations of this code, ~~and to~~ adopt rules, and establish policies ~~[,]~~ and procedures in order to clarify and implement its provisions. Such interpretations, policies, procedures, and rules shall be in compliance with the intent and purpose of this code. See the New York City Charter and Chapter 1 of Title 28 of the *Administrative Code* for additional provisions relating to the authority of the ~~[Commissioner of Buildings]~~commissioner.

**SECTION FGC 105
APPROVALS**

105.1 Approvals. Refer to Chapter 1 of Title 28 of the *Administrative Code*.

SECTION FGC ~~[405]~~ 106 PERMITS

~~[105.1]~~ **106.1 General.** Permits shall comply with this section, with Article 105 of Chapter 1 of Title 28 of the *Administrative Code*, and with requirements found elsewhere in this code.

~~[105.2]~~ **106.2 Required.** Any owner or authorized agent who intends to construct, add to, alter, repair, move, demolish, or change the occupancy of a building or structure, or to erect, install, add to, alter, repair, remove, convert or replace any gas, mechanical or plumbing system, the installation of which is regulated by this code, or to cause any such work to be done, shall first make application for construction document approval in accordance with Chapter 1 of Title 28 of the *Administrative Code* and this chapter and obtain the required permit.

~~[105.3]~~ **106.3 Work exempt from permit.** Exemptions from permit requirements of this code as authorized in Chapter 1 of Title 28 of the *Administrative Code* and the rules of the department shall not be deemed to grant authorization for any work to be done in any manner in violation of the provisions of this code or any other laws or rules.

~~[105.4]~~ **106.4 Validity of permit.** The issuance or granting of a permit shall not be construed to be a permit for, or an approval of, any violation of any of the provisions of this code or of any other law. Permits presuming to give authority to violate or cancel the provisions of this code or other law shall not be valid. The issuance of a permit based on construction documents and other data shall not prevent the commissioner from requiring the correction of errors in the construction documents and other data. The commissioner is also authorized to prevent occupancy or use of a structure where in violation of this code or of any other law.

~~[105.5]~~ **106.5 Other permits.** In addition to any permits required by the provisions of this code, permits for sidewalk and street openings shall be obtained from the Department of Transportation.

106.6 Permits with respect to limited alteration applications. For permits with respect to limited alteration applications, refer to Sections 28-101.5 and 28-104.6, Exception 1, of the *Administrative Code*.

SECTION FGC ~~[406]~~ 107 CONSTRUCTION DOCUMENTS

~~[106.1]~~ **107.1 General.** Construction documents shall comply with Article 104 of Chapter 1 of Title 28 of the *Administrative Code* and other applicable provisions of this code and its referenced standards. Such construction documents shall be coordinated with architectural, structural and means of egress plans.

~~[106.2]~~ **107.2 Required documents.** The applicant shall submit all of the documents specified in Sections ~~[106.3]~~ 107.3 through ~~[106.8]~~ 107.8 as appropriate to the nature and extent of the work proposed. Construction documents shall indicate the heating, ventilation, refrigeration, and other mechanical work to be performed, so drawn as to conform to the architectural and structural aspects of the building and to show in detail compliance with this code.

[106.2.1] 107.2.1 Composite plans. Composite plans showing compliance of architectural, structural, and mechanical parts of a building may be submitted provided that a clear understanding of each part is not impaired.

[106.3] 107.3 Lot diagram. The lot diagram shall be provided where applicable to the work proposed, including but not limited to the installation of exterior or rooftop equipment.

[106.4] 107.4 Building classification statement. Where applicable to the proposed work, the statement shall identify:

1. The occupancy group or groups that apply to parts of the building code in accordance with Section 302 of the *New York City Building Code*;
2. The occupancy group of the main use or dominant occupancy of the building;
3. The construction ~~[class]~~ type of the building in accordance with Section 602 of the *New York City Building Code*;
4. The structural occupancy/risk category in accordance with Table 1604.5 of the *New York City Building Code*;
5. The height of the building as defined in Section ~~[502.4]~~ 202 of the *New York City Building Code*;
6. The applicable measurements to the highest and lowest level of ~~[fire department]~~ Fire Department access; ~~[and]~~
7. Whether the building is inside or outside of the fire districts ~~[-];~~ and
8. Whether the building is inside or outside a flood hazard area as such term is defined in Chapter 2 of the *New York City Building Code*.

[106.5] 107.5 Fuel-gas-burning appliance and fuel-gas piping plans. Construction documents for fuel-gas-burning appliances and fuel-gas piping shall contain plans that include the following data and information:

1. Riser diagrams showing the story heights, the gas ~~[risers,]~~ riser diameter, operating pressure, gas meter piping and related appliances.
2. Diagrammatic floor plans showing the size, location, and material for all gas distribution piping and related appliances.
3. Floor plans or partial floor plans showing the location, operating pressure, layout, size, and listing information for all gas meter piping, gas distribution piping, fuel-gas burning appliances, gas vents, and chimneys, with the riser numbers coordinated with other plans and diagrams. The floor plans shall indicate locations of meters ~~[-]~~ and shutoff valves, including the outside gas cut-off required by Appendix E, Section E6. The plans shall also indicate the method or means of providing air to the appliance space, including duct and opening sizes, or means of direct venting.

4. Plans indicating the location and type of any relevant smoke and heat detectors, alarm and fire-extinguishing systems.
5. Seismic protection and restraint details for piping and appliances as required by Chapter 16 of the *New York City Building Code*.
6. Details indicating the location, size and materials for all breechings; the thickness and type of insulation materials; and the clearances from combustible walls, partitions and ceiling; and the fire-resistive ratings of rooms and spaces containing the appliances.
7. Details describing the type, material, listing information, height, and termination distances to adjacent properties and structures for chimneys and gas vents.
8. Details showing structural supports for fuel-gas-burning equipment where required.
9. In [~~areas of special~~] flood [~~hazards~~] hazard areas, construction documents shall comply with Appendix G of the *New York City Building Code*.

[106.6] 107.6 Heating systems. Construction documents for heating systems shall include the temperature to be maintained in every room and the output capacity in BTU per hour (W) of the central heating source.

[106.7] 107.7 Boilers. Construction documents for boiler installations shall indicate the output capacity in BTU per hour (W), the operating weight of each boiler, the pressure setting of the relief valves, and such other data and information as required by this code.

[106.8] 107.8 Energy efficiency. Construction documents shall include compliance documentation as required by the *New York City Energy Conservation Code*.

107.9 Retention of construction and submittal documents. Refer to Section 28-104.12 of the *Administrative Code*.

SECTION FGC [407] 108 INSPECTIONS AND TESTING

[107.1] 108.1 General. Except as otherwise specified in Section 28-116.2.4.3 of the *Administrative Code*, inspections required by this code or by the department during the progress of work may be performed on behalf of the owner by approved agencies or, if applicable, by special inspectors. However, in the interest of public safety, the commissioner may direct that any of such inspections be performed by the department. All inspections shall be performed at the sole cost and expense of the owner. Refer to Article 116 of Chapter 1 of Title 28 of the *Administrative Code* for additional provisions relating to inspections.

[107.2] 108.2 Required inspections and testing. In addition to any inspections otherwise required by this code or applicable rules, the following inspections shall be required:

1. **Progress inspections.**

- 1.1. Underground inspection and/or testing of installed piping, valves, fittings, support structures, anti-corrosion equipment and associated underground components shall be made [after trenches or ditches are excavated and bedded, piping is installed and] before backfill is put in place. When excavated soil contains rocks, broken concrete, frozen chunks and other rubble that would damage or break the piping or cause corrosive action, clean backfill shall be on the job site ready for use in backfilling.
- 1.2. Rough-in inspection shall be made to determine that the materials, design, fabrication and installation comply with all requirements of this code. The inspection shall be conducted after the roof, framing, fireblocking and bracing are in place and components to be concealed are complete, and prior to the installation of wall or ceiling membranes. The inspection shall be conducted prior to or in conjunction with the gas pressure test. This inspection may be completed in sections.

Exceptions:

1. A rough-in inspection shall not be required when an existing gas appliance is replaced, provided that (i) no gas piping is replaced upstream of the existing appliance shutoff valve, and (ii) not more than 6 feet (1828.8 mm) of pipe is installed or replaced downstream of the existing appliance shutoff valve.
 2. A rough-in inspection shall not be required when gas is reestablished by a utility company as permitted under Section 28-105.4.1 of the *Administrative Code*.
- 1.3. Inspections required by the *New York City Energy Conservation Code* shall be made in accordance with rules of the department, as applicable.
 - 1.4. Gas final inspections shall be conducted after all appliances are installed, vented, wired and ready to operate with the establishment of gas. Gas final inspections shall include, but not be limited to, an inspection of components downstream of the appliance shutoff valve including gas piping, appliances, vents, accessory piping and make up air. Gas final inspections may be completed in sections.
2. **Special inspections.** Special inspections shall be performed in accordance with this code and Chapter 17 of the *New York City Building Code*.
 3. **Periodic inspections.** Periodic inspections of gas piping systems shall be conducted in accordance with Article 318 of Chapter 3 of Title 28 of the *Administrative Code*.
 - [3.] 4. **Final inspection.** Refer to Article 116 of Chapter 1 of Title 28 of the *Administrative Code*.

[4.] 5. Issuance of certificate of compliance: Upon satisfactory inspection of service equipment and the satisfaction of all the requirements for sign-off, the department shall issue a certificate of compliance as applicable for the following service equipment:

[4.1.] 5.1. Fuel-gas-burning equipment,

[4.2.] 5.2. Heating systems, and

[4.3.] 5.3. Boilers.

The requirements of Section 108.2 shall not be considered to prohibit the operation of any heating equipment or appliances installed to replace existing heating equipment or appliances serving an occupied portion of a structure provided that a request for inspection of such heating equipment or appliances has been filed with the department not more than 48 hours after such replacement work is completed, and all required inspections are performed before any portion of such equipment or appliances is concealed by any permanent portion of the structure.

[107.2.1] 108.2.1 Approved inspection agencies. Refer to Articles 114 and 115 of Chapter 1 of Title 28 of the *Administrative Code*.

[107.2.2] 108.2.2 Inspection of prefabricated construction assemblies. Prior to the approval of a prefabricated construction assembly having concealed work and the issuance of a permit, the department shall require the submittal of an evaluation report by an approved agency on each prefabricated construction assembly, indicating the complete details of the installation, including a description of the system and its components, the basis upon which the system is being evaluated, test results and similar information and other data as necessary for the commissioner to determine conformance to this code.

[107.2.2.1] 108.2.2.1 Test and inspection records. Required test and inspection records shall be available to the commissioner at all times during the fabrication of the installation and the erection of the building; or such records as the commissioner designates shall be filed.

[107.2.3] 108.2.3 Exposure of work. ~~[It shall be the duty of the permit holder to cause the]~~ The work ~~[to]~~ shall remain accessible and exposed for inspection purposes. Neither the commissioner nor the city shall be liable for expense entailed in the removal or replacement of any material required to allow inspection.

[107.3] 108.3 Testing. Installations shall be tested as required in this code and in accordance with Sections ~~[107.3.1] 108.3.1~~ through ~~[107.3.3] 108.3.3~~. Tests shall be made by the permit holder and witnessed by the department ~~[or an approved agency]~~.

[107.3.1] 108.3.1 New, altered, extended or repaired installations. New installations and parts of existing installations that have been altered, extended, renovated or repaired, shall be tested as prescribed herein to disclose leaks and defects.

Exceptions:

1. A gas test shall not be required when an existing gas appliance is replaced, provided that (i) no gas piping is replaced upstream of the existing appliance shutoff valve and (ii) not more than 6 feet (1828.8 mm) of pipe is installed or replaced downstream of the existing appliance shutoff valve.
2. A gas test shall not be required when gas is reestablished by a utility company as permitted under section 28-105.4.1 of the *Administrative Code*.

[107.3.2] 108.3.2 Apparatus, instruments, material and labor for tests. Apparatus, instruments, material and labor required for testing an installation or part thereof shall be furnished by the permit holder.

[107.3.3] 108.3.3 Reinspection and testing. Where any work or installation does not pass an initial test or inspection, the necessary corrections shall be made ~~[so as to achieve compliance]~~ to comply with this code. The work or installation shall then be resubmitted to the department for inspection and testing.

108.3.4 Test validity. A gas test that is accepted by the department shall be valid for a period of one year from the date of the test.

[107.4] 108.4 Sign-off of completed work. Refer to Article 116 of Chapter 1 of Title 28 of the *Administrative Code*.

[107.5] 108.5 Temporary connection. The commissioner shall have the authority to allow the temporary connection of an installation to the sources of energy for the purpose of testing the installation or for use under a temporary certificate of occupancy.

SECTION FGC ~~108~~ 109 VIOLATIONS

[108.1] 109.1 General. Refer to Chapters 2 and 3 of Title 28 of the *Administrative Code*.

[108.2] 109.2 Authority to disconnect service utilities. The commissioner shall have the authority to require disconnection of utility service to the building, structure or system regulated by the technical codes in case of emergency where necessary to eliminate an immediate hazard to life or property. The commissioner shall notify the serving utility, and wherever possible, the owner and occupant of the building, structure or service system of the decision to disconnect prior to taking such action. If not notified prior to disconnection, the owner or occupant of the building, structure or service system shall be notified in writing, as soon as practicable thereafter.

[108.3] 109.3 Connection after order to disconnect. A person shall not make energy source connections to installations regulated by this code that have been disconnected or ordered to be disconnected by the commissioner, or the use of which has been ordered to be discontinued by the commissioner until the commissioner authorizes the reconnection and use of such installations. When an installation is maintained in violation of this code, and in violation of a notice issued pursuant to the provisions of this section, the commissioner shall institute appropriate action to prevent, restrain, correct or abate the violation.

§ 3. Chapter 2 of the New York city fuel gas code, as added by local law number 33 for the year 2007, the definitions of “BTU” and “demand” as amended by local law number 8 for the year 2008, and the definitions of “connector” and “chimney or vent” as added by local law number 51 for the year 2014, is amended to read as follows:

CHAPTER 2

DEFINITIONS

SECTION FGC 201

GENERAL

201.1 Scope. Unless otherwise expressly stated, the following words and terms shall, for the purposes of this code and standard, have the meanings indicated in this chapter.

201.2 Interchangeability. Words used in the present tense include the future; words in the masculine gender include the feminine and neuter; the singular number includes the plural and the plural, the singular.

201.3 Terms defined in other codes. Where terms are not defined in this code and are defined in the *New York City Electrical Code*, *New York City Building Code*, *New York City Fire Code*, *New York City Mechanical Code* [ø], *New York City Plumbing Code*, or the New York City Energy Conservation Code, such terms shall have meanings ascribed to them as in those codes.

201.3.1 Terms defined in the general administrative provisions. The following terms are defined in Section 28-101.5 of the *Administrative Code*:

1968 BUILDING CODE.

1968 OR PRIOR CODE BUILDINGS OR STRUCTURES (PRIOR CODE BUILDINGS).

ACCEPTANCE OR ACCEPTED.

ADDITION.

ADMINISTRATIVE CODE.

ALTERATION.

APPROVAL OR APPROVED.

APPROVED AGENCY.

APPROVED FABRICATOR.

APPROVED INSPECTION AGENCY.

APPROVED TESTING AGENCY.

ARCHITECT.

BUILDING.

CHARTER.

CERTIFICATE OF COMPLIANCE.

CITY.

COMMISSIONER.

CONSTRUCTION DOCUMENTS.

DAY.

DEFERRED SUBMITTAL.

DEMOLITION.

DEMOLITION, FULL.

DEMOLITION, PARTIAL.

DEPARTMENT.

ENGINEER.

ENLARGEMENT.

ENVIRONMENTAL CONTROL BOARD or ECB.

EXISTING BUILDING OR STRUCTURE.

FABRICATED ITEM.

FIRE PROTECTION PLAN.

HEREAFTER.

HERETOFORE.

INSPECTION CERTIFICATE.

INTERIM CERTIFICATE OF OCCUPANCY.

LABEL.

LABELED.

LAND SURVEYOR.

LANDSCAPE ARCHITECT.

LETTER OF COMPLETION.

LIMITED ALTERATION APPLICATION.

LIMITED PLUMBING ALTERATIONS.

LIMITED SPRINKLER ALTERATIONS.

LIMITED STANDPIPE ALTERATIONS.

LISTED.

MAIN USE OR DOMINANT OCCUPANCY (OF A BUILDING).

MANUFACTURER'S DESIGNATION.

MARK.

MATERIALS.

OCCUPANCY.

OWNER.

PARTY WALL.

PERMIT.

PERSON.

PREMISES.

PRIOR CODE BUILDING.

PROFESSIONAL CERTIFICATION.

PROGRESS INSPECTION.

PROJECT.

REGISTERED DESIGN PROFESSIONAL.

REGISTERED DESIGN PROFESSIONAL OF RECORD.

REQUIRED.

RETAINING WALL.

SERVICE EQUIPMENT.

SIGN-OFF.

SINGLE ROOM OCCUPANCY MULTIPLE DWELLING.

SPECIAL INSPECTION.

SPECIAL INSPECTION AGENCY.

SPECIAL INSPECTOR.

STRUCTURE.

SUBMITTAL DOCUMENTS.

SUPERINTENDENT OF CONSTRUCTION (CONSTRUCTION SUPERINTENDENT).

USE (USED).

UTILITY COMPANY OR PUBLIC UTILITY COMPANY.

UTILITY CORPORATION OR PUBLIC UTILITY CORPORATION.

WORK NOT CONSTITUTING MINOR ALTERATIONS OR ORDINARY REPAIRS.

WRITING (WRITTEN).

WRITTEN NOTICE.

ZONING RESOLUTION.

201.4 Terms not defined. Where terms are not defined through the methods authorized by this section, such terms shall have ordinarily accepted meanings such as the context implies.

SECTION FGC 202 GENERAL DEFINITIONS

~~[1968 OR PRIOR CODE BUILDINGS OR STRUCTURES (PRIOR CODE BUILDINGS). See Section 28-101.5 of the *Administrative Code*.]~~

ABNORMAL OPERATING CONDITION. A condition that may indicate a malfunction or a noncompliant component of a piping system or appliance.

ACCESS (TO). That which enables a device, fixture, appliance or equipment to be reached by ready access or by a means that first requires the removal or movement of a panel, door or similar obstruction (see also “Ready access (to)”).

~~[**ADMINISTRATIVE CODE.** The *Administrative Code* of the City of New York.]~~

AIR CONDITIONER, GAS-FIRED. A gas-burning, automatically operated appliance for supplying cooled ~~[and/]~~ or dehumidified air or chilled liquid.

AIR CONDITIONING. The treatment of air so as to control simultaneously the temperature, humidity, cleanness and distribution of the air to meet the requirements of a conditioned space.

AIR, EXHAUST. See “Exhaust”. ~~[Air being removed from any space or piece of equipment or appliance and conveyed directly to the atmosphere by means of openings or ducts.]~~

AIR-HANDLING UNIT. A blower or fan used for the purpose of distributing supply air to a room, space or area.

AIR, MAKEUP. ~~[Air that is provided]~~ Any combination of outdoor and transfer air intended to replace exhaust air [being exhausted] and exfiltration.

~~[**ALTERATION.** Any construction, addition, change of use or occupancy, or renovation to a building or structure in existence. See Section 28-101.5 of the *Administrative Code*.]~~

~~[**ANODELESS RISER.** A transition assembly in which plastic piping is installed and terminated above ground outside of a building.]~~

APPLIANCE. Any apparatus or device that utilizes ~~[gas as]~~ a fuel or raw material to produce light, heat, power, refrigeration or air conditioning.

APPLIANCE, AUTOMATICALLY CONTROLLED. Appliances equipped with an automatic burner ignition and safety shutoff device and other automatic devices which accomplish complete turn-on and shutoff of the gas to the main burner or burners, and graduate the gas supply to the burner or burners, but do not affect complete shutoff of the gas.

~~[**APPLIANCE, FAN-ASSISTED COMBUSTION.** An appliance equipped with an integral mechanical means to either draw or force products of combustion through the combustion chamber or heat exchanger.]~~

APPLIANCE TYPE.

Low-heat appliance (residential appliance). Any appliance in which the products of combustion at the point of entrance to the flue under normal operating conditions have a temperature of 1,000°F (538°C) or less.

Medium-heat appliance. Any appliance in which the products of combustion at the point of entrance to the flue under normal operating conditions have a temperature of more than 1,000°F (538°C) or less but not greater than 2,000°F (~~[4093]~~ 1093.3°C).

APPLIANCE, UNVENTED. An appliance designed or installed in such a manner that the products of combustion are not conveyed by a vent or chimney directly to the outdoor atmosphere.

APPLIANCE, VENTED. An appliance designed and installed in such a manner that all of the products of combustion are conveyed directly from the appliance to the outdoor atmosphere through an approved chimney or vent system. See also “VENTED APPLIANCE CATEGORIES.”

~~[**APPROVED.** In reference to construction documents, the determination by the department after full examination that submitted construction documents comply with this code and other applicable laws and rules. In reference to materials, the determination by the commissioner that material is acceptable for its intended use. See Section 28-101.5 of the *Administrative Code.*]~~

~~[**APPROVED AGENCY.** An established and recognized agency, or other qualified person, engaged in conducting tests or furnishing inspection services, when approved pursuant to department rules as qualified to perform or witness identified testing or inspection services. See Chapter 1 of Title 28 of the *Administrative Code.*]~~

~~[**APPROVED INSPECTION AGENCY.** An approved agency that is approved by the department as qualified to perform one or more of the inspections required by this code. See Chapter 1 of Title 28 of the *Administrative Code.*]~~

~~[**APPROVED TESTING AGENCY.** An approved agency that is approved by the department as qualified to test and evaluate the performance of one or more of the materials regulated in their use by this code. Such term shall include, when approved pursuant to department rules, a third party testing or certification agency, evaluation agency, testing laboratory, testing service, licensed concrete testing laboratory or other entity concerned with product evaluation. See Chapter 1 of Title 28 of the *Administrative Code.*]~~

~~[**ARCHITECT.** A person licensed and registered to practice the profession of architecture under the Education Law of the State of New York.]~~

ATMOSPHERIC PRESSURE. The pressure of the weight of air and water vapor on the surface of the earth, approximately 14.7 pounds per square inch (psi) (101 kPa absolute) at sea level.

~~[**AUTOMATIC IGNITION.** Ignition of gas at the burner(s) when the gas controlling device is turned on, including reignition if the flames on the burner(s) have been extinguished by means other than by the closing of the gas controlling device.]~~

BAFFLE. An object placed in an appliance to change the direction of or retard the flow of air, air-gas mixtures or flue gases.

BAROMETRIC DRAFT REGULATOR. A balanced damper device attached to a chimney, vent connector, breeching or flue gas manifold to protect combustion appliances by controlling chimney draft. A double-acting barometric draft regulator is one in which the balancing damper is free to move in either direction to protect combustion appliances from both excessive draft and backdraft.

BOILER, HIGH-PRESSURE. An appliance for supplying steam or hot water that, for a steam boiler, operates at a pressure of more than 15 psig (~~[103]~~ 103.4 kPa gauge), and for a hot water boiler, operates

at a pressure exceeding 160 psig ([4034] 1103 kPa gauge) or at a temperature exceeding 250°F ([424]121.1°C).

BOILER, LOW-PRESSURE. A self-contained appliance for supplying steam or hot water as follows:

Hot water heating boiler. A boiler in which no steam is generated, from which hot water is circulated for heating purposes and then returned to the boiler, and that operates at water pressures not exceeding 160 pounds per square inch gauge (psig) (1103 kPa gauge) and at water temperatures not exceeding 250°F ([424]121.1°C) at or near the boiler outlet.

Hot water supply boiler. A boiler, completely filled with water, which furnishes hot water to be used externally to itself, and that operates at water pressures not exceeding 160 psig (1103 kPa gauge) and at water temperatures not exceeding 250°F ([424]121.1°C) at or near the boiler outlet.

Steam heating boiler. A boiler in which steam is generated and that operates at a steam pressure not exceeding 15 psig ([403] 103.4 kPa gauge).

BRANCH. A section of gas piping downstream from a riser, leading to appliances or equipment on no more than two consecutive floors.

BRAZING. A metal-joining process wherein coalescence is produced by the use of a nonferrous filler metal having a melting point above 1,000°F ([538]537.8°C), but lower than that of the base metal being joined. The filler material is distributed between the closely fitted surfaces of the joint by capillary action.

BROILER. A general term including salamanders, barbecues and other appliances cooking primarily by radiated heat, excepting toasters.

BTU. Abbreviation for British thermal unit, which is the quantity of heat required to raise the temperature of 1 pound (454 g) of water 1°F ([0.56]-17.2°C) (1 Btu = 1055 J).

BURNER. A device for the final conveyance of the gas, or a mixture of gas and air, to the combustion zone.

~~[Induced-draft]~~ **Induced draft.** A burner that depends on draft induced by a fan that is an integral part of the appliance and is located downstream from the burner.

Power. A burner in which gas, air or both are supplied at pressures exceeding, for gas, the line pressure, and for air, atmospheric pressure, with this added pressure being applied at the burner.

CHIMNEY. A primarily vertical structure containing one or more flues [~~for the purpose of carrying gaseous products of combustion and air~~] used to remove hot gases from burning fuel, refuse, or industrial processes from a fuel-burning appliance to the [~~outside~~] outdoor atmosphere.

Factory-built chimney. A listed and labeled chimney composed of factory-made components, assembled in the field in accordance with manufacturer's instructions and the conditions of the listing.

Masonry chimney. A field-constructed chimney composed of solid masonry units, bricks, stones or concrete.

Metal chimney. A field-constructed chimney composed of metal.

~~[**CHIMNEY CONNECTOR.** A pipe that connects a fuel-burning appliance to a chimney.]~~

CLEARANCE. The minimum distance through air measured between the heat-producing surface of the mechanical appliance, device or equipment and the surface of the combustible material or assembly.

CLOTHES DRYER. An appliance used to dry wet laundry by means of heated air. Dryer classifications are as follows:

Type 1. Factory-built package, multiple production. Primarily used in family living environment. Usually the smallest unit physically and in function output.

Type 2. Factory-built package, multiple production. Used in business with direct intercourse of the function with the public. Not designed for use in individual family living environment.

COMBUSTIBLE ASSEMBLY. Wall, floor, ceiling or other assembly constructed of one or more component materials that are not defined as noncombustible.

COMBUSTIBLE MATERIAL. Any material not defined as noncombustible.

COMBUSTION. In the context of this code, refers to the rapid oxidation of fuel accompanied by the production of heat or heat and light.

COMBUSTION AIR. Air necessary for complete combustion of a fuel, including theoretical air and excess air.

COMBUSTION CHAMBER. The portion of an appliance within which combustion occurs.

COMBUSTION PRODUCTS. Constituents resulting from the combustion of a fuel with the oxygen of the air, including inert gases, but excluding excess air.

~~[**COMMISSIONER.** The Commissioner of buildings of the City of New York or his or her duly authorized representative. See Section 28-101.5 of the *Administrative Code*.]~~

CONCEALED LOCATION. A location that cannot be accessed without damaging permanent parts of the building structure or finished surface. Spaces above, below or behind readily removable panels or doors shall not be considered as concealed.

CONCEALED PIPING. Piping that is located in a concealed location (see “Concealed Location”).

CONDENSATE. The liquid that condenses from a gas (including flue gas) caused by a reduction in temperature or increase in pressure.

CONNECTOR, APPLIANCE (Fuel). Rigid metallic pipe and fittings or a listed and labeled device that connects an appliance to the gas piping system.

~~[**CONNECTOR, CHIMNEY OR VENT.** The pipe that connects an appliance to a chimney or vent.~~
~~[]~~

~~[CONSTRUCTION DOCUMENTS. Plans and specifications and other written, graphic and pictorial documents prepared or assembled for describing the design, location, physical characteristics and other elements of the project necessary for obtaining a building permit. See Section 28-101.5 of the Administrative Code.]~~

CONTROL. A manual or automatic device designed to regulate the gas, air, water or electrical supply to, or operation of, a mechanical system.

CONVERSION BURNER. A unit consisting of a burner and its controls for installation in an appliance originally utilizing another fuel.

COUNTER APPLIANCES. Appliances such as coffee brewers and coffee urns and any appurtenant water-heating appliance, food and dish warmers, hot plates, griddles, waffle bakers and other appliances designed for installation on or in a counter.

CUBIC FOOT. The amount of gas that occupies 1 cubic foot (0.02832 m³) when at a temperature of 60°F ([~~46~~]15.6°C), saturated with water vapor and under a pressure equivalent to that of 30 inches of mercury (101 kPa).

DAMPER. A manually or automatically controlled device to regulate draft or the rate of flow of air or combustion gases.

DECORATIVE APPLIANCE, VENTED. A vented appliance wherein the primary function lies in the aesthetic effect of the flames.

DECORATIVE APPLIANCES FOR INSTALLATION IN VENTED FIREPLACES. A vented appliance designed for installation within the fire chamber of a vented fireplace, wherein the primary function lies in the aesthetic effect of the flames.

DECORATIVE SHROUD. A listed, partial, noncombustible enclosure for aesthetic purposes that is installed at the termination of a venting system that surrounds or conceals [~~the chimney~~] a factory-built chimney system or vent cap.

DEMAND. The maximum amount of gas input required per unit of time, usually expressed in cubic feet per hour (1 ft³ = 0.0283 m³), or Btu/h (1 Btu/h = 0.2931 W).

DILUTION AIR. Air that is introduced into a draft hood and is mixed with the flue gases.

DIRECT-VENT APPLIANCES. Appliances that are constructed and installed so that all air for combustion is derived directly from the [~~outside~~] outdoor atmosphere and all flue gases are discharged directly to the [~~outside~~] outdoor atmosphere.

DRAFT. The pressure difference existing between the appliance or any component part and the atmosphere, that causes a continuous flow of air and products of combustion through the gas passages of the appliance to the atmosphere.

~~[Mechanical or induced]~~ **Induced draft.** The pressure difference created by the action of a fan, blower or ejector, that is located between the appliance and the chimney or vent termination.

Natural draft. The pressure difference created by a vent or chimney because of its height, and the temperature difference between the flue gases and the atmosphere.

DRAFT HOOD. A nonadjustable device built into an appliance, or made as part of the vent connector from an appliance, that is designed to (1) provide for ready escape of the flue gases from the appliance in the event of no draft, backdraft or stoppage beyond the draft hood, (2) prevent a backdraft from entering the appliance, and (3) neutralize the effect of stack action of the chimney or gas vent upon operation of the appliance.

DRAFT REGULATOR. A device that functions to maintain a desired draft in the appliance by automatically reducing the draft to the desired value.

DRIP. A nipple and cap placed at a low point in a system of piping to collect condensate and from which the condensate is removable.

DRY GAS. A gas having a moisture and hydrocarbon dew point below any normal temperature to which the gas piping is exposed.

DUCT FURNACE. A warm-air furnace or heater normally installed in an air distribution duct to supply warm air for heating. This definition shall apply only to a warm-air heating appliance that, ~~[depends]~~ for air circulation, depends on a blower not furnished as part of the furnace.

DUCT SYSTEM. A continuous passageway for the transmission of air that, in addition to ducts, includes duct fittings, dampers, plenums, fans and accessory air-handling equipment and appliances.

DWELLING. A building or structure which is occupied in whole or in part as the home, residence or sleeping place of one or more families.

DWELLING UNIT. A single unit consisting of one or more habitable rooms and occupied or arranged to be occupied as a unit separate from all other units within a dwelling.

~~[ENGINEER. A person licensed and registered to practice the profession of engineering under the Education Law of the State of New York.]~~

EQUIPMENT. Any apparatus or device that delivers gas as a fuel or raw material to an appliance or vents combustion products from an appliance, including but not limited to control devices, pressure regulators, valves, appliance appurtenances, gas connectors, or power exhausters used in connections to appliances.

EXCESS FLOW VALVE (EFV). A safety shut-off valve designed to activate to interrupt the flow of gas when the fuel gas passing through it exceeds a prescribed flow rate. Installed where specifically required by code or utility company.

EXHAUST. Air being removed from any space, appliance or piece of equipment conveyed directly to the atmosphere by means of openings or ducts.

EXTERIOR MASONRY CHIMNEYS. Masonry chimneys exposed to the outdoors on one or more sides below the roof line.

FIREPLACE. ~~[A fire chamber and hearth constructed of noncombustible material for use with solid fuels and provided with a chimney.]~~ An assembly consisting of a hearth and fire chamber of noncombustible material and provided with a chimney, for use with solid fuels.

Factory-built fireplace. ~~[A fireplace composed of listed factory built components assembled in accordance with the terms of listing to form the completed fireplace.]~~ A listed and labeled fireplace and chimney system composed of factory-made components, and assembled in the field in accordance with manufacturer's instructions and the conditions of the listing.

Masonry fireplace. A hearth and fire chamber of solid masonry units such as bricks, stones, listed masonry units or reinforced concrete, provided with a suitable chimney.

~~**[FIRING VALVE.** A valve of the plug and barrel type designed for use with gas, and equipped with a lever handle for manual operation and a dial to indicate the percentage of opening.]~~

FLAME SAFEGUARD. A device that will automatically shut off the fuel supply to a main burner or group of burners when the means of ignition of such burners becomes inoperative, and when flame failure occurs on the burner or group of burners.

FLASHBACK ARRESTOR CHECK VALVE. A device that will prevent the backflow of one gas into the supply system of another gas and prevent the passage of flame into the gas supply system.

FLOOR FURNACE. A completely self-contained furnace suspended from the floor of the space being heated, taking air for combustion from outside such space and with means for observing flames and lighting the appliance from such space.

Fan type. A floor furnace equipped with a fan ~~[which]~~ that provides the primary means for circulating air.

Gravity type. A floor furnace depending primarily on circulation of air by gravity. This classification shall also include floor furnaces equipped with booster-type fans ~~[which]~~ that do not materially restrict free circulation of air by gravity flow when such fans are not in operation.

FLUE. A passageway within a chimney or vent through which gaseous combustion products pass.

FLUE, APPLIANCE. The passage(s) within an appliance through which combustion products pass from the combustion chamber of the appliance to the draft hood inlet opening on an appliance equipped with a draft hood or to the outlet of the appliance on an appliance not equipped with a draft hood.

FLUE COLLAR. That portion of an appliance designed for the attachment of a draft hood, vent connector or venting system.

FLUE GASES. Products of combustion plus excess air in fireplace and appliance flues or heat exchangers.

FLUE LINER (LINING). A system or material used to form the inside surface of a flue in a chimney or vent, for the purpose of protecting the surrounding structure from the effects of combustion products and for conveying combustion products without leakage into the atmosphere.

FUEL GAS. A natural gas, manufactured gas, liquefied petroleum gas or mixtures of these gases.

~~[FUEL GAS UTILIZATION EQUIPMENT. See “Appliance.”]~~

FURNACE. A completely self-contained heating unit that is designed to supply heated air to spaces remote from or adjacent to the appliance location.

FURNACE, CENTRAL. A self-contained appliance for heating air by transfer of heat of combustion through metal to the air, and designed to supply heated air through ducts to spaces remote from or adjacent to the appliance location.

~~[Downflow furnace. A furnace designed with airflow discharge vertically downward at or near the bottom of the furnace.]~~

~~[Forced-air furnace with cooling unit. A single package unit, consisting of a gas-fired forced-air furnace of one of the types listed below combined with an electrically or fuel gas-powered summer air conditioning system, contained in a common casing.]~~

Forced-air type. A central furnace equipped with a fan or blower [~~which~~] that provides the primary means for circulation of air.

~~[Gravity furnace with booster fan. A furnace equipped with a booster fan that does not materially restrict free circulation of air by gravity flow when the fan is not in operation.]~~

~~[Gravity type. A central furnace depending primarily on circulation of air by gravity.]~~

~~[Horizontal forced-air type. A furnace with airflow through the appliance essentially in a horizontal path.]~~

~~[Multiple-position furnace. A furnace designed so that it can be installed with the airflow discharge in the upflow, horizontal or downflow direction.]~~

~~[Upflow furnace. A furnace designed with airflow discharge vertically upward at or near the top of the furnace. This classification includes “highboy” furnaces with the blower mounted below the heating element and “lowboy” furnaces with the blower mounted beside the heating element.]~~

~~[FURNACE, ENCLOSED. A specific heating, or heating and ventilating, furnace incorporating an integral total enclosure and using only outside air for combustion.]~~

FURNACE PLENUM. An air compartment or chamber to which one or more ducts are connected and [~~which~~] that forms part of an air distribution system.

GAS CONVENIENCE OUTLET. A permanently mounted, manually operated device that provides the means for connecting an appliance to, and disconnecting an appliance from, the supply piping. The device includes an integral, manually operated valve with a nondisplaceable valve member and is designed so that disconnection of an appliance only occurs when the manually operated valve is in the closed position.

GAS PIPING. An installation of pipe, valves or fittings installed on a premises or in a building and utilized to convey fuel gas.

GAS UTILIZATION EQUIPMENT. An appliance that utilizes gas as a fuel or raw material or both.

HAZARDOUS LOCATION. Any location considered to be a fire hazard for flammable vapors, dust, combustible fibers or other highly combustible substances. The location is not necessarily categorized in the *New York City Building Code* as a high-hazard group classification.

HOUSE PIPING. See “Piping system.”

HYDROGEN FUEL GAS ROOM. A separately ventilated, fully enclosed room designed to exclusively house the generation of gaseous hydrogen for immediate on-premises use in indoor fuel cells or other energy production process, and incidental indoor storage of gaseous hydrogen. A hydrogen fuel gas room is not intended to house the production or dispensing of hydrogen motor fuel.

~~**[IGNITION PILOT.** A pilot that operates during the lighting cycle and discontinues during main burner operation.]~~

IGNITION SOURCE. A flame, spark or hot surface capable of igniting flammable vapors or fumes. Such sources include appliance burners, burner ignitors, and electrical switching devices.

INCINERATOR. An appliance used to reduce combustible refuse material to ashes and ~~[which]~~ that is manufactured, sold and installed as a complete unit.

INDUSTRIAL AIR HEATERS, NONRECIRCULATING DIRECT-FIRED

~~**[NONRECIRCULATING].**~~ A heater in which all the products of combustion generated by the burners are released into the air stream being heated. The purpose of the heater is to offset building heat loss by heating only outdoor air.

INDUSTRIAL AIR HEATERS, RECIRCULATING DIRECT-FIRED ~~[RECIRCULATING].~~ A heater in which all the products of combustion generated by the burners are released into the air stream being heated. The purpose of the heater is to offset building heat loss by heating outdoor air, and, if applicable, indoor air.

INFRARED RADIANT HEATER. A heater that directs a substantial amount of its energy output in the form of infrared radiant energy into the area to be heated. Such heaters are of either the vented or unvented type.

INTEGRAL VENT APPLIANCES. Appliances designed for outdoor installation that have built-in natural or mechanical venting means and are constructed and installed so that all air for combustion is derived from the outdoor atmosphere and all flue gases are discharged to the outdoor atmosphere through an integral vent termination.

INTERLOCK. A device actuated by another device with which it is directly associated, to govern succeeding operations of the same or allied devices. A circuit in which a given action cannot occur until after one or more other actions have taken place.

JOINT, FLANGED. A joint made by bolting together a pair of flanged ends.

JOINT, FLARED. A metal-to-metal compression joint in which a conical spread is made on the end of a tube that is compressed by a flare nut against a mating flare.

JOINT, MECHANICAL. A general form of gas-tight joints obtained by the joining of metal parts through a positive-holding mechanical construction, such as press joint, flanged joint, threaded joint, flared joint or compression joint.

JOINT, PLASTIC ADHESIVE. A joint made in thermoset plastic piping by the use of an adhesive substance [~~which~~] that forms a continuous bond between the mating surfaces without dissolving either one of them.

JOINT, PLASTIC HEAT FUSION. A joint made in thermoplastic piping by heating the parts sufficiently to permit fusion of the materials when the parts are pressed together.

JOINT, WELDED. A gas-tight joint obtained by the joining of metal parts in molten state.

~~[**LABEL.** Identification applied to material by the manufacturer or an approved agency that contains the name of the manufacturer, the function and performance characteristics of the material, and the name and identification of the approved agency that conducted the evaluation of a representative sample of such material.]~~

~~[**LABELED.** Equipment, appliances, material or products to which has been attached a label, symbol or other identifying mark of the manufacturer that contains the name of the manufacturer, the function and performance characteristics of the equipment, appliances, material or products, and the name and identification of an approved agency and that indicates that a representative sample of the equipment, appliances, material, or products has been tested and evaluated by an approved agency for compliance with nationally recognized standards or tests to determine suitable usage in a specified manner. See Section 28-101.5 of the Administrative Code.]~~

LEAK CHECK. An operation performed on a gas piping system to verify that the system does not leak. Leakage checks are intended to discover open outlets, defective appliance connection and defects that have developed since the initial installation, normally performed after pressure testing.

LIMIT CONTROL. A device responsive to changes in pressure, temperature or level for turning on, shutting off or throttling the gas supply to an appliance.

LIQUEFIED PETROLEUM GAS or LPG (LP-GAS). Liquefied petroleum gas composed predominately of propane, propylene, butanes or butylenes, or mixtures thereof that is gaseous under normal atmospheric conditions, but is capable of being liquefied under moderate pressure at normal temperatures.

~~[**LISTED.** Material identified in a list published by an approved agency that maintains periodic inspection of production of listed material or periodic evaluation of services and whose listing states either that the material meets identified nationally recognized standards or has been tested and found suitable for a specified purpose when installed in accordance with the manufacturer's installation instructions. See Section 28-101.5 of the Administrative Code.]~~

LIVING SPACE. Space within a dwelling unit utilized for living, sleeping, eating, cooking, bathing, washing and sanitation purposes.

LOG LIGHTER. A manually operated solid fuel ignition appliance for installation in a vented solid fuel-burning fireplace.

~~[LUBRICATED PLUG-TYPE VALVE. A valve of the plug and barrel type provided with means for maintaining a lubricant between the bearing surfaces.]~~

MAIN BURNER. A device or group of devices essentially forming an integral unit for the final conveyance of gas or a mixture of gas and air to the combustion zone, and in which combustion takes place to accomplish the function for which the appliance is designed.

METER. The instrument installed to measure the volume of gas delivered through it.

~~[MODULATING. Modulating or throttling is the action of a control from its maximum to minimum position in either predetermined steps or increments of movement as caused by its actuating medium.]~~

NPS. An abbreviation for “Nominal pipe size.”

NONCOMBUSTIBLE MATERIALS. Materials that, when tested in accordance with ASTM E 136, have at least three of four specimens tested meeting all of the following criteria:

1. The recorded temperature of the surface and interior thermocouples shall not at any time during the test rise more than 54°F (12.2°C) above the furnace temperature at the beginning of the test.
2. There shall not be flaming from the specimen after the first 30 seconds.
3. If the weight loss of the specimen during testing exceeds 50 percent, the recorded temperature of the surface and interior thermocouples shall not at any time during the test rise above the furnace air temperature at the beginning of the test, and there shall not be flaming of the specimen.

~~[OCCUPANCY. The purpose or activity for which a building or space is used or is designed, arranged or intended to be used.]~~

OFFSET (VENT). A combination of approved bends that makes two changes in direction bringing one section of the vent out of line but into a line parallel with the other section.

ORIFICE. The opening in a cap, spud or other device whereby the flow of gas is limited and through which the gas is discharged to the burner.

OUTLET. The point at which a gas-fired appliance connects to the gas piping system.

OXYGEN DEPLETION SAFETY SHUTOFF SYSTEM (ODS). A system designed to act to shut off the gas supply to the main and pilot burners if the oxygen in the surrounding atmosphere is reduced below a predetermined level.

PILOT. A small flame that is utilized to ignite the gas at the main burner or burners.

PIPING. Where used in this code, “piping” refers to either pipe or tubing, or both.

Pipe. A rigid conduit of iron, steel, copper, brass or plastic.

Tubing. Semirigid conduit of copper, aluminum, plastic or steel.

PIPING SYSTEM. All fuel piping, valves and fittings from the outlet of the point of delivery to the outlets of the appliance shutoff valves.

PLASTIC, THERMOPLASTIC. A plastic that is capable of being repeatedly softened by increase of temperature and hardened by decrease of temperature.

POINT OF DELIVERY. For natural gas systems, the point of delivery is the outlet of the service meter assembly or the outlet of the service regulator or service shutoff valve where a meter is not provided. Where a valve is provided at the outlet of the service meter assembly, such valve shall be considered to be downstream of the point of delivery.

PORTABLE FUEL CELL APPLIANCE. A fuel cell generator of electricity, which is not fixed in place. A portable fuel cell appliance utilizes a cord and plug connection to a grid-isolated load and has an integral fuel supply.

PRESSURE DROP. The loss in pressure due to friction or obstruction in pipes, valves, fittings, regulators and burners.

PRESSURE TEST. An operation performed to verify the gas-tight integrity of gas piping following its installation or modification.

PURGE. To free a gas conduit of air or gas, or a mixture of gas and air.

QUICK-DISCONNECT DEVICE. A hand-operated device that provides a means for connecting and disconnecting an appliance or an appliance connector to a gas supply and that is equipped with an automatic means to shut off the gas supply when the device is disconnected.

READY ACCESS (TO). That which enables a device, fixture, appliance or equipment to be directly reached, without requiring the removal or movement of any panel, door or similar obstruction. (see “Access (to).”).

~~**[REGISTERED DESIGN PROFESSIONAL.** An architect or engineer.]~~

~~**[REGISTERED DESIGN PROFESSIONAL OF RECORD.** The registered design professional who prepared or supervised the preparation of applicable construction documents filed with the department.]~~

REGULATOR. A device for controlling and maintaining a uniform supply pressure, either pounds-to-inches water column (MP regulator) or inches-to-inches water column (appliance regulator).

REGULATOR, GAS APPLIANCE. A pressure regulator for controlling pressure to the manifold of ~~[equipment equipment]~~ the appliance. Types of appliance regulators are as follows:

Adjustable.

1. **Spring type, limited adjustment.** A regulator in which the regulating force acting upon the diaphragm is derived principally from a spring, the loading of which is adjustable over a range of not more than 15 percent of the outlet pressure at the midpoint of the adjustment range.
2. **Spring type, standard adjustment.** A regulator in which the regulating force acting upon the diaphragm is derived principally from a spring, the loading of which is adjustable. The adjustment means shall be concealed.

Multistage. A regulator for use with a single gas whose adjustment means is capable of being positioned manually or automatically to two or more predetermined outlet pressure settings. Each of these settings shall be adjustable or nonadjustable. The regulator may modulate outlet pressures automatically between its maximum and minimum predetermined outlet pressure settings.

Nonadjustable.

1. **Spring type, nonadjustable.** A regulator in which the regulating force acting upon the diaphragm is derived principally from a spring, the loading of which is not field adjustable.
2. **Weight type.** A regulator in which the regulating force acting upon the diaphragm is derived from a weight or combination of weights.

REGULATOR, LINE GAS PRESSURE. A device placed in a gas line between the service pressure regulator and the appliance for controlling, maintaining or reducing the pressure in that portion of the piping system downstream of the device.

REGULATOR, MEDIUM-PRESSURE (MP Regulator). A line pressure regulator that reduces gas pressure from the range of greater than 0.5 psig (3.4 kPa) and less than or equal to 5 psig (34.5 kPa) to a lower pressure.

REGULATOR, PRESSURE. A device placed in a gas line for reducing, controlling and maintaining the pressure in that portion of the piping system downstream of the device.

REGULATOR, SERVICE PRESSURE. A device installed by the serving gas supplier to reduce and limit the service line pressure to delivery pressure.

RELIEF OPENING. The opening provided in a draft hood to permit the ready escape to the atmosphere of the flue products from the draft hood in the event of no draft, back draft [;] or stoppage beyond the draft hood, and to permit air into the draft hood in the event of a strong chimney updraft.

RELIEF VALVE (DEVICE). A safety valve designed to forestall the development of a dangerous condition by relieving either pressure, temperature or vacuum [~~in the hot water supply system~~].

RELIEF VALVE, PRESSURE. An automatic valve that opens and closes a relief vent, depending on whether the pressure is above or below a predetermined value.

RELIEF VALVE, TEMPERATURE.

Manual reset type. A valve that automatically opens a relief vent at a predetermined temperature and that must be manually returned to the closed position.

Reseating or self-closing type. An automatic valve that opens and closes a relief vent, depending on whether the temperature is above or below a predetermined value.

RELIEF VALVE, VACUUM. A valve that automatically opens and closes a vent for relieving a vacuum within the hot water supply system, depending on whether the vacuum is above or below a predetermined value.

RISER, GAS. A vertical pipe supplying fuel gas that extends one full story or more.

ROOM HEATER, UNVENTED. See “Unvented room heater.”

ROOM HEATER, VENTED. See “Vented room heater.”

~~**[ROOM LARGE IN COMPARISON WITH SIZE OF EQUIPMENT THE APPLIANCE.** Rooms having a volume equal to at least 12 times the total volume of a furnace, water heater or air conditioning appliance and at least 16 times the total volume of a boiler. Total volume of the appliance is determined from exterior dimensions and is to include fan compartments and burner vestibules, when used. When the actual ceiling height of a room is greater than 8 feet (2438 mm), the volume of the room is figured on the basis of a ceiling height of 8 feet (2438 mm).]~~

ROUGH-IN. Parts of the gas system that are installed prior to the installation of appliances or equipment. This includes gas piping, all the necessary supports and any appliances that are built into the structure.

SAFETY SHUTOFF DEVICE. See “Flame safeguard.”

SERVICE PIPING. All fuel-gas piping, valves and fittings upstream of the point of delivery.

SHAFT. An enclosed space extending through one or more stories of a building, connecting vertical openings in successive floors, or floors and the roof.

SLEEPING UNIT. A dwelling unit, which may contain either toilet or kitchen facilities but not both. Any sleeping unit housing more than one family shall also be classified as a congregate living unit. The creation of or conversion to sleeping units shall be limited by Section 27-2077 of the *New York City Housing Maintenance Code*.

SPECIFIC GRAVITY. As applied to gas, specific gravity is the ratio of the weight of a given volume to that of the same volume of air, both measured under the same condition.

STATIONARY FUEL CELL POWER PLANT. A self-contained package or factory-matched packages ~~[which]~~ that constitute an automatically operated assembly of integrated systems for generating electrical energy and recoverable thermal energy that is permanently connected and fixed in place.

THERMOSTAT.

Electric switch type. A device that senses changes in temperature and controls electrically, by means of separate components, the flow of gas to the burner(s) to maintain selected temperatures.

Integral gas valve type. An automatic device, actuated by temperature changes, designed to control the gas supply to the burner(s) in order to maintain temperatures between predetermined limits, and in which the thermal actuating element is an integral part of the device.

1. **Graduating thermostat.** A thermostat in which the motion of the valve is approximately in direct proportion to the effective motion of the thermal element induced by temperature change.
2. **Snap-acting thermostat.** A thermostat in which the thermostatic valve travels instantly from the closed to the open position, and vice versa.

THIRD-PARTY CERTIFICATION AGENCY. An approved agency operating a product or material certification system that incorporates initial product testing, assessment and surveillance of a manufacturer's quality control system.

THIRD-PARTY CERTIFIED. Certification obtained by the manufacturer indicating that the function and performance characteristics of a product or material have been determined by testing and ongoing surveillance by an approved third-party certification agency. Assertion of certification is in the form of identification in accordance with the requirements of the third-party certification agency.

THIRD-PARTY TESTED. Procedure by which an approved testing laboratory provides documentation that a product, material or system conforms to specified requirements.

TRANSITION FITTINGS, PLASTIC TO STEEL. An adapter for joining plastic pipe to steel pipe. The purpose of this fitting is to provide a permanent, pressure-tight connection between two materials [which] that cannot be joined directly one to another.

UNIT HEATER.

High-static pressure type. A self-contained, automatically controlled, vented appliance having integral means for circulation of air against 0.2 inch (15 mm H₂O) or greater static pressure. Such appliance is equipped with provisions for attaching an outlet air duct and, where the appliance is for indoor installation remote from the space to be heated, is also equipped with provisions for attaching an inlet air duct.

Low-static pressure type. A self-contained, automatically controlled, vented appliance, intended for installation in the space to be heated without the use of ducts, having integral means for circulation of air. Such units are allowed to be equipped with louvers or face extensions made in accordance with the manufacturer's specifications.

UNLISTED BOILER. A boiler not listed by a nationally recognized testing agency.

UNVENTED ROOM HEATER. An unvented heating appliance designed for stationary installation and utilized to provide comfort heating. Such appliance provides radiant heat or convection heat by gravity or fan circulation directly from the heater and does not utilize ducts.

VALVE. A device used in piping to control the gas supply to any section of a system of piping or to an appliance.

Appliance shutoff. A valve located in the piping system, used to isolate individual appliances for purposes such as service or replacement.

Automatic. An automatic or semiautomatic device consisting essentially of a valve and operator that control the gas supply to the burner(s) during operation of an appliance. The operator shall be actuated by application of gas pressure on a flexible diaphragm, by electrical means, by mechanical means, or by other approved means.

Automatic gas shutoff. A valve used in conjunction with an automatic gas shutoff device to shut off the gas supply to a [water-heating] system. It shall be constructed integrally with the gas shutoff device or shall be a separate assembly.

Individual main burner. A valve that controls the gas supply to an individual main burner.

Main burner control. A valve that controls the gas supply to the main burner manifold.

Manual main gas-control. A manually operated valve in the gas line for the purpose of completely turning on or shutting off the gas supply to the appliance, except to pilot or pilots that are provided with independent shutoff.

Manual reset. An automatic shutoff valve installed in the gas supply piping and set to shut off when unsafe conditions occur. The device remains closed until manually reopened.

Service shutoff. A valve, installed by the serving gas supplier between the service meter or source of supply and the customer piping system, to shut off the entire piping system.

VENT. A pipe or other conduit composed of factory-made components, containing a passageway for conveying combustion products and air to the atmosphere, listed and labeled for use with a specific type or class of appliance.

Special gas vent. A vent listed and labeled for use with listed Category II, III and IV appliances.

Type B vent. A vent listed and labeled for use with appliances with draft hoods and other Category I appliances that are listed for use with Type B vents.

Type BW vent. A vent listed and labeled for use with wall furnaces.

Type L vent. A vent listed and labeled for use with appliances that are listed for use with Type L or Type B vents.

VENT CONNECTOR. [⚠ See “Connector” ⚠].

VENT GASES. Products of combustion from appliances plus excess air plus dilution air in the vent connector, gas vent or chimney above the draft hood or draft regulator.

VENT PIPING.

Breather. Piping run from a pressure-regulating device to the outdoors, designed to provide a reference to atmospheric pressure. If the device incorporates an integral pressure relief mechanism, a breather vent can also serve as a relief vent.

Relief. Piping run from a pressure-regulating or pressure-limiting device to the outdoors, designed to provide for the safe venting of gas in the event of excessive pressure in the gas piping system.

VENTED APPLIANCE CATEGORIES. Appliances that are categorized for the purpose of vent selection are classified into the following four categories:

Category I. An appliance that operates with a nonpositive vent static pressure and with a vent gas temperature that avoids excessive condensate production in the vent.

Category II. An appliance that operates with a nonpositive vent static pressure and with a vent gas temperature that is capable of causing excessive condensate production in the vent.

Category III. An appliance that operates with a positive vent static pressure and with a vent gas temperature that avoids excessive condensate production in the vent.

Category IV. An appliance that operates with a positive vent static pressure and with a vent gas temperature that is capable of causing excessive condensate production in the vent.

VENTED ROOM HEATER. A vented self-contained, free-standing, nonrecessed appliance for furnishing warm air to the space in which it is installed, directly from the heater without duct connections.

VENTED WALL FURNACE. A self-contained vented appliance complete with grilles or equivalent, designed for incorporation in or permanent attachment to the structure of a building, mobile home or travel trailer, and furnishing heated air circulated by gravity or by a fan directly into the space to be heated through openings in the casing. This definition shall exclude floor furnaces, unit heaters and central furnaces as herein defined.

VENTING SYSTEM. A continuous open passageway from the flue collar or draft hood of an appliance to the ~~outside~~ outdoor atmosphere for the purpose of removing flue or vent gases. A venting system is usually composed of a vent or a chimney and vent connector, if used, assembled to form the open passageway.

Forced-draft venting system. A portion of a venting system using a fan or other mechanical means to cause the removal of flue or vent gases under positive static vent pressure.

Induced draft venting system. A portion of a venting system using a fan or other mechanical means to cause the removal of flue or vent gases under nonpositive static vent pressure.

Mechanical draft venting system. A venting system designed to remove flue or vent gases by mechanical means, that consists of an induced draft portion under nonpositive static pressure or a forced draft portion under positive static pressure.

Natural draft venting system. A venting system designed to remove flue or vent gases under nonpositive static vent pressure entirely by natural draft.

WALL HEATER, UNVENTED-TYPE. A room heater of the type designed for insertion in or attachment to a wall or partition. Such heater does not incorporate concealed venting arrangements in its construction and discharges all products of combustion through the front into the room being heated.

WATER HEATER. Any heating appliance or equipment that heats potable water and supplies such water to the potable hot water distribution system.

§ 4. Chapter 3 of the New York city fuel gas code, as amended by local law number 141 for the year 2013, is amended to read as follows:

CHAPTER 3 GENERAL REGULATIONS

SECTION FGC 301 GENERAL

301.1 Scope. This chapter shall govern the approval and installation of all equipment and appliances that comprise parts of the installations regulated by this code in accordance with Section 101.2.

301.1.1 Other fuels. The requirements for combustion and dilution air for gas-fired appliances shall be governed by Section 304. The requirements for combustion and dilution air for appliances operating with fuels other than fuel gas shall be regulated by the *New York City Mechanical Code*.

301.2 Energy utilization. Heating, ventilating [~~and~~] , air-conditioning, and refrigeration systems of all structures shall be designed and installed for efficient utilization of energy in accordance with the *New York City Energy Conservation Code*.

301.3 Listed and labeled. Appliances regulated by this code shall be listed and labeled.

301.4 Labeling. Refer to Article 114 and Section 28-113.4 of the *Administrative Code* [~~and Article 114 of Chapter 1 of Title 28 of the Administrative Code~~].

301.5 Label information. A permanent factory-applied nameplate(s) shall be affixed to appliances on which shall appear [;] in legible lettering[;]; the manufacturer's name or trademark, the model number, serial number and, for listed appliances, the seal or mark of the testing agency. A label shall [~~also~~] include the hourly rating in British thermal units per hour (Btu/h) (W), the type of fuel approved for use with the appliance; and the minimum clearance requirements.

301.6 Plumbing connections. Potable water supply and building drainage system connections to appliances regulated by this code shall be in accordance with the *New York City Plumbing Code*.

301.7 Fuel types. Appliances shall be designed for use with the type of fuel gas that will be supplied to them.

301.7.1 Appliance fuel conversion. Appliances shall not be converted to utilize a different fuel gas except where complete instructions for such conversion are provided [~~in installation instructions~~] by the serving gas supplier [~~or by~~] , the appliance manufacturer, the burner manufacturer or the boiler

manufacturer. If a specific listing and labeling is available for the burner and boiler combination it shall be submitted to the department. If a specific listing for the combination is not available the listing for the burner and a letter confirming compatibility shall be submitted by the burner manufacturer. The completed installation shall be inspected and tested in the field by a representative of the appliance manufacturer, the burner manufacturer or the boiler manufacturer, and certified by a registered design professional. A certification of compliance by a registered design professional developed in accordance with the requirements of the New York City Department of Environmental Protection may be used to satisfy this certification requirement. The registered design professional need not be the engineer of record for the design.

301.7.2 Liquid petroleum gas. Storage or use of LPG for a stationary LPG installation shall comply with the *New York City Fire Code*.

301.8 Vibration isolation. Where means for isolation of vibration of an appliance is installed, means for support and restraint of that appliance shall be provided as designed by a registered design professional.

301.9 Repair. Defective material or parts shall be replaced or repaired in such a manner so as to preserve the original approval or listing.

301.10 Wind resistance. Appliances and supports that are exposed to wind shall be designed and installed to resist the wind pressures determined in accordance with the *New York City Building Code*.

301.11 Flood hazard. For structures located in [~~areas of special~~] flood hazard areas, the appliance, equipment and system installations regulated by this code shall comply with the additional requirements of Appendix G of the *New York City Building Code*.

301.12 Seismic resistance. When earthquake loads are applicable in accordance with the *New York City Building Code*, the supports shall be designed and installed for the seismic forces in accordance with that code.

301.13 Ducts. [~~All ducts~~] Ducts required for the installation of systems regulated by this code shall be designed and installed in accordance with the *New York City Mechanical Code*.

301.14 Rodentproofing. Buildings or structures and the walls enclosing habitable or occupiable rooms and spaces in which persons live, sleep or work, or in which feed, food or foodstuffs are stored, prepared, processed, served or sold, shall be constructed to protect against rodents in accordance with the *New York City Building Code*.

301.15 Prohibited location. The appliances, equipment and systems regulated by this code shall not be located in an elevator shaft.

301.16 Mechanical systems. Hydronic piping, ventilation and other mechanical systems not covered by this code shall be in accordance with the *New York City Mechanical Code*.

301.17 Electrical systems. Electrical wiring, controls and connections to equipment and appliances regulated by this code shall be in accordance with the *New York City Electrical Code*.

301.18 Noise control requirements. Appliances and equipment regulated by this code must comply with Section ~~[928]~~ 313 of the *New York City Mechanical Code*.

SECTION FGC 302 STRUCTURAL SAFETY

302.1 Structural safety. The building shall not be weakened by the installation of any gas piping. In the process of installing or repairing any gas piping, the finished floors, walls, ceilings, tile work or any other part of the building or premises which is required to be changed or replaced shall be left in a safe structural condition in accordance with the requirements of the *New York City Building Code*.

302.1.1 Loading. Alterations resulting in the addition of loads to any member, such as HVAC equipment and water heaters, shall not be permitted without verification that the members are capable of supporting such additional loading.

302.2 Penetrations of floor/ceiling assemblies and fire-resistance-rated assemblies. Penetrations of floor/ceiling assemblies and assemblies required to have a fire-resistance rating shall be protected in accordance with the *New York City Building Code*.

302.3 Cutting, notching and boring in wood members. The cutting, notching and boring of wood members shall comply with Sections 302.3.1 through ~~[302.3.4]~~ 302.3.5.

~~302.3.1 [Engineered wood products.~~ ~~Cuts, notches and holes bored in trusses, structural composite lumber, structural glued laminated members and I joists are prohibited except where permitted by the manufacturer's recommendations or where the effects of such alterations are specifically considered in the design of the member by a registered design professional.]~~

~~[302.3.2 Joist notching and boring.]~~ **Solid non-engineered joist notches and holes.** ~~[Notching at]~~ Notches on the ends of the solid non-engineered joists shall not exceed one-fourth the joist depth. Notches in the top or bottom of joists shall not exceed one-sixth the depth, shall not be longer than one-third the depth and shall not be located in the middle third of the span. Holes bored in joists shall not be within 2 inches (51 50.8 mm) of the top [and] or bottom of the joist, and [their] the diameter of any such hole shall not exceed one-third the depth of the [member] joist. [Notches in the top or bottom of the joist shall not exceed one-sixth the depth and shall not be located in the middle one-third of the span.] Holes bored in the middle third of the span shall be located at the center of the joist depth. Clear distance between holes and notches shall be a minimum of 2 inches (50.8 mm). See Figure 2308.5.8 of the *New York City Building Code*.

~~[302.3.3]~~ **302.3.2 Stud cutting and notching.** In exterior walls and bearing partitions, ~~[any]~~ wood [stud is] studs are permitted to be cut or notched to a depth not exceeding 25 percent of [its] the width of the stud. Cutting or notching of studs to a depth not greater than 40 percent of the width of the stud is permitted in ~~[nonload-bearing]~~ nonbearing partitions supporting no loads other than the weight of the partition. See Figure 2308.5.8 of the *New York City Building Code*.

~~[302.3.4]~~ **302.3.3 Bored holes in studs.** ~~[A hole]~~ Bored holes not greater [in diameter] than 40 percent of the stud [depth is] width are permitted to be bored in any wood stud. Bored holes not greater than 60 percent of the [depth of] the stud width are permitted in [nonload-bearing] nonbearing partitions or in any wall where each bored stud is doubled, provided not more than two such successive doubled

studs are so bored. In no case shall the edge of the bored hole be nearer than $\frac{5}{8}$ inch (15.9 mm) to the edge of the stud. Bored holes shall not be located at the same section of stud as a cut or notch. See Figure 2308.5.8 of the *New York City Building Code*.

302.3.4 Engineered wood products. Cuts, notches and holes bored in trusses, structural composite lumber, structural glued-laminated members and I-joists are prohibited except where permitted by the manufacturer's recommendations or where the effects of such alterations are specifically considered in the design of the member by a registered design professional.

302.3.5 Drilling and notching of top plate. When piping is placed in or partly in an exterior wall or interior load-bearing wall, necessitating cutting, drilling or notching of the top plate by more than 50 percent of its width, a galvanized metal tie not less than 0.054 inch thick (1.37 mm) (No. 16 gage) and 1½ inches (38.1 mm) wide shall be fastened across and to the plate at each side of the opening with not less than eight 10d (0.148 inch diameter) nails having a minimum length of 1½ inches (38.1 mm) at each side or equivalent. The metal tie must extend a minimum of 6 inches (152.4 mm) past the opening. See Figure 2308.5.8 of the *New York City Building Code*.

Exception: When the entire side of the wall with the notch or cut is covered by wood structural panel sheathing, additional fastening is not required.

302.4 [~~Alterations to trusses~~] Trusses. Truss members of any material and components shall not be cut, drilled, notched, spliced or otherwise altered in any way without the written concurrence and approval of a registered design professional. [~~Alterations resulting in the addition of loads to any member (e.g., HVAC equipment, water heaters) shall not be permitted without verification that the truss is capable of supporting such additional loading.~~]

302.5 Cutting, notching and boring in steel framing. The cutting, notching and boring of steel framing members shall comply with Sections 302.5.1 through 302.5.4.

302.5.1 [~~Cutting, notching and boring holes in structural~~] Structural steel framing. The cutting, notching and boring of holes in structural steel framing members shall be as prescribed by the registered design professional.

[~~302.6 Cutting, notching and boring holes in cold-formed~~] 302.5.2 Cold-formed steel framing. Flanges and lips of load-bearing, cold-formed steel framing members shall not be cut or notched. Holes in webs of load-bearing, cold-formed steel framing members shall be permitted along the centerline of the web of the framing member and shall not exceed the dimensional limitations, penetration spacing or minimum hole edge distance as prescribed by [a] the registered design professional. [~~Cutting, notching and boring holes of steel floor/roof decking shall be as prescribed by a registered design professional.~~]

[~~302.7 Cutting, notching and boring holes in nonstructural~~] 302.5.3 Nonstructural cold-formed steel wall framing. Flanges and lips of nonstructural cold-formed steel wall studs shall be permitted along the centerline of the web of the framing member, shall not exceed 1½ inches ([38] 38.1 mm) in width or 4 inches ([102] 101.6 mm) in length, and the holes shall not be spaced less than 24 inches ([610] 609.6 mm) center to center from another hole or less than 10 inches (254 mm) from the bearing end.

302.5.4 Steel floor and roof decking. Cutting, notching and boring holes in steel floor and roof decking shall be as prescribed by the registered design professional.

302.6 Cutting, notching and coring into concrete. The cutting, notching or coring of concrete must comply with provisions of Chapter 19 of the *New York City Building Code* and is not permitted without prior approval of the registered design professional.

302.7 Protection of footings. Trenching installed parallel to footings and walls shall not extend into the bearing plane of a footing or wall. The upper boundary of the bearing plane is a line that extends downward, at an angle of 34 degrees (1:1.5 slope) from horizontal, from the outside bottom edge of the footing or wall.

302.8 Piping materials exposed within plenums. Piping materials exposed within plenums shall comply with the provisions of the *New York City Mechanical Code*.

SECTION FGC 303 APPLIANCE LOCATION

303.1 General. Appliances shall be located as required by this section, specific requirements elsewhere in this code and the conditions of the equipment and appliance listing.

303.2 Hazardous locations. Appliances shall not be located in a hazardous location unless listed and approved for the specific installation.

303.3 Prohibited locations. Appliances shall not be located in sleeping rooms, bathrooms, toilet rooms, storage closets or surgical rooms, or in a space that opens only into such rooms or spaces.

Exceptions:

1. In rooms other than those used for sleeping purposes, direct-vent appliances that obtain all combustion air directly from the outdoors and installed in accordance with the conditions of the listing and the manufacturer's instructions.
2. In rooms other than those used for sleeping purposes, vented room heaters, wall furnaces, vented decorative appliances, vented gas fireplaces, vented gas fireplace heaters and decorative appliances for installation in vented solid fuel-burning fireplaces that are installed in rooms that meet the required volume criteria of Section 304.5.
3. In rooms other than those used for sleeping purposes, appliances installed in an enclosure in which all combustion air is taken from the outdoors, in accordance with Section 304.6. Access to such enclosure shall be through a solid weather-stripped door, equipped with an approved self-closing device.

303.3.1 Gas-fired direct vent appliances. Gas-fired direct vent space-heating appliances used for providing heat in rooms for sleeping purposes shall be deemed to be located outside of the sleeping room provided that the appliance and its installation comply with Sections 303.3.1.1 through 303.3.1.7.

303.3.1.1 General. ~~[such a]~~ Such unit is factory assembled and manufactured with an integral, factory assembled and hard-wired carbon monoxide detector interlock ~~[with]~~ and automatic main gas shut-off valve. ~~[Such unit shall be of direct vent type, such that all air for combustion is derived from the outdoors and that all flue gases are discharged directly to the outdoors.]~~ The appliance shall be tested, designed and evaluated in accordance with Section 622 of this code. Acceptable gas-fired direct vent space-heating appliances shall be listed and labeled by an approved agency in accordance with Section 28-113.2.3 of the *Administrative Code*. Installation shall be in accordance with the manufacturer's instructions and the applicable listing.

303.3.1.2 Carbon monoxide detector. The carbon monoxide detector shall be listed and labeled in accordance with UL 2034 and UL 2075 and installed in accordance with the carbon monoxide detector manufacturer's instructions. The carbon monoxide detector may be installed integral to the appliance, on the surface of the appliance or remotely, but hard-wired, no more than 5 feet (1.5 m) from the appliance.

303.3.1.3 Internal safety controls. The appliance shall be hard-wired to the carbon monoxide detector in a supervisory signaling mode. If the carbon monoxide detector connection is not sensed, the appliance shall not initiate a startup sequence and shall alert the operator to the fault condition. The appliance shall be supplied with a carbon monoxide fault indicator easily visible and recognizable to the operator. The appliance shall be equipped with a manual restart control. Automatic reset is not permitted.

303.3.1.4 Gas piping. The appliance shall be installed with natural gas only. All gas piping shall be hard-piped with no flexible connectors. ~~[Such unit shall be installed through a sleeve located in an exterior wall.]~~ Pursuant to Section 27-2034(f) of the *New York City Housing Maintenance Code*, each heater shall be equipped with an effective device ~~[which will]~~ to automatically shut off the gas supply to the heater if its pilot light or other constantly burning flame is extinguished, or in the event of an interruption of the gas supply to the heater, and will not permit the heater to be relighted unless such shut-off device is first reset manually. ~~[Installation requirements shall be in accordance with the manufacturer's instructions and the applicable listing.]~~

303.3.1.5 Venting. Such unit shall be of direct vent type, such that all air for combustion is derived from the outdoors and that all flue gases are discharged directly to the outdoors. Such unit shall be installed through a sleeve located in an exterior wall.

303.3.1.6 Installation. Gas-fired direct vented appliances shall be installed in accordance with the following:

1. Carbon monoxide detectors installed with gas-fired direct vent space-heating appliance shall be provided in addition to code required carbon monoxide detector devices in dwelling units.
2. Carbon monoxide detectors installed with gas-fired direct vent space-heating appliance shall not be interconnected to other carbon monoxide detecting devices in the dwelling unit.
3. The appliance shall only be installed by a master licensed plumber.

303.3.1.7 Clearances. Gas-fired direct vented appliances shall be installed with the following clearances:

1. Clearances from adjacent combustible surfaces shall meet the minimum clearances indicated by the manufacturer's instructions and the listing agency.
2. Clearances from adjacent openings or packaged terminal air conditioners (PTAC) and packaged terminal heat pumps (PTHP), the bottom of the vent terminal and the air intake shall be located at least 12 inches (304.8 mm) above finished ground level and in accordance with Table 303.3.1.7.
3. For all other equipment, all vent termination clearances from adjacent openings shall be in accordance with Section 503.8.

**TABLE 303.3.1.7
PTAC AND PTHP VENT TERMINATION CLEARANCE TO AIR OPENINGS**

<u>Appliance Input Rating (BTU per hour)</u>	<u>Vent Termination Clearance to Any Air Opening Into Same or Adjacent Building (inches)</u>
<u>10,000 or less</u>	<u>6</u>
<u>Over 10,000 but less than 50,000</u>	<u>9</u>
<u>50,000 or over</u>	<u>12</u>

For SI: 1 inch = 25.4 mm, 1 British thermal unit per hour = 0.2931 W.

303.4 Protection from physical damage. Appliances shall not be installed in a location where subject to physical damage, including vehicular impact, unless protected by approved barriers meeting the requirements of the *New York City Fire Code*.

303.5 Indoor locations. Furnaces and boilers installed in closets and alcoves shall be listed for such installation.

303.5.1 ~~[Gas Fired Appliances]~~ Gas fired appliances. ~~[Gas fired appliances]~~ Boilers, furnaces and other centrally installed space heating equipment, regardless of btu per hour input, shall be located in an enclosure in accordance with Section 509 of the *New York City Building Code*.

Exception: Gas-fired direct vented appliances with a 350,000 btu per hour (102.6 kW) input or less may be installed in a non-fire rated enclosure.

303.5.2 Maximum temperature. Maximum indoor temperature in spaces surrounding appliances shall not exceed the greater of the operational temperature of the installed equipment ~~[and/or]~~ or 104° F (40° C).

303.6 Outdoor locations. Appliances installed in outdoor locations shall be either listed for outdoor installation or provided with protection from outdoor environmental factors that influence the operability, durability and safety of the appliances.

303.7 Pit locations. Appliances installed in pits or excavations shall not come in direct contact with the surrounding soil. The sides of the pit or excavation shall be held back a minimum of 12 inches (~~[305]~~ 304.8 mm) from the appliance. Where the depth exceeds 12 inches (~~[305]~~ 304.8 mm) below adjoining grade, the walls of the pit or excavation shall be lined with concrete or masonry, such concrete or masonry shall extend a minimum of 4 inches (~~[102]~~ 101.6 mm) above adjoining grade and shall have sufficient lateral load-bearing capacity to resist collapse. The appliance shall be protected from flooding in a manner approved by the commissioner.

SECTION FGC 304 COMBUSTION, VENTILATION AND DILUTION AIR

304.1 General. Air for combustion, ventilation and dilution of flue gases for appliances installed in buildings shall be provided by application of one of the methods prescribed in Sections 304.5 through 304.9. Where the requirements of Section 304.5 are not met, outdoor air shall be introduced in accordance with one of the methods prescribed in Sections 304.6 through 304.9. Direct-vent appliances, gas appliances of other than natural draft design ~~[and]~~, vented gas appliances ~~[other than]~~ not designated as Category I and appliances equipped with power burners shall be provided with combustion, ~~[ventilation]~~ and dilution air in accordance with the appliance manufacturer's instructions. Combustion, ~~[ventilation,]~~ and dilution air shall be obtained solely from the outdoors for fuel-burning appliances with an input greater than 350,000 Btu/h (102.6 kW). Ventilation air shall be provided by any suitable means. The mechanical room shall comply with the requirements of Section 1012 of the *New York City Mechanical Code* and Sections C402.5.3 and R402.4.4, as applicable, of the *New York City Energy Conservation Code*.

Exception: Type 1 clothes dryers that are provided with makeup air in accordance with Section ~~[614.5]~~ 504 of the *New York City Mechanical Code*.

304.1.1 Crawl space and attic space. For the purposes of this chapter, an opening to a naturally ventilated crawl space or attic space shall be considered equivalent to an opening to the outdoors.

~~[304.1.2]~~ **304.1.1.1 Crawl space.** Where lower combustion air openings connect with crawl spaces, such spaces shall have unobstructed openings to the outdoors at least twice that required for the combustion air openings. The height of the crawl space shall comply with the requirements of the *New York City Building Code* and shall be without obstruction to the free flow of air.

~~[304.1.3]~~ **304.1.1.2 Attic space.** Where combustion air is obtained from an attic area, the attic ventilating openings shall not be subject to ice or snow blockage, and the attic shall have not less than 30 inches (762 mm) vertical clear height at its maximum point. Attic ventilation openings shall be sufficient to provide the required volume of combustion air and the attic ventilation required by the *New York City Building Code*. The combustion air openings shall be provided with a sleeve of not less than 0.019 inch (0.48 mm) (No. 26 Gage) galvanized

steel or other approved material extending from the appliance enclosure to at least 6 inches ([152] 152.4 mm) above the top of the ceiling joists and insulation.

304.2 Appliance location. Appliances shall be located so as not to interfere with proper circulation of combustion, ventilation and dilution air.

304.3 Draft hood/regulator location. Where used, a draft hood or a barometric draft regulator shall be installed in the same room or enclosure as the equipment served [~~so as~~] to prevent any difference in pressure between the hood or regulator and the combustion air supply. A barometric damper may be installed in an adjacent room provided that a louver is installed in the adjacent room to the outside air. The net free area of the louver shall be equal to or greater than the area of the barometric damper.

304.4 Circulation of air. The equipment and appliances within every room containing fuel-burning appliances shall be installed so as to allow free circulation of air. Provisions shall be made to allow for the simultaneous operation of mechanical exhaust systems, fireplaces or other equipment and appliances operating in the same room or space from which combustion, ventilation, and dilution air is being drawn. Such provisions shall prevent the operation of such appliances, equipment and systems from affecting the supply of combustion, ventilation, and dilution air.

304.4.1 Makeup air for fuel burning devices. Where exhaust fans are installed, makeup air shall be provided to replace the exhausted air. Calculations shall be provided on the construction documents to validate the use of the exhaust fan(s) and compliance with this Chapter.

304.4.2 Ventilation air for fuel burning devices. Where ventilation air is brought in by mechanical means for heat generation mitigation, provisions must be made for proper air balance to prevent a negative or positive pressure in the boiler room and to discharge the ventilation directly to the outside.

304.4.3 Prohibited sources. Openings and ducts shall not connect appliance enclosures with a space in which the operation of a fan will adversely affect the flow of the combustion, ventilation, and dilution air. Combustion, ventilation, and dilution air shall not be subject to ice or snow blockage. No combustion, ventilation, and dilution air inlet shall be less than 30 inches (762 mm) above grade. Combustion, ventilation, and dilution air shall not be obtained from a hazardous location, except where the fuel-fired appliances are located within the hazardous location and are not installed in accordance with this code. Combustion, ventilation, and dilution air shall not be taken from a refrigeration machinery room, except where a refrigerant vapor detector system is installed to automatically shut off the combustion process in the event of refrigerant leakage. For structures in [~~areas of special~~] flood hazard areas, air shall be obtained from a location complying with the additional requirements of Appendix G of the New York City Building Code.

304.5 Indoor combustion air. The required volume of indoor air shall be determined in accordance with Section 304.5.1 or 304.5.2, except that where the air infiltration rate is known to be less than 0.40 air changes per hour (ACH), Section 304.5.2 shall be used. The total required volume shall be the sum of the required volume calculated for all appliances located within the space. Rooms communicating directly with the space in which the appliances are installed through openings not furnished with doors, and through combustion air openings sized and located in accordance with Section 304.5.3, are considered to be part of the required volume.

Exception: Combustion, ventilation, and dilution air shall be obtained solely from the outdoors for fuel-burning appliances with an input greater than 350,000 Btu/h (102.6 kW).

304.5.1 Standard method. The minimum required volume shall be 50 cubic feet per 1,000 Btu/h (4.8m³/kW) of the appliance input rating.

304.5.2 Known air-infiltration-rate method. Where the air infiltration rate of a structure is known, the minimum required volume shall be determined as follows:

For appliances other than fan-assisted, calculate volume using Equation 3-1.

$$\text{Required Volume}_{\text{other}} \geq \frac{21 \text{ ft}^3}{\text{ACH}} \left(\frac{I_{\text{other}}}{1,000 \text{ Btu/hr}} \right) \quad \text{(Equation 3-1)}$$

For fan-assisted appliances, calculate volume using Equation 3-2.

$$\text{Required Volume}_{\text{fan}} \geq \frac{15 \text{ ft}^3}{\text{ACH}} \left(\frac{I_{\text{fan}}}{1,000 \text{ Btu/hr}} \right) \quad \text{(Equation 3-2)}$$

where:

I_{other} = All appliances other than fan assisted (input in Btu/h).

I_{fan} = Fan-assisted appliance (input in Btu/h).

ACH = Air change per hour (percent of volume of space exchanged per hour, expressed as a decimal).

For purposes of this calculation, an infiltration rate greater than 0.60 ACH shall not be used in Equations 3-1 and 3-2.

304.5.3 Indoor opening size and location. Openings used to connect indoor spaces shall be sized and located in accordance with Sections 304.5.3.1 and 304.5.3.2 (see Figure 304.5.3).

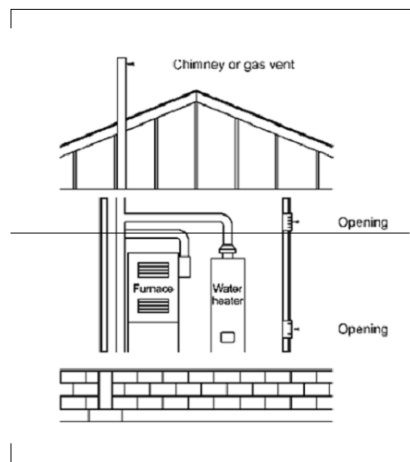

**[FIGURE 304.5.3
ALL AIR FROM INSIDE THE BUILDING
(see Section 304.5.3)]**

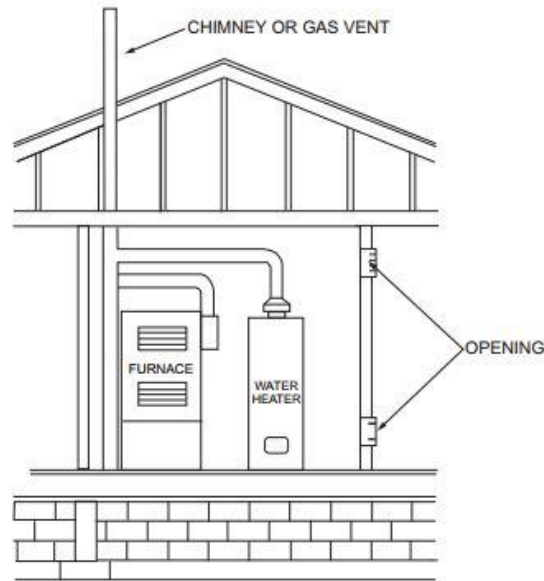

**FIGURE 304.5.3
ALL AIR FROM INSIDE THE BUILDING
(see Section 304.5.3)**

304.5.3.1 Combining spaces on the same story. Each opening shall have a minimum free area of 1 square inch per 1,000 Btu/h (2200 mm²/kW) of the total input rating of all appliances in the space, but not less than 100 square inches (0.06 m²). One opening shall commence within 12 inches ([305] 304.8 mm) of the top and one opening shall commence within 12 inches ([305] 304.8 mm) of the bottom of the enclosure. The minimum dimension of air openings shall be not less than 3 inches ([76] 76.2 mm).

304.5.3.2 Combining spaces in different stories. The volumes of spaces in different stories shall be considered as communicating spaces where such spaces are connected by one or more openings in doors or floors having a total minimum free area of 2 square inches per 1,000 Btu/h (4402 mm²/kW) of total input rating of all appliances.

304.6 Outdoor combustion air. Outdoor combustion air shall be provided through opening(s) to the outdoors in accordance with Section 304.6.1 or 304.6.2. The minimum dimension of air openings shall be not less than 3 inches ([76] 76.2 mm). The size of the openings connecting the room to the outdoor air supply shall also comply with any applicable rules of the New York City Department of Environmental Protection.

304.6.1 Two-permanent-openings method. Two permanent openings, one commencing within 12 inches ([305] 304.8 mm) of the top and one commencing within 12 inches ([305] 304.8 mm) of the bottom of the enclosure, shall be provided. The openings shall communicate

directly [7] or by ducts [7] with the outdoors or spaces that freely communicate with the outdoors.

Where directly communicating with the outdoors, or where communicating with the outdoors through vertical ducts, each opening shall have a minimum free area of 1 square inch per 4,000 Btu/h (550 mm²/kW) of total input rating of all appliances in the enclosure [F] (see Figures 304.6.1(1) and 304.6.1(2) [H]).

Where communicating with the outdoors through horizontal ducts, each opening shall have a minimum free area of not less than 1 square inch per 2,000 Btu/h (1100 mm²/kW) of total input rating of all appliances in the enclosure [F] (see Figure 304.6.1(3) [H]).

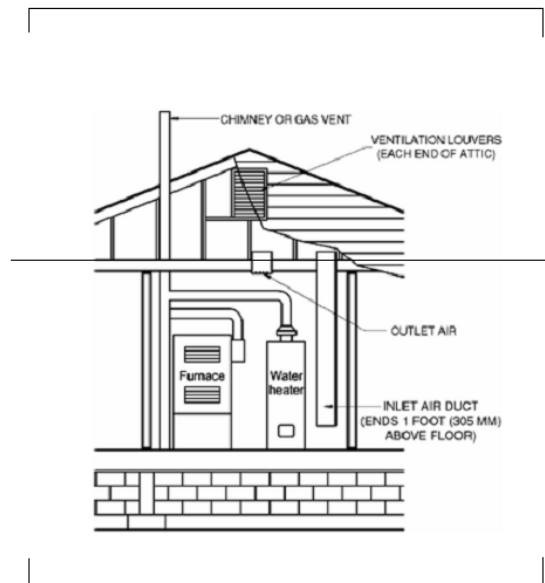

[FIGURE 304.6.1(1)]
~~ALL AIR FROM OUTDOORS INLET AIR FROM VENTILATED~~
~~CRAWL SPACE AND OUTLET AIR TO VENTILATED ATTIC~~
(see Section 304.6.1)

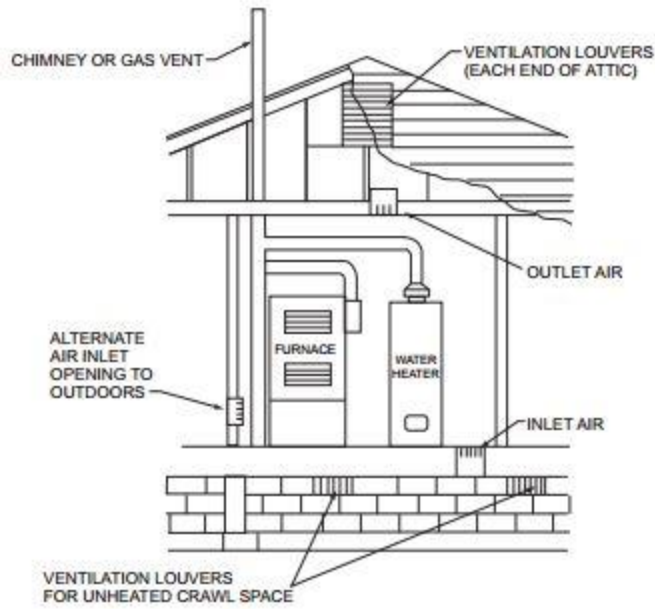
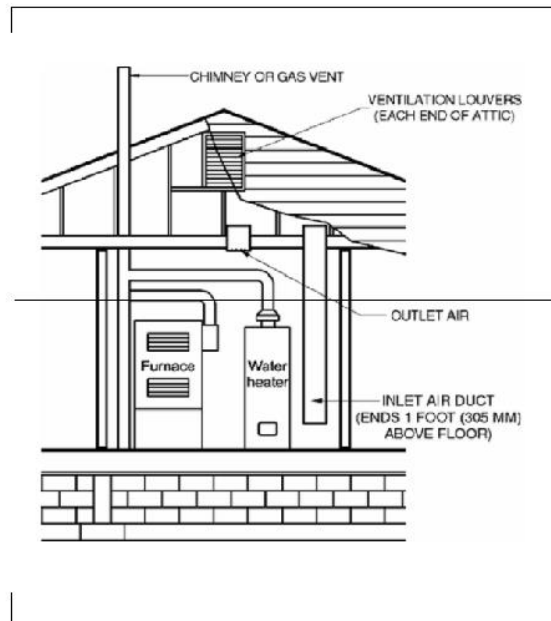

FIGURE 304.6.1(1)
ALL AIR FROM OUTDOORS—INLET AIR FROM VENTILATED CRAWL SPACE AND OUTLET AIR TO VENTILATED ATTIC
 (see Section 304.6.1)



[FIGURE 304.6.1(2)
ALL AIR FROM OUTDOORS THROUGH VENTILATED ATTIC
 (see Section 304.6.1)]

[For SI: 1 foot = 304.8 mm.]

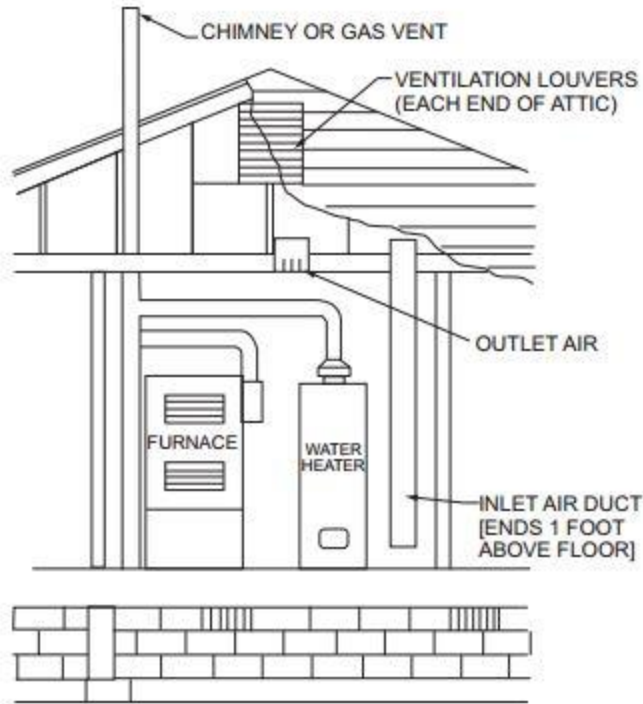

FIGURE 304.6.1(2)
ALL AIR FROM OUTDOORS THROUGH VENTILATED ATTIC
 (see Section 304.6.1)

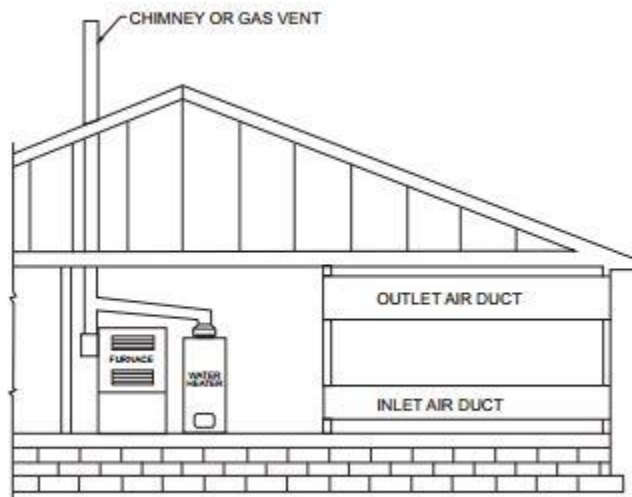

FIGURE 304.6.1(3)
ALL AIR FROM OUTDOORS
 (see Section 304.6.1)

304.6.2 One-permanent-opening method. One permanent opening, commencing within 12 inches ([305] 304.8 mm) of the top of the enclosure, shall

have clearances of [~~at least~~] not less than 1 inch (~~[25]~~ 25.4 mm) from the sides and back and 6 inches (~~[152]~~ 152.4 mm) from the front of the appliance. The opening shall directly communicate with the outdoors, or through a vertical or horizontal duct, to the outdoors or spaces that freely communicate with the outdoors (see Figure 304.6.2) and shall have a minimum free area of 1 square inch per 3,000 Btu/h (734 mm²/kW) of the total input rating of all appliances located in the enclosure [;] and not less than the sum of the areas of all vent connectors in the space.

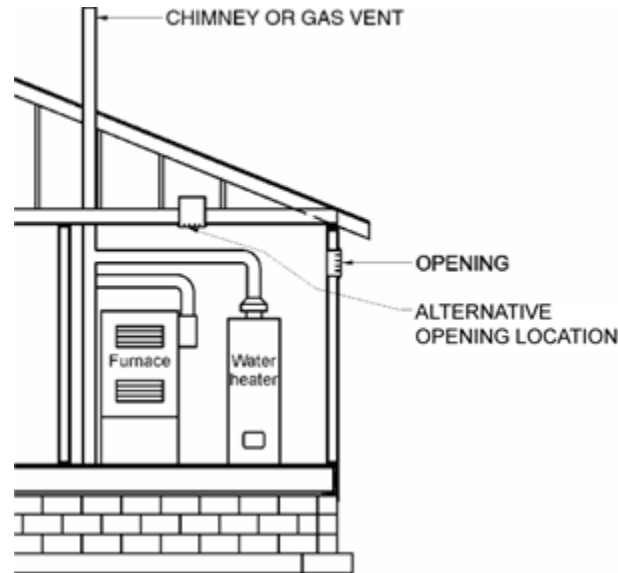

FIGURE 304.6.2
SINGLE COMBUSTION AIR OPENING,
ALL AIR FROM THE OUTDOORS

304.7 Combination indoor and outdoor combustion air. The use of a combination of indoor and outdoor combustion air shall be in accordance with Sections 304.7.1 through 304.7.3.

304.7.1 Indoor openings. Where used, openings connecting the interior spaces shall comply with Section 304.5.3.

304.7.2 Outdoor opening location. Outdoor opening(s) shall be located in accordance with Section 304.6.

304.7.3 Outdoor opening(s) size. The outdoor opening(s) size shall be calculated in accordance with the following:

1. The ratio of interior spaces shall be the available volume of all communicating spaces divided by the required volume.
2. The outdoor size reduction factor shall be one minus the ratio of interior spaces.
3. The minimum size of outdoor opening(s) shall be the full size of outdoor opening(s) calculated in accordance with Section 304.6, multiplied by the reduction factor. The minimum dimension of air openings shall be not less than 3 inches (~~[76]~~ 76.2 mm).

304.8 Reserved.

304.9 Mechanical combustion air supply. Where all combustion air is provided by a mechanical air supply system, the combustion air shall be supplied from the outdoors at a rate not less than 0.35 cubic feet per minute per 1,000 Btu/h (0.034 m³/min per kW) of total input rating of all appliances located within the space. Combustion air rates shall also comply with any applicable rules of the New York City Department of Environmental Protection. The mechanical air supply shall be sufficient to accommodate combustion air, ventilation air, and dilution air requirements of the installation.

304.9.1 Makeup air. Where exhaust fans are installed, makeup air shall be provided to replace the exhausted air.

304.9.2 Appliance interlock. Each of the appliances served shall be interlocked with the mechanical air supply system to prevent main burner operation when the mechanical air supply system is not in operation. The air flow and the damper operation shall be proven prior to burner operation.

304.9.3 Reserved.

304.10 Opening obstructions, locations, and protection. The required size of openings for combustion, ventilation, and dilution air shall be based on the net free area of each opening. The net free area of an opening shall be that specified by the manufacturer of the opening covering. In the absence of such information, openings covered with metal louvers shall be deemed to have a net free area of 60 percent of the area of the opening, and openings covered with wood louvers shall be deemed to have a net free area of 10 percent of the area of the opening. Louvers and grilles shall be fixed in the open position.

Exception: Operable louvers shall be interlocked with the appliance so that they are proven to be in the full open position prior to main burner ignition and during main burner operation. Means shall be provided to prevent the main burner from igniting if the louvers fail to open during burner startup and to shut down the main burner if the louvers close during operation.

304.10.1 Dampered openings. Where the combustion air openings are provided with automatic, smoke or fire dampers, the dampers shall be electrically interlocked with the appliances served, so as to prevent operation of any appliance when any of the dampers are closed. Manually operated dampers shall not be installed in combustion air openings. The damper opening shall be proven prior to burner operation.

304.10.2 Caution sign. A sign stating, "Louvers, dampers and/or ventilation openings must not be blocked or disabled." shall be permanently affixed, in clear view, adjacent to the opening(s) within the room containing the equipment. The letters used on the sign shall be at least 1[-]inch ([25] 25.4 mm) in height.

304.10.3 Opening location and protection. Combustion air openings to the outdoors shall comply with the location and protection provisions applicable to outside air intake openings of Sections 401.5 and 401.6 of the *New York City Mechanical Code*.

304.11 Combustion air ducts. Combustion air ducts shall comply with all of the following:

1. Be of galvanized steel complying with Chapter 6 of the *New York City Mechanical Code* or of equivalent corrosion-resistant material approved for this application.

Exception: Within dwelling units, unobstructed stud and joist spaces shall not be prohibited from conveying combustion air, provided that not more than one required fireblock is removed.

2. Have a minimum [~~cross-sectional~~] dimension of 3 inches (~~(76]~~76.2 mm) in all directions.
3. Terminate in an unobstructed space allowing free movement of combustion air to the appliances.
4. Have the same cross-sectional areas as the free area of the openings to which they connect.
5. Serve a single appliance enclosure.
6. Not serve both upper and lower combustion air openings where both such openings are used. The separation between ducts serving upper and lower combustion air openings shall be maintained to the source of combustion air.
7. Not be screened where terminating in an attic space.
8. Not slope downward toward the source of combustion air, where serving the upper required combustion air opening.
9. Be constructed so that the remaining space surrounding a chimney or chimney liner, installed within a masonry, metal or factory-built chimney cannot be used to supply combustion, ventilation and dilution air, except for direct vent appliances designed and installed in accordance with the equipment manufacturer's instructions and listing. [“]

304.12 Protection from fumes and gases. Where corrosive or flammable process fumes or gases, other than products of combustion, are present, means for the disposal of such fumes or gases shall be provided. Such fumes or gases include carbon monoxide, hydrogen sulfide, ammonia, chlorine and halogenated hydrocarbons.

In barbershops, beauty shops and other facilities where chemicals that generate corrosive or flammable products, such as aerosol sprays, are routinely used, nondirect-vent-type appliances shall be located in a mechanical room separated or partitioned off from other areas with provisions for combustion air and dilution air from the outdoors. Direct-vent appliances shall be installed in accordance with the appliance manufacturer's [~~installation~~] instructions.

SECTION FGC 305 INSTALLATION

305.1 General. Equipment and appliances shall be installed as required by the terms of their approval, in accordance with the conditions of listing, the manufacturer's instructions and this code. Manufacturers' [~~installation~~] instructions shall be available on the job site at the time of inspection. Where a code provision is less restrictive than the conditions of the listing of the equipment or appliance or the manufacturer's [~~installation~~] instructions, the conditions of the listing and the manufacturer's [~~installation~~] instructions shall apply.

305.2 Hazardous area. Equipment and appliances having an ignition source shall not be installed in Group H occupancies or control areas where open use, handling or dispensing of combustible, flammable or explosive materials occurs.

305.3 Elevation of ignition source. Equipment and appliances having an ignition source shall be elevated such that the source of ignition is not less than 18 inches (~~[457]~~ 457.2 mm) above the floor in hazardous locations and public garages, private garages, repair garages, motor fuel-dispensing facilities and parking garages. For the purpose of this section, rooms or spaces that are not part of the living space of a dwelling unit and that communicate directly with a private garage through openings shall be considered to be part of the private garage.

Exception: Elevation of the ignition source is not required for appliances that are listed as flammable vapor ignition resistant.

305.3.1 Installation in residential garages. In residential garages where appliances are installed in a separate, enclosed space having access only from outside of the garage, such appliances shall be permitted to be installed at floor level, provided that the required combustion air is taken from the exterior of the garage.

305.3.2 Parking garages. Connection of a parking garage with any room in which there is a fuel-fired appliance shall be by means of a vestibule providing a two-doorway separation, except that a single door is permitted where the sources of ignition in the appliance are elevated in accordance with Section 305.3.

Exception: This section shall not apply to appliance installations complying with Section 305.4.

305.4 Public garages, motor fuel-dispensing facilities and repair garages. Appliances located in public garages, motor fuel-dispensing facilities, repair garages or other areas frequented by motor vehicles shall be installed [~~a minimum of~~] not less than 8 feet (~~[2438]~~ 2438.4 mm) above the floor. Where motor vehicles are capable of passing under an appliance, the appliance shall be installed at the clearances required by the appliance manufacturer and not less than 1 foot (~~[305]~~ 304.8 mm) higher than the tallest vehicle garage door opening.

Exceptions:

1. The requirements of this section shall not apply where the appliances are protected from motor vehicle impact and installed in accordance with Section 305.3 of this code and NFPA 30A.
2. Appliances installed in repair garages shall be separated from repair areas by walls or partitions, floors, or floor ceiling assemblies that are constructed so as to prohibit the transmission of vapors and having a fire-resistance rating of not less than 1 hour, and that have no openings in the wall separating the repair area within 8 feet ([2438] 2438.4 mm) of the floor. Wall penetration shall be firestopped. Air for combustion purposes shall be obtained from the outdoors. The heating room shall not be used for the storage of combustible materials.
3. Heating appliances for vehicle repair areas where there is no dispensing or transferring of Class I or Class II flammable or combustible liquids or liquefied petroleum gas shall be installed in accordance with NFPA 30A.

305.5 Private garages. Appliances located in private garages shall be installed with a minimum clearance of 6 feet ([1829] 1828.8 mm) above the floor.

Exception: The requirements of this section shall not apply where the appliances are protected from motor vehicle impact and installed in accordance with Section 305.3.

305.6 Construction and protection. Boiler rooms and furnace rooms shall be protected as required by the *New York City Building Code*.

305.7 Clearances from grade. [~~Appliances~~] Equipment and appliances installed at grade level shall be supported on a level concrete slab or other approved material extending not less than 3 inches ([76] 76.2 mm) above adjoining grade or shall be suspended not less than 6 inches ([152] 152.4 mm) above adjoining grade. Such supports shall be installed in accordance with the manufacturer's [~~installation~~] instructions.

305.8 Clearances to combustible construction. Heat-producing equipment and appliances shall be installed to maintain the required clearances to combustible construction as specified in the listing and manufacturer's instructions. Such clearances shall be reduced only in accordance with Section 308. Clearances to combustibles shall include such considerations as door swing, drawer pull, overhead projections or shelving and window swing. Devices, such as door stops or limits and closers, shall not be used to provide the required clearances.

305.9 Parking structures. Appliances installed in enclosed, basement and underground parking structures shall be installed in accordance with NFPA 88A.

305.10 Repair garages. Appliances installed in repair garages shall be installed in accordance with NFPA 30A. [~~a detached building or room, separated from repair areas by walls or partitions, floors or floor ceiling assemblies that are constructed so as to prohibit the transmission of vapors and having a fire-resistance rating of not less than 1 hour, and that have no openings in the wall separating the repair area within 8 feet (2438 mm) of the floor. Wall penetrations shall be firestopped. Air for combustion purposes shall be obtained from the outdoors. The appliance room shall not be used for the storage of combustible materials.]~~]

[Exceptions:]

- ~~[1. Overhead heaters where installed not less than 8 feet (2438 mm) above the floor shall be permitted.]~~
- ~~[2. Heating appliances for vehicle repair areas where there is no dispensing or transferring of Class I or II flammable or combustible liquids or liquefied petroleum gas shall be installed in accordance with NFPA 30A.]~~

305.11 Installation in aircraft hangars. Heaters in aircraft hangars shall be installed in accordance with NFPA 409.

305.12 Avoid strain on gas piping. Appliances shall be supported and connected to the piping so as not to exert undue strain on the connections.

**SECTION FGC 306
ACCESS AND SERVICE SPACE**

306.1 Clearances for maintenance and replacement. Appliances, control devices, heat exchangers and HVAC components shall be accessible for inspection, service, repair and replacement without disabling the function of a fire-resistance-rated assembly or removing permanent construction, other appliances, or any other piping or ducts not connected to the appliance being inspected, serviced, repaired or replaced. A level working space ~~[at least]~~ not less than 30 inches (762 mm) deep and 30 inches ~~[wide (762 mm) by]~~ (762 mm) wide shall be provided in front of the control side to service an appliance.

306.2 Appliances in rooms. Rooms containing appliances shall be provided with a door and an unobstructed passageway measuring not less than 36 inches (~~[914]~~ 914.4 mm) wide and 80 inches (2032 mm) high.

Exception: Within a dwelling unit, appliances installed in a compartment, alcove, basement or similar space shall be provided with access by an opening or door and an unobstructed passageway measuring not less than 24 inches (~~[610]~~ 609.6 mm) wide and large enough to allow removal of the largest appliance in the space, provided that a level service space of not less than 30 inches (762 mm) deep and the height of the appliance, but not less than 30 inches (762 mm), is present at the front or service side of the appliance with the door open.

306.3 Appliances in attics. Attics containing appliances shall be provided with an opening and unobstructed passageway large enough to allow removal of the largest appliance. The passageway shall be not ~~[be]~~ less than 30 inches (762 mm) high and 22 inches (~~[559]~~ 558.8 mm) wide and not more than 20 feet (6096 mm) in length when measured along the centerline of the passageway from the opening to the appliance. The passageway shall have continuous solid flooring not less than 24 inches (~~[610]~~ 609.6 mm) wide. A level service space not less than 30 inches (762 mm) deep and 30 inches (762 mm) wide shall be present at the front or service side of the appliance. The clear access opening dimensions shall be ~~[a minimum of]~~ not less than 20 inches by 30 inches (508 mm by 762 mm) ~~[;]~~ and large enough to allow removal of the largest component of the appliance.

Exceptions:

1. The passageway and level service space are not required where the appliance is capable of being serviced and removed through the required opening.
2. Where the passageway is not less than 6 feet (~~[1829]~~ 1828.8 mm) high and 24 inches (609.6 mm) wide for its entire length, the passageway shall be not greater than 50 feet (15 250 mm) in length.

306.3.1 Electrical requirements. A luminaire controlled by a switch located at the required passageway opening and a receptacle outlet shall be provided at or near the appliance location in accordance with the *New York City Electrical Code*.

306.4 Appliances under floors. Under-floor spaces containing appliances shall be provided with an access opening and unobstructed passageway large enough to remove the largest component of the appliance. The passageway shall be not ~~[be]~~ less than 30 inches (762 mm) high and 22 inches (~~[559]~~ 558.8 mm) wide, nor more than 20 feet (6096 mm) in length when measured along the centerline of the passageway from the opening to the appliance. A level service space not less than 30 inches (762 mm) deep and 30 inches (762 mm) wide shall be present at the front or service side of the appliance. If the depth of the passageway or the service space exceeds 12 inches (~~[305]~~ 304.8 mm) below the adjoining grade, the walls of the passageway shall be lined with concrete or masonry extending 4 inches (~~[102]~~ 101.6 mm) above the adjoining grade and having sufficient lateral-bearing capacity to resist collapse. ~~[If the depth of the passageway or the service space exceeds 12 inches (305 mm) below the adjoining grade, the walls of the passageway shall be lined with concrete or masonry extending 4 inches (102 mm) above the adjoining grade and having sufficient lateral-bearing capacity to resist collapse.]~~ The clear access opening dimensions shall be ~~[a minimum of]~~ not less than 22 inches by 30 inches (559) 558.8 mm by 762 mm, and large enough to allow removal of the largest appliance.

Exceptions:

1. The passageway is not required where the level service space is present when the access is open and the appliance is capable of being serviced and removed through the required opening.
2. Where the passageway is ~~[unobstructed and]~~ not less than 6 feet high (~~[1829]~~ 1828.8 mm) ~~[high]~~ and 22 inches (~~[559]~~ 558.8 mm) wide for its entire length, the passageway shall not be limited in length.

306.4.1 Electrical requirements. A luminaire controlled by a switch located at the required passageway opening and a receptacle outlet shall be provided at or near the appliance location in accordance with the *New York City Electrical Code*.

306.5 Equipment and appliances on roofs or elevated structures. Where equipment ~~[and]~~ or appliances requiring access are ~~[installed]~~ located on ~~[roofs or]~~ an elevated ~~[structures at]~~ structure or the roof of a ~~[height exceeding]~~ building such that personnel will have to climb higher than 16 feet (4877 mm) [such] above grade, roof, or floor level to access such equipment or appliances, an interior or exterior means of access shall be provided ~~[by a permanent approved means of]~~

~~access, the extent of which shall be from grade or floor level to the equipment and appliances' level service space].~~ Such access shall not require climbing over obstructions greater than 30 inches (762 mm) ~~[high]~~ in height or walking on roofs having a slope greater than 4 units vertical in 12 units horizontal (33-percent slope). Such access to the roof or elevated structure and access from the roof or elevated structure to equipment requiring maintenance shall not require the use of portable ladders. Where access involves climbing over parapet walls, the height shall be measured to the top of the parapet wall.

Permanent ladders installed to provide the required access shall comply with the following minimum design criteria [-]:

1. The side railing shall extend above the parapet or roof edge not less than 30 inches (762 mm).
2. Ladders shall have rung spacing not to exceed 12 inches (~~[305]~~ 304.8 mm) on center. The uppermost rung shall be not more than 24 inches (~~[610]~~ 609.6 mm) below the upper edge of the roof hatch, roof or parapet, as applicable.
3. Ladders shall have a toe spacing not less than 7 inches (~~[178]~~ 177.8 mm) deep.
4. There shall be ~~[a minimum of]~~ not less than 18 inches (~~[457]~~ 457.2 mm) between rails.
5. Rungs shall have a ~~[minimum]~~ diameter ~~[of]~~ not less than 0.75-inch (19 mm) and ~~[shall]~~ be capable of withstanding a 300-pound (136.1 kg) load.
6. Where a cage, well or ladder safety device is provided, ladders over 20 feet (6096 mm) in height shall be provided with landing platforms for each 30 feet (9144 mm) of height. Where a cage, well or ladder safety device is not provided, ladders over 20 feet (6096 mm) in height shall be provided with landing platforms for each 20 feet (6096 mm) in height. Landings shall be capable of withstanding a load of 100 pounds per square foot (488.2 kg/m²). ~~[Landing dimensions shall be not less than 30 inches (762 mm) and not less than 24 inches (610 mm) in width.]~~ A guardrail and toeboard shall be provided on all open sides of the landing.
7. ~~[Where ladder extensions are installed, the side rails of through or side step ladder extensions shall extend 3½ feet above the parapets and landings. For through ladder extensions, the rungs shall be omitted from the extensions and shall have not less than 18 inches nor more than 24 inches of clearance between rails. For side step or offset fixed ladder sections, at landings, the side rails and rungs shall be carried to the next regular rung beyond or above the 3½ feet minimum.]~~

Climbing clearance. The distance from the centerline of the rungs to the nearest permanent object on the climbing side of the ladder shall be not less than 30 inches (762 mm) measured perpendicular to the rungs. This distance shall be maintained from the point of ladder access to the bottom of the roof hatch. A minimum clear width of 15 inches (381 mm) shall be provided on both sides of the ladder measured from the midpoint of and parallel with the rungs, except where cages or wells are installed.

8. Landing required. The ladder shall be provided with a clear and unobstructed bottom landing area having a minimum dimension of 30 inches by 30 inches (762 mm by 762 mm) centered in front of the ladder.
 9. Ladders shall be protected against corrosion by approved means.
 10. Service personnel shall have access to ladders at all times.
 11. Where ladder extensions are installed, the side rails of through or side-step ladder extensions shall extend 3½ feet (1066.8 mm) above the parapets and landings. For through ladder extensions, the rungs shall be omitted from the extensions and shall have not less than 18 inches (457.2 mm) nor more than 24 inches (609.6 mm) of clearance between rails. For side-step or offset fixed ladder sections, at landings, the side rails and rungs shall be carried to the next regular rung beyond or above the 3½ feet (1066.8 mm) minimum.
- [9-] Catwalks installed to provide the required access shall be not less than 24 inches ([610] 609.6 mm) wide and shall have railings as required for service platforms.

Exception: This section shall not apply to Group R-3 occupancies.

306.5.1 Sloped roofs. Where appliances, equipment, fans or other components that require service are installed on a roof having a slope of 3 units vertical in 12 units horizontal (25-percent slope) or greater and having an edge more than 30 inches (762 mm) above grade at such edge, a level platform shall be provided on each side of the appliance or equipment to which access is required for service, repair or maintenance. The platform shall be not less than 30 inches (762 mm) in any dimension and shall be provided with guards. The guards shall extend not less than 42 inches ([1067] 1066.8 mm) above the platform, shall be constructed so as to prevent the passage of a 21-inch-diameter ([533] 533.4 mm) sphere and shall comply with the loading requirements for guards specified in the *New York City Building Code*. Access shall not require walking on roofs having a slope greater than 4 units vertical in 12 units horizontal (33-percent slope). Where access involves obstructions greater than 30 inches (762 mm) in height, such obstructions shall be provided with ladders installed in accordance with Section 306.5 or ~~[stairs]~~ stairways installed in accordance with the requirements specified in the *New York City Building Code* in the path of travel to and from appliances, fans or equipment requiring service.

306.5.2 Electrical requirements. A receptacle outlet shall be provided at or near the appliance location in accordance with the *New York City Electrical Code*.

306.6 Guards. Guards shall be provided where ~~[appliances, equipment or other]~~ various components that require service and roof hatch openings are located within 10 feet (3048 mm) of a roof edge or open side of a walking surface and such edge or open side is located more than 30 inches (762 mm) above the floor, roof, or grade below. The guard shall extend not less than 30 inches (762 mm) beyond each end of ~~[such appliances, fans or other]~~ components ~~[and roof hatch openings and the]~~ that require service. The top of the guard shall be located not less than 42 inches ([1067] 1066.8 mm) above the elevated surface adjacent to the guard. The guard shall be

constructed so as to prevent the passage of a 21-inch-diameter (~~533~~ 533.4 mm) sphere and shall comply with the loading requirements for guards specified in the *New York City Building Code*.

306.7 Rooftop access and obstructions. Equipment and appliances installed on rooftops of buildings shall be installed in accordance with the requirements of the *New York City Fire Code* regarding rooftop access and obstructions, and shall not obstruct or interfere with firefighting operations or the operation of any doors, windows, fire escapes, or other means of egress or other building components requiring operation or access.

SECTION FGC 307 CONDENSATE DISPOSAL

307.1 Evaporators and cooling coils. Condensate [~~drainage~~] drain systems shall be provided for equipment and appliances containing evaporators and cooling coils in accordance with the *New York City Mechanical Code*.

307.2 Fuel-burning appliances. Liquid combustion by-products of condensing appliances shall be collected and discharged to an approved plumbing fixture [~~;~~] or disposal area in accordance with the manufacturer's [~~installation~~] instructions. Condensate piping shall [~~be of approved corrosion-resistant material~~] conform to one of the standards listed in Section 803 of the *New York City Plumbing Code* and shall not be smaller than the drain connection on the appliance. Such piping shall maintain a minimum horizontal slope in the direction of discharge of not less than [~~one-eighth~~] $\frac{1}{8}$ unit vertical in 12 units horizontal (1-percent slope).

307.2.1 Condensate disposal. Condensate from all fuel-burning appliances and associated flues shall be neutralized to a pH of at least 6 and no more than 8 prior to disposal to a sanitary system.

307.3 Drain pipe materials and sizes. Components of the condensate disposal system shall be cast iron, galvanized steel, copper, cross-linked polyethylene, [~~polybutylene,~~] polyethylene, ABS, CPVC, or PVC pipe or tubing. Polypropylene tubing may be used in lengths that do not exceed 12 inches (304.8 mm) for an individual drain application. [~~All components~~] Components shall be selected for the pressure and temperature rating of the installation. Joints and connections shall be made in accordance with the applicable provisions of Chapter 7 of the *New York City Plumbing Code* relative to the material type. Condensate waste and drain line size shall be not less than $\frac{3}{4}$ -inch (~~19~~) 19.1 mm) internal diameter and shall not decrease in size from the drain pan connection to the place of condensate disposal. Where the drain pipes from more than one unit are manifolded together for condensate drainage, the pipe or tubing shall be sized by a registered design professional.

307.4 Traps. Condensate drains shall be trapped as required by the equipment or appliance manufacturer.

307.5 Auxiliary drain pan. Category II or Category IV condensing appliances shall be provided with an auxiliary drain pan where damage to any building component will occur as a result of stoppage in the condensate drainage system. Such pan shall be installed in accordance with the applicable provisions of Section 307 of the *New York City Mechanical Code* and provided with a local alarm to indicate the collection of water.

[Exception] Exceptions:

1. An auxiliary drain pan shall not be required for appliances that automatically shut down operation in the event of a stoppage in the condensate drainage system.
2. An auxiliary drain pan shall not be required where a suitably sized and located floor drain is provided.

307.6 Condensate pumps. Condensate pumps located in uninhabitable spaces, such as attics and crawl spaces, shall be connected to the appliance or equipment served such that when the pump fails, the appliance or equipment will be prevented from operating. Pumps shall be installed in accordance with the manufacturer's instructions.

Exceptions:

1. Equipment shutdown shall not be required when the condensate pump resides within the auxiliary drain pan provided under Section 307.5 and an alternate means for unit shutdown due to condensate overflow or leakage, such as a leak detector, is provided.
2. Equipment shutdown shall not be required when the potential for freezing of interior piping systems exists and the auxiliary drain pan provided under Section 307.5 is equipped with a secondary overflow drain that shall discharge to a conspicuous point of disposal to alert occupants in the event of a stoppage of the primary drain.

307.7 Drain line maintenance. Condensate drain lines shall be configured to permit the clearing of blockages and performance of maintenance without requiring the drain line to be cut.

SECTION FGC 308 CLEARANCE REDUCTION

308.1 Scope. This section shall govern the reduction in required clearances to gypsum board, combustible materials and combustible assemblies for chimneys, vents, appliances, devices and equipment. Clearance requirements for air-conditioning equipment and central heating boilers and furnaces shall comply with Sections 308.3 and 308.4.

308.2 Reduction table. The allowable clearance reduction shall be based on one of the methods specified in Table 308.2 or shall utilize ~~[an]~~ a reduced clearance protective assembly listed ~~[for such application]~~ and labeled in accordance with UL 1618. Where required clearances are not listed in Table 308.2, the reduced clearances shall be determined by linear interpolation between the distances listed in the table. Reduced clearances shall not be derived by extrapolation below the range of the table. The reduction of the required clearances to combustibles for listed and labeled appliances and equipment shall be in accordance with the requirements of this section except that such clearances shall not be reduced where reduction is specifically prohibited by the terms of the appliance or equipment listing ~~[]~~ (see Figures 308.2(1) through 308.2(3) ~~[]~~).

TABLE 308.2^a through k
REDUCTION OF CLEARANCES WITH SPECIFIED FORMS OF PROTECTION

TYPE OF PROTECTION APPLIED TO AND COVERING ALL SURFACES OF COMBUSTIBLE MATERIAL WITHIN THE DISTANCE SPECIFIED AS THE REQUIRED CLEARANCE WITH NO PROTECTION [see Figures 308.2(1), 308.2(2), and 308.2(3)]	WHERE THE REQUIRED CLEARANCE WITH NO PROTECTION FROM APPLIANCE, VENT CONNECTOR, OR SINGLE-WALL METAL PIPE IS: (inches)									
	36		18		12		9		6	
	Allowable clearances with specified protection (inches)									
	Use Column 1 for clearances above appliance or horizontal connector. Use Column 2 for clearances from appliance, vertical connector and single-wall metal pipe.									
	Above Col. 1	Sides and rear Col. 2	Above Col. 1	Sides and rear Col. 2	Above Col. 1	Sides and rear Col. 2	Above Col. 1	Sides and rear Col. 2	Above Col. 1	Sides and rear Col. 2
1. 3½-inch-thick masonry wall without ventilated air space airspace	—	24	—	12	—	9	—	6	—	5
2. ½-inch insulation board over 1-inch glass fiber or mineral wool batts	24	18	12	9	9	6	6	5	4	3
3. 0.0296 (No. 22 gauge) galvanized sheet metal over 1-inch glass fiber or mineral wool batts reinforced with wire on rear face with ventilated airspace	18	12	9	6	6	4	5	3	3	3
4. 3½-inch-thick masonry wall with ventilated airspace	—	12	—	6	—	6	—	6	—	6
5. 0.024-inch (nominal 24 gage) sheet metal with ventilated airspace	18	12	9	6	6	4	5	3	3	[3] 2
6. ½-inch-thick insulation board with ventilated airspace	18	12	9	6	6	4	5	3	3	3
7. 0.024-inch (nominal 24 gage) sheet metal with ventilated airspace over 0.024-inch (nominal 24 gage) sheet metal with ventilated airspace	18	12	9	6	6	4	5	3	3	3

TABLE 308.2^a through k
REDUCTION OF CLEARANCES WITH SPECIFIED FORMS OF PROTECTION

TYPE OF PROTECTION APPLIED TO AND COVERING ALL SURFACES OF COMBUSTIBLE MATERIAL WITHIN THE DISTANCE SPECIFIED AS THE REQUIRED CLEARANCE WITH NO PROTECTION [see Figures 308.2(1), 308.2(2), and 308.2(3)]	WHERE THE REQUIRED CLEARANCE WITH NO PROTECTION FROM APPLIANCE, VENT CONNECTOR, OR SINGLE-WALL METAL PIPE IS: (inches)									
	36		18		12		9		6	
	Allowable clearances with specified protection (inches)									
	Use Column 1 for clearances above appliance or horizontal connector. Use Column 2 for clearances from appliance, vertical connector and single-wall metal pipe.									
	Above Col. 1	Sides and rear Col. 2	Above Col. 1	Sides and rear Col. 2	Above Col. 1	Sides and rear Col. 2	Above Col. 1	Sides and rear Col. 2	Above Col. 1	Sides and rear Col. 2
8. 1-inch glass fiber or mineral wool batts sandwiched between two sheets 0.024-inch (nominal 24 gage) sheet metal with ventilated airspace	18	12	9	6	6	4	5	3	3	3

For SI: 1 inch = 25.4 mm, °C = [(°F - 32)/1.8], 1 pound per cubic foot = 16.02 kg/m³, 1 Btu per inch per square foot per hour per °F = 0.144 W/m²·K.

- Reduction of clearances from combustible materials shall not interfere with combustion air, draft hood clearance and relief, and accessibility of servicing.
- All clearances shall be measured from the outer surface of the combustible material to the nearest point on the surface of the appliance, disregarding any intervening protection applied to the combustible material.
- Spacers and ties shall be of noncombustible material. No spacer or tie shall be used directly opposite an appliance or connector.
- For all clearance reduction systems using a ventilated airspace, adequate provision for air circulation shall be provided as described [see Figures 308.2(2) and 308.2(3)].
- There shall be [at least] not less than 1 inch between clearance reduction systems and combustible walls and ceilings for reduction systems using ventilated airspace.
- Where a wall protector is mounted on a single flat wall away from corners, it shall have a minimum 1-inch air gap. To provide air circulation, the bottom and top edges, or only the side and top edges, or all edges shall be left open.
- Mineral wool batts (blanket or board) shall have a minimum density of 8 pounds per cubic foot and a minimum melting point of 1500°F.
- Insulation material used as part of a clearance reduction system shall have a thermal conductivity of 1.0 Btu per inch per square foot per hour per °F or less.
- There shall be [at least] not less than 1 inch between the appliance and the protector. In no case shall the clearance between the appliance and the combustible surface be reduced below that allowed in this table.
- All clearances and thicknesses are minimum; larger clearances and thicknesses are acceptable.
- Listed single-wall connectors shall be installed in accordance with the [terms of their listing and the] manufacturer's [installation] instructions.

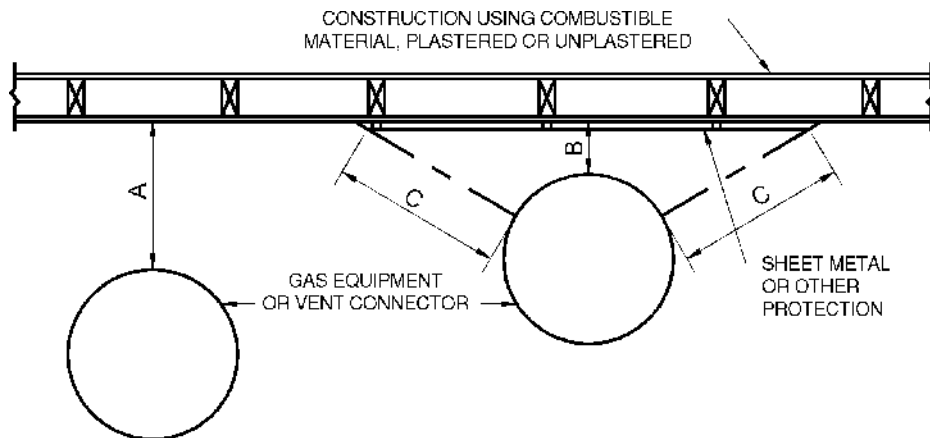

Notes:
 "A" equals the [reduced] clearance with no protection.
 "B" equals the reduced clearance permitted in accordance with Table 308.2. The protection applied to the construction using combustible material shall extend far enough in each direction to make "C" equal to "A."

FIGURE 308.2(1)
EXTENT OF PROTECTION NECESSARY TO REDUCE CLEARANCES FROM [GAS EQUIPMENT] APPLIANCE OR VENT CONNECTIONS

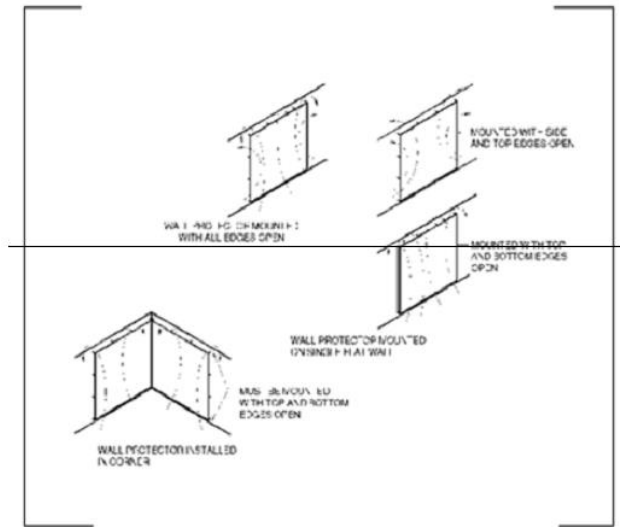

[For SI: 1 inch = 25.4 mm.]

[FIGURE 308.2(2)
WALL PROTECTOR CLEARANCE REDUCTION SYSTEM]

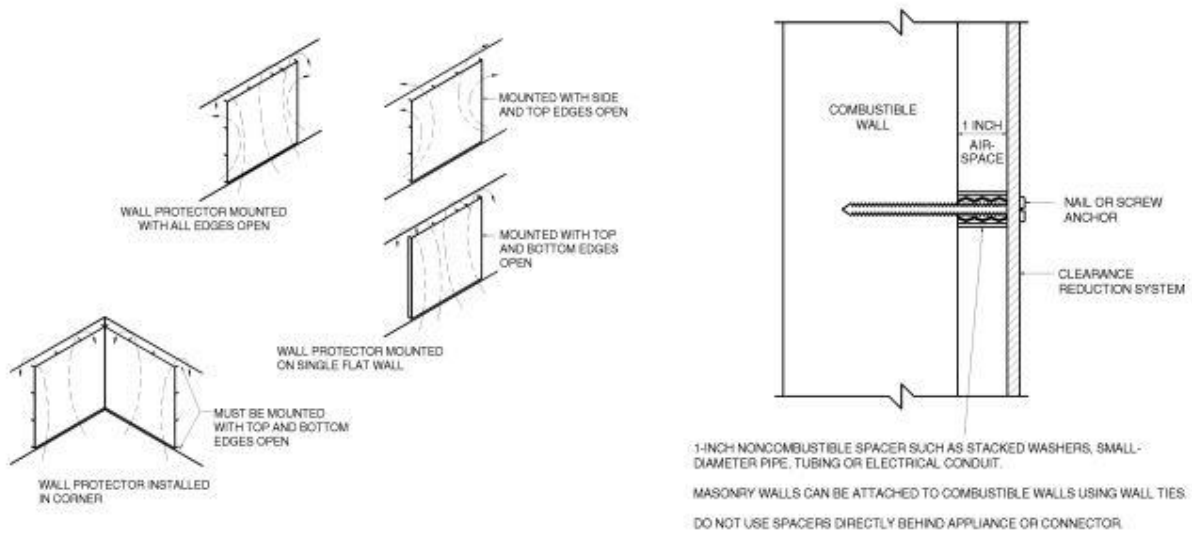

For SI: 1 inch = 25.4 mm.

FIGURE 308.2(2)
WALL PROTECTOR CLEARANCE REDUCTION SYSTEM

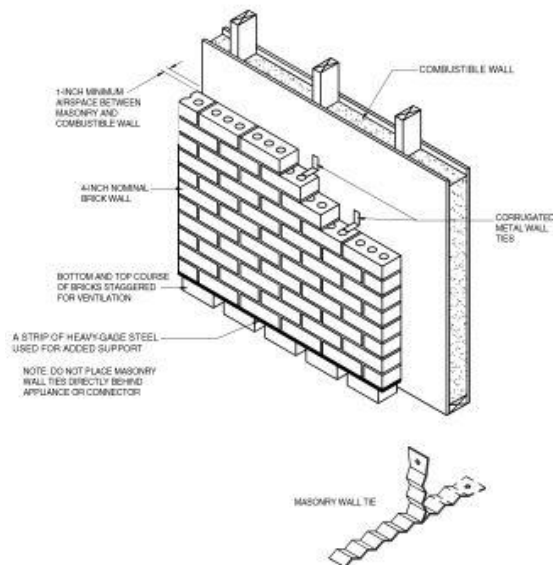

For SI: 1 inch = 25.4 mm.

FIGURE 308.2(3)
MASONRY CLEARANCE REDUCTION SYSTEM

308.3 Clearances for indoor air-conditioning appliances. Clearance requirements for indoor air-conditioning equipment shall comply with Sections 308.3.1 through ~~308.3.5~~ 308.3.4.

308.3.1 ~~[Appliances installed in rooms that are large in comparison with the size of the appliance.]~~ **Appliance clearances.** Air-conditioning appliances ~~installed in rooms that are large in comparison with the size of the appliance]~~ shall be installed with clearances in accordance with the terms of their listing and the manufacturer's instructions.

308.3.2 ~~[Appliances installed in rooms that are not large in comparison with the size of the appliance.~~ Air conditioning appliances installed in rooms that are not large in comparison with the size of the appliance, such as alcoves and closets, shall be listed for such installations and installed in accordance with the manufacturer's instructions. Listed clearances shall not be reduced by the protection methods described in Table 308.2, regardless of whether the enclosure is of combustible or noncombustible material.]

~~308.3.3~~ **Clearance reduction.** Air-conditioning appliances ~~[installed in rooms that are large in comparison with the size of the appliance]~~ shall be permitted to be installed with reduced clearances to combustible material, provided that the combustible material or appliance is protected as described in Table 308.2 and such reduction is allowed by the manufacturer's instructions.

~~308.3.4~~ **308.3.3 Plenum clearances.** Where the furnace plenum is adjacent to plaster on metal lath or noncombustible material attached to combustible material, the clearance shall be

measured to the surface of the plaster or other noncombustible finish where the clearance specified is 2 inches (~~51~~ 50.8 mm) or less.

~~[308.3.5]~~ **308.3.4 Clearance from supply ducts.** ~~[Air conditioning appliance shall]~~ Supply air ducts connecting to listed central heating furnaces shall have the same minimum clearance from supply ducts within 3 feet (914 mm) of to combustibles as required for the furnace supply plenum ~~[be]~~ for a distance of not less than [that specified] 3 feet (914.4 mm) from the [furnace] supply plenum. Clearance is not ~~[necessary]~~ required beyond ~~[this]~~ the 3-foot (914.4 mm) distance.

308.4 Central-heating boilers and furnaces. Clearance requirements for central-heating boilers and furnaces shall comply with Sections 308.4.1 through ~~[308.4.6]~~ 308.4.5. The clearance to these appliances shall not interfere with combustion air ~~[;]~~; draft hood clearance and relief ~~[;]~~; and accessibility for servicing.

308.4.1 ~~[Appliances installed in rooms that are large in comparison with the size of the appliance.]~~ **Appliance clearances.** Central-heating furnaces and low-pressure boilers ~~[installed in rooms large in comparison with the size of the appliance]~~ shall be installed with clearances in accordance with the ~~[terms of their listing and the]~~ manufacturer's instructions.

308.4.2 ~~[Appliances installed in rooms that are not large in comparison with the size of the appliance.~~ Central heating furnaces and low pressure boilers installed in rooms that are not large in comparison with the size of the appliance, such as alcoves and closets, shall be listed for such installations. ~~Listed clearances shall not be reduced by the protection methods described in Table 308.2 and illustrated in Figures 308.2(1) through 308.2(3), regardless of whether the enclosure is of combustible or noncombustible material.]~~

~~[308.4.3]~~ **Clearance reduction.** Central-heating furnaces and low-pressure boilers ~~[installed in rooms that are large in comparison with the size of the appliance]~~ shall be permitted to be installed with reduced clearances to combustible material provided that such reduction is allowed by the manufacturer's instructions and the combustible material or appliance is protected as described in Table 308.2.

~~[308.4.4]~~ **308.4.3 Clearance for servicing appliances.** Front clearance shall be sufficient for servicing the burner and the furnace or boiler.

~~[308.4.5]~~ **308.4.4 Plenum clearances.** Where the furnace plenum is adjacent to plaster on metal lath or noncombustible material attached to combustible material, the clearance shall be measured to the surface of the plaster or other noncombustible finish where the clearance specified is 2 inches (~~51~~ 50.8 mm) or less.

~~[308.4.6]~~ **308.4.5 Clearance from supply ducts.** ~~[Central heating furnaces shall have the clearance from supply ducts within 3 feet (914 mm) of the furnace plenum be not less than that specified from the furnace plenum. No clearance is necessary beyond this distance]~~ Supply air ducts connecting to listed central heating furnaces shall have the same minimum clearance to combustibles as required for the furnace supply plenum for a distance of not less than 3 feet (914.4 mm) from the supply plenum. Clearance is not required beyond the 3-foot (914.4 mm) distance.

**SECTION FGC 309
ELECTRICAL**

309.1 Grounding. Gas piping shall not be used as a grounding electrode.

309.2 Connections. Electrical connections between appliances and the building wiring, including the grounding of the ~~[appliance]~~ appliances, shall conform to the *New York City Electrical Code*.

**SECTION FGC 310
ELECTRICAL BONDING**

310.1 Pipe and tubing. Each above-ground portion of a gas piping system that is likely to become energized shall be continuously bonded electrically to an effective ground-fault current path. Gas piping shall be considered to be bonded where it is connected to appliances that are connected to the equipment grounding conductor of the circuit supplying that appliance.

§ 5. Chapter 4 of the New York city fuel gas code, as amended by local law number 141 for the year 2013, is amended to read as follows:

**CHAPTER 4
GAS PIPING INSTALLATIONS**

**SECTION FGC 401
GENERAL**

401.1 Scope. This chapter shall govern the design, installation, modification and maintenance of fuel-gas piping systems. The scope covered by this chapter includes piping systems from the point of delivery to the connections with the appliances and includes the design, materials, components, fabrication, assembly, installation, testing, inspection, operation and maintenance of such piping systems.

401.1.1 Meters and service piping. Service piping includes the fuel-gas piping up to the point of delivery. Meters and service piping shall comply with the requirements of Appendix E [~~of this code~~]. In addition, service piping located within buildings shall be designed and installed in accordance with the structural integrity, firestopping, and fire protection provisions of the *New York City Building Code*.

401.1.2 ~~[Reserved.] Meters for gas consumption monitoring.~~ Approved gas meters shall be permitted to be installed for gas consumption monitoring, energy measurement, verification and analysis. Gas meters shall be listed in accordance with ANSI B109.1, ANSI B109.2, or ANSI B109.3 and installed in accordance with the manufacturer's instructions. A full size valve bypass shall be provided around gas meters for maintenance and repair.

401.2 Reserved.

401.3 Modifications to existing systems. In modifying or adding to existing piping systems, sizes shall be maintained in accordance with this chapter.

401.4 Additional appliances. Where an additional appliance is to be served, the existing piping shall be checked to determine if it has adequate capacity for all appliances served. If inadequate, the existing system shall be enlarged as required or separate piping of adequate capacity shall be provided.

401.5 Identification. All piping installed in new construction and all new piping installed in existing buildings, whether or not the piping is intended to be enclosed when construction is completed, shall be identified by a yellow label marked “Gas” in black letters. Where the installation requires a gas test, such labeling shall be completed prior to such test. Labels shall be provided in accordance with ASME A13.1 and the marking shall be spaced at intervals not exceeding 5 feet (1524 mm). The marking shall not be required on pipe located in the same room as the appliance served.

401.6 Interconnections. Where two or more meters are installed on the same premises but supply separate consumers, the piping systems shall not be interconnected on the outlet side of the meters.

401.7 Piping meter identification. Piping from multiple meter installations shall be marked with an approved permanent identification by the installer so that the piping system supplied by each meter is readily identifiable. Such marking shall be in accordance with ASME A13.1.

401.8 Minimum sizes. ~~[All pipe]~~ Pipe utilized for the installation, extension and alteration of any piping system shall be sized to supply the full number of outlets for the intended purpose and shall be sized in accordance with Section 402.

401.9 Identification. Each length of pipe and each pipe fitting, utilized in a fuel gas system, shall bear the identification of the manufacturer.

401.10 Third-party testing and certification. Piping, tubing and fittings shall comply with the applicable referenced standards, specifications and performance criteria of this code and shall be identified in accordance with Section 401.9. Piping, tubing and fittings shall either be tested by an approved third-party testing agency or certified by an approved third-party certification agency.

SECTION FGC 402 PIPE SIZING

402.1 General considerations. Piping systems shall be of such size and so installed as to provide a supply of gas sufficient to meet the maximum demand and supply gas to each appliance inlet at not less than the minimum supply pressure required by the appliance.

402.2 Maximum gas demand. The ~~[volume]~~ volumetric flow rate of gas to be provided ~~[, in cubic feet per hour,]~~ shall be ~~[determined directly from]~~ the ~~[manufacturer’s input ratings]~~ sum of the ~~[appliance]~~ maximum input of the appliances served. ~~[Where an input rating is not indicated, the gas supplier, appliance manufacturer or a qualified agency shall be contacted, or the rating from Table 402.2 shall be used for estimating the volume of gas to be supplied.]~~

The total connected hourly load shall be used as the basis for pipe sizing, [appliances] assuming that all [equipment] appliances could be operating at full capacity simultaneously. Where a diversity of load can be established, pipe sizing shall be permitted to be based on such loads.

The volumetric flow rate of gas to be provided shall be adjusted for altitude where the installation is above 2,000 feet (610 m) in elevation.

**[TABLE 402.2
APPROXIMATE GAS INPUT FOR TYPICAL APPLIANCES**

APPLIANCE	INPUT BTU/H (Approx.)
Space Heating Units	
Hydronic boiler	
Single family	100,000
Multifamily, per unit	60,000
Warm air furnace	
Single family	100,000
Multifamily, per unit	60,000
Space and Water Heating Units	
Hydronic boiler	
Single family	120,000
Multifamily, per unit	75,000
Water Heating Appliances	
Water heater, automatic instantaneous	
Capacity at 2 gal./minute	142,800
Capacity at 4 gal./minute	285,000
Capacity at 6 gal./minute	428,400
Water heater, automatic storage, 30 to 40 gal. tank	35,000
Water heater, automatic storage, 50 gal.	50,000
Water heater, domestic, circulating or side arm	35,000
Cooking Appliances	
Built in oven or broiler unit, domestic	25,000
Built in top unit, domestic	40,000
Range, free standing, domestic	65,000
Other Appliances	
Barbecue	40,000
Clothes dryer, Type 1 (domestic)	35,000
Gas fireplace, direct vent	40,000
Gas light	2,500
Gas log	80,000
Refrigerator	3,000

For SI: British thermal unit per hour = 0.293 W, 1 gallon = 3.785 L, 1 gallon per minute = 3.785 L/m³

402.3 Sizing. Gas piping shall be sized in accordance with one of the following:

1. Pipe sizing tables or sizing equations in accordance with Section 402.4.
2. The sizing tables included in a listed piping system's manufacturer's ~~installation~~ instructions.
3. Other approved engineering methods.
4. Individual outlets to gas ranges shall not be less than ¾ inches (~~[19]~~19.1 mm) NPS.

402.4 Sizing tables and equations. Where Tables 402.4(1) through ~~[402.4(5)]~~ 402.4(7) are used to size piping or tubing, the pipe length shall be determined in accordance with Section 402.4.1, 402.4.2 or 402.4.3.

Where Equations 4-1 and 4-2 are used to size piping or tubing, the pipe or tubing shall have smooth inside walls and the pipe length shall be determined in accordance with Section 402.4.1, 402.4.2 or 402.4.3.

1. Low-pressure gas equation (Less than 1½ pounds per square inch (psi) (10.3 kPa)):

$$D = \frac{Q^{0.381}}{19.17 \left(\frac{\Delta H}{C_r \times L} \right)^{0.206}} \quad \text{(Equation 4-1)}$$

2. High-pressure gas equation (1½ psi (10.3 kPa) and above):

$$D = \frac{Q^{0.381}}{18.93 \left\{ \frac{(P_1^2 - P_2^2) \times Y}{C_r \times L} \right\}^{0.206}} \quad \text{(Equation 4-2)}$$

where:

- D = Inside diameter of pipe, inches (mm).
- Q = Input rate appliance(s), cubic feet per hour at 60°F (~~[16]~~15.6°C) and 30-inch mercury column.
- P₁ = Upstream pressure, psia (P₁ + 14.7).
- P₂ = Downstream pressure, psia (P₂ + 14.7).
- L = Equivalent length of pipe, feet.
- ΔH = Pressure drop, inch water column (27.7 inch water column = 1 psi).

**TABLE 402.4
C_r AND Y VALUES FOR NATURAL GAS
AT STANDARD CONDITIONS**

GAS	EQUATION FACTORS	
	C _r	Y
Natural gas	0.6094	0.9992

For SI: 1 cubic foot = 0.028 m³, 1 foot = 305 mm, 1-inch water column = 0.2488 kPa, 1 pound per square inch = 6.895 kPa, 1 British thermal unit per hour = 0.293 W.

**TABLE 402.4(1)
SCHEDULE 40 METALLIC PIPE**

Gas													Natural	
Inlet Pressure													Less than 2 psi	
Pressure Drop													0.3 in. w.c.	
Specific Gravity													0.60	
PIPE SIZE (inch)														
Nominal	½	¾	1	1¼	1½	2	2½	3	4	5	6	8	10	12
Actual ID	0.622	0.824	1.049	1.380	1.610	2.067	2.469	3.068	4.026	5.047	6.065	7.981	10.020	11.938
Length (ft)	Capacity in Cubic Feet of Gas Per Hour													
10	131	273	514	1,060	1,580	3,050	4,860	8,580	17,500	31,700	51,300	105,00	191,00	303,00
20	90	188	353	726	1,090	2,090	3,340	5,900	12,000	21,800	35,300	72,400	132,00	208,00
30	72	151	284	583	873	1,680	2,680	4,740	9,660	17,500	28,300	58,200	106,00	167,000
40	62	129	243	499	747	1,440	2,290	4,050	8,270	15,000	24,200	49,800	90,400	143,000
50	55	114	215	442	662	1,280	2,030	3,590	7,330	13,300	21,500	44,100	80,100	127,000
60	50	104	195	400	600	1,160	1,840	3,260	6,640	12,000	19,500	40,000	72,600	115,000
70	46	95	179	368	552	1,060	1,690	3,000	6,110	11,100	17,900	36,800	66,800	106,000
80	42	89	167	343	514	989	1,580	2,790	5,680	10,300	16,700	34,200	62,100	98,400
90	40	83	157	322	482	928	1,480	2,610	5,330	9,650	15,600	32,100	58,300	92,300
100	38	79	148	304	455	877	1,400	2,470	5,040	9,110	14,800	30,300	55,100	87,200
125	33	70	131	269	403	777	1,240	2,190	4,460	8,080	13,100	26,900	48,800	77,300
150	30	63	119	244	366	704	1,120	1,980	4,050	7,320	11,900	24,300	44,200	70,000
175	28	58	109	224	336	648	1,030	1,820	3,720	6,730	10,900	22,400	40,700	64,400
200	26	54	102	209	313	602	960	1,700	3,460	6,260	10,100	20,800	37,900	59,900
250	23	48	90	185	277	534	851	1,500	3,070	5,550	8,990	18,500	33,500	53,100
300	21	43	82	168	251	484	771	1,360	2,780	5,030	8,150	16,700	30,400	48,100
350	19	40	75	154	231	445	709	1,250	2,560	4,630	7,490	15,400	28,000	44,300
400	18	37	70	143	215	414	660	1,170	2,380	4,310	6,970	14,300	26,000	41,200
450	17	35	66	135	202	389	619	1,090	2,230	4,040	6,540	13,400	24,400	38,600
500	16	33	62	127	191	367	585	1,030	2,110	3,820	6,180	12,700	23,100	36,500
550	15	31	59	121	181	349	556	982	2,000	3,620	5,870	12,100	21,900	34,700
600	14	30	56	115	173	333	530	937	1,910	3,460	5,600	11,500	20,900	33,100
650	14	29	54	110	165	318	508	897	1,830	3,310	5,360	11,000	20,000	31,700
700	13	27	52	106	159	306	488	862	1,760	3,180	5,150	10,600	19,200	30,400
750	13	26	50	102	153	295	470	830	1,690	3,060	4,960	10,200	18,500	29,300
800	12	26	48	99	148	285	454	802	1,640	2,960	4,790	9,840	17,900	28,300
850	12	25	46	95	143	275	439	776	1,580	2,860	4,640	9,530	17,300	27,400
900	11	24	45	93	139	267	426	752	1,530	2,780	4,500	9,240	16,800	26,600
950	11	23	44	90	135	259	413	731	1,490	2,700	4,370	8,970	16,300	25,800
1,000	11	23	43	87	131	252	402	711	1,450	2,620	4,250	8,720	15,800	25,100
1,100	10	21	40	83	124	240	382	675	1,380	2,490	4,030	8,290	15,100	23,800
1,200	NA	20	39	79	119	229	364	644	1,310	2,380	3,850	7,910	14,400	22,700
1,300	NA	20	37	76	114	219	349	617	1,260	2,280	3,680	7,570	13,700	21,800
1,400	NA	19	35	73	109	210	335	592	1,210	2,190	3,540	7,270	13,200	20,900
1,500	NA	18	34	70	105	203	323	571	1,160	2,110	3,410	7,010	12,700	20,100
1,600	NA	18	33	68	102	196	312	551	1,120	2,030	3,290	6,770	12,300	19,500
1,700	NA	17	32	66	98	189	302	533	1,090	1,970	3,190	6,550	11,900	18,800
1,800	NA	16	31	64	95	184	293	517	1,050	1,910	3,090	6,350	11,500	18,300

TABLE 402.4(1)
SCHEDULE 40 METALLIC PIPE

Gas														Natural
Inlet Pressure														Less than 2 psi
Pressure Drop														0.3 in. w.c.
Specific Gravity														0.60
PIPE SIZE (inch)														
Nominal	½	¾	1	1¼	1½	2	2½	3	4	5	6	8	10	12
Actual ID	0.622	0.824	1.049	1.380	1.610	2.067	2.469	3.068	4.026	5.047	6.065	7.981	10.020	11.938
Length (ft)	Capacity in Cubic Feet of Gas Per Hour													
1,900	NA	16	30	62	93	178	284	502	1,020	1,850	3,000	6,170	11,200	17,700
2,000	NA	16	29	60	90	173	276	488	1,000	1,800	2,920	6,000	10,900	17,200

For SI: 1 inch = 25.4 mm, 1 foot = 304.8 mm, 1 pound per square inch = 6.895 kPa, 1-inch water column = 0.2488 kPa, 1 British thermal unit per hour = 0.2931 W, 1 cubic foot per hour = 0.0283 m³/h, 1 degree = 0.01745 rad.

Notes:

1. NA means a flow of less than 10 cfh.
2. All table entries have been rounded to three significant digits.

TABLE 402.4(2)
SCHEDULE 40 METALLIC PIPE

Gas														Natural
Inlet Pressure														Less than 2 psi
Pressure Drop														0.5 inch in. w.c.
Specific Gravity														0.60
PIPE SIZE (inch)														
Nominal	½	¾	1	1¼	1½	2	2½	3	4	5	6	8	10	12
Actual ID	0.622	0.824	1.049	1.380	1.610	2.067	2.469	3.068	4.026	5.047	6.065	7.981	10.020	11.938
Length (ft)	Capacity in Cubic Feet of Gas Per Hour													
10	172	360	678	1,390	2,090	4,020	6,400	11,300	23,100	41,800	67,600	139,000	252,000	399,000
20	118	247	466	957	1,430	2,760	4,400	7,780	15,900	28,700	46,500	95,500	173,000	275,000
30	95	199	374	768	1,150	2,220	3,530	6,250	12,700	23,000	37,300	76,700	139,000	220,000
40	81	170	320	657	985	1,900	3,020	5,350	10,900	19,700	31,900	65,600	119,000	189,000
50	72	151	284	583	873	1,680	2,680	4,740	9,660	17,500	28,300	58,200	106,000	167,000
60	65	137	257	528	791	1,520	2,430	4,290	8,760	15,800	25,600	52,700	95,700	152,000
70	60	126	237	486	728	1,400	2,230	3,950	8,050	14,600	23,600	48,500	88,100	139,000
80	56	117	220	452	677	1,300	2,080	3,670	7,490	13,600	22,000	45,100	81,900	130,000
90	52	110	207	424	635	1,220	1,950	3,450	7,030	12,700	20,600	42,300	76,900	122,000
100	50	104	195	400	600	1,160	1,840	3,260	6,640	12,000	19,500	40,000	72,600	115,000
125	44	92	173	355	532	1,020	1,630	2,890	5,890	10,600	17,200	35,400	64,300	102,000
150	40	83	157	322	482	928	1,480	2,610	5,330	9,650	15,600	32,100	58,300	92,300
175	37	77	144	296	443	854	1,360	2,410	4,910	8,880	14,400	29,500	53,600	84,900
200	34	71	134	275	412	794	1,270	2,240	4,560	8,260	13,400	27,500	49,900	79,000
250	30	63	119	244	366	704	1,120	1,980	4,050	7,320	11,900	24,300	44,200	70,000
300	27	57	108	221	331	638	1,020	1,800	3,670	6,630	10,700	22,100	40,100	63,400
350	25	53	99	203	305	587	935	1,650	3,370	6,100	9,880	20,300	36,900	58,400
400	23	49	92	189	283	546	870	1,540	3,140	5,680	9,190	18,900	34,300	54,300
450	22	46	86	177	266	512	816	1,440	2,940	5,330	8,620	17,700	32,200	50,900
500	21	43	82	168	251	484	771	1,360	2,780	5,030	8,150	16,700	30,400	48,100
550	20	41	78	159	239	459	732	1,290	2,640	4,780	7,740	15,900	28,900	45,700

TABLE 402.4(2)
SCHEDULE 40 METALLIC PIPE

Gas		Natural												
Inlet Pressure		Less than 2 psi												
Pressure Drop		0.5 [inch] <u>in.</u> w.c.												
Specific Gravity		0.60												
PIPE SIZE (inch)														
Nominal	<u>½</u>	<u>¾</u>	<u>1</u>	<u>1¼</u>	<u>1½</u>	<u>2</u>	<u>2½</u>	<u>3</u>	<u>4</u>	<u>5</u>	<u>6</u>	<u>8</u>	<u>10</u>	<u>12</u>
Actual ID	0.622	0.824	1.049	1.380	1.610	2.067	2.469	3.068	4.026	5.047	6.065	7.981	10.020	11.938
Length (ft)	Capacity in Cubic Feet of Gas Per Hour													
600	19	39	74	152	228	438	699	1,240	2,520	4,560	7,380	15,200	27,500	43,600
650	18	38	71	145	218	420	669	1,180	2,410	4,360	7,070	14,500	26,400	41,800
700	17	36	68	140	209	403	643	1,140	2,320	4,190	6,790	14,000	25,300	40,100
750	17	35	66	135	202	389	619	1,090	2,230	4,040	6,540	13,400	24,400	38,600
800	16	34	63	130	195	375	598	1,060	2,160	3,900	6,320	13,000	23,600	37,300
850	16	33	61	126	189	363	579	1,020	2,090	3,780	6,110	12,600	22,800	36,100
900	15	32	59	122	183	352	561	992	2,020	3,660	5,930	12,200	22,100	35,000
950	15	31	58	118	178	342	545	963	1,960	3,550	5,760	11,800	21,500	34,000
1,000	14	30	56	115	173	333	530	937	1,910	3,460	5,600	11,500	20,900	33,100
1,100	14	28	53	109	164	316	503	890	1,810	3,280	5,320	10,900	19,800	31,400
1,200	13	27	51	104	156	301	480	849	1,730	3,130	5,070	10,400	18,900	30,000
1,300	12	26	49	100	150	289	460	813	1,660	3,000	4,860	9,980	18,100	28,700
1,400	12	25	47	96	144	277	442	781	1,590	2,880	4,670	9,590	17,400	27,600
1,500	11	24	45	93	139	267	426	752	1,530	2,780	4,500	9,240	16,800	26,600
1,600	11	23	44	89	134	258	411	727	1,480	2,680	4,340	8,920	16,200	25,600
1,700	11	22	42	86	130	250	398	703	1,430	2,590	4,200	8,630	15,700	24,800
1,800	10	22	41	84	126	242	386	682	1,390	2,520	4,070	8,370	15,200	24,100
1,900	10	21	40	81	122	235	375	662	1,350	2,440	3,960	8,130	14,800	23,400
2,000	NA	20	39	79	119	229	364	644	1,310	2,380	3,850	7,910	14,400	22,700

For SI: 1 inch = 25.4 mm, 1 foot = 304.8 mm, 1 pound per square inch = 6.895 kPa, 1-inch water column = 0.2488 kPa, 1 British thermal unit per hour = 0.2931 W, 1 cubic foot per hour = 0.0283 m³/h, 1 degree = 0.01745 rad.

Notes:

1. NA means a flow of less than 10 cfh.
2. All table entries have been rounded to three significant digits.

TABLE 402.4(3)
SCHEDULE 40 METALLIC PIPE

Gas		Natural								
Inlet Pressure		Less than 2 psi								
Pressure Drop		<u>3.0 in. w.c.</u>								
Specific Gravity		<u>0.60</u>								
INTENDED USE: Initial supply pressure of 8.0 inches w.c. or greater										
PIPE SIZE (inch)										
Nominal	<u>½</u>	<u>¾</u>	<u>1</u>	<u>1¼</u>	<u>1½</u>	<u>2</u>	<u>2½</u>	<u>3</u>	<u>4</u>	
Actual ID	<u>0.622</u>	<u>0.824</u>	<u>1.049</u>	<u>1.380</u>	<u>1.610</u>	<u>2.067</u>	<u>2.469</u>	<u>3.068</u>	<u>4.026</u>	
Length (ft)	Capacity in Cubic Feet of Gas Per Hour									
<u>10</u>	<u>454</u>	<u>949</u>	<u>1,790</u>	<u>3,670</u>	<u>5,500</u>	<u>10,600</u>	<u>16,900</u>	<u>29,800</u>	<u>60,800</u>	
<u>20</u>	<u>312</u>	<u>652</u>	<u>1,230</u>	<u>2,520</u>	<u>3,780</u>	<u>7,280</u>	<u>11,600</u>	<u>20,500</u>	<u>41,800</u>	
<u>30</u>	<u>250</u>	<u>524</u>	<u>986</u>	<u>2,030</u>	<u>3,030</u>	<u>5,840</u>	<u>9,310</u>	<u>16,500</u>	<u>33,600</u>	
<u>40</u>	<u>214</u>	<u>448</u>	<u>844</u>	<u>1,730</u>	<u>2,600</u>	<u>5,000</u>	<u>7,970</u>	<u>14,100</u>	<u>28,700</u>	
<u>50</u>	<u>190</u>	<u>397</u>	<u>748</u>	<u>1,540</u>	<u>2,300</u>	<u>4,430</u>	<u>7,070</u>	<u>12,500</u>	<u>25,500</u>	

TABLE 402.4(3)
SCHEDULE 40 METALLIC PIPE

Gas		<u>Natural</u>							
Inlet Pressure		<u>Less than 2 psi</u>							
Pressure Drop		<u>3.0 in. w.c.</u>							
Specific Gravity		<u>0.60</u>							
INTENDED USE: Initial supply pressure of 8.0 inches w.c. or greater									
PIPE SIZE (inch)									
Nominal	<u>½</u>	<u>¾</u>	<u>1</u>	<u>1¼</u>	<u>1½</u>	<u>2</u>	<u>2½</u>	<u>3</u>	<u>4</u>
Actual ID	<u>0.622</u>	<u>0.824</u>	<u>1.049</u>	<u>1.380</u>	<u>1.610</u>	<u>2.067</u>	<u>2.469</u>	<u>3.068</u>	<u>4.026</u>
Length (ft)	Capacity in Cubic Feet of Gas Per Hour								
<u>60</u>	<u>172</u>	<u>360</u>	<u>678</u>	<u>1,390</u>	<u>2,090</u>	<u>4,020</u>	<u>6,400</u>	<u>11,300</u>	<u>23,100</u>
<u>70</u>	<u>158</u>	<u>331</u>	<u>624</u>	<u>1,280</u>	<u>1,920</u>	<u>3,700</u>	<u>5,890</u>	<u>10,400</u>	<u>21,200</u>
<u>80</u>	<u>147</u>	<u>308</u>	<u>580</u>	<u>1,190</u>	<u>1,790</u>	<u>3,440</u>	<u>5,480</u>	<u>9,690</u>	<u>19,800</u>
<u>90</u>	<u>138</u>	<u>289</u>	<u>544</u>	<u>1,120</u>	<u>1,680</u>	<u>3,230</u>	<u>5,140</u>	<u>9,090</u>	<u>18,500</u>
<u>100</u>	<u>131</u>	<u>273</u>	<u>514</u>	<u>1,060</u>	<u>1,580</u>	<u>3,050</u>	<u>4,860</u>	<u>8,580</u>	<u>17,500</u>
<u>125</u>	<u>116</u>	<u>242</u>	<u>456</u>	<u>936</u>	<u>1,400</u>	<u>2,700</u>	<u>4,300</u>	<u>7,610</u>	<u>15,500</u>
<u>150</u>	<u>105</u>	<u>219</u>	<u>413</u>	<u>848</u>	<u>1,270</u>	<u>2,450</u>	<u>3,900</u>	<u>6,890</u>	<u>14,100</u>
<u>175</u>	<u>96</u>	<u>202</u>	<u>380</u>	<u>780</u>	<u>1,170</u>	<u>2,250</u>	<u>3,590</u>	<u>6,340</u>	<u>12,900</u>
<u>200</u>	<u>90</u>	<u>188</u>	<u>353</u>	<u>726</u>	<u>1,090</u>	<u>2,090</u>	<u>3,340</u>	<u>5,900</u>	<u>12,000</u>
<u>250</u>	<u>80</u>	<u>166</u>	<u>313</u>	<u>643</u>	<u>964</u>	<u>1,860</u>	<u>2,960</u>	<u>5,230</u>	<u>10,700</u>
<u>300</u>	<u>72</u>	<u>151</u>	<u>284</u>	<u>583</u>	<u>873</u>	<u>1,680</u>	<u>2,680</u>	<u>4,740</u>	<u>9,700</u>
<u>350</u>	<u>66</u>	<u>139</u>	<u>261</u>	<u>536</u>	<u>803</u>	<u>1,550</u>	<u>2,470</u>	<u>4,360</u>	<u>8,900</u>
<u>400</u>	<u>62</u>	<u>129</u>	<u>243</u>	<u>499</u>	<u>747</u>	<u>1,440</u>	<u>2,290</u>	<u>4,060</u>	<u>8,300</u>
<u>450</u>	<u>58</u>	<u>121</u>	<u>228</u>	<u>468</u>	<u>701</u>	<u>1,350</u>	<u>2,150</u>	<u>3,800</u>	<u>7,800</u>
<u>500</u>	<u>55</u>	<u>114</u>	<u>215</u>	<u>442</u>	<u>662</u>	<u>1,280</u>	<u>2,030</u>	<u>3,590</u>	<u>7,300</u>
<u>550</u>	<u>52</u>	<u>109</u>	<u>204</u>	<u>420</u>	<u>629</u>	<u>1,210</u>	<u>1,930</u>	<u>3,410</u>	<u>7,000</u>
<u>600</u>	<u>50</u>	<u>104</u>	<u>195</u>	<u>400</u>	<u>600</u>	<u>1,160</u>	<u>1,840</u>	<u>3,260</u>	<u>6,640</u>
<u>650</u>	<u>47</u>	<u>99</u>	<u>187</u>	<u>384</u>	<u>575</u>	<u>1,110</u>	<u>1,760</u>	<u>3,120</u>	<u>6,360</u>
<u>700</u>	<u>46</u>	<u>95</u>	<u>179</u>	<u>368</u>	<u>552</u>	<u>1,060</u>	<u>1,700</u>	<u>3,000</u>	<u>6,110</u>
<u>750</u>	<u>44</u>	<u>92</u>	<u>173</u>	<u>355</u>	<u>532</u>	<u>1,020</u>	<u>1,630</u>	<u>2,890</u>	<u>5,890</u>
<u>800</u>	<u>42</u>	<u>89</u>	<u>167</u>	<u>343</u>	<u>514</u>	<u>989</u>	<u>1,580</u>	<u>2,790</u>	<u>5,680</u>
<u>850</u>	<u>41</u>	<u>86</u>	<u>162</u>	<u>332</u>	<u>497</u>	<u>957</u>	<u>1,530</u>	<u>2,700</u>	<u>5,500</u>
<u>900</u>	<u>40</u>	<u>83</u>	<u>157</u>	<u>322</u>	<u>482</u>	<u>928</u>	<u>1,480</u>	<u>2,620</u>	<u>5,330</u>
<u>950</u>	<u>39</u>	<u>81</u>	<u>152</u>	<u>312</u>	<u>468</u>	<u>901</u>	<u>1,440</u>	<u>2,540</u>	<u>5,180</u>
<u>1,000</u>	<u>38</u>	<u>79</u>	<u>148</u>	<u>304</u>	<u>455</u>	<u>877</u>	<u>1,400</u>	<u>2,470</u>	<u>5,040</u>
<u>1,100</u>	<u>36</u>	<u>75</u>	<u>141</u>	<u>289</u>	<u>432</u>	<u>833</u>	<u>1,330</u>	<u>2,350</u>	<u>4,780</u>
<u>1,200</u>	<u>34</u>	<u>71</u>	<u>134</u>	<u>275</u>	<u>412</u>	<u>794</u>	<u>1,270</u>	<u>2,240</u>	<u>4,560</u>
<u>1,300</u>	<u>33</u>	<u>68</u>	<u>128</u>	<u>264</u>	<u>395</u>	<u>761</u>	<u>1,210</u>	<u>2,140</u>	<u>4,370</u>
<u>1,400</u>	<u>31</u>	<u>65</u>	<u>123</u>	<u>253</u>	<u>379</u>	<u>731</u>	<u>1,170</u>	<u>2,060</u>	<u>4,200</u>
<u>1,500</u>	<u>30</u>	<u>63</u>	<u>119</u>	<u>244</u>	<u>366</u>	<u>704</u>	<u>1,120</u>	<u>1,980</u>	<u>4,050</u>
<u>1,600</u>	<u>29</u>	<u>61</u>	<u>115</u>	<u>236</u>	<u>353</u>	<u>680</u>	<u>1,080</u>	<u>1,920</u>	<u>3,910</u>
<u>1,700</u>	<u>28</u>	<u>59</u>	<u>111</u>	<u>228</u>	<u>342</u>	<u>658</u>	<u>1,050</u>	<u>1,850</u>	<u>3,780</u>
<u>1,800</u>	<u>27</u>	<u>57</u>	<u>108</u>	<u>221</u>	<u>331</u>	<u>638</u>	<u>1,020</u>	<u>1,800</u>	<u>3,670</u>
<u>1,900</u>	<u>27</u>	<u>56</u>	<u>105</u>	<u>215</u>	<u>322</u>	<u>619</u>	<u>987</u>	<u>1,750</u>	<u>3,560</u>
<u>2,000</u>	<u>26</u>	<u>54</u>	<u>102</u>	<u>209</u>	<u>313</u>	<u>602</u>	<u>960</u>	<u>1,700</u>	<u>3,460</u>

For SI: 1 inch = 25.4 mm, 1 foot = 304.8 mm, 1 pound per square inch = 6.895 kPa, 1-inch water column = 0.2488 kPa, 1 British thermal unit per hour = 0.2931 W, 1 cubic foot per hour = 0.0283 m³/h, 1 degree = 0.01745 rad.

Note: All table entries have been rounded to three significant digits.

TABLE 402.4(4)
SCHEDULE 40 METALLIC PIPE

		Gas	Natural						
		Inlet Pressure	Less than 2 psi						
		Pressure Drop	6.0 in. w.c.						
		Specific Gravity	0.60						
INTENDED USE: Initial supply pressure of 11.0 inches w.c. or greater									
PIPE SIZE (inch)									
Nominal	½	¾	1	1¼	1½	2	2½	3	4
Actual ID	0.622	0.824	1.049	1.380	1.610	2.067	2.469	3.068	4.026
Length (ft)	Capacity in Cubic Feet of Gas Per Hour								
10	660	1,380	2,600	5,340	8,000	15,400	24,600	43,400	88,500
20	454	949	1,790	3,670	5,500	10,600	16,900	29,900	60,800
30	364	762	1,440	2,950	4,420	8,500	13,600	24,000	48,900
40	312	652	1,230	2,520	3,780	7,280	11,600	20,500	41,800
50	276	578	1,090	2,240	3,350	6,450	10,300	18,200	37,100
60	250	524	986	2,030	3,030	5,840	9,310	16,500	33,600
70	230	482	907	1,860	2,790	5,380	8,570	15,100	30,900
80	214	448	844	1,730	2,600	5,000	7,970	14,100	28,700
90	201	420	792	1,630	2,440	4,690	7,480	13,200	27,000
100	190	397	748	1,540	2,300	4,430	7,070	12,500	25,500
125	168	352	663	1,360	2,040	3,930	6,260	11,100	22,600
150	153	319	601	1,230	1,850	3,560	5,670	10,000	20,500
175	140	293	553	1,140	1,700	3,280	5,220	9,230	18,800
200	131	273	514	1,060	1,580	3,050	4,860	8,580	17,500
250	116	242	456	936	1,400	2,700	4,300	7,610	15,500
300	105	219	413	848	1,270	2,450	3,900	6,890	14,100
350	96	202	380	780	1,170	2,250	3,590	6,340	12,900
400	90	188	353	726	1,090	2,090	3,340	5,900	12,000
450	84	176	332	681	1,020	1,970	3,130	5,540	11,300
500	80	166	313	643	964	1,860	2,960	5,230	10,700
550	76	158	297	611	915	1,760	2,810	4,970	10,100
600	72	151	284	583	873	1,680	2,680	4,740	9,660
650	69	144	272	558	836	1,610	2,570	4,540	9,250
700	66	139	261	536	803	1,550	2,470	4,360	8,890
750	64	134	252	516	774	1,490	2,380	4,200	8,560
800	62	129	243	499	747	1,440	2,290	4,060	8,270
850	60	125	235	483	723	1,390	2,220	3,920	8,000
900	58	121	228	468	701	1,350	2,150	3,800	7,760
950	56	118	221	454	681	1,310	2,090	3,700	7,540
1,000	55	114	215	442	662	1,280	2,030	3,590	7,330
1,100	52	109	204	420	629	1,210	1,930	3,410	6,960
1,200	50	104	195	400	600	1,160	1,840	3,260	6,640
1,300	47	99	187	384	575	1,100	1,760	3,120	6,360
1,400	46	95	179	368	552	1,060	1,700	3,000	6,110
1,500	44	92	173	355	532	1,020	1,630	2,890	5,890
1,600	42	89	167	343	514	989	1,580	2,790	5,680
1,700	41	86	162	332	497	957	1,530	2,700	5,500
1,800	40	83	157	322	482	928	1,480	2,620	5,330
1,900	39	81	152	312	468	901	1,440	2,540	5,180
2,000	38	79	148	304	455	877	1,400	2,470	5,040

For SI: 1 inch = 25.4 mm, 1 foot = 304.8 mm, 1 pound per square inch = 6.895 kPa, 1-inch water column = 0.2488 kPa, 1 British thermal unit per hour = 0.2931 W, 1 cubic foot per hour = 0.0283 m³/h, 1 degree = 0.01745 rad.

Note: All table entries have been rounded to three significant digits.

**TABLE [402.4(3)] 402.4(5)
SCHEDULE 40 METALLIC PIPE**

Gas		Natural							
Inlet Pressure		2.0 psi							
Pressure Drop		1.0 psi							
Specific Gravity		0.60							
PIPE SIZE (inch)									
Nominal	½	¾	1	1¼	1½	2	2½	3	4
Actual ID	0.622	0.824	1.049	1.380	1.610	2.067	2.469	3.068	4.026
Length (ft)	Capacity in Cubic Feet of Gas Per Hour								
10	1,510	3,040	5,560	11,400	17,100	32,900	52,500	92,800	189,000
20	1,070	2,150	3,930	8,070	12,100	23,300	37,100	65,600	134,000
30	869	1,760	3,210	6,590	9,880	19,000	30,300	53,600	109,000
40	753	1,520	2,780	5,710	8,550	16,500	26,300	46,400	94,700
50	673	1,360	2,490	5,110	7,650	14,700	23,500	41,500	84,700
60	615	1,240	2,270	4,660	6,980	13,500	21,400	37,900	77,300
70	569	1,150	2,100	4,320	6,470	12,500	19,900	35,100	71,600
80	532	1,080	1,970	4,040	6,050	11,700	18,600	32,800	67,000
90	502	1,010	1,850	3,810	5,700	11,000	17,500	30,900	63,100
100	462	934	1,710	3,510	5,260	10,100	16,100	28,500	58,200
125	414	836	1,530	3,140	4,700	9,060	14,400	25,500	52,100
150	372	751	1,370	2,820	4,220	8,130	13,000	22,900	46,700
175	344	695	1,270	2,601	3,910	7,530	12,000	21,200	43,300
200	318	642	1,170	2,410	3,610	6,960	11,100	19,600	40,000
250	279	583	1,040	2,140	3,210	6,180	9,850	17,400	35,500
300	253	528	945	1,940	2,910	5,600	8,920	15,800	32,200
350	232	486	869	1,790	2,670	5,150	8,210	14,500	29,600
400	216	452	809	1,660	2,490	4,790	7,640	13,500	27,500
450	203	424	759	1,560	2,330	4,500	7,170	12,700	25,800
500	192	401	717	1,470	2,210	4,250	6,770	12,000	24,400
550	182	381	681	1,400	2,090	4,030	6,430	11,400	23,200
600	174	363	650	1,330	2,000	3,850	6,130	10,800	22,100
650	166	348	622	1,280	1,910	3,680	5,870	10,400	21,200
700	160	334	598	1,230	1,840	3,540	5,640	9,970	20,300
750	154	322	576	1,180	1,770	3,410	5,440	9,610	19,600
800	149	311	556	1,140	1,710	3,290	5,250	9,280	18,900
850	144	301	538	1,100	1,650	3,190	5,080	8,980	18,300
900	139	292	522	1,070	1,600	3,090	4,930	8,710	17,800
950	135	283	507	1,040	1,560	3,000	4,780	8,460	17,200
1,000	132	275	493	1,010	1,520	2,920	4,650	8,220	16,800
1,100	125	262	468	960	1,440	2,770	4,420	7,810	15,900
1,200	119	250	446	917	1,370	2,640	4,220	7,450	15,200
1,300	114	239	427	878	1,320	2,530	4,040	7,140	14,600
1,400	110	230	411	843	1,260	2,430	3,880	6,860	14,000
1,500	106	221	396	812	1,220	2,340	3,740	6,600	13,500
1,600	102	214	382	784	1,180	2,260	3,610	6,380	13,000
1,700	99	207	370	759	1,140	2,190	3,490	6,170	12,600
1,800	96	200	358	736	1,100	2,120	3,390	5,980	12,200
1,900	93	195	348	715	1,070	2,060	3,290	5,810	11,900

**TABLE [402.4(3)] 402.4(5)
SCHEDULE 40 METALLIC PIPE**

Gas		Natural							
Inlet Pressure		2.0 psi							
Pressure Drop		1.0 psi							
Specific Gravity		0.60							
PIPE SIZE (inch)									
Nominal	½	¾	1	1¼	1½	2	2½	3	4
Actual ID	0.622	0.824	1.049	1.380	1.610	2.067	2.469	3.068	4.026
Length (ft)	Capacity in Cubic Feet of Gas Per Hour								
2,000	91	189	339	695	1,040	2,010	3,200	5,650	11,500

For SI: 1 inch = 25.4 mm, 1 foot = 304.8 mm, 1 pound per square inch = 6.895 kPa, 1-inch water column = 0.2488 kPa,
1 British thermal unit per hour = 0.2931 W, 1 cubic foot per hour = 0.0283 m³/h, 1 degree = 0.01745 rad.
Note: All table entries have been rounded to three significant digits.

**TABLE [402.4(4)] 402.4(6)
SCHEDULE 40 METALLIC PIPE**

Gas		Natural							
Inlet Pressure		3.0 psi							
Pressure Drop		2.0 psi							
Specific Gravity		0.60							
PIPE SIZE (inch)									
Nominal	½	¾	1	1¼	1½	2	2½	3	4
Actual ID	0.622	0.824	1.049	1.380	1.610	2.067	2.469	3.068	4.026
Length (ft)	Capacity in Cubic Feet of Gas Per Hour								
10	2,350	4,920	9,270	19,000	28,500	54,900	87,500	155,000	316,000
20	1,620	3,380	6,370	13,100	19,600	37,700	60,100	106,000	217,000
30	1,300	2,720	5,110	10,500	15,700	30,300	48,300	85,400	174,000
40	1,110	2,320	4,380	8,990	13,500	25,900	41,300	73,100	149,000
50	985	2,060	3,880	7,970	11,900	23,000	36,600	64,800	132,000
60	892	1,870	3,520	7,220	10,800	20,800	33,200	58,700	120,000
70	821	1,720	3,230	6,640	9,950	19,200	30,500	54,000	110,000
80	764	1,600	3,010	6,180	9,260	17,800	28,400	50,200	102,000
90	717	1,500	2,820	5,800	8,680	16,700	26,700	47,100	96,100
100	677	1,420	2,670	5,470	8,200	15,800	25,200	44,500	90,800
125	600	1,250	2,360	4,850	7,270	14,000	22,300	39,500	80,500
150	544	1,140	2,140	4,400	6,590	12,700	20,200	35,700	72,900
175	500	1,050	1,970	4,040	6,060	11,700	18,600	32,900	67,100
200	465	973	1,830	3,760	5,640	10,900	17,300	30,600	62,400
250	412	862	1,620	3,330	5,000	9,620	15,300	27,100	55,300
300	374	781	1,470	3,020	4,530	8,720	13,900	24,600	50,100
350	344	719	1,350	2,780	4,170	8,020	12,800	22,600	46,100
400	320	669	1,260	2,590	3,870	7,460	11,900	21,000	42,900
450	300	627	1,180	2,430	3,640	7,000	11,200	19,700	40,200
500	283	593	1,120	2,290	3,430	6,610	10,500	18,600	38,000

**TABLE [402.4(4)] 402.4(6)
SCHEDULE 40 METALLIC PIPE**

Gas		Natural							
Inlet Pressure		3.0 psi							
Pressure Drop		2.0 psi							
Specific Gravity		0.60							
PIPE SIZE (inch)									
Nominal	½	¾	1	1¼	1½	2	2½	3	4
Actual ID	0.622	0.824	1.049	1.380	1.610	2.067	2.469	3.068	4.026
Length (ft)	Capacity in Cubic Feet of Gas Per Hour								
550	269	563	1,060	2,180	3,260	6,280	10,000	17,700	36,100
600	257	537	1,010	2,080	3,110	5,990	9,550	16,900	34,400
650	246	514	969	1,990	2,980	5,740	9,150	16,200	33,000
700	236	494	931	1,910	2,860	5,510	8,790	15,500	31,700
750	228	476	897	1,840	2,760	5,310	8,470	15,000	30,500
800	220	460	866	1,780	2,660	5,130	8,180	14,500	29,500
850	213	445	838	1,720	2,580	4,960	7,910	14,000	28,500
900	206	431	812	1,670	2,500	4,810	7,670	13,600	27,700
950	200	419	789	1,620	2,430	4,670	7,450	13,200	26,900
1,000	195	407	767	1,580	2,360	4,550	7,240	12,800	26,100
1,100	185	387	729	1,500	2,240	4,320	6,890	12,200	24,800
1,200	177	369	695	1,430	2,140	4,120	6,570	11,600	23,700
1,300	169	353	666	1,370	2,050	3,940	6,290	11,100	22,700
1,400	162	340	640	1,310	1,970	3,790	6,040	10,700	21,800
1,500	156	327	616	1,270	1,900	3,650	5,820	10,300	21,000
1,600	151	316	595	1,220	1,830	3,530	5,620	10,000	20,300
1,700	146	306	576	1,180	1,770	3,410	5,440	9,610	19,600
1,800	142	296	558	1,150	1,720	3,310	5,270	9,320	19,000
1,900	138	288	542	1,110	1,670	3,210	5,120	9,050	18,400
2,000	134	280	527	1,080	1,620	3,120	4,980	8,800	18,000

For SI: 1 inch = 25.4 mm, 1 foot = 304.8 mm, 1 pound per square inch = 6.895 kPa, 1-inch water column = 0.2488 kPa, 1 British thermal unit per hour = 0.2931 W, 1 cubic foot per hour = 0.0283 m³/h, 1 degree = 0.01745 rad.

Note: All table entries have been rounded to three significant digits.

**TABLE [402.4(5)] 402.4(7)
SCHEDULE 40 METALLIC PIPE**

		Gas		Natural					
		Inlet Pressure		5.0 psi					
		Pressure Drop		3.5 psi					
		Specific Gravity		0.60					
PIPE SIZE (inch)									
Nominal	½	¾	1	1¼	1½	2	2½	3	4
Actual ID	0.622	0.824	1.049	1.380	1.610	2.067	2.469	3.068	4.026
Length (ft)	Capacity in Cubic Feet of Gas Per Hour								
10	3,190	6,430	11,800	24,200	36,200	69,700	111,000	196,000	401,000
20	2,250	4,550	8,320	17,100	25,600	49,300	78,600	139,000	283,000
30	1,840	3,720	6,790	14,000	20,900	40,300	64,200	113,000	231,000
40	1,590	3,220	5,880	12,100	18,100	34,900	55,600	98,200	200,000
50	1,430	2,880	5,260	10,800	16,200	31,200	49,700	87,900	179,000
60	1,300	2,630	4,800	9,860	14,800	28,500	45,400	80,200	164,000
70	1,200	2,430	4,450	9,130	13,700	26,400	42,000	74,300	151,000
80	1,150	2,330	4,260	8,540	12,800	24,700	39,300	69,500	142,000
90	1,060	2,150	3,920	8,050	12,100	23,200	37,000	65,500	134,000
100	979	1,980	3,620	7,430	11,100	21,400	34,200	60,400	123,000
125	876	1,770	3,240	6,640	9,950	19,200	30,600	54,000	110,000
150	786	1,590	2,910	5,960	8,940	17,200	27,400	48,500	98,900
175	728	1,470	2,690	5,520	8,270	15,900	25,400	44,900	91,600
200	673	1,360	2,490	5,100	7,650	14,700	23,500	41,500	84,700
250	558	1,170	2,200	4,510	6,760	13,000	20,800	36,700	74,900
300	506	1,060	1,990	4,090	6,130	11,800	18,800	33,300	67,800
350	465	973	1,830	3,760	5,640	10,900	17,300	30,600	62,400
400	433	905	1,710	3,500	5,250	10,100	16,100	28,500	58,100
450	406	849	1,600	3,290	4,920	9,480	15,100	26,700	54,500
500	384	802	1,510	3,100	4,650	8,950	14,300	25,200	51,500
550	364	762	1,440	2,950	4,420	8,500	13,600	24,000	48,900
600	348	727	1,370	2,810	4,210	8,110	12,900	22,900	46,600
650	333	696	1,310	2,690	4,030	7,770	12,400	21,900	44,600
700	320	669	1,260	2,590	3,880	7,460	11,900	21,000	42,900
750	308	644	1,210	2,490	3,730	7,190	11,500	20,300	41,300
800	298	622	1,170	2,410	3,610	6,940	11,100	19,600	39,900
850	288	602	1,130	2,330	3,490	6,720	10,700	18,900	38,600
900	279	584	1,100	2,260	3,380	6,520	10,400	18,400	37,400
950	271	567	1,070	2,190	3,290	6,330	10,100	17,800	36,400
1,000	264	551	1,040	2,130	3,200	6,150	9,810	17,300	35,400
1,100	250	524	987	2,030	3,030	5,840	9,320	16,500	33,600
1,200	239	500	941	1,930	2,900	5,580	8,890	15,700	32,000
1,300	229	478	901	1,850	2,770	5,340	8,510	15,000	30,700
1,400	220	460	866	1,780	2,660	5,130	8,180	14,500	29,500
1,500	212	443	834	1,710	2,570	4,940	7,880	13,900	28,400
1,600	205	428	806	1,650	2,480	4,770	7,610	13,400	27,400
1,700	198	414	780	1,600	2,400	4,620	7,360	13,000	26,500

**TABLE [402.4(5)] 402.4(7)
SCHEDULE 40 METALLIC PIPE**

		Gas		Natural					
		Inlet Pressure		5.0 psi					
		Pressure Drop		3.5 psi					
		Specific Gravity		0.60					
PIPE SIZE (inch)									
Nominal	½	¾	1	1¼	1½	2	2½	3	4
Actual ID	0.622	0.824	1.049	1.380	1.610	2.067	2.469	3.068	4.026
Length (ft)	Capacity in Cubic Feet of Gas Per Hour								
1,800	192	401	756	1,550	2,330	4,480	7,140	12,600	25,700
1,900	186	390	734	1,510	2,260	4,350	6,930	12,300	25,000
2,000	181	379	714	1,470	2,200	4,230	6,740	11,900	24,300

For SI: 1 inch = 25.4 mm, 1 foot = 304.8 mm, 1 pound per square inch = 6.895 kPa, 1-inch water column = 0.2488 kPa, 1 British thermal unit per hour = 0.2931 W, 1 cubic foot per hour = 0.0283 m³/h, 1 degree = 0.01745 rad.

Note: All table entries have been rounded to three significant digits.

402.4.1 Longest length method. The pipe size of each section of gas piping shall be determined using the longest length of piping from the point of delivery to the most remote outlet and the load of the section.

402.4.2 Branch length method. Pipe shall be sized as follows:

1. Pipe size of each section of the longest pipe run from the point of delivery to the most remote outlet shall be determined using the longest run of piping and the load of the section.
2. The pipe size of each section of branch piping not previously sized shall be determined using the length of piping from the point of delivery to the most remote outlet in each branch and the load of the section.

402.4.3 Hybrid pressure. The pipe size for each section of higher pressure gas piping shall be determined using the longest length of piping from the point of delivery to the most remote line pressure regulator. The pipe size from the line pressure regulator to each outlet shall be determined using the length of piping from the regulator to the most remote outlet served by the regulator.

402.5 Allowable pressure drop. The design pressure loss in any piping system under maximum probable flow conditions, from the point of delivery to the inlet connection of the appliance, shall be such that the supply pressure at the appliance is greater than or equal to the minimum pressure required by the appliance.

402.6 Gas distribution pressures. ~~[No gas distribution piping containing gas at a pressure in excess of ½ psig (3.5 kPa gauge) shall be run within a building.]~~ The maximum design operating pressure for piping systems located inside buildings shall not exceed ½ pounds per square inch gauge (psig) (3.5 kPa gauge).

Exceptions:

1. Pressure not exceeding 5 psig (34.5 kPa gauge) is permitted ~~[for: (a) commercial and industrial occupancies where fuel requirements for appliances exceed 4,000 cubic feet per hour (113.2 m³/h) and such large volume use is supplied through separate gas distribution piping]~~ where a system supplies one or more appliances that require gas pressure in excess of ½ psig (3.5 kPa gauge).
2. Gas pressure not exceeding 15 psig (~~[100]~~ 103.4 kPa gauge) is permitted for appliances in excess of 100,000 cubic feet per hour (2830 m³/h) provided the gas distribution piping is installed as provided for in Section 404.
3. The use of pressure in excess of 15 psig (~~[100]~~ 103.4 kPa gauge) shall be permitted for distribution piping provided all of the requirements of Section 406 and Appendix G are met.

SECTION FGC 403 PIPING MATERIALS

403.1 General. Materials used for piping systems shall be new and comply with the requirements of this chapter or shall be approved.

403.1.1 Pipe size and pressure limitations.

1. All requirements for installation of gas distribution piping ~~[with operating pressures at ½ psig (3.5 kPa gauge) or less and above ½ psig (3.5 kPa gauge)]~~ shall be in accordance with Chapter 4 ~~[of this code]~~. Gas distribution piping with operating pressures of 15 psig (103.4 kPa gauge) or more shall be in accordance with Appendix G.
 2. Gas distribution piping operating at a pressure of over ½ psig (3.5 kPa gauge) ~~[to 5 psig (34.5 kPa gauge) and size 4 inches (102 mm) or larger]~~ shall be welded.
Exception: Manufactured and listed gas trains provided with the appliance may be threaded.
 3. ~~[All gas distribution piping operating at a pressure above 5 psig (34.5 kPa gauge) shall be welded.]~~
- ~~[4.]~~ All welding of gas distribution piping shall be subject to radiography or special inspection as set forth in Section 406.
- ~~[5. All piping 4 inches (102 mm) and greater operating at pressure exceeding 5 psig (34.5 kPa gauge) must be butt welded, subject to special inspection and radiographed.]~~
- ~~[6.]~~ 4. Threaded piping may be used up to 4 inches (~~[102]~~ 101.6 mm) in diameter at pressure no greater than ½ psig (3.5 kPa gauge). All piping greater than 4 inches in diameter shall be welded, regardless of operating pressure.

5. All welded piping 2½ inches (63.5 mm) or greater in diameter shall be butt-welded, and welded piping less than 2½ inches (63.5 mm) in diameter may be socket-welded or butt-welded.

403.2 Used materials. Used pipe, fittings, valves and other materials shall not be reused.

403.3 Other materials. Material not covered by the standards specifications listed herein shall be investigated and tested to determine that it is safe and suitable for the proposed service, and, in addition, shall be recommended for that service by the manufacturer subject to approval by the commissioner.

403.4 Metallic pipe. Metallic pipe shall comply with Sections 403.4.1 through 403.4.4.

403.4.1 Cast iron. Cast-iron pipe shall not be used.

403.4.2 Steel. Carbon steel and wrought-iron pipe shall be [~~at least of~~] not less than standard weight and shall comply with one of the following standards:

1. ASME [~~B36.10, 10M~~] B36.10M.
2. ASTM A 53/A 53M [~~;~~ ~~or~~].
3. ASTM [~~A-106~~] A106/A106M.

403.4.3 Copper and brass. Copper and brass pipe shall not be used.

403.4.4 Aluminum. Aluminum-alloy pipe shall not be used.

403.5 Metallic tubing. Metallic tubing shall not be used except as provided in Section [~~405.5~~] 404.2.

403.5.1 Standards. Stainless steel flexible multiple leg hose assemblies shall be listed and labeled in accordance with UL 536 and designed in accordance with the manufacturer's recommendation.

403.5.2 Seismic requirements. Stainless steel flexible multiple leg hose assemblies shall be designed to withstand seismic force and displacement in accordance with Section 1613 of the *New York City Building Code*.

403.5.3 Special inspection required. The installation of stainless steel flexible multiple leg hose assemblies shall be subject to special inspection in accordance with Section [~~1707.7~~] 1705.12.3 of the *New York City Building Code* and Section 406 of this code.

403.6 Reserved.

403.7 Workmanship and defects. Pipe and fittings shall be clear and free from cutting burrs and defects in structure or threading, and shall be thoroughly brushed, and chip and scale blown.

Defects in pipe and fittings shall not be repaired. Defective pipe and fittings shall be replaced (see Section 406.1.2).

403.8 Protective coating. Where in contact with material or atmosphere exerting a corrosive action, metallic piping and fittings coated with a corrosion-resistant material shall be used. External coatings or linings used on piping or components shall not be considered as adding strength.

403.9 Metallic pipe threads. Metallic pipe and fitting threads shall be taper pipe threads and shall comply with ASME B1.20.1.

403.9.1 Damaged threads. Pipe with threads that are stripped, chipped, corroded or otherwise damaged shall not be used. Where a weld opens during the operation of cutting or threading, that portion of the pipe shall not be used.

403.9.2 Number of threads. Field threading of metallic pipe shall be in accordance with Table 403.9.2.

**TABLE 403.9.2
SPECIFICATIONS FOR THREADING METALLIC PIPE**

IRON PIPE SIZE (inches)	APPROXIMATE LENGTH OF THREADED PORTION (inches)	APPROXIMATE NUMBER OF THREADS TO BE CUT
1/2	3/4	10
3/4	3/4	10
1	7/8	10
1 1/4	1	11
1 1/2	1	11
2	1	11
2 1/2	1 1/2	12
3	1 1/2	12
4	1 5/8	13

For SI: 1 inch = 25.4 mm.

403.9.3 Thread joint compounds. Thread [~~(joint)~~] joint compounds [~~(pipe dope)~~] shall be in non-hardening paste or tape form and shall be resistant to the action of liquefied petroleum gas or to any other chemical constituents of the gases to be conducted through the piping. Use of cotton thread (lamp wick) is prohibited. Threaded joint compound in tape form is prohibited for use at pressure regulator connections.

403.10 Metallic piping joints and fittings. The type of piping joint used shall be suitable for the pressure-temperature conditions and shall be selected giving consideration to joint tightness and mechanical strength under the service conditions. The joint shall be able to sustain the maximum end force caused by the internal pressure and any additional forces caused by temperature expansion or contraction, vibration, fatigue or the weight of the pipe and its contents.

403.10.1 Pipe joints. Pipe joints shall be threaded, flanged, or welded.

403.10.1.1 Prohibited joints and fittings. Unions and threaded close nipples shall be prohibited.

Exception: Unions shall be permitted to be installed downstream of the appliance valve in accordance with Section 411.1.6.

403.10.2 Tubing joints. Tubing joints shall not be used.

403.10.3 Flared joints. Flared joints shall not be used.

403.10.4 Metallic fittings. Metallic fittings shall comply with the following:

1. Threaded fittings in sizes larger than 4 inches (~~[402]~~ 101.6 mm) shall not be used.
2. Fittings used with steel or wrought-iron pipe shall be steel or malleable iron.
3. Bushings shall not be used.

403.11 Reserved.

403.12 Flanges. ~~[All flanges]~~ Flanges and flange gaskets shall comply with ~~[ASME B16.1, ASME B16.20, or MSS SP 6. The pressure temperature ratings shall equal or exceed that required by the application]~~ Sections 403.12.1 through 403.12.7.

403.12.1 ~~[Flange facings. Standard facings shall be permitted for use under this code. Where 150 pound (1034 kPa) pressure-rated steel flanges are bolted to Class 125 cast-iron flanges, the raised face on the steel flange shall be removed.]~~ **Cast-iron.** Cast-iron flanges shall not be used.

403.12.2 Steel. Steel flanges shall be in accordance with ASME B16.5 or ASME B16.47.

403.12.3 Nonferrous. Nonferrous flanges shall not be used.

403.12.4 Ductile iron. Ductile-iron flanges shall be in accordance with ASME B16.42.

403.12.5 Raised face. Raised face flanges shall not be joined to flat faced cast-iron, ductile-iron or nonferrous material flanges.

403.12.6 Flange facings. Standard facings shall be permitted for use under this code. Where 150 pound (1034 kPa) pressure-rated steel flanges are bolted to Class 125 cast-iron flanges, the raised face on the steel flange shall be removed.

403.12.7 Lapped flanges. Lapped flanges shall be used only above ground or in exposed locations accessible for inspection.

403.13 Flange gaskets. Material for gaskets shall be capable of withstanding the design temperature and pressure of the piping system, and the chemical constituents of the gas being

conducted, without change to its chemical and physical properties. The effects of fire exposure to the joint shall be considered in choosing material. Acceptable materials include metal ~~[or]~~ (plain or corrugated), ~~[nonasbestos]~~ non-asbestos fiber, ~~[and aluminum “O” rings]~~ and spiral wound metal gaskets ~~[and rubber-faced phenolic and elastomeric]~~. ~~[When]~~ Where a flanged joint is opened, the gasket shall be replaced. Full-face flange gaskets shall be used with all ~~[cast-iron]~~ non-steel flanges. Rubber-faced phenolic and elastomeric gaskets shall be prohibited.

403.13.1 Metallic gaskets. Metallic flange gaskets shall be in accordance with ASME B16.20.

403.13.2 Nonmetallic gaskets. Nonmetallic flange gaskets shall be in accordance with ASME B16.21.

403.14 Flange bolts. Flange bolts and associated hardware shall be manufactured from corrosion-resistant materials.

SECTION FGC 404 PIPING SYSTEM INSTALLATION

404.1 Installation of materials. Materials used shall be installed in strict accordance with the standards under which the materials are accepted and approved. In the absence of such installation procedures, the manufacturer’s instructions shall be followed. Where the requirements of referenced standards or manufacturer’s instructions do not conform to minimum provisions of this code, the provisions of this code shall apply.

404.2 Pipe movement. Flammable or combustible gas piping systems shall be designed to account for pipe movement resulting from thermal changes or seismic forces.

404.2.1 Seismic requirements. Gas piping shall be designed and installed to withstand seismic forces in accordance with Section 1613 of the *New York City Building Code*.

404.2.1.1 Stainless steel flexible multiple leg hose assemblies. Stainless steel flexible multiple leg hose assemblies may be installed where pipe movement resulting from seismic forces may occur. Such assemblies shall be listed and labeled in accordance with UL 536 and shall be installed in accordance with the manufacturer’s instructions.

404.2.1.2 Inspection. The installation of stainless steel flexible multiple leg hose assemblies shall be subject to special inspections in accordance with Chapter 17 of the *New York City Building Code*.

404.3 Prohibited locations. Piping shall not be installed in or through a ducted supply, return or exhaust duct, or a trash or clothes chute, chimney or gas vent, ventilating duct, dumbwaiter or elevator shaft. Piping installed downstream of the point of delivery shall not extend through any townhouse unit other than the unit served by such piping. Piping, fixtures, or equipment shall be located so as not to interfere with the normal operation of windows or doors and other exit openings. The following installation limitations shall apply:

1. **Stair enclosures.** Gas piping shall not be installed within a stair enclosure or required exit or exit way.

2. **Fire standpipe riser.** Gas piping shall not be installed in any shaft containing standpipe risers.
3. **Fire pump and fire pump rooms.** Gas piping, gas consumption devices, appliances or any other gas equipment shall not be installed within any space housing a fire pump. Access to gas meter rooms shall not be permitted ~~[thru]~~ through rooms housing a fire pump.
4. **Fire-rated construction.** Gas piping shall not be installed within ~~[fire-rated assemblies]~~ a wall or assembly required to have a fire-resistance rating. Through penetrations of fire-resistance-rated assemblies shall be in accordance with Chapter 7 of the *New York City Building Code*.
5. **Public corridor.** Gas piping shall not be installed in public corridors and exit enclosures.

[Exception: Gas] Exceptions:

1. Gas piping may be installed in public corridors or exit enclosures where separated by a fire-resistance-rated assembly meeting the hour rating and, if applicable, the impact-resistance rating required for the corridor or exit enclosure. Such assembly shall be rated for exposure to fire from both sides.
2. In residential buildings that do not have floors below grade, or in multi-use buildings that have a residential occupancy, gas piping may be installed in public corridors ~~[in residential buildings that do not have floors below grade or in multi-use buildings that have a residential occupancy]~~ in accordance with the following:
 - ~~[1-]~~ 2.1. _____ Gas piping shall be permitted to be installed within a public corridor at the lowest level of the building or the lowest residential level of the building.
 - ~~[2-]~~ 2.2. _____ All gas valves located within the public corridor shall be accessible for maintenance and inspection.
 - ~~[3-]~~ 2.3. _____ Gas pressure within the public corridor piping shall not exceed ½ psi (14 inch w.c.). ~~[The completed piping within the public corridor is to be tested and proven tight at 10 psig (69 kPa gauge) for a minimum of 30 minutes.]~~
 - ~~[4-]~~ 2.4. _____ The public corridor shall be ventilated in accordance with the *New York City Mechanical Code*. The pipe shall not be installed in a return air plenum.
 - ~~[5-]~~ 2.5. _____ Pipes must be welded.

[404.2] 404.4 Piping in solid partitions and walls. Concealed piping shall not be located in solid partitions and solid walls, unless installed in a ventilated chase or casing.

~~[404.3]~~ **404.5 [Piping] Fittings in concealed locations.** ~~[Portions of a piping system]~~ Fittings installed in concealed locations shall [not have unions, tubing fittings, bushings, compression couplings or swing joints made by combinations of fittings.] be limited to the following types:

1. Threaded elbows, tees and couplings.
2. Welded fittings.

~~[404.4]~~ **404.6 Piping through foundation wall.** Underground piping, where installed below grade through the outer foundation or basement wall of a building, shall be encased in a protective pipe sleeve. Such sleeve shall extend a minimum of 1 inch (25.4 mm) beyond the inside of the foundation wall and a minimum of 4 inches (101.6 mm) beyond the outside of the foundation wall, or as otherwise required by the gas provider. The annular space between the gas piping and the sleeve shall be waterproofed and sealed.

~~[404.5]~~ **404.7 Branch take-off.** Branches shall be taken off the riser with not less than a two-elbow swing.

~~[404.6]~~ **404.8 Piping in solid floors.** Piping in solid floors shall be laid in channels in the floor and covered in a manner that will allow access to the piping with a minimum amount of damage to the building. Where such piping is subject to exposure to excessive moisture or corrosive substances, the piping shall be protected in an approved manner. As an alternative to installation in channels, the piping shall be installed in a conduit of Schedule 40 steel or wrought iron pipe ~~[with tightly sealed ends and joints. At least one end shall have a vented outlet piped to a safe location outdoors. The vent terminal shall be outdoors, minimum 18 inches (457 mm) above grade, not under an opening to building or overhang, and shall be installed so as to prevent the entrance of water and insects. Both ends of such conduit shall extend not less than 2 inches (51 mm) beyond the point where the pipe emerges from the floor.]~~ installed in accordance with Section 404.8.1 or 404.8.2.

~~[404.6.1]~~ **404.8.1 Conduit with one end terminating outdoors.** The conduit shall extend into an occupiable portion of the building and, at the point where the conduit terminates in the building, the space between the conduit and the gas piping shall be sealed to prevent the possible entrance of any gas leakage. The conduit shall extend not less than 2 inches (~~[51]~~ 50.8 mm) beyond the point where the pipe emerges from the floor. If the end sealing is capable of withstanding the full pressure of the gas pipe, the conduit shall be designed for the same pressure as the pipe. Such conduit shall extend not less than 4 inches (~~[402]~~ 101.6 mm) outside the building, shall be vented above grade to the outdoors and shall be installed so as to prevent the entrance of water and insects.

~~[404.6.2]~~ **404.8.2 Conduit with both ends terminating indoors.** Where the conduit originates and terminates within the same building, the conduit shall originate and terminate in an accessible portion of the building and shall not be sealed. The conduit shall extend not less than 2 inches (~~[51]~~ 50.8 mm) beyond the point where the pipe emerges from the floor.

[404.7] 404.9 Above-ground outdoor piping. ~~[All piping]~~ Piping installed outdoors shall be elevated not less than 3½ inches (~~[152]~~ 88.9 mm) above ground and where installed across roof surfaces, shall be elevated not less than 3½ inches (~~[152]~~ 88.9 mm) above the roof surface, identified in accordance with Section 401.5, and shall not be concealed. Piping installed above ground, outdoors, and installed across the surface of roofs shall be securely supported to the structure and located where it will be protected from physical damage. Where passing through an outside wall, the piping shall ~~[also]~~ be protected against corrosion ~~[by coating or wrapping with an inert material]~~ in accordance with Section 404.11. Where piping is encased in a protective pipe sleeve, the annular space between the piping and the sleeve shall be sealed. At least one end shall have a vented outlet piped to a safe location outdoors. The vent terminal shall be outdoors, minimum 18 inches (~~[457]~~ 457.2 mm) above grade, not under an opening to building or overhang, and shall be installed so as to prevent the entrance of water and insects.

[404.8] 404.10 Reserved.

[404.9] 404.11 Protection against corrosion. Metallic pipe, fittings, and joints susceptible ~~[exposed]~~ to corrosive action, such as soil condition or moisture, shall be protected in an approved manner as set forth in Sections 404.11.1 through 404.11.6. ~~[Zinc coatings (galvanizing) shall not be deemed adequate protection for gas piping underground. Ferrous metal exposed in exterior locations shall be protected from corrosion. Zinc coatings (galvanizing) shall be deemed adequate protection for gas piping exposed in exterior locations. Where dissimilar metals are joined underground, an insulating coupling or fitting shall be used. Piping shall not be laid in contact with einders.]~~

[404.9.1] 404.11.1 Prohibited use. ~~[Uncoated threaded or socket welded]~~ Threaded or uncoated welded joints shall not be used in piping in contact with soil [ø]. Uncoated piping, fittings, and joints shall be prohibited where internal or external ~~[erevice]~~ corrosion is known to occur.

404.11.2 Protection of exposed pipe. ~~[Zinc coatings (galvanizing) shall not be deemed adequate protection for gas piping underground.]~~ Ferrous metal exposed in exterior locations shall be protected from corrosion by one of the following methods:

1. Zinc coatings (galvanizing).
2. Bonded coatings in accordance with Section 404.11.4.
3. Protective coatings in accordance with Section 404.11.5.
4. Protective wrappings in accordance with Section 404.11.6.

404.11.3 Protection of buried pipe. Ferrous metal installed in buried locations shall be protected from corrosion by one of the following methods:

1. Bonded coatings in accordance with Section 404.11.4.
2. Protective wrappings in accordance with Section 404.11.6.

Where dissimilar metals are joined underground, an insulating coupling or fitting shall be used. Piping shall not be laid in contact with cinders.

[404.9.2] 404.11.4 Protective bonded coatings [~~and wrappings~~]. Pipe protective bonded coatings [~~and wrappings~~] shall be approved for the application and shall be factory applied.

Exception: Where installed in accordance with the manufacturer's [~~installation~~] instructions, field application of bonded coatings [~~and wrappings~~] shall be permitted for pipe [~~nipples~~], fittings and locations where the factory coating or wrapping has been damaged or necessarily removed at joints.

404.11.5 Protective coatings. Pipe protective coatings shall be approved for the application and shall be factory applied or field applied in accordance with the manufacturer's instructions.

Exception: Where installed in accordance with the manufacturer's instructions, field application of coatings shall be permitted for pipe, fittings and locations where the factory coating has been damaged or necessarily removed at joints.

404.11.6 Protective wrappings. Pipe protective wrappings shall be approved for the application and shall be field applied in accordance with the manufacturer's instructions.

[404.10] 404.12 Minimum burial depth. Underground piping systems shall be installed a minimum depth of 24 inches (~~[640]~~ 609.6 mm) below grade, measured to the top of the pipe.

Exception: Burial depth less than 24 inches (609.6 mm) is permissible when the underground piping system is protected by steel protective plates not less than ¼--inch thick (6.36 mm) and with joints tack welded and overlapped a minimum of 3 inches (76.2 mm). The pipe shall be not less than 4 inches (101.6 mm) below the protective steel plate.

[404.11] 404.13 Trenches. The trench shall be graded so that the pipe has a firm, substantially continuous bearing on the bottom of the trench.

404.13.1 Backfilling. Material used under and beside pipes shall be clean backfill, free of discarded construction material and debris. Loose earth free from rocks, broken concrete and frozen chunks shall be placed in the trench in 6-inch (152.4 mm) layers and tamped in place until the crown of the pipe is covered by 12 inches (304.8 mm) of tamped earth. The backfill under and beside the pipe shall be compacted for pipe support. Backfill shall be brought up evenly on both sides of the pipe so that the pipe remains aligned. In instances where the manufacturer's installation instructions for materials are more restrictive than those prescribed by the code, the material shall be installed in accordance with the more restrictive requirement. Backfilling is subject to progress inspection in accordance with Section 108.

[404.12] 404.14 Piping underground beneath buildings. Piping installed underground beneath buildings is prohibited except where the piping is encased in a conduit of wrought iron or steel pipe designed to withstand the superimposed loads. The conduit shall be protected from corrosion in accordance with Section ~~[404.9]~~ 404.11 and shall be installed in accordance with Section ~~[404.12.1]~~ 404.14.1, 404.14.2 or [404.12.2] 404.14.3.

[404.12.1] 404.14.1 Conduit with one end terminating outdoors. The conduit shall extend into an occupiable portion of the building and, at the point where the conduit terminates in the building, the space between the conduit and the gas piping shall be permanently sealed to prevent the possible entrance of any gas leakage. The conduit shall extend not less than 2 inches (~~[51]~~ 50.8 mm) beyond the point where the pipe emerges from the floor. ~~[Where the]~~ The end sealing ~~[is]~~ shall be capable of withstanding the full pressure of the gas pipe, and the conduit shall be designed for the same pressure as the pipe. Such conduit shall extend not less than 4 inches (~~[102]~~ 101.6 mm) outside of the building, shall be vented above grade to the outdoors and shall be installed so as to prevent the entrance of water and insects.

[404.12.2] 404.14.2 Conduit with both ends terminating indoors. Where the conduit originates and terminates within the same building, the conduit shall originate and terminate in an accessible portion of the building and shall not be sealed. The conduit shall extend not less than 2 inches (~~[51]~~ 50.8 mm) beyond the point where the pipe emerges from the floor.

404.14.3 Conduit with both ends terminating indoors within different buildings. Where the conduit originates indoors in a building and terminates indoors within a different building, the conduit shall comply with Section 404.14.2.

[404.13] 404.15 Outlet closures. Gas outlets shall be permitted only under the following conditions:

1. Valved and capped gas tight outlets for ~~[single]~~ appliance outlets ~~[as]~~ listed on approved applications.
2. Valved and capped outlets on each floor in nonproduction laboratory buildings for future laboratories.
3. Listed and labeled flush-mounted-type quick disconnect devices and listed and labeled gas convenience outlets installed in accordance with the manufacturer's ~~[installation]~~ instructions.

Exceptions:

1. Test ports for gas riser valves installed downstream of a riser control valve.
2. Outlets for pressure sensors and gauges installed in conjunction with gas appliances or equipment installed as per manufacturer's instructions.

[404.14] 404.16 Location of outlets. The unthreaded portion of piping outlets shall extend not less than 1 inch (~~[25]~~ 25.4 mm) through finished ceilings and walls and where extending through floors or outdoor patios and slabs, shall be not ~~[be]~~ less than 2 inches (~~[51]~~ 50.8 mm) above them. The outlet fitting or piping shall be securely supported. Outlets shall not be placed behind doors. Outlets shall be located in the room or space where the appliance is installed.

Exception: Listed and labeled flush-mounted-type [~~quick-disconnect~~] quick-disconnect devices and listed and labeled gas convenience outlets shall be installed in accordance with the manufacturer's [~~installation~~] instructions.

~~[404.15]~~ **404.17 Reserved.**

404.18 Pipe cleaning. The use of a flammable or combustible gas to clean or remove debris from the interior of a piping system shall be prohibited.

~~[404.16]~~ **404.19 Prohibited devices.** A device shall not be placed inside the piping or fittings that will reduce the cross-sectional area or otherwise obstruct the free flow of gas.

Exceptions:

1. Approved gas filters.
2. An approved fitting or device where the gas piping system has been sized to accommodate the pressure drop of the fitting or device.
3. Approved gas meters for monitoring and analysis of gas usage.

~~[404.17]~~ **404.20 Testing of piping.** Before any system of piping is put in service [~~or concealed~~], it shall be tested to ensure that it is gas tight. Testing, inspection and purging of piping systems shall comply with Section 406.

404.21 Qualifications for gas work. Gas work shall be performed by individuals possessing the qualifications set forth in Article 28-423 of the Administrative Code. Welders must be qualified in accordance with Section 404.21.1.

404.21.1 Welder's qualifications. Welders installing gas piping within buildings at any pressure shall comply with the following:

1. Welders shall be qualified for all pipe sizes, wall thicknesses and all positions in accordance with the ASME Boiler and Pressure Vessel Code, Section IX. Requalification of welders is required on an annual basis and when requested by the commissioner.
2. Welder qualification testing shall be performed by an approved agency and the inspector witnessing the test shall be an authorized AWS Certified Welding Inspector. Radiographic test specimens shall be evaluated by a radiographic inspector having a minimum radiography qualification of Level II in accordance with the ASNT, Document No. SNT-TC-1A, Supplement A.
3. Copies of the certified welder qualification reports shall be maintained by both the approved agency and the licensed master plumber employing the welder(s) for at least six years and shall be made available to the department upon request.

4. The approved agency shall submit certified welder qualification reports to the department upon successful qualification of a welder and when requested by the commissioner.
5. The licensed master plumber employing the welder(s) shall submit a statement to the department including who welded the gas piping along with a copy(s) of the certified welder qualification report(s) witnessed by a representative of the licensed master plumber, at the time of the first roughing inspection.
6. Requalification of a welder is required should the welder fail to maintain welder's continuity every six months. The licensed master plumber employing the welder shall maintain a welder continuity log and the log shall be made available to the department upon request.

404.21.2 Welding requirements. All gas distribution piping to customer appliances operating in excess of ½ psig (3.5 kPa gauge) shall be welded.

404.21.3 Welding records. The licensed master plumber employing the welder(s) shall assign to each welder an identification symbol or number to identify the welds performed by that particular welder. The welder shall identify all welds with his or her symbol or number. The licensed master plumber shall maintain records identifying the weld(s) made by each welder for at least six years and shall make such records available to the department upon request.

SECTION FGC 405 PIPING BENDS AND CHANGES IN DIRECTION

405.1 General. Changes in direction of pipe shall be permitted to be made by the use of fittings, factory bends, or field bends.

405.2 ~~Reserved.~~ Metallic pipe. Metallic pipe bends shall comply with the following:

1. Bends shall be made only with bending tools and procedures intended for that purpose.
2. All bends shall be smooth and free from buckling, cracks or other evidence of mechanical damage.
3. Bends shall be made only with seamless pipe.
4. Pipe shall not be bent through an arc of more than 90 degrees (1.6 rad).
5. The inside radius of a bend shall be not less than six times the outside diameter of the pipe.

405.3 Reserved.

405.4 Elbows. Factory-made welding elbows or transverse segments cut therefrom shall have an arc length measured along the crotch ~~at least~~ of not less than 1 inch (~~25~~ 25.4 mm) in pipe sizes 2 inches (~~51~~ 50.8 mm) and larger.

~~[405.5 Pipe movement. Stainless steel flexible multiple leg hose assemblies listed and labeled as an assembly per UL-536 shall be installed for low pressure flammable and combustible gas piping systems where pipe movement resulting from thermal changes and random seismic shifts can occur in the piping systems.]~~

~~[405.5.1 Seismic requirements. Stainless steel flexible multiple leg hose assemblies shall be designed to withstand seismic force and displacement in accordance with Section 1613 of the *New York City Building Code*.]~~

~~[405.5.2 Inspection. The installation of stainless steel flexible multiple leg hose assemblies shall be subject to special inspections in accordance with Chapter 17 of the *New York City Building Code*.]~~

SECTION FGC 406 INSPECTION, TESTING AND PURGING

406.1 General. Prior to acceptance and initial operation, all piping installations shall be inspected and pressure tested to determine that the materials, design, fabrication [;] and installation practices comply with the requirements of this code.

406.1.1 Inspections. Inspection shall consist of visual examination [;] during or after manufacture, fabrication, assembly [;] or pressure tests as appropriate. Supplementary types of nondestructive inspection techniques, such as magnetic-particle, radiographic, ultrasonic, etc., shall not be required unless specifically listed herein or in the engineering design. All inspections shall be performed in accordance with Section 108.

406.1.1.1 Welding inspections and testing. Welded gas piping shall be subject to special inspection in accordance with Chapter 17 of the *New York City Building Code*. Radiographic testing shall be performed on all butt welds in gas meter and gas distribution piping operating at pressures exceeding 5 psig (34.5 kPa gauge) within buildings, in accordance with ASME Boiler and Pressure Vessel Code, Section IX.

~~[**Welder's qualifications.** Welders installing gas piping within buildings at any pressure shall comply with the following:]~~

~~[1. Welders shall be qualified for all pipe sizes, wall thicknesses and all positions in accordance with the ASME Boiler and Pressure Vessel Code, Section IX. Requalification of welders is required on an annual basis and when requested by the commissioner.]~~

~~[2. Welder qualification testing shall be performed by an approved agency and the inspector witnessing the test shall be an authorized AWS Certified Welding Inspector. Radiographic test specimens shall be evaluated by a radiographic inspector having a minimum radiography qualification of Level II in accordance with the ASNT, Document No. SNT TC 1A, Supplement A.]~~

~~[3. Copies of the certified welder qualification reports shall be maintained by both the approved agency and the licensed master plumber employing the welder(s) for at least six years and shall be made available to the department upon request.]~~

~~[4. The approved agency shall submit certified welder qualification reports to the department upon successful qualification of a welder and when requested by the commissioner.]~~

~~[5. The licensed master plumber employing the welder(s) shall submit a statement to the department including who welded the gas piping along with a copy(s) of the certified welder qualification report(s) witnessed by a representative of the licensed master plumber, at the time of the first roughing inspection.]~~

~~**[406.1.1.2 Welding requirements.** All welded gas distribution and meter piping main and branch supplies to customer equipment operating in excess of 5 psig (34.5 kPa gauge) inside buildings shall be welded; and shall be subject to special inspection in accordance with Chapter 17 of the *New York City Building Code*. All piping 2½ inches (63.5 mm) or greater in diameter shall be butt welded, and piping less than 2½ inches (63.5 mm) in diameter may be socket welded or butt welded.]~~

~~[Radiographic testing shall be performed on all butt welds in gas meter and gas distribution piping operating at pressures exceeding 5 psig (34.5 kPa gauge) within buildings, in accordance with ASME Boiler and Pressure Vessel Code, Section IX.]~~

~~**[406.1.1.3 Welding records.** The licensed master plumber employing the welder(s) shall assign to each welder an identification symbol or number to identify the welds performed by that particular welder. The welder shall identify all welds with his or her symbol or number. The licensed master plumber shall maintain records identifying the weld(s) made by each welder for at least six years and shall make such records available to the department upon request.]~~

406.1.2 Repairs and additions. In the event repairs or additions are made after the pressure test, the affected piping shall be tested. All sections of de-energized piping shall be pressure tested in accordance with Section 406.4.

406.1.3 New branches. ~~[A piping system shall be tested as a complete unit.]~~ Where new branches are installed, the new branches shall be pressure tested. Connections between the new piping and the existing piping shall be pressure tested.

406.1.4 [System] Section testing. A piping system shall be permitted to be tested as a complete unit or in sections. Under no circumstances shall a valve in a line be used as a bulkhead between gas in one section of the piping system and test medium in an adjacent section, except where a double block and bleed valve system or flange is installed. A valve shall not be subjected to the test pressure unless the piping system upstream of the valve has been deenergized. The section of piping not subjected to the pressure test shall be checked with a

noncorrosive leak-detecting fluid or other approved leak-detecting methods. Sections may be tested at different pressures in accordance with Section 406.4.

406.1.5 Regulators and valve assemblies. Regulator and valve assemblies fabricated independently of the piping system in which they are to be installed shall be permitted to be tested with inert gas or air at the time of fabrication. Such regulators and valve assemblies shall not be subjected to the testing requirements of Section 406.4. Spool pieces shall be installed in place for the test. The regulators and valve assemblies not subjected to the pressure test shall be checked with a noncorrosive leak-detecting fluid or other approved leak-detecting methods.

406.1.6 Pipe clearing. Prior to testing, the interior of the pipe shall be purged with air or an inert gas to clear foreign material, including weld splatter, dirt, rags, and other debris left inside the pipe during welding operations or piping installation.

406.2 Test medium. The test medium shall be air, nitrogen, carbon dioxide or an inert gas. Oxygen shall not be used. [~~Fresh water may be used as the test medium only where the required test pressure exceeds 100 psig (689 kPa).~~]

406.3 Test preparation. Pipe joints [;] and piping including welds, shall be left exposed for examination during the test.

Exception: Covered or concealed pipe end joints that have been previously [~~tested~~] inspected in accordance with this code.

406.3.1 Expansion joints. Expansion joints shall be provided with temporary restraints, if required, for the additional thrust load under test.

406.3.2 Appliance and equipment isolation. Appliances and equipment that are not to be included in the test shall be either disconnected from the piping or isolated by blanks, blind flanges [;] or caps. Flanged joints at which blinds are inserted to blank off other equipment during the test shall not be required to be tested. The affected piping and joints shall be checked with a noncorrosive leak-detecting fluid or other approved leak-detecting methods when gas is energized.

406.3.3 Appliance and equipment disconnection. Where the piping system is connected to appliances or equipment designed for operating pressures of less than the test pressure, such appliances or equipment shall be isolated from the piping system by disconnecting them and capping the outlet(s). The affected piping and joints shall be checked with a noncorrosive leak-detecting fluid or other approved leak-detecting methods when gas is energized.

406.3.4 Valve isolation. Where the piping system is connected to appliances or equipment designed for operating pressures equal to or greater than the test pressure, such appliances or equipment shall be isolated from the piping system by closing the individual appliance or equipment shutoff valve(s). The affected piping and joints shall be checked with a noncorrosive leak-detecting fluid or other approved leak-detecting methods when gas is energized.

406.3.5 Testing precautions. ~~[All testing]~~ Testing of piping systems shall be ~~[done with due regard for]~~ performed in a manner that protects the safety of employees and the public during the test. Bulkheads, anchorage, and bracing suitably designed to resist test pressures shall be installed if necessary. Prior to testing, the interior of the pipe shall be purged to flush out all foreign material, including weld splatter, dirt, rags, and other debris left inside the pipe during welding operations and piping installation.

406.4 Test pressure measurement. Upon completion of the installation of a section of a gas system or of the entire gas system, and before appliances are connected thereto, the completed section or system shall be verified as to materials, and tested and proven tight ~~[as follows:]~~. Test pressure shall be measured with a manometer or with a pressure-measuring device designed and calibrated to read, record or indicate a pressure loss caused by leakage during the pressure test period. The source of pressure shall be isolated before the pressure tests are made. Mechanical gauges used to measure test pressures shall have a range such that the highest end of the scale is not greater than two times the test pressure. Gauges shall comply with the requirements of Section 406.4.3 or 406.4.4.

406.4.1 Test pressure. The test pressure to be used shall be not less than 1½ times the proposed maximum working pressure, but not less than 3 psig (20.9 kPa gauge), irrespective of design pressure. Where the test pressure exceeds 125 psig (861.8 kPa gauge), the test pressure shall not exceed a value that produces a hoop stress in the piping greater than 50 percent of the specified minimum yield strength of the pipe.

Exceptions:

~~[1. Gas distribution piping shall comply with the following:]~~

~~[1.1. Distribution pressures up to 1/2 psig (3.5 kPa gauge). The completed piping is to be tested with a nonmercury gauge at a pressure of 3 psig (20 kPa gauge) for a minimum of 30 minutes.]~~

~~[1.2. Distribution pressures over 1/2 psig (3.5 kPa gauge) through 5 psig (34.5 kPa gauge). The completed piping is to be tested at 50 psig (340 kPa gauge) for a minimum of 30 minutes.]~~

~~[1.3. Distribution pressures over 5 psig (34.5 kPa gauge) through 15 psig (100 kPa gauge). The completed piping is to be tested at 100 psig (689 kPa gauge) for a minimum of 1 hour.]~~

~~[1.4. Distribution]~~ 1. Gas piping with distribution pressures above ~~[15]~~ 5 psig (~~[100]~~ 34.5 kPa gauge) ~~[-The completed piping is to]~~ shall be tested to twice the maximum allowable operating pressure, but not less than 100 psig (~~[689]~~ 689.5 kPa gauge), for a minimum of 1 hour.

~~[1.5. Where the test pressure exceeds 125 psig (862 kPa gauge), the test pressure shall not exceed a value that produces a hoop stress in the piping greater than 50 percent of the specified minimum yield strength of the pipe.]~~

2. Gas piping installed in public corridors in accordance with Section 404 shall be tested and proven tight at a pressure of 10 psig ([69] 68.9 kPa gauge) for a minimum of 30 minutes.
3. Meter piping shall be pressure tested in accordance with the requirements of the serving utility. These requirements shall be either the same as those for testing distribution piping in ~~[numbered paragraph 1 of]~~ this section or, if different, the piping shall be certified by the ~~[local]~~ utility company as being tested in compliance with their requirements.
4. Notwithstanding the above, all field applied or factory applied coated and wrapped pipe shall be pressure tested at a minimum of [90] 100 psig ([624] 689.5 kPa gauge) for a minimum of 60 minutes. For testing, the piping shall be filled with air or an inert gas, and the source of pressure shall be isolated before the pressure readings are made. All test duration time periods are to be measured after stabilization of testing medium. ~~[Fresh water may be used as the test medium only where the required test pressure exceeds 100 psig (689 kPa gauge).]~~

406.4.1.1 Factory applied coatings. Gas piping with factory applied coatings intended to protect against corrosion during material shipping and storage shall be tested at not less than 1½ times the proposed maximum working pressure, but not less than 3 psig (20.9 kPa gauge), irrespective of design pressure. Where the test pressure exceeds 125 psig (861.8 kPa gauge), the test pressure shall not exceed a value that produces a hoop stress in the piping greater than 50 percent of the specified minimum yield strength of the pipe.

406.4.1.2 Field applied paint. Gas piping with field applied paint intended to protect against corrosion shall be tested at not less than 1½ times the proposed maximum working pressure, but not less than 3 psig (20.9 kPa gauge), irrespective of design pressure. Where the test pressure exceeds 125 psig (861.8 kPa gauge), the test pressure shall not exceed a value that produces a hoop stress in the piping greater than 50 percent of the specified minimum yield strength of the pipe.

406.4.2 Test duration. Test duration shall be not less than ½ hour, unless a greater duration is required by Section 406.4.1.

406.4.3 Minimum standards for [nonmercury] gauges.

~~[1.] This section establishes minimum standards for [nonmercury] gauges used to test gas piping [~~-, drainage and vent systems~~].~~

~~[2.] Each gauge shall meet the following requirements:~~

~~[2.1.]~~ 1. The gauge shall be manufactured and used in accordance with ASME [B 40.100] B40.100, which incorporates ASME B 40.1 and ASME B 40.7, and the manufacturer shall provide with the gauge a written statement that the gauge is manufactured in accordance with such ASME standard;

~~[2.2.]~~ 2. The gauge shall be labeled with the name of the manufacturer;

~~[2.3.]~~ The gauge shall be kept in a padded separate rigid box and the manufacturer's instructions for use and protection of the gauge shall be complied with;

~~[2.4.]~~ 3. The units of measurement "psig" shall appear on the face of the gauge; and

~~[2.5.]~~ 4. The gauge shall be kept in good working order.

~~**[406.4.2 Analog gauges used to measure pressure in the magnitude of 3 psig (20 kPa gauge).** Each analog gauge used to measure pressure in the magnitude of 3 psig (20 kPa gauge) shall meet the following requirements in addition to satisfying the minimum requirements set forth in Section 406.4.1.:~~

~~[1. The face of the gauge shall not be smaller than 2¼ inches (57 mm) in diameter;]~~

~~[2. The gauge shall have a minimum of 270 degree (5 rad) dial arc;]~~

~~[3. The gauge shall be calibrated in increments of not greater than one tenth of a pound;]~~

~~[4. The range of the gauge shall not exceed 5 psig (34.5 kPa gauge) when a 2¼ inch (57 mm) diameter gauge is used;]~~

~~[5. The 1/10 psig (0.69 kPa gauge) interval on the gauge shall not be smaller than one-tenth of an inch (2.5 mm) of arc;]~~

~~[6. The gauge shall be provided with an effective stop for the indicating pointer at the zero point;]~~

~~[7. The gauge shall be protected from excessive pressure with a shutoff valve and prior to using the 5 psig (34.5 kPa gauge) the snifter valve shall be tested with a tire gauge to determine the magnitude of pressure; and]~~

~~[8. The gauge shall have a calibration screw.]~~

~~**[406.4.3 Analog gauges used to measure pressure in the magnitude of 5 psig (34.5 kPa gauge).** Each analog gauge used to measure pressure in the magnitude of 5 psig (34.5 kPa gauge) shall meet the following requirements in addition to satisfying the minimum requirements set forth in Section 406.4.1.:~~

~~[1. The face of the gauge shall not be smaller than 2¼ inches (57 mm) in diameter;]~~

~~[2. The gauge shall have a minimum of 270 degree (5 rad) dial arc;]~~

- ~~[3. The gauge shall be calibrated in increments not greater than one fifth of a pound;]~~
- ~~[4. The range of the gauge shall not exceed 10 psig (69 kPa gauge) when a 2¼ inch (57 mm) diameter gauge is used;]~~
- ~~[5. The one fifth interval on the gauge shall not be smaller than one tenth of an inch (2.5 mm) of arc;]~~
- ~~[6. The gauge shall be provided with an effective stop for the indicating pointer at the zero point;]~~
- ~~[7. The gauge shall be protected from excessive pressure with a shutoff valve and prior to using the 10 psig (69 kPa gauge) the snifter valve shall be tested with a tire gauge to determine the magnitude of pressure; and]~~
- ~~[8. The gauge shall have a calibration screw.]~~

406.4.4 Digital gauges used to measure pressure in the magnitude of 3 psig ([20] 20.9 kPa gauge) and higher. Each digital gauge used to measure pressure in the magnitude of 3 psig ([20] 20.9 kPa gauge) and higher shall meet the following requirements in addition to satisfying the minimum requirements set forth in Section [~~406.4.1~~] 406.4.3:

1. The gauge shall have a minimum reading of $1/100$ of a psig (69 Pa), and
2. An extra charged battery shall be readily available for immediate use with the gauge.

406.4.5 Witnessing tests of gas-piping systems. Tests of gas piping systems in accordance with this code shall be witnessed by department plumbing inspectors, ~~[, or approved agencies. The department shall prescribe qualifications for individuals who are authorized to witness such tests on behalf of approved agencies, including but not limited to the requirement that such individuals shall be licensed master plumbers or registered design professionals with not less than 5 years' experience in the inspection and testing of gas piping systems. Such tests may be conducted without any verifying inspection of tests by the department, provided that verified statements and supporting inspectorial and test reports are filed with the department within one working day of such tests.]~~

406.4.6 Conducting tests of gas-piping systems. Tests of gas piping systems in accordance with this code shall be conducted by an individual with not less than five years' experience in gas work.

~~[406.4.6]~~ **406.4.7 Notification.** The holder of the plumbing permit shall give at least two days prior [~~written~~] notice to the commissioner that the plumbing work covered by the permit is ready for inspections and test.

406.5 Detection of leaks and defects. The piping system shall withstand the test pressure specified without showing any evidence of leakage or other defects. Any reduction of test pressures as indicated by pressure gauges shall be deemed to indicate the presence of a leak unless such reduction can be readily attributed to some other cause.

406.5.1 Detection methods. The leakage shall be located by means of an approved gas detector, a noncorrosive leak detection fluid [7] or other approved leak detection methods. ~~[Matches, candles, open flames, or other methods that could provide a source of ignition shall not be used.]~~

406.5.2 Corrections. Where leakage or other defects are located, the affected portion of the piping system shall be repaired or replaced and retested.

406.6 Piping system and equipment leakage check. Leakage checking of systems and equipment shall be in accordance with Sections 406.6.1 through 406.6.4.

406.6.1 Check gases. Leak checks using fuel gas shall be permitted in piping systems that have been pressure tested in accordance with Section 406.

406.6.2 Before turning gas on. During the process of turning gas on into a system of new gas piping, the entire system shall be inspected to determine that there are no open fittings or ends and that all valves at unused outlets are closed and plugged or capped.

406.6.2.1 Gas authorization required. A gas piping system shall not be energized prior to authorization. Such authorization is demonstrated by issuance of a certificate of approval of gas installation by the department. The certificate shall not be issued prior to the completion of the required inspections and tests. The certificate shall not expire.

Exception: Gas authorization shall not be required when gas is reestablished by a utility company as permitted under Section 28-105.4.3 of Chapter 1 of Title 28 of the Administrative Code.

406.6.2.1.1 Existing gas piping. Any gas piping system or part thereof that has been previously energized and has been shut down shall be required to obtain a certificate of approval of gas installation for all appliances served by the affected gas meter(s) prior to the reestablishment of gas into such system.

Exception: When an existing gas appliance is replaced and no gas piping is replaced upstream of the existing appliance shutoff valve and not more than 6 feet (1828.8 mm) of pipe is installed or replaced downstream of the existing appliance shutoff valve, a certificate of approval of gas installation shall not be required to energize such pipe or replacement appliance.

406.6.2.1.2 Partial gas authorization. A certificate of approval of gas installation may be issued for a portion of a gas piping system provided the remainder of the system is locked-off by the gas service provider.

~~[406.6.2.1]~~ **406.6.2.2 Establishing gas supply.** It shall be unlawful for any utility company to supply or restore gas to a building, place or premises in which new meters other than replacement gas meters are required until a certificate of approval of gas installation ~~[from the department]~~ is ~~[filed with such utility company]~~ issued in accordance with Section

406.6.2.1. When new gas service piping has been installed, it shall be locked-off by the utility either by locking the gas service line valve or by installing a locking device on the outside gas service line valve. The lock shall not be removed until the gas meter piping (other than utility-owned) and gas distribution piping has been inspected and certified as required by the department as being ready for service. When an existing gas service piping has been taken out of service, it shall be locked-off by the utility. The lock shall not be removed until the gas meter piping (other than utility-owned) and gas distribution piping has been inspected and certified as required by the department as being ready for service.

~~[406.6.2.2]~~ **406.6.2.3 Alterations to gas piping systems.** When alterations, extensions or repairs to existing gas meter piping or gas distribution piping requires the ~~[shutoff of gas flow to a building]~~ operation of a service head valve, regulator valve or meter valve that would interrupt the flow of gas to a building, the utility shall be notified by the owner or his or her authorized representative.

406.6.2.4 Emergency service head valve, regulator valve or gas meter valve operation. It is permissible for a licensed plumber or his or her employee to operate a valve in an emergency to alleviate a hazardous condition. The utility shall be notified by the licensee or his or her authorized representative. Such licensee or authorized representative shall wait on location for utility company operators to arrive and lock the affected valve.

406.6.3 Leak check. Immediately after the gas is turned on into a new system or into a system that has been initially restored after an interruption of service, the piping system shall be checked for abnormal operating conditions and leakage. The leakage check shall be performed by means of a combustible gas indicator complying with Section 406.7.1.4, or a noncorrosive leak detection fluid. Where leakage is indicated, or where an abnormal operating condition presents a hazard, the gas supply shall be shut off until the necessary repairs have been made.

406.6.4 Placing appliances and equipment in operation. ~~[Gas utilization appliances]~~ Appliances and equipment shall not be [permitted to be] placed in operation until after the piping system has been checked [for leakage] in accordance with Section 406.6.3 [and determined to be free of leakage and] , the piping system has been purged in accordance with Section [406.7.2] 406.7 and the connections to the appliances have been checked for leakage.

406.6.4.1 Requirements for placing [equipment] appliances in operation. The following will be required prior to placing ~~[equipment]~~ appliances in operation as applicable:

1. Required fire protection system (sprinkler or standpipe) are completed, inspected and ready for service.
2. Such ~~[equipment]~~ appliance and related equipment and gas piping are inspected by the department ~~[or authorized inspector].~~
3. Associated fire suppression system is inspected and approved by the Fire Department.

Exception: Appliances may be used as temporary sources of heat during construction as needed and in accordance with requirements of the department.

406.7 Purging. The purging of piping shall be in accordance with Sections 406.7.1 through 406.7.3.

406.7.1 Piping systems required to be purged outdoors. The purging of piping systems shall be in accordance with the provisions of Sections 406.7.1.1 through 406.7.1.4 where the piping system meets either of the following:

1. The design operating gas pressure is greater than 2 psig (~~[13.79]~~ 13.8 kPa).
2. The piping being purged contains one or more sections of pipe ~~[or tubing that meet(s)]~~ meeting the size and length criteria of Table 406.7.1.1.

406.7.1.1 Removal from service. Where existing gas piping is opened, the section that is opened shall be isolated from the gas supply and the line pressure vented in accordance with Section 406.7.1.3. Where gas piping meeting the criteria of Table 406.7.1.1 is removed from service, the residual fuel gas in the piping shall be displaced with an inert gas.

**TABLE 406.7.1.1
SIZE AND LENGTH OF PIPING**

NOMINAL PIPE SIZE (inches)	LENGTH OF PIPING (feet)
$\geq 2\frac{1}{2} < 3$	[\leq] ≥ 50
$\geq 3 < 4$	[\leq] ≥ 30
$\geq 4 < 6$	[\leq] ≥ 15
$\geq 6 < 8$	[\leq] ≥ 10
≥ 8	Any length

For SI: 1 inch = 25.4 mm, 1 foot = 304.8 mm.

406.7.1.2 Placing in operation. Where gas piping containing air and meeting the criteria of Table 406.7.1.1 is placed in operation, the air in the piping shall first be displaced with an inert gas. The inert gas shall then be displaced with fuel gas in accordance with Section 406.7.1.3.

406.7.1.3 Outdoor discharge of purged gases. The open end of a piping system being pressure vented or purged shall discharge directly to an outdoor location. Purging operations shall comply with all of the following requirements:

1. The point of discharge shall be controlled with a shutoff valve.
2. The point of discharge shall be located ~~[at least]~~ not less than 10 feet (3048 mm) from sources of ignition, ~~[at least]~~ not less than 10 feet (3048 mm) from building openings and ~~[at least]~~ not less than 25 feet (7620 mm) from mechanical air intake openings.

3. During discharge, the open point of discharge shall be continuously attended and monitored with a combustible gas indicator that complies with Section 406.7.1.4.
4. Purging operations introducing fuel gas shall be stopped when ~~[90 percent]~~ at least 95 percent fuel gas by volume is detected within the pipe.
5. Persons not involved in the purging operations shall be evacuated from all areas within 10 feet (3048 mm) of the point of discharge.

406.7.1.4 Combustible gas indicator. Combustible gas indicators shall be listed and shall be calibrated in accordance with the manufacturer's instructions. Combustible gas indicators shall numerically display a volume scale from zero percent to 100 percent in 1 percent or smaller increments.

406.7.2 Piping systems allowed to be purged indoors or outdoors. The purging of piping systems shall be in accordance with the provisions of Section 406.7.2.1 where the piping system meets both of the following:

1. The design operating gas pressure is 2 psig (13.79 kPa) or less.
2. The piping being purged is constructed entirely from pipe or tubing not meeting the size and length criteria of Table 406.7.1.1.

406.7.2.1 Purging procedure. The piping system shall be purged in accordance with one or more of the following:

~~[1. The piping shall be purged with fuel gas and shall discharge to the outdoors.]~~

~~[2. The piping shall be purged with fuel gas and shall discharge to the indoors or outdoors through an appliance burner not located in a combustion chamber. Such burner shall be provided with a continuous source of ignition.]~~

~~[3. The piping shall be purged with fuel gas and shall discharge to the indoors or outdoors through a burner that has a continuous source of ignition and that is designed for such purpose.]~~

~~[4.]~~ 1. The piping shall be purged with fuel gas that is discharged to the indoors or outdoors, and the point of discharge shall be monitored with a listed combustible ~~[has]~~ gas detector in accordance with Section 406.7.2.2. Purging shall be stopped when fuel gas is detected.

~~[5.]~~ 2. The piping shall be purged ~~[by the gas supplier]~~ in accordance with written procedures of the utility company.

406.7.2.2 Combustible gas detector. Combustible gas detectors shall be listed and shall be calibrated or tested in accordance with the manufacturer's instructions. Combustible gas detectors shall be capable of indicating the presence of fuel gas.

406.7.3 Purging appliances and equipment. After the piping system has been placed in operation, appliances and equipment subsequently installed shall be purged before being placed into operation.

SECTION FGC 407 PIPING SUPPORT

407.1 General. Piping shall be provided with support in accordance with Section 407.2. In addition, when earthquake loads are applicable in accordance with the *New York City Building Code*, a detailed piping system stress analysis including seismic analysis shall be performed. The pipe supports and restraints shall be designed and installed to accommodate the resultant seismic forces, moments and displacements from this stress analysis in accordance with the *New York City Building Code*.

407.2 Design and installation. Piping shall be supported with metal pipe hooks, metal pipe straps, metal bands, metal brackets, metal hangers or building structural components, suitable for the size of piping, of adequate strength and quality, and located at intervals so as to prevent or damp out excessive vibration. Piping shall be anchored to prevent undue strains on connected appliances and shall not be supported by other piping. Pipe hangers and supports shall conform to the requirements of MSS SP-58 and shall be spaced in accordance with Section 415. Supports, hangers [7] and anchors shall be installed so as not to interfere with the free expansion and contraction of the piping between anchors. All parts of the supporting equipment shall be designed and installed so that they will not be disengaged by movement of the supported piping.

SECTION FGC 408 DRIPS AND SLOPED PIPING

408.1 Slopes. Piping for other than dry gas conditions shall be sloped not less than ¼ inch in 15 feet (6.3 mm in 4572 mm) to prevent traps. The local gas supplier/utility company should be consulted to determine the type of fuel gas available for the intended service.

408.2 Drips. [~~Where the local gas supplier/utility company requires, a manufactured test fitting or drip leg shall be installed downstream of a lockable supply/riser valve in accordance with the requirements for installation of the serving utility. No other locations will be allowed to prevent additional unapproved gas connections.~~] Drips are not permitted.

408.3 [Reserved.] Test fittings. A manufactured test fitting shall be installed where required by the gas supplier. Such fitting shall be downstream of a lockable supply or riser valve in accordance with the requirements of the gas supplier and the manufacturer's instructions. The outlet of the test fitting shall be the smallest commercially available. The installation of manufactured test fittings in other locations shall be prohibited.

408.4 Sediment trap. Where a sediment trap is not incorporated as part of the appliance, a sediment trap shall be installed downstream of the appliance shutoff valve as close to the inlet of

the appliance as practical. The sediment trap shall be either a tee fitting having a capped nipple of any length installed vertically in the bottom most opening of the tee as illustrated in Figure 408.4 or other device approved as an effective sediment trap. Illuminating appliances, ranges, clothes dryers, decorative vented appliances for installation in vented fireplaces, gas fireplaces [7] and outdoor grills need not be so equipped.

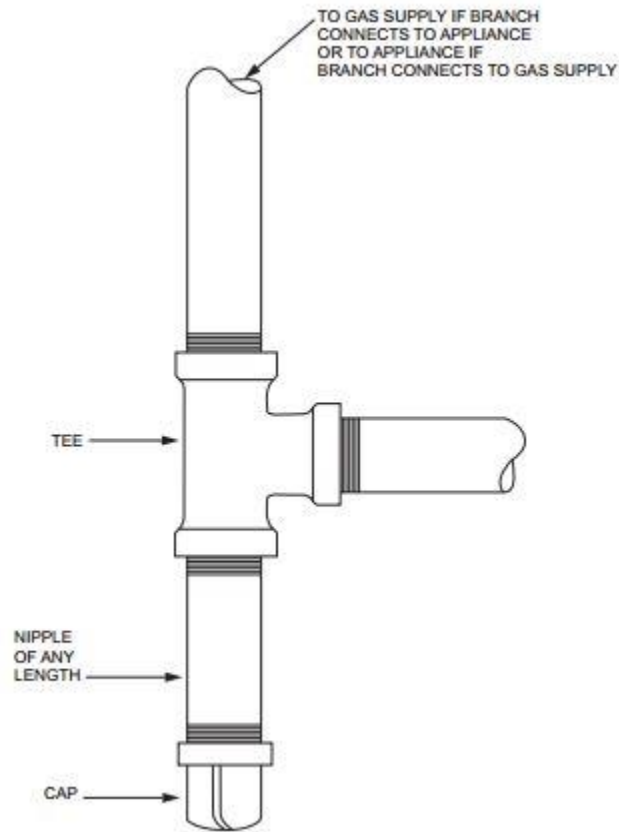

FIGURE 408.4
METHOD OF INSTALLING A TEE FITTING SEDIMENT TRAP

**SECTION FGC 409
SHUTOFF VALVES**

409.1 General. Piping systems shall be provided with shutoff valves in accordance with this section.

409.1.1 Valve approval. Shutoff valves shall be of an approved type; shall be constructed of materials compatible with the piping; and shall comply with the standard that is applicable for the pressure and application, in accordance with Table 409.1.1.

**TABLE 409.1.1
MANUAL GAS VALVE STANDARDS**

VALVE STANDARDS	APPLIANCE SHUTOFF VALVE APPLICATION UP TO 1/2 psig	OTHER VALVE APPLICATIONS			
		UP TO 1/2 psig PRESSURE	UP TO 2 psig PRESSURE	UP TO 5 psig PRESSURE	UP TO 125 psig PRESSURE
ANSI Z21.15/CGA 9.1	X	—	—	—	—
[CSA Requirement 3-88]	[X]	[X]	[X ^a]	[X ^b]	[—]
ASME B16.44	X	X	X ^a	X ^b	—
ASME B16.33	X	X	X	X	X

For SI: 1 pound per square inch gauge = 6.895 kPa.

a. If labeled 2G.

b. If labeled 5G.

409.1.2 Prohibited locations. Shutoff valves shall be prohibited in concealed locations and furnace plenums.

409.1.3 Access to shutoff valves. Shutoff valves shall be located in places so as to provide access for operation and shall be installed so as to be protected from damage.

409.2 Meter valve. Every meter shall be equipped with a shutoff valve located on the supply side of the meter. Meter valves shall be of a type approved by the utility company.

409.3 Shutoff valves for multiple-house line systems. Where a single meter is used to supply gas to more than one building or tenant, a separate shutoff valve shall be provided for each building or tenant.

409.3.1 Multiple tenant buildings. In multiple tenant buildings, where a common piping system is installed to supply other than individual dwelling units, shutoff valves shall be provided for each tenant. Each tenant shall have access to the shutoff valve serving that tenant's space.

409.3.2 Individual buildings. In a common system serving more than one building, shutoff valves shall be installed outdoors at each building.

409.3.3 Identification of shutoff valves. Each house line shutoff valve shall be plainly marked with an identification tag attached by the installer so that the piping systems supplied by such valves are readily identified. Identification shall be provided in compliance with ASME A13.1.

409.4 MP regulator valves. [~~A-listed~~] An approved shutoff valve shall be installed immediately ahead of each MP regulator.

409.5 Appliance shutoff valve. Each appliance shall be provided with a shutoff valve in accordance with Section 409.5.1 [~~;~~] or 409.5.2 [~~or 409.5.3~~].

409.5.1 Located within the same room. The shutoff valve shall be located in the same room as the appliance. The shutoff valve shall be within 6 feet (~~[1829]~~ 1828.8 mm) of the appliance, and shall be installed upstream of the union, connector or quick disconnect device it serves. Such shutoff valves shall be provided with access and located not more than 60 inches (1524 mm) above the finished floor. Appliance shutoff valves located in the firebox of a fireplace shall be installed in accordance with the appliance manufacturer's instructions. Where the shutoff valve is located in the firebox, a remote shutoff valve shall also be provided.

Exception: Shutoff valves may be located more than 60 inches (1524 mm) above the finished floor where the gas connection to the appliance is more than 60 inches (1524 mm) above the finished floor.

409.5.2 Vented decorative appliances and room heaters. Shutoff valves for vented decorative appliances, room heaters and decorative appliances for installation in vented fireplaces shall be permitted to be installed in an area remote from the appliances where such valves are provided with ready access. Such valves shall be permanently identified and shall not serve [~~no other~~] another appliance. The piping from the shutoff valve to within 6 feet (~~[1829]~~ 1828.8 mm) of the appliance shall be designed, sized and installed in accordance with Sections 401 through 408.

409.6 Shutoff valve for laboratories. Where provided with two or more fuel gas outlets, including table-, bench- and hood-mounted outlets, each laboratory space in educational, research, commercial and industrial occupancies shall be provided with a single dedicated shutoff valve through which all such gas outlets shall be supplied. The dedicated shutoff valve shall be readily accessible, located within the laboratory space served, located adjacent to the egress door from the space and shall be identified by approved signage stating "Gas Shutoff."

409.7 Outside gas cut-off. An outside gas service line valve or other outside shutoff device or method acceptable to the commissioner shall be provided in accordance with Section E.2 of Appendix E [~~of this code~~].

409.8 Riser shutoff valves. Risers shall be equipped with an approved lockable shutoff valve. There shall be a test port installed downstream of the valve.

409.9 Branch shutoff valves. Branches serving more than one appliance shall be equipped with an approved lockable shutoff valve. There shall be a test port installed downstream of the valve.

SECTION FGC 410 FLOW CONTROLS

410.1 Pressure regulators. A line pressure regulator shall be installed where the appliance is designed to operate at a lower pressure than the supply pressure. Line gas pressure regulators shall be listed as complying with ANSI Z21.80/CSA 6.22. Access shall be provided to pressure regulators. Pressure regulators shall be protected from physical damage. Regulators installed on the exterior of the building shall be approved for outdoor installation.

410.2 MP regulators. Medium pressure (MP) regulators shall comply with the following:

1. The MP regulator shall be approved and shall be suitable for the inlet and outlet gas pressures for the application.
2. The MP regulator shall maintain a reduced outlet pressure under lockup (no-flow) conditions.
3. The capacity of the MP regulator, determined by published ratings of its manufacturer, shall be adequate to supply the appliances served.
4. The MP regulator shall be provided with access. Where located indoors, the regulator shall be vented to the outdoors or shall be equipped with a leak-limiting device, in either case complying with Section 410.3.
5. A tee fitting with one opening capped or plugged shall be installed between the MP regulator and its upstream shutoff valve. Such tee fitting shall be positioned to allow connection of a pressure-measuring instrument and to serve as a sediment trap.
6. A tee fitting with one opening capped or plugged shall be installed not less than 10 pipe diameters downstream of the MP regulator outlet. Such tee fitting shall be positioned to allow connection of a pressure-measuring instrument. A pressure gauge with an isolation valve may also be installed in addition to the fitting.
7. At least one union shall be installed within 1 foot (304.8 mm) of either side of the MP regulator.

410.3 Venting of regulators. Pressure regulators that require a vent shall be vented directly to the outdoors. The vent terminal shall be a minimum of 18 inches (~~[457]~~ 457.2 mm) above grade, not under ~~[an opening to the building]~~ a building-opening or overhang, and shall be installed so as to prevent the entrance of water and insects.

Exception: A vent to the outdoors is not required for regulators [~~less than 1¼ inches (31.7 mm) NPS~~] equipped with and labeled for utilization with an approved vent-limiting [devices] device installed in accordance with ANSI Z21.18 and the manufacturer's instructions. The

vent-limiting device shall be installed in a location sufficiently ventilated to dissipate any gas discharged from the device.

410.3.1 Vent piping. Vent piping for relief vents and breather vents shall be constructed of materials allowed for gas piping in accordance with Section 403. Vent piping shall be not smaller than the vent connection on the [~~pressure-regulating~~] pressure-regulating device. Vent piping serving relief vents and combination relief and breather vents shall be run independently to the outdoors and shall serve only a single device vent. Vent piping serving only breather vents is permitted to be connected in a manifold arrangement where sized in accordance with an approved design that minimizes back pressure in the event of diaphragm rupture. Regulator vent piping shall not exceed the length specified in the [~~regulator's~~] regulator manufacturer's [~~installation~~] instructions.

410.4 Excess flow valves. Where automatic excess flow valves are installed, they shall be listed for the application and shall be sized and installed in accordance with the manufacturer's instructions.

410.5 Flashback arrestor check valve. Where fuel gas is used with oxygen in any hot work operation, a listed protective device that serves as a combination flashback arrestor and backflow check valve shall be installed at an approved location on both the fuel gas and oxygen supply lines. Where the pressure of the piped fuel gas supply is insufficient to ensure such safe operation, approved equipment shall be installed between the gas meter and the appliance that increases pressure to the level required for such safe operation.

SECTION FGC 411 APPLIANCE AND MANUFACTURED HOME CONNECTIONS

411.1 Connecting appliances. Except as required by Section 411.1.1, appliances shall be connected to the piping system by one of the following:

1. Rigid metallic pipe and fittings. Space heaters and water heaters [~~within dwelling units~~] shall be connected using rigid piping and fittings only. Use of semirigid (flexible) metallic tubing, fittings, appliance connectors or quick-disconnect devices is not permitted for this application.
2. Listed and labeled appliance connectors in compliance with ANSI Z21.24/CGA 6.10 and installed in accordance with the manufacturer's [~~installation~~] instructions and located entirely in the same room as the appliance. Connectors shall have an overall length not to exceed 6 feet (1828.8 mm). Measurement shall be made along the centerline of the connector. Only one connector shall be used for each appliance.
3. Listed and labeled quick-disconnect devices used in conjunction with listed and labeled appliance connectors.
4. Listed and labeled convenience outlets used in conjunction with listed and labeled appliance connectors.

5. Listed and labeled outdoor appliance connectors [~~complying~~] in compliance with ANSI Z21.75/CSA 6.27 and installed in accordance with the manufacturer's [~~installation~~] instructions.
6. Listed outdoor gas hose connectors in compliance with ANSI Z21.54 used to connect portable outdoor appliances. The gas hose connection shall be made only in the outdoor area where the appliance is used, and shall be to the gas piping supply at an appliance shutoff valve, a listed quick-disconnect device or listed gas convenience outlet.

411.1.1 Commercial cooking appliances. Commercial cooking appliances installed on casters and appliances that are moved for cleaning and sanitation purposes shall be connected to the piping system with an appliance connector listed as complying with ANSI Z21.69/CSA 6.16 and NSF/ANSI 169 or in accordance with Item 1 of Section 411.1. The commercial cooking appliance connector installation shall be configured in accordance with the manufacturer's instructions. Movement of appliances with casters shall be limited by a restraining device installed in accordance with the connector and appliance manufacturer's instructions.

411.1.2 Protection against damage. Connectors and tubing shall be installed so as to be protected against physical damage.

411.1.3 Connector installation. Fuel connectors shall be installed in accordance with the manufacturer's instructions and Sections 411.1.3.1 through 411.1.3.4.

411.1.3.1 Maximum length. Connectors shall have an overall length not to exceed 6 feet ([~~1829~~] 1828.8 mm). Measurement shall be made along the centerline of the connector. Only one connector shall be used for each appliance.

411.1.3.2 Minimum size. Connectors shall have the capacity for the total demand of the connected appliance.

411.1.3.3 Prohibited locations and penetrations. Connectors shall not be concealed within, or extended through, walls, floors, partitions, ceilings or appliance housings.

Exceptions:

1. Connectors constructed of materials allowed for piping systems in accordance with Section 403 shall be permitted to pass through walls, floors, partitions and ceilings where installed in accordance with Section 409.5.2.
2. Rigid steel pipe connectors shall be permitted to extend through openings in appliance housings.
3. Fireplace inserts that are factory equipped with grommets, sleeves or other means of protection in accordance with the listing of the appliance.

4. Listed connectors shall be permitted to extend through an opening in an appliance housing, cabinet or casing where the tubing or connector is protected against damage.

411.1.3.4 Shutoff valve. A shutoff valve not less than the nominal size of the piping system shall be installed ahead of the connector in accordance with Section 409.5.

411.1.4 Movable appliances. Where appliances are equipped with casters or are otherwise subject to periodic movement or relocation for purposes such as routine cleaning and maintenance, such appliances shall be connected to the supply system piping by means of an ~~[approved flexible connector designed and labeled for the application]~~ appliance connector listed as complying with ANSI Z21.69/CSA 6.16 or by means of Item 1 of Section 411.1 of this code. Such flexible connectors shall be installed and protected against physical damage in accordance with the manufacturer's ~~[installation]~~ instructions.

411.1.5 Connection of gas engine-powered air conditioners. Internal combustion engines shall not be rigidly connected to the gas supply piping.

411.1.6 Unions. A union fitting shall be provided for appliances connected by rigid metallic pipe. Such unions shall be accessible and located within 6 feet (~~[1829]~~ 1828.8 mm) of the appliance.

411.2 Manufactured home connections. Manufactured homes shall be connected to the distribution piping system by one of the following materials:

1. Metallic pipe in accordance with Section 403.4.
2. Listed and labeled connectors in compliance with ANSI Z21.75/CSA 6.27 and installed in accordance with the manufacturer's ~~[installation]~~ instructions.

411.3 Suspended low-intensity infrared tube heaters. Suspended low-intensity infrared tube heaters shall be connected to the building piping system with a connector listed for the application complying with ANSI Z21.24/CGA 6.10. The connector shall be installed as specified by the tube heater manufacturer's instructions.

SECTION FGC 412

LIQUEFIED PETROLEUM GAS MOTOR VEHICLE FUEL-DISPENSING ~~[STATIONS]~~ FACILITIES

412.1 Applicability. Motor fuel-dispensing facilities for LP-gas fuel shall be designed and operated in accordance with the *New York City Fire Code*.

412.2 Reserved.

412.3 Reserved.

412.4 Reserved.

412.5 Reserved.

412.6 Reserved.

412.7 Reserved.

412.8 Reserved.

SECTION FGC 413
COMPRESSED NATURAL GAS MOTOR VEHICLE FUEL-DISPENSING [STATIONS]
FACILITIES

413.1 Applicability. Motor fuel-dispensing facilities for CNG fuel shall be designed and operated in accordance with the *New York City Fire Code*.

413.2 Reserved.

413.3 Reserved.

413.4 Reserved.

413.5 Reserved.

413.6 Reserved.

413.7 Reserved.

413.8 Reserved.

SECTION FGC 414
RESERVED

SECTION FGC 415
PIPING SUPPORT INTERVALS

415.1 Interval of support. Piping shall be supported at intervals not exceeding the spacing specified in Table 415.1.

TABLE 415.1
SUPPORT OF PIPING

STEEL PIPE, NOMINAL SIZE OF PIPE (inches)	SPACING OF SUPPORTS (feet)
½	6
¾ or 1	8
1¼ or larger (horizontal)	12

**TABLE 415.1
SUPPORT OF PIPING**

STEEL PIPE, NOMINAL SIZE OF PIPE (inches)	SPACING OF SUPPORTS (feet)
All vertical piping	Every floor level

For SI: 1 inch = 25.4 mm, 1 foot = 304.8 mm.

**SECTION FGC 416
OVERPRESSURE PROTECTION DEVICES**

416.1 [General. ~~Overpressure protection devices shall be provided in accordance with this section to prevent the pressure in the piping system from exceeding the pressure that would cause unsafe operation of any connected and properly adjusted appliances.]~~ **Where required.** Where the serving gas supplier delivers gas at a pressure greater than 2 psi (13.79 kPa) for piping systems serving appliances designed to operate at a gas pressure of 14 inches w.c. (3.49 kPa) or less, overpressure protection devices shall be installed. Piping systems serving appliances designed to operate at inlet pressures greater than 14 inches w.c. (3.49 kPa) shall be equipped with overpressure protection devices as required by the appliance manufacturer's instructions.

416.2 [Protection methods. ~~The requirements of this section shall be considered to be met and a piping system deemed to have overpressure protection where a service or line pressure regulator plus one other device are installed such that the following occur:]~~

- [1. ~~Each device limits the pressure to a value that does not exceed the maximum working pressure of the downstream system.]~~
- [2. ~~The individual failure of either device does not result in the over-pressurization of the downstream system.]~~

Pressure limitation requirements. The requirements for pressure limitation shall be in accordance with Sections 416.2.1 through 416.2.5.

416.2.1 Pressure under 14 inches w.c. Where piping systems serving appliances designed to operate with a gas supply pressure of 14 inches w.c. (3.49 kPa) or less are required to be equipped with overpressure protection by Section 416.1, each overpressure protection device shall be adjusted to limit the gas pressure to each connected appliance to 2 psi or less upon a failure of the line pressure regulator.

416.2.2 Pressure over 14 inches w.c. Where piping systems serving appliances designed to operate with a gas supply pressure greater than 14 inches w.c. (3.49 kPa) are required to be equipped with overpressure protection by Section 416.1, each overpressure protection device shall be adjusted to limit the gas pressure to each connected appliance as required by the appliance manufacturer's instructions.

416.2.3 Device capability. Each overpressure protection device installed to meet the requirements of this section shall be capable of limiting the pressure to its connected appliance(s) as required by Section 416.2.1, independently of any other pressure control equipment in the piping system.

416.2.4 Failure detection. Each gas piping system for which an overpressure protection device is required by Section 416 shall be designed and installed so that a failure of the primary pressure control device(s) is detectable.

416.2.5 Relief valve. Where a pressure relief valve is used to meet the requirements of Section 416, it shall have a flow capacity such that the pressure in the protected system is maintained at or below the limits specified in Section 416.2.1 under all of the following conditions:

1. The line pressure regulator for which the relief valve is providing overpressure protection has failed wide open.
2. The gas pressure at the inlet of the line pressure regulator for which the relief valve is providing overpressure protection is not less than the regulator's normal operating inlet pressure.

~~[416.3 Device maintenance. The overpressure protection device shall be properly maintained and inspected every two years by a Licensed Master Plumber and inspection records shall be maintained by the Owner and made available for the Department; and inspection procedures shall be in accordance with the commissioner; and replacements or repairs shall be promptly made.]~~

~~[Exception: Where the gas pressure is 15 psig (103 kPa gauge) or above, the overpressure protection device shall be inspected annually.]~~

~~[416.4 Where required. A pressure-relieving or pressure-limiting device shall not be required where: (1) the gas does not contain materials that could seriously interfere with the operation of the service or line pressure regulator; (2) the operating pressure of the gas source is 5 psi (34.5 kPa) or less; and (3) service or line pressure regulator has all of the following design features or characteristics:]~~

- ~~[1. Pipe connections to the service or line regulator do not exceed 2 inches (51 mm) nominal diameter.]~~
- ~~[2. The regulator is self-contained with no external static or control piping.]~~
- ~~[3. The regulator has a single port valve with an orifice diameter not greater than that recommended by the manufacturer for the maximum gas pressure at the regulator inlet.]~~
- ~~[4. The valve seat is made of resilient material designed to withstand abrasion of the gas, impurities in the gas and cutting by the valve, and to resist permanent deformation where it is pressed against the valve port.]~~
- ~~[5. The regulator is capable, under normal operating conditions, of regulating the downstream pressure within the necessary limits of accuracy and of limiting the discharge pressure~~

~~under no flow conditions to not more than 150 percent of the discharge pressure maintained under flow conditions.]~~

[416.5] 416.3 Devices. Pressure-relieving or pressure-limiting devices shall be one of the following:

1. ~~[Spring-loaded relief device.]~~ Pressure relief valve.
2. ~~[Pilot-loaded back pressure regulator used as a relief valve and designed so that failure of the pilot system or external control piping will cause the regulator relief valve to open.]~~ Monitoring regulator.
3. ~~[A monitoring]~~ Series regulator installed [in series with the service or] upstream from the line [pressure] regulator and set to continuously limit the pressure on the inlet of the line regulator to the maximum values specified by Section 416.2.1.
4. ~~[An automatic]~~ Automatic shutoff device installed in series with the [service or] line pressure regulator and set to shut off when the pressure on the downstream piping system reaches the maximum [working pressure or some other predetermined pressure less than the maximum working pressure] values specified by Section 416.2.1. This device shall be designed so that it will remain closed until manually reset.
- ~~5. A liquid seal relief device that can be set to open accurately and consistently at the desired pressure.]~~

The devices specified in this section shall be installed either as an integral part of the service or line pressure regulator or as separate units. Where separate pressure-relieving or pressure-limiting devices are installed, they shall comply with Sections ~~[416.5.1]~~ 416.3.1 through ~~[416.5.6]~~ 416.3.6.

~~[416.5.1]~~ 416.3.1 Construction and installation. ~~[Pressure-relieving]~~ Pressure-relieving and pressure-limiting devices shall be constructed of materials so that the operation of the devices will not be impaired by corrosion of external parts by the atmosphere or of internal parts by the gas. Pressure-relieving and pressure-limiting devices shall be designed and installed so that they can be operated to determine whether the valve is free. The devices shall ~~[also]~~ be designed and installed so that they can be tested to determine the pressure at which they will operate and examined for leakage when in the closed position. The devices shall be maintained and inspected in accordance with Section 416.3.7.

~~[416.5.2]~~ 416.3.2 External control piping. External control piping shall be ~~[protected from falling objects, excavations and other causes of damage and shall be]~~ designed and installed so that damage to ~~[any]~~ the control piping of one device will not render both the regulator and the overpressure ~~[protective]~~ protection device inoperative.

~~[416.5.3]~~ 416.3.3 Setting. Each pressure-relieving or pressure-limiting device shall be set so that the gas pressure [does not exceed a safe level beyond the maximum allowable working pressure for] supplied to the connected [piping and] appliances does not exceed the limits specified in Section 416.2.1.

[416.5.4] 416.3.4 Unauthorized operation. Precautions shall be taken to prevent unauthorized operation of any shutoff valve that will make a pressure-relieving valve or pressure-limiting device inoperative. The valve shall be locked ~~[for]~~ or continuously monitored in the open position.

[416.5.5] 416.3.5 Vents. The discharge stacks, vents and outlet parts of all pressure-relieving and pressure-limiting devices shall be located so that gas is safely discharged to the outdoors. Discharge stacks and vents shall be designed to prevent the entry of water, insects and other foreign material that could cause blockage. The discharge stack or vent line shall be ~~[at least]~~ not less than the same size as the outlet of the pressure-relieving device.

[416.5.6] 416.3.6 Size of fittings, pipe and openings. The fittings, pipe and openings located between the system to be protected and the pressure-relieving device shall be sized to prevent hammering of the valve and to prevent impairment of relief capacity.

416.3.7 Device maintenance. The overpressure protection device: (i) shall be properly maintained and inspected every two years by a licensed master plumber; (ii) inspection records shall be maintained by the owner and made available to the department; (iii) inspection procedures shall be in accordance with the commissioner; and (iv) replacements or repairs shall be promptly made.

Exception: Where the gas pressure is 15 psig (103.4 kPa gauge) or above, the overpressure protection device shall be inspected annually.

§ 6. Chapter 5 of the New York city fuel gas code, as amended by, and sections 507 and 508 as added by, local law number 141 for the year 2013, and section 504.3.20 as added by local law number 51 for the year 2014, is amended to read as follows:

CHAPTER 5 CHIMNEYS AND VENTS

SECTION FGC 501 GENERAL

501.1 Scope. This chapter shall govern the installation, alteration, maintenance, design, minimum safety requirements, repair and approval of factory-built chimneys, chimney liners, vents and connectors, field-built chimneys and connectors and the utilization of masonry chimneys serving gas-fired appliances. The requirements for the installation, maintenance, repair and approval of factory-built chimneys, chimney liners, vents and connectors serving appliances burning fuels other than fuel gas shall be regulated by the *New York City Mechanical Code*. The construction, repair, maintenance and approval of masonry chimneys shall be regulated by the *New York City Building Code*. Venting systems shall be designed in accordance with this chapter and comply with the requirements of the *New York City Air Pollution Control Code*.

501.1.1 ~~[Adjoining]~~ Existing chimneys and vents. ~~[Adjoining]~~ Existing chimneys and vents shall ~~[be in accordance with]~~ comply with the requirements of Section 28-104.13 of the *Administrative Code* and Sections 501.1.1.1 through 501.1.1.8 of this code.

501.1.1.1 Responsibility of owner of taller building. Whenever a building is erected, enlarged, or increased in height so that any portion of such building, except chimneys or vents, extends higher than the top of any [~~previously constructed~~] existing chimneys or vents within 100 feet (30 480 mm), the owner of such new or altered building shall have the responsibility of altering such chimneys or vents to make them conform with the requirements of this chapter. A chimney or vent that is no longer connected with a fireplace or combustion or other equipment for which a chimney or vent was required shall be exempt from this requirement. Such alterations shall be accomplished by one of the following means or a combination thereof:

1. Carry up the [~~previously constructed~~] existing chimneys or vents to the height required in this chapter.
2. Offset such chimneys or vents to a distance beyond that required by this chapter from the new or altered building provided that the new location of the outlet of the offset chimney or vent shall otherwise comply with the requirements of this chapter.

Such requirements shall not dispense with or modify any additional requirements that may be applicable pursuant to rules of the *New York City Department of Environmental Protection*.

501.1.1.1.1 Chimney and vent plan. Applications for a new or altered building shall include a chimney and vent plan submitted pursuant to Section 107.18 of the *New York City Building Code*.

501.1.1.2 Protection of draft. After the alteration of a chimney or vent as required by this section, it shall be the responsibility of the owner of the new or altered building to provide any mechanical equipment or devices necessary to maintain the proper draft in the equipment.

501.1.1.3 Written notification, plans and required documents. The owner of the new or altered building shall notify the owner of [~~the~~] any building that may require a chimney or vent to be altered. Notification, plans and required documents shall comply with the requirements of Sections 501.1.1.3.1 through 501.1.1.3.3. [~~affected in writing at least 45 days before starting the work required and request written consent to do such work. Such notice shall be accompanied by plans indicating the manner in which the proposed alterations are to be made.]~~

501.1.1.3.1 First notice. Written notice in a form acceptable to the department shall be provided to the building owner not less than 60 days prior to a request for permit for construction on the new or altered building. Such notice shall include a request for access to determine the need to alter the existing chimney or vent and a description of such work. Notice shall be sent by regular mail and certified mail, return receipt requested. A copy of such return receipt shall be filed with the department.

501.1.1.3.2 Second notice. Written notice in a form acceptable to the department shall be provided to the building owner not more than 45 days following commencement of

work after a permit has been issued for the new or altered building. Such notice shall include a request for access to determine the need to alter the existing chimney or vent and a description of such work. Notice shall be sent by regular mail and certified mail, return receipt requested. The second notice shall also be posted by a licensed process server at the public entrance of the building requiring a chimney or vent to be altered. A copy of such return receipt and proof of service by the licensed process server shall be filed with the department.

Exceptions:

1. A second notice shall not be required where an application to alter the affected chimney or vent has been filed with the department.
2. A second notice shall not be required where access is granted and conditions are observed that result in a determination that chimney or vent alteration is not required and a revised chimney and vent plan is submitted to the department.

501.1.1.3.3 Plans and required documentation for alteration work. Where access is granted and conditions are observed that result in a determination that chimney or vent alteration is required, plans for such alteration work shall be provided to the owner of the existing building and a request for written consent to submit construction documents and perform such work shall be made.

501.1.1.4 Approval. The [~~plans and method of~~] construction documents for the proposed chimney extension, alteration or relocation shall be [subject] submitted to the [approval of the commissioner] department pursuant to Section 28-104 of the *Administrative Code*. No certificate of occupancy shall be issued for the new building pursuant to Section 28-118.23 of the *Administrative Code* until the work associated with the construction documents for the proposed chimney extension, alteration or relocation has been signed-off by the department.

Exceptions:

1. A certificate of occupancy may be issued where access is granted and conditions are observed that result in a determination that chimney or vent alteration is not required and a revised chimney or vent plan is submitted pursuant to Section 107.18 of the *New York City Building Code* documenting such.
2. A certificate of occupancy may be issued in accordance with Section 28-118.23, Exception 2 of the *Administrative Code*.

501.1.1.5 Refusal of consent. If consent is not granted by the owner of the [~~previously constructed~~] affected building to do the alteration work required by this section, such owner shall signify his or her refusal in writing to the owner of the new or altered building and to the commissioner; and the owner of the new or altered building having [~~submitted plans that conform to the requirements of this section,~~] provided the notices required by

Section 501.1.1.3 shall thereupon be released from any responsibility for the proper operation of the equipment due to loss of draft and for any health hazard or nuisance that may occur as a result of the new or altered building. Such responsibilities shall then be assumed by the owner of the previously constructed building. Similarly, should such owner fail to grant consent within 45 days from the date of [~~written request~~] the second notice or fail to signify his or her refusal, he or she shall then assume all responsibilities as prescribed above.

501.1.1.6 Procedure. It shall be the obligation of the owner of the new or altered building to:

1. Prepare and submit a chimney and vent plan to the department pursuant to Section 107.18 of the *New York City Building Code*.
2. Provide required notification pursuant to Section 501.1.1.3 of this code.
3. Provide plans pursuant to Section 501.1.1.3.3 of this code.
4. Prepare and submit construction documents to the department pursuant to Section 28-104 of the *Administrative Code* for the alteration of existing chimneys or vents which conform to the requirements of this chapter;
5. Obtain permit(s) for the proposed work in accordance with Section 28-105 of the *Administrative Code*;
6. Schedule this work so as to create a minimum of disturbance to the occupants of the affected building;
- [2] 7. Provide such essential services as are normally supplied by the equipment while it is out of service;
- [3] 8. Where necessary, support such extended chimneys, vents and equipment from this building or to carry up such chimneys or vents within his or her building;
- [4] 9. Provide for the maintenance, repair, and/or replacement of such extensions and added equipment; [~~and~~]
- [5] 10. Make such alterations of the same material as the original chimney or vent so as to maintain the same quality and appearance, except where the owner of the chimney or vent shall give his or her consent to do otherwise. All work shall be done in such fashion as to maintain the architectural aesthetics of the existing building. Where there is practical difficulty in complying strictly with the provisions of this item, the commissioner may permit an equally safe alternative[-];
11. Comply with the tenant protection plan requirements of Section 28-120 of the *Administrative Code*; and

12. Comply with inspection and sign-off requirements of Section 28-116 of the Administrative Code.

501.1.1.7 Existing violations. Any existing violations on the previously constructed equipment shall be corrected by the owner of the equipment before any equipment is added or alterations made at the expense of the owner of the new or altered building.

501.1.1.8 Variance. The commissioner may grant a variance in accordance with the provisions of this code.

501.2 General. Every appliance shall discharge the products of combustion to the outdoors, except for appliances exempted by Section 501.8.

Exception: Commercial cooking appliances vented by a Type I hood installed in accordance with [MC] Section 507 of the *New York City Mechanical Code*.

501.2.1 Design. Chimneys and vents shall be designed and constructed so as to provide the necessary draft and capacity for each appliance connected to completely exhaust the products of combustion to the outside air. The temperature on adjacent combustible surfaces shall not be raised above 160°F (~~[74]~~71.1°C). Chimneys and vents shall be designed to resist the effects of condensation that would cause deterioration of the chimney or vent.

501.2.2 Outlets. The outlet shall be arranged so that the flue gases are not directed so that they jeopardize people, overheat combustible structures, or enter building openings in the vicinity of the outlet. Gas-fired appliances shall be vented in accordance with this code and NFPA 54.

501.2.3 Support. Chimneys and vents shall not be supported by the equipment they serve unless such equipment has been specifically designed for such loads.

501.2.4 Changes in appliance fuels. Masonry chimneys shall be constructed in accordance with Section 507.

501.2.5 Exhaust gases from internal combustion engines and turbines. Exhaust pipes shall be constructed in accordance with Section 508.

501.3 Masonry chimneys. Masonry chimneys shall be constructed in accordance with Section 503.5.3 and the *New York City Building Code*.

501.4 Minimum size of chimney or vent. Chimneys and vents shall be sized in accordance with Sections 503 and 504.

501.5 Abandoned inlet openings. Abandoned inlet openings in chimneys and vents shall be closed by an approved method.

501.6 Positive pressure. Where an appliance equipped with a mechanical forced draft system creates a positive pressure in the venting system, the venting system shall be designed for positive pressure applications.

501.7 Connection to fireplace. Connection of appliances to chimney flues serving fireplaces shall be in accordance with Sections 501.7.1 through 501.7.3.

501.7.1 Closure and access. A noncombustible seal shall be provided below the point of connection to prevent entry of room air into the flue. Means shall be provided for access to the flue for inspection and cleaning.

501.7.2 Connection to factory-built fireplace flue. An appliance shall not be connected to a flue serving a factory-built fireplace unless the appliance is specifically listed for such installation. The connection shall be made in accordance with the appliance manufacturer's [~~installation~~] instructions.

501.7.3 Connection to masonry fireplace flue. A connector shall extend from the appliance to the flue serving a masonry fireplace such that the flue gases are exhausted directly into the flue. The connector shall be accessible or removable for inspection and cleaning of both the connector and the flue. Listed direct connection devices shall be installed in accordance with their listing.

501.8 Appliances not required to be vented. The following appliances shall not be required to be vented:

1. Ranges.
2. Built-in domestic cooking units listed and marked for optional venting.
3. Hot plates and laundry stoves.
4. Type 1 clothes dryers (Type 1 clothes dryers shall be exhausted in accordance with the requirements of Section [~~614~~] 504 of the *New York City Mechanical Code*).
5. A single booster-type automatic instantaneous water heater, where designed and used solely for the sanitizing rinse requirements of a dishwashing machine, provided that the heater is installed in a commercial kitchen having a mechanical exhaust system. Where installed in this manner, the draft hood, if required, shall be in place and unaltered and the draft hood outlet shall be not less than 36 inches (~~[914]~~ 914.4 mm) vertically and 6 inches (~~[152]~~ 152.4 mm) horizontally from any surface other than the heater.
6. Refrigerators.
7. Counter appliances.
8. Specialized appliances of limited input such as laboratory burners and gas lights.
9. Recirculating direct-fired industrial air heaters as provided for in Section 612.

Where the appliances listed in Items 5 through 9 above are installed so that the aggregate input rating exceeds 20 British thermal units (Btu) per hour per cubic [~~feet~~] foot (207 watts per m³) of volume of the room or space in which such appliances are installed, one or more shall be provided

with venting systems or other approved means for conveying the vent gases to the outdoor atmosphere so that the aggregate input rating of the remaining unvented appliances does not exceed 20 Btu per hour per cubic foot (207 watts per m³). Where the room or space in which the appliance is installed is directly connected to another room or space by a doorway, archway, or other opening of comparable size that cannot be closed, the volume of such adjacent room or space shall be permitted to be included in the calculations.

501.9 Chimney entrance. Connectors shall connect to a masonry chimney flue at a point not less than 12 inches (~~[305]~~ 304.8 mm) or one chimney diameter above the lowest portion of the interior of the chimney flue.

501.10 Connections to exhauster. Appliance connections to a chimney or vent equipped with a power exhauster shall be made on the inlet side of the exhauster. Joints and vent systems on the positive pressure side of the exhauster shall be sealed to prevent flue-gas leakage as specified by the manufacturer's ~~[installation]~~ instructions for the exhauster or in accordance with this code.

501.11 Masonry chimneys. Masonry chimneys utilized to vent appliances shall be located, constructed and sized as specified in the manufacturer's ~~[installation]~~ instructions for the appliances being vented and Section 503.

501.12 Residential and low-heat appliances flue lining systems. Flue lining systems for use with residential-type and low-heat appliances shall be limited to the following:

1. Clay flue lining complying with the requirements of ASTM C 315 or equivalent. Clay flue lining shall be installed in accordance with the *New York City Building Code*.
2. Listed chimney lining systems complying with UL 1777 (new and existing chimneys) or ULC-S635 (existing chimneys) or ULC-S640 (new chimneys) [-].
3. Other approved materials that will resist, without cracking, softening or corrosion, flue gases and condensate at temperatures up to 1,800°F (~~[982]~~182.2°C).

501.13 Category I appliance flue lining systems. Flue lining systems for use with Category I appliances shall be limited to the following:

1. Flue lining systems complying with Section 501.12.
2. Chimney lining systems listed and labeled for use with gas appliances with draft hoods and other Category I gas appliances listed and labeled for use with Type B vents.

501.14 Category II, III and IV appliance venting systems. The design, sizing and installation of vents for Category II, III and IV appliances shall be in accordance with the appliance manufacturer's ~~[installation]~~ instructions.

501.15 Existing chimneys and vents. Where an appliance is permanently disconnected from an existing chimney or vent, or where an appliance is connected to an existing chimney or vent during the process of a new installation, the chimney or vent shall comply with Sections 501.15.1 through 501.15.4.

501.15.1 Size. The chimney or vent shall be resized as necessary to control flue gas condensation in the interior of the chimney or vent and to provide the appliance or appliances served with the required draft. For Category I appliances, the resizing shall be in accordance with Section 502.

501.15.2 Flue passageways. The flue gas passageway shall be free of obstructions and combustible deposits and shall be cleaned if previously used for venting a solid or liquid fuel-burning appliance or fireplace. The flue liner, chimney inner wall or vent inner wall shall be continuous and shall be free of cracks, gaps, perforations or other damage or deterioration [~~which~~] that would allow the escape of combustion products, including gases, moisture and creosote.

501.15.3 Cleanout. Masonry chimney flues shall be provided with a cleanout opening having a minimum height of 6 inches (~~[152]~~ 152.4 mm). The upper edge of the opening shall be located not less than 6 inches (~~[152]~~ 152.4 mm) below the lowest chimney inlet opening. The cleanout shall be provided with a tight-fitting, noncombustible cover of a minimum size of 8 inches by 8 inches (~~[203]~~ 203.2 mm by ~~[203]~~ 203.2 mm).

501.15.4 Clearances. Chimneys and vents shall have airspace clearance to combustibles in accordance with the *New York City Building Code* and the chimney or vent manufacturer's [~~installation~~] instructions.

Exception: Masonry chimneys without the required air-space clearances shall be permitted to be used if lined or relined with a chimney lining system listed for use in chimneys with reduced clearances in accordance with UL 1777 or ULC-S635. The chimney clearance shall be not less than permitted by the terms of the chimney liner listing and the manufacturer's instructions.

501.15.4.1 Fireblocking. Noncombustible fireblocking shall be provided in accordance with the *New York City Building Code*.

501.15.5 Testing. Testing of existing chimneys shall be in accordance with Section 1705.32 of the *New York City Building Code*.

501.16 Drains. A drain shall be provided for all chimneys and gas vents to remove rain water and condensation. The drain shall be [~~a minimum of~~] not less than 1 inch (~~[25]~~ 25.4 mm) in [~~size~~] diameter and shall be equipped with an appropriately-sized p-trap with automatic trap seal primer in accordance with Section 1002 of the *New York City Plumbing Code* or a float drain trap installed in accordance with the manufacturer's [~~installation~~] requirements. The drain shall be sized by the design engineer and shall be suitable for the chimney area. For listed chimneys and gas vents, the connection tap into the chimney shall be determined by the manufacturer and connected to the drain piping in accordance with the listing and [~~installation~~] instructions. On all outdoor chimneys and gas vents, the connection and drain shall be installed indoors as close as practicable to the chimney base to prevent freezing.

501.17 ~~[Thermal safety (spill) switches. Thermal safety (spill) switches shall be installed on barometric dampers, draft hoods, draft diverters, and all other appurtenances that allow dilution air into chimneys or gas vents. Thermal safety (spill) switches shall be interlocked with all of the appliances connected to the same chimney or gas vent.]~~ **Outdoor chimneys and vents.** Outdoor portions of chimneys or vents shall be provided with integral R-8 insulation or be provided with an R-8 insulation enclosure, where exposed to the outdoors for more than 5 feet (1524 mm).

501.17.1 Type B vents. Type B vents shall not be considered exposed to the outdoors in the following conditions:

1. A type B vent of a listed chimney system passing through an unused masonry chimney provided with a sealed cap that prevents airflow within the confines of the masonry chimney; or
2. A type B vent passing through an unventilated enclosure or chase insulated to R-8.

SECTION FGC 502 VENTS

502.1 General. ~~[All vents]~~ Vents, except as provided in Section 503.7, shall be listed and labeled. Type B and BW vents shall be tested in accordance with UL 441 and labeled or field fabricated in accordance with NFPA 211. Type L vents shall be tested in accordance with UL 641. Vents for Category II ~~[and]~~, III and IV appliances shall be tested in accordance with UL 1738. Plastic piping shall be listed and installed in accordance with the terms of its listing and the appliance manufacturer's instructions.

502.2 Connectors required. Connectors shall be used to connect appliances to the vertical chimney or vent, except where the chimney or vent is attached directly to the appliance. Vent connector size, material, construction and installation shall be in accordance with Section 503.

502.3 Vent application. The application of vents shall be in accordance with Table 503.4.

502.4 Insulation shield. Where vents pass through insulated assemblies, an insulation shield constructed of steel having a minimum thickness of 0.0187 inch (0.4712 mm) (No. 26 gage) shall be installed to provide clearance between the vent and the insulation material. The clearance shall be not [be] less than the clearance to combustibles specified by the vent manufacturer's ~~[installation]~~ instructions. Where vents pass through attic space, the shield shall terminate not less than 2 inches (~~[54]~~ 50.8 mm) above the insulation materials and shall be secured in place to prevent displacement. Insulation shields provided as part of a listed vent system shall be installed in accordance with the manufacturer's ~~[installation]~~ instructions.

502.5 Installation. Vent systems shall be sized, installed and terminated in accordance with the vent and appliance manufacturer's ~~[installation]~~ instructions and Section 503.

502.6 Support of vents. All portions of vents shall be adequately supported for the design and weight of the materials employed.

502.7 Protection against physical damage. In concealed locations, where a vent is installed through holes or notches in studs, joists, rafters or similar members less than 1½ inches (~~[38]~~ 38.1 mm) from the nearest edge of the member, the vent shall be protected by shield plates. Protective steel shield plates having a minimum thickness of 0.0575 inch (~~[1.463]~~ 1.461 mm) (No. 16 gage) shall cover the area of the vent where the member is notched or bored and shall extend [~~a minimum of~~] not less than 4 inches (~~[102]~~ 101.6 mm) above sole plates, below top plates and to each side of a stud, joist or rafter.

502.7.1 Door swing. Appliance and equipment vent terminals shall be located such that doors cannot swing within 12 inches (~~[305]~~ 304.8 mm) horizontally of the vent terminal. Door stops or closers shall not be installed to obtain this clearance. Means of protecting the clearance that are not easily overridden or removed may be used to obtain this clearance.

SECTION FGC 503 VENTING OF APPLIANCES

503.1 General. [~~This section recognizes that the choice of venting materials and the methods of installation of venting systems are dependent on the operating characteristics of the appliance being vented. The operating characteristics of vented appliances can be categorized with respect to (1) positive or negative pressure within the venting system; and (2) whether or not the appliance generates flue or vent gases that might condense in the venting system. See Section 202 for the definition of these vented appliance categories.~~] The venting of appliances shall be in accordance with Sections 503.2 through 503.16.

503.2 Venting systems required. Except as permitted in Sections 503.2.1 through [~~503.2.3]~~ 503.2.4 and 501.8, all appliances shall be connected to venting systems.

503.2.1 Ventilating hoods. Ventilating hoods and exhaust systems shall be permitted to be used to vent appliances installed in commercial applications [~~see~~] in accordance with Section 503.3.4 [}] and to vent industrial appliances, such as where the process itself requires fume disposal.

503.2.2 Reserved.

503.2.3 Direct-vent appliances. Listed direct-vent appliances shall be considered properly vented where installed in accordance with the terms of its listing, the manufacturer's instructions and Section 503.8.

[~~503.2.3~~] **503.2.4 Appliances with integral vents.** An appliance incorporating integral venting means shall be considered properly vented where installed in accordance with its listing, the manufacturer's instructions and Section 503.8.

503.2.5 Incinerators. Commercial-industrial-type incinerators shall be vented in accordance with NFPA 82.

503.3 Design and construction. [~~A venting system~~] Venting systems shall be designed and constructed so as to [~~develop a positive flow adequate to~~] convey all flue [~~or~~] and vent gases to the outdoors.

503.3.1 Appliance draft requirements. A venting system shall satisfy the draft requirements of the appliance in accordance with the manufacturer's instructions.

503.3.2 Design and construction. Appliances required to be vented shall be connected to a venting system designed and installed in accordance with the provisions of Sections 503.4 through 503.16.

503.3.3 Mechanical draft systems. Mechanical draft systems shall comply with the following:

1. Mechanical draft systems shall be listed and shall be installed in accordance with the terms of their listing and both the appliance and the mechanical draft system manufacturer's instructions.
2. Appliances [~~except incinerators,~~] requiring venting shall be permitted to be vented by means of mechanical draft systems of either forced or induced draft design.
3. Forced draft systems and all portions of induced draft systems under positive pressure during operation shall be designed and installed so as to prevent leakage of flue or vent gases into a building.
4. Vent connectors serving appliances vented by natural draft shall not be connected [~~into~~] to any portion of mechanical draft systems operating under positive pressure.
5. Where a mechanical draft system is employed, provisions shall be made to prevent the flow of gas to the main burners when the draft system is not performing so as to satisfy the operating requirements of the appliance for safe performance.
6. The exit terminals of mechanical draft systems shall be not less than 7 feet ([~~2134~~] 2133.6 mm) above finished ground level where located adjacent to public walkways and shall be located as specified in Section 503.8, Items 1 and 2.

503.3.4 Ventilating hoods and exhaust systems. Ventilating hoods and exhaust systems shall be permitted to be used to vent appliances installed in commercial applications. Where automatically operated appliances, other than commercial cooking appliances, are [~~is~~] vented through a ventilating hood or exhaust system equipped with a damper or with a power means of exhaust, provisions shall be made to allow the flow of gas to the main burners only when the damper is open to a position to properly vent the appliance and when the power means of exhaust is in operation.

503.3.5 Air ducts and furnace plenums. Venting systems shall not extend into or pass through any fabricated air duct or furnace plenum.

503.3.6 Above-ceiling air-handling spaces. Where a venting system passes through an above-ceiling air-handling space or other nonducted portion of an air-handling system, such space shall be accessible for inspection. The venting system shall conform to one of the following requirements:

1. The venting system shall be a listed special gas vent; other venting system serving a Category III or Category IV appliance; or other positive pressure vent, with joints sealed in accordance with the appliance or vent manufacturer's instructions.
2. The venting system shall be installed such that fittings and joints between sections are not installed in the above-ceiling space.
3. The venting system shall be installed in a sealed metal conduit or enclosure with sealed joints separating the interior of the conduit or enclosure from the ceiling space.

503.4 Type of venting system to be used. The type of venting system to be used shall be in accordance with Table 503.4.

**TABLE 503.4
TYPE OF VENTING SYSTEM TO BE USED**

GAS UTILIZATION EQUIPMENT	TYPE OF VENTING SYSTEM
Listed Category I equipment Listed equipment t equipped with draft hood Equipment listed for use with Type B gas vent	Type B gas vent (Section 503.6) Chimney (Section 503.5) Single-wall metal pipe (Section 503.7) Listed chimney lining system for gas venting (Section 503.5.3)
Listed vented wall furnaces	Type B-W gas vent (Sections 503.6, 608)
Category II equipment	As specified or furnished by manufacturers of listed equipment (Sections 503.4.1, 503.4.2)
Category III equipment	As specified or furnished by manufacturers of listed equipment (Sections 503.4.1, 503.4.2)
Category IV equipment	As specified or furnished by manufacturers of listed equipment (Sections 503.4.1, 503.4.2)
[Incinerators, indoors]	[Chimney (Section 503.5)]
Incinerators [-, outdoors]	Single wall metal pipe (Sections 503.7, 503.7.6)] <u>In accordance with NPFA 82</u>
Equipment which may be converted to use of solid fuel	Chimney (Section 503.5)
Unlisted combination gas_ and oil-burning equipment	Chimney (Section 503.5)
Listed combination gas_ and oil-burning equipment	Type L vent (Section 503.6) or chimney (Section 503.5)
Combination gas_ and solid fuel-burning equipment	Chimney (Section 503.5)
Equipment listed for use with chimneys only	Chimney (Section 503.5)
Unlisted equipment	Chimney (Section 503.5)
Decorative [appliance] <u>appliances</u> in vented [fireplace] <u>fireplaces</u>	Chimney
Direct vent equipment	See [Sections 503.2.2,] <u>Section 503.2.3</u>
Appliances with integral vent	See [Sections 503.2.3,] <u>Section 503.2.4</u>

503.4.1 Plastic piping. Plastic piping used for venting appliances listed for use with such venting materials shall be listed and installed in accordance with the terms of its listing and the manufacturers' instructions. Installation shall be in accordance with the *New York City Building Code*. PVC shall not be permitted [-].

503.4.1.1 Plastic vent joints. Plastic pipe and fittings used to vent appliances shall be installed in accordance with the appliance manufacturer's instructions. Where a primer is required, it shall be of a contrasting color.

503.4.2 Special gas vent. Special gas vent shall be listed and installed in accordance with the terms of the special gas vent listing and the manufacturers' instructions.

503.4.2.1 Inspection of special gas vents. Before replacing an existing appliance or connecting a vent connector to a special gas vent, the special gas vent shall be examined to ascertain that it is clear and free of obstructions.

503.4.2.2 Unsafe special gas vents. Where inspection reveals that an existing special gas vent is not safe for the intended application, it shall be repaired or replaced.

503.4.2.3 Test run. All special gas vents shall be test run by the registered design professional or special inspector responsible for the testing under operating conditions to demonstrate fire safety and the complete exhausting of smoke and the products of combustion to the outer air. The results of such test run shall be certified as correct by the registered design professional or special inspector responsible for the test and shall be submitted in writing to the department.

503.4.2.4 Requirement of a smoke test. A smoke test shall be conducted in accordance with Section 503.4.2.5. Any faults or leaks found shall be corrected. Such smoke test shall be witnessed by a representative of the commissioner. In the alternative, the commissioner may accept a test report instead of requiring that it be witnessed by a representative of the commissioner. Such test report of the registered design professional or special inspector responsible for the test which shall be submitted in writing to the department.

503.4.2.5 Smoke test. To determine the tightness of vent construction, a smoke test shall be conducted in accordance with the following conditions and requirements:

- 1. The equipment, materials, power and labor necessary for such test shall be furnished by, and at the expense of, either the owner or holder of the work permit**
:
- 2. If the test shows any evidence of leakage or other defects, such leakage or other defects shall be corrected in accordance with the requirements of this chapter, and the test shall be repeated until the results are satisfactory.**
- 3. The vent shall be filled with a thick penetrating smoke produced by one or more smoke machines, or smoke bombs, or other equivalent method. As the smoke appears at the stack opening on the roof, such opening shall be tightly closed and a pressure equivalent to ½ inch (12.7 mm) column of water measured at the base**

of the special gas vent shall be applied. The test shall be applied for a length of time sufficient to permit the inspection of the special gas vent.

4. Testing and inspection of existing and new negative pressure chimneys and vents shall be in accordance with Section 1705.32 of the *New York City Building Code*.

503.5 Masonry, metal, and factory-built chimneys. Masonry, metal and factory-built chimneys shall comply with Sections 503.5.1 through 503.5.10.

503.5.1 Factory-built chimneys. Factory-built chimneys shall be installed in accordance with their listing and the manufacturer's instructions. Factory-built chimneys used to vent appliances that operate at positive vent pressure shall be listed for such application.

503.5.2 Metal chimneys. Metal chimneys shall be built and installed in accordance with NFPA 211.

503.5.3 Masonry chimneys. Masonry chimneys shall be built and installed in accordance with Chapter 21 of the *New York City Building Code* and NFPA 211 and shall be lined with approved clay flue lining, a listed chimney lining system or other approved material that will resist corrosion, erosion, softening or cracking from vent gases at temperatures up to 1,800°F ([982]982.2°C).

Exception: Masonry chimney flues serving listed gas appliances with draft hoods, Category I appliances and other gas appliances listed for use with Type B ~~[vent]~~ vents shall be permitted to be lined with a chimney lining system specifically listed for use only with such appliances. The liner shall be installed in accordance with the liner manufacturer's instructions and the terms of the listing. A permanent identifying label shall be attached at the point where the connection is to be made to the liner. The label shall read: "This chimney liner is for appliances that burn gas only. Do not connect to solid or liquid fuel-burning appliances or incinerators."

For ~~[information on]~~ installation of gas vents in existing masonry chimneys, see Section 503.6.3.

503.5.4 Chimney termination. Chimneys serving gas-fired equipment shall comply with the appliance listing, the manufacturer's instructions, Figure 503.5.4 and the following requirements:

1. Chimneys, vents and flues serving appliances or fireplaces with outlet temperatures less than 600°F ([316]315.6 °C) shall extend ~~[at least]~~ not less than 3 feet ([914] 914.4 mm) above the highest construction, such as a roof ridge, parapet wall, or penthouse ~~[]~~ within 10 feet (3048 mm) of the chimney, vent or flue outlet, whether the construction is on the same building as the chimney or on another building. However, such constructions do not include other chimneys, vents, or open structural framing. Any ~~[chimney]~~ chimneys, vents or flues located beyond 10 feet (3048 mm) from such construction, but not more than the distance determined by Equation 5-1₂, shall be at least as high as the construction.

2. Chimneys serving appliances or fireplaces with outlet temperatures between 600°F ([316]315.6°C) and 1000°F ([538]537.8°C) shall extend ~~[at least]~~ not less than 10 feet (3048 mm) above the highest construction, such as a roof ridge, or parapet wall or penthouse within 20 feet (6096 mm) of the chimney outlet, whether the construction is on the same building as the chimney or on another building. However, such constructions do not include other chimneys, and vents or open structural framing. Any ~~[chimney]~~ chimneys located beyond 20 feet (6096 mm) from such construction, but not more than the distance determined by Equation 5-1, shall be at least as high as the construction.
3. Chimneys serving appliances or fireplaces with outlet temperatures greater than 1000°F ([538]537.8°C) shall extend ~~[at least]~~ not less than 20 feet (6096 mm) above the highest construction, such as roof ridge, parapet wall, penthouse, or other obstruction within 50 feet (15 240 mm) of the chimney outlet, whether the construction is on the same building as the chimney or in another building. However, such constructions do not include other chimneys, vents, or open structural framing. Any ~~[chimney]~~ chimneys located beyond 50 feet (15 240 mm) from such construction, but not more than the distance determined by Equation 5-1, shall be at least as high as the construction.
4. Termination caps shall not be permitted. A drain shall be installed in accordance with Section ~~[801.21]~~ 801.22 of the *New York City Mechanical Code*. A positive means shall be provided to prevent water from entering the appliance.

Exception: Termination caps shall be permitted on listed factory-built chimneys unless otherwise prohibited by the *New York City Air Pollution Control Code*.
5. Decorative shrouds shall not be installed at the termination of factory-built chimneys except where such shrouds are listed and labeled for use with the specific factory-built chimney system and are installed in accordance with the manufacturers' ~~[installation]~~ instructions.
6. The following equation shall be used for determining the distances referred to in Items 1, 2 and 3 of this section.

$$D = F \times \sqrt{A} \qquad \text{(Equation 5-1)}$$

where:

D = Distance, in feet, measured from the center of the chimney, vent or flue outlet to the nearest edge of the construction. If a single chimney is divided into multiple smaller flues or chimneys, measure from the center of the chimney outlet that is closest to the nearest edge of the construction.

F = Value determined from table below.

A = Free area, in square inches, of chimney flue space outlet. If a single chimney is divided into multiple smaller flues or chimneys, the total aggregate free area of such flue and chimney outlets shall be used to calculate "A".

"F" FACTOR FOR DETERMINING CHIMNEY DISTANCES			
Type of Fuel	"F" Factor		
	600°F ([316]315.6°C) and less	600°F ([316]315.6°C) to 1000°F ([538]537.8°C)	Greater than 1000°F ([538]537.8°C)
Gas	2	2	3

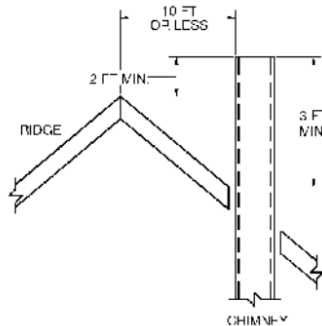
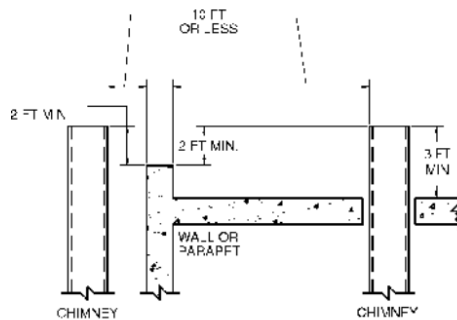

A. TERMINATION 10 FT OR LESS FROM RIDGE, WALL, OR PARAPET

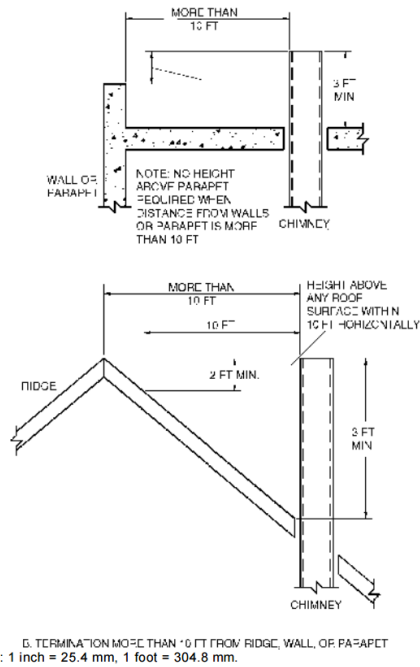

FIGURE 503.5.4
TYPICAL TERMINATION LOCATIONS FOR CHIMNEYS AND
SINGLE-WALL METAL PIPES SERVING RESIDENTIAL-TYPE
AND LOW-HEAT APPLIANCES

503.5.5 Size of chimneys. The effective area of a chimney venting system serving listed appliances with draft hoods, Category I appliances, and other appliances listed for use with Type B vents shall be determined in accordance with one of the following methods:

1. The provisions of Section 504.
2. For sizing an individual chimney venting system for a single appliance with a draft hood, the effective areas of the vent connector and chimney flue shall be not less than the area of the appliance flue collar or draft hood outlet, nor greater than seven times the draft hood outlet area.
3. For sizing a chimney venting system connected to two appliances with draft hoods, the effective area of the chimney flue shall be not less than the area of the larger draft hood outlet plus 50 percent of the area of the smaller draft hood outlet, nor greater than seven times the smallest draft hood outlet area.
4. Chimney venting systems using mechanical draft shall be sized in accordance with approved engineering methods.
5. Other approved engineering methods.

503.5.6 Inspection of chimneys. Before replacing an existing appliance or connecting a vent connector to a chimney, the chimney passageway shall be examined to ascertain that it is clear

and free of obstructions and it shall be cleaned if previously used for venting solid or liquid fuel-burning appliances or fireplaces.

503.5.6.1 Chimney lining. Chimneys shall be lined in accordance with NFPA 211.

Exception: Where an existing chimney complies with Sections 503.5.6 through 503.5.6.5 and its sizing is in accordance with Section 503.5.5, its continued use shall be allowed where the appliance vented by such chimney is replaced by an appliance of similar type, input rating and efficiency.

503.5.6.2 Cleanouts. Cleanouts shall be examined to determine if they will remain tightly closed when not in use.

503.5.6.3 Unsafe chimneys. Where inspection reveals that an existing chimney is not safe for the intended application, it shall be repaired, rebuilt, lined, relined [] or replaced with a vent or chimney to conform to NFPA 211 and it shall be suitable for the appliances to be vented.

503.5.6.4 Test run. All new chimneys shall be test run by the registered design professional responsible for the testing under operating conditions to demonstrate fire safety and the complete exhausting of smoke and the products of combustion to the outer air. The results of such test run shall be certified as correct by the registered design professional responsible for the test and shall be submitted in writing to the department.

503.5.6.5 Requirement of a smoke test. A smoke test shall be made as outlined below. Any faults or leaks found shall be corrected. Such smoke test shall be witnessed by a representative of the commissioner. In lieu thereof, the commissioner may accept the test report of the registered design professional or special inspector responsible for the test [which] that shall be submitted in writing to the department.

503.5.6.5.1 Smoke test. To determine the tightness of chimney construction, a smoke test shall be made in accordance with the following conditions and requirements:

1. The equipment, materials, power and labor necessary for such test shall be furnished by, and at the expense of, the owner or holder of the work permit.
2. If the test shows any evidence of leakage or other defects, such defects shall be corrected in accordance with the requirement of this chapter and the test shall be repeated until the results are satisfactory.
3. Method of test. The chimney shall be filled with a thick penetrating smoke produced by one or more smoke machines, or smoke bombs, or other equivalent method. As the smoke appears at the stack opening on the roof, such opening shall be tightly closed and a pressure equivalent to ½ inch (12.7 mm) column of water measured at the base of the stack, shall be applied. The test shall be applied for a length of time sufficient to permit the inspection of the chimney.

503.5.7 Chimneys serving appliances burning other fuels. Chimneys serving appliances burning other fuels shall comply with Sections 503.5.7.1 through 503.5.7.4.

503.5.7.1 Solid fuel-burning appliances. An appliance shall not be connected to a chimney flue serving a separate appliance designed to burn solid fuel.

503.5.7.2 Liquid fuel-burning appliances. Where one chimney flue serves gas appliances and liquid fuel-burning appliances, the appliances shall be connected through separate openings or shall be connected through a single opening where joined by a suitable fitting located as close as practical to the chimney. Where two or more openings are provided into one chimney flue, they shall be at different levels. Where the appliances are automatically controlled, they shall be equipped with safety shutoff devices.

503.5.7.3 Combination [gas] gas- and solid fuel-burning appliances. A combination gas- and solid fuel-burning appliance shall be permitted to be connected to a single chimney flue where equipped with a manual reset device to shut off gas to the main burner in the event of sustained back draft or flue gas spillage. The chimney flue shall be sized to properly vent the appliance.

503.5.7.4 Combination gas- and oil fuel-burning appliances. A listed combination gas- and oil fuel-burning appliance shall be permitted to be connected to a single chimney flue. The chimney flue shall be sized to properly vent the appliance.

503.5.8 Support of chimneys. All portions of chimneys shall be supported for the design and weight of the materials employed. Factory-built chimneys shall be supported and spaced in accordance with their listings and the manufacturer's instructions.

503.5.9 Cleanouts. Where a chimney that formerly carried flue products from liquid or solid fuel-burning appliances is used with an appliance using fuel gas, an accessible cleanout shall be provided. The cleanout shall have a tight-fitting cover and shall be installed at the base of all chimneys in accordance with the rules of the *New York City Department of Environmental Protection*. The cleanout shall be gas tight if the chimney is to be of positive pressure.

503.5.10 Space surrounding lining or vent. The remaining space surrounding a chimney liner, gas vent, special gas vent [7] or plastic piping installed within a masonry chimney flue shall not be used to vent another appliance. The insertion of another liner or vent within the chimney as provided in this code and the liner or vent manufacturer's instructions shall not be prohibited.

The remaining space surrounding a chimney liner, gas vent, special gas vent [7] or plastic piping installed within a masonry, metal or factory-built chimney, shall not be used to supply combustion air. Such space shall not be prohibited from supplying combustion air to direct-vent appliances designed for installation in a solid fuel-burning fireplace and installed in accordance with the listing and the manufacturer's instructions.

503.6 Gas vents. Gas vents shall comply with Sections 503.6.1 through 503.6.13 (see Section 202, Definitions).

503.6.1 Installation, general. Gas vents shall be installed in accordance with the terms of their listings and manufacturer's instructions.

503.6.2 Type B-W vent capacity. A Type B-W gas vent shall have a listed capacity not less than that of the listed vented wall furnace to which it is connected.

503.6.3 Gas vents installed within masonry chimneys. Gas vents installed within masonry chimneys shall be installed in accordance with the terms of their listing and the manufacturer's [installation] instructions. Gas vents installed within masonry chimneys shall be identified with a permanent label installed at the point where the vent enters the chimney. The label shall contain the following language: "This gas vent is for appliances that burn gas. Do not connect to solid or liquid fuel-burning appliances or incinerators."

503.6.4 Gas vent terminations. A gas vent shall terminate in accordance with one of the following:

1. Gas vents that are 12 inches (~~[305]~~ 304.8 mm) or less in size and located not less than 8 feet (~~[2438]~~ 2438.4 mm) from a vertical wall or similar obstruction shall terminate above the roof in accordance with Figure ~~[503.6.6]~~ 503.6.4.
2. Gas vents that are over 12 inches (~~[305]~~ 304.8 mm) in size or are located less than 8 feet (~~[2438]~~ 2438.4 mm) from a vertical wall or similar obstruction shall terminate not less than 2 feet (~~[610]~~ 609.6 mm) above the highest point where they pass through the roof and not less than 2 feet (~~[610]~~ 609.6 mm) above any portion of a building within 10 feet (3048 mm) horizontally.
3. As provided for direct-vent systems in Section ~~[503.2.2]~~ 503.2.3.
4. As provided for appliances with integral vents in Section ~~[503.2.3]~~ 503.2.4.
5. As provided for mechanical draft systems in Section 503.3.3.
6. As provided for ventilating hoods and exhaust systems in Section 503.3.4.

However, such constructions do not include chimneys or other vents, or open structural framing. The vent shall be as high as such construction which is located beyond 10 feet (3048 mm) from the vent and up to and including the distance determined by the following formula:

$$D = 2\sqrt{A} \qquad \text{(Equation 5-2)}$$

where:

D = Distance, in feet, measured from the center of the vent outlet to the nearest edge of the construction.

A = Free area, in square inches, of vent flue space.

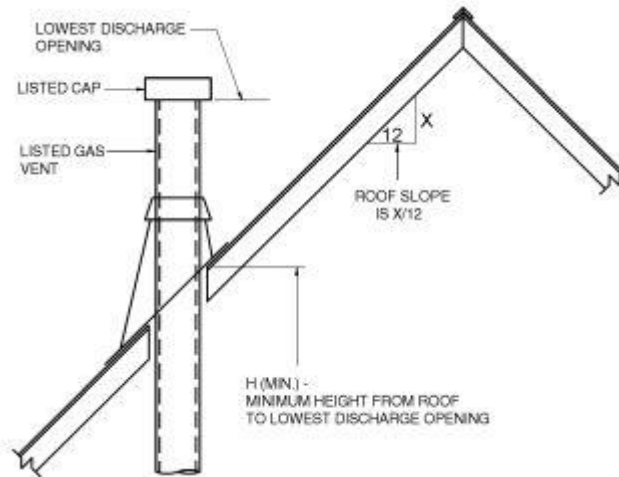

ROOF PITCH	H (min) ft
Flat to 6/12	1.0
Over 6/12 to 7/12	1.25
Over 7/12 to 8/12	1.5
Over 8/12 to 9/12	2.0
Over 9/12 to 10/12	2.5
Over 10/12 to 11/12	3.25
Over 11/12 to 12/12	4.0
Over 12/12 to 14/12	5.0
Over 14/12 to 16/12	6.0
Over 16/12 to 18/12	7.0
Over 18/12 to 20/12	7.5
Over 20/12 to 21/12	8.0

For SI: 1 inch = 25.4 mm, 1 foot = 304.8 mm.

FIGURE 503.6.4
TERMINATION LOCATIONS FOR GAS VENTS WITH
LISTED CAPS 12 INCHES OR LESS IN SIZE AT
LEAST 8 FEET FROM A VERTICAL WALL

503.6.4.1 Decorative shrouds. Decorative shrouds shall not be installed at the termination of gas vents except where such shrouds are listed for use with the specific gas venting system and are installed in accordance with the manufacturer's [installation] instructions.

All gas vents shall terminate in an approved vent or cowl, which shall prevent downdrafts and prevent rain and debris from entering the vent.

503.6.5 Minimum height. A Type B or L gas vent shall terminate [at least] not less than 5 feet (1524 mm) in vertical height above the highest connected [equipment] appliance draft hood or flue collar. A Type B-W gas vent shall terminate [at least] not less than 12 feet ([3658] 3657.6 mm) in vertical height above the bottom of the wall furnace.

503.6.6 Roof terminations. Gas vents shall extend through the roof flashing, roof jack or roof thimble and terminate with a listed cap or listed roof assembly.

503.6.7 Forced air inlets. Gas vents shall terminate not less than 3 feet ([914] 914.4 mm) above any forced air inlet located within 10 feet (3048 mm).

503.6.8 Exterior wall penetrations. A gas vent extending through an exterior wall shall not terminate adjacent to the wall or below eaves or parapets, except as provided in Sections [~~503.2.3~~] 503.2.4 and 503.3.3.

503.6.9 Size of gas vents. Venting systems shall be sized and constructed in accordance with Section 504 or other approved engineering methods acceptable to the commissioner. Gas vents shall also comply with the manufacturers' instructions.

503.6.9.1 Category I appliances. The sizing of natural draft venting systems serving one or more listed appliances equipped with a draft hood or appliances listed for use with Type B gas vent, installed in a single story of a building, shall be in accordance with one of the following methods:

1. The provisions of Section 504.
2. For sizing an individual gas vent for a single, draft-hood-equipped appliance, the effective area of the vent connector and the gas vent shall be not less than the area of the appliance draft hood outlet, nor greater than seven times the draft hood outlet area.
3. For sizing a gas vent connected to two appliances with draft hoods, the effective area of the vent shall be not less than the area of the larger draft hood outlet plus 50 percent of the area of the smaller draft hood outlet, nor greater than seven times the smaller draft hood outlet area.
4. Engineering practices acceptable to the commissioner.

503.6.9.2 Vent offsets. Type B and L vents sized in accordance with Item 2 or 3 of Section 503.6.9.1 shall extend in a generally vertical direction with offsets not exceeding 45 degrees (0.79 rad), except that a vent system having not more than one 60-degree (1.04 rad) offset shall be permitted. Any angle greater than 45 degrees (0.79 rad) from the vertical is considered horizontal. The total horizontal distance of a vent plus the horizontal vent connector serving [~~draft hood-equipped~~] draft-hood-equipped appliances shall be not greater than 75 percent of the vertical height of the vent.

503.6.9.3 Category II, III, and IV appliances. The sizing of gas vents or plastic pipe specified by the appliance manufacturer for Category II, III, and IV appliances shall be in accordance with the appliance manufacturer's instructions.

503.6.9.4 Mechanical draft. Chimney venting systems using mechanical draft shall be designed and sized to develop a positive flow adequate to carry all products of combustion to the outside atmosphere.

503.6.10 Multistory prohibited. Common venting systems for appliances located on more than one floor level shall be prohibited.

503.6.11 Support of gas vents. Gas vents shall be supported and spaced in accordance with their listings and the manufacturer's instructions.

503.6.12 Marking. Gas vents shall be permanently identified by a label attached to the wall or ceiling at a point where the vent connector enters the gas vent. The label shall read:

“This gas vent is for appliances that burn gas. Do not connect to solid or liquid fuel- burning appliances or incinerators.”

503.6.13 Fastener penetrations. Screws, rivets and other fasteners shall not penetrate the inner wall of double-wall gas vents, except at the transition from an appliance draft hood outlet, a flue collar or a single-wall metal connector to a double-wall vent.

503.7 Single-wall metal pipe. Single-wall metal pipe vents shall comply with Sections 503.7.1 through 503.7.13.

503.7.1 Construction. Single-wall metal pipe shall be constructed of galvanized sheet steel not less than 0.0304 inch (~~[0.7]~~ 0.77 mm) thick, or other approved, noncombustible, corrosion-resistant material.

503.7.2 Climate protection. Uninsulated single-wall metal pipe shall not be used outdoors for venting appliances.

503.7.3 Termination. Single-wall metal pipe shall terminate at least 5 feet (1524 mm) in vertical height above the highest connected appliance draft hood outlet or flue collar. Single-wall metal pipe shall extend [~~at least~~] not less than 2 feet (~~[610]~~ 609.6 mm) above the highest point where it passes through a roof of a building and [~~at least~~] not less than 2 feet (~~[610]~~ 609.6 mm) higher than any portion of a building within a horizontal distance of 10 feet (3048 mm) (see Figure 503.5.4). An approved cap or roof assembly shall be attached to the terminus of a single-wall metal pipe (see also Section 503.7.9, Item 3). However, such constructions do not include chimneys or other vents, or open structural framing. The single-wall metal pipe shall be as high as such construction which is located beyond 10 feet (3048 mm) from the vent and up to and including the distance determined by Equation 5-2.

503.7.4 Limitations of use. Single-wall metal pipe shall be used only for runs directly from the space in which the appliance is located through the roof or exterior wall to the outdoor atmosphere.

503.7.5 Roof penetrations. A pipe passing through a roof shall extend without interruption through the roof flashing, roof jack, or roof thimble. Where a single-wall metal pipe passes through a roof constructed of combustible material, a noncombustible, non-ventilating thimble

shall be used at the point of passage. The thimble shall extend [~~at least~~] not less than 18 inches ([457] 457.2 mm) above and 6 inches ([152] 152.4 mm) below the roof with the annular space open at the bottom and closed only at the top. The thimble shall be sized in accordance with Section 503.7.7.

503.7.6 Installation. Single-wall metal pipe shall not originate in any unoccupied attic or concealed space and shall not pass through any attic, inside wall, concealed space, or floor. The installation of a single-wall metal pipe through an exterior combustible wall shall comply with Section 503.7.7. [~~Single-wall metal pipe used for venting an incinerator shall be exposed and readily examinable for its full length and shall have suitable clearances maintained.~~]

503.7.7 Single-wall penetrations of combustible walls. A single-wall metal pipe shall not pass through a combustible exterior wall unless guarded at the point of passage by a ventilated metal thimble not smaller than the following:

1. For listed appliances [~~equipped~~] with draft hoods and appliances listed for use with Type B gas vents, the thimble shall be not [~~be~~] less than 4 inches ([402] 101.6 mm) larger in diameter than the metal pipe. Where there is a run of not less than 6 feet ([1829] 1828.8 mm) of metal pipe in the open between the draft hood outlet and the thimble, the thimble shall be permitted to be not less than 2 inches ([54] 50.8 mm) larger in diameter than the metal pipe.
2. For unlisted appliances having draft hoods, the thimble shall be not less than 6 inches ([152] 152.4 mm) larger in diameter than the metal pipe.
3. For residential and low-heat appliances, the thimble shall be not less than 12 inches ([305] 304.8 mm) larger in diameter than the metal pipe.

Exception: In lieu of thimble protection, all combustible material in the wall shall be removed a sufficient distance from the metal pipe to provide the specified clearance from such metal pipe to combustible material. Any material used to close up such opening shall be noncombustible.

503.7.8 Clearances. Minimum clearances from single-wall metal pipe to combustible material shall be in accordance with Table 503.10.5. The clearance from single-wall metal pipe to combustible material shall be permitted to be reduced where the combustible material is protected as specified for vent connectors in Table 308.2.

503.7.9 Size of single-wall metal pipe. A venting system constructed of single-wall metal pipe shall be sized in accordance with one of the following methods and the appliance manufacturer's instructions:

1. For a draft-hood-equipped appliance, in accordance with Section 504.
2. For a venting system for a single appliance with a draft hood, the areas of the connector and the pipe each shall be not less than the area of the appliance flue collar or draft hood outlet, whichever is smaller. The vent area shall be not [~~be~~] greater than seven times the draft hood outlet area.

3. Other approved engineering methods.

503.7.10 Pipe geometry. Any shaped single-wall metal pipe shall be permitted to be used, provided that its equivalent effective area is equal to the effective area of the round pipe for which it is substituted, and provided that the minimum internal dimension of the pipe is not less than 2 inches ([54] 50.8 mm).

503.7.11 Termination capacity. The vent cap or a roof assembly shall have a venting capacity of not less than that of the pipe to which it is attached.

503.7.12 Support of single-wall metal pipe. All portions of single-wall metal pipe shall be supported for the design and weight of the material employed.

503.7.13 Marking. Single-wall metal pipe shall comply with the marking provisions of Section 503.6.12.

503.8 Venting system termination location. The location of venting system terminations shall comply with the following:

1. Gas venting systems shall be extended at least 3 feet ([914] 914.4 mm) above the highest construction, such as a roof ridge, parapet wall, or penthouse, within 10 feet (3048 mm) of the vent outlet whether the construction is on the same building as the chimney or on another building. However, such constructions do not include chimneys or other vents, or open structural framing. The vent shall be as high as such construction which is located beyond 10 feet (3048 mm) from the vent and up to and including the distance determined by Equation 5-2.

Exception: [~~Direct vent~~] Horizontally terminated direct-vent appliances and integral vent appliances approved by the commissioner and installed in accordance with the manufacturer's instructions and Section 503.8, Item 3.

2. Where permitted, through-the-wall vents for Category I, II, III and IV appliances and noncategorized condensing appliances shall not terminate over public walkways or over an area where condensate or vapor could create a nuisance or hazard or could be detrimental to the operation of regulators, relief valves or other equipment.
3. Horizontal terminations shall only be allowed if they are in a nonhazardous location and if the appliance has a sealed combustion chamber (direct vent) or integral vent in accordance with the appliance listing and manufacturer's instructions. In addition, horizontal terminations shall comply with the following requirements:
 - 3.1. Where located adjacent to walkways, the termination shall be not less than 7 feet ([2434] 2133.6 mm) above the level of the walkway.

- 3.2. Vents shall terminate at least 3 feet (~~[914]~~ 914.4 mm) above any forced air inlet, other than the forced air inlet for the subject direct vent or integral vent appliance, located within 10 feet (3048 mm).
- 3.3. The vent system shall terminate at least 4 feet (~~[1219]~~ 1219.2 mm) below, 4 feet (~~[1219]~~ 1219.2 mm) horizontally from or 1 foot (~~[305]~~ 304.8 mm) above any door, window or gravity air inlet into the building.
- 3.4. The vent termination point shall not be located closer than 3 feet (~~[914]~~ 914.4 mm) to an interior corner formed by two walls perpendicular to each other.
- 3.5. The vent termination shall not be mounted directly above or within 3 feet (~~[914]~~ 914.4 mm) horizontally from any gas or electric metering, regulating, venting relief equipment or other building opening.
- 3.6. The bottom of the vent termination shall be located at least 24 inches (~~[610]~~ 609.6 mm) above finished grade.
- 3.7. The maximum heat input of an appliance served by single horizontal vent termination shall be 350,000 Btu/h (~~[1025]~~ 102.6 kW), unless otherwise approved by the ~~[Commissioner]~~ commissioner.
- 3.8. The maximum heat input of all appliances served by horizontal vent terminations located within a 10 ~~[feet]~~ feet (3048 mm) radius shall be 350,000 Btu/h (~~[1025]~~ 102.6 kW), unless otherwise approved by the commissioner.
- 3.9. The vent termination shall be located a minimum of 4 feet (1219.2 mm) from the lot line or from adjacent buildings. The termination shall be installed in accordance with the gas vent manufacturer's listing and ~~[installation]~~ instructions.

503.9 Condensation drainage. Provisions shall be made to collect and dispose of condensate from venting systems serving Category II and IV appliances and noncategorized condensing appliances in accordance with Section 307.

503.10 Vent connectors for Category I appliances. Vent connectors for Category I appliances shall comply with Sections 503.10.1 through ~~[503.10.15]~~ 503.10.14.

503.10.1 Where required. A vent connector shall be used to connect an appliance to a gas vent, chimney, or single-wall metal pipe, except where the gas vent, chimney, or single-wall metal pipe is directly connected to the appliance.

503.10.2 Materials. Vent connectors shall be constructed in accordance with Sections 503.10.2.1 through 503.10.2.5.

503.10.2.1 General. A vent connector shall be made of noncombustible corrosion-resistant material capable of withstanding the vent gas temperature produced by the appliance and of sufficient thickness to withstand physical damage.

503.10.2.2 Vent connectors located in unconditioned areas. Where the vent connector used for an appliance having a draft hood or a Category I appliance is located in or passes through attics, crawl spaces or other unconditioned spaces, that portion of the vent connector shall be listed Type B ~~[or]~~, Type L or listed vent material having equivalent insulation properties.

503.10.2.3 Residential-type appliance connectors. Where vent connectors for residential-type appliances are not installed in attics or other unconditioned spaces, connectors for listed appliances having draft hoods, appliances having draft hoods and equipped with listed conversion burners and Category I appliances shall be one of the following:

1. Type B or Type L vent material ~~[or]~~.
2. Galvanized sheet steel not less than 0.018 inch (0.46 mm) thick ~~[or]~~.
3. Aluminum (1100 or 3003 alloy or equivalent) sheet not less than 0.027 inch (0.69 mm) thick ~~[or]~~.
4. Stainless steel sheet not less than 0.012 inch (0.31 mm) thick ~~[or]~~.
5. Smooth interior wall metal pipe having resistance to heat and corrosion equal to or greater than that of Item 2, 3 or 4 ~~[above; or]~~.
6. A listed vent connector.

Vent connectors shall not be covered with insulation.

Exception: Listed insulated vent connectors shall be installed according to the terms of their listing ~~[and]~~, the manufacturer's ~~[installation]~~ instructions and Section 803.10.4 of the *New York City Mechanical Code*.

503.10.2.4 Low-heat equipment. A vent connector for a nonresidential, low-heat ~~[equipment]~~ appliance shall be a factory-built chimney section or steel pipe having resistance to heat and corrosion equivalent to that for the appropriate galvanized pipe as specified in Table 503.10.2.4. Factory-built chimney sections shall be joined together in accordance with the chimney manufacturer's instructions.

**TABLE 503.10.2.4
MINIMUM THICKNESS FOR GALVANIZED STEEL VENT
CONNECTORS FOR LOW-HEAT APPLIANCES**

DIAMETER OF CONNECTOR (inches)	MINIMUM THICKNESS (inch)
Less than 6	0.019
6 to less than 10	0.023

DIAMETER OF CONNECTOR (inches)	MINIMUM THICKNESS (inch)
10 to 12 inclusive	0.029
14 to 16 inclusive	0.034
Over 16	0.056

For SI: 1 inch = 25.4 mm.

503.10.2.5 Medium-heat appliances. Vent connectors for medium-heat appliances [~~and commercial and industrial incinerators~~] shall be constructed of factory-built medium-heat chimney sections or steel of a thickness not less than that specified in Table 503.10.2.5 and shall comply with the following:

1. A steel vent connector for an appliance with a vent gas temperature in excess of 1000°F ([~~538~~] 537.8°C) [∓] measured at the entrance to the connector shall be lined with medium-duty fire brick (ASTM C 64, Type F), or the equivalent.
2. The lining shall be [~~at least~~] not less than 2½ inches ([~~64~~] 63.5 mm) thick for a vent connector having a diameter or greatest cross-sectional dimension of 18 inches ([~~457~~] 457.2 mm) or less [∓]
3. The lining shall be [~~at least~~] not less than 4½ inches ([~~114~~] 114.3 mm) thick laid on the 4½-inch ([~~114~~] 114.3 mm) bed for a vent connector having a diameter or greatest cross-sectional dimension greater than 18 inches ([~~457~~] 457.2 mm).
4. Factory-built chimney sections, if employed, shall be joined together in accordance with the chimney manufacturer's instructions.

**TABLE 503.10.2.5
MINIMUM THICKNESS FOR STEEL VENT CONNECTORS FOR
MEDIUM-HEAT APPLIANCES [~~AND COMMERCIAL AND
INDUSTRIAL INCINERATORS VENT CONNECTOR SIZE~~]**

<u>VENT CONNECTOR SIZE</u>		
DIAMETER (inches)	AREA (square inches)	MINIMUM THICKNESS
Up to 14	Up to 154	0.053
Over 14 to 16	154 to 201	0.067
Over 16 to 18	201 to 254	0.093
Over 18	Larger than 254	0.123

For SI: 1 inch = 25.4 mm, 1 square inch = 645.16 mm².

503.10.3 Size of vent connector. Vent connectors shall be sized in accordance with Sections 503.10.3.1 through 503.10.3.5.

503.10.3.1 Single draft hood and fan-assisted. A vent connector for an appliance with a single draft hood or for a Category I fan-assisted combustion system appliance shall be sized and installed in accordance with Section 504 or other approved engineering methods.

503.10.3.2 Multiple draft hoods. For a single appliance having more than one draft hood outlet or flue collar, the manifold shall be constructed according to the instructions of the appliance manufacturer. Where there are no instructions, the manifold shall be designed and constructed in accordance with approved engineering practices. As an alternate method, the effective area of the manifold shall equal the combined area of the flue collars or draft hood outlets and the vent connectors shall have a minimum 1-foot (~~[305]~~ 304.8 mm) rise.

503.10.3.3 Multiple appliances. Where two or more appliances are connected to a common vent or chimney, each vent connector shall be sized in accordance with Section 504 or other approved engineering methods.

As an alternative method applicable only when all of the appliances are draft hood equipped, each vent connector shall have an effective area not less than the area of the draft hood outlet of the appliance to which it is connected.

503.10.3.4 Common connector/manifold. Where two or more appliances are vented through a common vent connector or vent manifold, the common vent connector or vent manifold shall be located at the highest level consistent with available headroom and the required clearance to combustible materials and shall be sized in accordance with Section 504 or other approved engineering methods.

As an alternate method applicable only where there are two draft ~~[hood-equipped]~~ hood-equipped appliances, the effective area of the common vent connector or vent manifold and all junction fittings shall be not less than the area of the larger vent connector plus 50 percent of the area of the smaller flue collar outlet.

503.10.3.5 Size increase. Where the size of a vent connector is increased to overcome installation limitations and obtain connector capacity equal to the appliance input, the size increase shall be made at the appliance draft hood outlet.

503.10.4 Two or more appliances connected to a single vent or chimney. Where two or more vent connectors enter a common gas vent, chimney flue [~~]~~ or single-wall metal pipe, the smaller connector shall enter at the highest level consistent with the available headroom or clearance to combustible material. Vent connectors serving Category I appliances shall not be connected to any portion of a mechanical draft system operating under positive static pressure, such as those serving Category III or IV appliances.

503.10.4.1 Two or more openings. Where two or more openings are provided into one chimney flue or vent, the openings shall be at different levels, or the connectors shall be attached to the vertical portion of the chimney or vent at an angle of 45 degrees (0.79 rad) or less relative to the vertical in accordance with Figure 503.10.4.1.

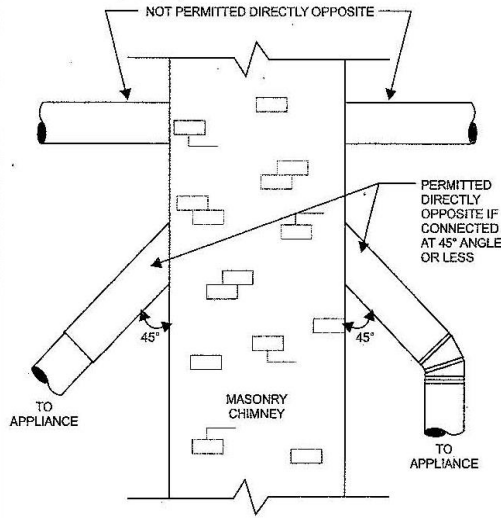

**FIGURE 503.10.4.1
OPPOSING OPENINGS IN CHIMNEY**

503.10.5 Clearance. Minimum clearances from vent connectors to combustible material shall be in accordance with Table 503.10.5.

Exception: The clearance between a vent connector and combustible material shall be permitted to be reduced where the combustible material is protected as specified for vent connectors in Table 308.2.

**TABLE 503.10.5^a
CLEARANCES FOR CONNECTORS**

APPLIANCE	MINIMUM DISTANCE FROM COMBUSTIBLE MATERIAL			
	Listed Type B gas vent material	Listed Type L vent material	Single-wall metal pipe	Factory-built chimney sections
Listed appliances with draft hoods and appliances listed for use with Type B gas vents	As listed	As listed	6 inches	As listed
Residential boilers and furnaces with listed gas conversion burner and with draft hood	6 inches	6 inches	9 inches	As listed
Residential appliances listed for use with Type L vents	Not permitted	As listed	9 inches	As listed
Listed gas-fired toilets	Not permitted	As listed	As listed	As listed
Unlisted residential appliances with draft hood	Not permitted	6 inches	9 inches	As listed
Residential and low-heat appliances other than above	Not permitted	9 inches	18 inches	As listed
Medium-heat appliances	Not permitted	Not permitted	36 inches	As listed

For SI: 1 inch = 25.4 mm.

- a. These clearances shall apply unless the manufacturer's installation instructions for a listed appliance or connector specify different clearances, in which case the listed clearances shall apply.

503.10.6 ~~[Flow resistance. A vent connector shall be installed so as to avoid turns or other construction features that create excessive resistance to flow of vent gases.]~~

[503.10.7] Joints. Joints between sections of connector [~~pip~~ing] and connections to flue collars and draft hood outlets shall be tight-fitting and fastened by one of the following methods

1. [~~Sheet metal screws.~~] Galvanized steel – Overlapping joint with sheet metal screws or rivets at a minimum of 4 locations for diameters not greater than 12 inches (304.8mm) and 8 locations for diameters greater than 12 inches (304.8 mm).
2. Carbon steel – Overlapping joint with ½ inch (12.7 mm) tack welds at a minimum of 4 locations for diameters up to 12 inches (304.8mm) and 8 locations for diameters larger than 12 inches (304.8 mm).
3. Carbon steel – continuous butt welded perimeter.
- [2.] 4. Vent connectors of listed vent material assembled and connected to flue collars or draft hood outlets in accordance with the manufacturer’s instructions.

[3. ~~Welding.~~]

[503.10.8] 503.10.7 Slope. A vent connector shall be installed without dips or sags and shall slope upward toward the vent or chimney [~~at least~~] not less than ¼ inch per foot (21 mm/m).

Exception: Vent connectors attached to a mechanical draft system installed in accordance with the manufacturers’ instructions.

[503.10.9] 503.10.8 Length of vent connector. [~~A vent connector shall be as short as practical and the appliance located as close as practical to the chimney or vent.~~] The maximum horizontal length of a [~~single-wall~~] single-wall connector shall be 75 percent of the height of the chimney or vent except for engineered systems. The maximum horizontal length of a Type B double-wall connector shall be 100 percent of the height of the chimney or vent except for engineered systems.

[503.10.10] 503.10.9 Support. A vent connector shall be supported in accordance with the manufacturer’s recommendations for the design and weight of the material employed to maintain clearances and prevent physical damage and separation of joints.

[503.10.11] 503.10.10 Chimney connection. Where entering a flue in a masonry or metal chimney, the vent connector shall be installed above the extreme bottom to avoid stoppage. Where a thimble or slip joint is used to facilitate removal of the connector, the connector shall be firmly attached to or inserted into the thimble or slip joint to prevent the connector from falling out. Means shall be employed to prevent the connector from entering so far as to restrict the space between its end and the opposite wall of the chimney flue (see Section 501.9).

[503.10.12] 503.10.11 Inspection. The entire length of a vent connector shall be provided with ready access for inspection, cleaning [7] and replacement.

[503.10.13] 503.10.12 Fireplaces. A vent connector shall not be connected to a chimney flue serving a fireplace.

~~[503.10.14]~~ **503.10.13 Passage through ceilings, floors [5] or walls.** Single-wall metal pipe connectors shall not pass through any wall, floor or ~~[fire resistance rated]~~ ceiling except as permitted by Section 503.7.4.

~~[503.10.15]~~ **503.10.14 Medium-heat connectors.** Vent connectors for medium-heat appliances shall not pass through walls or partitions constructed of combustible material.

503.11 Vent connectors for Category II, III, and IV appliances. Vent connectors for Category II, III, and IV appliances shall be as specified for the venting systems in accordance with Section 503.4.

503.12 Draft hoods and draft controls. The installation of draft hoods and draft controls shall comply with Sections 503.12.1 through 503.12.7.

503.12.1 Appliances requiring draft hoods. Vented appliances shall be installed with draft hoods.

Exception: ~~[Incinerators, direct vent]~~ Direct-vent appliances, fan-assisted combustion system appliances, appliances requiring chimney draft for operation, appliances equipped with blast, power, or pressure burners that are not listed for use with draft hoods, and appliances designed for forced venting.

503.12.2 Installation. A draft hood supplied with or forming a part of a listed vented appliance shall be installed without alteration, exactly as furnished and specified by the appliance manufacturer. ~~[Draft hoods shall be equipped with a thermal safety (spill) switch installed in accordance with its listing and the manufacturer's instructions.]~~

503.12.2.1 Draft hood required. If a draft hood is not supplied by the appliance manufacturer where one is required, a draft hood shall be installed, shall be of a listed or approved type and, in the absence of other instructions, shall be of the same size as the appliance flue collar. Where a draft hood is required with a conversion burner, it shall be of a listed or approved type.

503.12.2.2 Special design draft hood. Where it is determined that a draft hood of special design is needed or preferable for a particular installation, the installation shall be in accordance with the recommendations of the appliance manufacturer and shall be approved by the department.

503.12.3 Draft control devices. Where a draft control device is part of the appliance or is supplied by the appliance manufacturer, it shall be installed in accordance with the manufacturer's instructions. In the absence of manufacturer's instructions, the device shall be attached to the flue collar of the appliance or as near to the appliance as practical.

503.12.4 Additional devices. Appliances requiring a controlled chimney draft shall be permitted to be equipped with a listed double-acting barometric-draft regulator installed and adjusted in accordance with the manufacturers' instructions. ~~[Barometric draft regulators shall be equipped with a thermal safety (spill) switch installed in accordance with its listing and the manufacturer's instructions.]~~

503.12.5 Location. Draft hoods and barometric draft regulators shall be installed in the same room or enclosure as the appliance in such a manner as to prevent any difference in pressure between the hood or regulator and the combustion air supply.

503.12.6 Positioning. Draft hoods and draft regulators shall be installed in the position for which they were designed with reference to the horizontal and vertical planes and shall be located so that the relief opening is not obstructed by any part of the appliance or adjacent construction. The appliance and its draft hood shall be located so that the relief opening is accessible for checking vent operation.

503.12.7 Clearance. A draft hood shall be located so its relief opening is not less than 6 inches (~~[152]~~ 152.4 mm) from any surface except that of the appliance it serves and the venting system to which the draft hood is connected. Where a greater or lesser clearance is indicated on the appliance label, the clearance shall be not less than that specified on the label. Such clearances shall not be reduced.

503.12.8 Thermal safety (spill) switches. Thermal safety (spill) switches shall be installed on barometric-draft regulators and all other appurtenances that allow dilution air into chimneys or vents. Thermal safety (spill) switches shall be interlocked with all of the appliances connected to the same chimney or gas vent.

503.13 Manually operated dampers. A manually operated damper shall not be placed in the vent connector for any appliance. Fixed baffles shall not be classified as manually operated dampers.

503.14 Automatically operated vent dampers. An automatically operated vent damper shall be of a listed type complete with safety controls to prove open position of the damper ~~[before equipment operation]~~ and/or appropriate draft before appliance operation. The automatically operated dampers shall be installed in accordance with the manufacturer's instructions. An automatic vent damper device shall not be installed on an existing appliance unless the appliance is listed and labeled and the device is installed in accordance with the terms of its listing. The name of the installer and date of installation shall be marked on a label affixed to the damper device.

503.15 Obstructions. Devices that retard the flow of vent gases shall not be installed in a vent connector, chimney [~~7~~] or vent. The following shall not be considered as obstructions:

1. Draft regulators and safety controls specifically listed for installation in venting systems and installed in accordance with the terms of their listing and manufacturer's ~~[installation]~~ instructions.
2. Approved draft regulators and safety controls that are designed and installed in accordance with approved engineering methods.
3. Listed heat reclaimers and automatically operated vent dampers installed in accordance with the terms of their listing and manufacturer's ~~[installation]~~ instructions.

4. Approved economizers, heat reclaimers [7] and recuperators installed in venting systems of appliances not required to be equipped with draft hoods, provided that the appliance manufacturer's instructions cover the installation of such a device in the venting system and performance in accordance with Sections 503.3 and 503.3.1 is obtained.
5. Vent dampers serving listed appliances installed in accordance with Sections 504.2.1 and 504.3.1 or other approved engineering methods.

503.16 Outside wall penetrations. Where vents, including those for direct-vent appliances, penetrate outside walls of buildings, the annular spaces around such penetrations shall be permanently sealed using approved materials to prevent entry of combustion products into the building.

SECTION FGC 504 SIZING OF CATEGORY I APPLIANCE VENTING SYSTEMS

504.1 Definitions. The following definitions apply to the tables in this section.

APPLIANCE CATEGORIZED VENT DIAMETER/AREA. The minimum vent area/diameter permissible for Category I appliances to maintain a non-positive vent static pressure when tested in accordance with nationally recognized standards.

FAN-ASSISTED COMBUSTION SYSTEM. An appliance equipped with an integral mechanical means to either draw or force products of combustion through the combustion chamber or heat exchanger.

FAN Min. The minimum input rating of a Category I fan-assisted appliance attached to a vent or connector.

FAN Max. The maximum input rating of a Category I fan-assisted appliance attached to a vent or connector.

NAT Max. The maximum input rating of a Category I draft-hood-equipped appliance attached to a vent or connector.

FAN + FAN. The maximum combined appliance input rating of two or more Category I fan-assisted appliances attached to the common vent.

FAN + NAT. The maximum combined appliance input rating of one or more Category I fan-assisted appliances and one or more Category I draft-hood-equipped appliances attached to the common vent.

NA. Vent configuration is not allowed due to potential for condensate formation or pressurization of the venting system, or not applicable due to physical or geometric restraints.

NAT + NAT. The maximum combined appliance input rating of two or more Category I draft-hood-equipped appliances attached to the common vent.

504.2 Application of single-appliance vent Tables 504.2(1) through 504.2(6). The application of Tables 504.2(1) through 504.2(6) shall be subject to the requirements of Sections 504.2.1 through [~~504.2.16~~] 504.2.17.

TABLE 504.2(1)
TYPE B DOUBLE-WALL GAS
VENT

Number of Appliances	Single
Appliance Type	Category I
Appliance Vent Connection	Connected directly to vent

HEI GHT (H) (feet)	LATE RAL (L) (feet)	VENT DIAMETER – (D) inches																				
		3			4			5			6			7			8			9		
		APPLIANCE INPUT RATING IN THOUSANDS OF BTU/H																				
		FAN		N A T	FAN		N A T	FAN		N A T	FAN		N A T	FAN		N A T	FAN		N A T	FAN		N A T
M in	M ax	M ax	M in	M ax	M ax	M in	M ax	M ax	M in	M ax	M ax	M in	M ax	M ax	M in	M ax	M ax	M in	M ax	M ax		
6	0	0	78	46	0	15 2	86	0	25 1	14 1	0	37 5	20 5	0	52 4	28 5	0	69 8	37 0	0	89 7	47 0
	2	13	51	36	18	97	67	27	15 7	10 5	32	23 2	15 7	44	32 1	21 7	53	42 5	28 5	63	54 3	37 0
	4	21	49	34	30	94	64	39	15 3	10 3	50	22 7	15 3	66	31 6	21 1	79	41 9	27 9	93	53 6	36 2
	6	25	46	32	36	91	61	47	14 9	10 0	59	22 3	14 9	78	31 0	20 5	93	41 3	27 3	11 0	53 0	35 4
8	0	0	84	50	0	16 5	94	0	27 6	15 5	0	41 5	23 5	0	58 3	32 0	0	78 0	41 5	0	1,0 06	53 7
	2	12	57	40	16	10 9	75	25	17 8	12 0	28	26 3	18 0	42	36 5	24 7	50	48 3	32 2	60	61 9	41 8
	5	23	53	38	32	10 3	71	42	17 1	11 5	53	25 5	17 3	70	35 6	23 7	83	47 3	31 3	99	60 7	40 7
	8	28	49	35	39	98	66	51	16 4	10 9	64	24 7	16 5	84	34 7	22 7	99	46 3	30 3	11 7	59 6	39 6
10	0	0	88	53	0	17 5	10 0	0	29 5	16 6	0	44 7	25 5	0	63 1	34 5	0	84 7	45 0	0	1,0 96	58 5
	2	12	61	42	17	11 8	81	23	19 4	12 9	26	28 9	19 5	40	40 2	27 3	48	53 3	35 5	57	68 4	45 7
	5	23	57	40	32	11 3	77	41	18 7	12 4	52	28 0	18 8	68	39 2	26 3	81	52 6	34 6	95	67 1	44 6
	10	30	51	36	41	10 4	70	54	17 6	11 5	67	26 7	17 5	88	37 6	24 5	10 4	50 4	33 0	12 2	65 1	42 7
15	0	0	94	58	0	19 1	11 2	0	32 7	18 7	0	50 2	28 5	0	71 6	39 0	0	97 0	52 5	0	1,2 63	68 2
	2	11	69	48	15	13 6	93	20	22 6	15 0	22	33 9	22 5	38	47 5	31 6	45	63 3	41 4	53	81 5	54 4
	5	22	65	45	30	13 0	87	39	21 9	14 2	49	33 0	21 7	64	46 3	30 0	76	62 0	40 3	90	80 0	52 9
	10	29	59	41	40	12 1	82	51	20 6	13 5	64	31 5	20 8	84	44 5	28 8	99	60 0	38 6	11 6	77 7	50 7
	15	35	53	37	48	11 2	76	61	19 5	12 8	76	30 1	19 8	98	42 9	27 5	11 5	58 0	37 3	13 4	75 5	49 1
20	0	0	97	61	0	20 2	11 9	0	34 9	20 2	0	54 0	30 7	0	77 6	43 0	0	1,0 57	57 5	0	1,3 84	75 2
	2	10	75	51	14	14 9	10 0	18	25 0	16 6	20	37 7	24 9	33	53 1	34 6	41	71 1	48 0	50	91 7	61 2
	5	21	71	48	29	14 3	96	38	24 2	16 0	47	36 7	24 1	62	51 9	33 7	73	69 7	46 0	86	90 2	59 9
	10	28	64	44	38	13 3	89	50	22 9	15 0	62	35 1	22 8	81	49 9	32 1	95	67 5	44 3	11 2	87 7	57 6
	15	34	58	40	46	12 4	84	59	21 7	14 2	73	33 7	21 7	94	48 1	30 8	11 1	65 4	42 7	12 9	85 3	55 7
	20	48	52	35	55	11 6	78	69	20 6	13 4	84	32 2	20 6	10 7	46 4	29 5	12 5	63 0	41 0	14 5	83 0	53 7
30	0	0	10 0	64	0	21 3	12 8	0	37 4	22 0	0	58 7	33 6	0	85 3	47 5	0	1,1 73	65 0	0	1,5 48	85 5
	2	9	81	56	13	16 6	11 2	14	28 3	18 5	18	43 2	28 0	27	61 3	39 4	33	82 6	53 5	42	1,0 72	70 0
	5	21	77	54	28	16 0	10 8	36	27 5	17 6	45	42 1	27 3	58	60 0	38 5	69	81 1	52 4	82	1,0 55	68 8
	10	27	70	50	37	15 0	10 2	48	26 2	17 1	59	40 5	26 1	77	58 0	37 1	91	78 8	50 7	10 7	1,0 28	66 8
	15	33	64	N A	44	14 1	96	57	24 9	16 3	70	38 9	24 9	90	56 0	10 7	10 5	76 5	49 0	12 4	1,0 02	64 8
	20	56	58	N A	53	13 2	90	66	23 7	15 4	80	37 4	23 1	10	46 2	34 3	11 9	74 3	47 3	13 9	97 7	62 8
	30	N A	N A	N A	73	11 3	N A	88	21 4	N A	10 4	34 6	21 9	13 1	50 7	32 1	14 9	70 2	44 4	17 1	92 9	59 4
50	0	0	10	67	0	21	13	0	39	23	0	63	36	0	93	51	0	1,2	70	0	1,7	95

**TABLE 504.2(1)
TYPE B DOUBLE-WALL GAS
VENT**

Number of Appliances	Single
Appliance Type	Category I
Appliance Vent Connection	Connected directly to vent

HEI GHT (H) (feet)	LATE RAL (L) (feet)	VENT DIAMETER – (D) inches																						
		3			4			5			6			7			8			9				
		APPLIANCE INPUT RATING IN THOUSANDS OF BTU/H																						
		FAN		N A T	FAN		N A T	FAN		N A T	FAN		N A T	FAN		N A T	FAN		N A T	FAN		N A T		
M in	M ax	M ax	M in	M ax	M ax	M in	M ax	M ax	M in	M ax	M ax	M in	M ax	M ax	M in	M ax	M ax	M in	M ax	M ax	M in	M ax	M ax	
			1			6	4		7	2		3	3		2	8		97	8		30	2		
	2	8	86	61	11	18 3	12 2	14	32 0	20 6	15	49 7	31 4	22	71 5	44 5	26	97 5	61 5	33	1,2 76	81 3		
	5	20	82	N A	27	17 7	11 9	35	31 2	20 0	43	48 7	30 8	55	70 2	73 8	65	96 0	60 5	77	1,2 59	79 8		
	10	26	76	N A	35	16 8	11 4	45	29 9	19 0	56	47 1	29 8	73	68 1	42 6	86	93 5	58 9	10 1	1,2 30	77 3		
	15	59	70	N A	42	15 8	N A	54	28 7	18 0	66	45 5	28 8	85	66 2	41 3	10 0	91 1	57 2	11 7	1,2 03	74 7		
	20	N A	N A	N A	50	14 9	N A	63	27 5	16 9	76	44 0	27 8	97	64 2	40 1	11 3	88 8	55 6	13 1	1,1 76	72 2		
	30	N A	N A	N A	69	13 1	N A	84	25 0	N A	99	41 0	25 9	12 3	60 5	37 6	14 4	84 1	52 2	16 1	1,1 25	67 0		
100	0	N A	N A	N A	0	21 8	N A	0	40 7	N A	0	66 5	40 0	0	99 7	56 0	0	1,4 11	77 0	0	1,9 08	1,0 40		
	2	N A	N A	N A	10	19 4	N A	12	35 4	N A	13	56 6	37 5	18	83 1	51 0	21	1,1 55	70 0	25	1,5 36	93 5		
	5	N A	N A	N A	26	18 9	N A	33	34 7	N A	40	55 7	36 9	52	82 0	50 4	60	1,1 41	69 2	71	1,5 19	92 6		
	10	N A	N A	N A	33	18 2	N A	43	33 5	N A	53	54 2	36 1	68	80 1	49 3	80	1,1 18	67 9	94	1,4 92	91 0		
	15	N A	N A	N A	40	17 4	N A	50	32 1	N A	62	52 8	35 3	80	78 2	48 2	93	1,0 95	66 6	10 9	1,4 65	89 5		
	20	N A	N A	N A	47	16 6	N A	59	31 1	N A	71	51 3	34 4	90	76 3	47 1	10 5	1,0 73	65 3	12 2	1,4 38	88 0		
	30	N A	N A	N A	N A	N A	N A	78	29 0	N A	92	48 3	N A	11 5	72 6	44 9	13 1	1,0 29	62 7	14 9	1,3 87	84 9		
50	N A	N A	N A	N A	N A	N A	N A	N A	N A	14 7	42 8	N A	18 0	65 1	40 5	19 7	94 4	57 5	21 7	1,2 88	78 7			

TABLE 504.2(1)-continued
TYPE B DOUBLE-WALL GAS VENT

		Number of Appliances																	Single										
		Appliance Type																	Category I										
HEIGHT T (H) (feet)		LATERAL L (L) (feet)		VENT DIAMETER - (D) inches																									
				10			12			14			16			18			20			22			24				
				APPLIANCE INPUT RATING IN THOUSANDS OF BTU/H																									
		FAN		NAT		FAN		NAT		FAN		NAT		FAN		NAT		FAN		NAT		FAN		NAT		FAN		NAT	
		Min	Max	Max	Min	Max	Max	Min	Max	Max	Min	Max	Max	Min	Max	Max	Min	Max	Max	Min	Max	Max	Min	Max	Max	Min	Max	Max	Min
6	0	0	1,121	570	0	1,645	850	0	2,267	1,170	0	2,983	1,530	0	3,802	1,960	0	4,721	2,430	0	5,737	2,950	0	6,853	3,520				
	2	75	675	455	103	982	650	138	1,346	890	178	1,769	1,170	225	2,250	1,480	296	2,782	1,850	360	3,377	2,220	426	4,030	2,670				
	4	110	668	445	147	975	640	191	1,338	880	242	1,761	1,160	300	2,242	1,475	390	2,774	1,835	469	3,370	2,215	555	4,023	2,660				
	6	128	661	435	171	967	630	219	1,330	870	276	1,753	1,150	341	2,235	1,470	437	2,767	1,820	523	3,363	2,210	618	4,017	2,650				
8	0	0	1,261	660	0	1,858	970	0	2,571	1,320	0	3,399	1,740	0	4,333	2,220	0	5,387	2,750	0	6,555	3,360	0	7,838	4,010				
	2	71	770	515	98	1,124	745	130	1,543	1,020	168	2,030	1,340	212	2,574	1,700	278	3,196	2,110	336	3,882	2,560	401	4,634	3,050				
	5	115	758	503	154	1,110	733	199	1,528	1,010	251	2,013	1,330	311	2,563	1,685	398	3,180	2,090	476	3,863	2,545	562	4,612	3,040				
	8	137	746	490	180	1,097	720	231	1,514	1,000	289	2,000	1,320	354	2,552	1,670	450	3,163	2,070	537	3,850	2,530	630	4,602	3,030				
10	0	0	1,377	720	0	2,036	1,060	0	2,825	1,450	0	3,742	1,925	0	4,782	2,450	0	5,955	3,050	0	7,254	3,710	0	8,682	4,450				
	2	68	852	560	93	1,244	850	124	1,713	1,130	161	2,256	1,480	202	2,868	1,890	264	3,556	2,340	319	4,322	2,840	378	5,153	3,390				
	5	112	839	547	149	1,229	829	192	1,696	1,105	243	2,238	1,461	300	2,849	1,871	382	3,536	2,318	458	4,301	2,818	540	5,132	3,371				
	10	142	817	525	187	1,204	795	238	1,669	1,080	298	2,209	1,430	364	2,818	1,840	459	3,504	2,280	546	4,268	2,780	641	5,099	3,340				
15	0	0	1,596	740	0	2,380	1,240	0	3,323	1,720	0	4,423	2,270	0	5,678	2,900	0	7,099	3,620	0	8,665	4,410	0	10,393	5,300				
	2	63	1,019	675	86	1,495	985	114	2,062	1,350	147	2,719	1,770	186	3,467	2,260	239	4,304	2,800	290	5,232	3,410	346	6,251	4,080				
	5	105	1,003	660	140	1,476	967	182	2,041	1,327	229	2,696	1,748	283	3,442	2,235	355	4,278	2,777	426	5,204	3,385	501	6,222	4,057				
	10	135	977	635	177	1,446	936	227	2,009	1,289	283	2,659	1,712	346	3,402	2,193	432	4,234	2,739	510	5,159	3,343	599	6,175	4,019				
20	15	155	953	610	202	1,418	905	257	1,976	1,250	318	2,623	1,675	385	3,363	2,150	479	4,192	2,700	564	5,115	3,300	665	6,129	3,980				
	0	0	1,756	930	0	2,637	1,350	0	3,701	1,900	0	4,948	2,520	0	6,376	3,250	0	7,988	4,060	0	9,785	4,980	0	11,753	6,000				
	2	59	1,150	755	81	1,694	1,100	107	2,343	1,520	139	3,097	2,000	175	3,955	2,570	220	4,916	3,200	269	5,983	3,910	321	7,154	4,700				
	5	101	1,133	738	135	1,674	1,079	174	2,320	1,498	219	3,071	1,978	270	3,926	2,544	337	4,885	3,174	403	5,950	3,880	475	7,119	4,662				
	10	130	1,105	710	172	1,641	1,045	220	2,282	1,460	273	3,029	1,940	334	3,880	2,500	413	4,835	3,130	489	5,896	3,830	573	7,063	4,600				
	15	150	1,078	688	195	1,609	1,018	248	2,245	1,425	306	2,988	1,910	372	3,835	2,465	459	4,786	3,090	541	5,844	3,795	631	7,007	4,575				
30	20	167	1,052	665	217	1,578	990	273	2,210	1,390	335	2,948	1,880	404	3,791	2,430	495	4,737	3,050	585	5,792	3,760	689	6,953	4,550				
	0	0	1,977	1,060	0	3,004	1,550	0	4,252	2,170	0	5,725	2,920	0	7,420	3,770	0	9,341	4,750	0	11,483	5,850	0	13,848	7,060				
	2	54	1,351	865	74	2,004	1,310	98	2,786	1,800	127	3,696	2,380	159	4,734	3,050	199	5,900	3,810	241	7,194	4,650	285	8,617	5,600				
	5	96	1,332	851	127	1,981	1,289	164	2,759	1,775	206	3,666	2,350	252	4,701	3,020	312	5,863	3,783	373	7,155	4,622	439	8,574	5,552				
	10	125	1,301	829	164	1,944	1,254	209	2,716	1,733	259	3,617	2,300	316	4,647	2,970	386	5,803	3,739	456	7,090	4,574	535	8,505	5,471				
	15	143	1,272	807	187	1,908	1,220	237	2,674	1,692	292	3,570	2,250	354	4,594	2,920	431	5,744	3,695	507	7,026	4,527	590	8,437	5,391				
	20	160	1,243	784	207	1,873	1,185	260	2,633	1,650	319	3,523	2,200	384	4,542	2,870	467	5,686	3,650	548	6,964	4,480	639	8,370	5,310				
	30	195	1,189	745	246	1,807	1,130	305	2,555	1,585	369	3,433	2,130	440	4,442	2,785	540	5,574	3,565	635	6,842	4,375	739	8,239	5,225				
50	0	0	2,231	1,195	0	3,441	1,825	0	4,934	2,550	0	6,711	3,440	0	8,774	4,460	0	11,129	5,635	0	13,767	6,940	0	16,694	8,430				
	2	41	1,620	1,010	66	2,431	1,513	86	3,409	2,125	113	4,554	2,840	141	5,864	3,670	171	7,339	4,630	209	8,980	5,695	251	10,788	6,860				
	5	90	1,600	996	118	2,406	1,495	151	3,380	2,102	191	4,520	2,813	234	5,826	3,639	283	7,295	4,597	336	8,933	5,654	394	10,737	6,818				
	10	118	1,567	972	154	2,366	1,466	196	3,332	2,064	243	4,464	2,767	295	5,763	3,585	355	7,224	4,542	419	8,855	5,585	491	10,652	6,749				
	15	136	1,536	948	177	2,327	1,437	222	3,285	2,026	274	4,409	2,721	330	5,701	3,534	396	7,155	4,511	465	8,779	5,546	542	10,570	6,710				
	20	151	1,505	924	195	2,288	1,408	244	3,239	1,987	300	4,356	2,675	361	5,641	3,481	433	7,086	4,479	506	8,704	5,506	586	10,488	6,670				
	30	183	1,446	876	232	2,214	1,349	287	3,150	1,810	347	4,253	2,631	412	5,523	3,431	494	6,953	4,421	577	8,557	5,444	672	10,328	6,603				
100	0	0	2,491	1,310	0	3,925	2,050	0	5,729	2,950	0	7,914	4,050	0	10,485	5,300	0	13,454	6,700	0	16,817	8,600	0	20,578	10,300				
	2	30	1,975	1,170	44	3,027	1,820	72	4,313	2,550	95	5,834	3,500	120	7,591	4,600	138	9,577	5,800	169	11,803	7,200	204	14,264	8,800				
	5	82	1,955	1,159	107	3,002	1,803	136	4,282	2,531	172	5,797	3,475	208	7,548	4,566	245	9,528	5,769	293	11,748	7,162	341	14,204	8,756				
	10	108	1,923	1,142	142	2,961	1,775	180	4,231	2,500	223	5,737	3,434	268	7,478	4,509	318	9,447	5,717	374	11,658	7,100	436	14,105	8,683				
	15	126	1,892	1,124	163	2,920	1,747	206	4,182	2,469	252	5,678	3,392	304	7,409	4,451	358	9,367	5,665	418	11,569	7,037	487	14,007	8,610				
	20	141	1,861	1,107	181	2,880	1,719	226	4,133	2,438	277	5,619	3,351	330	7,341	4,394	387	9,289	5,613	452	11,482	6,975	523	13,910	8,537				
	30	170	1,802	1,071	215	2,803	1,663	265	4,037	2,375	319	5,505	3,267	378	7,209	4,279	446	9,136	5,509	514	11,310	6,850	592	13,720	8,391				
50	241	1,688	1,000	292	2,657	1,550	350	3,856	2,250	415	5,289	3,100	486	6,956	4,050	572	8,841	5,300	659	10,979	6,600	752	13,354	8,100					

For SI: 1 inch = 25.4 mm, 1 foot = 304.8 mm, 1 British thermal unit per hour = 0.2931 W.

**TABLE 504.2(2)
TYPE B DOUBLE-WALL GAS VENT**

Number of Appliances	Single
Appliance Type	Category I
Appliance Vent Connection	Single-wall metal connector

HEIGHT (H) (feet)	LATERAL (L) (feet)	VENT DIAMETER – (D) inches																																			
		3				4				5				6				7				8				9				10				12			
		APPLIANCE INPUT RATING IN THOUSANDS OF BTU/H						FAN		NAT		FAN		NAT		FAN		NAT		FAN		NAT		FAN		NAT		FAN		NAT							
		Min	Max	Max	Min	Max	Max	Min	Max	Max	Min	Max	Max	Min	Max	Max	Min	Max	Max	Min	Max	Max	Min	Max	Max	Min	Max	Max	Min	Max	Max						
6	0	38	77	45	59	151	85	85	249	140	126	373	204	165	522	284	211	695	369	267	894	469	371	1,118	569	537	1,639										
	2	39	51	36	60	96	66	85	156	104	123	231	156	159	320	213	201	423	284	251	541	368	347	671	453	498	979										
	4	NA	NA	33	74	92	63	102	152	102	146	225	152	187	313	208	237	416	277	295	533	360	409	664	443	584	971										
	6	NA	NA	31	83	89	60	114	147	99	163	220	148	207	307	203	263	409	271	327	526	352	449	656	433	538	962										
8	0	37	83	50	58	164	93	83	273	154	123	412	234	161	580	319	206	777	414	258	1,002	536	360	1,257	658	521	1,852										
	2	39	56	39	59	108	75	83	176	119	121	261	179	155	363	246	197	482	321	246	617	417	339	768	513	486	1,120										
	5	NA	NA	37	77	102	69	107	168	114	151	252	171	193	352	235	245	470	311	305	604	404	418	754	500	598	1,104										
	8	NA	NA	33	90	95	64	122	161	107	175	243	163	223	342	225	280	458	300	344	591	392	470	740	486	665	1,089										
10	0	37	87	53	57	174	99	82	293	165	120	444	254	158	648	254	202	844	449	253	1,093	584	351	1,373	718	507	2,031										
	2	39	61	41	59	117	80	82	193	128	119	287	194	153	400	272	193	531	354	242	681	456	332	849	559	475	1,242										
	5	52	56	39	76	111	76	105	185	122	148	277	186	190	388	261	241	518	344	299	667	443	409	834	544	584	1,224										
	10	NA	NA	34	97	100	68	132	171	112	188	261	171	237	325	241	296	497	325	363	643	423	492	808	520	688	1,194										
15	0	36	93	57	56	190	111	80	325	186	166	499	283	153	713	388	195	966	523	244	1,259	681	336	1,571	838	488	2,374										
	2	38	69	47	57	136	93	80	225	149	115	337	224	148	473	314	187	631	413	232	812	543	319	1,015	673	457	1,491										
	5	51	63	44	75	128	86	102	216	140	144	326	217	182	459	298	231	616	400	287	795	526	383	997	657	562	1,469										
	10	NA	NA	39	95	116	79	128	201	131	182	308	203	228	438	284	284	592	381	349	768	501	470	966	628	664	1,433										
20	0	35	96	60	54	200	118	78	346	201	114	537	306	149	772	428	190	1,053	573	238	1,379	750	326	1,751	927	473	2,631										
	2	37	74	50	56	148	99	78	248	165	113	375	248	144	528	344	182	708	468	227	914	611	309	1,146	754	443	1,689										
	5	50	68	47	73	140	94	100	239	158	141	363	239	178	514	334	224	692	381	457	896	596	381	1,126	734	547	1,665										
	10	NA	NA	41	93	129	86	125	223	146	177	344	224	222	491	316	277	666	437	339	866	570	457	1,092	702	646	1,626										
30	0	34	99	63	53	211	127	76	372	219	110	584	334	144	849	472	184	1,168	647	229	1,542	852	312	1,971	1,056	454	2,996										
	2	37	80	56	55	164	111	76	281	183	109	429	279	139	610	392	175	823	533	219	1,069	698	296	1,346	863	424	1,999										
	5	49	74	52	72	157	106	98	271	173	136	417	271	171	595	382	215	806	521	269	1,049	684	366	1,324	846	524	1,971										
	10	NA	NA	NA	91	144	98	122	255	168	171	397	257	213	570	367	265	777	501	327	1,017	662	440	1,287	821	620	1,927										
50	0	33	99	66	51	213	133	73	394	230	105	629	361	138	928	515	176	1,292	704	220	1,724	948	295	2,223	1,189	428	3,432										
	2	36	84	61	53	181	121	73	318	205	104	495	312	133	712	443	168	971	613	209	1,273	811	280	1,615	1,007	401	2,426										
	5	48	80	NA	70	174	117	94	308	198	131	482	305	164	696	435	204	953	602	257	1,252	795	347	1,591	991	496	2,396										
	10	NA	NA	NA	89	160	NA	118	292	186	162	461	292	203	671	420	253	923	583	313	1,217	765	418	1,551	963	589	2,347										
100	0	NA	NA	NA	NA	NA	NA	NA	NA	NA	176	257	NA	176	257	NA	176	257	NA	176	257	NA	176	257	NA	176	257	NA									
	2	NA	NA	NA	NA	NA	NA	NA	NA	NA	176	257	NA	176	257	NA	176	257	NA	176	257	NA	176	257	NA	176	257	NA									
	5	NA	NA	NA	NA	NA	NA	NA	NA	NA	176	257	NA	176	257	NA	176	257	NA	176	257	NA	176	257	NA	176	257	NA									
	10	NA	NA	NA	NA	NA	NA	NA	NA	NA	176	257	NA	176	257	NA	176	257	NA	176	257	NA	176	257	NA	176	257	NA									
100	0	NA	NA	NA	NA	NA	NA	NA	NA	NA	231	264	NA	231	264	NA	231	264	NA	231	264	NA	231	264	NA	231	264	NA									
	2	NA	NA	NA	NA	NA	NA	NA	NA	NA	231	264	NA	231	264	NA	231	264	NA	231	264	NA	231	264	NA	231	264	NA									
	5	NA	NA	NA	NA	NA	NA	NA	NA	NA	231	264	NA	231	264	NA	231	264	NA	231	264	NA	231	264	NA	231	264	NA									
	10	NA	NA	NA	NA	NA	NA	NA	NA	NA	231	264	NA	231	264	NA	231	264	NA	231	264	NA	231	264	NA	231	264	NA									

For SI: 1 inch = 25.4 mm, 1 foot = 304.8 mm, 1 British thermal unit per hour = 0.2931 W.

**TABLE 504.2(3)
MASONRY CHIMNEY**

Number of Appliances	Single
Appliance Type	Category I
Appliance Vent Connection	Type B double-wall connector

HEIGHT (H) (feet)	LATERAL (L) (feet)	TYPE B DOUBLE-WALL CONNECTOR DIAMETER – (D) inches to be used with chimney areas within the size limits at bottom																											
		3			4			5			6			7			8			9			10			12			
		FAN		NAT	FAN		NAT	FAN		NAT	FAN		NAT	FAN		NAT	FAN		NAT	FAN		NAT	FAN		NAT	FAN		NAT	
		Min	Max	Max	Min	Max	Max	Min	Max	Max	Min	Max	Max	Min	Max	Max	Min	Max	Max	Min	Max	Max	Min	Max	Max	Min	Max	Max	Min
6	2	NA	NA	28	NA	NA	52	NA	NA	86	NA	NA	130	NA	NA	180	NA	NA	247	NA	NA	320	NA	NA	401	NA	NA	581	
	5	NA	NA	25	NA	NA	49	NA	NA	82	NA	NA	117	NA	NA	165	NA	NA	231	NA	NA	298	NA	NA	376	NA	NA	561	
	8	NA	NA	29	NA	NA	55	NA	NA	93	NA	NA	145	NA	NA	198	NA	NA	266	84	590	350	100	728	446	139	1,024	651	
8	5	NA	NA	26	NA	NA	52	NA	NA	88	NA	NA	134	NA	NA	183	NA	NA	248	NA	NA	328	149	711	423	201	1,007	640	
	8	NA	NA	24	NA	NA	48	NA	NA	83	NA	NA	127	NA	NA	175	NA	NA	239	NA	NA	318	173	695	410	231	990	623	
	10	NA	NA	31	NA	NA	61	NA	NA	103	NA	NA	162	NA	NA	221	68	519	298	82	655	388	98	720	491	136	1,144	724	
10	5	NA	NA	28	NA	NA	57	NA	NA	96	NA	NA	148	NA	NA	204	NA	NA	277	124	638	365	146	791	466	196	1,124	712	
	10	NA	NA	25	NA	NA	50	NA	NA	87	NA	NA	139	NA	NA	191	NA	NA	263	155	610	347	182	762	444	240	1,093	668	
	2	NA	NA	35	NA	NA	67	NA	NA	114	NA	NA	179	53	475	250	64	613	336	77	779	441	92	968	562	127	1,376	841	
	5	NA	NA	35	NA	NA	62	NA	NA	107	NA	NA	164	NA	NA	231	99	597	313	118	759	416	139	946	533	186	1,352	828	
15	10	NA	NA	28	NA	NA	55	NA	NA	97	NA	NA	153	NA	NA	216	126	565	296	148	727	394	173	912	567	229	1,315	777	
	15	NA	NA	NA	NA	NA	48	NA	NA	89	NA	NA	141	NA	NA	201	NA	NA	281	171	698	375	198	880	485	259	1,280	742	
	2	NA	NA	38	NA	NA	74	NA	NA	124	NA	NA	201	51	522	274	61	678	375	73	867	491	87	1,083	627	121	1,548	953	
20	5	NA	NA	36	NA	NA	68	NA	NA	116	NA	NA	184	80	503	254	95	658	350	113	845	463	133	1,059	597	179	1,523	933	
	10	NA	NA	NA	NA	NA	60	NA	NA	107	NA	NA	172	NA	NA	237	122	627	332	143	811	440	167	1,022	566	221	1,482	879	
	15	NA	NA	NA	NA	NA	NA	NA	NA	97	NA	NA	159	NA	NA	220	NA	NA	314	165	780	418	191	987	541	251	1,443	840	
	20	NA	NA	NA	NA	NA	NA	NA	NA	83	NA	NA	148	NA	NA	206	NA	NA	296	186	750	397	214	955	513	277	1,406	807	
30	2	NA	NA	41	NA	NA	82	NA	NA	137	NA	NA	216	47	581	303	57	762	421	68	985	558	81	1,240	717	111	1,793	1,112	
	5	NA	NA	NA	NA	NA	76	NA	NA	128	NA	NA	198	75	561	281	90	741	393	106	962	526	125	1,216	683	169	1,766	1,094	
	10	NA	NA	NA	NA	NA	67	NA	NA	115	NA	NA	184	NA	NA	263	115	709	373	135	927	500	158	1,176	648	210	1,721	1,025	
	15	NA	NA	NA	NA	NA	NA	NA	NA	107	NA	NA	171	NA	NA	243	NA	NA	353	156	893	476	181	1,139	621	239	1,679	981	
	20	NA	NA	NA	NA	NA	NA	NA	NA	91	NA	NA	159	NA	NA	227	NA	NA	332	176	860	450	203	1,103	592	264	1,638	940	
50	30	NA	NA	NA	NA	NA	NA	NA	NA	NA	NA	NA	NA	NA	NA	188	NA	NA	288	NA	NA	416	249	1,035	555	318	1,560	877	
	2	NA	NA	NA	NA	NA	92	NA	NA	161	NA	NA	251	NA	NA	351	51	840	477	61	1,106	633	72	1,413	812	99	2,080	1,243	
	5	NA	NA	NA	NA	NA	NA	NA	NA	151	NA	NA	230	NA	NA	323	83	819	445	98	1,083	596	116	1,387	774	155	2,052	1,225	
	10	NA	NA	NA	NA	NA	NA	NA	NA	138	NA	NA	215	NA	NA	304	NA	NA	424	126	1,047	567	147	1,347	733	195	2,006	1,147	
	15	NA	NA	NA	NA	NA	NA	NA	NA	127	NA	NA	199	NA	NA	282	NA	NA	400	146	1,010	539	170	1,307	702	222	1,961	1,099	
	20	NA	NA	NA	NA	NA	NA	NA	NA	NA	NA	NA	185	NA	NA	264	NA	NA	376	165	977	511	190	1,269	669	246	1,916	1,050	
30	NA	NA	NA	NA	NA	NA	NA	NA	NA	NA	NA	NA	NA	NA	NA	NA	NA	327	NA	NA	468	233	1,196	623	295	1,832	984		
Minimum Internal Area of Chimney (square inches)		12			19			28			38			50			63			78			95			132			
Maximum Internal Area of Chimney (square inches)		Seven times the listed appliance categorized vent area, flue collar area or draft hood outlet area.																											

For SI: 1 inch = 25.4 mm, 1 square inch = 645.16 mm², 1 foot = 304.8 mm, 1 British thermal unit per hour = 0.2931 W.

**TABLE 504.2(4)
MASONRY CHIMNEY**

Number of Appliances	Single
Appliance Type	Category I
Appliance Vent Connection	Single-wall metal connector

HEIGHT (H) (feet)	LATERAL (L) (feet)	SINGLE-WALL METAL CONNECTOR DIAMETER – (D) inches to be used with chimney areas within the size limits at bottom																													
		3			4			5			6			7			8			9			10			12					
		APPLIANCE INPUT RATING IN THOUSANDS OF BTU/H						FAN			NAT			FAN			NAT			FAN			NAT			FAN			NAT		
		FAN		NAT	FAN		NAT	FAN		NAT	FAN		NAT	FAN		NAT	FAN		NAT	FAN		NAT	FAN		NAT	FAN		NAT	FAN		NAT
	Min	Max	Max	Min	Max	Max	Min	Max	Max	Min	Max	Max	Min	Max	Max	Min	Max	Max	Min	Max	Max	Min	Max	Max	Min	Max	Max	Min	Max	Max	
6	2	NA	NA	28	NA	NA	52	NA	NA	86	NA	NA	130	NA	NA	180	NA	NA	247	NA	NA	319	NA	NA	400	NA	NA	580			
	5	NA	NA	25	NA	NA	48	NA	NA	81	NA	NA	116	NA	NA	164	NA	NA	230	NA	NA	297	NA	NA	375	NA	NA	560			
8	2	NA	NA	29	NA	NA	55	NA	NA	93	NA	NA	145	NA	NA	197	NA	NA	265	NA	NA	349	382	725	445	549	1,021	650			
	5	NA	NA	26	NA	NA	51	NA	NA	87	NA	NA	133	NA	NA	182	NA	NA	246	NA	NA	327	NA	NA	422	673	1,003	638			
	8	NA	NA	23	NA	NA	47	NA	NA	82	NA	NA	126	NA	NA	174	NA	NA	237	NA	NA	317	NA	NA	408	747	985	621			
10	2	NA	NA	31	NA	NA	61	NA	NA	102	NA	NA	161	NA	NA	220	216	518	297	271	654	387	372	808	490	536	1,142	722			
	5	NA	NA	28	NA	NA	56	NA	NA	95	NA	NA	147	NA	NA	203	NA	NA	276	334	635	364	459	789	465	657	1,121	710			
	10	NA	NA	24	NA	NA	49	NA	NA	86	NA	NA	137	NA	NA	189	NA	NA	261	NA	NA	345	547	758	441	771	1,088	665			
15	2	NA	NA	35	NA	NA	67	NA	NA	113	NA	NA	178	166	473	249	211	611	335	264	776	440	440	362	865	560	520	1,373	740		
	5	NA	NA	32	NA	NA	61	NA	NA	106	NA	NA	163	NA	NA	230	261	591	312	325	775	414	444	843	531	637	1,348	825			
	10	NA	NA	27	NA	NA	54	NA	NA	96	NA	NA	151	NA	NA	214	NA	NA	294	392	722	392	531	907	504	749	1,309	774			
	15	NA	NA	NA	NA	NA	46	NA	NA	87	NA	NA	138	NA	NA	198	NA	NA	278	452	692	372	606	873	481	840	1,272	738			
20	2	NA	NA	38	NA	NA	73	NA	NA	123	NA	NA	200	163	520	273	206	675	374	258	864	490	252	1,079	625	508	1,544	850			
	5	NA	NA	35	NA	NA	67	NA	NA	115	NA	NA	183	80	NA	252	255	655	348	317	842	461	433	1,055	594	623	1,518	930			
	10	NA	NA	NA	NA	NA	59	NA	NA	105	NA	NA	170	NA	NA	235	312	622	330	382	806	437	517	1,016	562	733	1,475	875			
	15	NA	NA	NA	NA	NA	NA	NA	NA	95	NA	NA	156	NA	NA	217	NA	NA	311	442	773	414	591	979	539	823	1,434	835			
	20	NA	NA	NA	NA	NA	NA	NA	NA	80	NA	NA	144	NA	NA	202	NA	NA	292	NA	NA	NA	663	944	510	911	1,394	800			
30	2	NA	NA	41	NA	NA	81	NA	NA	136	NA	NA	215	158	578	302	200	759	420	249	982	556	340	1,237	715	489	1,789	1,110			
	5	NA	NA	NA	NA	NA	75	NA	NA	127	NA	NA	196	NA	NA	279	245	737	391	306	958	524	417	1,210	680	600	1,760	1,090			
	10	NA	NA	NA	NA	NA	66	NA	NA	113	NA	NA	182	NA	NA	260	300	703	370	370	920	496	500	1,168	644	708	1,713	1,020			
	15	NA	NA	NA	NA	NA	NA	NA	NA	105	NA	NA	168	NA	NA	240	NA	NA	349	428	884	471	572	1,128	615	798	1,668	975			
	20	NA	NA	NA	NA	NA	NA	NA	NA	88	NA	NA	155	NA	NA	223	NA	NA	327	NA	NA	445	643	327	1,089	585	883	1,624	932		
50	30	NA	NA	NA	NA	NA	NA	NA	NA	NA	NA	NA	NA	NA	NA	182	NA	NA	281	NA	NA	408	NA	NA	544	1055	1,539	865			
	2	NA	NA	NA	NA	NA	91	NA	NA	160	NA	NA	250	NA	NA	350	191	837	475	238	1,103	631	323	1,408	810	463	2,076	1,240			
	5	NA	NA	NA	NA	NA	NA	NA	NA	149	NA	NA	228	NA	NA	321	NA	NA	442	293	1,078	593	398	1,381	770	571	2,044	1,220			
	10	NA	NA	NA	NA	NA	NA	NA	NA	136	NA	NA	212	NA	NA	301	NA	NA	420	355	1,038	562	447	1,337	728	674	1,994	1,140			
	15	NA	NA	NA	NA	NA	NA	NA	NA	124	NA	NA	195	NA	NA	278	NA	NA	395	NA	NA	533	546	1,294	695	761	1,945	1,090			
	20	NA	NA	NA	NA	NA	NA	NA	NA	NA	180	NA	NA	258	NA	NA	370	NA	NA	370	NA	NA	504	616	1,251	660	844	1,898	1,040		
	30	NA	NA	NA	NA	NA	48	NA	NA	NA	NA	NA	NA	NA	NA	NA	NA	318	NA	NA	458	NA	NA	610	1,009	1,805	970				
Minimum Internal Area of Chimney (square inches)		12			19			28			38			50			63			78			95			132					
Maximum Internal Area of Chimney (square inches)		Seven times the listed appliance categorized vent area, flue collar area or draft hood outlet area.																													

**TABLE 504.2(5)
SINGLE-WALL METAL
PIPE OR TYPE B
ASBESTOS CEMENT
VENT**

Number of Appliances	Single
Appliance Type	Draft hoot equipped
Appliance Vent Connection	Connected directly to pipe or vent

HEIGHT (H) (feet)	LATERAL (L) (feet)	VENT DIAMETER – (D) inches							
		3	4	5	6	7	8	10	12
MAXIMUM APPLIANCE INPUT RATING IN THOUSANDS OF BTU/H									
6	0	39	70	116	170	232	312	500	750
	2	31	55	94	141	194	260	415	620
	5	28	51	88	128	177	242	390	600
8	0	42	76	126	185	252	340	542	815
	2	32	61	102	154	210	284	451	680
	5	29	56	95	141	194	264	430	948
	10	24	49	86	131	180	250	406	925
10	0	45	84	138	202	279	372	606	912
	2	35	67	111	168	233	311	505	760
	5	32	61	104	153	215	289	480	724
	10	27	54	94	143	200	274	455	700
	15	NA	46	84	130	186	258	432	666
15	0	49	91	151	223	312	420	684	1,040
	2	39	72	122	186	260	350	570	865
	5	35	67	110	170	240	325	540	825
	10	30	58	103	158	223	308	514	795
	15	NA	50	93	144	207	291	488	760
	20	NA	NA	82	132	195	273	466	726
20	0	53	101	163	252	342	470	770	1,190
	2	42	80	136	210	286	392	641	990
	5	38	74	123	192	264	364	610	945
	10	32	65	115	178	246	345	571	910
	15	NA	55	104	163	228	326	550	870
30	20	NA	NA	91	149	214	306	525	832
	0	56	108	183	276	384	529	878	1,370
	2	44	84	148	230	320	441	730	1,140
	5	NA	78	137	210	296	410	694	1,080
	10	NA	68	125	196	274	388	656	1,050
	15	NA	NA	113	177	258	366	625	1,000
	20	NA	NA	99	163	240	344	596	960
50	30	NA	NA	NA	NA	192	295	540	890
	0	NA	120	210	310	443	590	980	1,550
	2	NA	95	171	260	370	492	820	1,290
	5	NA	NA	159	234	342	474	780	1,230
	10	NA	NA	146	221	318	456	730	1,190
	15	NA	NA	NA	200	292	407	705	1,130
	20	NA	NA	NA	185	276	384	670	1,080
	30	NA	NA	NA	NA	222	330	605	1,010

For SI: 1 inch = 25.4 mm, 1 foot = 304.8 mm, 1 British thermal unit per hour = 0.2931 W.

**TABLE 504.2(6)
EXTERIOR MASONRY
CHIMNEY**

Number of Appliances	Single
Appliance Type	NAT
Appliance Vent Connection	Type B double-wall connector

MINIMUM ALLOWABLE INPUT RATING OF SPACE-HEATING APPLIANCE IN THOUSANDS OF BTU PER HOUR								
VENT HEIGHT (feet)	Internal area of chimney (square inches)							
	12	19	28	38	50	63	78	113
37°F or Greater								
Local 99% Winter Design Temperature: 37°F or Greater								
6	0	0	0	0	0	0	0	0
8	0	0	0	0	0	0	0	0
10	0	0	0	0	0	0	0	0
15	NA	0	0	0	0	0	0	0
20	NA	NA	123	190	249	184	0	0
30	NA	NA	NA	NA	NA	NA	334	0
50	NA	NA	NA	NA	NA	NA	NA	579
27°F to 36°F								
Local 99% Winter Design Temperature: 27°F to 36°F								
6	0	0	68	116	156	180	212	266
8	0	0	82	127	167	187	214	263
10	0	51	97	141	183	201	225	265
15	NA	NA	NA	NA	233	253	274	305
20	NA	NA	NA	NA	NA	307	330	362
30	NA	NA	NA	NA	NA	419	445	485
50	NA	NA	NA	NA	NA	NA	NA	763
17°F to 26°F								
Local 99% Winter Design Temperature: 17°F to 26°F								
6	NA	NA	NA	NA	NA	215	259	349
8	NA	NA	NA	NA	197	226	264	352
10	NA	NA	NA	NA	214	245	278	358
15	NA	NA	NA	NA	NA	296	331	398
20	NA	NA	NA	NA	NA	352	387	457
30	NA	NA	NA	NA	NA	NA	507	581
50	NA	NA	NA	NA	NA	NA	NA	NA
5°F to 16°F								
Local 99% Winter Design Temperature: 5°F to 16°F								
6	NA	NA	NA	NA	NA	NA	NA	416
8	NA	NA	NA	NA	NA	NA	312	423
10	NA	NA	NA	NA	NA	289	331	430
15	NA	NA	NA	NA	NA	NA	393	485
20	NA	NA	NA	NA	NA	NA	450	547
30	NA	NA	NA	NA	NA	NA	NA	682
50	NA	NA	NA	NA	NA	NA	NA	972
-10°F to 4°F								
Local 99% Winter Design Temperature: -10°F to 4°F								
6	NA	NA	NA	NA	NA	NA	NA	484
8	NA	NA	NA	NA	NA	NA	NA	494
10	NA	NA	NA	NA	NA	NA	NA	513
15	NA	NA	NA	NA	NA	NA	NA	586
20	NA	NA	NA	NA	NA	NA	NA	650
30	NA	NA	NA	NA	NA	NA	NA	805
50	NA	NA	NA	NA	NA	NA	NA	1,003
-11°F or Lower								
Local 99% Winter Design Temperature: -11°F or Lower								
Not recommended for any vent configuration								

For SI: °C = (°F - 32)/1.8, 1 inch = 25.4 mm, 1 foot = 304.8 mm, 1 British thermal unit per hour = 0.2931 W.

[Note: See Figure B-19 in Appendix B for a map showing local 99-percent winter design temperatures in the United States.]

504.2.1 Vent obstructions. These venting tables shall not be used where obstructions, as described in Section 503.15, are installed in the venting system. The installation of vents serving listed appliances with vent dampers shall be in accordance with the appliance manufacturer's instructions or in accordance with the following:

1. The maximum capacity of the vent system shall be determined using the "NAT Max" column.
2. The minimum capacity shall be determined as if the appliance were a fan-assisted appliance, using the "FAN Min" column to determine the minimum capacity of the vent system. Where the corresponding "FAN Min" is "NA," the vent configuration shall not be permitted and an alternative venting configuration shall be utilized.

504.2.2 Minimum size. Where the vent size determined from the tables is smaller than the appliance draft hood outlet or flue collar, the smaller size shall be permitted to be used provided that all of the following requirements are met:

1. The total vent height (H) is [~~at least~~] not less than 10 feet (3048 mm).
2. Vents for appliance draft hood outlets or flue collars 12 inches (~~[305]~~ 304.8 mm) in diameter or smaller are not reduced more than one table size.
3. Vents for appliance draft hood outlets or flue collars larger than 12 inches (~~[305]~~ 304.8 mm) in diameter are not reduced more than two table sizes.
4. The maximum capacity listed in the tables for a fan-assisted appliance is reduced by 10 percent (0.90 × maximum table capacity).
5. The draft hood outlet is greater than 4 inches (~~[402]~~ 101.6 mm) in diameter. Do not connect a 3-inch-diameter (~~[76]~~ 76.2 mm) vent to a 4-inch-diameter (~~[402]~~ 101.6 mm) draft hood outlet. This provision shall not apply to fan-assisted appliances.

504.2.3 Vent offsets. Single-appliance venting configurations with zero (0) lateral lengths in Tables 504.2(1), 504.2(2) and 504.2(5) shall not have elbows in the venting system. Single-appliance venting configurations with lateral lengths include two 90-degree (1.57 rad) elbows. For each additional elbow up to and including 45 degrees (0.79 rad), the maximum capacity listed in the venting tables shall be reduced by 5 percent. For each additional elbow greater than 45 degrees (0.79 rad) up to and including 90 degrees (1.57 rad), the maximum capacity listed in the venting tables shall be reduced by 10 percent. Where multiple offsets occur in a vent, the total lateral length of all offsets combined shall not exceed that specified in Tables 504.2(1) through 504.2(5).

504.2.4 Zero lateral. Zero (0) lateral (L) shall apply only to a straight vertical vent attached to a top outlet draft hood or flue collar.

504.2.5 Reserved.

504.2.6 Multiple input rate appliances. For appliances with more than one input rate, the minimum vent capacity (FAN Min) determined from the tables shall be less than the lowest appliance input rating, and the maximum vent capacity (FAN Max/NAT Max) determined from the tables shall be greater than the highest appliance rating input.

504.2.7 Liner system sizing and connections. Listed corrugated metallic chimney liner systems in masonry chimneys shall be sized by using Table 504.2(1) or 504.2(2) for Type B vents with the maximum capacity reduced by 20 percent ($0.80 \times$ maximum capacity) and the minimum capacity as shown in Table 504.2(1) or 504.2(2). Corrugated metallic liner systems installed with bends or offsets shall have their maximum capacity further reduced in accordance with Section 504.2.3. The 20-percent reduction for corrugated metallic chimney liner systems includes an allowance for one long-radius 90-degree (~~1.57~~ 1.57 rad) turn at the bottom of the liner.

Connections between chimney liners and listed double-wall connectors shall be made with listed adapters designed for such purpose.

504.2.8 Vent area and diameter. Where the vertical vent has a larger diameter than the vent connector, the vertical vent diameter shall be used to determine the minimum vent capacity, and the connector diameter shall be used to determine the maximum vent capacity. The flow area of the vertical vent shall not exceed seven times the flow area of the listed appliance categorized vent area, flue collar area [∓] or draft hood outlet area unless designed in accordance with approved engineering methods.

504.2.9 Chimney and vent locations. Tables 504.2(1), 504.2(2), 504.2(3), 504.2(4) and 504.2(5) shall be used only for chimneys and vents not exposed to the outdoors below the roof line. ~~[A Type B vent or listed chimney lining system passing through an unused masonry chimney flue shall not be considered to be exposed to the outdoors. A Type B vent shall not be considered to be exposed to the outdoors where it passes through an unventilated enclosure or chase insulated to a value of not less than R8.]~~ Table 504.2(3) in combination with Table 504.2(6) shall be used for clay-tile-lined exterior masonry chimneys, provided that all of the following are met:

1. Vent connector is a Type B double-wall.
2. Vent connector length is limited to 1½ feet for each inch (~~[18 mm per mm]~~ 18 mm for each mm) of vent connector diameter.
3. The appliance is draft hood equipped.
4. The input rating is less than the maximum capacity given by Table 504.2(3).
5. For a water heater, the outdoor design temperature is not less than 5°F (-15°C).
6. For a space-heating appliance, the input rating is greater than the minimum capacity given by Table 504.2(6).

Where these conditions cannot be met, an alternative venting design shall be used, such as a listed chimney lining system.

Exception: The installation of vents serving listed appliances shall be permitted to be in accordance with the appliance manufacturer's instructions and the terms of the listing.

504.2.10 Corrugated vent connector size. Corrugated vent connectors shall be not smaller than the listed appliance categorized vent diameter, flue collar diameter [∓] or draft hood outlet diameter.

504.2.11 Vent connector size limitation. Vent connectors shall not be increased in size more than two sizes greater than the listed appliance categorized vent diameter, flue collar diameter, or draft hood outlet diameter.

504.2.12 Component commingling. In a single run of vent or vent connector, different diameters and types of vent and connector components shall be permitted to be used, provided that all such sizes and types are permitted by the tables.

504.2.13 Draft hood conversion accessories. Draft hood conversion accessories for use with masonry chimneys venting listed Category I fan-assisted appliances shall be listed and installed in accordance with the manufacturer's ~~installation~~ instructions for such listed accessories.

504.2.14 Table interpolation. Interpolation shall be permitted in calculating capacities for vent dimensions that fall between the table entries.

504.2.15 Extrapolation prohibited. Extrapolation beyond the table entries shall not be permitted.

504.2.16 Engineering calculations. For vent heights less than 6 feet (~~[1829]~~ 1828.8 mm) and greater than shown in the tables, engineering methods shall be used to calculate vent capacities. Signed and sealed calculations shall be submitted with filing application.

504.2.17 Height entries. Where the actual height of a vent falls between entries in the height column of the applicable table in Tables 504.2(1) through 504.2(6), either interpolation shall be used or the lower appliance input rating shown in the table entries shall be used for FAN MAX and NAT MAX column values and the higher appliance input rating shall be used for the FAN MIN column values.

504.3 Application of multiple appliance vent Tables 504.3(1) through ~~[504.3(87)] 504.3(7b).~~ The application of Tables 504.3(1) through 504.3(7) shall be subject to the requirements of Sections 504.3.1 through ~~[504.3.27]~~ 504.3.28.

**TABLE 504.3(1)
TYPE B DOUBLE-WALL VENT**

Number of Appliances	Single
Appliance Type	Category I
Appliance Vent Connection	Type B double-wall connector

VENT CONNECTOR CAPACITY

VENT HEIGHT (H) (feet)	CONNECTOR RISE (R) (feet)	TYPE B DOUBLE-WALL VENT AND CONNECTOR DIAMETER – (D) inches																							
		3			4			5			6			7			8			9			10		
		APPLIANCE INPUT RATING IN THOUSANDS OF BTU/H																							
		FAN		NAT	FAN		NAT	FAN		NAT	FAN		NAT	FAN		NAT	FAN		NAT	FAN		NAT	FAN		NAT
Min	Max	Max	Min	Max	Max	Min	Max	Max	Min	Max	Max	Min	Max	Max	Min	Max	Max	Min	Max	Max	Min	Max	Max		
6	1	22	37	26	35	66	46	46	106	72	58	164	104	77	225	142	92	296	185	109	376	237	128	466	289
	2	23	41	31	37	75	55	48	121	86	60	183	124	79	253	168	95	333	220	112	424	282	131	526	345
	3	24	44	35	38	81	62	49	132	96	62	199	139	82	275	189	97	363	248	114	463	317	134	575	386
8	1	22	40	27	35	72	48	49	114	76	64	176	109	84	243	148	100	320	194	118	408	248	138	507	303
	2	23	44	32	36	80	57	51	128	90	66	195	129	86	269	175	103	356	230	121	454	294	141	564	358
	3	24	47	36	37	87	64	53	139	101	67	210	145	88	290	198	105	384	258	123	492	330	143	612	402
10	1	22	43	28	34	78	50	49	123	78	65	189	113	89	257	154	106	341	200	125	436	257	146	542	314
	2	23	47	33	36	86	59	51	136	93	67	206	134	91	282	182	109	374	238	128	479	305	149	596	372
	3	24	50	37	37	92	67	52	146	104	69	220	150	94	303	205	111	402	268	131	515	342	152	642	417
15	1	21	50	30	33	89	53	47	142	83	64	220	120	88	298	163	110	389	214	134	493	273	162	609	333
	2	22	53	35	35	96	63	49	153	99	66	235	142	91	320	193	112	419	253	137	532	323	165	658	394
	3	24	55	40	36	102	71	51	163	111	68	248	160	93	339	218	115	445	286	140	565	365	167	700	444
20	1	21	54	31	33	99	56	46	157	87	62	246	125	86	334	171	107	436	224	131	552	285	158	681	347
	2	22	57	37	34	105	66	48	167	104	64	259	148	89	354	202	110	463	265	134	587	339	161	725	414
	3	23	60	42	35	110	74	50	176	116	66	271	168	91	371	228	113	486	300	137	618	383	164	764	466
30	1	20	62	33	31	113	59	45	181	93	60	288	134	93	391	182	103	512	238	125	649	305	151	802	372
	2	21	64	39	33	118	70	47	190	110	62	299	158	95	408	215	105	535	282	129	679	360	155	840	439
	3	22	66	44	34	123	79	48	198	124	64	309	178	99	423	242	108	555	317	132	706	405	158	874	494
50	1	19	71	36	30	133	64	43	216	101	57	349	145	89	477	197	97	627	257	120	797	330	144	984	403
	2	21	73	43	32	137	76	45	223	119	59	358	172	91	490	234	100	645	306	123	820	392	148	1,014	478
	3	22	75	48	33	141	86	46	229	134	61	366	194	93	502	263	103	661	3434	126	842	441	151	1,043	538
100	1	18	82	37	28	158	66	40	262	104	53	442	150	73	611	204	91	810	266	112	1,038	341	135	1,285	417
	2	19	83	44	30	161	79	42	267	123	55	447	178	75	619	242	94	822	316	115	1,054	405	139	1,306	494
	3	20	84	50	31	163	89	44	272	138	57	452	109	78	627	272	97	834	955	118	1,069	455	142	1,327	555

COMMON VENT CAPACITY

VENT HEIGHT (H) (feet)	TYPE B DOUBLE-WALL VENT AND CONNECTOR DIAMETER – (D) inches																				
	4			5			6			7			8			9			10		
	COMBINED APPLIANCE INPUT RATING IN THOUSANDS OF BTU/H																				
	FAN +FAN	FAN +NAT	NAT +NAT	FAN +FAN	FAN +NAT	NAT +NAT	FAN +FAN	FAN +NAT	NAT +NAT	FAN +FAN	FAN +NAT	NAT +NAT	FAN +FAN	FAN +NAT	NAT +NAT	FAN +FAN	FAN +NAT	NAT +NAT	FAN +FAN	FAN +NAT	NAT +NAT
6	92	81	65	140	116	103	204	161	147	309	248	200	404	314	260	547	434	335	672	520	410
8	101	90	73	155	129	114	224	178	163	339	275	223	444	348	290	602	480	378	740	577	465
10	110	97	79	169	141	124	243	194	178	367	299	242	477	377	315	649	522	405	800	627	495
15	125	112	91	195	164	144	283	228	206	427	352	280	556	444	365	753	612	465	924	733	565
20	136	123	102	215	183	160	314	255	229	475	394	310	621	499	405	842	688	423	1,035	826	640
30	152	138	118	244	210	185	361	297	266	547	459	360	720	585	470	979	808	605	1,209	975	740
50	167	153	134	279	244	214	421	353	310	641	547	423	854	706	550	1,164	977	705	1,451	1,188	860
100	175	163	NA	311	277	NA	489	421	NA	751	658	479	1,025	873	625	1,408	1,215	800	1,784	1,502	975

(continued)

**TABLE 504.3(1)-continued
TYPE B DOUBLE-WALL
VENT**

Number of Appliances	Two or more
Appliance Type	Category I
Appliance Vent Connection	Type B double-wall connector

VENT CONNECTOR CAPACITY																													
VENT HEIGHT (H) (feet)	CONNECTOR RISE (R) (feet)	APPLIANCE INPUT RATING LIMITS IN THOUSANDS OF BTU/H																											
		12				14				16				18				20				22				24			
		FAN		N A T	FAN		N A T	FAN		N A T	FAN		N A T	FAN		N A T	FAN		N A T	FAN		N A T	FAN		N A T				
		Min	Max	Max	Min	Max	Max	Min	Max	Max	Min	Max	Max	Min	Max	Max	Min	Max	Max	Min	Max	Max	Min	Max	Max				
6	2	174	764	49 6	22 3	1,0 46	56 3	28 1	1,3 71	85 3	34 5	1,7 32	1,0 80	N A	N A	N A	N A	NA	N A	N A	N A	N A	N A						
	4	180	897	61 6	23 0	1,2 31	82 7	28 1,6	1,3 17	85 1,0	34 2	1,7 69	1,0 70	N A	N A	N A	N A	NA	N A	N A	N A	N A	N A						
	6	NA	NA	N A	N A	N A	N A	N A	N A	N A	N A	N A	N A	N A	N A	N A	N A	NA	N A	N A	N A	N A	N A						
8	2	186	822	51 6	23 8	1,1 26	69 6	29 8	1,4 78	91 0	36 5	1,9 20	1,1 50	N A	N A	N A	N A	NA	N A	N A	N A	N A	N A						
	4	192	952	64 4	21 07	1,3 4	88 5	30 1,9	1,1 50	1,1 2	37 11	2,2 60	1,4 1	47 37	2,7 00	1,8 00	56 9	3,31 2,6	2,1 80	66 2	3,9 57	2,5 90	3,1 90						
	6	198	1,050	77 2	25 2	1,4 45	1,0 72	31 3	1,9 02	1,3 90	38 0	2,4 34	1,8 70	47 8	3,0 18	80 8	2,1 8	56 5	3,66 40	66 8	4,3 73	3,1 30	3,1 30						
10	2	196	870	53 6	24 9	1,1 95	73 0	31 1	1,5 70	95 5	37 9	2,0 49	0,2 05	N A	N A	N A	N A	NA	N A	N A	N A	N A	N A						
	4	201	997	66 4	25 6	1,3 71	92 4	31 8	1,8 04	1,2 05	38 7	2,3 32	1,5 6	48 87	2,8 90	1,8 90	58 1	3,50 2	2,2 2,7	68 6	4,1 75	2,7 10	2,7 10						
	6	207	1,095	79 2	26 3	1,5 09	1,1 18	32 5	1,9 89	1,4 55	39 5	2,5 56	1,8 65	49 4	2,3 09	2,2 90	58 9	3,84 9	2,7 60	69 4	4,5 93	3,2 70	3,2 70						
15	2	214	967	56 8	23 51	1,3 51	79 6	33 1,7	1,2 05	40 8	2,3 17	1,3 03	N A	N A	N A	N A	NA	N A	N A	N A	N A	N A	N A						
	4	221	1,085	71 5	27 9	1,4 99	1,0 06	34 4	1,9 78	1,3 20	41 6	2,5 79	1,6 65	52 3	3,1 97	2,0 50	62 4	3,88 1	2,4 90	73 4	4,6 31	2,9 60	2,9 60						
	6	228	1,181	85 6	28 32	1,6 32	1,2 22	35 1	2,1 57	1,6 4	42 4	2,7 96	2,0 25	53 3	3,4 70	2,5 10	63 10	4,21 6	3,0 90	74 3	5,3 35	3,6 00	3,6 00						
20	2	223	1,051	99 6	29 1	1,4 63	84 0	35 7	1,9 11	1,0 95	43 0	2,5 33	1,3 85	N A	N A	N A	N A	NA	N A	N A	N A	N A	N A						
	4	230	1,162	74 8	29 8	1,5 97	1,0 54	36 5	2,1 16	1,3 95	43 8	2,7 78	1,7 65	55 4	3,4 47	2,1 80	65 1	4,19 0	2,6 30	77 2	5,0 05	3,1 90	3,1 90						
	6	237	1,253	90 0	30 7	1,7 26	1,2 88	37 3	2,2 87	1,6 95	45 0	2,9 84	2,1 45	56 7	3,7 08	2,6 90	67 1	4,51 1	3,1 90	78 5	5,3 92	3,7 90	3,7 90						
30	2	216	1,217	63 2	28 6	1,6 64	91 0	36 7	2,1 83	1,1 90	46 1	2,8 91	1,3 40	N A	N A	N A	N A	NA	N A	N A	N A	N A	N A						
	4	223	1,316	79 2	29 4	1,8 02	1,1 60	37 6	2,3 66	1,5 10	47 4	3,1 10	1,9 20	61 9	3,8 40	2,3 65	72 8	4,86 1	2,8 60	84 7	5,6 06	3,4 10	3,4 10						
	6	231	1,400	95 2	30 3	1,9 20	1,4 10	38 4	2,5 24	1,8 30	48 5	3,2 99	2,3 40	63 2	4,0 80	2,8 75	74 0	4,97 6	3,4 80	86 0	5,9 51	4,1 50	4,1 50						
50	2	206	1,479	68 9	27 3	2,0 23	1,0 07	35 0	2,6 59	1,3 15	43 5	3,5 48	1,6 65	N A	N A	N A	N A	NA	N A	N A	N A	N A	N A						
	4	213	1,561	86 0	28 1	2,1 99	1,2 91	35 9	2,8 14	1,6 85	44 7	3,7 30	2,1 35	58 0	4,6 01	2,6 33	70 9	5,56 0	3,1 85	85 1	6,6 33	3,7 90	3,7 90						
	6	221	1,630	1,0 31	29 0	2,2 42	1,5 75	36 9	2,9 51	1,0 55	46 1	3,8 93	2,6 05	59 4	4,8 08	3,2 08	72 4	5,82 0	3,8 85	86 7	6,9 43	4,6 20	4,6 20						
100	2	192	1,923	71 2	25 4	2,6 44	1,0 50	32 6	3,4 90	1,3 70	40 2	4,7 07	1,7 40	N A	N A	N A	N A	NA	N A	N A	N A	N A	N A						
	4	200	1,984	88 8	26 3	2,7 31	1,3 46	33 6	3,6 06	1,7 40	41 4	4,8 42	2,2 20	5,9 3	2,7 82	2,7 50	63 9	7,25 4	3,3 30	76 9	8,6 30	3,9 50	3,9 50						
	6	208	2,035	1,0 64	27 2	2,8 11	1,6 42	34 6	3,7 14	2,1 50	42 6	4,9 68	2,7 00	59 9	6,1 43	3,3 50	65 4	7,45 3	4,0 70	78 6	8,8 92	4,8 10	4,8 10						

COMMON VENT CAPACITY

VENT HEIGHT (H) (feet)	TYPE B DOUBLE-WALL VENT AND CONNECTOR DIAMETER – (D) inches																				
	12			14			16			18			20			22			24		
	COMBINED APPLIANCE INPUT RATING IN THOUSANDS OF BTU/H																				
	FAN +FAN	FAN +NAT	NAT +NAT	FAN +FAN	FAN +NAT	NAT +NAT	FAN +FAN	FAN +NAT	NAT +NAT	FAN +FAN	FAN +NAT	NAT +NAT	FAN +FAN	FAN +NAT	NAT +NAT	FAN +FAN	FAN +NAT	NAT +NAT	FAN +FAN	FAN +NAT	NAT +NAT
6	900	696	588	1,284	990	815	1,735	1,336	1,065	2,253	1,732	1,345	2,838	2,180	1,660	3,488	2,677	1,970	4,205	3,226	2,390
8	994	773	652	1,423	1,103	912	1,927	1,491	1,190	2,507	1,936	1,510	3,162	2,439	1,860	3,890	2,998	2,200	4,695	3,616	2,680
10	1,076	941	712	1,542	1,200	995	2,093	1,625	1,500	2,727	2,113	1,645	3,444	2,665	2,030	4,241	3,278	2,400	5,123	3,957	2,920
15	1,247	986	825	1,794	1,410	1,158	2,440	1,910	1,510	3,184	2,484	1,910	4,026	3,133	2,160	4,971	3,862	2,790	6,016	4,670	9,400
20	1,405	1,116	916	2,006	1,588	1,290	2,722	2,147	1,690	3,561	2,798	2,140	4,548	3,552	2,640	5,573	4,332	3,120	6,749	5,231	3,800
30	1,658	1,325	1,025	2,373	1,892	1,525	3,220	2,558	1,990	4,197	3,326	2,520	5,303	4,193	3,110	6,539	5,157	3,680	7,940	6,247	4,430
50	2,024	1,640	1,280	2,911	2,347	1,863	3,964	3,183	2,430	5,184	4,149	3,075	6,567	5,240	3,800	8,116	6,458	4,500	9,837	7,813	5,475
100	2,569	2,131	1,670	3,732	3,076	2,450	5,125	4,202	3,200	6,749	5,509	4,050	8,897	6,986	5,000	10,681	8,648	5,920	13,704	10,439	7,200

For SI: 1 inch = 25.4 mm, 1 foot = 304.8 mm, 1 British thermal unit per hour = 0.2931 W.

**TABLE 504.3(2)
TYPE B DOUBLE-WALL
VENT**

Number of Appliances	Two or more
Appliance Type	Category I
Appliance Vent	Single-wall metal
Connection	connector

**VENT CONNECTOR
CAPACITY**

VENT HEIGHT (H) (feet)	CONNECTOR RISE (R) (feet)	SINGLE-WALL METAL VENT CONNECTOR DIAMETER – (D) inches																							
		3			4			5			6			7			8			9			10		
		APPLIANCE INPUT RATING IN THOUSANDS OF BTU/H																							
		FAN	NAT	FAN	NAT	FAN	NAT	FAN	NAT	FAN	NAT	FAN	NAT	FAN	NAT	FAN	NAT	FAN	NAT	FAN	NAT				
		Min	Max	Max	Min	Max	Min	Max	Max	Min	Max	Max	Min	Max	Max	Min	Max	Max	Min	Max	Max	Min	Max	Max	
6	1	NA	NA	26	NA	NA	46	NA	NA	71	NA	NA	102	207	223	140	262	293	183	325	373	234	447	463	286
	2	NA	NA	31	NA	NA	55	NA	NA	85	168	182	123	215	251	167	271	331	219	334	422	287	458	524	344
	3	NA	NA	34	NA	NA	62	NA	NA	131	93	175	198	138	222	273	188	279	361	247	344	462	316	468	574
8	1	NA	NA	27	NA	NA	48	NA	NA	75	NA	NA	106	226	240	145	285	316	191	352	403	244	481	502	299
	2	NA	NA	32	NA	NA	57	125	126	89	181	193	127	234	266	173	293	353	228	360	450	292	492	560	355
	3	NA	NA	35	NA	NA	64	130	138	100	181	208	144	241	287	197	302	381	256	370	489	328	501	600	400
10	1	NA	NA	28	NA	NA	50	119	121	77	182	186	110	260	253	150	302	335	196	372	429	252	506	534	308
	2	NA	NA	33	84	85	59	124	134	91	189	203	132	248	278	183	311	369	235	381	473	302	517	589	368
	3	NA	NA	36	89	91	67	129	144	102	197	217	148	258	299	203	320	398	255	391	511	339	528	637	413
15	1	NA	NA	29	79	87	52	116	138	81	177	214	116	238	291	158	312	380	208	397	452	266	556	596	324
	2	NA	NA	34	85	94	62	121	150	97	185	230	138	246	314	189	321	411	248	407	522	317	568	646	387
	3	NA	NA	39	87	100	70	127	160	109	193	243	157	255	333	215	831	438	281	418	557	360	579	690	437
20	1	49	56	30	78	97	54	115	152	84	175	238	120	233	323	165	306	425	217	390	539	276	546	664	336
	2	52	59	36	82	103	64	120	163	101	182	252	144	243	306	191	317	453	259	400	574	331	558	709	403
	3	55	62	40	87	107	72	125	172	113	190	264	164	252	363	223	326	476	294	412	607	375	570	750	457
30	1	47	60	31	77	110	57	112	175	89	169	278	129	226	380	175	296	497	230	378	630	294	528	779	358
	2	51	62	37	81	115	67	117	185	106	177	290	152	236	397	208	307	521	274	389	662	349	541	817	425
	3	54	64	42	85	119	76	122	193	120	185	300	172	244	412	235	316	542	309	400	690	394	555	855	482
50	1	46	69	34	75	128	60	109	207	96	162	336	137	217	460	188	284	604	245	364	768	314	507	951	384
	2	49	71	40	79	132	72	114	215	113	170	345	164	226	473	223	294	523	293	376	793	375	520	983	458
	3	52	72	45	83	136	82	119	221	123	178	353	186	235	486	252	304	640	331	387	816	423	535	1,013	518
100	1	45	79	34	71	150	61	104	249	98	153	424	100	205	585	192	269	714	240	345	993	321	476	1,236	393
	2	48	80	41	75	153	73	110	255	115	160	428	167	212	593	228	279	758	299	358	1,011	383	490	1,259	469
	3	51	81	46	79	157	85	114	260	129	168	433	190	222	603	256	289	807	339	368	1,027	431	506	1,280	527

COMMON VENT CAPACITY

VENT HEIGHT (H) (feet)	TYPE B DOUBLE-WALL VENT AND CONNECTOR DIAMETER – (D) inches																				
	4		5		6		7		8		9		10								
	COMBINED APPLIANCE INPUT RATING IN THOUSANDS OF BTU/H																				
	FAN +FAN	FAN +NAT	NAT +NAT	FAN +FAN	FAN +NAT	NAT +NAT	FAN +FAN	FAN +NAT	NAT +NAT	FAN +FAN	FAN +NAT	NAT +NAT	FAN +FAN	FAN +NAT	NAT +NAT	FAN +FAN	FAN +NAT	NAT +NAT	FAN +FAN	FAN +NAT	NAT +NAT
6	NA	78	64	NA	115	99	200	158	144	304	244	196	398	310	257	541	429	332	665	515	407
8	NA	87	71	NA	126	111	218	173	159	331	269	218	436	342	285	592	473	373	730	569	460
10	NA	94	76	163	137	120	237	189	174	357	292	236	467	369	309	638	512	398	787	617	487
15	121	108	88	189	159	140	275	221	200	416	343	274	544	434	357	738	599	456	905	718	553
20	131	138	98	208	177	156	305	247	223	463	383	302	606	487	395	824	673	512	1,013	808	626
30	145	132	113	236	202	180	350	286	257	535	446	349	703	570	459	958	790	593	1,183	952	723
50	159	145	128	268	233	208	406	337	296	622	527	410	833	686	535	1,139	954	689	1,418	1,157	838
100	166	153	NA	297	263	NA	469	398	NA	726	603	464	999	846	606	1,378	1,185	780	1,741	1,459	948

For SI: 1 inch = 25.4 mm, 1 foot = 304.8 mm, 1 British thermal unit per hour = 0.2931 W.

Number of Appliances	Two or more
Appliance Type	Category I
Appliance Vent Connection	Type B double-wall connector

**TABLE 504.3(3)
MASONRY CHIMNEY**

VENT CONNECTOR CAPACITY

VENT HEIGHT (H) (feet)	CONNECTOR RISE (R) (feet)	TYPE B DOUBLE-WALL VENT CONNECTOR DIAMETER – (D) inches																									
		3			4			5			6			7			8			9			10				
		APPLIANCE INPUT RATING IN THOUSANDS OF BTU/H																									
		FAN		NAT		FAN		NAT		FAN		NAT		FAN		NAT		FAN		NAT		FAN		NAT		FAN	
Min	Max	Min	Max	Min	Max	Min	Max	Min	Max	Min	Max	Min	Max	Min	Max	Min	Max	Min	Max	Min	Max	Min	Max	Min	Max	Min	Max
6	1	24	33	21	39	62	40	52	106	67	65	194	101	87	274	141	104	370	201	124	479	253	145	599	319		
	2	26	43	28	41	79	52	53	135	85	67	230	124	89	324	173	107	436	232	127	562	300	148	694	378		
	3	27	49	34	42	92	61	55	155	97	69	262	143	91	369	200	109	491	270	129	533	349	151	795	439		
8	1	24	39	22	39	72	41	55	117	69	71	213	105	94	304	148	113	414	210	134	539	267	156	682	335		
	2	26	47	29	40	87	53	57	140	16	73	246	127	97	350	179	116	473	240	137	615	311	160	776	394		
	3	27	52	34	42	97	62	59	159	98	75	269	145	99	383	206	119	517	276	139	572	358	163	848	452		
10	1	24	42	22	38	80	42	55	130	71	74	232	108	101	324	153	120	444	216	142	582	277	165	739	348		
	2	26	50	29	40	93	54	57	153	87	76	264	129	103	366	184	123	498	247	145	652	321	168	825	407		
	3	27	55	35	41	105	63	58	170	100	78	284	148	106	397	209	126	540	281	147	705	366	171	893	463		
15	1	24	48	23	38	93	44	54	154	74	72	277	114	100	384	161	125	511	229	153	658	297	184	824	375		
	2	25	55	31	39	105	55	56	174	89	74	299	134	103	419	182	128	558	260	156	718	339	187	900	452		
	3	26	59	35	41	115	64	57	189	102	76	319	153	105	448	215	131	597	292	189	760	382	180	960	486		
20	1	24	52	24	37	102	46	53	172	77	71	313	119	98	437	173	123	584	239	150	752	312	180	943	397		
	2	25	58	31	39	114	56	55	190	91	73	335	138	101	467	199	126	625	270	153	805	354	184	1,011	452		
	3	26	63	35	40	123	65	57	204	104	75	353	157	104	493	222	129	661	301	156	851	396	187	1,067	505		
30	1	24	54	25	37	111	48	52	182	82	69	357	127	96	504	187	119	680	255	145	883	337	175	1,115	432		
	2	25	60	32	38	132	58	54	208	95	72	376	145	99	531	209	122	715	287	149	928	378	179	1,171	484		
	3	26	64	36	40	131	66	56	221	107	74	392	163	101	554	233	125	746	317	152	968	418	182	1,220	535		
50	1	23	51	25	36	116	51	51	209	89	67	408	143	92	582	213	115	798	294	140	1,049	392	168	1,334	506		
	2	24	59	32	37	127	61	53	225	102	70	421	161	95	604	235	118	827	326	143	1,085	433	172	1,379	558		
	3	26	64	36	39	135	69	55	237	115	72	435	180	98	624	260	121	854	357	147	1,118	474	176	1,421	611		
100	1	23	46	24	35	108	50	49	208	92	65	428	155	88	640	237	109	907	334	134	1,222	454	161	1,589	596		
	2	24	53	31	37	120	60	51	224	105	67	444	174	92	660	260	113	933	368	138	1,253	497	165	1,626	651		
	3	25	59	35	38	130	68	53	237	118	69	458	193	94	679	285	116	936	399	141	1,282	540	169	1,661	705		

COMMON VENT CAPACITY

VENT HEIGHT (H) (feet)	MINIMUM INTERNAL AREA OF MASONRY CHIMNEY FLUE (square inches)																									
	12			19			28			38			50			63			78			113				
	COMBINED APPLIANCE INPUT RATING IN THOUSANDS OF BTU/H																									
	FAN	FAN	NAT	FAN	FAN	NAT	FAN	FAN	NAT	FAN	FAN	NAT	FAN	FAN	NAT	FAN	FAN	NAT	FAN	FAN	NAT	FAN	FAN	NAT	FAN	FAN
6	NA	74	25	NA	119	46	NA	178	71	NA	257	103	NA	351	143	NA	458	188	NA	582	246	1,041	853	NA		
8	NA	80	28	NA	130	53	NA	193	82	NA	279	119	NA	384	163	NA	501	218	724	636	278	1,144	937	408		
10	NA	84	31	NA	138	56	NA	207	90	NA	299	131	NA	409	177	605	538	236	776	686	302	1,226	1,010	454		
15	NA	NA	36	NA	152	67	NA	233	106	NA	334	152	523	467	212	682	611	283	874	781	365	1,374	1,156	546		
20	NA	NA	41	NA	NA	75	NA	250	122	NA	368	172	565	508	243	743	668	325	955	858	419	1,513	1,286	648		
30	NA	NA	NA	NA	NA	NA	NA	270	137	NA	404	198	615	564	278	816	747	381	1,062	969	496	1,702	1,473	749		
50	NA	NA	NA	NA	NA	NA	NA	NA	NA	NA	NA	NA	NA	620	328	879	831	461	1,165	1,039	606	1,900	1,692	922		
100	NA	NA	NA	NA	NA	NA	NA	NA	NA	NA	NA	NA	NA	NA	348	NA	NA	499	NA	NA	669	1,053	1,921	1,058		

For SI: 1 inch = 25.4 mm, 1 square inch = 645.16 mm², 1 foot = 304.8mm, 1 British thermal unit per hour = 0.2931 W.

Number of Appliances	Two or more
Appliance Type	Category I
Appliance Vent Connection	Single-wall metal connector

**TABLE 504.3(4)
MASONRY CHIMNEY**

VENT CONNECTOR CAPACITY

VENT HEIGHT (H) (feet)	CONNECTOR RISE (R) (feet)	SINGLE-WALL METAL VENT CONNECTOR DIAMETER – (D) inches																										
		3		4			5			6			7			8			9			10						
		APPLIANCE INPUT RATING IN THOUSANDS OF BTU/H																										
		FAN		NAT		FAN		NAT		FAN		NAT		FAN		NAT		FAN		NAT		FAN		NAT		FAN		NAT
Min	Max	Max	Min	Max	Ma40x52	Min	Max	Max	Min	Max	Max	Min	Max	Max	Min	Max	Max	Min	Max	Max	Min	Max	Max	Min	Max	Max	Min	Max
6	1	NA	NA	21	NA	NA	39	NA	NA	66	179	191	100	231	271	140	292	365	200	362	474	252	499	594	316			
	2	NA	NA	28	NA	NA	52	NA	NA	84	136	227	123	239	321	172	301	432	231	373	557	299	509	696	376			
	3	NA	NA	34	NA	NA	61	134	153	97	193	258	142	247	365	202	309	491	263	381	634	348	519	703	437			
8	1	NA	NA	21	NA	NA	40	NA	NA	68	195	108	103	250	298	146	313	407	207	387	530	263	529	672	331			
	2	NA	NA	28	NA	NA	52	137	139	85	202	240	125	258	343	177	323	465	238	397	607	309	540	766	391			
	3	NA	NA	34	NA	NA	62	143	156	98	210	264	145	266	376	205	332	509	274	407	663	356	551	838	450			
10	1	NA	NA	22	NA	NA	41	130	151	70	202	225	106	267	316	151	333	434	213	410	571	273	558	727	343			
	2	NA	NA	29	NA	NA	53	136	150	86	210	255	128	276	358	181	346	489	244	420	640	317	569	813	403			
	3	NA	NA	34	97	102	62	143	166	99	217	277	147	284	389	207	352	530	279	430	694	363	580	880	459			
15	1	NA	NA	23	NA	NA	43	129	151	73	199	271	112	268	376	161	349	502	225	445	646	291	623	808	366			
	2	NA	NA	60	92	103	54	135	170	88	207	295	132	277	411	189	359	548	256	456	706	334	634	884	424			
	3	NA	NA	34	96	112	63	141	185	101	215	315	151	286	439	213	358	585	289	466	735	378	646	945	479			
20	1	NA	NA	23	87	99	45	128	167	76	197	303	117	265	425	169	345	569	235	439	734	306	614	920	347			
	2	NA	NA	30	91	111	55	134	185	90	205	325	136	274	455	195	355	610	266	450	787	348	627	986	443			
	3	NA	NA	35	96	119	64	140	199	103	213	343	154	282	481	219	363	644	298	461	831	391	639	1,042	496			
30	1	NA	NA	24	86	108	47	126	187	80	193	347	124	259	402	183	338	665	250	430	864	330	600	1,089	421			
	2	NA	NA	31	91	119	57	132	203	93	201	366	142	269	518	205	348	699	282	442	908	372	613	1,145	473			
	3	NA	NA	35	95	127	65	138	216	105	209	381	160	277	540	229	358	729	312	452	946	412	626	1,193	524			
50	1	NA	NA	24	85	113	50	124	204	87	188	392	139	252	567	208	328	778	287	417	1,022	383	582	1,302	492			
	2	NA	NA	31	89	123	60	130	218	100	196	408	158	262	588	230	339	805	320	429	1,058	425	595	1,346	545			
	3	NA	NA	35	94	131	68	136	231	112	205	422	176	271	607	255	349	731	351	440	1,090	456	610	1,386	587			
100	1	NA	NA	23	84	104	49	122	200	89	182	410	151	243	617	232	315	875	328	402	1,181	444	560	1,537	580			
	2	NA	NA	30	88	115	59	127	215	102	190	425	169	253	636	254	326	899	361	415	1,200	438	575	1,570	634			
	3	NA	NA	34	93	124	67	133	228	115	199	438	188	262	654	279	337	921	392	427	1,238	529	589	1,604	687			

COMMON VENT CAPACITY

VENT HEIGHT (H) (feet)	MINIMUM INTERNAL AREA OF MASONRY CHIMNEY FLUE (square inches)																									
	12		19			28			38			50			63			78			113					
	COMBINED APPLIANCE INPUT RATING IN THOUSANDS OF BTU/H																									
	FAN	FAN	NAT	FAN	FAN	NAT	FAN	FAN	NAT	FAN	FAN	NAT	FAN	FAN	NAT	FAN	FAN	NAT	FAN	FAN	NAT	FAN	FAN	NAT	FAN	FAN
+FAN	+NAT	+NAT	+FAN	+NAT	+NAT	+FAN	+NAT	+NAT	+FAN	+NAT	+NAT	+FAN	+NAT	+NAT	+FAN	+NAT	+NAT	+FAN	+NAT	+NAT	+FAN	+NAT	+NAT	+FAN	+NAT	+NAT
6	NA	NA	25	NA	118	45	NA	176	71	NA	255	102	NA	348	142	NA	455	187	NA	579	245	NA	846	NA		
8	NA	NA	28	NA	128	52	NA	150	81	NA	275	118	NA	380	162	NA	497	217	NA	633	277	1,136	928	405		
10	NA	NA	31	NA	136	56	NA	205	89	NA	295	129	NA	405	175	NA	532	234	171	680	300	1,216	1,000	450		
15	NA	NA	36	NA	NA	65	NA	230	105	NA	335	150	NA	400	210	677	602	280	866	772	360	1,359	1,139	540		
20	NA	NA	NA	NA	NA	74	NA	247	120	NA	362	170	NA	503	240	765	661	321	947	849	415	1,495	1,264	640		
30	NA	NA	NA	NA	NA	NA	NA	135	NA	NA	398	195	NA	558	275	808	739	377	1,052	957	490	1,682	1,447	740		
50	NA	NA	NA	NA	NA	NA	NA	NA	NA	NA	NA	NA	NA	612	325	NA	NA	456	1,152	1,076	600	1,879	1,672	910		
100	NA	NA	NA	NA	NA	NA	NA	NA	NA	NA	NA	NA	NA	NA	NA	NA	NA	494	NA	NA	663	2,006	1,835	1,046		

For SI: 1 inch = 25.4 mm, 1 square inch = 645.16 mm², 1 foot = 304.8mm, 1 British thermal unit per hour = 0.2931 W.

**TABLE 504.3(6b)
EXTERIOR MASONRY
CHIMNEY**

Number of Appliances	Two or more
Appliance Type	NAT + NAT
Appliance Vent Connection	Type B double-wall connector

Minimum Allowable Input Rating of Space-heating Appliance in Thousands of Btu per Hour

VENT HEIGHT (feet)	INTERNAL AREA OF CHIMNEY (square inches)							
	12	19	28	38	50	63	78	113
37°F or Greater Local 99% Winter Design Temperature: 37°F or Greater								
6	0	0	0	0	0	0	0	NA
8	0	0	0	0	0	0	0	0
10	0	0	0	0	0	0	0	0
15	NA	0	0	0	0	0	0	0
20	NA	NA	NA	NA	NA	184	0	0
30	NA	NA	NA	NA	NA	393	334	0
50	NA	NA	NA	NA	NA	NA	NA	579
100	NA	NA	NA	NA	NA	NA	NA	NA
27°F to 36°F Local 99% Winter Design Temperature: 27°F to 36°F								
6	0	0	68	NA	NA	180	212	NA
8	0	0	85	NA	NA	187	214	263
10	0	51	NA	NA	NA	201	225	265
15	NA	NA	NA	NA	NA	253	274	305
20	NA	NA	NA	NA	NA	307	330	362
30	NA	NA	NA	NA	NA	NA	445	485
50	NA	NA	NA	NA	NA	NA	NA	763
100	NA	NA	NA	NA	NA	NA	NA	NA
17°F to 26°F Local 99% Winter Design Temperature: 17°F to 26°F								
6	NA	NA	NA	NA	NA	NA	NA	NA
8	NA	NA	NA	NA	NA	NA	264	352
10	NA	NA	NA	NA	NA	NA	278	358
15	NA	NA	NA	NA	NA	NA	331	398
20	NA	NA	NA	NA	NA	NA	387	457
30	NA	NA	NA	NA	NA	NA	NA	581
50	NA	NA	NA	NA	NA	NA	NA	862
100	NA	NA	NA	NA	NA	NA	NA	NA
5°F to 16°F Local 99% Winter Design Temperature: 5°F to 16°F								
6	NA	NA	NA	NA	NA	NA	NA	NA
8	NA	NA	NA	NA	NA	NA	NA	NA
10	NA	NA	NA	NA	NA	NA	NA	430
15	NA	NA	NA	NA	NA	NA	NA	485
20	NA	NA	NA	NA	NA	NA	NA	547
30	NA	NA	NA	NA	NA	NA	NA	682
50	NA	NA	NA	NA	NA	NA	NA	NA
100	NA	NA	NA	NA	NA	NA	NA	NA
4°F or Lower Local 99% Winter Design Temperature: 4°F or Lower Not recommended for any vent configurations								

For SI: °C = (°F - 32)/1.8, 1 inch = 25.4 mm, 1 square inch = 615.16 mm², 1 foot = 304.8 mm, 1 British thermal unit per hour = 0.2931 W.
[Note: See Figure B-19 in Appendix B for a map showing local 99-percent winter design temperatures in the United States.]

-10°F to 4°F		Local 99% Winter Design Temperature: -10°F to 4°F						
6	NA	NA	145	196	249	296	349	484
8	NA	NA	159	213	269	320	371	494
10	NA	NA	175	231	292	339	397	513
15	NA	NA	NA	283	351	404	457	586
20	NA	NA	NA	333	408	468	528	650
30	NA	NA	NA	NA	NA	603	667	805
50	NA	NA	NA	NA	NA	NA	955	1,003
100	NA	NA	NA	NA	NA	NA	NA	NA
-11°F or Lower		Local 99% Winter Design Temperature: -11°F or Lower						
Not recommended for any vent configurations								

For SI: °C = (°F - 32)/1.8, 1 inch = 25.4 mm, 1 square inch = 615.16 mm², 1 foot = 304.8 mm, 1 British thermal unit per hour = 0.2931 W.

[Note: See Figure B-19 in Appendix B for a map showing local 99-percent winter design temperatures in the United States.]

504.3.1 Vent obstructions. These venting tables shall not be used where obstructions, as described in Section 503.15, are installed in the venting system. The installation of vents serving listed appliances with vent dampers shall be in accordance with the appliance manufacturer's instructions or in accordance with the following:

1. The maximum capacity of the vent connector shall be determined using the NAT Max column.
2. The maximum capacity of the vertical vent or chimney shall be determined using the FAN+NAT column when the second appliance is a fan-assisted appliance, or the NAT+NAT column when the second appliance is equipped with a draft hood.
3. The minimum capacity shall be determined as if the appliance were a fan-assisted appliance.
 - 3.1. The minimum capacity of the vent connector shall be determined using the FAN Min column.
 - 3.2. The FAN+FAN column shall be used where the second appliance is a fan-assisted appliance, and the FAN+NAT column shall be used where the second appliance is equipped with a draft hood, to determine whether the vertical vent or chimney configuration is not permitted (NA). Where the vent configuration is NA, the vent configuration shall not be permitted and an alternative venting configuration shall be utilized.

504.3.2 Connector length limit. The vent connector shall be routed to the vent utilizing the shortest possible route. Except as provided in Section 504.3.3, the maximum vent connector horizontal length shall be 1½ feet for each inch (~~[18 mm per mm]~~ 18 mm for each mm) of connector diameter as shown in Table 504.3.2.

TABLE 504.3.2 MAXIMUM VENT CONNECTOR LENGTH	
CONNECTOR DIAMETER [MAXIMUM] (inches)	CONNECTOR <u>MAXIMUM</u> HORIZONTAL LENGTH (feet)
3	4½
4	6
5	7½
6	9
7	10½
8	12
9	13½
10	15
12	18
14	21
16	24
18	27
20	30
22	33
24	36

For SI: 1 inch = 25.4 mm, 1 foot = 304.8 mm.

504.3.3 Connectors with longer lengths. Connectors with longer horizontal lengths than those listed in Section 504.3.2 are permitted under the following conditions:

1. The maximum capacity (FAN Max or NAT Max) of the vent connector shall be reduced 10 percent for each additional multiple of the length allowed by Section 504.3.2. For example, the maximum length listed in Table 504.3.2 for a 4-inch (~~[402]~~ 101.6 mm) connector is 6 feet (1829 mm). With a connector length greater than 6 feet (~~[1829]~~ 1828.8 mm) but not exceeding 12 feet (~~[3658]~~ 3657.6 mm), the maximum capacity must be reduced by 10 percent ($0.90 \times$ maximum vent connector capacity). With a connector length greater than 12 feet (~~[3658]~~ 3657.6 mm) but not exceeding 18 feet (5486 mm), the maximum capacity must be reduced by 20 percent ($0.80 \times$ maximum vent capacity).
2. For a connector serving a fan-assisted appliance, the minimum capacity (FAN Min) of the connector shall be determined by referring to the corresponding single appliance table. For Type B double-wall connectors, Table 504.2(1) shall be used. For single-wall connectors, Table 504.2(2) shall be used. The height (H) and lateral (L) shall be measured according to the procedures for a single-appliance vent, as if the other appliances were not present.

504.3.4 Vent connector manifold. Where the vent connectors are combined prior to entering the vertical portion of the common vent to form a common vent manifold, the size of the common vent manifold and the common vent shall be determined by applying a 10[-]percent

reduction ($0.90 \times$ maximum common vent capacity) to the common vent capacity part of the common vent tables. The length of the common vent connector manifold (~~[L_M]~~ L_M) shall not exceed 1½ feet for each inch (~~[457 mm for each 25.4 mm]~~ [18 mm per mm] 18 mm for each mm) of common vent connector manifold diameter (D) (see Figure 504.3.4).

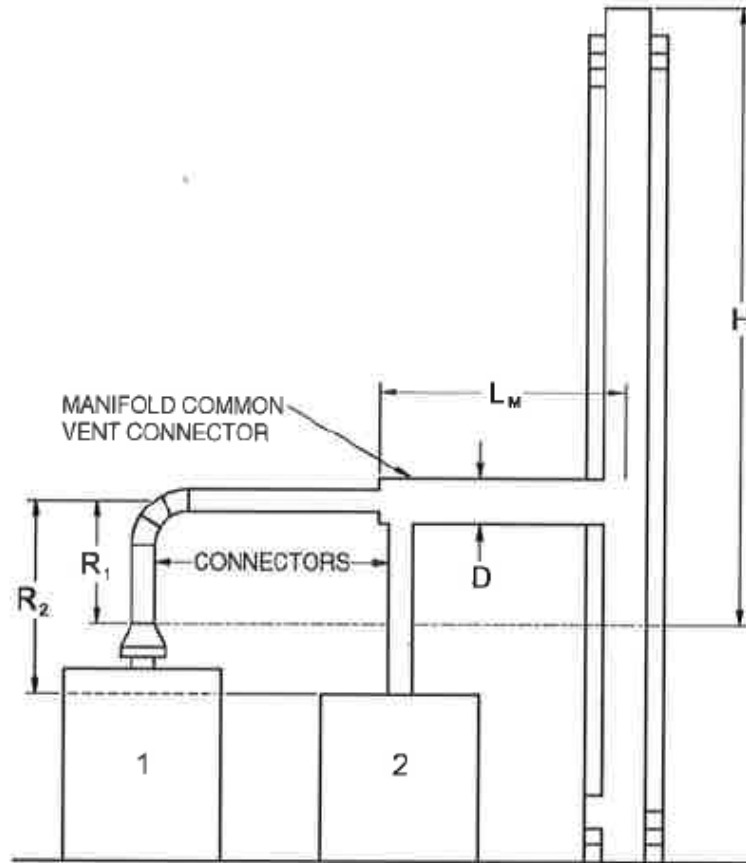

Example: Manifolded Common Vent Connector L_M shall be no greater than 18 times the common vent connector manifold inside diameter; i.e., a 4-inch (102 mm) inside diameter common vent connector manifold shall not exceed 72 inches (1829 mm) in length (see Section 504.3.4).

Note: This is an illustration of a typical manifolded vent connector. Different appliance, vent connector, or common vent types are possible. Consult Section 502.3.

FIGURE 504.3.4
USE OF A MANIFOLD COMMON VENT CONNECTOR

504.3.5 Common vertical vent offset. Where the common vertical vent is offset, the maximum capacity of the common vent shall be reduced in accordance with Section 504.3.6. The horizontal length of the common vent offset (L_o) shall not exceed 1½ feet for each inch ([18 mm per mm] 18 mm for each mm) of common vent diameter (D). Where multiple offsets

occur in a common vent, the total horizontal length of all offsets combined shall not exceed 1½ feet for each inch (~~[18 mm per mm]~~ 18 mm for each mm) of common vent diameter (D).

504.3.6 Elbows in vents. For each elbow up to and including 45 degrees (0.79 rad) in the common vent, the maximum common vent capacity listed in the venting tables shall be reduced by 5 percent. For each elbow greater than 45 degrees (0.79 rad) up to and including 90 degrees (1.57 rad), the maximum common vent capacity listed in the venting tables shall be reduced by 10 percent.

504.3.7 Elbows in connectors. The vent connector capacities listed in the common vent sizing tables include allowance for two 90-degree (1.57 rad) elbows. For each additional elbow up to and including 45 degrees (0.79 rad), the maximum vent connector capacity listed in the venting tables shall be reduced by 5 percent. For each elbow greater than 45 degrees (0.79 rad) up to and including 90 degrees (1.57 rad), the maximum vent connector capacity listed in the venting tables shall be reduced by 10 percent.

504.3.8 Common vent minimum size. The cross-sectional area of the common vent shall be equal to or greater than the cross-sectional area of the largest connector.

504.3.9 Common vent fittings. At the point where tee or wye fittings connect to a common vent, the opening size of the fitting shall be equal to the size of the common vent. Such fittings shall not be prohibited from having reduced size openings at the point of connection of appliance vent connectors.

504.3.9.1 Tee and wye fittings. Tee and wye fittings connected to a common gas vent shall be considered as part of the common gas vent and shall be constructed of materials consistent with that of the common gas vent.

504.3.10 Reserved.

504.3.11 Connector rise measurement. Connector rise (R) for each appliance connector shall be measured from the draft hood outlet or flue collar to the centerline where the vent gas streams come together.

504.3.12 Vent height measurement. For multiple units of appliances all located on one floor, available total height (H) shall be measured from the highest draft hood outlet or flue collar up to the level of the outlet of the common vent.

504.3.13 ~~[Multistory height measurement. For multistory installations, available total height (H) for each segment of the system shall be the vertical distance between the highest draft hood outlet or flue collar entering that segment and the centerline of the next higher interconnection tee.]~~ **Reserved.**

504.3.14 ~~[Multistory lowest portion sizing. The size of the lowest connector and of the vertical vent leading to the lowest interconnection of a multistory system shall be in accordance with Table 504.2(1) or 504.2(2) for available total height (H) up to the lowest interconnection.]~~ **Reserved.**

504.3.15 [~~Multistory common vents. Where used in multistory systems, vertical common vents shall be Type B double wall and shall be installed with a listed vent cap.~~] **Reserved.**

504.3.16 [~~Multistory common vents offsets. Offsets in multistory common vent systems shall be limited to a single offset in each system, and systems with an offset shall comply with all of the following:~~]

[1. ~~The offset angle shall not exceed 45 degrees (0.79 rad) from vertical.~~]

[2. ~~The horizontal length of the offset shall not exceed 1½ feet for each inch (18 mm for each 25.4 mm) of common vent diameter of the segment in which the offset is located.~~]

[3. ~~For the segment of the common vertical vent containing the offset, the common vent capacity listed in the common venting tables shall be reduced by 20 percent (0.80 × maximum common vent capacity).~~]

[4. ~~A multistory common vent shall not be reduced in size above the offset.~~] **Reserved.**

504.3.17 Vertical vent maximum size. Where two or more appliances are connected to a vertical vent or chimney, the flow area of the largest section of vertical vent or chimney shall not exceed seven times the smallest listed appliance categorized vent areas, flue collar area [∅] or draft hood outlet area unless designed in accordance with approved engineering methods.

504.3.18 Multiple input rate appliances. For appliances with more than one input rate, the minimum vent connector capacity (FAN Min) determined from the tables shall be less than the lowest appliance input rating, and the maximum vent connector capacity (FAN Max or NAT Max) determined from the tables shall be greater than the highest appliance input rating.

504.3.19 Liner system sizing and connections. Listed, corrugated metallic chimney liner systems in masonry chimneys shall be sized by using Table 504.3(1) or 504.3(2) for Type B vents, with the maximum capacity reduced by 20 percent (0.80 × maximum capacity) and the minimum capacity as shown in Table 504.3(1) or 504.3(2). Corrugated metallic liner systems installed with bends or offsets shall have their maximum capacity further reduced in accordance with Sections 504.3.5 and 504.3.6. The 20-percent reduction for corrugated metallic chimney liner systems includes an allowance for one long-radius 90-degree (1.57 rad) turn at the bottom of the liner. Where double-wall connectors are required, tee and wye fittings used to connect to the common vent chimney liner shall be listed double-wall fittings. Connections between chimney liners and listed double-wall fittings shall be made with listed adapter fittings designed for such purpose.

504.3.20 Chimney and vent location. Tables 504.3(1), 504.3(2), 504.3(3), 504.3(4), and 504.3(5) shall be used only for chimneys and vents not exposed to the outdoors below the roof line. [~~A Type B vent or listed chimney lining system passing through an unused masonry chimney flue shall not be considered to be exposed to the outdoors. A Type B vent shall not be considered to be exposed to the outdoors where it passes through an unventilated enclosure or chase insulated to a value of not less than R8. Tables 504.3(6) and 504.3(7) shall be used~~]

for clay-tile-lined exterior masonry chimneys, provided that all of the following conditions are met:]

Tables 504.3(6a), 504.3(6b), 504.3(7a) and 504.3(7b) shall be used for clay-tile-lined exterior masonry chimneys, provided that all of the following conditions are met:

1. Vent [~~connector is~~] connectors are Type B [~~double-wall~~] double wall.
2. [~~At least~~] Not less than one appliance is draft hood equipped.
3. The combined appliance input rating is less than the maximum capacity given by Table 504.3(6a) for NAT+NAT or Table 504.3(7a) for FAN+NAT.
4. The input rating of each space-heating appliance is greater than the minimum input rating given by Table 504.3(6b) for NAT+NAT or Table 504.3(7b) for FAN+NAT.
5. The vent connector sizing is in accordance with Table 504.3(3).

504.3.21 Connector maximum and minimum size. Vent connectors shall not be increased in size more than two sizes greater than the listed appliance categorized vent diameter, flue collar diameter [~~]~~ or draft hood outlet diameter. Vent connectors for draft hood-equipped appliances shall not be smaller than the draft hood outlet diameter. Where a vent connector size(s) determined from the tables for a fan-assisted appliance(s) is smaller than the flue collar diameter, the use of the smaller size(s) shall be permitted provided that the installation complies with all of the following conditions:

1. Vent connectors for fan-assisted appliance flue collars 12 inches (~~[305]~~ 304.8 mm) in diameter or smaller are not reduced by more than one table size (e.g., 12 inches (~~[305]~~ 304.8 mm to 254 mm) is a one-size reduction) and those larger than 12 inches (~~[305]~~ 304.8 mm) in diameter are not reduced more than two table sizes (e.g., 24 inches to 20 inches (~~[610]~~ 609.6 mm to 508 mm) is a two-size reduction).
2. The fan-assisted appliance(s) is common vented with a draft-hood-equipped appliance(s).
3. The vent connector has a smooth interior wall.

504.3.22 Component commingling. All combinations of pipe sizes, single-wall [~~]~~ and double-wall metal pipe shall be allowed within any connector run(s) or within the common vent, provided that all of the appropriate tables permit all of the desired sizes and types of pipe, as if they were used for the entire length of the subject connector or vent. Where single-wall and Type B double-wall metal pipes are used for vent connectors within the same venting system, the common vent must be sized using Table 504.3(2) or 504.3(4), as appropriate.

504.3.23 Draft hood conversion accessories. Draft hood conversion accessories for use with masonry chimneys venting listed Category I fan-assisted appliances shall be listed and installed in accordance with the manufacturer's [~~installation~~] instructions for such listed accessories.

504.3.24 Multiple sizes permitted. Where a table permits more than one diameter of pipe to be used for a connector or vent, all the permitted sizes shall be permitted to be used.

504.3.25 Table interpolation. Interpolation shall be permitted in calculating capacities for vent dimensions that fall between table entries.

504.3.26 Extrapolation prohibited. Extrapolation beyond the table entries shall not be permitted.

504.3.27 Engineering calculations. For vent heights less than 6 feet ([1829] 1828.8 mm) and greater than shown in the tables, engineering methods shall be used to calculate vent capacities.

504.3.28 Height entries. Where the actual height of a vent falls between entries in the height column of the applicable table in Tables 504.3(1) through 504.3(7b), either interpolation shall be used or the lower appliance input rating shown in the table shall be used for FAN MAX and NAT MAX column values and the higher appliance input rating shall be used for the FAN MIN column values.

SECTION FGC 505 DIRECT-VENT, INTEGRAL VENT, MECHANICAL VENT AND VENTILATION/EXHAUST HOOD VENTING

505.1 General. The installation of direct-vent and integral vent appliances shall be in accordance with Section 503. Mechanical venting systems and exhaust hood venting systems shall be designed and installed in accordance with Section 503.

505.1.1 Commercial cooking appliances vented by exhaust hoods. Refer to Chapter 5 of the *New York City Mechanical Code*.

505.1.2 Interlock requirements. Where commercial cooking appliances are vented by means of the Type I or Type II kitchen exhaust hood system that serves such appliances, the exhaust system shall be fan powered and the appliances shall be interlocked with the exhaust hood system to prevent appliance operation when the exhaust hood system is not operating. The method of interlock between the exhaust hood system and the appliances equipped with standing pilot burner ignition systems shall not cause such pilots to be extinguished. Where a solenoid valve is installed in the gas piping as part of an interlock system, gas piping shall not be installed to bypass such valve. Dampers shall not be installed in the exhaust system.

Exception: An interlock between the cooking appliance(s) and the exhaust hood system shall not be required where heat sensors or other approved methods automatically activate the exhaust hood system when cooking operations occur.

SECTION FGC 506 FACTORY-BUILT CHIMNEYS

506.1 Building heating appliances. Factory-built chimneys for building heating appliances producing flue gases having a temperature not greater than 1,000°F (~~538~~537.8°C), measured at the entrance to the chimney, shall be listed and labeled in accordance with UL 103 and shall be installed and terminated in accordance with the manufacturer's ~~installation~~ instructions and this code.

506.2 Support. Where factory-built chimneys are supported by structural members, such as joists and rafters, such members shall be designed to support the additional load.

506.3 Medium-heat appliances. Factory-built chimneys for medium-heat appliances producing flue gases having a temperature above 1,000°F (~~538~~537.8°C), measured at the entrance to the chimney, shall be listed and labeled in accordance with UL 959 and shall be installed and terminated in accordance with the manufacturer's ~~installation~~ instructions and this code.

SECTION FGC 507 CHANGES IN APPLIANCE FUELS

507.1 Changes in appliance fuels. Conversion of appliances from solid or liquid fuel to natural gas or the addition of natural gas, shall be made in accordance with this code. Conversion from natural gas to, or the addition of, #2 fuel oil for a heating appliance shall be made only if:

1. The chimney design meets the requirements of this chapter for the conversion fuel and the chimney is test run and smoke tested in accordance with Sections 503.5.6.4 and 503.5.6.5.
2. The chimney is sized to provide adequate draft and to vent the combustion products for the new fuel.
3. The chimney is thoroughly cleaned prior to the conversion to remove collected flue deposits.

SECTION FGC 508 EXHAUST GASES FROM INTERNAL COMBUSTION ENGINES AND TURBINES

508.1 Exhaust ~~pipe~~ system construction. The exhaust ~~pipe~~ system from internal combustion engines and turbines shall be constructed in accordance with ~~[NFPA 211, NFPA 37, and based on the temperature of the gases entering the exhaust pipe, and in accordance with the following:]~~

- ~~[1. The exhaust pipe, if factory fabricated, shall be installed in accordance with its listing and the manufacturer's instructions.]~~
- ~~[2. The exhaust pipe, if field fabricated, shall be constructed of at least 3/16-inch (5 mm) steel, or of other equivalent metal of similar strength and resistance to the temperature and corrosive action of the exhaust gases. No lining shall be required.]~~

~~[3. Where the exhaust pipe runs inside a building, it shall be insulated with insulation adequate for the temperature of the pipe, so that the surface temperature shall be not more than 200°F (93°C).]~~

~~[4. Where the exhaust pipe runs inside a building outside of the generator room, it shall be enclosed in a fire-rated construction equal to the construction of the generator room.]~~

~~[5. All joints shall be constructed so as to be gas tight under all operating conditions and tested in accordance with Sections 503.5.6.4 and 503.5.6.5.]~~ Section 811 of the *New York City Mechanical Code*.

§ 7. Chapter 6 of the New York city fuel gas code, as added by local law number 33 for the year 2007, section 605.3 as amended by local law number 85 for the year 2009, sections FGC 607, FGC 608, FGC 609, FGC 610, FGC 614, FGC 615, FGC 618, FGC 620, FGC 622, FGC 623, FGC 624, FGC 627, FGC 630, FGC 631 and FGC 633 as amended by and section FGC 635 as added by local law number 141 for the year 2013, is amended to read as follows:

CHAPTER 6 SPECIFIC APPLIANCES

SECTION FGC 601 GENERAL

601.1 Scope. This chapter shall govern the approval, design, installation, construction, maintenance, alteration and repair of the appliances and equipment specifically identified herein. The approval, design, installation, construction, maintenance, alteration and repair of nongas-fired appliances shall be regulated by the *New York City Mechanical Code*.

601.2 Fireplaces. Fireplaces (solid fuel type or ANSI Z21.50/CSA 2.22) shall be installed with tight-fitting noncombustible fireplace doors to control infiltration losses in construction type listed here:

1. Masonry or factory-built fireplaces designed to allow an open burn.
2. Whenever a decorative appliance (ANSI Standard Z21.60/CSA 2.26 gas-log style unit) is installed in a vented solid fuel fireplace.
3. Vented decorative gas fireplace appliances (ANSI Standard Z21.50/CSA 2.22 units).

Fireplaces shall be provided with a source of combustion air as required by the fireplace construction provisions of the *New York City Building Code*.

601.3 Flame safeguard device. All fuel gas space-heating appliances installed or used in a building occupied as a residence shall be equipped with an automatic flame safeguard device that

shall shut off the fuel supply to the main burner or group of burners when the flame or pilot light thereof is extinguished.

SECTION FGC 602 DECORATIVE GAS-FIRED APPLIANCES FOR INSTALLATION IN FIREPLACES

602.1 General. Decorative appliances for installation in approved solid fuel-burning fireplaces shall be tested in accordance with ANSI Z21.60/CSA 2.26 and shall be installed in accordance with the manufacturer's [~~installation~~] instructions. Manually lighted natural gas decorative appliances shall be tested in accordance with ANSI Z21.84.

602.2 Flame safeguard device. Decorative appliances for installation in approved solid fuel-burning fireplaces, with the exception of those tested in accordance with ANSI Z21.84, shall utilize a direct ignition device, an ignitor or a pilot flame to ignite the fuel at the main burner, and shall be equipped with a flame safeguard device. The flame safeguard device shall automatically shut off the fuel supply to a main burner or group of burners when the means of ignition of such burners becomes inoperative.

602.3 Prohibited installations. Decorative appliances for installation in fireplaces shall not be installed where prohibited by Section 303.3.

SECTION FGC 603 LOG LIGHTERS

603.1 General. Log lighters shall be [~~tested in accordance with CSA 8 and~~] installed in accordance with the manufacturer's [~~installation~~] instructions.

603.2 Automatic valves. Automatic valves or semiautomatic valves shall be provided and shall comply with the applicable provisions of ANSI Z21.21/CSA 6.5.

SECTION FGC 604 VENTED GAS FIREPLACES (DECORATIVE APPLIANCES)

604.1 General. Vented gas fireplaces shall be tested in accordance with ANSI Z21.50/CSA 2.22, shall be installed in accordance with the manufacturer's [~~installation~~] instructions and shall be designed and equipped as specified in Section 602.2.

604.2 Access. Panels, grilles and access doors that are required to be removed for normal servicing operations shall not be attached to the building.

SECTION FGC 605 VENTED GAS FIREPLACE HEATERS

605.1 General. Vented gas fireplace heaters shall be installed in accordance with the manufacturer's [~~installation~~] instructions, shall be tested in accordance with ANSI Z21.88/CSA

2.33 and shall be designed and equipped as specified in Section 602.2. The installation of unvented gas fired space heaters, gas stoves, gas logs, gas fireplaces and gas fireplace inserts is prohibited.

605.2 Separate flues. Separate flues shall be provided for every fireplace and fireplace stove.

605.3 Combustion air supply. The requirements of the *New York City Energy Conservation Code* concerning combustion air supply shall be followed.

SECTION FGC 606 RESERVED

SECTION FGC 607 COMMERCIAL-INDUSTRIAL INCINERATORS AND CREMATORIES

607.1 Incinerators and crematories, commercial-industrial. Commercial-industrial-type incinerators and crematories shall be constructed and installed in accordance with NFPA 82.

607.2 Compliance. All new and existing refuse disposal systems shall be installed, altered and maintained in buildings in conformity with the applicable provisions of the *Administrative Code* and the *New York City Air Pollution Control Code*.

SECTION FGC 608 VENTED WALL FURNACES

608.1 General. Vented wall furnaces shall be tested in accordance with ANSI Z21.86/CSA 2.32 and shall be installed in accordance with the manufacturer's [~~installation~~] instructions.

608.2 Venting. Vented wall furnaces shall be vented in accordance with Section 503.

608.3 Location. Vented wall furnaces shall be located so as not to cause a fire hazard to walls, floors, combustible furnishings or doors. Vented wall furnaces installed between bathrooms and adjoining rooms shall not circulate air from bathrooms to other parts of the building.

608.4 Door swing. Vented wall furnaces shall be located so that a door cannot swing within 12 inches ([~~305~~] 304.8 mm) of an air inlet or air outlet of such furnace measured at right angles to the opening. Doorstops or door closers shall not be installed to obtain this clearance.

608.5 Ducts prohibited. Ducts shall not be attached to wall furnaces. Casing extension boots shall not be installed unless listed as part of the appliance.

608.6 Access. Vented wall furnaces shall be provided with access for cleaning of heating surfaces, removal of burners, replacement of sections, motors, controls, filters and other working parts, and for adjustments and lubrication of parts requiring such attention. Panels, grilles and access doors that are required to be removed for normal servicing operations shall not be attached to the building construction.

SECTION FGC 609 FLOOR FURNACES

609.1 General. Floor furnaces shall be tested in accordance with ANSI Z21.86/CSA 2.32 and shall be installed in accordance with the manufacturer's ~~installation~~ instructions.

609.2 Placement. The following provisions apply to floor furnaces [-]:

1. **Floors.** Floor furnaces shall not be installed in the floor of any doorway, stairway landing, aisle or passageway of any enclosure, public or private, or in ~~an exit way~~ a means of egress from any such room or space.
2. **Walls and corners.** The register of a floor furnace with a horizontal warm-air outlet shall not be placed closer than 6 inches (~~152~~ 152.4 mm) to the nearest wall. A distance of ~~at least~~ not less than 18 inches (~~457~~ 457.2 mm) from two adjoining sides of the floor furnace register to walls shall be provided to eliminate the necessity of occupants walking over the warm-air discharge. The remaining sides shall be permitted to be placed not closer than 6 inches (~~152~~ 152.4 mm) to a wall. ~~Wall register~~ Wall-register models shall not be placed closer than 6 inches (~~152~~ 152.4 mm) to a corner.
3. **Draperies.** The furnace shall be placed so that a door, drapery or similar object cannot be nearer than 12 inches (~~305~~ 304.8 mm) to any portion of the register of the furnace.
4. **Floor construction.** Floor furnaces shall be located so as to be readily accessible. Means shall be provided for supporting the furnace when the grille is removed. Floor furnaces shall be installed only on floors of noncombustible construction having at least a 2-hour fire rating, except that floor furnace enclosures in one- and two-family dwellings shall be constructed of noncombustible materials with a fire-resistance rating ~~of at least~~ not less than 1 hour.
5. **Thermostat.** The controlling thermostat for a floor furnace shall be located within the same room or space as the floor furnace or shall be located in an adjacent room or space that is permanently open to the room or space containing the floor furnace.

609.3 Bracing. The floor around the furnace shall be braced and headed with a support framework designed in accordance with the *New York City Building Code*.

609.4 Clearance. The lowest portion of the floor furnace shall have not less than a 6-inch (~~152~~ 152.4 mm) clearance from the grade level; except where the lower 6[-] inch (~~152~~ 152.4 mm) portion of the floor furnace is sealed by the manufacturer to prevent entrance of water, the minimum clearance shall be not less than 2 inches (~~51~~ 50.8 mm). Where such clearances cannot be provided, the ground below and to the sides shall be excavated to form a pit under the furnace so that the required clearance is provided beneath the lowest portion of the furnace. A 12[-] inch (~~305~~ 304.8 mm) minimum clearance shall be provided on all sides except the control side, which shall have an 18[-] inch (~~457~~ 457.2 mm) minimum clearance.

609.5 Reserved.

609.6 Reserved.

609.7 Enclosures. Enclosures of floor furnaces shall be constructed entirely of noncombustible materials with a fire-resistance rating of at least 1-hour and the enclosure shall be provided with adequate outdoor air to ensure proper combustion. The enclosure shall be provided with adequate means of access for servicing the furnace.

609.8 Duct temperature. The outlet duct temperature of warm-air heating furnaces shall not be greater than 250°F (~~[124]~~121.1°C).

609.9 One- and two-family dwellings. Floor furnace enclosures shall be constructed of noncombustible materials with a fire-resistance rating of at least 1-hour. Means shall be provided for supporting the furnace when the grille is removed. Clearances shall be provided as per NFPA 54.

SECTION FGC 610 DUCT FURNACES

610.1 General. Duct furnaces shall be tested in accordance with ANSI Z83.8/CSA 2.6 or UL 795 and shall be installed in accordance with the manufacturer's ~~[installation]~~ instructions.

610.2 Access panels. Ducts connected to duct furnaces shall have removable access panels on both the upstream and downstream sides of the furnace.

610.3 Location of draft hood and controls. The controls, combustion air inlets and draft hoods for duct furnaces shall be located outside of the ducts. The draft hood shall be located in the same enclosure from which combustion air is taken.

610.4 Circulating air. Where a duct furnace is installed so that supply ducts convey air to areas outside the space containing the furnace, the return air shall ~~[also]~~ be conveyed by a duct(s) sealed to the furnace casing and terminating outside the space containing the furnace. The duct furnace shall be installed on the positive pressure side of the circulating air blower.

610.5 Unvented duct furnaces. Unvented duct furnaces are prohibited.

SECTION FGC 611 NONRECIRCULATING DIRECT-FIRED INDUSTRIAL AIR HEATERS

611.1 General. Nonrecirculating direct-fired industrial air heaters shall be listed to ANSI Z83.4/CSA 3.7 and shall be installed in accordance with the manufacturer's instructions.

611.2 Installation. Nonrecirculating direct-fired industrial air heaters shall not be used to supply any area containing sleeping quarters. Nonrecirculating direct-fired industrial air heaters shall be installed only in industrial or commercial occupancies. Nonrecirculating direct-fired industrial air heaters shall be permitted to provide ventilation air.

611.3 Clearance from combustible materials. Nonrecirculating direct-fired industrial air heaters shall be installed with a clearance from combustible materials of not less than that shown on the rating plate and in the manufacturer's instructions.

611.4 Supply air. All air handled by a nonrecirculating direct-fired industrial air heater, including combustion air, shall be ducted directly from the outdoors.

611.5 Outdoor air louvers. If outdoor air louvers of either the manual or automatic type are used, such devices shall be proven to be in the open position prior to allowing the main burners to operate.

611.6 Atmospheric vents and gas reliefs or bleeds. Nonrecirculating direct-fired industrial air heaters with valve train components equipped with atmospheric vents or gas reliefs or bleeds shall have their atmospheric vent lines or gas reliefs or bleeds lead to the outdoors. Means shall be employed on these lines to prevent water from entering and to prevent blockage by insects and foreign matter. An atmospheric vent line shall not be required to be provided on a valve train component equipped with a listed vent limiter.

611.7 Relief opening. The design of the installation shall include provisions to permit nonrecirculating direct-fired industrial air heaters to operate at rated capacity without overpressurizing the space served by the heaters by taking into account the structure's designed infiltration rate, providing properly designed relief openings or an interlocked power exhaust system, or a combination of these methods. The structure's designed infiltration rate and the size of relief openings shall be determined by approved engineering methods. Relief openings shall be permitted to be louvers or counterbalanced gravity dampers. Motorized dampers or closable louvers shall be permitted to be used, provided they are verified to be in their full open position prior to main burner operation.

611.8 Access. Nonrecirculating direct-fired industrial air heaters shall be provided with access for removal of burners; replacement of motors, controls, filters and other working parts; and for adjustment and lubrication of parts requiring maintenance.

611.9 Purging. Inlet ducting, where used, shall be purged by not less than four air changes prior to an ignition attempt.

611.10 Controls. Direct-fired make-up air heaters shall be equipped with airflow-sensing devices, safety shutoff devices, operating temperature controls and thermally actuated temperature limit controls in accordance with the terms of their listing.

SECTION FGC 612 RECIRCULATING DIRECT-FIRED INDUSTRIAL AIR HEATERS

612.1 General. Recirculating direct-fired industrial air heaters shall be listed to ANSI Z83.18 and shall be installed in accordance with the manufacturer's [~~installation~~] instructions.

612.2 Location. Recirculating direct-fired industrial air heaters shall be installed only in industrial and commercial occupancies. Recirculating direct-fired air heaters shall not serve any area

containing sleeping quarters. Recirculating direct-fired industrial air heaters shall not be installed in hazardous locations or in buildings that contain flammable solids, liquids or gases, explosive materials or substances that can become toxic when exposed to flame or heat.

612.3 Installation. Direct-fired industrial air heaters shall be permitted to be installed in accordance with their listing and the manufacturer's instructions. Direct-fired industrial air heaters shall be installed only in industrial or commercial occupancies. Direct-fired industrial air heaters shall be permitted to provide fresh air ventilation.

612.4 Clearance from combustible materials. Direct-fired industrial air heaters shall be installed with a clearance from combustible material of not less than that shown on the label and in the manufacturer's instructions.

612.5 Air supply. Air to direct-fired industrial air heaters shall be taken from the building, ducted directly from outdoors, or a combination of both. Direct-fired industrial air heaters shall incorporate a means to supply outside ventilation air to the space at a rate of not less than 4 cubic feet per minute per 1,000 Btu per hour (0.38 m³ per min per kW) of rated input of the heater. If a separate means is used to supply ventilation air, an interlock shall be provided so as to lock out the main burner operation until the mechanical means is verified. Where outside air dampers or closing louvers are used, they shall be verified to be in the open position prior to main burner operation.

612.6 Atmospheric vents, gas reliefs or bleeds. Direct-fired industrial air heaters with valve train components equipped with atmospheric vents, gas reliefs or bleeds shall have their atmospheric vent lines and gas reliefs or bleeds lead to the outdoors.

Means shall be employed on these lines to prevent water from entering and to prevent blockage by insects and foreign matter. An atmospheric vent line shall not be required to be provided on a valve train component equipped with a listed vent limiter.

612.7 Relief opening. The design of the installation shall include adequate provision to permit direct-fired industrial air heaters to operate at rated capacity by taking into account the structure's designed infiltration rate, providing properly designed relief openings or an interlocked power exhaust system, or a combination of these methods. The structure's designed infiltration rate and the size of relief openings shall be determined by a registered design professional. Relief openings shall be permitted to be louvers or counterbalanced gravity dampers. Motorized dampers or closable louvers shall be permitted to be used, provided they are verified to be in their full open position prior to main burner operation.

612.8 Controls. Recirculating direct-fired air heaters shall be equipped with airflow-sensing devices, safety shutoff devices, operating temperature controls and thermally actuated temperature limit controls in accordance with the terms of their listing.

SECTION FGC 613 CLOTHES DRYERS

613.1 General. Clothes dryers shall be tested in accordance with ANSI Z21.5.1/CSA 7.1 or ANSI Z21.5.2/CSA 7.2, and shall be installed in accordance with the manufacturer's [~~installation~~] instructions.

SECTION FGC 614 CLOTHES DRYER EXHAUST

614.1 [~~Installation~~] Clothes dryer exhaust. [~~Clothes dryers shall be exhausted in accordance with the manufacturer's instructions. Dryer exhaust systems shall be independent of all other systems and shall convey the moisture and any products of combustion to the outside of the building.~~]

[~~**Exception:** This section shall not apply to listed and labeled condensing (ductless) clothes dryers.~~]

Clothes dryer exhaust shall be in accordance with Section 504 of the *New York City Mechanical Code*.

[~~**614.2 Duct penetrations.** Ducts that exhaust clothes dryers shall not penetrate or be located within any fireblocking, draftstopping or any wall, floor/ceiling or other assembly required by the *New York City Building Code* to be fire resistance rated, unless such duct is constructed of galvanized steel or aluminum of the thickness specified in Table 603.4 of the *New York City Mechanical Code* and the fire resistance rating is maintained in accordance with the *New York City Building Code*. Fire dampers shall not be installed in clothes dryer exhaust duct systems.~~]

[~~**614.3 Cleaning access.** Each vertical duct riser for dryers listed to ANSI Z21.5.2 shall be provided with a cleanout or other means for cleaning the interior of the duct.~~]

[~~**614.4 Exhaust installation.** Exhaust ducts for clothes dryers shall terminate on the outside of the building and shall be equipped with a backdraft damper. Screens shall not be installed at the duct termination. Ducts shall not be connected or installed with sheet metal screws or other fasteners that will obstruct the flow. Clothes dryer exhaust ducts shall not be connected to a vent connector, vent or chimney. Clothes dryer exhaust ducts shall not extend into or through ducts or plenums.~~]

[~~**614.5 Makeup air.** Installations exhausting more than 200 cfm (0.09 m³/s) shall be provided with makeup air. Where a closet is designed for the installation of a clothes dryer, an opening having an area of not less than 100 square inches (645 mm²) for makeup air shall be provided in the closet enclosure, or makeup air shall be provided by other approved means.~~]

[~~**614.6 Domestic clothes dryer exhaust ducts.** Exhaust ducts for domestic clothes dryers shall conform to the requirements of Sections 614.6.1 through 614.6.7.~~]

[~~**614.6.1 Material and size.** Exhaust ducts shall have a smooth interior finish and shall be constructed of metal that is a minimum of 0.016 inches (0.4 mm) thick. The exhaust duct size~~

shall be 4 inches minimum (102 mm) nominal diameter, unless a larger duct size is specifically required by the dryer manufacturer.]

[614.6.2 Duct installation. Exhaust ducts shall be supported at 4 foot (1219 mm) intervals and secured in place. The inserted end of the duct shall extend into the adjoining duct or fitting in the direction of airflow. Ducts shall not be joined with screws or similar fasteners that protrude into the inside of the duct.]

[614.6.3 Protection required. Protective shield plates shall be placed where nails or screws from finish or other work are likely to penetrate the clothes dryer exhaust duct. Shield plates shall be placed on the finished face of all framing members where there is less than 1¼ inches (32 mm) between the duct and the finished face of the framing member. Protective shield plates shall be constructed of steel, shall have a minimum thickness of 0.062 inch (1.6 mm) and shall extend a minimum of 2 inches (51 mm) above sole plates and below top plates.]

[614.6.4 Transition ducts. Transition ducts used to connect the dryer to the exhaust duct system shall be a single length that is listed and labeled in accordance with UL 2158A. Transition ducts shall be a maximum of 8 feet (2438 mm) in length, and shall not be concealed within construction.]

[614.6.5 Duct length. The maximum allowable exhaust duct length shall be determined by one of the methods specified in Section 614.6.5.1 or 614.6.5.2.]

[614.6.5.1 Specified length. The maximum length of the exhaust duct shall be 35 feet (10 668 mm) from the connection to the transition duct from the dryer to the outlet terminal. Where fittings are utilized, the maximum length of the exhaust duct shall be reduced in accordance with Table 614.6.5.1.]

**[TABLE 614.6.5.1
DRYER EXHAUST DUCT FITTING EQUIVALENT LENGTH**

DRYER EXHAUST DUCT FITTING TYPE	EQUIVALENT LENGTH
4 inch radius mitered 45-degree elbow	2 feet, 6 inches
4 inch radius mitered 90-degree elbow	5 feet
6 inch radius smooth 45-degree elbow	1 foot
6 inch radius smooth 90-degree elbow	1 foot, 9 inches
8 inch radius smooth 45-degree elbow	1 foot
8 inch radius smooth 90-degree elbow	1 foot, 7 inches
10 inch radius smooth 45-degree elbow	9 inches
10 inch radius smooth 90-degree elbow	1 foot, 6 inches

For SI: 1 inch = 25.4 mm, 1 foot = 304.8 mm, 1 degree = 0.01745 rad.

The equivalent length column of the table indicates how much length must be added to the exhaust duct total length for each fitting used.]

~~[614.6.5.2 Manufacturer's instructions. The maximum length of the exhaust duct shall be determined by the dryer manufacturer's installation instructions. The special inspector shall be provided with a copy of the installation instructions for the make and model of the dryer. Where the exhaust duct is to be concealed, the installation instructions shall be provided to the special inspector prior to the concealment inspection. In the absence of fitting equivalent length calculations from the clothes dryer manufacturer, Table 614.6.5.1 shall be utilized.]~~

~~[614.6.6 Length identification. Where the exhaust duct is concealed within the building construction, the equivalent length of the exhaust duct shall be identified on a permanent label or tag. The label or tag shall be located within 6 feet (1829 mm) of the exhaust duct connection.]~~

~~[614.6.7 Exhaust duct required. Where space for a clothes dryer is provided, an exhaust duct system shall be installed.~~

~~Where the clothes dryer is not installed at the time of occupancy, the exhaust duct shall be capped at the location of the future dryer.]~~

~~[Exception: Where a listed condensing clothes dryer is installed prior to occupancy of the structure.]~~

~~[614.7 Commercial clothes dryers. The installation of dryer exhaust ducts serving Type 2 clothes dryers shall comply with the appliance manufacturer's installation instructions. Exhaust fan motors installed in exhaust systems shall be located outside of the airstream. In multiple installations, the fan shall operate continuously or be interlocked to operate when any individual unit is operating. Ducts shall have a minimum clearance of 6 inches (152 mm) to combustible materials.]~~

~~[614.8 Common exhaust systems for clothes dryers located in multistory structures. Where a common multistory duct system is designed and installed to convey exhaust from multiple clothes dryers, the construction of such system shall be in accordance with all of the following:]~~

~~[1. The shaft in which the duct is installed shall be constructed and fire resistance rated as required by the *New York City Building Code*.]~~

~~[2. Dampers shall be prohibited in the exhaust duct.]~~

~~[3. Rigid metal ductwork shall be installed within the shaft to convey the exhaust. The ductwork shall be constructed of sheet steel having a minimum thickness of 0.0187 inch (0.471 mm) (No. 26 gage) and in accordance with SMACNA Duct Construction Standards.]~~

~~[4. Exhaust ducts 20 square inches (12 903 mm²) or less connected into dryer exhaust shaft shall not require fire dampers when the exhaust fan runs continuously.]~~

~~[5. The exhaust fan motor design shall be in accordance with Section 503.2 of the *New York City Mechanical Code*.]~~

- [6. ~~The exhaust fan motor shall be located outside of the airstream.~~]
- [7. ~~The exhaust fan shall run continuously, and shall be connected to a standby power source, where a building emergency or standby power source is required by the *New York City Building Code*.~~]
- [8. ~~The exhaust fan operation shall be monitored in an approved location and shall initiate an audible or visual signal when the fan is not in operation.~~]
- [9. ~~Makeup air shall be provided for the exhaust system.~~]
- [10. ~~Cleanout openings shall be located at the base of the shaft and the bases of all offsets to provide access to the duct to allow for cleaning and inspection. The finished opening shall be not less than 12 inches by 12 inches (305 mm by 305 mm).~~]
- [11. ~~Screens shall not be installed at the termination.~~]

SECTION FGC 615 SAUNA HEATERS

615.1 General. Sauna heaters shall be installed in accordance with the manufacturer's [installation] instructions.

615.2 Location and protection. Sauna heaters shall be located so as to minimize the possibility of accidental contact by a person in the room.

615.2.1 Guards. Sauna heaters shall be protected from accidental contact by an approved guard or barrier of material having a low coefficient of thermal conductivity. The guard shall not substantially affect the transfer of heat from the heater to the room.

615.3 Access. Panels, grilles and access doors that are required to be removed for normal servicing operations shall not be attached to the building.

615.4 Combustion and dilution air intakes. Sauna heaters of other than the direct-vent type shall be installed with the draft hood and combustion air intake located outside the sauna room. Where the combustion air inlet and the draft hood are in a dressing room adjacent to the sauna room, there shall be provisions to prevent physically blocking the combustion air inlet and the draft hood inlet, and to prevent physical contact with the draft hood and vent assembly, or warning notices shall be posted to avoid such contact. Any warning notice shall be easily readable, shall contrast with its background and the wording shall be in letters not less than ¼ inch (6.4 mm) high.

615.5 Combustion and ventilation air. Combustion air shall not be taken from inside the sauna room. Combustion and ventilation air for a sauna heater not of the direct-vent type shall be provided to the area in which the combustion air inlet and draft hood are located in accordance with Section 304.

615.6 Heat and time controls. Sauna heaters shall be equipped with a thermostat which will limit room temperature to 194°F (90°C). If the thermostat is not an integral part of the sauna heater, the

heat-sensing element shall be located within 6 inches (~~[152]~~ 152.4 mm) of the ceiling. If the heat-sensing element is a capillary tube and bulb, the assembly shall be attached to the wall or other support, and shall be protected against physical damage.

615.6.1 Timers. A timer, if provided to control main burner operation, shall have a maximum operating time of 1 hour. The control for the timer shall be located outside the sauna room.

615.7 Sauna room. A ventilation opening into the sauna room shall be provided. The opening shall be not less than 4 inches by 8 inches (~~[102]~~ 101.6 mm by ~~[203]~~ 203.2 mm) located near the top of the door into the sauna room.

615.7.1 Warning notice. The following permanent notice, constructed of approved material, shall be mechanically attached to the sauna room on the outside:

WARNING: DO NOT EXCEED 30 MINUTES IN SAUNA. EXCESSIVE EXPOSURE CAN BE HARMFUL TO HEALTH. ANY PERSON WITH POOR HEALTH SHOULD CONSULT A PHYSICIAN BEFORE USING SAUNA.

The words shall contrast with the background and the wording shall be in letters not less than $\frac{1}{4}$ inch (6.4 mm) high.

Exception: This section shall not apply to one- and two-family dwellings.

SECTION FGC 616 ENGINE AND GAS TURBINE-POWERED EQUIPMENT AND APPLIANCES

616.1 Powered equipment. Permanently installed equipment powered by internal combustion engines and turbines shall be installed in accordance with the manufacturer's [~~installation~~] instructions and NFPA 37. Stationary engine generator assemblies shall meet the requirements of UL 2200.

616.2 Gas supply connection. Equipment powered by internal combustion engines and turbines shall not be rigidly connected to the gas supply piping.

SECTION FGC 617 POOL AND SPA HEATERS

617.1 General. Pool and spa heaters shall be tested in accordance with ANSI Z21.56/CSA 4.7 and shall be installed in accordance with the manufacturer's [~~installation~~] instructions.

SECTION FGC 618 FORCED-AIR WARM-AIR FURNACES

618.1 General. Forced-air warm-air furnaces shall be tested in accordance with ANSI Z21.47/CSA 2.3 or UL 795 and shall be installed in accordance with the manufacturer's [~~installation~~] instructions.

618.2 Forced-air furnaces. The minimum unobstructed total area of ~~[the outside]~~ outdoor and return air ducts or openings to a forced-air warm-air furnace shall be not less than 2 square inches for each 1,000 Btu/h (4402 mm²/W) output rating capacity of the furnace and not less than that specified in the furnace manufacturer's ~~[installation]~~ instructions. The minimum unobstructed total area of supply ducts from a forced-air warm-air furnace shall be not less than 2 square inches (1290.32 mm²) for each 1,000 Btu/h (4402 mm²/W) output rating capacity of the furnace and not less than that specified in the furnace manufacturer's ~~[installation]~~ instructions.

Exception: The total area of ~~[the]~~ supply air ducts and ~~[outside]~~ outdoor and return air ducts shall not be required to be larger than the minimum size required by the furnace manufacturer's ~~[installation]~~ instructions.

618.3 Dampers. Volume dampers shall not be placed in the air inlet to a furnace in a manner that will reduce the required air to the furnace.

~~[618.4 Circulating air ducts for forced-air warm-air furnaces. Circulating air for fuel-burning, forced-air type, warm-air furnaces shall be conducted into the blower housing from outside the furnace enclosure by continuous air-tight ducts.]~~

~~[618.5]~~ **618.4 Prohibited sources.** Outdoor or return air for [a] forced-air heating ~~[system]~~ or forced-air heating and cooling systems shall not be taken from the following locations:

1. ~~[Less]~~ Closer than 10 feet (3048 mm) from an appliance vent outlet, a vent opening from a plumbing drainage system or the discharge outlet of an exhaust fan, unless the outlet is 3 feet (~~[914]~~ 914.4 mm) above the ~~[outdoor]~~ outside air inlet.
2. Where there is the presence of objectionable odors, fumes or flammable vapors; or where located less than 10 feet (3048 mm) above the surface of any abutting public way or driveway; or where located at grade level by a sidewalk, street, alley or driveway.
3. A hazardous or insanitary location or a refrigeration machinery room as defined in the *New York City Mechanical Code*.
4. A room or space, the volume of which is less than 25 percent of the entire volume served by such system. Where connected by a permanent opening having an area sized in accordance with Section 618.2, adjoining rooms or spaces shall be considered as a single room or space for the purpose of determining the volume of such rooms or spaces.

Exception: The minimum volume requirement shall not apply where the amount of return air taken from a room or space is less than or equal to the amount of supply air delivered to such room or space.

5. A room or space containing an appliance where such a room or space serves as the sole source of return air.

Exception: This shall not apply where:

1. The appliance is a direct-vent appliance or an appliance not requiring a vent in accordance with Section 501.8.
2. The room or space complies with the following requirements:
 - 2.1. The return air shall be taken from a room or space having a volume exceeding 1 cubic foot for each 10 Btu/h (9.6 L/W) of combined input rating of all fuel-burning appliances therein.
 - 2.2. The volume of supply air discharged back into the same space shall be approximately equal to the volume of return air taken from the space.
 - 2.3. Return-air inlets shall not be located within 10 feet (3048 mm) of ~~[any appliance firebox or]~~ a draft hood in the same room or space or the combustion chamber of any atmospheric burner appliance in the same room or space.
3. Rooms or spaces containing solid fuel-burning appliances, provided that return-air inlets are located not less than 10 feet (3048 mm) from the firebox of such appliances.
6. A closet, bathroom, toilet room, kitchen, garage, ~~[mechanical room,]~~ boiler room, furnace room or unconditioned attic.

[Exception] Exceptions:

1. Where return air intakes are located not less than 10 feet (3048 mm) from cooking appliances and serve only the kitchen area, taking return air from a kitchen area shall not be prohibited.
2. Dedicated forced-air systems serving only a garage shall not be prohibited from obtaining return air from the garage.
7. A crawl space by means of direct connection to the return side of a ~~[forced-air]~~ forced-air system. Transfer openings in the crawl space enclosure shall not be prohibited.

[618.6] 618.5 Screen. Required outdoor air inlets for residential portions of a building shall be covered with a screen having ¼-inch (6.4 mm) openings. Required outdoor air inlets serving a nonresidential portion of a building shall be covered with screen having openings larger than ¼ inch (6.4 mm) and not larger than 1 inch (~~[25]~~ 25.4 mm).

[618.7] 618.6 Return-air limitation. Return air from one dwelling unit shall not be discharged into another dwelling unit.

[618.8] 618.7 Furnace plenums and air ducts. Where a furnace is installed so that supply ducts carry air circulated by the furnace to areas outside of the space containing the furnace, the return air shall ~~[also]~~ be handled by a duct(s) sealed to the furnace casing and terminating outside of the space containing the furnace.

SECTION FGC 619 CONVERSION BURNERS

619.1 Conversion burners. The installation of conversion burners shall conform to ANSI Z21.8 and ASME CSD-1, including Appendix C.

SECTION FGC 620 UNIT HEATERS

620.1 General. Unit heaters shall be tested in accordance with ANSI Z83.8/CSA 2.6 and shall be installed in accordance with the manufacturer's [~~installation~~] instructions.

620.2 Support. Suspended-type unit heaters shall be supported by elements that are designed and constructed to accommodate the weight and dynamic loads. Hangers and brackets shall be of noncombustible material.

620.3 Ductwork. Ducts shall not be connected to a unit heater unless the heater is listed for such installation.

620.4 Clearance. Suspended-type unit heaters shall be installed with clearances to combustible materials of not less than 18 inches (~~[457]~~ 457.2 mm) at the sides, 12 inches (~~[305]~~ 304.8 mm) at the bottom and 6 inches (~~[152]~~ 152.4 mm) above the top where the unit heater has an internal draft hood or 1 inch (~~[25]~~ 25.4 mm) above the top of the sloping side of the vertical draft hood.

Floor-mounted-type unit heaters shall be installed with clearances to combustible materials at the back and one side only of not less than 6 inches (~~[152]~~ 152.4 mm). Where the flue gases are vented horizontally, the 6-inch (~~[152]~~ 152.4 mm) clearance shall be measured from the draft hood or vent instead of the rear wall of the unit heater. Floor-mounted-type unit heaters shall not be installed on combustible floors unless listed for such installation.

Clearances for servicing all unit heaters shall be in accordance with the manufacturer's [~~installation~~] instructions.

Exception: Unit heaters listed for reduced clearance shall be permitted to be installed with such clearances in accordance with their listing and the manufacturer's instructions and as approved by the department.

620.5 Installation in commercial garages and aircraft hangars. Unit heaters installed in garages for more than three motor vehicles or in aircraft hangars shall be installed in accordance with Sections 305.9, 305.10 and 305.11.

SECTION FGC 621 UNVENTED ROOM HEATERS

621.1 General. The installation of unvented room heaters is prohibited.

621.2 Reserved.

621.3 Reserved.

621.4 Reserved.

621.5 Reserved.

621.6 Reserved.

621.7 Reserved.

SECTION FGC 622 VENTED ROOM HEATERS

622.1 General. Vented room heaters shall be tested in accordance with ANSI Z21.86/CSA 2.32, ~~[shall be designed and equipped as specified in Section 602.2 and shall be]~~ installed in accordance with the manufacturer's ~~[installation]~~ instructions, and shall be designed and equipped as specified in Section 602.2 of this code.

SECTION FGC 623 COOKING APPLIANCES

623.1 Cooking appliances. Cooking appliances that are designed for permanent installation, including ranges, ovens, stoves, broilers, grills, fryers, griddles, hot plates and barbecues, shall be tested in accordance with ANSI Z21.1/CSA 6.5, ANSI Z21.58/CSA 1.6 or ANSI Z83.11/CSA 1.8 and shall be installed in accordance with the manufacturer's ~~[installation]~~ instructions.

623.1.1 LPG. Except as may be permitted by the *New York City Fire Code*, cooking appliances using LPG are prohibited.

623.2 Prohibited location. Cooking appliances designed, tested, listed and labeled for use in commercial occupancies shall not be installed within dwelling units or within any area where domestic cooking operations occur.

Exception: Appliances that are also listed as domestic cooking appliances.

623.2.1 Barbeque grills. Barbeque grills piped to natural gas shall not be installed or operated within 10 feet (3048 mm) of any combustible waste or combustible material including combustible building surfaces, balconies and decks.

623.3 Domestic appliances. Cooking appliances installed within dwelling units and within areas where domestic cooking operations occur shall be listed and labeled as household-type appliances for domestic use.

623.4 Domestic range installation. Domestic ranges installed on combustible floors shall be set on their own bases or legs and shall be installed with clearances of not less than that shown on the label.

623.5 Open-top broiler unit hoods. A ventilating hood shall be provided above a domestic open-top broiler unit, unless otherwise listed for forced down draft ventilation.

623.5.1 Clearances. A minimum clearance of 24 inches (~~[610]~~ 609.6 mm) shall be maintained between the cooking top and combustible material above the hood. The hood shall be at least as wide as the open-top broiler unit and be centered over the unit.

623.6 Commercial cooking appliance venting. Commercial cooking appliances, other than those exempted by Section 501.8, shall be vented by connecting the appliance to a vent or chimney in accordance with this code and the appliance manufacturer's instructions or the appliance shall be vented in accordance with Section 505.1.1.

623.7 Domestic ventilation. When a hood is provided for a domestic cooking appliance, the exhaust and make-up air systems shall be properly engineered and designed in accordance with Chapter 5 of this code and the *New York City Mechanical Code*. Household cooking appliances shall have a vertical clearance above the cooking top of not less than 30 inches (760 mm) to combustible material and metal cabinets. A minimum clearance of 24 inches (~~[610]~~ 609.6 mm), measured to the underside of the above cabinet or combustible material, is permitted where one of the following is installed:

1. The underside of the combustible material or metal cabinet above the cooking top is protected with not less than ¼-inch (~~[6]~~ 6.4 mm) insulating millboard covered with sheet metal not less than 0.0122 inch (0.3 mm) thick.
2. A metal ventilating hood constructed of sheet metal not less than 0.0122 inch (0.3 mm) thick is installed above the cooking top with a clearance of not less than ¼ inch (6.4 mm) between the hood and the underside of the combustible material or metal cabinet. The hood shall have a width not less than the width of the appliance and shall be centered over the appliance.
3. A listed cooking appliance or microwave oven is installed over a listed cooking appliance and in compliance with the terms of the manufacturer's installation instructions for the upper appliance.

SECTION FGC 624 WATER HEATERS

624.1 General. Water heaters shall be tested in accordance with [~~ANSI Z 21.10.1~~] ANSI Z21.10.1/CSA 4.1 and [~~ANSI Z 21.10.3~~] ANSI Z21.10.3/CSA 4.3 and shall be installed in accordance with the manufacturer's [~~installation~~] instructions. Water heaters utilizing fuels other than fuel gas shall be regulated by the *New York City Mechanical Code*. Approval for water heaters 350,000 Btu/h input (~~1025~~ 102.6 kW) and above shall be obtained from the New York City Department of Environmental Protection.

624.1.1 Installation requirements. The requirements for water heaters relative to sizing, relief valves, drain pans and scald protection shall be in accordance with the *New York City Plumbing Code* and the following:

1. No person shall install or maintain in any dwelling unit a gas fuel-fired water heater unless the heater obtains combustion air directly from the outside of the building.
2. No person shall install or maintain a gas-fueled water heater in a room occupied for sleeping purposes, or cause or permit to be occupied for sleeping purposes any room in which a gas-fueled heater is installed.
3. Each heater shall be connected to a flue or outlet pipe.

624.2 Water heaters utilized for space heating. Water heaters utilized both to supply potable hot water and provide hot water for space-heating applications shall be listed and labeled for such applications by the manufacturer, and shall be built in accordance with Section IV of the ASME Boiler and Pressure Vessel Code with an “H” code stamp. They shall be installed in accordance with the manufacturer’s ~~installation~~ instructions, the ASME Boiler and Pressure Vessel Code and the *New York City Plumbing Code*.

SECTION FGC 625 REFRIGERATORS

625.1 General. Refrigerators shall be tested in accordance with ANSI Z21.19/CSA 1.4 and shall be installed in accordance with the manufacturer’s ~~installation~~ instructions.

Refrigerators shall be provided with adequate clearances for ventilation at the top and back, and shall be installed in accordance with the manufacturer’s instructions. If such instructions are not available, ~~at least~~ not less than 2 inches (~~51~~ 50.8 mm) shall be provided between the back of the refrigerator and the wall and ~~at least~~ not less than 12 inches (~~305~~ 304.8 mm) above the top.

SECTION FGC 626 GAS-FIRED TOILETS

626.1 General. Gas-fired toilets are not approved for use in New York City.

626.2 Reserved.

SECTION FGC 627 AIR CONDITIONING APPLIANCES

627.1 General. Gas-fired air-conditioning appliances shall be tested in accordance with ANSI Z21.40.1/CGA 2.91 or ANSI Z21.40.2/CGA 2.92 and shall be installed in accordance with the manufacturer’s ~~installation~~ instructions.

627.2 Independent piping. Gas piping serving heating appliances shall be permitted to also serve cooling appliances where such heating and cooling appliances cannot be operated simultaneously (see Section 402).

627.3 Connection of gas engine-powered air conditioners. To protect against the effects of normal vibration in service, gas engines shall not be rigidly connected to the gas supply piping. Where units are powered by internal combustion engines and turbines, installation shall comply with Section 616.1.

627.4 Clearances for indoor installation. Air-conditioning appliances installed in rooms other than alcoves and closets shall be installed with clearances not less than those specified in Section 308.3 [~~except that air-conditioning~~].

Exceptions:

1. Air-conditioning appliances listed for installation at lesser clearances than those specified in Section 308.3 shall be permitted to be installed in accordance with such listing and the manufacturer's instructions [~~and air-conditioning~~]. Air-conditioning appliances installed in rooms other than alcoves and closets shall be permitted to be installed with reduced clearances to combustible material, provided that the combustible material is protected in accordance with Table 308.2.
2. Air-conditioning appliances listed for installation at greater clearances than those specified in Section 308.3 shall be installed in accordance with such listing and the manufacturer's instructions.

~~[Air-conditioning appliances installed in rooms other than alcoves and closets shall be permitted to be installed with reduced clearances to combustible material, provided that the combustible material is protected in accordance with Table 308.2.]~~

627.5 Alcove and closet installation. Air-conditioning appliances installed in spaces such as alcoves and closets shall be specifically listed for such installation and installed in accordance with the terms of such listing. The installation clearances for air-conditioning appliances in alcoves and closets shall not be reduced by the protection methods described in Table 308.2.

627.6 Installation. Air-conditioning appliances shall be installed in accordance with the manufacturer's instructions. Unless the appliance is listed for installation on a combustible surface such as a floor or roof, or unless the surface is protected in an approved manner, [~~appliances~~] the appliance shall be installed on a surface of noncombustible construction with noncombustible material and surface finish and with no combustible material against the underside thereof.

627.7 Plenums and air ducts. A plenum supplied as a part of the air-conditioning appliance shall be installed in accordance with the appliance manufacturer's instructions. Where a plenum is not supplied with the appliance, such plenum shall be installed in accordance with the fabrication and installation instructions provided by the plenum and appliance manufacturer. The method of connecting supply and return ducts shall facilitate proper circulation of air.

Where ~~an~~ the air-conditioning appliance is installed within a space separated from the spaces served by the appliance, the air circulated by the appliance shall be conveyed by ducts that are sealed to the casing of the appliance and that separate the circulating air from the combustion and ventilation air.

627.8 Refrigeration coils. A refrigeration coil shall not be installed in conjunction with a forced-air furnace where circulation of cooled air is provided by the furnace blower, unless the blower has sufficient capacity to overcome the external static resistance imposed by the duct system and cooling coil at the air throughput necessary for heating or cooling, whichever is greater. Furnaces shall not be located upstream from cooling units, unless the cooling unit is designed or equipped so as not to develop excessive temperature or pressure. Refrigeration coils shall be installed in parallel with or on the downstream side of central furnaces to avoid condensation in the heating element, unless the furnace has been specifically listed for downstream installation. With a parallel flow arrangement, the dampers or other means used to control flow of air shall be sufficiently tight to prevent any circulation of cooled air through the furnace.

Means shall be provided for disposal of condensate and to prevent dripping of condensate onto the heating element.

627.9 Cooling units used with heating boilers. Boilers, where used in conjunction with refrigeration systems, shall be installed so that the chilled medium is piped in parallel with the heating boiler with appropriate valves to prevent the chilled medium from entering the heating boiler. Where hot water heating boilers are connected to heating coils located in air-handling units where they might be exposed to refrigerated air circulation, such boiler piping systems shall be equipped with flow control valves or other automatic means to prevent gravity circulation of the boiler water during the cooling cycle.

627.10 Switches in electrical supply line. Means for interrupting the electrical supply to the air-conditioning appliance and to its associated cooling tower (if supplied and installed in a location remote from the air conditioner) shall be provided within sight of and not over 50 feet (15 240 mm) from the air conditioner and cooling tower.

SECTION FGC 628 ILLUMINATING APPLIANCES

628.1 General. Illuminating appliances shall be tested in accordance with ANSI Z21.42 and shall be installed in accordance with the manufacturer's ~~installation~~ instructions.

628.2 Mounting on buildings. Illuminating appliances designed for wall or ceiling mounting shall be securely attached to substantial structures in such a manner that they are not dependent on the gas piping for support.

628.3 Mounting on posts. Illuminating appliances designed for post mounting shall be securely and rigidly attached to a post. Posts shall be rigidly mounted in accordance with the requirements of the *New York City Building Code*. Drain openings shall be provided near the base of posts where there is a possibility of water collecting inside them.

628.4 Appliance pressure regulators. Where an appliance pressure regulator is not supplied with an illuminating appliance and the service line is not equipped with a service pressure regulator, an appliance pressure regulator shall be installed in the line to the illuminating appliance. For multiple installations, one regulator of adequate capacity shall be permitted to serve more than one illuminating appliance.

SECTION FGC 629 ~~[SMALL]~~ CERAMIC KILNS

629.1 General. ~~[Ceramic kilns with a maximum interior volume of 20 cubic feet (0.566 m³) and used for hobby and noncommercial purposes shall be installed in accordance with the manufacturer's installation instructions and the provisions of this code.]~~ Kilns shall be listed and labeled unless otherwise approved in accordance with Section 105.1. Electric kilns shall comply with UL 499. The approval of unlisted appliances in accordance with Section 105.1 shall be based on an approved engineering evaluation.

SECTION FGC 630 INFRARED RADIANT HEATERS

630.1 General. Infrared radiant heaters shall be tested in accordance with ~~[ANSI Z83.6]~~ ANSI Z83.19/CSA 2.35 or ANSI Z83.20/CSA 2.34 and shall be installed in accordance with the manufacturer's ~~[installation]~~ instructions.

630.2 Support. Infrared radiant heaters shall be safely and adequately fixed in an approved position independent of gas and electric supply lines. Hangers and brackets shall be of noncombustible material.

630.3 Combustion and ventilation air. Where unvented infrared heaters are installed, natural or mechanical means shall provide outdoor ventilation air at a rate of not less than 4 cfm per 1,000 Btu/h (0.38 m³/min/kW) of the aggregate input rating of all such heaters installed in the space. Exhaust openings for removing flue products shall be above the level of the heaters.

630.4 Installation in commercial garages and air-craft hangars. Overhead infrared heaters installed in garages for more than three motor vehicles or in aircraft hangars shall be installed in accordance with Sections 305.9, 305.10 and 305.11.

SECTION FGC 631 BOILERS

631.1 Standards. Boilers shall be listed in accordance with the requirements of ANSI Z21.13/CSA 4.9 or UL 795. If applicable, the boiler shall be designed and constructed in accordance with the requirements of ASME CSD-1 and as applicable, the *ASME Boiler and Pressure Vessel Code*, Sections I, II, IV, V, VI and IX ~~[7]~~ and NFPA ~~[8501, NFPA 8502 and NFPA 8504]~~ 85. Low-pressure boilers shall conform to the requirements of 12 NYCRR Part 4 and high-pressure boilers shall conform to the requirements of 12 NYCRR Part 14.

631.2 Installation. In addition to the requirements of this code, the installation of boilers shall be in accordance with the manufacturer’s instructions and the *New York City Mechanical Code*. Operating instructions of a permanent type shall be attached to the boiler. Spill switches must be installed on all flue gas draft openings and interlocked with all vented appliances. Boilers shall have all controls set, adjusted and tested by the installer. A complete control diagram together with complete boiler operating instructions shall be furnished by the installer. The manufacturer’s rating data and the nameplate shall be attached to the boiler.

631.3 Clearance to combustible materials. Clearances to combustible materials shall be in accordance with Section 308.4.

**SECTION FGC 632
EQUIPMENT INSTALLED IN EXISTING UNLISTED BOILERS**

632.1 General. Gas equipment installed in existing unlisted boilers shall comply with Section 631.1 and shall be installed in accordance with the manufacturer’s instructions and *the New York City Mechanical Code*.

**SECTION FGC 633
[FUEL CELL POWER PLANTS]
STATIONARY FUEL CELL POWER SYSTEMS**

633.1 General. Stationary fuel[-]cell power systems having a power output not exceeding [4] 10 MW shall be tested in accordance with ANSI/CSA America FC 1 and shall be installed in accordance with the manufacturer’s [~~installation~~] instructions, NFPA 853, the *New York City Building Code*, the *New York City Fire Code* [;] and [~~with National Electric Code Article 692 Fuel Cell Systems~~] the New York City Electrical Code. Indoor stationary fuel cell power systems used in hydrogen generating systems shall be located in accordance with the requirements of Section 706 of this code.

**SECTION FGC 634
CHIMNEY DAMPER OPENING AREA**

634.1 Free opening area of chimney dampers. Where an unlisted decorative appliance for installation in a vented fireplace is installed, the fireplace damper shall have a permanent free opening equal to or greater than specified in Table 634.1.

**TABLE 634.1
FREE OPENING AREA OF CHIMNEY DAMPER FOR VENTING FLUE GASES
FROM UNLISTED DECORATIVE APPLIANCES FOR INSTALLATION IN VENTED FIREPLACES**

CHIMNEY HEIGHT (feet)	MINIMUM PERMANENT FREE OPENING (square inches) ^a						
	8	13	20	29	39	51	64
	Appliance input rating (Btu per hour)						
6	7,800	14,000	23,200	34,000	46,400	62,400	80,000

CHIMNEY HEIGHT (feet)	MINIMUM PERMANENT FREE OPENING (square inches) ^a						
	8	13	20	29	39	51	64
	Appliance input rating (Btu per hour)						
8	8,400	15,200	25,200	37,000	50,400	68,000	86,000
10	9,000	16,800	27,600	40,400	55,800	74,400	96,400
15	9,800	18,200	30,200	44,600	62,400	84,000	108,800
20	10,600	20,200	32,600	50,400	68,400	94,000	122,200
30	11,200	21,600	36,600	55,200	76,800	105,800	138,600

For SI: 1 inch = 25.4 mm, 1 foot = 304.8 mm, 1 square inch = 645.16mm², 1 British thermal unit per hour = 0.2931 W.

c. The first six minimum permanent free openings (8 to 51 square inches) correspond approximately to the cross-sectional areas of chimneys having diameters of 3 through 8 inches, respectively. The 64-square-inch opening corresponds to the cross-sectional area of standard 8-inch by 8-inch chimney tile.

SECTION FGC 635 GASEOUS HYDROGEN SYSTEMS

635.1 Installation. The installation of gaseous hydrogen systems shall be in accordance with the applicable requirements of the *New York City Fire Code*, the *New York City Building Code*, and Chapter 7 of this code [5].

SECTION FGC 636 OUTDOOR DECORATIVE APPLIANCES

636.1 General. Permanently fixed-in-place outdoor decorative appliances shall be tested in accordance with ANSI Z21.97/CSA 2.41 and shall be installed in accordance with the manufacturer's instructions.

§ 8. Chapter 7 of the New York city fuel gas code, as amended by local law number 141 for the year 2013, is amended to read as follows:

CHAPTER 7 GASEOUS HYDROGEN SYSTEMS

SECTION FGC 701 GENERAL

701.1 Scope. The installation of gaseous hydrogen systems shall comply with this chapter and Chapters [30 and 35] 53 and 58 of the *New York City Fire Code*. Compressed gases shall also comply with Chapter [27] 50 of the *New York City Fire Code* for general requirements.

701.2 Permits. Permits shall be required as set forth in Section 106 and as required by the *New York City Fire Code*.

SECTION FGC 702
RESERVED

SECTION FGC 703
GENERAL REQUIREMENTS

703.1 Hydrogen generation. The generation of gaseous hydrogen for immediate on-premises use in indoor fuel cells or other energy production process and incidental indoor storage of gaseous hydrogen shall be located in accordance with Section 706. Exhaust ventilation shall be required in rooms or spaces that house such generation of gaseous hydrogen in accordance with the applicable provisions of NFPA 2.

SECTION FGC 704
RESERVED

SECTION FGC 705
RESERVED

SECTION FGC 706
LOCATION OF GASEOUS HYDROGEN SYSTEMS

706.1 General. The location and installation of gaseous hydrogen systems and appliances shall be in accordance with Sections 706.2 and 706.3.

Exception: Outdoor stationary fuel cell power plants in accordance with Section 633.

Indoor stationary fuel cell power systems used in hydrogen generating systems shall be located in accordance with the requirements of Section 706.

706.2 Indoor gaseous hydrogen systems. Gaseous hydrogen systems shall be located in hydrogen fuel gas rooms constructed in accordance with the *New York City Building Code*, the *New York City Mechanical Code*, the *New York City Fire Code* and NFPA 2.

706.3 Outdoor gaseous hydrogen systems. Gaseous hydrogen systems located outdoors shall be in accordance with the *New York City Fire Code*.

§ 9. Chapter 8 of the New York city fuel gas code is REPEALED, and a new Chapter 8 is added to read as follows:

CHAPTER 8
REFERENCED STANDARDS

SECTION FGC 801
GENERAL

801.1 General. This chapter lists the standards that are referenced in various sections of this document. The standards are listed herein by the promulgating agency of the standard, the standard

identification, the effective date and title and the section or sections of this document that reference the standard.

801.2 Subsequent additions, modifications or deletions. Refer to the rules of the department for any subsequent additions, modifications or deletions that may have been made to these standards in accordance with Section 28-103.19 of the *Administrative Code*.

801.3 Applicability. The application of the referenced standards shall be as specified in Section 102.8

SECTION FGC 802
STANDARDS

<u>ANSI</u>	<u>American National Standards Institute</u> 11 West 42nd Street New York, NY 10036	
<u>Standard reference number</u>	<u>Title</u>	<u>Referenced in code section number</u>
<u>ANSI/CSA America FC1—2012</u>	<u>Stationery Fuel Cell Power Systems</u>	<u>633.1</u>
<u>NSF/ANSI 169 — 2016</u>	<u>Special Purpose Food Equipment and Devices</u>	<u>411.1.1</u>
<u>B109.1 —19</u>	<u>Diaphragm-Type Gas Displacement Meters (Under 500 Cubic Feet Per Hour Capacity)</u>	<u>401.1.2</u>
<u>B109.2—00 (R2008)</u>	<u>Diaphragm Type Gas Displacement Meters (500 Cubic Feet per Hour Capacity and over)</u>	<u>401.1.2</u>
<u>B109.3—19</u>	<u>Rotary-Type Gas Displacement Meters</u>	<u>401.1.2</u>
<u>Z21.1—2010</u>	<u>Household Cooking Gas Appliances</u>	<u>623.1</u>
<u>Z21.5.1/ CSA 7.1—2014</u>	<u>Gas Clothes Dryers—Volume I—Type 1 Clothes Dryers</u>	<u>613.1</u>
<u>Z21.5.2/ CSA 7.2—2014</u>	<u>Gas Clothes Dryers - Volume II- Type 2 Clothes Dryers</u>	<u>613.1, 614.3</u>
<u>Z21.8—94 (R2002)</u>	<u>Installation of Domestic Gas Conversion Burners</u>	<u>619.1</u>
<u>Z21.10.1/CSA 4.1/—2012</u>	<u>Gas Water Heaters - Volume I - Storage, Water Heaters with Input Ratings of 75,000 Btu per Hour or Less</u>	<u>624.1</u>
<u>Z21.10.3/CSA 4.3—2011</u>	<u>Gas Water Heaters - Volume III - Storage, Water Heaters with Input Ratings Above 75,000 Btu per hour, Circulating and Instantaneous</u>	<u>624.1</u>
<u>Z21.13/CSA 4.9—2011</u>	<u>Gas-fired Low-pressure Steam and Hot Water Boilers</u>	<u>631.1</u>
<u>Z21.15/CGA 9.1—09</u>	<u>Manually Operated Gas Valves for Appliances, Appliance Connector Valves and Hose End Valves</u>	<u>Table 409.1.1</u>

<u>ANSI</u>	<u>American National Standards Institute</u> <u>11 West 42nd Street</u> <u>New York, NY 10036</u>	
<u>Standard reference number</u>	<u>Title</u>	<u>Referenced in code section number</u>
<u>Z21.18—2007 (R2017)</u>	<u>Gas Appliance Pressure Regulators</u>	<u>410.3</u>
<u>Z21.19/CSA 1.4—02 (R2007)</u>	<u>Refrigerators Using Gas (R1999) Fuel</u>	<u>625.1</u>
<u>Z21.21/CSA 6.5—05</u>	<u>Automatic Valves for Gas Appliances</u>	<u>603.2</u>
<u>Z21.24/CGA 6.10—06</u>	<u>Connectors for Gas Appliances</u>	<u>411.1, 411.3</u>
<u>Z21.40.1/CGA 2.91—96 (R2011)</u>	<u>Gas-fired Heat Activated Air Conditioning and Heat Pump Appliances</u>	<u>627.1</u>
<u>Z21.40.2/CGA 2.92—96 (R2011)</u>	<u>Gas-fired Work Activated Air Conditioning and Heat Pump Appliances (Internal Combustion)</u>	<u>627.1</u>
<u>Z21.42—2014</u>	<u>Gas-Fired Illuminating Appliances</u>	<u>628.1</u>
<u>Z21.47/CSA 2.3—2012</u>	<u>Gas-fired Central Furnaces</u>	<u>618.1</u>
<u>Z21.50/CSA 2.22—2012</u>	<u>Vented Gas Fireplaces</u>	<u>601.2, 604.1</u>
<u>Z21.54—09</u>	<u>Gas Hose Connectors for Portable Outdoor Gas Fired Appliances</u>	<u>411.1</u>
<u>Z21.56/CSA 4.7—2013</u>	<u>Gas-fired Pool Heaters</u>	<u>617.1</u>
<u>Z21.58/CSA 1.6—2013</u>	<u>Outdoor Cooking Gas Appliances</u>	<u>623.1</u>
<u>Z21.60/CSA 2.26—2012</u>	<u>Decorative Gas Appliances for Installation in Solid-fuel Burning Fireplaces</u>	<u>601.2, 602.1</u>
<u>Z21.69/CSA 6.16—09</u>	<u>Connectors for Movable Gas Appliances</u>	<u>411.1.1, 411.1.4</u>
<u>Z21.75/CSA 6.27—07</u>	<u>Connectors for Outdoor Gas Appliances and Manufactured Homes</u>	<u>411.1, 411.2</u>
<u>Z21.80/CSA 6.22—11</u>	<u>Line Pressure Regulators</u>	<u>410.1</u>
<u>Z21.84—2012</u>	<u>Manually-lighted, Natural Gas Decorative Gas Appliances for Installation in Solid Fuel Burning Fireplaces</u>	<u>602.1, 602.2</u>
<u>Z21.86/CSA 2.32—08</u>	<u>Vented Gas-fired Space Heating Appliances</u>	<u>608.1, 622.1</u>
<u>Z21.88/CSA 2.33—2014</u>	<u>Vented Gas Fireplace Heaters</u>	<u>605.1</u>
<u>Z21.97/CSA 2.41—2012</u>	<u>Outdoor Decorative Appliances</u>	<u>636.1</u>

<u>ANSI</u>	<u>American National Standards Institute</u> <u>11 West 42nd Street</u> <u>New York, NY 10036</u>	
<u>Standard reference number</u>	<u>Title</u>	<u>Referenced in code section number</u>
<u>Z83.4/CSA 3.7—2012</u>	<u>Nonrecirculating Direct-gas-fired Industrial Air Heaters</u>	<u>611.1</u>
<u>Z83.8/CSA 2.6—09</u>	<u>Gas Unit Heater, Gas Packaged Heater, Gas Utility Heaters and Gas-fired Duct Furnaces</u>	<u>610.1, 620.1</u>
<u>Z83.11/CSA 1.8—2013</u>	<u>Gas Food Service Equipment</u>	<u>623.1</u>
<u>Z83.18—00</u>	<u>Recirculating Direct Gas-fired Industrial Air Heaters</u>	<u>612.1</u>
<u>Z83.19/CSA 2.35—01(R2009)</u>	<u>Gas-fired High-intensity Infrared Heaters</u>	<u>630.1</u>
<u>Z83.20/CSA 2.34—08</u>	<u>Gas-fired Low-intensity Infrared Heaters</u>	<u>630.1</u>

<u>ASME</u>	<u>American Society of Mechanical Engineers</u> <u>Three Park Avenue</u> <u>New York, NY 10016-5990</u>	
<u>Standard reference number</u>	<u>Title</u>	<u>Referenced in code section number</u>
<u>A13.1—2015</u>	<u>Scheme for the Identification of Piping Systems</u>	<u>401.5, 411.1, 411.2, G.5.3</u>
<u>B1.20.1—83 (Reaffirmed 2006)</u>	<u>Pipe Threads, General Purpose (inch)</u>	<u>403.9</u>
<u>B16.5—R2009</u>	<u>Pipe Flanges and Flanged Fittings: NPS 1/2 through NFPS 24 Metric/Inch Standard</u>	<u>403.12.2</u>
<u>B16.20—2017</u>	<u>Metallic Gaskets for Pipe Flanges</u>	<u>403.13.1</u>
<u>B16.21—2016</u>	<u>Nonmetallic Flat Gaskets for Pipe Flanges</u>	<u>403.13.2</u>
<u>B16.33—2012</u>	<u>Manually Operated Metallic Gas Valves for Use in Gas Piping Systems up to 125 psig (Sizes ½ through 2)</u>	<u>Table 409.1.1</u>
<u>B16.42—2011</u>	<u>Ductile Iron Pipe Flanges and Flanged Fittings, Classes 150 and 300</u>	<u>403.12.4</u>
<u>B16.44—2002 (Reaffirmed 2007)</u>	<u>Manually Operated Metallic Gas Valves for Use in Aboveground Piping Systems Up to 5 psi</u>	<u>Table 409.1.1</u>
<u>B16.47—2011</u>	<u>Large Diameter Steel Flanges: NPS 26 through NPS 60 Metric/Inch Standard</u>	<u>403.12.2</u>
<u>B31.1—12</u>	<u>Power Piping Code</u>	<u>G.5.1</u>

<u>ASME</u>	<u>American Society of Mechanical Engineers</u> <u>Three Park Avenue</u> <u>New York, NY 10016-5990</u>	
<u>Standard reference number</u>	<u>Title</u>	<u>Referenced in code section number</u>
<u>B36.10M—2004</u>	<u>Welded and Seamless Wrought-steel Pipe</u>	<u>403.4.2</u>
<u>B40.100—2013</u>	<u>Pressure Gauges and Gauge Attachments</u>	<u>406.4.3</u>
<u>BPVC—2010/2011 addenda</u>	<u>ASME Boiler & Pressure Vessel Code</u>	<u>404.21.1,</u> <u>406.1.1.1, 624.2,</u> <u>631.1</u>
<u>CSD-1—2012</u>	<u>Controls and Safety Devices for Automatically Fired Boilers</u>	<u>619.1, 631.1</u>

<u>ASNT</u>	<u>American Society for Nondestructive Testing</u> <u>PO Box 28518</u> <u>1/11 Arlington Lane</u> <u>Columbus, OH 43228</u>	
<u>Standard reference number</u>	<u>Title</u>	<u>Referenced in code section number</u>
<u>SNT—TC—1A—2016</u>	<u>Recommended Practice</u>	<u>404.21.1</u>

<u>ASTM</u>	<u>ASTM International</u> <u>100 Barr Harbor Drive</u> <u>West Conshohocken, PA 19428</u>	
<u>Standard reference number</u>	<u>Title</u>	<u>Referenced in code section number</u>
<u>A53/A53M—12</u>	<u>Specification for Pipe, Steel, Black and Hot Dipped Zinc-coated Welded and Seamless</u>	<u>403.4.2</u>
<u>A106/A106M—11</u>	<u>Specification for Seamless Carbon Steel Pipe for High-temperature Service</u>	<u>403.4.2</u>
<u>C64—72 (1977)</u>	<u>Withdrawn No Replacement (Specification for Fireclay Brick Refractories for Heavy Duty Stationary Boiler Service)</u>	<u>503.10.2.5</u>
<u>C315—07(2011)</u>	<u>Specification for Clay Flue Liners and Chimney Pots</u>	<u>501.12</u>
<u>E136—2012</u>	<u>Standard Test Method for Behavior of Materials in a Vertical Tube Furnace at 750°C</u>	<u>202</u> <u>(Noncombustible materials)</u>

<u>CAN/ULC</u>	<u>Standards Council of Canada</u> <u>270 Albert Street, Suite 200</u> <u>Ottawa ON KIP 6N7</u> <u>Canada</u>	
<u>Standard reference number</u>	<u>Title</u>	<u>Referenced in code section number</u>
<u>S635—16</u>	<u>Standard for Lining Systems for Existing Masonry or Factory-Built Chimneys and Vents</u>	<u>501.12, 501.15.4</u>
<u>S640—16</u>	<u>Standard for Lining Systems for New Masonry Chimneys</u>	<u>501.12</u>

<u>CSA</u>	<u>CSA Group</u> <u>8501 East Pleasant Valley Road</u> <u>Cleveland, OH 44131-5516</u>	
<u>Standard reference number</u>	<u>Title</u>	<u>Referenced in code section number</u>
<u>ANSI/CSA America FC1—2012</u>	<u>Stationary Fuel Cell Power Systems</u>	<u>633.1</u>

<u>MSS</u>	<u>Manufacturers Standardization Society of the Valve & Fittings Industry, Inc.</u> <u>127 Park Street, N.E.</u> <u>Vienna, VA 22180</u>	
<u>Standard reference number</u>	<u>Title</u>	<u>Referenced in code section number</u>
<u>ANSI/SP-58—2009</u>	<u>Pipe Hangers and Supports—Materials Design and Manufacture, Selection, Application and Installation</u>	<u>407.2</u>

<u>NFPA</u>	<u>National Fire Protection Association</u> <u>1 Batterymarch Park</u> <u>Quincy, MA 02169-7471</u>	
<u>Standard reference number</u>	<u>Title</u>	<u>Referenced in code section number</u>
<u>2—16</u>	<u>Hydrogen Technologies Code</u>	<u>703.1, 706.2</u>
<u>30A—15</u>	<u>Code for Motor Fuel Dispensing Facilities and Repair Garages</u>	<u>305.4, 305.10</u>
<u>37—15</u>	<u>Standard for the Installation and Use of Stationary Combustion Engines and Gas Turbines</u>	<u>616.1, G.3.1.1</u>

<u>NFPA</u>	<u>National Fire Protection Association</u> <u>1 Batterymarch Park</u> <u>Quincy, MA 02169-7471</u>	
<u>Standard reference number</u>	<u>Title</u>	<u>Referenced in code section number</u>
<u>54—16</u>	<u>National Fuel Gas Code</u>	<u>501.2.2, 609.9</u>
<u>56PS—12</u>	<u>Standard for Fire and Explosion Prevention During Cleaning and Purging of Flammable Gas Piping Systems</u>	<u>G.7</u>
<u>68—07</u>	<u>Standard for Explosion Protection by Deflagration Venting</u>	<u>E.2.1, G.3.1</u>
<u>69—14</u>	<u>Standard on Explosion Prevention Systems</u>	<u>E.2.1, G.2.5.1, G.3.2</u>
<u>72—16*</u> <u>*As modified by Appendix Q of the New York City Building Code</u>	<u>National Fire Alarm and Signaling Code</u>	<u>G.2.4.3</u>
<u>82—14</u>	<u>Incinerators, Waste and Linen Handling Systems and Equipment</u>	<u>503.2.5, Table 503.4, 607.1</u>
<u>85—15</u>	<u>Boiler and Combustion Systems Hazards Code</u>	<u>631.1</u>
<u>88A—15</u>	<u>Parking Structures</u>	<u>305.9</u>
<u>211—13</u>	<u>Standard for the Chimneys, Fireplaces, Vents and Solid Fuel-burning Appliances</u>	<u>502.1, 503.5.2, 503.5.3, 503.5.6.1, 503.5.6.3</u>
<u>409—11</u>	<u>Standard for the Aircraft Hangars</u>	<u>305.11</u>
<u>853—15</u>	<u>Installation of Stationary Fuel Cell Power Systems</u>	<u>633.1</u>

1

<u>UL</u>	<u>UL LLC</u> <u>333 Pfingsten Road</u> <u>Northbrook, IL 60062-2096</u>	
<u>Standard reference number</u>	<u>Title</u>	<u>Referenced in code section number</u>
<u>103—2010</u>	<u>Factory-built Chimneys, Residential Type and Building Heating Appliances—with Revisions through July 2012</u>	<u>506.1</u>
<u>441—2010</u>	<u>Gas Vents</u>	<u>502.1</u>
<u>536—2014</u>	<u>Flexible Metallic Hose</u>	<u>405.5</u>
<u>641—2010</u>	<u>Type L Low-temperature Venting Systems—with Revisions through May 2013</u>	<u>502.1</u>
<u>795—2011</u>	<u>Commercial-industrial Gas Heating Equipment</u>	<u>610.1, 618.1, 631.1</u>

<u>UL</u>	<u>UL LLC</u> <u>333 Pfingsten Road</u> <u>Northbrook, IL 60062-2096</u>	
<u>Standard reference number</u>	<u>Title</u>	<u>Referenced in code section number</u>
<u>959—2010</u>	<u>Medium Heat Appliance Factory-built Chimneys</u>	<u>506.3</u>
<u>1618—2009</u>	<u>Wall Protectors, Floor Protectors and Hearth Extensions— with Revisions through May 2013</u>	<u>308.2</u>
<u>1738—2010</u>	<u>Venting Systems for Gas Burning Appliances, Categories II, III and IV— with Revisions through May 2011</u>	<u>502.1</u>
<u>1777—2007</u>	<u>Standard for Chimney Liners-with revisions through October 2015</u>	<u>501.12, 501.15.4</u>
<u>2034—2008</u>	<u>Standard for Single- and Multiple-Station Carbon Monoxide Alarm - with Revisions through February 2009</u>	<u>303.3.1.2</u>
<u>2075—2013</u>	<u>Standard for Gas and Vapor Detectors and Sensors</u>	<u>303.3.1.3</u>

1
2 § 10. Appendix E of the New York city fuel gas code, as added by local law number
3 33 for the year 2007, sections E.1 and E.3, as amended by local law number 141 for the year 2013, is
4 amended to read as follows:

5 **APPENDIX E**
6 **METERS AND GAS SERVICE PIPING**

7 **E.1 General.** This appendix addresses the requirements for meters and service piping, underground
8 or aboveground, as the piping enters the building. Service piping includes fuel-gas piping, valves,
9 and fittings upstream of the point of delivery. Service piping may include piping supplied by the gas
10 service utility.

11 **E.2 Gas regulator and gas regulator vent outlets.** Gas meter piping supplying gas to a building at
12 a pressure in excess of ½ psig (3.4 kPa gauge) shall be provided with a regulator that will reduce the
13 pressure of the gas to ½ psig (3.4 kPa gauge) or less prior to entering the gas distribution piping in
14 the building, except where the use of higher pressure is permitted. Where gas distribution pressure
15 in excess of ½ psig (3.4 kPa gauge) is permitted, it shall be regulated [~~not~~] to not exceed the
16 maximum pressure level as permitted by the code or the commissioner.

17 **E.2.1** Inside gas meter piping operating at a pressure in excess of 15 psig ([~~403~~] 103.4 kPa gauge)
18 shall comply with the following:

19 **1.** Where such piping is greater than 4 inches ([~~402~~] 101.6 mm) in diameter, the meter piping
20 shall be installed in a properly ventilated meter room of 3-hour fire-rated construction.

21 **2.** The maximum [~~distance~~] total developed length from the outlet of the service [~~line~~]
22 head valve to the inlet of the farthest regulator shall be limited as follows:

SERVICE LINE VALVE SIZE	MAXIMUM DISTANCE (LINEAR FEET OF PIPE)
Up through to 2-inch (51 mm) pipe size	4 feet (1219 mm)
Over 2-inch (51 mm) through 4-inch (102 mm) pipe size	8 feet (2438 mm)
Over 4-inch (102 mm) through 8-inch (203 mm) pipe size	15 feet (4572 mm)
10-inch (254 mm) pipe size and larger	20 feet (6096 mm)

1
2 3. Where these maximum distances cannot be met, the following shall be required:
3

FOOTAGE (LINEAR FEET OF PIPE) IN EXCESS OF ABOVE REQUIREMENTS	ADDITIONAL REQUIREMENTS
Up to 5 feet (1534 mm)	The meter room shall have [3-hour fire-rating] <u>3-hour fire-rated</u> construction and adequate ventilation
Over 5 feet (1524 mm) through 10 feet (3048 mm)	Above requirements plus a combustible gas-detection alarm system
Over 10 feet (3048 mm) through 15 feet (4572 mm)	Above requirements plus special inspection by the customer, or his or her representative as required by the <i>New York City Building Code</i> .
Over 15 feet (4572 mm) through 20 feet (6096 mm)	Above requirements plus <u>(i) automatic gas shutoff devices; and (ii) explosion venting per NFPA 68 and NFPA 69 or alternative ventilation acceptable to the commissioner</u> [and automatic gas shutoff devices]
Over 20 feet (6096 mm)	Above requirements plus suitable fire protection approved by the commissioner

4
5 For new gas installations made in existing structures, the above requirements shall be used
6 to the extent feasible. Alternate designs may be considered by the commissioner.

7 **E.2.2** When located inside the building, each regulator shall be provided with a vent pipe that
8 leads directly to the outdoor air. The vent pipe shall be sized according to local utility
9 requirements. The vent outlet shall not be located under a window or any opening leading back
10 into the premises or located below any overhang or projection. No gas regulator vent outlet shall
11 be covered over, plugged up, or otherwise obstructed, and all gas vents shall be identified by
12 suitable marking on the outlet on the outside of the building. For buildings located in flood hazard
13 areas, gas regulator vent outlets shall be installed in accordance with the additional requirements
14 of Appendix G of the *New York City Building Code*.

15 ~~**E.2.3** Gas appliance pressure regulators requiring access to the atmosphere for successful~~
16 ~~operation shall be equipped with vent leading to the outdoors, unless constructed or equipped~~

1 ~~with a vent limiting means to limit the escape of gas from the vent opening in the event of~~
2 ~~diaphragm failure.]~~

3 **E.3 Gas meter location.** Gas meter location shall comply with the following:

- 4 1. When located inside the building, meters shall be located as near as practicable to the point
5 of entrance of the service and, where possible, the meters shall be located in the cellar or
6 basement unless otherwise permitted by the commissioner. The meter location shall be clean,
7 dry, and free of refuse, steam or chemical fumes and located not less than 3 feet ([914] 914.4
8 mm) from any source of ignition or any source of heat which might cause damage to the
9 meter. Meters shall be adequately protected against extreme cold or heat and shall be readily
10 accessible for reading and inspection. The area in which the meter is located shall be properly
11 ventilated as per Section E.4. Notwithstanding the foregoing, outside meter installation shall
12 be permitted in areas where the utility company certifies that dry gas is being distributed.

13 **Exception.** Gas meter locations in one- and two-family dwellings shall not require
14 ventilation.

- 15 2. No gas meter, other than the replacement of an existing meter shall be located in any boiler
16 room or other room or space containing a heating boiler, in any stair hall, nor in any public
17 hall above the cellar or above the lowest story if there is no cellar. [~~However, where there is~~
18 ~~an existing gas meter located in any boiler room or other room or space containing a heating~~
19 ~~boiler, one additional gas meter may be installed in such room or space, provided such~~
20 ~~additional gas meter is installed adjacent to the existing gas meter and is used in conjunction~~
21 ~~with the supply of gas for a gas-fired heating boiler or a gas-fired water heater used as a~~
22 ~~central source of supply of heat or hot water for the tenants. Such additional gas meter may~~
23 ~~be installed only upon the condition that space heaters or hot water appliances in the tenant~~
24 ~~spaces are eliminated.]~~

- 25 3. Gas meter rooms, when provided, shall at all times be kept clear of all rubbish; and shall not be
26 used in any way for storage purposes, including material or equipment of any kind. A legible
27 sign reading “Gas meter room—No storage permitted” shall be permanently and conspicuously
28 posted on the exterior of the meter room door, except that the sign may be posted on the interior
29 of the meter room door in Occupancy Group R-3. The lettering of such signs shall be of bold
30 type at least 1 inch ([25] 25.4 mm) in height and shall be properly spaced to provide good
31 legibility. The lettering and background shall be of contrasting colors. Where gas meters and
32 related equipment are not located in a separate room but are located in an open floor area, no
33 combustible material shall be stored or kept within 5 feet (1524 mm) of such equipment; nor
34 shall the gas meter be within 3 feet ([914] 914.4 mm) of any heating boiler or sources of ignition
35 and, except Occupancy Group R-3, there shall be a physical barrier required if the room is also
36 used for storage purposes or the like.

- 37 4. The installation of gas meter piping shall be made in accordance with the requirements of this
38 code and the local utility company.

1 5. Piping containing gas with a pressure exceeding ½ psig (3.4 kPa gauge) and the gas service
2 pressure regulator which may be subjected to accidental vehicular impact shall be suitably
3 protected.

4 **E.4 Gas meter room ventilation.** Any one of the following methods shall be considered sufficient
5 to provide proper ventilation to a room or space in which a gas meter(s) is installed:

6 1. An opening to the outside air in the wall of such room or space, provided the free area of the
7 opening is not less than 30 square inches (19 321 mm²).

8 2. A duct or pipe having a cross-section area of at least 50 square inches (32 522mm²) of free area
9 and a maximum length of 15 feet (4572 mm) leading to the outside air. [~~If a longer duct is~~
10 ~~required due to the building construction, the area of the duct should be increased accordingly,~~
11 ~~subject to the approval of the commissioner.~~] However, under no circumstances shall the means
12 of ventilation for the gas meter room or space be from an adjoining room or space within the
13 building.

14 [~~The above requirement is not applicable to one and two family dwellings, since the gas meter~~
15 ~~is available for continuous supervision.~~]

16 **E.5 Gas service piping connections.** Gas service piping connections shall comply with the
17 following:

18 1. Gas service piping shall be fitted with a gas service line valve, the valve located on the supply
19 side of the meter and service regulator, if a service regulator is required. [~~If~~] Where a plug-
20 type valve is used, it shall be constructed so as to prevent the core from being blown out by
21 the pressure of the gas. In addition, it shall be of a type capable of being locked in the off
22 position by the local gas utility. [~~When~~] Where the gas service line valve is inside the
23 building, it shall be in an accessible location within 2 feet ([~~640~~] 609.6 mm) of the point
24 where the gas service connection enters the building or at such other location as may be
25 permitted by the commissioner. Where the gas service connection is installed through a
26 building wall below ground, it shall be protected with a wall sleeve extending at least 4
27 inches ([~~402~~] 101.6 mm) beyond the outer side of the wall and at least 1 inch ([~~25~~] 25.4 mm)
28 beyond the inner side of the wall. The sleeve shall be sealed at both ends to prevent the entry
29 of water and gas. Gas service connections, installed through ground slab construction, shall
30 be protected with a floor sleeve sealed at both ends to prevent the entry of water and gas.
31 The sleeve shall extend at least 4 inches ([~~402~~] 101.6 mm) above the floor, and shall be
32 installed as specified by the utility company providing the service. It shall terminate at least
33 4 inches ([~~402~~] 101.6 mm) outside the building.

34 2. In all high-pressure areas, the utility company providing the service may inspect the gas
35 service line valve and regulator in accordance with the provisions of 16 NYCRR Part 255 in
36 addition to the department in accordance with Section 406 of this code.

37 3. No gas service shall enter a structure at a horizontal distance of less than 10 feet (3048 mm)
38 from the cellar termination of a stairway, nor shall any gas meters or gas regulators be located
39 less than 10 feet (3048 mm) from such stairway termination. Where such services, meters

1 and regulators are separated from the stairway termination by a permanent partition or wall
2 having a fire-resistance rating of at least 1 hour, the foregoing shall not apply. Unless
3 forbidden by other provisions of this code, locations under a stairway are exempt from this
4 requirement.

5 4. When the structure is erected on fill or on piles, provision shall be made to preclude possible
6 damage to the gas service piping caused by settlement.

7 5. The installation of gas service piping shall be made in accordance with the requirements of
8 the utility corporation providing the service as regulated by the provisions of 16 NYCRR
9 Part 255. Further, such installation shall meet the requirements of the department.

10 6. Gas service piping outside a structure shall be installed not less than 24 inches ([610] 609.6
11 mm) below grade, except that a lesser distance of not less than 18 inches ([457] 457.2 mm)
12 may be permitted, provided the piping is adequately protected in accordance with the
13 requirements of this code and the utility corporation supplying service, and the piping is not
14 located below a driveway. Any piping that is exposed to outdoor temperatures or installed
15 underground with a cover of less than 2 feet ([610] 609.6 mm) shall be protected against
16 frost, except that frost protection may be omitted in areas where the utility company certifies
17 that dry gas is being distributed.

18 **E.6 Outside gas cut-off.** Outside gas cut-off shall comply with the following:

19 1. An outside gas service line valve or other outside emergency shutoff device, or other means
20 acceptable to the commissioner and the Fire Commissioner, shall be installed in every gas
21 service pipe outside the building. If buried, such valve, device or method shall be readily
22 accessible from grade. Every existing service which is being replaced or refurbished shall be
23 provided with such valve, device or means, but in any event, all existing gas services shall be
24 provided with such valve, device or method by January 1, 2010. However, in Group R-3
25 occupancy the completion date shall be January 1, 2020. The utility company shall provide the
26 Fire Department with suitable tools for operation of such emergency shutoff valves, devices or
27 means. The number of such tools required for supplying Fire Department units shall be
28 determined by the Fire Department. On or before January 31, of each year, the utility company
29 shall report to the department and the Fire Department the actual number of emergency shutoff
30 valves installed for the preceding year.

31 2. If the outside gas service line valve, emergency shutoff device or means is located below
32 ground, it shall be installed in a protective housing, and [~~a cover,~~] an easily identifiable cover
33 shall be provided for the housing. The cover shall be flush with the surface of the ground and
34 kept clear at all times so as to be accessible for immediate use.

35 3. The valve or emergency shutoff device shall be capable of being readily operated by removing
36 the cover of the housing and inserting a portable key or other device over the operating end of
37 the valve or emergency shutoff device.

1 4. If the outside gas service line valve is located above ground, it shall be suitably protected to
2 prevent accidental vehicular impact and must be installed in accordance with provisions of 16
3 NYCRR Part 255.

4 5. Where a gas-fired generator provides required emergency power in accordance with the *New*
5 *York City Building Code*, such generator shall have an outside gas cut-off valve that is separate
6 from other gas services to the buildings. Such valves shall be identified by signage.

7 Subpart 10 (Appendix F of the New York City Fuel Gas Code)

8 § 11. The New York city fuel gas code is amended by adding a new appendix
9 F to read as follows:

10 **APPENDIX F**
11 **RESERVED**

12 § 12. Appendix G of the New York city fuel gas code, as added by local law
13 number 141 for the year 2013, is amended to read as follows:

14 **APPENDIX G**
15 **HIGH PRESSURE NATURAL GAS INSTALLATIONS**

16 **G.1 General.** This appendix addresses natural gas distribution piping requirements for systems where
17 the gas pressure is at or above 15 psig (~~[103]~~ 103.4 kPa gauge). Installations of gas piping at pressures
18 at or above 15 psig (~~[103]~~ 103.4 kPa gauge) and equipment and appliances using gas with an inlet
19 pressure at or above 15 psig (~~[103]~~ 103.4 kPa gauge) shall be considered as high pressure natural gas
20 installations.

21 **G.1.1 Fire Department approval.** High pressure natural gas installations shall be approved by
22 the Fire Department. All design documents associated with the installation shall be submitted to
23 the Fire Department for approval. The Fire Department shall witness and approve final testing of
24 the installation.

25 **G.1.2 Certificate of fitness.** High pressure natural gas installations shall be operated under the
26 supervision of a person holding a Certificate of Fitness issued by the Fire Department when
27 required by the *New York City Fire Code*.

28 **G.2 Construction requirements.** Buildings with high pressure natural gas installations shall meet
29 the requirements of this section.

30 **G.2.1 Structural requirements.** The structural integrity of the building shall meet the
31 requirements of Section 1615.6 of the *New York City Building Code* for gas explosions. An
32 explosion analysis shall be conducted where the gas pressure exceeds 125 psig (~~[862]~~ 861.8 kPa
33 gauge). Where an explosion analysis shows explosion pressure exceeding 430 psf (20.5 kPa
34 gauge), the building's structural integrity shall be maintained at pressure levels determined by the

1 explosion analysis. The explosion scenario and explosion analysis shall be approved by the Fire
2 Department.

3 **G.2.2 [~~Fire-resistance-rated~~] Fire-resistance-rated rooms and spaces.** Rooms and spaces
4 containing high pressure natural gas piping shall be separated from all other areas of the building
5 by fire barriers or horizontal assemblies, or both, having a fire-resistance rating of not less than 3
6 hours.

7 **G.2.2.1 Shaft requirements.** Vertical runs of high pressure gas piping within a building shall
8 be enclosed in masonry shafts constructed of walls not less than 4 inches (~~[100]~~ 101.6 mm) in
9 thickness and sealed to prevent any gas leakage from the shaft. Such shaft shall be vented to
10 the outdoors at the top. Such shaft shall not be located adjacent to an exit stairway or exit
11 passageway unless the shaft wall separating the exit stairway or exit passageway from the
12 shaft is designed to resist a potential gas explosion in accordance with Section 1615.6 of the
13 *New York City Building Code*.

14 **G.2.3 Automatic sprinkler system.** Buildings and structures shall be equipped throughout with
15 an automatic sprinkler system in accordance with Section 903.3.1.1 of the *New York City Building*
16 *Code*, except where an alternative fire-extinguishing system is approved in accordance with
17 [~~Section 904.1 of~~] the *New York City Fire Code* and the *New York City Building Code*.

18 **G.2.4 Gas detection.** Rooms and spaces containing [~~the~~] high pressure gas piping must be
19 equipped with an approved and listed gas detection alarm system.

20 **G.2.4.1 Gas detection system.** A gas detection system including placement of gas detectors
21 shall be installed in accordance with the manufacturer's recommendations, its listing and
22 Section 908 of the *New York City Building Code*.

23 **G.2.4.2 Supervision.** Gas detectors shall be supervised by a building fire alarm system in
24 buildings where fire alarm systems are required or installed.

25 **G.2.4.3 Power supply.** Power supply to the system, wiring of the system, its associated
26 components and outputs shall be in accordance with NFPA 72 as modified by Appendix Q of
27 the *New York City Building Code* and Section 907 of the *New York City Building Code*.

28 **G.2.4.4 Alarm.** An audible and visual alarm shall be provided at the gas detection panel with
29 an audible silence switch only.

30 **G.2.4.5 Alarm transmission.** The gas detection system shall transmit a trouble signal and an
31 alarm to the supervising station and to a 24-hour supervised location within the building.

32 **G.2.4.6 Shutoff valves closure.** The gas detection system alarm activation shall trigger
33 emergency gas shutoff valves serving the affected area to close and stop the gas flow.

34 **G.2.5 Ventilation.** Rooms containing appliances or equipment operating with gas pressure at or
35 above 15 psig (~~[103]~~ 103.4 kPa gauge) shall be provided with ventilation in accordance with the
36 requirements of Chapter 4 of the *New York City Mechanical Code*.

1 **G.2.5.1 Explosion prevention.** For rooms or spaces containing appliances operating with gas
2 pressure at or above 15 psig (~~[103]~~ 103.4 kPa gauge) and less than 125 psig (~~[862]~~ 861.8 kPa
3 gauge), explosion prevention systems shall be provided in accordance with NFPA 69.

4 **G.3 High hazard.** Rooms and areas containing appliances and equipment operating with gas pressure
5 at or above 125 psig (~~[862]~~ 861.8 kPa gauge) shall be classified as a Group H-2 occupancy and shall
6 comply with the requirements of this section.

7 **G.3.1 Explosion venting.** Appliances and equipment using gas at or above 125 psig (~~[862]~~ 861.8
8 kPa gauge) shall be located in rooms provided with explosion venting in accordance with NFPA
9 68.

10 **G.3.1.1 Gas turbines.** Gas turbine installations shall comply with the requirements of NFPA
11 37 and the requirements of Title 28 of the *Administrative Code*.

12 **G.3.1.2 Gas turbine rooms.** For rooms containing gas turbines and fuel gas compressors, the
13 design of the explosion venting system shall be based on the explosion resulting from the
14 lower explosion limit being achieved within the room housing the turbine or fuel gas
15 compressor, including its enclosure. All control valve stations, filters, and related accessories
16 shall be placed in the gas turbine room or a separately protected room.

17 **G.3.2 Emergency ventilation.** An emergency ventilation system shall be provided in accordance
18 with NFPA 69 and shall be approved by the Fire Department. Ventilation calculations as listed in
19 Annex D Ventilation Calculations of NFPA 69 shall be provided, and the gas release rate shall be
20 approved.

21 **G.3.3 Electrical equipment.** Electrical equipment within rooms and enclosures requiring
22 emergency ventilation shall conform to the *New York City Electrical Code* for Class 1 Division 2
23 requirements.

24 **G.4 Gas meter room.** A gas meter room served by gas at a pressure at or above 15 psig (~~[103]~~ 103.4
25 kPa gauge) shall meet the requirements of ~~[Appendix E of this code and]~~ the *New York City Electrical*
26 *Code* for Class 1 Division 2 requirements, and shall comply with Appendix E of this code.

27 **G.5 Piping requirements.** High pressure gas piping shall comply with the requirements of this
28 section.

29 **G.5.1 Piping material.** Installations of natural gas piping operating at pressures of 125 psig (~~[862]~~
30 861.8 kPa gauge) and above shall comply with the requirements of ASME B 31.1.

31
32 **G.5.2 Double wall piping.** Horizontal piping that traverses within a building from a protected
33 room or shaft to a protected room or shaft shall be run in an outer pipe of the same pressure rating
34 as the inner pipe. The outer pipe shall be welded and the annular space between the inner and
35 outer pipe shall be equal to or greater than the inside diameter of the inner pipe. The annular space
36 shall be monitored for natural gas with an approved gas detection alarm system and shall be vented

1 to the exterior of the building. The outer pipe must open to the shaft and/or protected room or to
2 the outside air.

3 **G.5.3 Piping identification.** Piping shall be identified with markings in accordance with ASME
4 A13.1.

5 **G.5.4 Emergency gas shutoff.** An emergency gas shutoff valve shall be provided on the gas
6 supply outside of any room containing an appliance utilizing gas at a pressure at or above 15 psig
7 (~~[103]~~ 103.4 kPa gauge). The emergency shutoff valve shall be controlled from a break glass
8 station located outside the room served and from the gas detection system monitoring the room.
9 The emergency shutoff valve shall automatically stop the gas flow to the room(s) containing the
10 appliance(s) in the event of an unsafe condition. The emergency shutoff valve shall be manually
11 operable. Emergency gas shutoff valve bypasses shall be prohibited.

12 **G.6 Special inspection required.** The entire high pressure natural gas installation, including piping,
13 equipment, appliances, gas detection and control systems, shall be subject to special inspection as set
14 forth in Section ~~[1704.19]~~ 1705.24 of the *New York City Building Code*.

15 **G.7 Cleaning and purging procedures.** Cleaning and purging procedures for high pressure natural
16 gas piping, equipment and appliances shall be in accordance with ~~[NFPA-56PS]~~ NFPA 56.

17 Section 2. The New York city amendments to section 760.41(B) of the 2008 National
18 Electrical Code as set forth in section 27-3025 of the administrative code of the city of New York, as
19 added by local law number 39 for the year 2011, are amended to read as follows:

20 **(B) Secondary Power Source.** Where an emergency power system is provided or required to be
21 provided for emergency system loads, the fire alarm circuits shall be provided with a secondary power
22 source. Batteries ~~[shall not be a substitute for connection to a]~~ may serve as the secondary power
23 source where allowed by the New York City Building Code. The secondary power source shall
24 comply with the requirements for emergency power systems and/or emergency generator that are
25 used for emergency systems loads as articulated below:

26 **(1) Generally.** Emergency power systems complying with Chapter 27 of the ~~[2008]~~ New York
27 City Building Code shall be permitted to serve as a secondary power source or

28 **(2) Existing Buildings.** Emergency power systems and/or emergency generators in existing
29 buildings in compliance with Title 27, chapter 1, subchapter 6, section 27-396.4 of the
30 Administrative Code (also referred to as the 1968 Building Code) shall be permitted to serve as
31 the secondary power source.

32 The secondary power supply shall be connected such that all other disconnecting means serving
33 other building emergency loads can be opened without de-energizing the facility fire alarm
34 secondary power supply.

1 FPN: The use of a main disconnecting means on the output of the generator(s) is permitted
2 where the disconnection of all other loads does not interrupt the facility fire alarm system
3 secondary power supply.

4 Section 3. Section 4 of local law number 14 for the year 2020 is amended to read as
5 follows:

6 §4. This local law shall take effect on the same date as the effective date of a local law
7 amending the administrative code of the city of New York [in relation to bringing the New York city
8 building code up to date with the 2014 edition of the International Building Code published by the
9 International Code Council] the New York city plumbing code, the New York city building code, the
10 New York city mechanical code and the New York city fuel gas code in relation to bringing such
11 codes and related provisions of law up to date with the 2015 editions of the international building,
12 mechanical, fuel gas and plumbing codes, except that this local law shall not apply to plumbing work
13 related to applications for construction document approval filed prior to such effective date.

14 Section 4. Notwithstanding any other law or rule, tables, figures or equations in PDF
15 or other electronic format to be added to the New York city construction codes or amended pursuant
16 to this local law need not be underlined to denote new matter being added. The absence of underlining
17 to denote new matter being added shall not affect the validity of new tables, figures or equations in
18 PDF or other electronic format to be added to the New York city construction codes or amended
19 pursuant to this local law.

20 Section 5. This local law takes effect 12 months after it is enacted into law and shall
21 apply to work related to applications for construction document approval filed on and after such
22 effective date, except that:

23 (i) section 28-401.11 and articles 421, 422 and 425 of chapter 4 of title 28 of the
24 administrative code of the city of New York as amended by section 4 of part A of this local law and

1 articles 303, 304 and 323 of chapter 3 of title 28 of the administrative code of the city of New York
2 as amended by section 3 of part A of this local law shall take effect on January 1, 2022;

3 (ii) the amendments to section 28-110.1 of the administrative code of the city of
4 New York made by section 1 of part A of this local law and the amendments to chapter 33 of the New
5 York city building code made by sections 32 through 50 of part C of this local law shall apply to:

6 1. all work on major buildings as defined in section BC 202 of chapter 2 of the New
7 York city building code, as added by section 3 of part C of this local law, for which a site safety plan
8 is approved by the department of buildings on or after such effective date;

9 2. all temporary construction equipment permits and all crane and derrick permits,
10 as required by article 105 of chapter 1 of Title 28 of the Administrative Code, as amended by section
11 1 of part A of this local law, where the application for approval for such permit is filed with the
12 department of buildings on or after such effective date; and

13 (iii) the commissioner of buildings may promulgate rules or take other actions for
14 the implementation of this local law prior to such effective date.

LS 5406
GZ 9.29.21/6pm